

ASHLEY AN NORTON

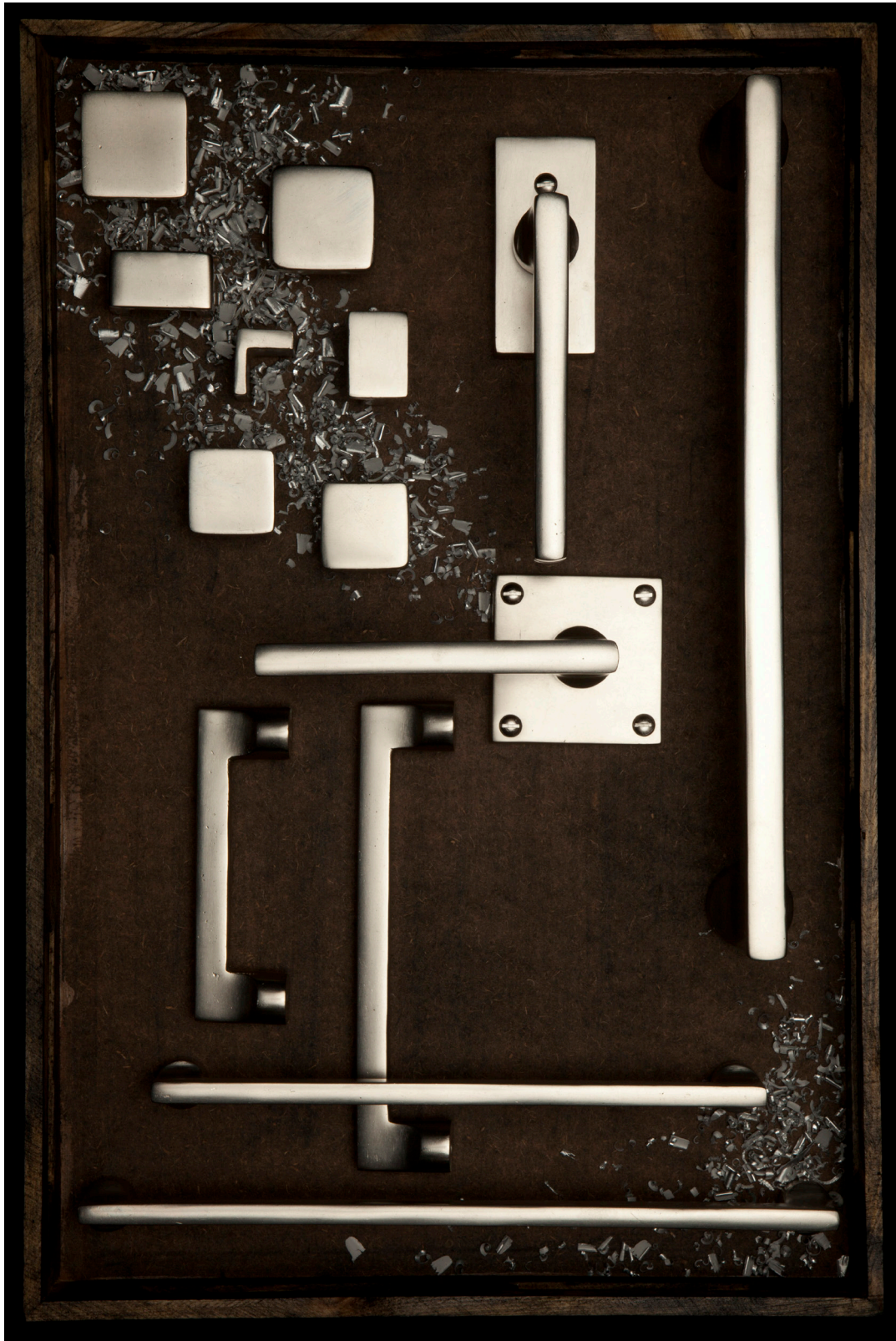

SOLID BRONZE COLLECTION
PRICE BOOK JULY 2026

INTRODUCTION

The Ashley Norton Advantage

Established in 1987, Ashley Norton has grown to become one of the leading designers and manufacturers of architectural hardware. We have developed a wide range of products including a collection of designs, finishes and styles that suit even the most discerning customer.

We pride ourselves on the technical aspects of our product:

- Products sand cast from the finest art grade bronze, assuring a naturally flowing texture
- European engineering and design, with spring assisted levers to eliminate lever sag
- European made, short-throw (28 degree) latch which minimizes effort to open the door
- ANSI Grade 1 certified, US made entry mortise locks, exceeding 5 million cycles
- Stainless steel components used wherever possible to increase durability and resist corrosion

The durability of our products, our elegant and unique designs, and our best-in-class value-proposition are amongst the many reasons why our products are selected again and again by design professionals in the high-end residential and hospitality industries as a testimonial to the versatility and quality of our products, consider the following list of projects enjoying Ashley Norton products: Wynn Las Vegas, Wynn Macau, Treasure Island, The Bellagio, Beau-Rivage and The Ritz-Carlton (Naples).

Environmentally Sound

At Ashley Norton we believe that being environmentally responsible is part of our job. Over the years, we have implemented various steps to reuse, reduce and recycle materials at every stage in our factory as well as in our offices.

- The character of our products is bolstered by a 90% recycled bronze content
- All of the bronze used in our machining and casting processes is reclaimed for reuse
- The non-destructive casting process we employ allows us to reclaim our molds for use again and again
- Our packaging is made from recycled materials

TABLE OF CONTENTS

INTRODUCTION	3	Tubular Entrysets & Deadbolts	45
TERMS & CONDITIONS OF SALE	5	Passage & Privacy Sets	47
RETURNS POLICY	6	TRADITIONAL SUITE	49
WARRANTY	7	Passage, Privacy Sets & Deadbolts	49
CUSTOM ORDERS	8	MULTIPOINT HANDLESETS	51
ORDERING GUIDELINES	9	Handlesets for Swinging Doors	53
OUR PATINAS	10	Handlesets for Sliding Doors	59
LEVERS & KNOBS	11	SPECIALTY DOOR & WINDOW HARDWARE	61
URBAN SUITE	19	Edge & Flush Pulls	61
Mortise Entrysets	19	Sliding & Pocket Door Hardware	63
Tubular Entrysets & Deadbolts	21	Gate Hardware	65
Passage & Privacy Sets	23	Surface Bolts & Cane Bolt	67
RECTANGULAR SUITE	25	Window Hardware	69
Mortise Entrysets	25	Solid Brass Hinges	71
Tubular Entrysets & Deadbolts	27	Door Stops	73
Passage & Privacy Sets	29	DOOR PULLS & PUSH PLATES	75
ARCHED SUITE	31	Pull Handles	75
Mortise Entrysets	31	Push Plates	76
Tubular Entrysets & Deadbolts	33	HOME ACCESSORIES	77
Passage & Privacy Sets	35	Bathroom Accessories	77
CURVED SUITE	37	Hooks	81
Mortise Entrysets	37	Door Knockers	84
Tubular Entrysets & Deadbolts	39	House Numbers	85
Passage & Privacy Sets	41	Bell Buttons	87
ANGULAR SUITE	43	Clavos & Strap Hinges	87
Mortise Entrysets	43	Switch & Outlet Covers	88
		Cabinet hardware and appliance pull pricing is published in our dedicated Cabinet Hardware catalog.	



TERMS & CONDITIONS OF SALE

Terms

Net 30 (subject to credit check and account approval). A monthly finance charge, computed at a periodic rate of 18% will be added to all past due accounts. The amount of credit we extend to a customer is subject to change or limitation at any time, either before or after delivery of any part thereof, of an order. Payment in advance may be required prior to delivery. If a customer's account is in arrears, we shall have the right, in addition to all other legal remedies and without prejudice to any other of our rights, to defer further shipments until payment is received. We reserve the right to ship on a C.O.D. basis when considered necessary. All goods supplied remain the property of Ashley Norton Inc. until paid in full; provided, however, that risk of loss for such items shall be borne entirely by the Buyer upon delivery of such goods by Ashley Norton Inc. (F.O.B. Pompton Plains, NJ) as detailed below. All accounts that are deemed consistently problematic in the sole discretion of Ashley Norton Inc. including but not limited to untimely payments, excessive ordering errors or excessive returns are subject to closure at Ashley Norton Inc.'s discretion.

Prices

All prices are subject to change without prior notice. All orders accepted will be priced according to the prevailing price at time of shipment. Orders delayed due to "on hold" account status will be charged at the price effective on date of shipment. All Prices are exclusive of all local, state and federal taxes. Wherever applicable, such taxes will be added to the invoice as a separate charge to be paid by the Buyer.

Claims

Any claims for shortages must be made in writing within 14 days from date of invoice. Any claims for defective merchandise or billing errors must be made in writing within 30 days from date of invoice. No claim will be allowed for work or modifications done by others, for incidental or consequential damages, or for other expenditures. The liability of Ashley Norton Inc., is limited to its obligation to repair or replace defective goods as set forth below.

TERMS & CONDITIONS OF SALE

Specifications

Sizes and designs may be changed without notification. Ashley Norton Inc reserves the right to discontinue products without prior notice.

Order Cancellations & Changes

Ashley Norton Inc will attempt to comply with submitted order changes or cancellations, however, we cannot guarantee that they can be accomplished before shipment. Handling charges will apply if goods had been manufactured prior to processing a change or cancellation request. Orders for nonstock or special items cannot be cancelled or changed without consent from Ashley Norton Inc. Where items have not been manufactured, we will endeavor to action a cancellation or change request. However, where items have been manufactured any cancellation or change is subject to approval by Ashley Norton Inc. and will result in a handling charge of up to the full order value.

Disputes

All disputes relating in any way to these Terms and Conditions of Sale shall be resolved in an appropriate court located in the State of New Jersey, and such disputes shall be governed entirely by New Jersey law.

RETURNS POLICY

Returned goods will not be accepted without prior written authorization. Minimum net amount for return of hardware is \$25.00 except in case of Ashley Norton error.

All requests for RGAs must be made in writing within 60 days of original invoice date. RGA numbers are valid for 30 days from date of issuance and will not be re-issued. A minimum 30% restock charge plus freight will apply to items returned in original condition and packaging and having a factory issued RGA number. If a factory defect is claimed, an RGA will be issued for inspection purposes only. Any credit due will be determined upon inspection; approved returns will be credited. All returns must be shipped freight pre-paid. COD returns will be refused.

ITEMS SOLD IN SPECIAL FINISHES, SPLIT FINISHES AND CUSTOM ITEMS ARE NON-RETURNABLE.

Special order or discontinued items will not be accepted for return except in case of manufacturing error.



WARRANTY

Mechanical Warranty

Ashley Norton Inc. extends a 10 year mechanism warranty to the original residential purchaser, providing the product has been installed in strict accordance with our installation instructions. The only obligation of Ashley Norton Inc. will be to repair or replace the defective product or parts upon presentation, together with proof of purchase dated within the warranty period. We assume no liability for any labor charges regarding the removal or reinstallation of the products; nor will we cover any freight, postage, or handling expense. This warranty does not cover damage caused by accident, misuse, abuse, tampering, extreme climatic conditions, improper installation or products used in commercial applications.

Finish Warranty

Our bronze patinas are 'living finishes' and may lighten, highlight, oxidize or rub off in places due to frequency of use; therefore, such events do not constitute a defect.

Our Matte Black finish is susceptible to chipping. Such chipping is a feature of the finish and in no way constitutes a defect. The finish may be easily restored by the application of a spot of black paint to the chipped area.

Thus Ashley Norton Inc., cannot guarantee our Bronze and Matte Black finishes and therefore, Ashley Norton Inc. will not have any obligation to repair or replace such finishes under this warranty.

Exclusion of Incidental and Consequential Damages

In no event shall Ashley Norton be liable for any incidental or consequential damages arising from the sale or use of our products. We assume no liability for any labor charges regarding the removal or reinstallation of the products; nor will we cover any freight, postage, or handling expense related to the product. The only obligation upon Ashley Norton Inc. will be to repair or replace the defective product or parts upon presentation, together with proof of purchase dated within the warranty period.

Ashley Norton welcomes your requests for custom products. From modifications to existing designs to completely new products, we welcome the opportunity to discuss your requirements. Minimum quantities and special charges may apply.

Examples of our capabilities include:

- Custom lever or plate designs
- Custom sizes for existing designs, e.g. cabinet knobs or pulls in alternative sizes, or plates in alternative sizes
- Products to suit specific multipoint locks
- Handlesets with narrow (or extended) backset mortise locks. Note that narrow backset mortise locks are not available in a grip x lever/knob configuration

If a custom order is cancelled after work has begun, charges will be billed for time and costs incurred to date.

Please call or email us (custom@ashleynorton.com) with your requirements. When emailing, be sure to include as much detail as possible, particularly on quantities required.

MORTISE LOCK OPTIONS

ANSI F12 Entry

Accurate 9148B Lock

- Latch bolt by key outside and lever either side unless outside lever is locked by toggle action stop
- Deadbolt by key outside and turn piece inside
- Turning inside lever retracts latch and deadbolt simultaneously, **outside lever remains locked until manually unlocked by toggle**



ANSI F13 Dormitory

Accurate 9124B Lock

- Latch bolt by lever either side
- Deadbolt by key outside and turn piece inside
- A turn of inside lever retracts latch and deadbolt simultaneously, **automatically unlocking outside lever.**



ORDERING GUIDELINES

Almost any combination of lever, knob, escutcheon and finish may be combined to create a unique piece for your client's project. Our staff will be delighted to assist if you have any questions regarding compatibility of levers/escutcheons or other technical questions. Some frequently requested information is presented below.

Handing Guide

Most of our interior sets (tubular passage/privacy) do not require handing. Handing is required for single dummies, entry hardware and all mortise sets.

Backset, Strike, Door Thickness

Our hardware is supplied with accessories to suit a typical door. However, a number of options are available to suit particular circumstances.

Handing Guide For Swinging Door Hardware

Door handing is always determined from outside of the door. The side of the door that the hinges are on determines the handing of the door. For mortise sets, we need to know the swing direction of the door. Most doors swing in, but if the door swings outwards, designate this as reverse swing.

- L** = Left Hand
- R** = Right Hand
- LHR** = Left Hand Reverse
(needed for mortise sets only)
- RHR** = Right Hand Reverse
(needed for mortise sets only)

	STANDARD	OPTION
Please call to verify suitability for any doors thicker than 2 1/2"		
TUBULAR PASSAGE / PRIVACY SETS		
Door thickness	1 3/8" - 1 3/4"	Up to: 3" (passage); 2 1/2" (privacy)
Backset	2 3/8"	2 3/4"
Strike	Full Lipped Strike	T Strike
DEADBOLTS		
Door thickness	1 3/4"	Up to: 3" (standard); 2 1/4" (double-keyed)
Backset	2 3/8"	2 3/4"
TUBULAR ENTRYSETS		
Door thickness	1 3/4"	Up to 3" - see footnote (a) below
Backset	2 3/8"	2 3/4"
Strike	Full Lipped Strike	T Strike
MORTISE ENTRYSETS		
Door thickness	1 3/4"	Up to 3" (upcharge for doors 2 1/2" or thicker)
Backset	2 1/2"	2 3/4" (call for narrow or extended backset)
Strike	Mortise strike	Mortise strike
MULTIPOINT TRIM		
Door thickness	1 3/4"	Up to 2 1/4" (inquire for thicker doors)
Strike	Not included	Not included

(a) Max. thickness for double keyed entryset is 2 1/4". Max. thickness for tubular gripset is 2 1/2"

OUTSIDE VIEW

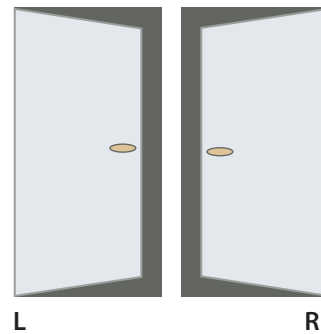

OUTSIDE VIEW – OUTSWING DOOR

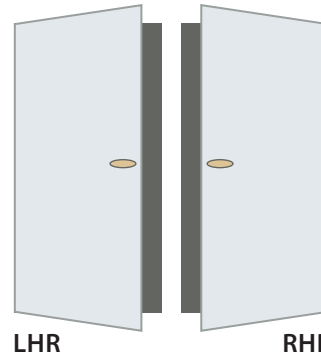

VIEWED FROM THE TOP
Inside

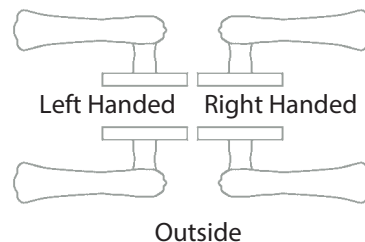

Ashley Norton utilizes the finest art grade bronze alloys in the production of our hardware. Our **Dark Bronze (BZ)**, **Natural Bronze (NB)** and **Matte Black (TC)** products are produced from silicon bronze, a coppery-gold colored alloy of copper, silicon and zinc.

Our **Dark Bronze (BZ)** patina is our most popular, and allows for the greatest uniformity in shade at time of delivery. We aim to stock the most popular items in this patina.

Our **Natural Bronze (NB)** patina infuses a modern natural bronze tone with the ageless texture typical of sand cast bronze hardware.

Our **Matte Black (TC)** products are created through the application of a black powder coat. The combination of distressed bronze with a modern black finish offers a striking look which works well in a transitional or modern space.

Our **White Bronze (WL)** products are produced from an alloy known simply as white bronze. The infusion of manganese and nickel to the copper creates a pleasing silver colored metal.

Our **White Medium (WM)** patina products are hand finished in small batches. Each batch will be similar in hue, however different batches may have slight variation in tone. Such differences are caused not only by the small variation in time for which the item is oxidized, but also environmental factors such as humidity and temperature.

Ashley Norton applies a light coating of wax to protect our products from oxidization and wear. As the wax coating wears off, the patinas will be exposed to the environment. The effects of age, climate and touch will work in conjunction to create unique, contrasted color variations. The most frequently touched areas will highlight as the patina wears off and natural shades of bronze are exposed. Areas which are not handled may oxidize further, and the combination of colors and hues will accentuate the timeless elegance of bronze.

LEVER OPTIONS



Churchill Lever (500)

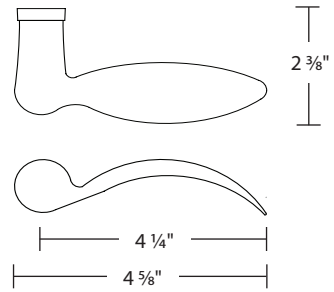

Chiltern Lever (160)

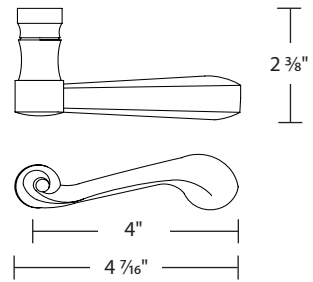

Colonial Lever (490)

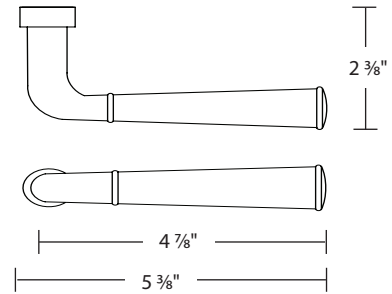

Hampton Lever (400)

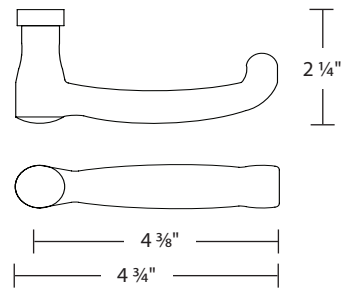

Shropshire Lever (800)

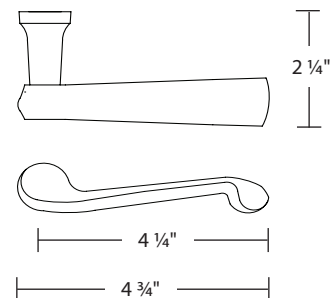

LEVER OPTIONS

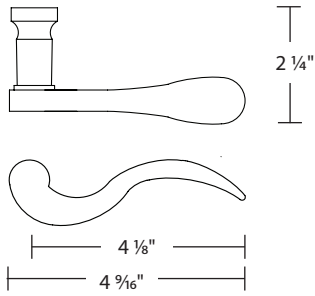

Chester Lever (200)

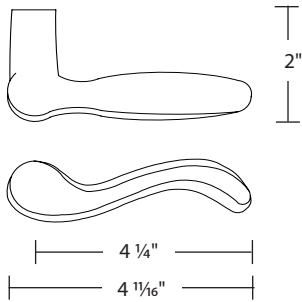

Elm Lever (580)

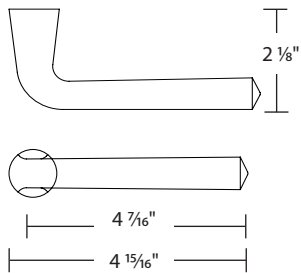

Alessa Lever (830)

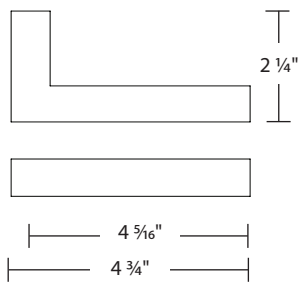

Greenwich Lever (350)

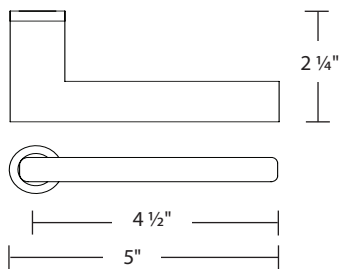

Apollo Lever (450)

LEVER OPTIONS



Atlas Lever (375)

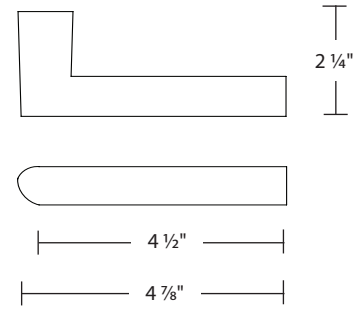

Centaur Lever (349)

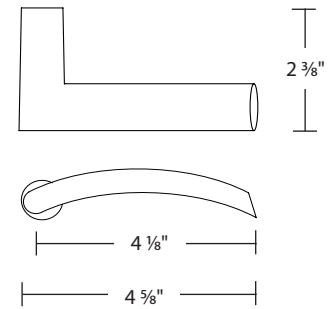

Mason Lever (478)

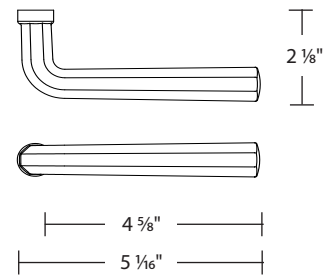

Adonis Lever (985)

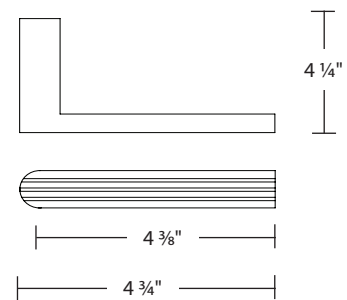

Metro Lever (465)

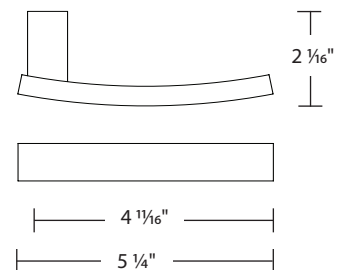

LEVER OPTIONS

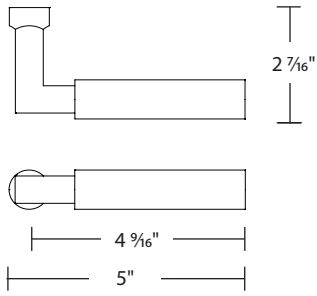

Bauhaus Lever (225)

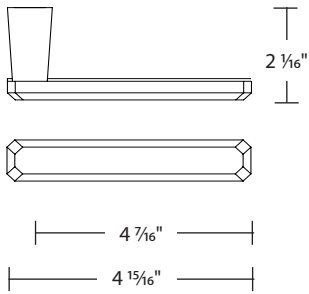

Artemis Lever (680)

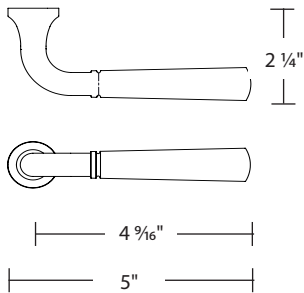

Cara Lever (790)

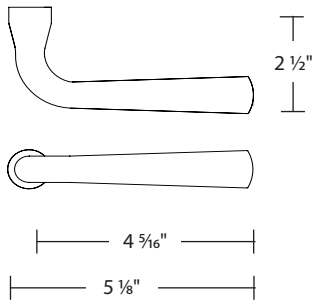

Joan Lever (480)

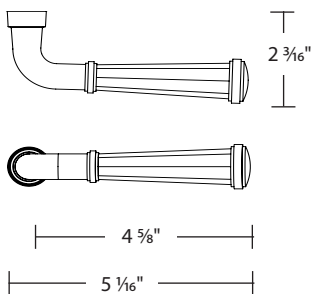

Edward Lever (740)

LEVER OPTIONS



Alexis Lever (890)

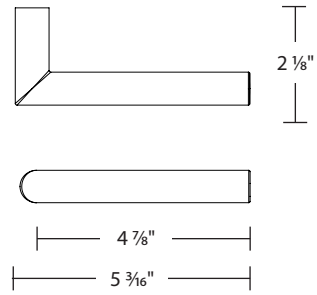

Meridian Lever (310)

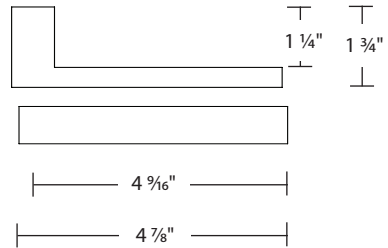

Lucas Lever (194)

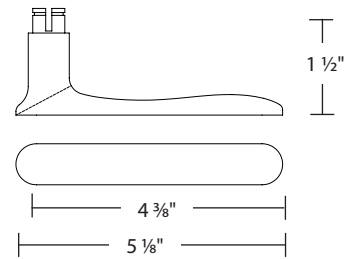

Hammered Cara Lever (793)
\$80 list upcharge per pair

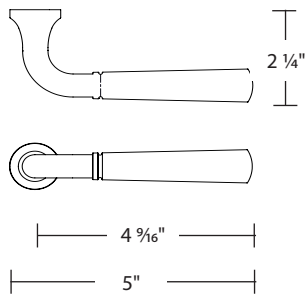

Hammered Meridian Lever (313)
\$80 list upcharge per pair

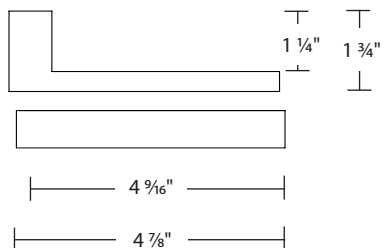

RETURN LEVER OPTIONS

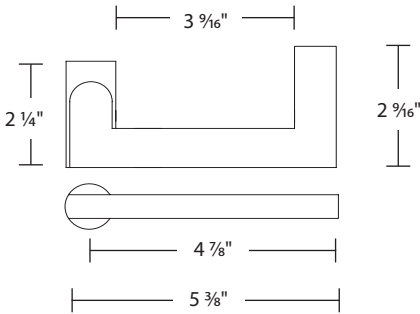

Apollo Return Lever (451)

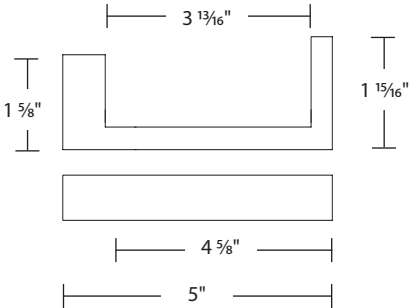

Meridian Return Lever (311)

KNOB OPTIONS



Faceted Knob (995)

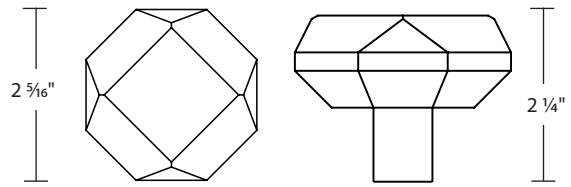

Mateo Knob (640)

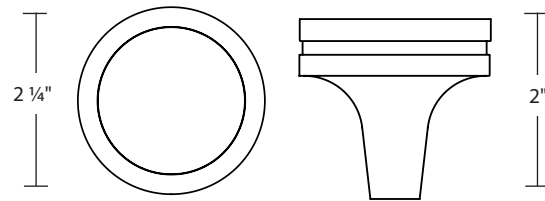

Helios Knob (880)

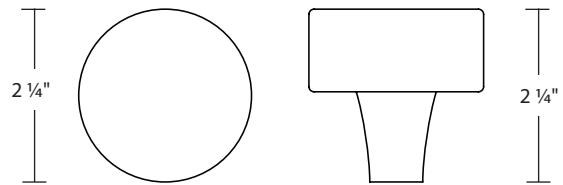

Newport Knob (990)

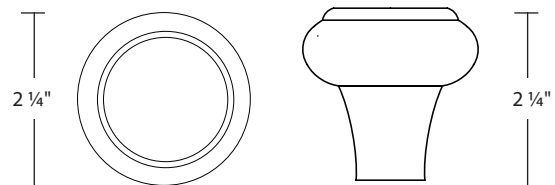

Owen Knob (549)

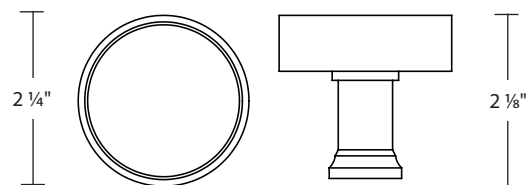

KNOB OPTIONS

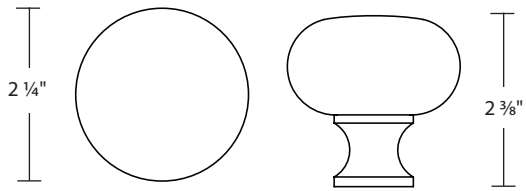

Windsor Knob (900)

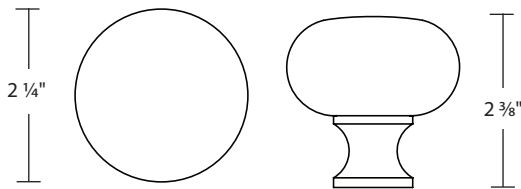

Hammered Windsor Knob (903)
\$80 list upcharge per pair

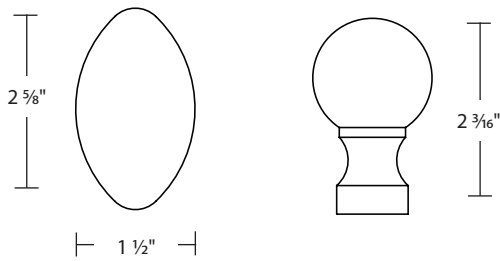

Carlisle Knob (660)



URBAN SUITE – MORTISE ENTRYSETS







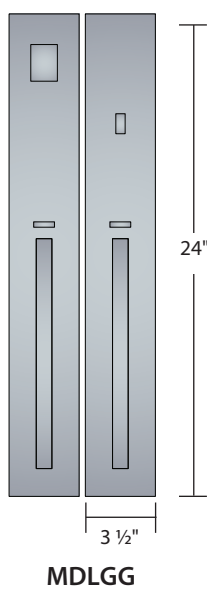
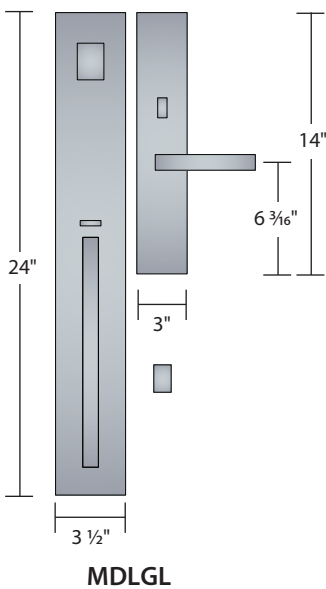
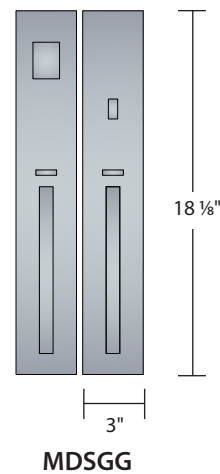
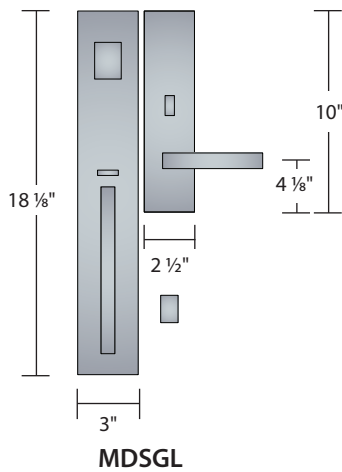
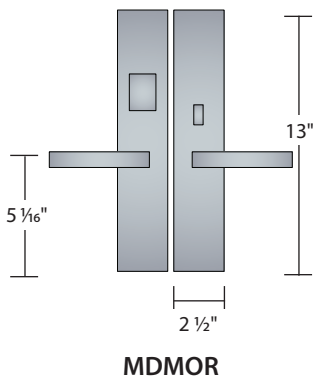

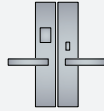
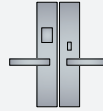
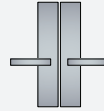
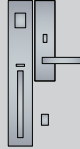
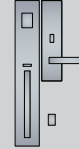

PATINA	ESCUTCHEON	LEVER/KNOB	FUNCTION	HANDING	BACKSET
BZ Dark Bronze	select from	select from	select from	L LHR	2 ½"
WL White Bronze	table below	pages 11-18	table across	R RHR	2 ¾"
WM White Medium					
TC Matte Black					
NB Natural Bronze					

For example, to order an item in Natural Bronze (NB) patina, with the 18 ⅞" x 3" grip entry escutcheon (MDSGL), the Churchill (500) lever in an Entry (10) function for a left hand door (L), use product code: NB.MDSGL.500.10.L and specify backset

- Available with any lever or knob. \$80 list upcharge per pair of hammered levers/knobs, or \$40 list for a single lever/knob
- ANSI F12 Entry is supplied with Accurate 9148B lock; ANSI F13 Dormitory is supplied with Accurate 9124B lock. See page 8 for further details. Other locks available on request (upcharge may apply)
- For narrow or extended backsets, please email quote request including quantities to custom@ashleynorton.com
- Specify door thickness and handing including door swing (e.g. Left, Right, Left Reverse, Right Reverse)
- For doors 2 ½" or thicker, a \$150 list upcharge will apply
- Maximum door thickness is 3"



URBAN SUITE – MORTISE ENTRYSETS

	MORTISE ENTRY ⁽¹⁾ ANSI F12	MORTISE DORMITORY ⁽¹⁾ ANSI F13	FULL DUMMY
LEVER x LEVER OR KNOB x KNOB 13" x 2 ½"	 MDMOR / 12 FUNCTION \$1,283	 MDMOR / 13 FUNCTION \$1,283	 MDMOR / 22 FUNCTION \$675
GRIP x LEVER OR GRIP x KNOB EXTERIOR: 18 ⅞" x 3" INTERIOR: 10" x 2 ½"	 MDSGL / 10 FUNCTION \$1,616	 MDSGL / 11 FUNCTION \$1,616	 MDSGL / 42 FUNCTION \$985
GRIP x LEVER OR GRIP x KNOB EXTERIOR: 24" x 3 ½" INTERIOR: 14" x 3"	 MDLGL / 10 FUNCTION \$1,863	 MDLGL / 11 FUNCTION \$1,863	 MDLGL / 42 FUNCTION \$1,236
GRIP x GRIP 18 ⅞" x 3"	 MDSGG / 14 FUNCTION \$2,107	 MDSGG / 15 FUNCTION \$2,107	 MDSGG / 42 FUNCTION \$1,380
GRIP x GRIP 24" x 3 ½"	 MDLGG / 14 FUNCTION \$2,515	 MDLGG / 15 FUNCTION \$2,515	 MDLGG / 42 FUNCTION \$1,787

URBAN SUITE / MORTISE ENTRY SETS

(1) See page 8 for explanation of these locks.

URBAN SUITE – TUBULAR ENTRYSETS & DEADBOLTS







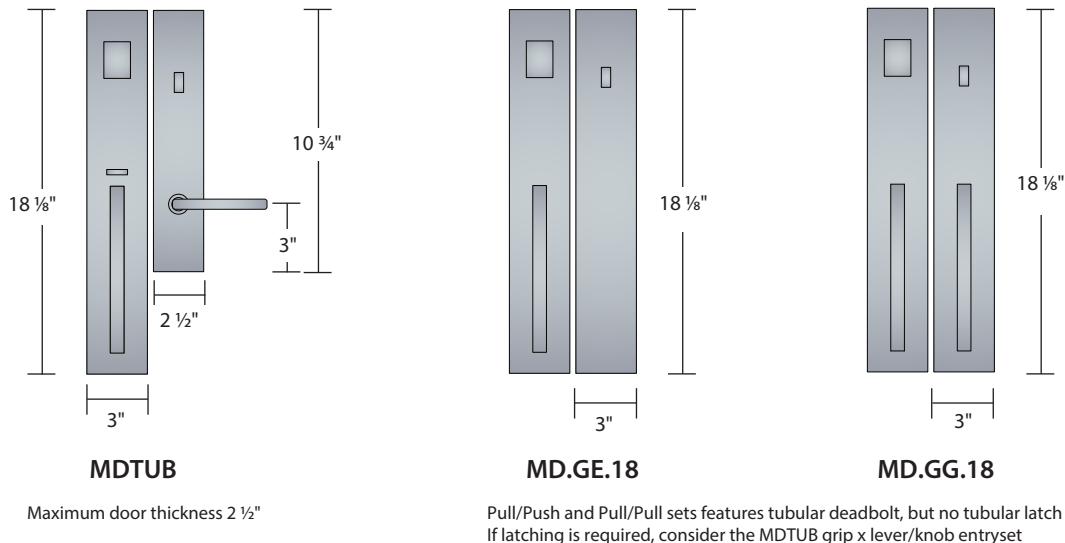
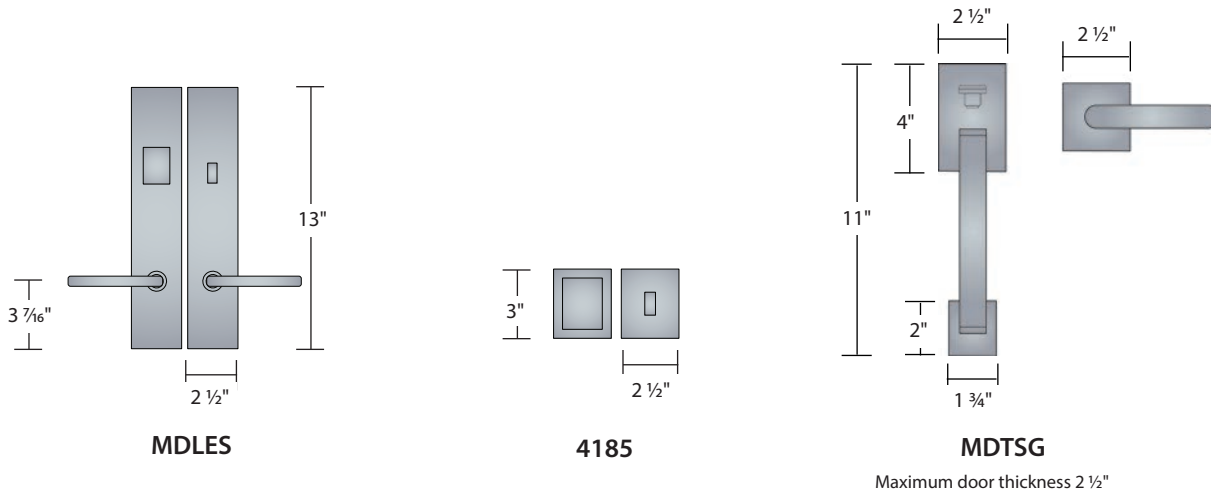





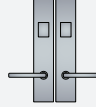
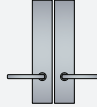
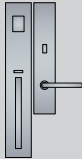

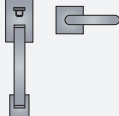
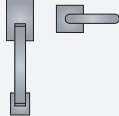
PATINA	ESCUTCHEON	LEVER/KNOB	FUNCTION	HANDING	BACKSET
BZ Dark Bronze	select from table below	select from pages 11-18	select from table across	Left	2 3/8"
WL White Bronze				Right	2 3/4"
WM White Medium					
TC Matte Black					
NB Natural Bronze					

For example to order an item in Natural Bronze (NB) patina, with the 18 1/8" x 3" grip entry escutcheon (MDTUB), the Apollo (450) lever in an Entry (50) function for a right hand door (R), use product code: NB.MDTUB.450.50.R and specify backset.

- Available with any lever or knob. \$80 list upcharge per pair of hammered levers/knobs, or \$40 list for a single lever/knob
- Suitable for doors with standard 5 1/2" center to center
- Supplied with tubular latch and deadbolt
- Specify door thickness, handing and backset (2 3/8" or 2 3/4")
- Maximum door thickness for MDTUB and MDTSG (grip x lever/knob entryset): 2 1/2"
- Maximum door thickness for MDLES entryset and deadbolts: 3" for single keyed or patio, 2 1/4" for double-keyed



URBAN SUITE – TUBULAR ENTRYSETS & DEADBOLTS

	TUBULAR ENTRY	TUBULAR PATIO	DOUBLE ENTRY	FULL DUMMY
LEVER x LEVER OR KNOB x KNOB 13" x 2 1/2"	 MDLES / 50 FUNCTION \$821	 MDLES / 43 FUNCTION \$821	 MDLES / 52 FUNCTION \$921	 MDLES / 42 FUNCTION \$675
GRIP x LEVER OR GRIP x KNOB EXTERIOR: 18 1/8" x 3" INTERIOR: 10 3/4" x 2 1/2"	 MDTUB / 50 FUNCTION \$1,184			 MDTUB / 42 FUNCTION \$985
SECTIONAL TUBULAR EXTERIOR: 11" x 2 1/2" INTERIOR: 2 1/2" x 2 1/2"	 MDTSG / 30 FUNCTION \$618 Order deadbolt separately			 MDTSG / 42 FUNCTION \$618
	DEADBOLT	PATIO DEADBOLT	DOUBLE KEYED DEADBOLT	FULL DUMMY
DEADBOLT 3" x 2 1/2"	 4185 \$312 Collar available for 1 3/8" doors and Level Bolt*	 4785 \$312	 4285 \$372	
PULL x PUSH⁽¹⁾ DEADBOLT 18 1/8" x 3"	 MD.GE.18.50 \$1,364		 MD.GE.18.52 \$1,464	 MD.GE.18.42 \$1,130
PULL x PULL⁽¹⁾ DEADBOLT 18 1/8" x 3"	 MD.GG.18.50 \$1,767		 MD.GG.18.52 \$1,867	 MD.GG.18.42 \$1,500

URBAN SUITE / TUBULAR ENTRY SETS

(1) Pull x Push and Pull x Pull sets feature a keyed tubular deadbolt, but not a tubular latch. If latching is required, consider a grip x lever/knob entryset.

*Order 4185-COLLAR if 4185 deadbolt is to be installed on 1 3/8" door, or with Level Bolt on 1 3/4" door. Price \$54



URBAN SUITE – PASSAGE & PRIVACY







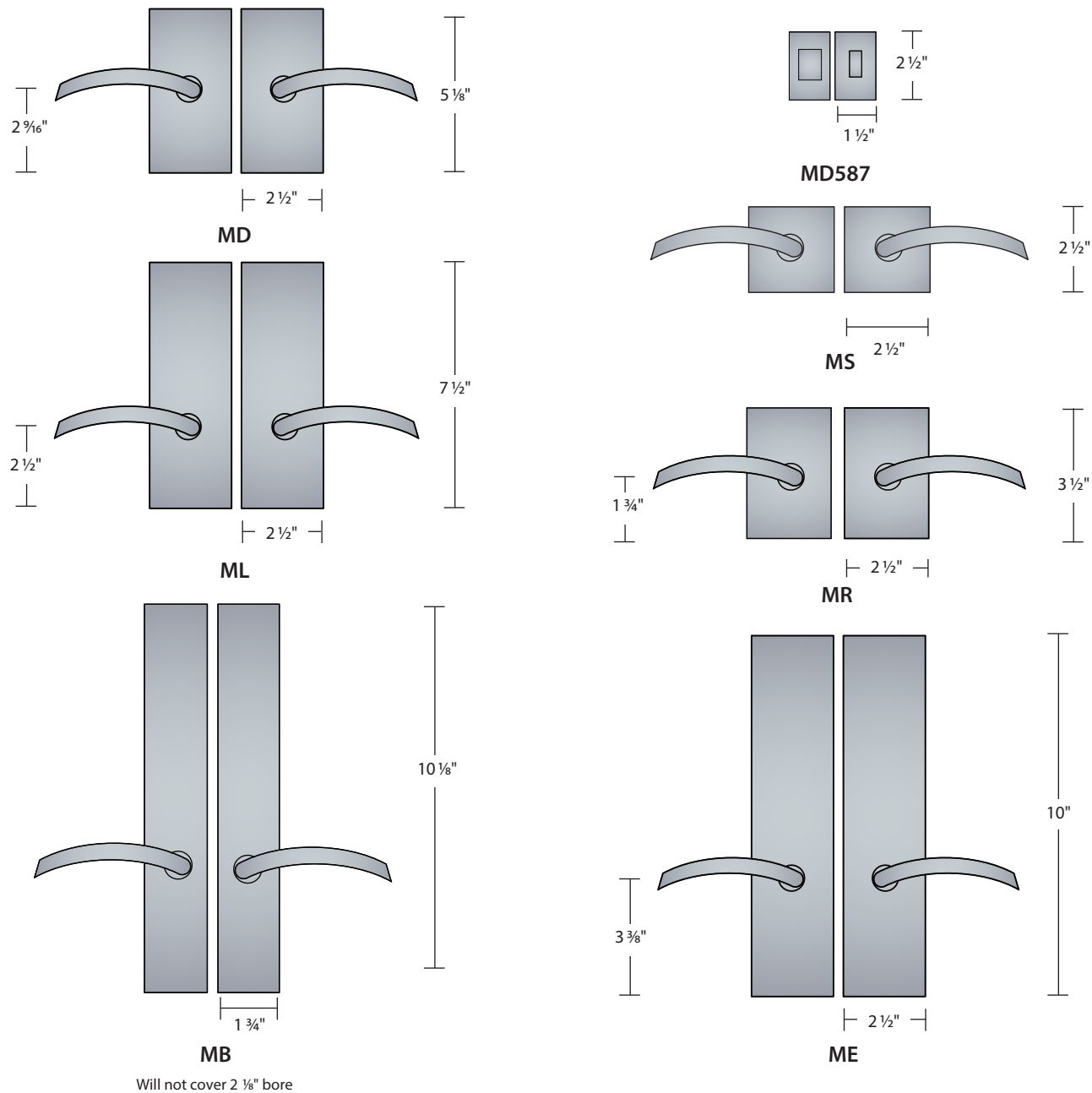



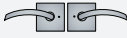











PATINA	ESCUTCHEON	LEVER/KNOB	FUNCTION	HANDING	BACKSET
BZ Dark Bronze	select from	select from	select from	L	2 3/8"
WL White Bronze	table below	pages 11-18	table across	R	2 3/4"
WM White Medium					
TC Matte Black					
NB Natural Bronze					

For example to order an item in Dark Bronze (BZ) patina, with the 7 1/2" x 2 1/2" escutcheon (ML), the Churchill (500) lever in a Single Dummy (40) function for a left hand door (L), use product code: BZ.ML.500.40.L

- Available with any lever or knob. \$80 list upcharge per pair of hammered levers/knobs, or \$40 list for a single lever/knob
- Handing not required for tubular passage and privacy sets
- Specify door thickness and backset (2 3/8" or 2 3/4" for tubular latch; 2 1/2" or 2 3/4" for interior mortise locks)
- Maximum door thickness 3" (passage); 2 1/2" (privacy pin)

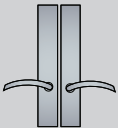
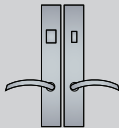
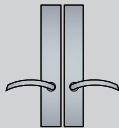
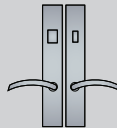

URBAN SUITE – PASSAGE & PRIVACY

	TUBULAR PASSAGE	TUBULAR PRIVACY (PIN)	TUBULAR PRIVACY (BOLT)	MORTISE PASSAGE*	MORTISE PRIVACY*	SINGLE DUMMY
LEVER x LEVER OR KNOB x KNOB 2 ½" x 2 ½"	 MS 30 FUNCTION \$330	 MS 20 FUNCTION \$346	 MD587 PRIVACY BOLT \$168			 MS 40 FUNCTION \$165
LEVER x LEVER OR KNOB x KNOB 3 ½" x 2 ½"	 MR 30 FUNCTION \$336	 MR 20 FUNCTION \$352				 MR 40 FUNCTION \$168
LEVER x LEVER OR KNOB x KNOB 5 ⅞" x 2 ½"	 MD 30 FUNCTION \$360	 MD 20 FUNCTION \$376				 MD 40 FUNCTION \$180
LEVER x LEVER OR KNOB x KNOB 7 ½" x 2 ½"	 ML 30 FUNCTION \$426	 ML 20 FUNCTION \$442	 ML 26 FUNCTION \$492	 ML 34 FUNCTION \$786	 ML 24 FUNCTION \$816	 ML 40 FUNCTION \$213
LEVER x LEVER OR KNOB x KNOB 10" x 2 ½"	 ME 30 FUNCTION \$504	 ME 20 FUNCTION \$520	 ME 26 FUNCTION \$570	 ME 34 FUNCTION \$864	 ME 24 FUNCTION \$894	 ME 40 FUNCTION \$252
LEVER x LEVER OR KNOB x KNOB 10 ⅞" x 1 ¾" Will not cover 2 ⅞" bore	 MB 30 FUNCTION \$502		 MB 26 FUNCTION \$568	 MB 34 FUNCTION \$862	 MB 24 FUNCTION \$892	 MB 40 FUNCTION \$251

URBAN SUITE / PASSAGE & PRIVACY SETS

Note: Ashley Norton supplies Accurate 9800 series interior locks with our mortise passage and privacy sets. Should you prefer a 3 hour UL rated, full size lock for design or code requirements, please contact us for pricing.

Note: For full dummy, order 1x LH and 1x RH single dummies



RECTANGULAR SUITE – MORTISE ENTRYSETS

PATINA	ESCUTCHEON	LEVER/KNOB	FUNCTION	HANDING	BACKSET
BZ Dark Bronze	select from	select from	select from	L LHR	2 1/2"
WL White Bronze	table below	pages 11-18	table across	R RHR	2 3/4"
WM White Medium					
TC Matte Black					
NB Natural Bronze					

For example to order an item in Dark Bronze (BZ) patina, with the 18 1/8" x 3" grip entry escutcheon (SQSGL), the Churchill (500) lever in an Entry (10) function for a left hand door (L), use product code: BZ.SQSGL.500.10.L and specify backset.

- Available with any lever or knob. \$80 list upcharge per pair of hammered levers/knobs, or \$40 list for a single lever/knob
- ANSI F12 Entry is supplied with Accurate 9148B lock; ANSI F13 Dormitory is supplied with Accurate 9124B lock. See page 8 for further details. Other locks available on request (upcharge may apply)
- For narrow or extended backsets, please email quote request including quantities to custom@ashleynorton.com
- Specify door thickness and handing including door swing (e.g. Left, Right, Left Reverse, Right Reverse)
- For doors 2 1/2" or thicker, a \$150 list upcharge will apply
- Maximum door thickness is 3"

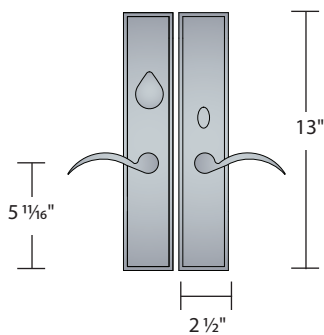

SQMOR

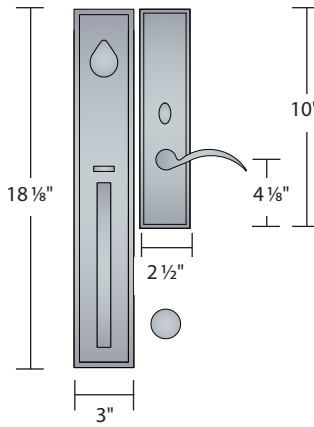

SQSGL

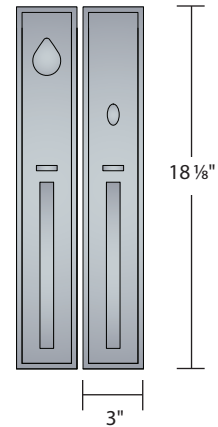

SQSGG

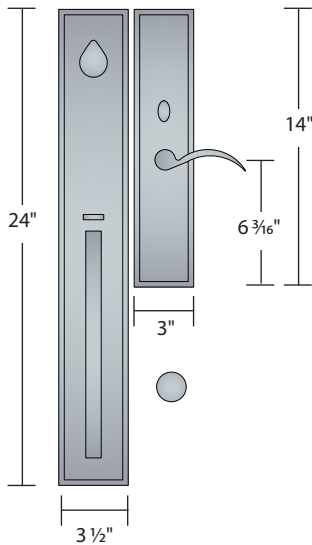



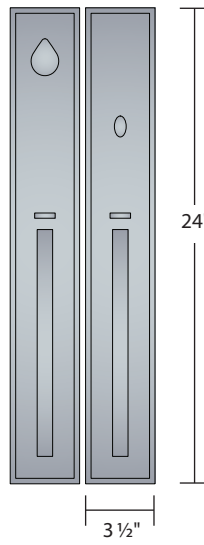





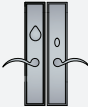
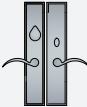

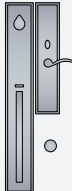

SQLGL



SQLGG

RECTANGULAR SUITE – MORTISE ENTRYSETS

	MORTISE ENTRY ⁽¹⁾ ANSI F12	MORTISE DORMITORY ⁽¹⁾ ANSI F13	FULL DUMMY
LEVER x LEVER OR KNOB x KNOB 13" x 2 ½"	 SQMOR / 12 FUNCTION \$1,283	 SQMOR / 13 FUNCTION \$1,283	 SQMOR / 22 FUNCTION \$675
GRIP x LEVER OR GRIP x KNOB EXTERIOR: 18 ⅞" x 3" INTERIOR: 10" x 3 ½"	 SQSG L / 10 FUNCTION \$1,616	 SQSG L / 11 FUNCTION \$1,616	 SQSG L / 42 FUNCTION \$985
GRIP x LEVER OR GRIP x KNOB EXTERIOR: 24" x 3 ½" INTERIOR: 14" x 3"	 SQLGL / 10 FUNCTION \$1,863	 SQLGL / 11 FUNCTION \$1,863	 SQLGL / 42 FUNCTION \$1,236
GRIP x GRIP 18 ⅞" x 3"	 SQSGG / 14 FUNCTION \$2,107	 SQSGG / 15 FUNCTION \$2,107	 SQSGG / 42 FUNCTION \$1,380
GRIP x GRIP 24" x 3 ½"	 SQLGG / 14 FUNCTION \$2,515	 SQLGG / 15 FUNCTION \$2,515	 SQLGG / 42 FUNCTION \$1,787

RECTANGULAR SUITE / MORTISE ENTRYSETS

(1) See page 8 for explanation of these locks.

RECTANGULAR SUITE – TUBULAR ENTRYSETS & DEADBOLTS

PATINA	ESCUTCHEON	LEVER/KNOB	FUNCTION	HANDING	BACKSET
BZ Dark Bronze	select from	select from	select from	L Left	2 3/8"
WL White Bronze	table below	pages 11-18	table across	R Right	2 3/4"
WM White Medium					
TC Matte Black					
NB Natural Bronze					

For example to order an item in Natural Bronze (NB) patina, with the 18 1/8" x 3" grip entry escutcheon (SQTUB), the Chester (200) lever in an Entry (50) function for a right hand door (R), use product code: NB.SQTUB.200.50.R and specify backset

- Available with any lever or knob. \$80 list upcharge per pair of hammered levers/knobs, or \$40 list for a single lever/knob
- Suitable for doors with standard 5 1/2" center to center
- Supplied with tubular latch and deadbolt
- Specify door thickness, handing and backset (2 3/8" or 2 3/4")
- Maximum door thickness for SQTUB and SQTSG (grip x lever/knob entryset): 2 1/2"
- Maximum door thickness for SQLES entryset and deadbolts: 3" for single keyed or patio, 2 1/4" for double-keyed

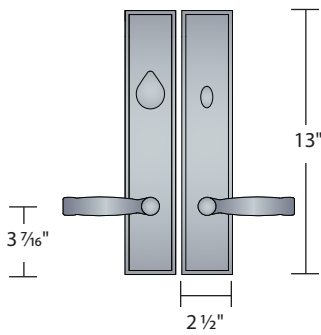

SQLES

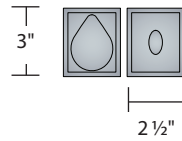

4150

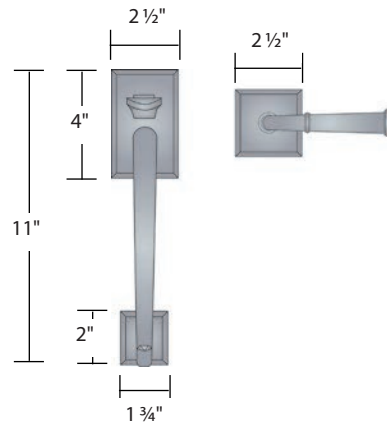

SQTSG

Maximum door thickness 2 1/2"

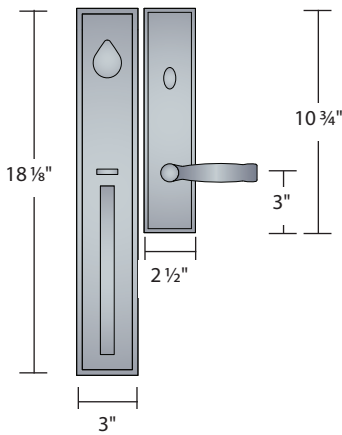

SQTUB

Maximum door thickness 2 1/2"

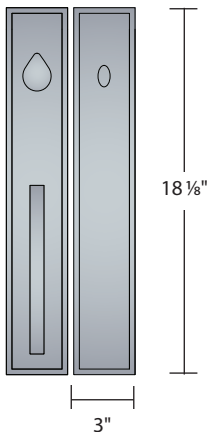





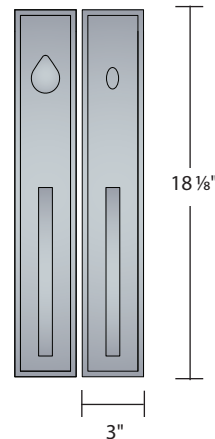





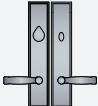
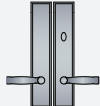

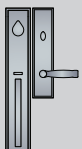
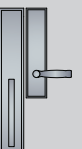

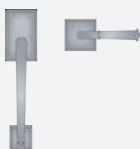
SQ.GE.18

Pull/Push and Pull/Pull sets features tubular deadbolt, but no tubular latch
If latching is required, consider the SQTUB grip x lever/knob entryset



SQ.GG.18

RECTANGULAR SUITE – TUBULAR ENTRYSETS & DEADBOLTS

	TUBULAR ENTRY	TUBULAR PATIO	DOUBLE ENTRY	FULL DUMMY
LEVER x LEVER OR KNOB x KNOB 13" x 2 1/2"	 SQLES / 50 FUNCTION \$821	 SQLES / 43 FUNCTION \$821	 SQLES / 52 FUNCTION \$921	 SQLES / 42 FUNCTION \$675
GRIP x LEVER OR GRIP x KNOB EXTERIOR: 18 1/8" x 3" INTERIOR: 10 3/4" x 2 1/2"	 SQTUB / 50 FUNCTION \$1,184			 SQTUB / 42 FUNCTION \$985
SECTIONAL TUBULAR EXTERIOR: 11" x 2 1/2" INTERIOR: 2 1/2" x 2 1/2"	 SQTSG / 30 FUNCTION \$618 Order deadbolt separately			 SQTSG / 42 FUNCTION \$618
	DEADBOLT	PATIO DEADBOLT	DOUBLE KEYED DEADBOLT	FULL DUMMY
DEADBOLT 3" x 2 1/2"	 4150 \$312 Collar available for 1 3/8" doors and Level Bolt*	 4750 \$312	 4250 \$372	
PULL x PUSH DEADBOLT⁽¹⁾ 18 1/8" x 3"	 SQ.GE.18.50 \$1,364		 SQ.GE.18.52 \$1,464	 SQ.GE.18.42 \$1,130
PULL x PULL DEADBOLT⁽¹⁾ 18 1/8" x 3"	 SQ.GG.18.50 \$1,767		 SQ.GG.18.52 \$1,867	 SQ.GG.18.42 \$1,500

RECTANGULAR SUITE / TUBULAR ENTRYSETS

(1) Pull x Push and Pull x Pull sets feature a keyed tubular deadbolt, but not a tubular latch. If latching is required, consider a grip x lever/knob entryset. Order 4185-COLLAR if 4150 deadbolt is to be installed on 1 3/8" door, or with Level Bolt on 1 3/4" door. Price \$54



RECTANGULAR SUITE – PASSAGE & PRIVACY

PATINA	ESCUTCHEON	LEVER/KNOB	FUNCTION	HANDING	BACKSET
BZ Dark Bronze	select from table below	select from pages 11-18	select from table across	L Left	2 3/8"
WL White Bronze				R Right	2 3/4"
WM White Medium					
TC Matte Black					
NB Natural Bronze					





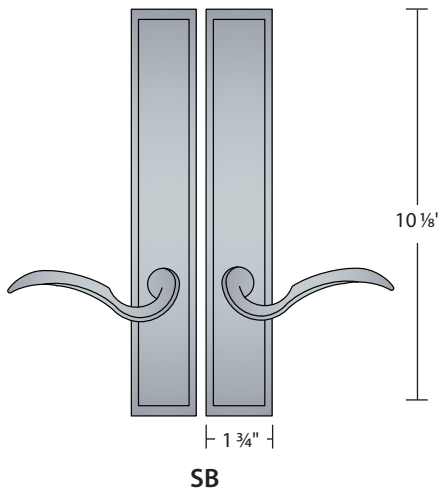
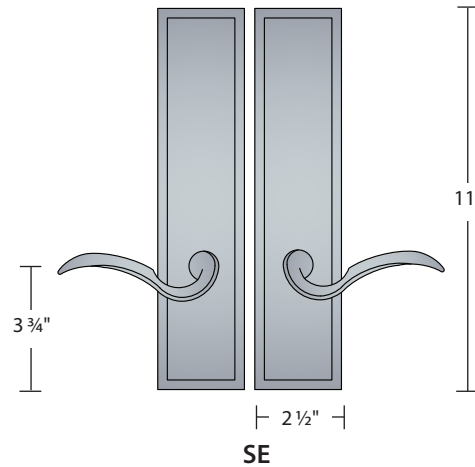
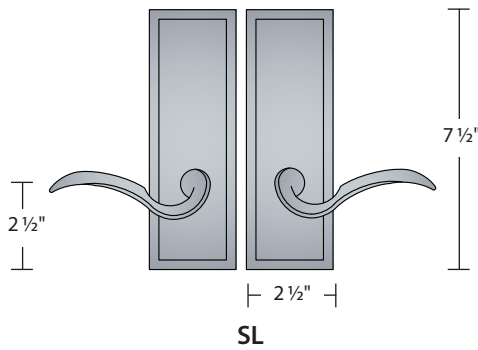
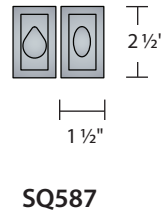
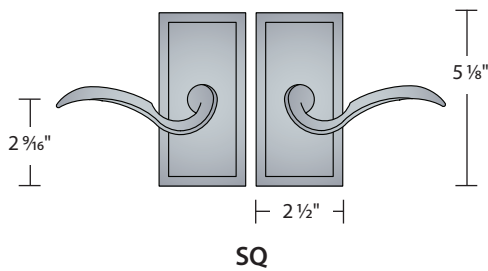













For example to order an item in White Bronze (WL) patina, with the 5 1/8" x 2 1/2" escutcheon (SQ), the Hampton (400) lever in a Single Dummy (40) function for a left hand door (L), use product code: WL.SQ.400.40.L

- Available with any lever or knob. \$80 list upcharge per pair of hammered levers/knobs, or \$40 list for a single lever/knob
- Handing not required for tubular passage or privacy sets
- Specify door thickness and backset (2 3/8" or 2 3/4" for tubular latch; 2 1/2" or 2 3/4" for interior mortise locks)
- Maximum door thickness: 3" (passage); 2 1/2" (privacy)

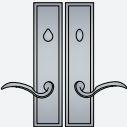

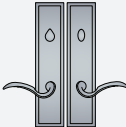
Will not cover 2 1/8" bore

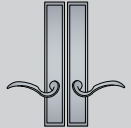
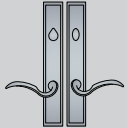
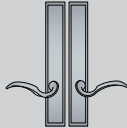
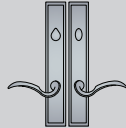
RECTANGULAR SUITE – PASSAGE & PRIVACY

	TUBULAR PASSAGE	TUBULAR PRIVACY (PIN)	TUBULAR PRIVACY (BOLT)	MORTISE PASSAGE	MORTISE PRIVACY	SINGLE DUMMY
LEVER x LEVER OR KNOB x KNOB 5 1/8" x 2 1/2"	 SQ 30 FUNCTION \$360	 SQ 20 FUNCTION \$376	 SQ587 PRIVACY BOLT \$168			 SQ 40 FUNCTION \$180
LEVER x LEVER OR KNOB x KNOB 7 1/2" x 2 1/2"	 SL 30 FUNCTION \$426	 SL 20 FUNCTION \$442	 SL 26 FUNCTION \$492	 SL 34 FUNCTION \$786	 SL 24 FUNCTION \$816	 SL 40 FUNCTION \$213
LEVER x LEVER OR KNOB x KNOB 11" x 2 1/2"	 SE 30 FUNCTION \$504	 SE 20 FUNCTION \$520	 SE 26 FUNCTION \$570	 SE 34 FUNCTION \$864	 SE 24 FUNCTION \$894	 SE 40 FUNCTION \$252
LEVER x LEVER OR KNOB x KNOB 10 1/8" x 1 3/4" Will not cover 2 1/8" bore	 SB 30 FUNCTION \$502		 SB 26 FUNCTION \$568	 SB 34 FUNCTION \$862	 SB 24 FUNCTION \$892	 SB 40 FUNCTION \$251

RECTANGULAR SUITE / PASSAGE & PRIVACY

Note: Ashley Norton supplies Accurate 9800 series interior locks with our mortise passage and privacy sets. Should you prefer a 3 hour UL rated, full size lock for design or code requirements, please contact us for pricing.
 Note: For full dummy, order 1x LH and 1x RH single dummies

ARCHED SUITE – MORTISE ENTRYSETS

PATINA	ESCUTCHEON	LEVER/KNOB	FUNCTION	HANDING	BACKSET
BZ Dark Bronze	select from	select from	select from	L LHR	2 ½"
WL White Bronze	table below	pages 11-18	table across	R RHR	2 ¾"
WM White Medium					
TC Matte Black					
NB Natural Bronze					

For example to order an item in Natural Bronze (NB) patina, with the 18 ⅞" x 3" grip entry escutcheon (SPSGL), the Churchill (500) lever in an Entry (10) function for a left hand door (L), use product code: NB.SPSGL.500.10.L and specify backset

- Available with any lever or knob. \$80 list upcharge per pair of hammered levers/knobs, or \$40 list for a single lever/knob
- ANSI F12 Entry is supplied with Accurate 9148B lock; ANSI F13 Dormitory is supplied with Accurate 9124B lock. See page 8 for further details. Other locks available on request (upcharge may apply)
- For narrow or extended backsets, please email quote request including quantities to custom@ashleynorton.com
- Specify door thickness and handing including door swing (e.g. Left, Right, Left Reverse, Right Reverse)
- For doors 2 ½" or thicker, a \$150 list upcharge will apply
- Maximum door thickness is 3"

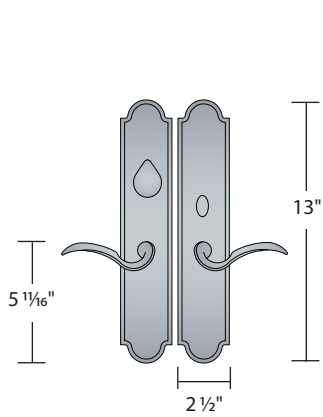

SPMOR

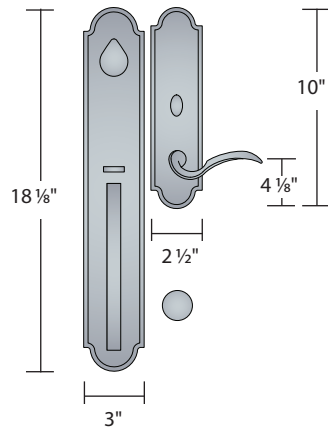

SPSGL

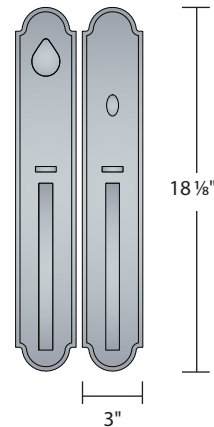

SPSGG

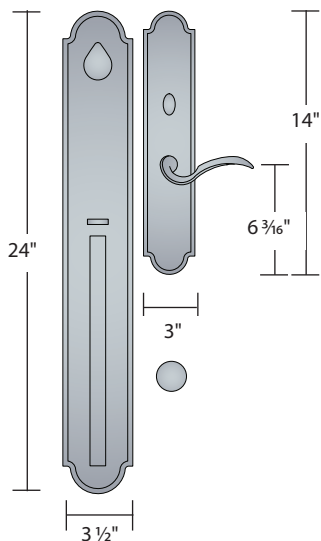



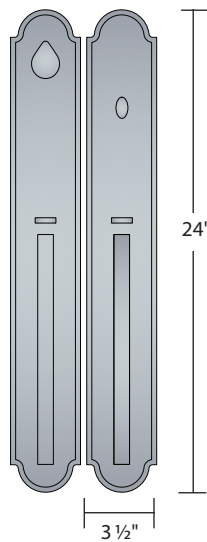





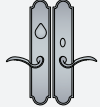

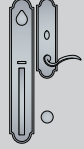
SPLGL

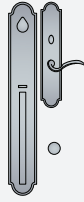
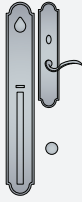
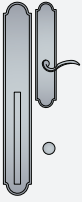

SPLGG

ARCHED SUITE – MORTISE ENTRYSETS

	MORTISE ENTRY ⁽¹⁾ ANSI F12	MORTISE DORMITORY ⁽¹⁾ ANSI F13	FULL DUMMY
LEVER x LEVER OR KNOB x KNOB 13" x 2 ½"	 SPMOR / 12 FUNCTION \$1,283	 SPMOR / 13 FUNCTION \$1,283	 SPMOR / 22 FUNCTION \$675
GRIP x LEVER OR GRIP x KNOB EXTERIOR: 18 ⅞" x 3" INTERIOR: 10" x 2 ½"	 SPSGL / 10 FUNCTION \$1,616	 SPSGL / 11 FUNCTION \$1,616	 SPSGL / 42 FUNCTION \$985
GRIP x LEVER OR GRIP x KNOB EXTERIOR: 24" x 3 ½" INTERIOR: 14" x 3"	 SPLGL / 10 FUNCTION \$1,863	 SPLGL / 11 FUNCTION \$1,863	 SPLGL / 42 FUNCTION \$1,236
GRIP x GRIP 18 ⅞" x 3"	 SPSGG / 14 FUNCTION \$2,107	 SPSGG / 15 FUNCTION \$2,107	 SPSGG / 42 FUNCTION \$1,380
GRIP x GRIP 24" x 3 ½"	 SPLGG / 14 FUNCTION \$2,515	 SPLGG / 15 FUNCTION \$2,515	 SPLGG / 42 FUNCTION \$1,787

ARCHED SUITE / MORTISE ENTRYSETS

(1) See page 8 for explanation of these locks.

ARCHED SUITE – TUBULAR ENTRYSETS & DEADBOLTS

PATINA	ESCUTCHEON	LEVER/KNOB	FUNCTION	HANDING	BACKSET
BZ Dark Bronze	select from	select from	select from	L Left	2 3/8"
WL White Bronze	table below	pages 11-18	table across	R Right	2 3/4"
WM White Medium					
TC Matte Black					
NB Natural Bronze					

For example to order an item in Matte Black (TC) patina, with the 18 1/8" x 3" grip entry escutcheon (SPTUB), the Shropshire (800) lever in a Dummy (42) function for a left hand door (L), use product code: TC.SPTUB.800.42.L

- Available with any lever or knob. \$80 list upcharge per pair of hammered levers/knobs, or \$40 list for a single lever/knob
- Suitable for doors with standard 5 1/2" center to center
- Supplied with tubular latch and deadbolt
- Specify door thickness, handing and backset (2 3/8" or 2 3/4")
- Maximum door thickness for SPTUB (grip x lever/knob entryset): 2 1/2"
- Maximum door thickness for SPLES entryset and deadbolts: 3" for single keyed or patio, 2 1/4" for double-keyed

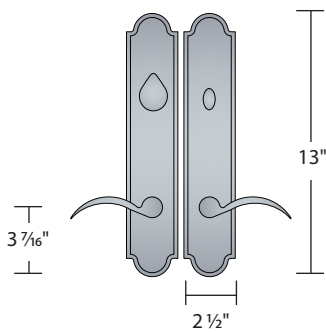

SPLES

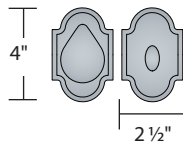

4165

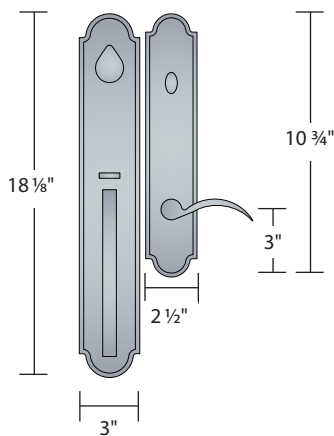

SPTUB

Maximum door thickness 2 1/2"

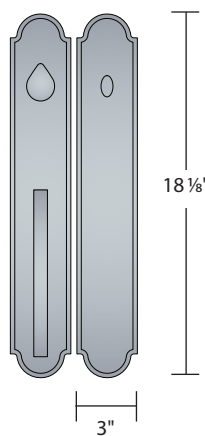





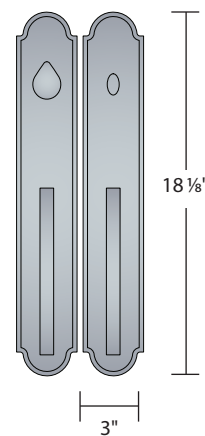





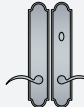
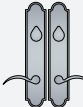

SP.GE.18

Pull/Push and Pull/Pull sets features tubular deadbolt, but no tubular latch
If latching is required, consider the SPTUB grip x lever/knob entryset



SP.GG.18

ARCHED SUITE – TUBULAR ENTRYSETS & DEADBOLTS

	TUBULAR ENTRY	TUBULAR PATIO	DOUBLE ENTRY	FULL DUMMY	ARCHED SUITE / TUBULAR ENTRYSETS
LEVER x LEVER OR KNOB x KNOB 13" x 2 1/2"	 SPLES / 50 FUNCTION \$821	 SPLES / 43 FUNCTION \$821	 SPLES / 52 FUNCTION \$921	 SPLES / 42 FUNCTION \$675	
GRIP x LEVER OR GRIP x KNOB EXTERIOR: 18 1/8" x 3" INTERIOR: 10 3/4" x 2 1/2"	 SPTUB / 50 FUNCTION \$1,184			 SPTUB / 42 FUNCTION \$985	
	DEADBOLT	PATIO DEADBOLT	DOUBLE KEYED DEADBOLT	FULL DUMMY	
DEADBOLT 4" x 2 1/2"	 4165 \$312 Collar available for 1 3/8" doors and Level Bolt	 4765 \$312	 4265 \$372		
PULL x PUSH DEADBOLT (1) 18 1/8" x 3"	 SP.GE.18.50 \$1,364		 SP.GE.18.52 \$1,464	 SP.GE.18.42 \$1,130	
PULL x PULL DEADBOLT (1) 18 1/8" x 3"	 SP.GG.18.50 \$1,767		 SP.GG.18.52 \$1,867	 SP.GG.18.42 \$1,500	

(1) Pull x Push and Pull x Pull sets feature a keyed tubular deadbolt, but not a tubular latch. If latching is required, consider a grip x lever/knob entryset. Order 4165-COLLAR if 4165 deadbolt is to be installed on 1 3/8" door, or with Level Bolt on 1 3/4" door. Price \$54

ARCHED SUITE – PASSAGE & PRIVACY

PATINA	ESCUTCHEON	LEVER/KNOB	FUNCTION	HANDING	BACKSET
BZ Dark Bronze	select from table below	select from pages 11-18	select from table across	L	2 3/8"
WL White Bronze				R	2 3/4"
WM White Medium					
TC Matte Black					
NB Natural Bronze					





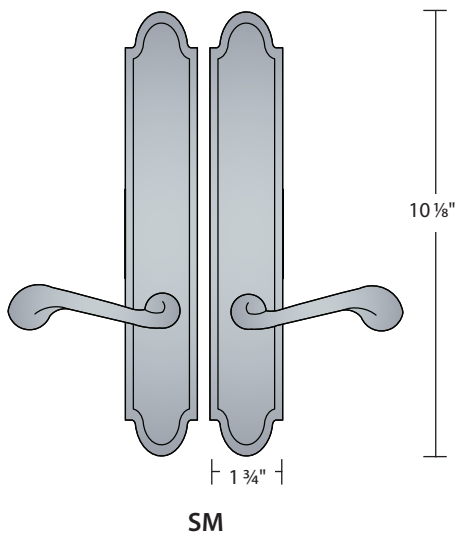
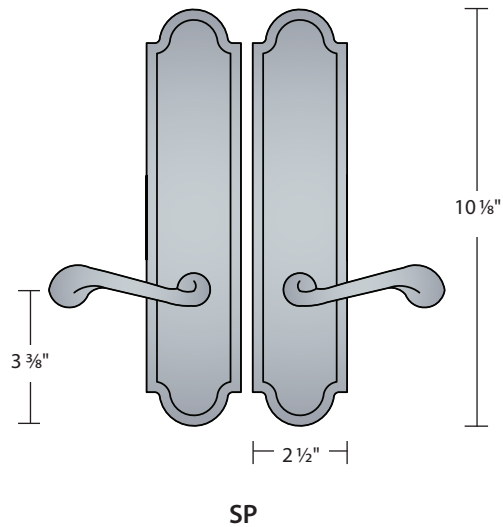
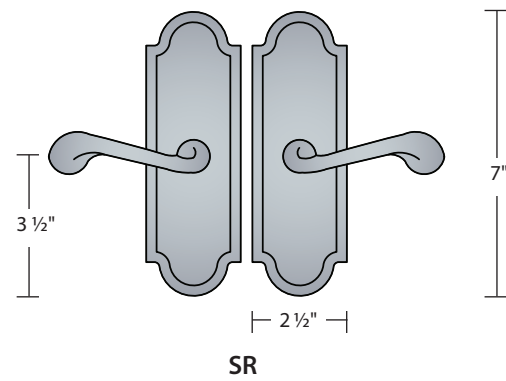
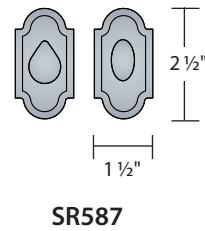
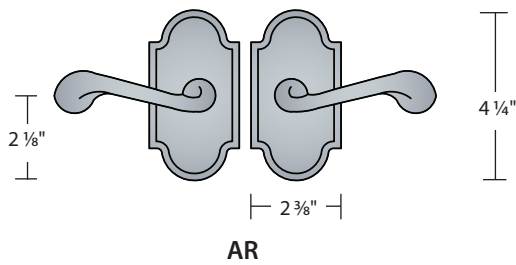

For example to order an item in Dark Bronze (BZ) patina, with the small arched escutcheon (AR), the Churchill (500) lever in a Passage (30) function, use product code: BZ.AR.500.30 and specify backset.

- Available with any lever or knob. \$80 list upcharge per pair of hammered levers/knobs, or \$40 list for a single lever/knob
- Handing not required for tubular passage and privacy sets.
- Specify door thickness and backset (2 3/8" or 2 3/4" for tubular latch; 2 1/2" or 2 3/4" for interior mortise locks)
- Maximum door thickness: 3" (passage); 2 1/2" (privacy)

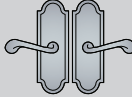
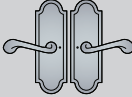

Will not cover 2 1/8" bore

ARCHED SUITE – PASSAGE & PRIVACY

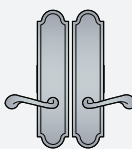
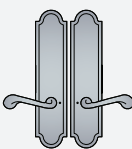
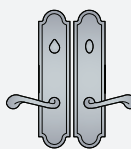
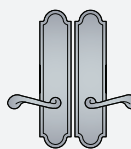
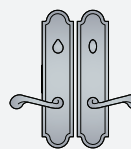
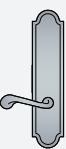
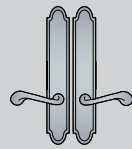
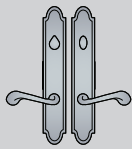
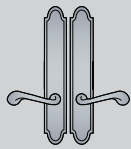
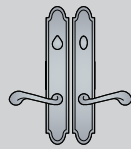
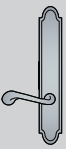
	TUBULAR PASSAGE	TUBULAR PRIVACY (PIN)	TUBULAR PRIVACY (BOLT)	MORTISE PASSAGE	MORTISE PRIVACY	SINGLE DUMMY
LEVER x LEVER OR KNOB x KNOB 4 ¼" x 2 ⅜"	 AR 30 FUNCTION \$336	 AR 20 FUNCTION \$352	 SR587 PRIVACY BOLT \$168			 AR 40 FUNCTION \$168
LEVER x LEVER OR KNOB x KNOB 7" x 2 ½"	 SR 30 FUNCTION \$426	 SR 20 FUNCTION \$442				 SR 40 FUNCTION \$213
LEVER x LEVER OR KNOB x KNOB 10 ⅞" x 2 ½"	 SP 30 FUNCTION \$504	 SP 20 FUNCTION \$520	 SP 26 FUNCTION \$570	 SP 34 FUNCTION \$864	 SP 24 FUNCTION \$894	 SP 40 FUNCTION \$252
LEVER x LEVER OR KNOB x KNOB 10 ⅞" x 1 ¾" Will not cover 2 ⅞" bore	 SM 30 FUNCTION \$502		 SM 26 FUNCTION \$568	 SM 34 FUNCTION \$862	 SM 24 FUNCTION \$892	 SM 40 FUNCTION \$251

ARCHED SUITE / PASSAGE & PRIVACY SETS

Note: Ashley Norton supplies Accurate 9800 series interior locks with our mortise passage and privacy sets. Should you prefer a 3 hour UL rated, full size lock for design or code requirements, please contact us for pricing.

Note: For full dummy, order 1x LH and 1x RH single dummies

CURVED SUITE – MORTISE ENTRYSETS

PATINA	ESCUTCHEON	LEVER/KNOB	FUNCTION	HANDING	BACKSET
BZ Dark Bronze	select from	select from	select from	L LHR	2 ½"
WL White Bronze	table below	pages 11-18	table across	R RHR	2 ¾"
WM White Medium					
TC Matte Black					
NB Natural Bronze					

For example to order an item in White Bronze (WL) patina, with the 24" x 3 ½" grip entry escutcheon (CVLGL), the Apollo (450) lever in an Entry (10) function for a right hand door (R), use product code: WL.CVLGL.450.10.R and specify backset

- Available with any lever or knob. \$80 list upcharge per pair of hammered levers/knobs, or \$40 list for a single lever/knob
- ANSI F12 Entry is supplied with Accurate 9148B lock; ANSI F13 Dormitory is supplied with Accurate 9124B lock. See page 8 for further details. Other locks available on request (upcharge may apply)
- For narrow or extended backsets, please email quote request including quantities to custom@ashleynorton.com
- Specify door thickness and handing including door swing (e.g. Left, Right, Left Reverse, Right Reverse)
- For doors 2 ½" or thicker, a \$150 list upcharge will apply
- Maximum door thickness is 3"

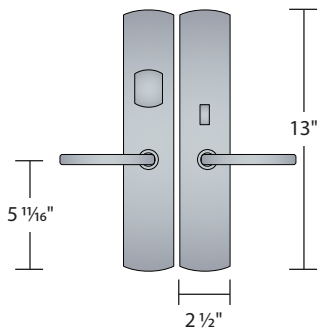

CVMOR

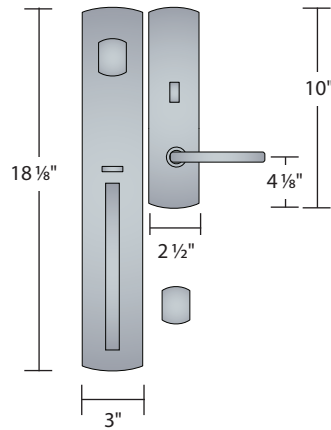

CVSGL

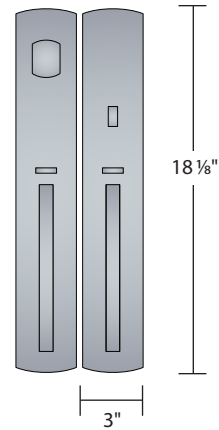

CVSGLG

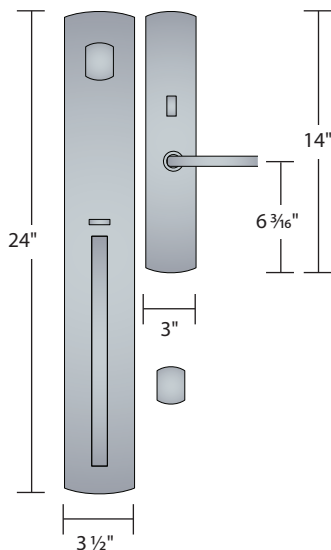



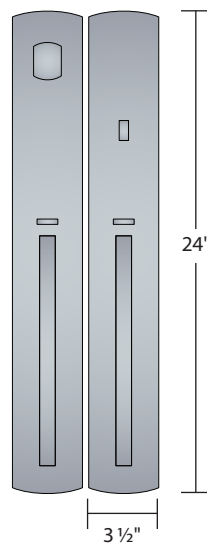





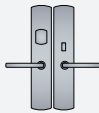
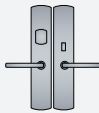
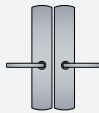
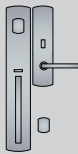



CVLGL



CVLGG

CURVED SUITE – MORTISE ENTRYSETS

	MORTISE ENTRY ⁽¹⁾ ANSI F12	MORTISE DORMITORY ⁽¹⁾ ANSI F13	FULL DUMMY
LEVER x LEVER OR KNOB x KNOB 13" x 2 ½"	 CVMOR / 12 FUNCTION \$1,283	 CVMOR / 13 FUNCTION \$1,283	 CVMOR / 22 FUNCTION \$675
GRIP x LEVER OR GRIP x KNOB EXTERIOR: 18 ⅛" x 3" INTERIOR: 10" x 2 ½"	 CVSGL / 10 FUNCTION \$1,616	 CVSGL / 11 FUNCTION \$1,616	 CVSGL / 42 FUNCTION \$985
GRIP x LEVER OR GRIP x KNOB EXTERIOR: 24" x 3 ½" INTERIOR: 14" x 3"	 CVLGL / 10 FUNCTION \$1,863	 CVLGL / 11 FUNCTION \$1,863	 CVLGL / 42 FUNCTION \$1,236
GRIP x GRIP 18 ⅛" x 3"	 CVSGG / 14 FUNCTION \$2,107	 CVSGG / 15 FUNCTION \$2,107	 CVSGG / 42 FUNCTION \$1,380
GRIP x GRIP 24" x 3 ½"	 CVLGG / 14 FUNCTION \$2,515	 CVLGG / 15 FUNCTION \$2,515	 CVLGG / 42 FUNCTION \$1,787

CURVED SUITE / MORTISE ENTRYSETS

(1) See page 8 for explanation of these locks.

CURVED SUITE – TUBULAR ENTRYSETS & DEADBOLTS

PATINA	ESCUTCHEON	LEVER/KNOB	FUNCTION	HANDING	BACKSET
BZ Dark Bronze	select from	select from	select from	L Left	2 3/8"
WL White Bronze	table below	pages 11-18	table across	R Right	2 3/4"
WM White Medium					
TC Matte Black					
NB Natural Bronze					

For example to order an item in White Bronze (WL) patina, with the 13" x 2 1/2" lever x lever escutcheon (CVLES), the Greenwich (350) lever in a Patio (43) function for a right hand door (R), use product code: WL.CVLES.350.43.R and specify backset



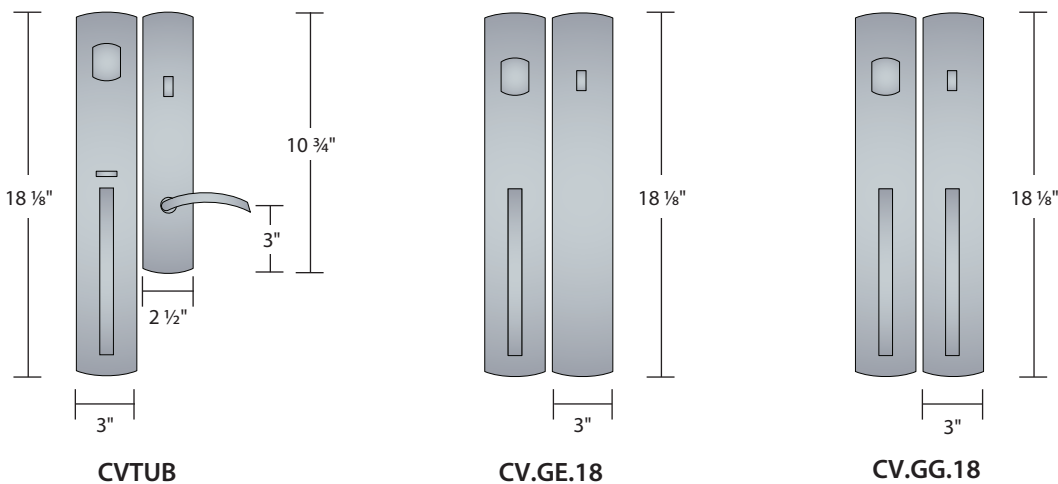
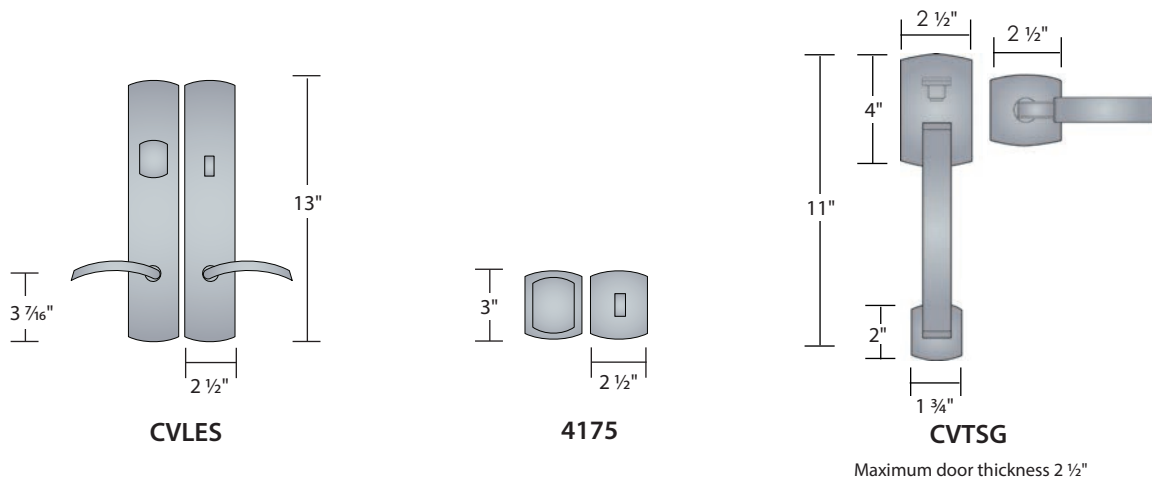









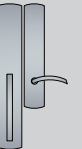
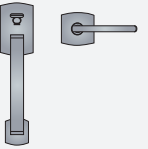
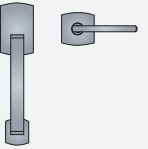

- Available with any lever or knob. \$80 list upcharge per pair of hammered levers/knobs, or \$40 list for a single lever/knob
- Suitable for doors with standard 5 1/2" center to center
- Supplied with tubular latch and deadbolt
- Specify door thickness, handing and backset (2 3/8" or 2 3/4")
- Maximum door thickness for CVTUB and CVTSG (grip x lever/knob entryset): 2 1/2"
- Maximum door thickness for CVLES entryset and deadbolts: 3" for single keyed or patio, 2 1/4" for double-keyed



Maximum door thickness 2 1/2"

Pull/Push and Pull/Pull sets features tubular deadbolt, but no tubular latch
If latching is required, consider the CVTUB grip x lever/knob entryset

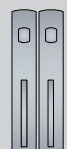
CURVED SUITE – TUBULAR ENTRYSETS & DEADBOLTS

	TUBULAR ENTRY	TUBULAR PATIO	DOUBLE ENTRY	FULL DUMMY
LEVER x LEVER OR KNOB x KNOB 13" x 2 1/2"	 CVLES / 50 FUNCTION \$821	 CVLES / 43 FUNCTION \$821	 CVLES / 52 FUNCTION \$921	 CVLES / 42 FUNCTION \$675
GRIP x LEVER OR GRIP x KNOB EXTERIOR: 18 1/8" x 3" INTERIOR: 10 3/4" x 2 1/2"	 CVTUB / 50 FUNCTION \$1,184			 CVTUB / 42 FUNCTION \$985
SECTIONAL TUBULAR EXTERIOR: 11" x 2 1/2" INTERIOR: 2 1/2" x 2 1/2"	 CVTSG / 30 FUNCTION \$618 Order deadbolt separately			 CVTSG / 42 FUNCTION \$618
	DEADBOLT	PATIO DEADBOLT	DOUBLE KEYED DEADBOLT	FULL DUMMY
DEADBOLT 3" x 2 1/2"	 4175 \$312 Collar available for 1 3/8" doors and Level Bolt	 4775 \$312	 4275 \$372	
PULL x PUSH DEADBOLT (1) 18 1/8" x 3"	 CV.GE.18.50 \$1,364		 CV.GE.18.52 \$1,464	 CV.GE.18.42 \$1,130
PULL x PULL DEADBOLT (1) 18 1/8" x 3"	 CV.GG.18.50 \$1,767		 CV.GG.18.52 \$1,867	 CV.GG.18.42 \$1,500

CURVED SUITE / TUBULAR ENTRYSETS

(1) Pull x Push and Pull x Pull sets feature a keyed tubular deadbolt, but not a tubular latch. If latching is required, consider a grip x lever/knob entryset. Order 4175-COLLAR if 4175 deadbolt is to be installed on 1 3/8" door, or with Level Bolt on 1 3/4" door. Price \$54



CURVED SUITE – PASSAGE & PRIVACY







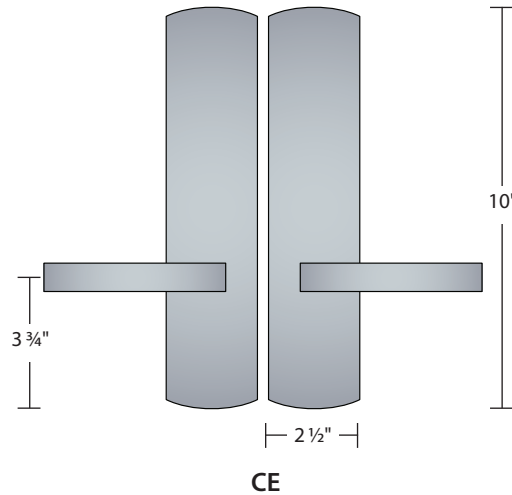
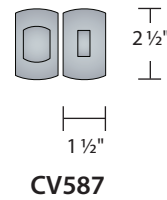
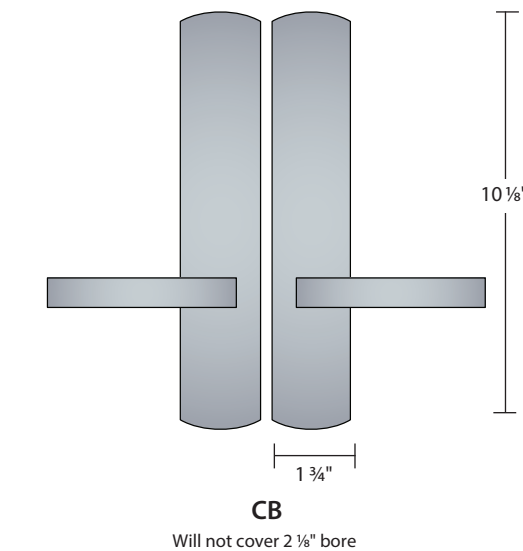
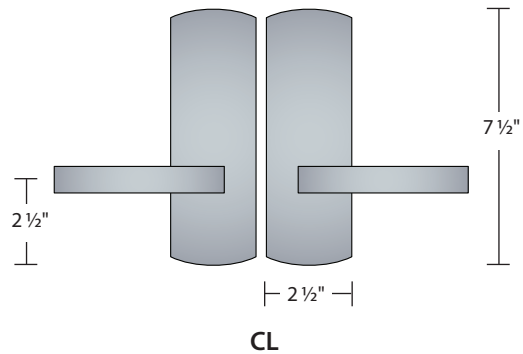
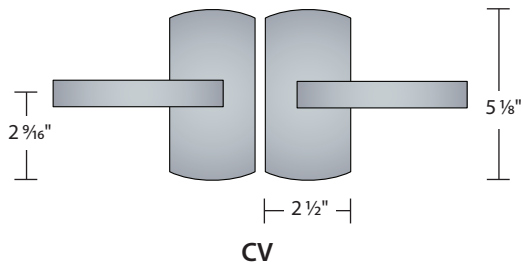



PATINA	ESCUTCHEON	LEVER/KNOB	FUNCTION	HANDING	BACKSET
BZ Dark Bronze	select from table below	select from pages 11-18	select from table across	L	2 3/8"
WL White Bronze					2 3/4"
WM White Medium					
TC Matte Black					
NB Natural Bronze					

For example to order an item in Dark Bronze (BZ) patina, with the 10" x 2 1/2" escutcheon (CE), the Centaur (349) lever in a Single Dummy (40) function for a left hand door (L), use product code: BZ.CE.349.40.L

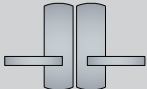
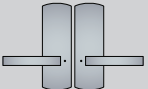
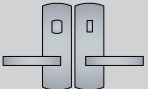
- Available with any lever or knob. \$80 list upcharge per pair of hammered levers/knobs, or \$40 list for a single lever/knob
- Handing not required for tubular passage and privacy sets
- Specify door thickness and backset (2 3/8" or 2 3/4" for tubular latch; 2 1/2" or 2 3/4" for interior mortise locks)
- Maximum door thickness: 3" (passage); 2 1/2" (privacy)

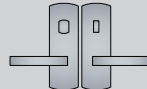

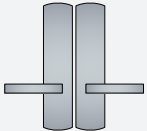
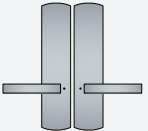
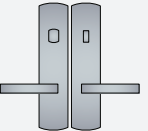
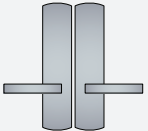
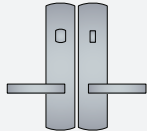
CURVED SUITE – PASSAGE & PRIVACY

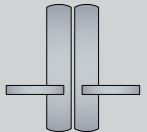
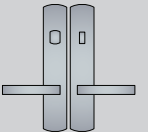
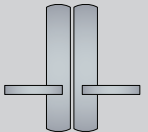
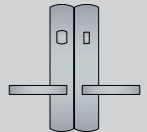
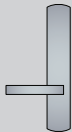
	TUBULAR PASSAGE	TUBULAR PRIVACY (PIN)	TUBULAR PRIVACY (BOLT)	MORTISE PASSAGE	MORTISE PRIVACY	SINGLE DUMMY
LEVER x LEVER OR KNOB x KNOB 5 1/8" x 2 1/2"	 CV 30 FUNCTION \$360	 CV 20 FUNCTION \$376	 CV587 PRIVACY BOLT \$168			 CV 40 FUNCTION \$180
LEVER x LEVER OR KNOB x KNOB 7 1/2" x 2 1/2"	 CL 30 FUNCTION \$426	 CL 20 FUNCTION \$442	 CL 26 FUNCTION \$492	 CL 34 FUNCTION \$786	 CL 24 FUNCTION \$816	 CL 40 FUNCTION \$213
LEVER x LEVER OR KNOB x KNOB 10" x 2 1/2"	 CE 30 FUNCTION \$504	 CE 20 FUNCTION \$520	 CE 26 FUNCTION \$570	 CE 34 FUNCTION \$864	 CE 24 FUNCTION \$894	 CE 40 FUNCTION \$252
LEVER x LEVER OR KNOB x KNOB 10 1/8" x 1 3/4" Will not cover 2 1/8" bore	 CB 30 FUNCTION \$502		 CB 26 FUNCTION \$568	 CB 34 FUNCTION \$862	 CB 24 FUNCTION \$892	 CB 40 FUNCTION \$251

CURVED SUITE / PASSAGE & PRIVACY

Note: Ashley Norton supplies Accurate 9800 series interior locks with our mortise passage and privacy sets. Should you prefer a 3 hour UL rated, full size lock for design or code requirements, please contact us for pricing.

Note: For full dummy, order 1 x LH and 1 x RH single dummies

ANGULAR SUITE – MORTISE ENTRYSETS

PATINA	ESCUTCHEON	LEVER/KNOB	FUNCTION	HANDING	BACKSET
BZ Dark Bronze	select from	select from	select from	L LHR	2 ½"
WL White Bronze	table below	pages 11-18	table across	R RHR	2 ¾"
WM White Medium					
TC Matte Black					
NB Natural Bronze					

For example to order an item in White Bronze (WL) patina, with the 24" x 3 ½" grip entry escutcheon (AGLGL), the Apollo (450) lever in an Entry (10) function for a right hand door (R), use product code: WL.AGLGL.450.10.R and specify backset

- Available with any lever or knob. \$80 list upcharge per pair of hammered levers/knobs, or \$40 list for a single lever/knob
- ANSI F12 Entry is supplied with Accurate 9148B lock; ANSI F13 Dormitory is supplied with Accurate 9124B lock. See page 8 for further details. Other locks available on request (upcharge may apply)
- For narrow or extended backsets, please email quote request including quantities to custom@ashleynorton.com
- Specify door thickness and handing including door swing (e.g. Left, Right, Left Reverse, Right Reverse)
- For doors 2 ½" or thicker, a \$150 list upcharge will apply
- Maximum door thickness is 3"

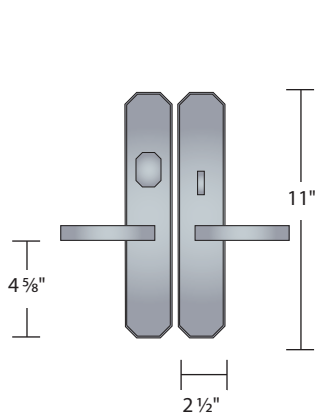

AGMOR

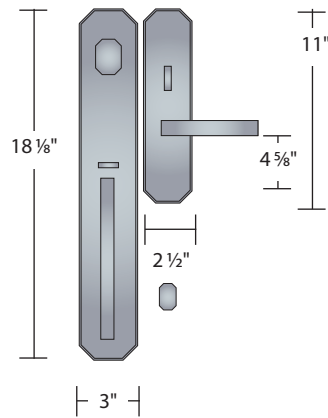

AGSGL

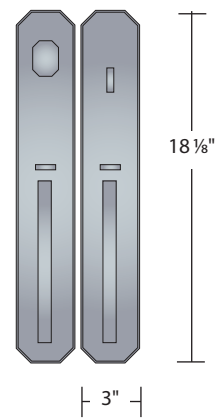

AGSGG

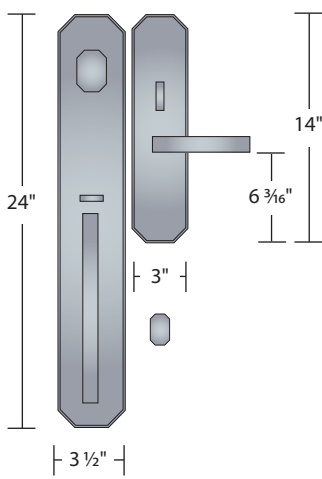



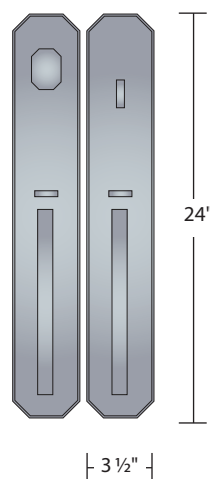





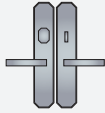
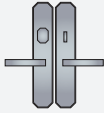





AGLGL



AGLGG

ANGULAR SUITE – MORTISE ENTRYSETS

	MORTISE ENTRY ⁽¹⁾ ANSI F12	MORTISE DORMITORY ⁽¹⁾ ANSI F13	FULL DUMMY
LEVER x LEVER OR KNOB x KNOB 11" x 2 ½"	 AGMOR / 12 FUNCTION \$1,283	 AGMOR / 13 FUNCTION \$1,283	 AGMOR / 22 FUNCTION \$675
GRIP x LEVER OR GRIP x KNOB EXTERIOR: 18 ⅞" x 3" INTERIOR: 11" x 2 ½"	 AGSGL / 10 FUNCTION \$1,616	 AGSGL / 11 FUNCTION \$1,616	 AGSGL / 42 FUNCTION \$985
GRIP x LEVER OR GRIP x KNOB EXTERIOR: 24" x 3 ½" INTERIOR: 14" x 3"	 AGLGL / 10 FUNCTION \$1,863	 AGLGL / 11 FUNCTION \$1,863	 AGLGL / 42 FUNCTION \$1,236
GRIP x GRIP 18 ⅞" x 3"	 AGSGG / 14 FUNCTION \$2,107	 AGSGG / 15 FUNCTION \$2,107	 AGSGG / 42 FUNCTION \$1,380
GRIP x GRIP 24" x 3 ½"	 AGLGG / 14 FUNCTION \$2,515	 AGLGG / 15 FUNCTION \$2,515	 AGLGG / 42 FUNCTION \$1,787

ANGULAR SUITE / MORTISE ENTRYSETS

(1) See page 8 for explanation of these locks.

ANGULAR SUITE – TUBULAR ENTRYSETS & DEADBOLTS

PATINA	ESCUTCHEON	LEVER/KNOB	FUNCTION	HANDING	BACKSET
BZ Dark Bronze	select from table below	select from pages 11-18	select from table across	L Left	2 3/8"
WL White Bronze				R Right	2 3/4"
WM White Medium					
TC Matte Black					
NB Natural Bronze					

For example to order an item in White Bronze (WL) patina, with the 11" x 2 1/2" lever x lever escutcheon (AGLES), the Greenwich (350) lever in a Patio (43) function for a right hand door (R), use product code: WL.AGLES.350.43.R and specify backset

- Available with any lever or knob. \$80 list upcharge per pair of hammered levers/knobs, or \$40 list for a single lever/knob
- Suitable for doors with standard 5 1/2" center to center
- Supplied with tubular latch and deadbolt
- Specify door thickness, handing and backset (2 3/8" or 2 3/4")
- Maximum door thickness for AGTUB (grip x lever/knob entryset): 2 1/2"
- Maximum door thickness for AGLES entryset and deadbolts: 3" for single keyed or patio, 2 1/4" for double-keyed

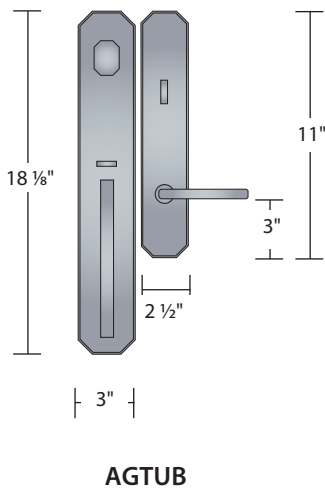
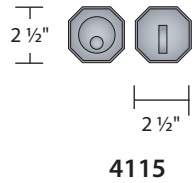
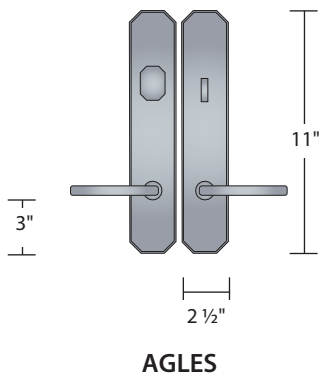



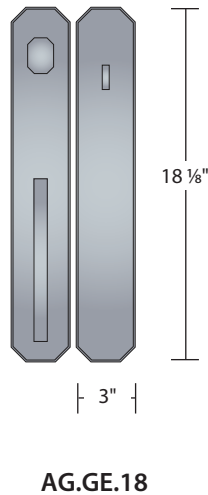



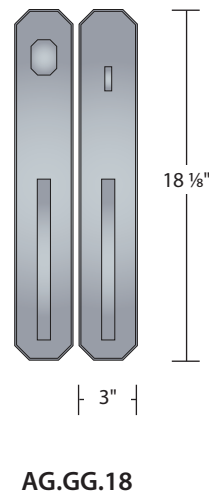



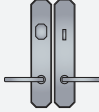
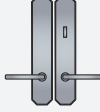
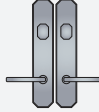
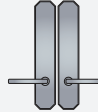

Maximum door thickness 2 1/2"



Pull/Push and Pull/Pull sets features tubular deadbolt, but no tubular latch
If latching is required, consider the AGTUB grip x lever/knob entryset



ANGULAR SUITE – TUBULAR ENTRYSETS & DEADBOLTS

	TUBULAR ENTRY	PATIO	DOUBLE ENTRY	FULL DUMMY
LEVER x LEVER OR KNOB x KNOB 11" x 2 ½"	 AGLES / 50 FUNCTION \$821	 AGLES / 43 FUNCTION \$821	 AGLES / 52 FUNCTION \$921	 AGLES / 42 FUNCTION \$675
GRIP x LEVER OR GRIP x KNOB EXTERIOR: 18 ⅞" x 3" INTERIOR: 11" x 2 ½"	 AGTUB / 50 FUNCTION \$1,184			 AGTUB / 42 FUNCTION \$985
	DEADBOLT	PATIO DEADBOLT	DOUBLE KEYED DEADBOLT	FULL DUMMY
DEADBOLT 2 ½" x 2 ½"	 4115 \$276	 4715 \$276	 4215 \$336	
PULL x PUSH DEADBOLT (1) 18 ⅞" x 3"	 AG.GE.18.50 \$1,364		 AG.GE.18.52 \$1,464	 AG.GE.18.42 \$1,130
PULL x PULL DEADBOLT (1) 18 ⅞" x 3"	 AG.GG.18.50 \$1,767		 AG.GG.18.52 \$1,867	 AG.GG.18.42 \$1,500

ANGULAR SUITE / TUBULAR ENTRYSETS & DEADBOLTS

(1) Pull x Push and Pull x Pull sets feature a keyed tubular deadbolt, but not a tubular latch. If latching is required, consider a grip x lever/knob entryset.

ANGULAR SUITE – PASSAGE & PRIVACY

PATINA	ESCUTCHEON	LEVER/KNOB	FUNCTION	HANDING	BACKSET
BZ Dark Bronze	select from table below	select from pages 11-18	select from table across	L	2 3/8"
WL White Bronze					2 3/4"
WM White Medium					
TC Matte Black					
NB Natural Bronze					

For example to order an item in Dark Bronze (BZ) patina, with the 7 1/2" x 2 1/2" escutcheon (AL), the Centaur (349) lever in a Single Dummy (40) function for a left hand door (L), use product code: BZ.AL.349.40.L

- Available with any lever or knob. \$80 list upcharge per pair of hammered levers/knobs, or \$40 list for a single lever/knob
- Handing not required for tubular passage and privacy sets
- Specify door thickness and backset (2 3/8" or 2 3/4" for tubular latch; 2 1/2" or 2 3/4" for interior mortise locks)
- Maximum door thickness: 3" (passage); 2 1/2" (privacy)

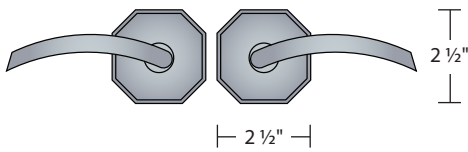

AS

• Not suitable for use with Windsor (900) or Newport (990) knobs

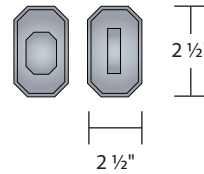

AG587

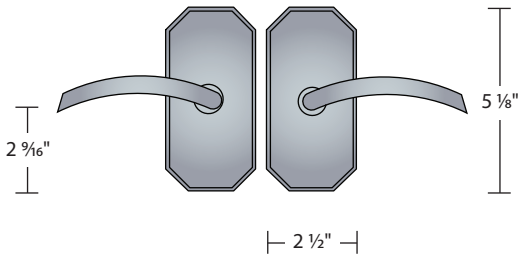

AG

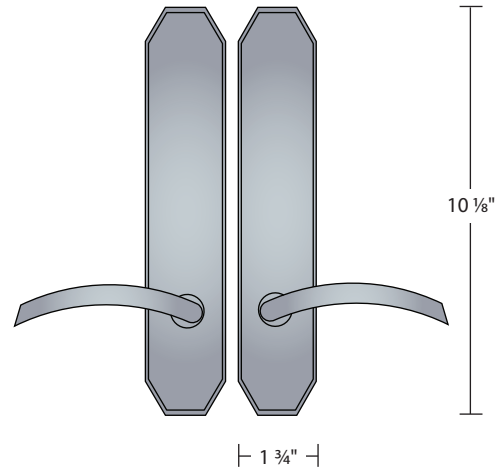





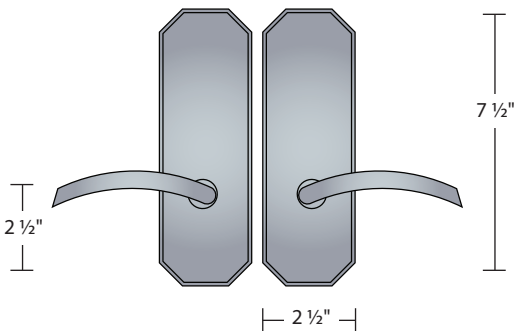





AB

Will not cover 2 1/8" bore

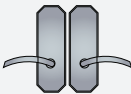
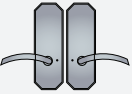
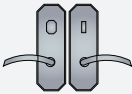
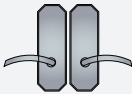
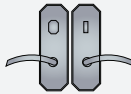

AL

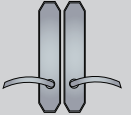
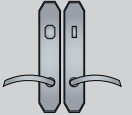
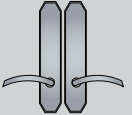
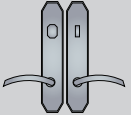
ANGULAR SUITE – PASSAGE & PRIVACY

	TUBULAR PASSAGE	TUBULAR PRIVACY (PIN)	TUBULAR PRIVACY (BOLT)	MORTISE PASSAGE	MORTISE PRIVACY	SINGLE DUMMY
LEVER x LEVER OR KNOB x KNOB 2 ½" x 2 ½"	 AS 30 FUNCTION \$330	 AS 20 FUNCTION \$346	 AG587 PRIVACY BOLT \$168			 AS 40 FUNCTION \$165
LEVER x LEVER OR KNOB x KNOB 5 ⅞" x 2 ½"	 AG 30 FUNCTION \$360	 AG 20 FUNCTION \$376				 AG 40 FUNCTION \$180
LEVER x LEVER OR KNOB x KNOB 7 ½" x 2 ½"	 AL 30 FUNCTION \$426	 AL 20 FUNCTION \$442	 AL 26 FUNCTION \$492	 AL 34 FUNCTION \$786	 AL 24 FUNCTION \$816	 AL 40 FUNCTION \$213
LEVER x LEVER OR KNOB x KNOB 10 ⅞" x 1 ¾" Will not cover 2 ½" bore	 AB 30 FUNCTION \$502		 AB 26 FUNCTION \$568	 AB 34 FUNCTION \$862	 AB 24 FUNCTION \$892	 AB 40 FUNCTION \$251

ANGULAR SUITE / PASSAGE & PRIVACY SETS

Note: Ashley Norton supplies Accurate 9800 series interior locks with our mortise passage and privacy sets. Should you prefer a 3 hour UL rated, full size lock for design or code requirements, please contact us for pricing.

Note: For full dummy, order 1x LH and 1x RH single dummies



TRADITIONAL SUITE – PASSAGE/PRIVACY & DEADBOLTS







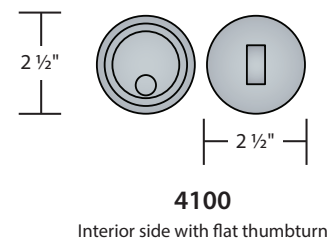
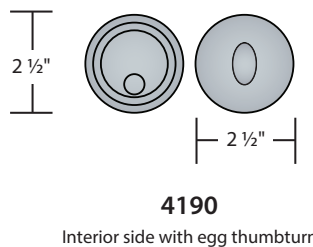
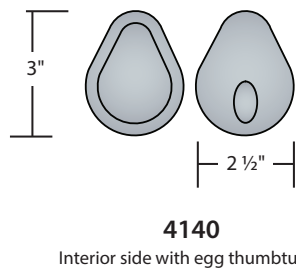
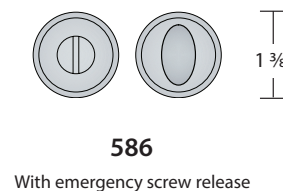
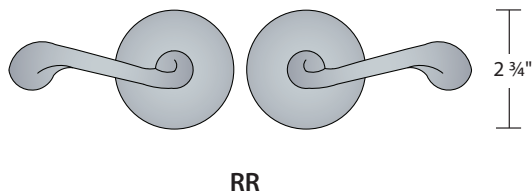
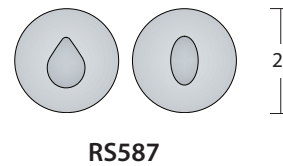
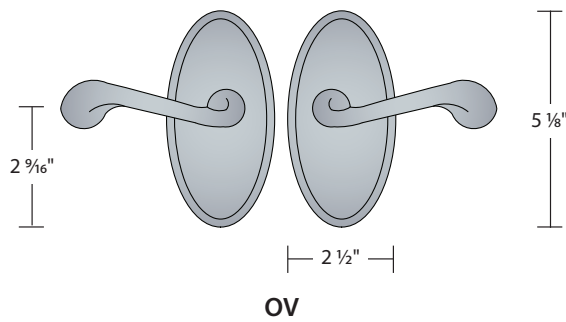



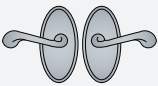
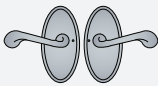





PATINA	ESCUTCHEON	LEVER/KNOB	FUNCTION	HANDING	BACKSET
BZ Dark Bronze	select from	select from	select from	L	2 3/8"
WL White Bronze	table below	pages 11-18	table across	R	2 3/4"
WM White Medium					
TC Matte Black					
NB Natural Bronze					

For example to order an item in Dark Bronze (BZ) patina, with the 5 1/8" x 2 1/2" escutcheon (OV), the Churchill (500) lever in a passage (30) function for a left hand door (L), use product code: BZ.OV.500.30.L and specify backset

- Available with any lever or knob. \$80 list upcharge per pair of hammered levers/knobs, or \$40 list for a single lever/knob
- Handing not required for passage and privacy sets
- Specify door thickness and backset (2 3/8" or 2 3/4")
- Maximum door thickness: 3" (passage); 2 1/2" (privacy)



TRADITIONAL SUITE – PASSAGE/PRIVACY & DEADBOLTS

	TUBULAR PASSAGE	TUBULAR PRIVACY (PIN)	PRIVACY (BOLT)	DUMMY	TRADITIONAL SUITE / PASSAGE & PRIVACY SETS	
LEVER x LEVER OR KNOB x KNOB 5 1/8" x 2 1/2"	 OV 30 FUNCTION \$360	 OV 20 FUNCTION \$376		 OV 40 FUNCTION \$180		
LEVER x LEVER OR KNOB x KNOB DIA. 2 3/4"	 RR 30 FUNCTION \$330	 RR 20 FUNCTION \$346	 586 PRIVACY BOLT \$148	 RR 40 FUNCTION \$165		
			 RS587 PRIVACY BOLT \$148	 RR 42 FUNCTION \$330		
	DEADBOLT	PATIO DEADBOLT	DOUBLE KEYED DEADBOLT	FULL DUMMY		TRADITIONAL SUITE / DEADBOLTS
DEADBOLT (egg thumbturn) 3" x 2 1/2"	 4140 \$312	 4740 \$312	 4240 \$372			
DEADBOLT (egg thumbturn) DIA.: 2 1/2"	 4190 \$276 Collar available for 1 3/8" doors and Level Bolt	 4790 \$276	 4200 \$336			
DEADBOLT (flat thumbturn) DIA.: 2 1/2"	 4100 \$276 Collar available for 1 3/8" doors and Level Bolt	 4700 \$276				

Note: For full dummy with OV plate, order 1x LH and 1x RH single dummies

Order 4100-COLLAR if 4100 or 4190 deadbolts are to be installed on 1 3/8" door, or with Level Bolt on 1 3/4" door. Price \$54



MULTIPOINT HANDLESETS

Ashley Norton offers multipoint handlesets to suit most door and lock manufacturers.

To determine the correct multipoint handleset configuration, a few pieces of information are required:

- The manufacturer of the french door or multipoint lock
- The distance between the lever and the cylinder - typically 92mm or 105mm
- The type of cylinder - American, Europrofile or Andersen
- Whether the levers are above or below the cylinder

Listed below are some of the most common door and lock manufacturers. Our customer service team is available to assist in identifying the correct configuration for specific locks - email lock drawings to service@ashleynorton.com to get started.

Ashley Norton provides handlesets, spindle, screws and cylinder (where needed). We do not include the multipoint lock, strike or faceplate.

All of our handlesets have a two-way spring assist to avoid lever-sag.

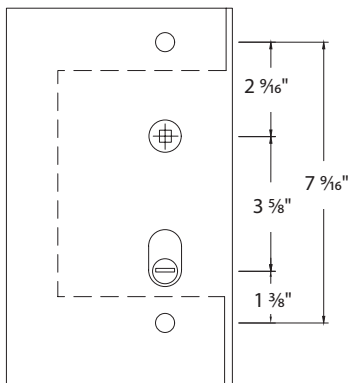

CONFIGURATION 1 - LEVER HIGH / AMERICAN CYLINDER

Lever-high American cylinder locks with 92mm CTC
e.g. G-U locks, Lepage Millwork

Not suitable for Marvin Integrity doors

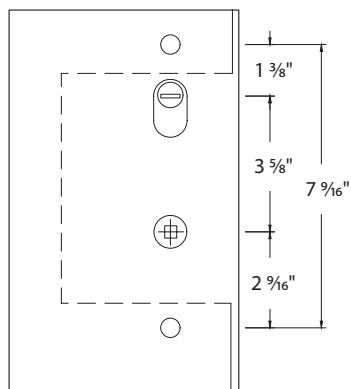

CONFIGURATION 2 - LEVER LOW / AMERICAN CYLINDER

Lever-low American cylinder locks with 92mm CTC
e.g. G-U locks, Sierra Pacific Wisconsin Product (formerly Hurd),
Biltbest

CONFIGURATION 3 - ANDERSEN LOCKS
Lever-low Andersen locks with 105mm CTC

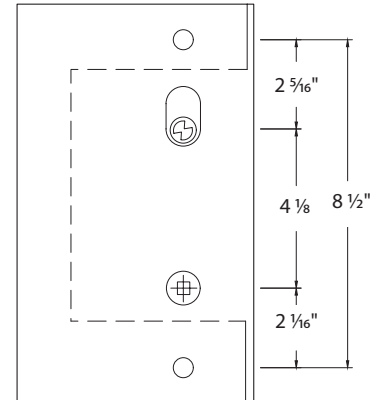

CONFIGURATION 4 - ASHLAND LOCKS
Lever-low Ashland locks with 92mm CTC
e.g. Caradco, JELD-WEN⁽¹⁾, Marvin⁽²⁾, PGT and Weather Shield⁽¹⁾

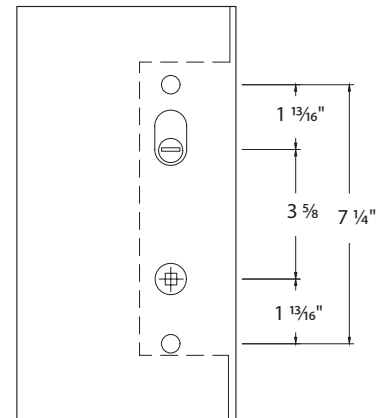

CONFIGURATION 5 - EUROPROFILE CYLINDER
Lever-high Europrofile cylinder locks with 92mm CTC
e.g. Hoppe locks, JELD-WEN⁽¹⁾, Kolbe, KFV, Lincoln, Loewen, Norco, Peachtree, Semco, Weather Shield⁽¹⁾, Sierra Pacific⁽³⁾, Windsor and Vetter

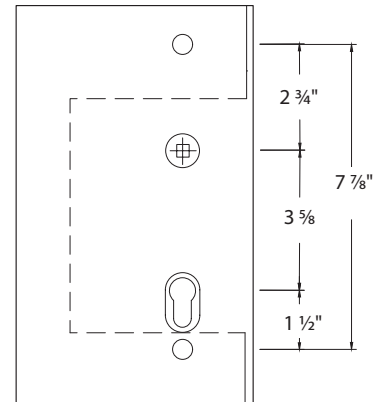

CONFIGURATION 6 - LEVER HIGH / AMERICAN CYLINDER
Lever-high American cylinder locks with 92mm CTC
e.g. G-U locks, Milgard, Pella

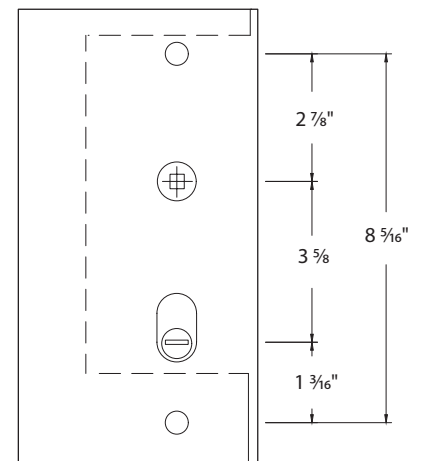

(1) JELD-WEN and Weather Shield may use either Hoppe or Ashland locks.
(2) For true Marvin doors only, not suitable for Integrity.
(3) Sierra Pacific Wisconsin Product (formerly Hurd) uses G-U locks, see Configuration 2

MULTIPOINT CONFIGURATION 1 – AMERICAN CYLINDER BELOW LEVER

PATINA	ESCUTCHEON	LEVER	FUNCTION	HANDING
BZ Dark Bronze	select from table	select from	select from	L
WL White Bronze	below	pages 11-16	table below	R
WM White Medium				
TC Matte Black				
NB Natural Bronze				

- Available with any lever. \$80 list upcharge per pair of hammered levers
- Suitable for lever-high G-U locks with 92mm CTC and similar operated using an American cylinder
- 7 5/16" screw to screw
- Doors require Patio (53) function on secondary panel of double doors where active multipoint hardware is present
- For 13" x 2 1/2" wide plate, change last digit of escutcheon to 5 (e.g. change SQLP4 to SQLP5). \$350 list upcharge applies. Wide plate option not available in Angular Suite (AGLP5 not available).
- Door manufacturers listed for reference only and subject to change. Multipoint lock, strike and faceplate not included

	REFERENCE	ENTRY	PATIO	DUMMY
US TAILPIECE LEVER HIGH				
G-U LOCKS	LEPAGE MILLWORK			FIXED FIXED
92mm CTC		55 FUNCTION	53 FUNCTION	42 FUNCTION
		\$564	\$564	\$564

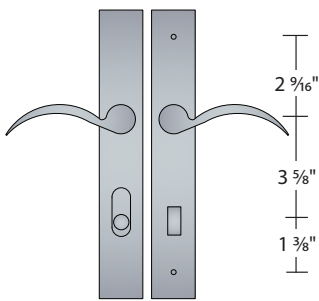

MDLP4
10 1/8" x 1 3/4"

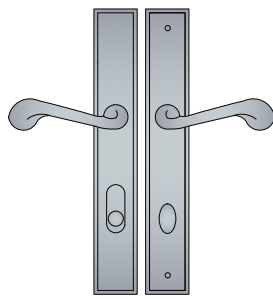

SQLP4
10 1/8" x 1 3/4"

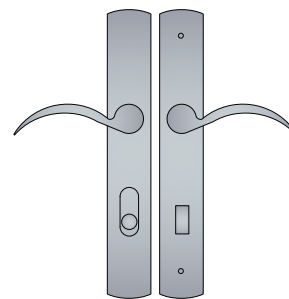

CVLP4
10 1/8" x 1 3/4"

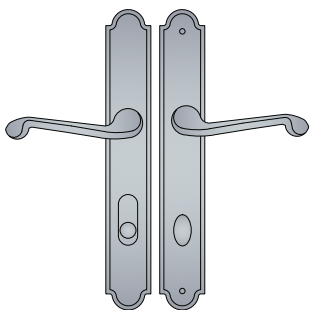

SPLP4
11 1/4" x 1 3/4"

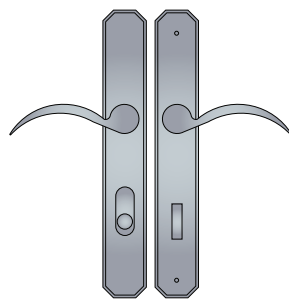





AGLP4
10 1/8" x 1 3/4"

MULTIPOINT CONFIGURATION 2 – AMERICAN CYLINDER ABOVE LEVER

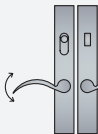
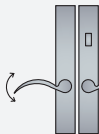
PATINA	ESCUTCHEON	LEVER	FUNCTION	HANDING
BZ Dark Bronze	select from table	select from	select from	L
WL White Bronze	below	pages 11-16	table below	R
WM White Medium				
TC Matte Black				
NB Natural Bronze				

- Available with any lever. \$80 list upcharge per pair of hammered levers
- Suitable for lever-low G-U locks with 92mm CTC and similar operated using an American cylinder
- 7 1/16" screw to screw
- Doors require Patio (53) function on secondary panel of double doors where active multipoint hardware is present
- For 13" x 2 1/2" wide plate, change last digit of escutcheon to 5 (e.g. change SQEG4 to SQEG5). \$350 list upcharge applies
Wide plate option not available in Angular Suite (AGEG5 not available).
- Door manufacturers listed for reference only and subject to change. Multipoint lock, strike and faceplate not included

	REFERENCE	ENTRY	PATIO	DUMMY
US TAILPIECE LEVER LOW				
G-U LOCKS	SIERRA PACIFIC WISCONSIN PRODUCT (FORMERLY HURD), BILTBEST			
92mm CTC		55 FUNCTION	53 FUNCTION	47 FUNCTION
		\$564	\$564	\$564

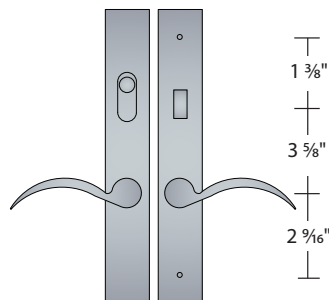

MDEG4
10 1/8" x 1 3/4"

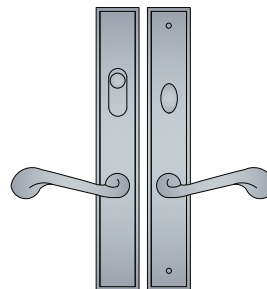

SQEG4
10 1/8" x 1 3/4"

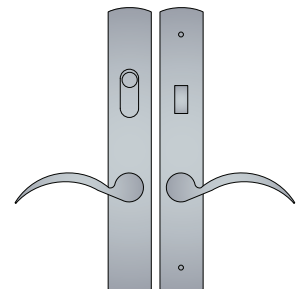

CVEG4
10 1/8" x 1 3/4"

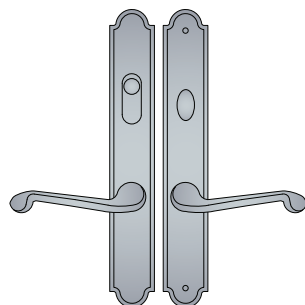

SPEG4
11 1/4" x 1 3/4"

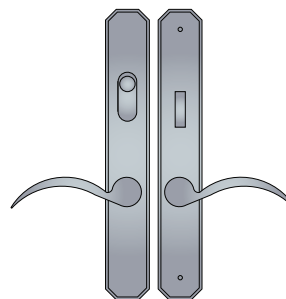

AGEG4
10 1/8" x 1 3/4"

MULTIPOINT CONFIGURATION 3 – ANDERSEN LOCKS

PATINA	ESCUTCHEON	LEVER	FUNCTION	HANDING
BZ Dark Bronze	select from table below	select from pages 11-16	select from table below	L
WL White Bronze				R
WM White Medium				
TC Matte Black				
NB Natural Bronze				

- Available with any lever. \$80 list upcharge per pair of hammered levers
- Suitable for Andersen locks with 105mm CTC
- 8 ½" screw to screw
- Andersen's double doors require a Passive (39) function on the secondary panel of double doors
- Multipoint lock, strike and faceplate not included
- Wide plate option not available for Andersen locks

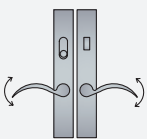
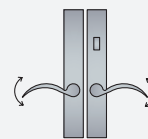
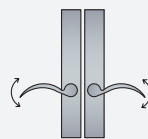
	REFERENCE	ENTRY	PATIO	DUMMY
US TAILPIECE LEVER HIGH				
ANDERSEN LOCKS	ANDERSEN			
105 mm CTC		55 FUNCTION	53 FUNCTION	39 FUNCTION
		\$564	\$564	\$564

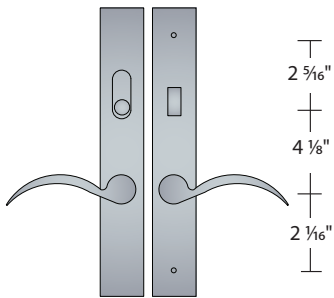

MDAD4
10 1/8" x 1 3/4"

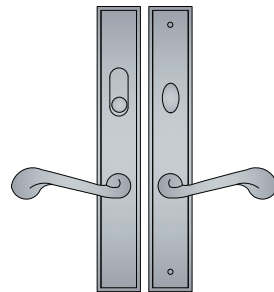

SQAD4
10 1/8" x 1 3/4"

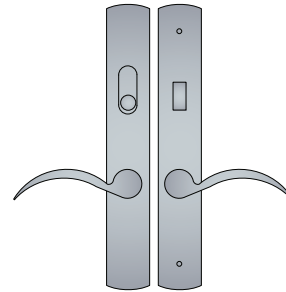

CVAD4
10 1/8" x 1 3/4"

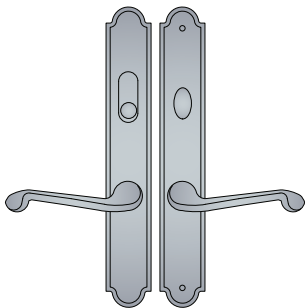

SPAD4
11 1/4" x 1 3/4"

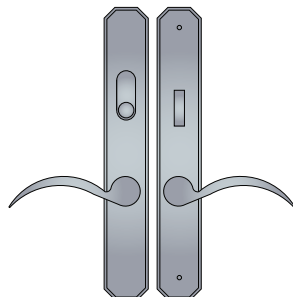

AGAD4
10 1/8" x 1 3/4"

MULTIPOINT CONFIGURATION 4 – ASHLAND LOCKS

PATINA	ESCUTCHEON	LEVER	FUNCTION	HANDING
BZ Dark Bronze	select from table below	select from pages 11-16	select from table below	L
WL White Bronze				R
WM White Medium				
TC Matte Black				
NB Natural Bronze				

- Available with any lever. \$80 list upcharge per pair of hammered levers
- Suitable for Ashland locks with 92mm CTC
- 7 ¼" screw to screw
- Marvin and Weather Shield doors require Passive (39) function on the secondary panel of double doors where active multipoint hardware is present
- For 13" x 2 ½" wide plate, change last digit of escutcheon to 5 (e.g. change SQMR4 to SQMR5). \$350 list upcharge applies. Wide plate option not available in Angular Suite (AGMR5 not available).
- Door manufacturers listed for reference only and subject to change. Multipoint lock, strike and faceplate not included

	REFERENCE	ENTRY	PATIO	DUMMY	PASSIVE
US TAILPIECE LEVER LOW					
ASHLAND LOCKS	CARADCO, JELD-WEN ⁽¹⁾ , MARVIN ⁽²⁾ , PGT, WEATHER SHIELD ⁽¹⁾			FIXED	
92 mm CTC		55 FUNCTION	53 FUNCTION	47 FUNCTION	39 FUNCTION
		\$564	\$564	\$564	\$564

(1) JELD-WEN and Weather Shield doors may use either Hoppe or Ashland locks depending on product range and manufacture date

(2) For true Marvin doors only, not suitable for Integrity

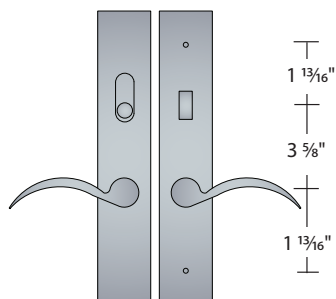

MDMR4
10 1/8" x 1 7/8"

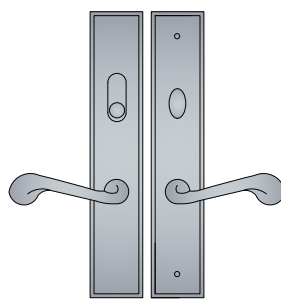

SQMR4
10 1/8" x 1 7/8"

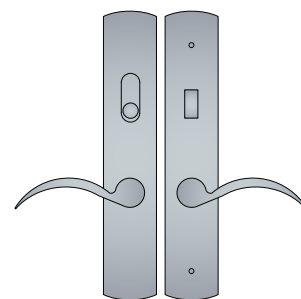

CVMR4
10 1/8" x 1 7/8"

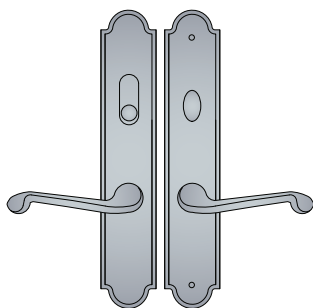

SPMR4
11 1/4" x 1 7/8"

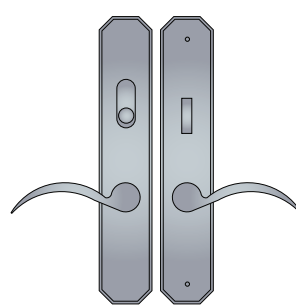

AGMR4
10 1/8" x 1 7/8"

MULTIPOINT CONFIGURATION 5 – PROFILE CYLINDER BELOW LEVER

PATINA	ESCUTCHEON	LEVER	FUNCTION	HANDING
BZ Dark Bronze	select from table below	select from pages 11-16	select from table below	L
WL White Bronze				R
WM White Medium				
TC Matte Black				
NB Natural Bronze				

- Available with any lever. \$80 list upcharge per pair of hammered levers
- Suitable for Hoppe locks or similar with 92mm CTC using a profile cylinder. Screw to screw is 7 7/8"
- Contact us before ordering split finish keyed entry function with profile cylinder as upcharge will apply
- We assume lock is centered within door. Offset profile cylinders available for certain 2 1/4" doors, contact us for details and pricing
- Doors require Patio (58) function on secondary panel of double doors where active multipoint hardware is present
- For 13" x 2 1/2" wide plate, change last digit of escutcheon to 5 (e.g. change SQUE4 to SQUE5). \$350 list upcharge applies. Wide plate option not available in Angular Suite (AGEU5 not available).
- Door manufacturers listed for reference only and subject to change. Multipoint lock, strike and faceplate not included

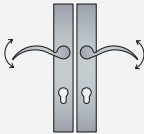
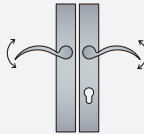
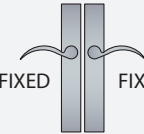
	REFERENCE	ENTRY	PATIO	DUMMY
PROFILE CYLINDER LEVER HIGH	JELD-WEN ⁽¹⁾ , KOLBE & KOLBE, KFV, LINCOLN, LOEWEN, NORCO, PEACHTREE, SEMCO, WEATHER SHIELD ⁽¹⁾ , SIERRA PACIFIC ⁽²⁾ , WINDSOR, VETTER			
HOPPE LOCKS		57 FUNCTION	58 FUNCTION	42 FUNCTION
92 mm CTC		\$564	\$564	\$564

(1) JELD-WEN and Weather Shield doors may use either Hoppe or Ashland locks depending on product range and manufacture date
 (2) Sierra Pacific Wisconsin Product (formerly Hurd) uses G-U locks, see configuration (2)

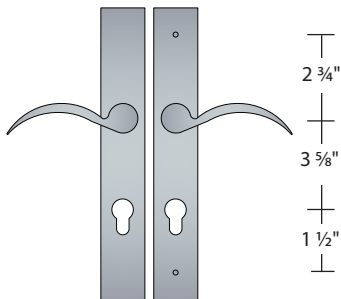

MDEU4
10 1/8" x 1 3/4"

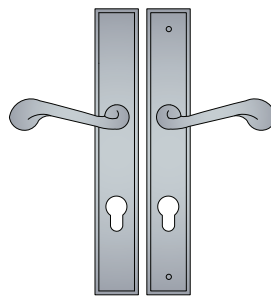

SQUE4
10 1/8" x 1 3/4"

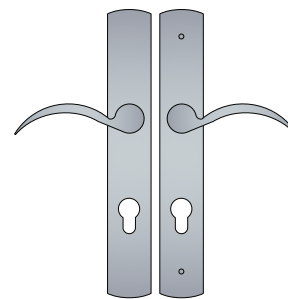

CVEU4
10 1/8" x 1 3/4"

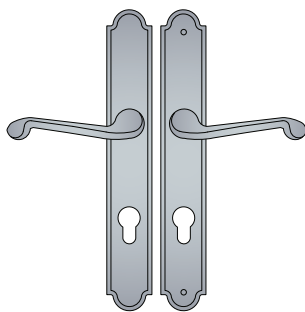

SPEU4
11 1/4" x 1 3/4"

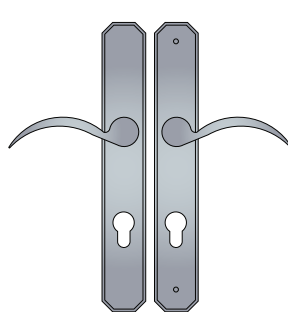

AGEU4
10 1/8" x 1 3/4"

MULTIPOINT CONFIGURATION 6 – AMERICAN CYLINDER BELOW LEVER

PATINA	ESCUTCHEON	LEVER	FUNCTION	HANDING
BZ Dark Bronze	select from table below	select from pages 11-16	select from table below	L
WL White Bronze				R
WM White Medium				
TC Matte Black				
NB Natural Bronze				

- Available with any lever. \$80 list upcharge per pair of hammered levers
- Suitable for lever-high G-U locks with 92mm CTC and similar operated using an American cylinder
- 8 5/16" screw to screw
- Most doors require Patio (53) function on secondary panel of double doors where active multipoint hardware is present
- For 13" x 2 1/2" wide plate, change last digit of escutcheon to 5 (e.g. change SQUS4 to SQUS5). \$350 list upcharge applies. Wide plate option not available in Angular Suite (AGUS5 not available).
- Door manufacturers listed for reference only and subject to change. Multipoint lock, strike and faceplate not included

	REFERENCE	ENTRY	PATIO	DUMMY
US TAILPIECE LEVER HIGH				
G-U LOCKS	MILGARD, PELLA			
92 mm CTC				
		55 FUNCTION \$564	53 FUNCTION \$564	42 FUNCTION \$564

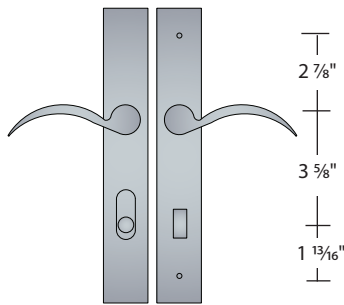

MDUS4
10 1/8" x 1 3/4"

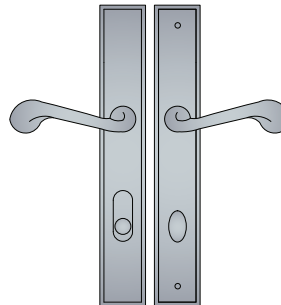

SQUS4
10 1/8" x 1 3/4"

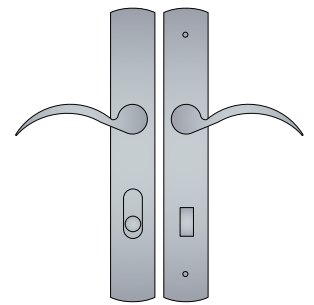

CVUS4
10 1/8" x 1 3/4"

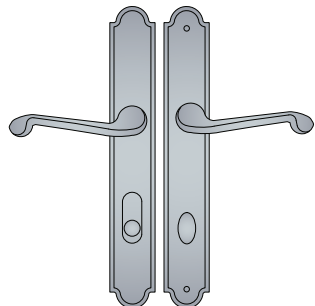

SPUS4
11 1/4" x 1 3/4"

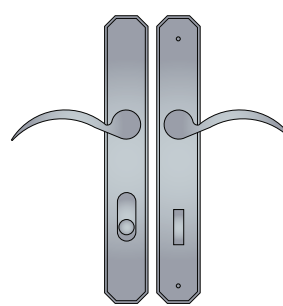

AGUS4
10 1/8" x 1 3/4"



TRIM FOR SLIDING FRENCH & PATIO DOORS

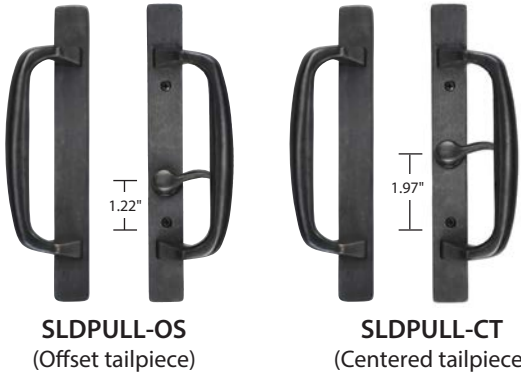

Single Point Sliding Handle

8 3/8" x 1"

- Suitable for locks with mounting holes 100mm (3.94") apart.
- Narrow (1") plate makes this ideal for doors with narrow stile.
- Handing not required.

FUNCTION	RECTANGULAR	PRICE
Patio with offset tailpiece	SLDPULL-OS.43	\$414
Patio with centered tailpiece	SLDPULL-CT.43	\$414
Dummy	SLDPULL.42	\$414

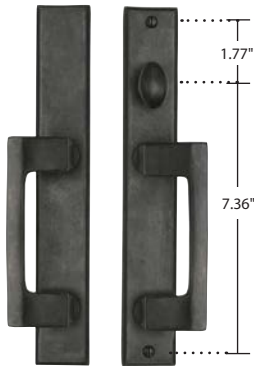

Handle for Hoppe HLS 9000 Lock

- Suitable only for Hoppe HLS 9000 sliding door lock.
- Thumbturn operates a 7mm spindle (square orientation).
- Available with Offset Apollo (454) handle as shown on left.

SUITE	HANDLE	FUNCTION	PRICE
SQHPS Rectangular 10 1/8" x 1 1/2"	454 Offset	43 Patio	\$674
MDHPS Urban 10 1/8" x 1 1/2"	Apollo	42 Dummy	\$674

SQHPS

10 1/8" x 1 1/2"

Shown with 454 Offset Apollo handle
in dark bronze patina

TRIM FOR SLIDING FRENCH & PATIO DOORS

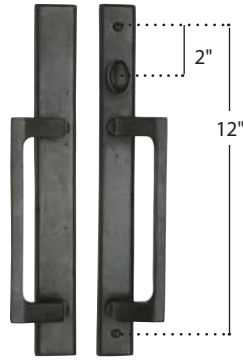

TSL / MTL CONFIGURATION
 13 3/4" x 1 1/4" Plate
 Shown with Dunn Pull

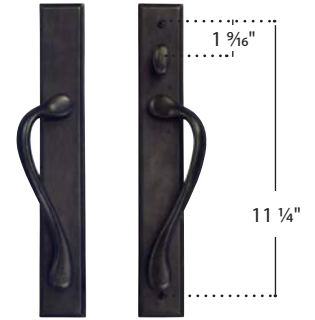

MWF CONFIGURATION
 13 x 1 7/8" Plate
 Shown with York Pull

- The above handlesets are configured to operate a lock with an American tailpiece. If the lock has a 7mm spindle, see handlesets for HLS 9000 lock on previous page.
- Match distance from top screw to thumbturn, and between top and bottom screws with one of the above plate configurations. If top screw to thumbturn is 2", then order MTL configuration for Marvin doors and TSL configuration for others.
- Marvin sliding doors may use either MWF or MTL configurations depending on date of manufacture, contact us for assistance
- Choose pull handle design - either the Dunn handle or the York handle can be combined with any plate configuration.
- Handing is not required.

SUITE	CONFIGURATION	PULL	FUNCTION	PRICE
SQ Rectangular			43 Patio	\$674
MD Urban	TSL or MTL or MWF	York or Dunn	42 Dummy	\$674



Flush Pull

ITEM	SIZE	PRICE
1823	7" x 2 1/4"	\$162



Round Flush Pull

ITEM	OUTER DIA.	INNER DIA.	PRICE
1821.2	2 1/2"	2 1/8"	\$75



Edge Pull

ITEM	PRICE
1165	\$50

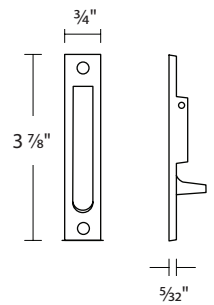

Flush Pull

ITEM	LENGTH	PRICE
1820 4	4"	\$52
1820 6	6"	\$69
1820 8	8"	\$85
1820 12	12"	\$148

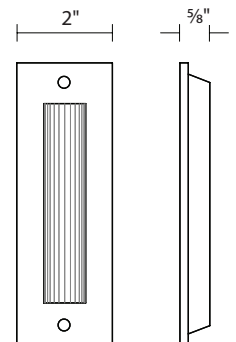







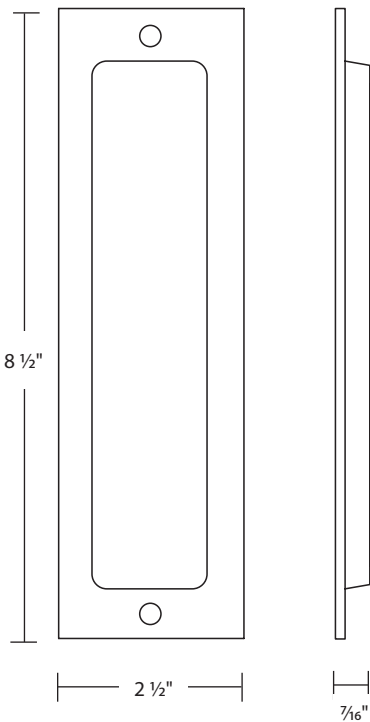

SLIDING & POCKET DOOR HARDWARE

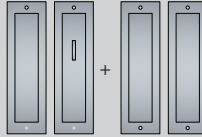

Sliding/Pocket Door Hardware
8 1/2" x 2 1/2"

- Supplied with mortise lock
- Available 2 1/2" or 2 3/4" backset
- Minimum door thickness: 1 3/4"
- Maximum door thickness: 2 1/4"
- Keyed version cannot be flush mounted

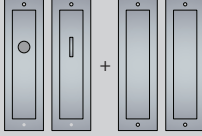

	<p>1830.8.25</p> <ul style="list-style-type: none"> • Privacy Function • Includes Mortise Lock / Pull • Minimum Door Thickness 1 3/4" 	<p>\$671</p>
	<p>1830.8.25 DBL</p> <ul style="list-style-type: none"> • Privacy Function for Double Doors • Includes Mortise Lock / Pull and Mortise Strike / Pull • Minimum Door Thickness 1 3/4" 	<p>\$1,331</p>
	<p>1830.8.44</p> <ul style="list-style-type: none"> • Patio Function • Includes Mortise Lock / Pull • Minimum Door Thickness 1 3/4" 	<p>\$671</p>
	<p>1830.8.44 DBL</p> <ul style="list-style-type: none"> • Patio Function for Double Doors • Includes Mortise Lock / Pull and Mortise Strike / Pull • Minimum Door Thickness 1 3/4" 	<p>\$1,331</p>
	<p>1830.8.50</p> <ul style="list-style-type: none"> • Entry Function • Includes Mortise Lock / Pull • Minimum Door Thickness 1 3/4" • Keyed Set Cannot be Flush Mounted 	<p>\$770</p>
	<p>1830.8.50 DBL</p> <ul style="list-style-type: none"> • Entry Function for Double Doors • Includes Mortise Lock / Pull and Mortise Strike / Pull • Minimum Door Thickness 1 3/4" • Keyed Set Cannot be Flush Mounted 	<p>\$1,430</p>
	<p>1830.8.34</p> <ul style="list-style-type: none"> • Passage Function • Includes Accurate 2000 Pull <p>For larger 2002CPDP Pull, add \$100 list</p>	<p>\$539</p>
	<p>1830.8.40</p> <ul style="list-style-type: none"> • Flush Pull • Single Pull Supplied • No Lock 	<p>\$110</p>

POCKET DOOR HARDWARE

SLIDING & POCKET DOOR HARDWARE







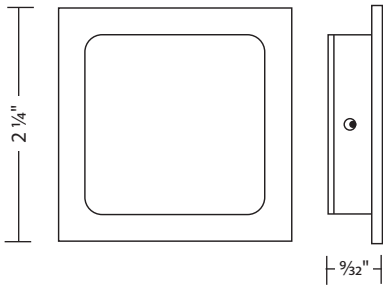

Sliding/Pocket Door Hardware

2 1/4" x 2 1/4"

Lip thickness: 2mm (5/64")

- Supplied with mortise lock
- Minimum door thickness 1 3/8"
- Maximum door thickness 2 1/4"
- Must be surface mounted on 1 3/8" doors



	<p>1870.25</p> <ul style="list-style-type: none"> • Privacy Function • Includes Mortise Lock / Pull • Minimum Door Thickness 1 3/8" 	<p>\$583</p>
	<p>1870.25 DBL</p> <ul style="list-style-type: none"> • Privacy Function for Double Doors • Includes Mortise Lock / Pull and Mortise Strike / Pull • Minimum Door Thickness 1 3/8" 	<p>\$1,155</p>
	<p>1870.44</p> <ul style="list-style-type: none"> • Patio Function • Includes Mortise Lock / Pull • Minimum Door Thickness 1 3/8" 	<p>\$583</p>
	<p>1870.44 DBL</p> <ul style="list-style-type: none"> • Patio Function for Double Doors • Includes Mortise Lock / Pull and Mortise Strike / Pull • Minimum Door Thickness 1 3/8" 	<p>\$1,155</p>
	<p>1870.34</p> <ul style="list-style-type: none"> • Passage Function • Includes Mortise Pull • Minimum Door Thickness 1 3/8" <p>For larger 2002CPDP Pull, add \$100 list</p>	<p>\$439</p>
	<p>1870.40</p> <ul style="list-style-type: none"> • Flush Pull • Single Pull Supplied • No Lock 	<p>\$68</p>

POCKET DOOR HARDWARE

GATE HARDWARE

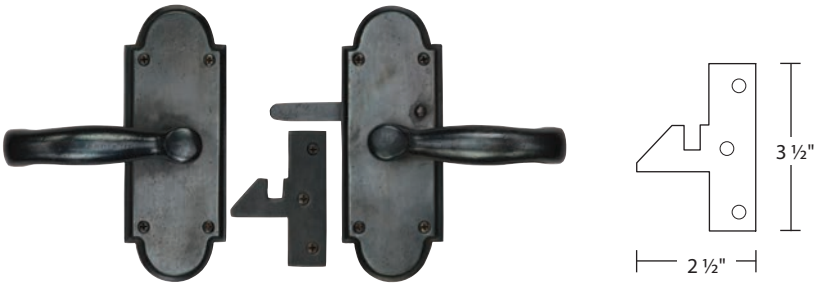

Gate Latch

Shown with Hampton 400 lever on SR backplate

PATINA	ESCUTCHEON	LEVER	FUNCTION	HANDING
BZ Dark Bronze	select from table below	select from pages 11-16	36 Gate Passage	L LHR
WL White Bronze				R RHR
WM White Medium				
TC Matte Black				
NB Natural Bronze				

Handing including swing direction is critical when ordering gate hardware.

Drop bar is not designed to act as the sole closing device for a gate. The product is designed to be used with a gate stop or other hardware that stops the gate slightly before the drop bar connects with the strike. Should you require a gate stop, please see below.

Gate Hardware is available for doors between 1 3/8" to 3" thick in your choice of these escutcheons with any lever. Knobs not suitable for use with gate hardware.





				
SQ Rectangular 5 1/8" x 2 1/2"	SR Arched 7" x 2 1/2"	CV Curved 5 1/8" x 2 1/2"	MD Urban 5 1/8" x 2 1/2"	AG Angular 5 1/8" x 2 1/2"

PLATE	LEVER	PRICE
SQ		
SR	Any	
CV	Ashley	\$423
MD	Norton	
AG	Lever	

\$80 upcharge for hammered levers

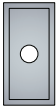

Standard Gate Stop

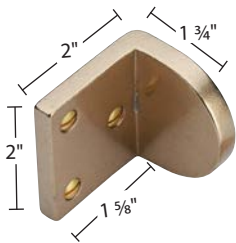
ITEM	SIZE	PRICE
3550.1 3/4	1 3/4"	\$76

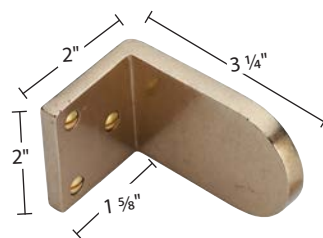

Extended Gate Stop

ITEM	SIZE	PRICE
3550.3 1/4	3 1/4"	\$119



Strike included with Gate stops

Hasp and Staple

ITEM	SIZE	PRICE
3540	5" x 1"	\$94



Drop Bar with Handle

ITEM	SIZE	PRICE
3520	7 1/8" x 3 3/4"	\$162

Hardware installed on single side of door
Must be used in conjunction with a gate stop.

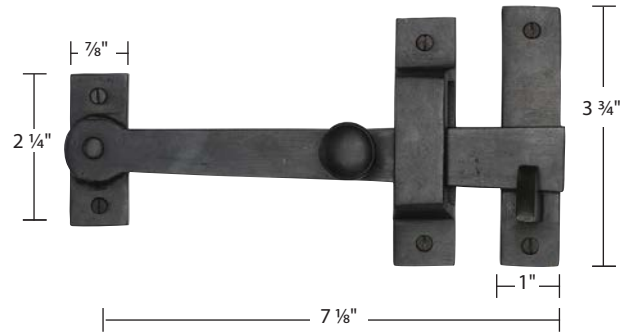

Ring Turn Drop Bar

ITEM	PRICE
3510.RH	\$488
3510.LH	\$488

Handing required.
Right hand pictured.
Must be used in conjunction with a gate stop.

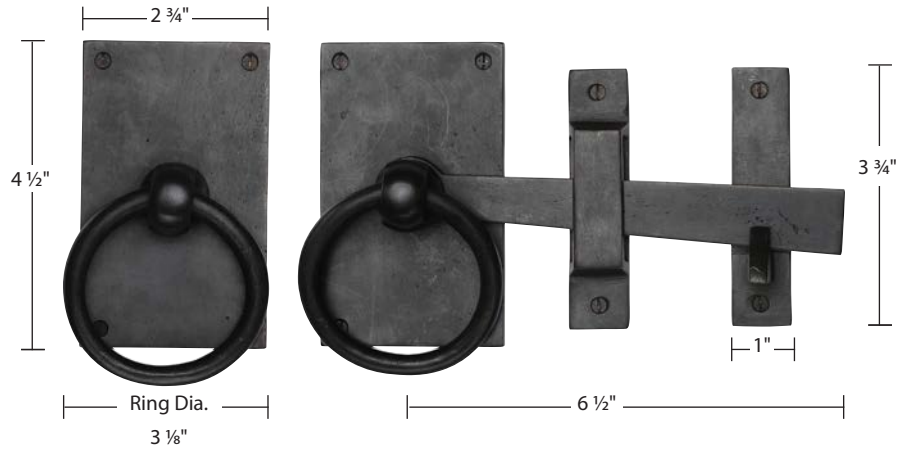

Dummy Ring on Plate (Single)

ITEM	SIZE	PRICE
3514	3 1/8" x 4 1/2"	\$198

Gate Latch

ITEM	PRICE
3530	\$525

Must be used in conjunction with a gate stop.
Maximum door thickness: 2 1/2"

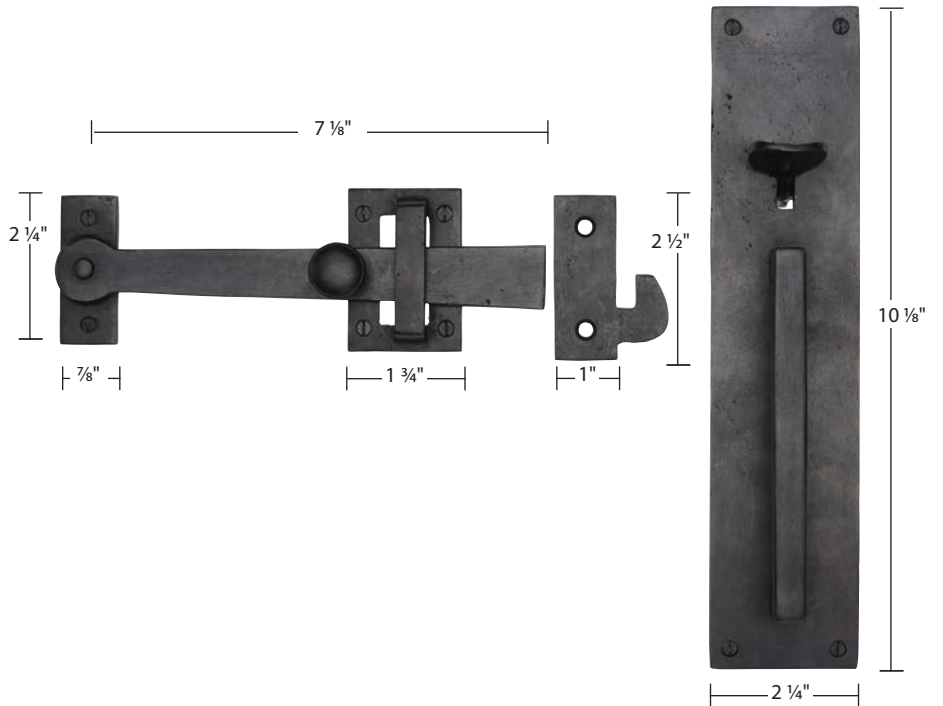

Pull Handle on Plate (dummy)

ITEM	SIZE	PRICE
3534	10 1/8" x 2 1/4"	\$358

SURFACE BOLTS AND CANE BOLT, HOOK & EYE

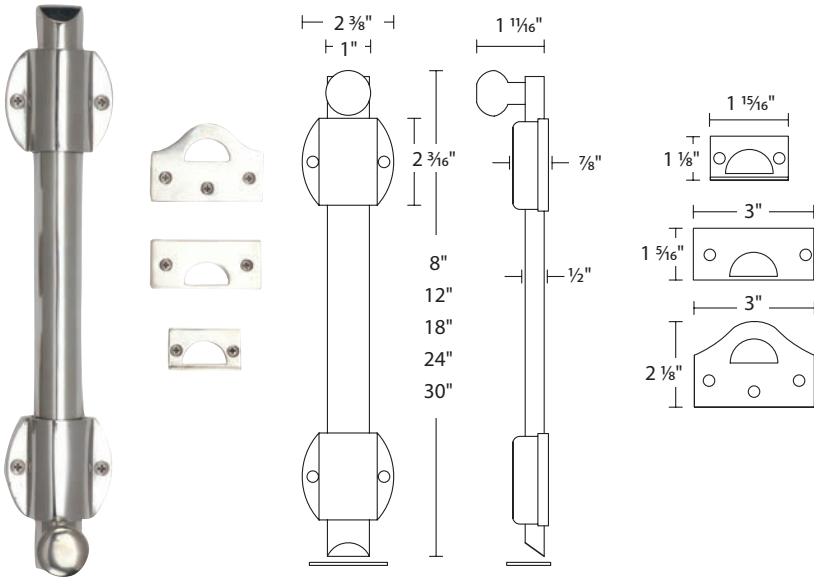

Surface Bolt

ITEM	SIZE	THROW	PRICE
1582 8	8"	1"	\$307
1582 12	12"	1"	\$335
1582 18	18"	1"	\$387
1582 24	24"	1"	\$416
1582 30	30"	1"	\$474

Two strike plates included

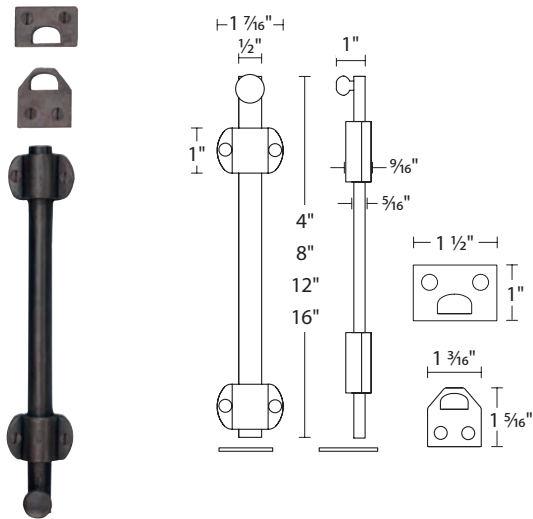

Mini Surface Bolt

ITEM	SIZE	THROW	PRICE
1571 4	4"	1"	\$217
1571 8	8"	1"	\$261
1571 12	12"	1"	\$296
1571 16	16"	1"	\$326

Two strike plates included

SURFACE BOLTS AND CANE BOLT, HOOK & EYE

Hook & Eye

ITEM	SIZE	BRACKET SIZE	PRICE
1530 6	6"	1 1/2" x 1 1/2"	\$115
1530 9	9"	1 1/2" x 1 1/2"	\$120



Cane Bolt

ITEM	SIZE	BRACKET	STRIKE	THROW	ROD DIA.	PRICE
1593 12	12"	2" x 2"	2 9/16" x 2"	2"	1/2"	\$300
1593 18	18"	2" x 2"	2 9/16" x 2"	2"	1/2"	\$330
1593 24	24"	2" x 2"	2 9/16" x 2"	2"	3/4"	\$370



WINDOW HARDWARE



Casement Stay

ITEM	ARM LENGTH	PRICE
990 13	12 ¾"	\$216.00



Sash Lift

ITEM	BASE	HEIGHT	PRICE
1110	2 ¼" x 1"	1 ¾"	\$37.00



Sash Lock

ITEM	WIDTH	PRICE
1120	2 ½"	\$83.00



Casement Fastener

ITEM	WIDTH	PRICE
129	2 x 1 1/8"	\$83.00



Casement Fastener

ITEM	WIDTH	PRICE
127	2 x 1 1/8"	\$83.00

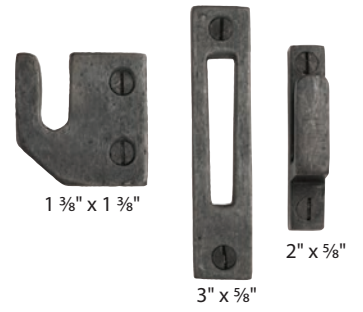

Three strike plate included with all casement fasteners



Casement Fastener*

ITEM	HANDLE LENGTH	BACKPLATE	PRICE
128	3 1/4"	2 1/8" x 1 1/8"	\$185.00

Handing required

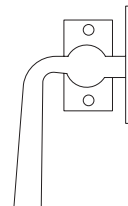

Right-hand window

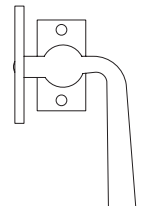

Left-hand window

*Photos depict handle for left-hand window, also available for right-hand window

SOLID BRASS HINGES

GENERAL INFORMATION

- Full mortise, plain bearing hinges manufactured from solid brass extrusions to current ANSI template specifications. Brass base ensures excellent strength and precision tolerance.
- There may be a slight variation in texture and color between the hinge and the Solid Bronze product
- Supplied as standard with button finials

TECHNICAL FEATURES

- Pin manufactured from grade 304 stainless steel to prevent corrosion
- Finials threaded into barrel of hinge to prevent pin from rising
- Hinges beveled on inside leaf to obtain tight fit when viewing in closed position
- Template screw hole location for use with wood doors and frames

ITEM NO.	DESCRIPTION	WT. / BOX	THICKNESS	SCREWS (INCLUDED)
HIN3535	3 1/2" x 3 1/2" Plain Bearing Hinge	1.4 lb	0.123"	6x #10 x 1" screws per hinge
HIN4040	4" x 4" Plain Bearing Hinge	1.8 lb	0.130"	8x #12 x 1 1/4" screws per hinge
HIN4545	4 1/2" x 4 1/2" Plain Bearing Hinge	2.1 lb	0.134"	8x #12 x 1 1/4" screws per hinge

ITEM NO.	DESCRIPTION		PRICE (BZ/NB/WL/WM)	PRICE (BLACK)
HIN3535	3 1/2" x 3 1/2" Plain Bearing Hinge	Each	\$64.00	\$54.00
HIN4040	4" x 4" Plain Bearing Hinge	Each	\$72.00	\$63.00
HIN4545	4 1/2" x 4 1/2" Plain Bearing Hinge	Each	\$79.50	\$70.00
HIN-F-BAL	Ball Finial	Pair	\$25.00	\$22.00
HIN-F-STP	Steeple Finial	Pair	\$25.00	\$22.00
HIN-F-KNL	Knurled Finial	Pair	\$30.00	\$25.00

REPLACEMENT PARTS	SCREW OR FINIAL	PART	PRICE
HIN-F-BUT	Button Finials	Pair	\$18.00
HIN-S-10W	#10 x 1" wood screw	Pack of 6	\$11.80
HIN-S-12W	#12 x 1 1/4" wood screw	Pack of 8	\$16.50
HIN-F-HPS	Hinge Stop	Single	\$40.00

NRP option available, \$16.00 list upcharge per hinge



Solid Brass Hinge - Distressed



Hinge Stop

ITEM	PRICE
HIN-F-HPS	\$40.00

Suitable for square and radius corner hinges

RADIUS CORNER HINGES

GENERAL INFORMATION

- Manufactured from solid brass extrusions, to allow for higher strength and tolerance
- There may be a slight variation in texture and color between the hinge and the Solid Bronze product
- Supplied with button finials
- Finials will not work with Radius Corner Hinges

TECHNICAL FEATURES

- 3 1/2" x 3 1/2" and 4" x 4" residential duty hinges with 3/32" (0.094") thickness
- Available with 1/4" and 5/8" radius corners
- Supplied with #10 x 1" screws
- 4" x 4" hinges feature zig-zag screw pattern
- Removable pin made from grade 304 stainless steel to resist corrosion

ITEM	SIZE	CORNER	THICKNESS	PRICE (BZ/NB/WL/WM)	PRICE (BLACK)
HNR.3514	3 1/2" x 3 1/2"	1/4" radius	0.094"	\$45.00 each	\$38.00 each
HNR.3558	3 1/2" x 3 1/2"	5/8" radius	0.094"	\$45.00 each	\$38.00 each
HNR.4014	4" x 4"	1/4" radius	0.094"	\$49.50 each	\$42.00 each
HNR.4058	4" x 4"	5/8" radius	0.094"	\$49.50 each	\$42.00 each

NRP option not offered with radius corner hinges



HNR.3514 - 3 1/2" x 3 1/2" with 1/4" radius



HNR.3558 - 3 1/2" x 3 1/2" with 5/8" radius



HNR.4014 - 4" x 4" with 1/4" radius



HNR.4058 - 4" x 4" with 5/8" radius



DOOR STOPS



Baseboard Door Stop

ITEM	SIZE	PRICE
130	1 1/2" length	\$44.00
131	3" length	\$48.00
132	4" length	\$56.00



Cylindrical Stop

ITEM	HEIGHT	DIA. EXCL RING	RING HEIGHT	PRICE
136 1 1/2	1 1/2"	1 1/8"	3/4"	\$62.00
136 2	2"	1 1/8"	1 1/4"	\$72.00
136 4	4"	1 1/8"	3 1/4"	\$102.00



Half Button Door Stop

ITEM	OVERALL HEIGHT	HIGH BASE PLATE	PRICE
1082	1 1/4"	1 1/4"	\$56.00



Half Button Door Stop

ITEM	OVERALL HEIGHT	LOW BASE PLATE	PRICE
1080	1 1/8"	1 1/8"	\$53.00



Door Stop with holder

ITEM	BASE DIA.	HEIGHT	HOOK LENGTH	PRICE
133	2 1/2"	3 7/8"	2 1/2"	\$145.00



Floor Mounted Door Stop

ITEM	SIZE	PRICE
1089	1 1/8" x 1 1/8"	\$62.00



Square Wall Mounted Door Stop

ITEM	SIZE	PRICE
137	3"	\$52.00



Goose Neck Door Stop

ITEM	SIZE	PRICE
134	2 1/2" x 2 1/2"	\$72.00



Magnetic Door Holder

ITEM	SIZE	PRICE
1085	3" x 3 1/8"	\$144.00

PULL HANDLES



Offset Pull

ITEM	SIZE	PROJ.	PRICE
1150	12 3/8" x 2"	2 1/2"	\$270

For Back-to-Back application, order two pulls (surface mounted)



Pull Handle

ITEM	SIZE	PROJ.	PRICE
1155	15" x 2 3/8"	2 3/8"	\$391

For Back-to-Back application, order two pulls (surface mounted)



Rectangular



Arched



Curved



Urban



Angular

SUITE	ITEM	SIZE	PRICE	ITEM	SIZE	PRICE
Rectangular	SQ.E.13	13" x 3"		SQ.E.18	18 1/8" x 3"	
Arched	SP.E.13	13" x 3"		SP.E.18	18 1/8" x 3"	
Curved	CV.E.13	13" x 3"	\$250	CV.E.18	18 1/8" x 3"	\$380
Urban	MD.E.13	13" x 3"		MD.E.18	18 1/8" x 3"	
Angular	AG.E.11	11" x 2 1/2"		AG.E.18	18 1/8" x 3"	



Rectangular



Arched



Curved



Urban



Angular

SUITE	ITEM	SIZE	PRICE
Rectangular	SQ.G.18	18 1/2" x 3"	
Arched	SP.G.18	18 1/2" x 3"	
Curved	CV.G.18	18 1/2" x 3"	\$750
Urban	MD.G.18	18 1/2" x 3"	
Angular	AG.G.18	18 1/2" x 3"	

BATHROOM ACCESSORIES

PATINA	ESCUTCHEON	ACCESSORY
BZ Dark Bronze	select from table below	125 Double Ended Paper Holder
WL White Bronze		145 Paper Holder
WM White Medium		100 Towel Ring
TC Matte Black		150 Towel Rail
NB Natural Bronze		410 Robe Hook

For example to order a Robe Hook with 5 1/8" x 2 1/2" (SQ) escutcheon in Natural Bronze (NB) patina, use:
NB.SQ.410

Hardware is available with your choice of the following escutcheons:

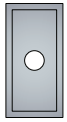

SQ

Rectangular Plate
5 1/8" x 2 1/2"



CV

Curved Plate
5 1/8" x 2 1/2"

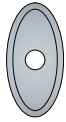

OV

Oval Plate
5 1/8" x 2 1/2"



AR

Small Arched Plate
4 1/4" x 2 3/8"



AG

Angular Plate
5 1/8" x 2 1/2"



AS

Angular Rose
2 1/2" x 2 1/2"



RR

Round Rose
2 3/4" dia



MS

Urban Rose
2 1/2" x 2 1/2"



MR

Urban Plate
3 1/2" x 2 1/2"



MD

Urban Plate
5 1/8" x 2 1/2"



Towel Rail

ITEM	9" PRICE	18" PRICE	24" PRICE	30" PRICE
SQ.150				
CV.150				
MD.150				
OV.150	\$280	\$310	\$342	\$376
AG.150				
MR.150				
AR.150				
MS.150				
AS.150	\$255	\$274	\$292	\$310
RR.150				



Towel Ring

ITEM	PRICE
SQ.100	
CV.100	
MD.100	
OV.100	\$234
AG.100	
MR.100	
AR.100	
MS.100	
AS.100	\$218
RR.100	

Ring Dia. 6 1/2"



Single Ended Toilet Paper Holder

ITEM	PRICE
SQ.145	
CV.145	
MD.145	
OV.145	\$176
AG.145	
MR.145	
AR.145	
MS.145	
AS.145	\$160
RR.145	

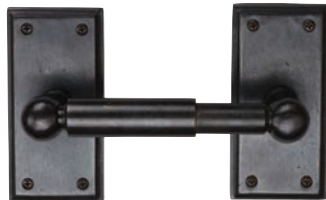

Double Ended Toilet Paper Holder

ITEM	PRICE
SQ.125	
CV.125	
MD.125	
OV.125	\$252
AG.125	
MR.125	
AR.125	
MS.125	
AS.125	\$240
RR.125	



Robe Hook

ITEM	PRICE
SQ.410	
CV.410	
MD.410	
OV.410	\$160
AG.410	
MR.410	
AR.410	
MS.410	
AS.410	\$128
RR.410	

BATHROOM ACCESSORIES



Single Ended TP Holder

ITEM	LENGTH	PROJ.	PRICE
175	6 1/8"	3 5/8"	\$172



Robe Hook

ITEM	BASE DIA.	PROJ.	PRICE
178	1 1/2"	2 3/8"	\$82

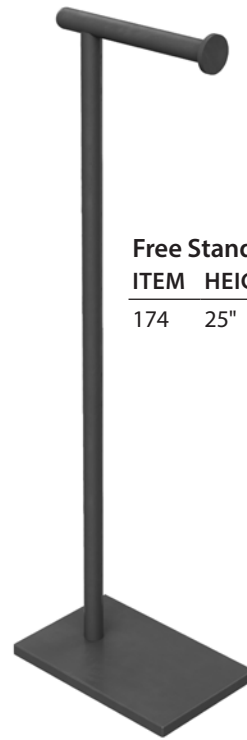

Free Standing Toilet Paper Holder

ITEM	HEIGHT	WIDTH.	PRICE
174	25"	7 7/8"	\$540



Towel Rail

ITEM	SIZE	BASE DIA.	PROJ.	PRICE
176 9	9"	1 1/2"	2 1/2"	\$260
176 18	18"	1 1/2"	2 1/2"	\$280
176 24	24"	1 1/2"	2 1/2"	\$300
176 30	30"	1 1/2"	2 1/2"	\$324

BATHROOM ACCESSORIES



Shelf Toilet Paper Holder

ITEM	LENGTH	PROJ.	PRICE
179	5 7/8"	5"	\$324



8" Curved Shelf Bracket

ITEM	WIDTH	LENGTH	PROJ.	PRICE
514	3/4"	9 1/2"	7 5/8"	\$160

Sold individually



HOOKS



Single Hook

ITEM	SIZE	PROJ.	PRICE
387	1 1/8" x 1 3/4"	2 5/8"	\$50.00



Double Hook

ITEM	SIZE	PROJ.	PRICE
386	2 3/4" x 1 3/8"	1 1/2"	\$62.70



Utility Double Hook

ITEM	SIZE	PROJ.	PRICE
407	2" x 1 1/8"	3 1/4"	\$73.00



Flat J Hook

ITEM	SIZE	PROJ.	PRICE
408	2 3/8" x 1"	2"	\$57.60

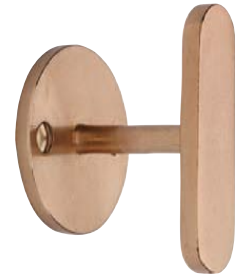

Camilla Hook

ITEM	WIDTH	DIA. ROSE	PROJ.	PRICE
413	2 3/4"	2"	1 1/2"	\$68.70



Rivet Hook

ITEM	DIA. FRONT	PROJ.	PRICE
423	1 1/8"	2 1/8"	\$50.00



Ox Hook

ITEM	SIZE	PROJ.	PRICE
422	2 5/8" x 2 3/4"	3/4"	\$56.80



Whale Hook

ITEM	WIDTH	DIA. ROSE	PROJ.	PRICE
421	2 1/2"	2"	2 3/8"	\$68.70



J Hook

ITEM	SIZE	PROJ.	PRICE
417	3 1/8" x 5/8"	1 5/8"	\$52.00



Peg Hook with Plate

ITEM	PLATE SIZE	PROJ.	PRICE
419	4" x 1 1/2"	2"	\$85.40



Curved Hook

ITEM	SIZE	PROJ.	PRICE
404	4 5/8" x 1 3/8"	3 3/4"	\$73.00



Angular Hook

ITEM	SIZE	PROJ.	PRICE
389	5" x 1/2"	1 3/4"	\$61.60



Double Twist Hook

ITEM	SIZE	PROJ.	PRICE
400	5 3/4" x 1 5/8"	3 1/4"	\$73.00



Coat & Hat Hook

ITEM	SIZE	PROJ.	PRICE
406	5 1/8" x 1 1/4"	1 7/8"	\$73.00



Double Flat J Hook

ITEM	SIZE	PROJ.	PRICE
409	5 1/8" x 1"	3 1/4"	\$85.40



4" Plated Hook

ITEM	PLATE SIZE	PROJ.	PRICE
427	4" x 1 1/8"	1 1/8"	\$102.00



Scroll Hook

ITEM	SIZE	PROJ.	PRICE
405	6 1/4" x 1/2"	2 1/2"	\$78.00

HOOKS

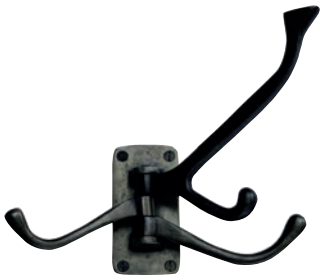

Triple Hook

ITEM	SIZE	PROJ.	PRICE
397	3 1/4" x 1 5/8"	5 3/4"	\$108.00



Cleat Hook

ITEM	SIZE	PROJ.	PRICE
414	5 3/4" x 1"	1 1/2"	\$80.50



8" Plated Hook

ITEM	SIZE	PROJ.	PRICE
428	8" x 1 1/8"	1 1/8"	\$150.00



Line and Dot Hook

ITEM	SIZE	PROJ.	PRICE
420	1 1/2" x 8 1/4"	2 1/8"	\$85.30



Oversized Traditional Hook

ITEM	SIZE	PROJ.	PRICE
424	2 3/4" x 7"	4"	\$105.00



Large Lion Knocker

ITEM	DIA.	PRICE
1225	8"	\$764

Thru Bolted



Small Lion Knocker

ITEM	SIZE	PRICE
1220	3 7/8" x 6 3/4"	\$286

Thru Bolted



Circular Knocker

ITEM	ESCUTCHEON DIA.	RING DIA.	PRICE
1275	1 3/4"	7"	\$344

Surface Mounted

HOUSE NUMBERS



6" Traditional Numerals

ITEM	SIZE	PRICE
156 1		
156 2		
156 3		
156 4		
156 5	6"	\$60.00
156 6		
156 7		
156 8		
156 9		
156 0		

Concealed mount



6" Contemporary Numerals

ITEM	SIZE	PRICE
166 1		
166 2		
166 3		
166 4		
166 5	6"	\$64.00
166 6		
166 7		
166 8		
166 9		
166 0		

Surface mounted

7" Modern Numerals

ITEM	LENGTH	WIDTH	PRICE
168 1	7 ¼"	2 ½"	
168 2	7 ¼"	5"	
168 3	7 ¼"	5 ¼"	
168 4	7 ¼"	5 ½"	
168 5	7 ¼"	5 ¼"	\$96.00
168 6	7 ¼"	5 ¼"	
168 7	7 ¼"	4 ⅝"	
168 8	7 ¼"	5"	
168 9	7 ¼"	5 ¼"	
168 0	7 ¼"	5 ¾"	

Floating or Flush Mount



BELL BUTTONS, CLAVOS AND STRAP HINGES



RD1184

DIA.	PRICE
2 1/2"	\$76.00
Supplied with illuminated button	



SQNE1180

SIZE	PRICE
4 1/2" x 1 1/2"	\$76.00
Supplied with illuminated button	



MDNE1189

SIZE	PRICE
4 1/2" x 1 1/2"	\$76.00
Supplied with illuminated button	



Strap Hinge

ITEM	SIZE	A	B	PRICE
412 23	22 7/8"	3 15/16"	2 3/8"	\$295.00



ITEM	SIZE	PRICE
121 1	1"	\$25.00
121 1 1/2"	1 1/2"	\$31.00

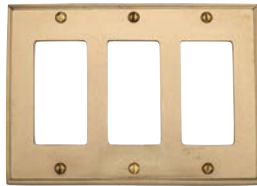

SQ.DSC

DECORA COVER	SIZE	ITEM	PRICE
single gang	2 7/8" x 4 1/16"	SQ.DSC 1	\$45.00
double gang	4 1/16" x 4 1/16"	SQ.DSC 2	\$65.00
triple gang	6 1/2" x 4 1/16"	SQ.DSC 3	\$72.00
quad gang	8 7/16" x 4 1/16"	SQ.DSC 4	\$131.00



SQ.SC

TOGGLE SWITCH COVER	SIZE	ITEM	PRICE
single gang	2 7/8" x 4 1/16"	SQ.SC 1	\$45.00
double gang	4 1/16" x 4 1/16"	SQ.SC 2	\$65.00
triple gang	6 1/2" x 4 1/16"	SQ.SC 3	\$72.00
quad gang	8 7/16" x 4 1/16"	SQ.SC 4	\$131.00



SQ.OC1

DECORA COVER	SIZE	ITEM	PRICE
duplex	2 7/8" x 4 1/16"	SQ.OC 1	\$45.00



SQ.BP

BLANK COVER	SIZE	ITEM	PRICE
single	2 7/8" x 4 1/16"	SQ.BP 1	\$45.00
double	4 1/16" x 4 1/16"	SQ.BP 2	\$65.00



210 West Parkway Suite 1
Pompton Plains, NJ 07444
United States
Tel: (973) 835 4027
ashleynorton.com