



HYDRO SYSTEMS

TRANSFORMING THE BATH THROUGH THE
POWER OF WATER SINCE 1978

IF YOU CAN DREAM IT, WE CAN BUILD IT

- Hydro Systems, a third-generation family-run business founded in 1978
- From its humble beginnings in a Van Nuys garage to a preeminent tub manufacturer in 2025
- Bi-coastal state-of-the-art manufacturing facilities in Valencia, California and Atlanta, Georgia
- All products are 100% entirely Made in the USA



WELLNESS IN THE BATH

Innovative Design Meets Customized Wellness

- From colors and sizing to hydrotherapy options, Hydro Systems can personalize one's vision of wellness with bespoke, made-to-order tubs
- Hydro Systems is the only tub manufacturer to integrate its hydrotherapy options into a free-standing tub



THE "YES" COMPANY

Endless Choices, Customized Solutions

- Specify any size, shape, material, color, drain location or hydrotherapy option for your project

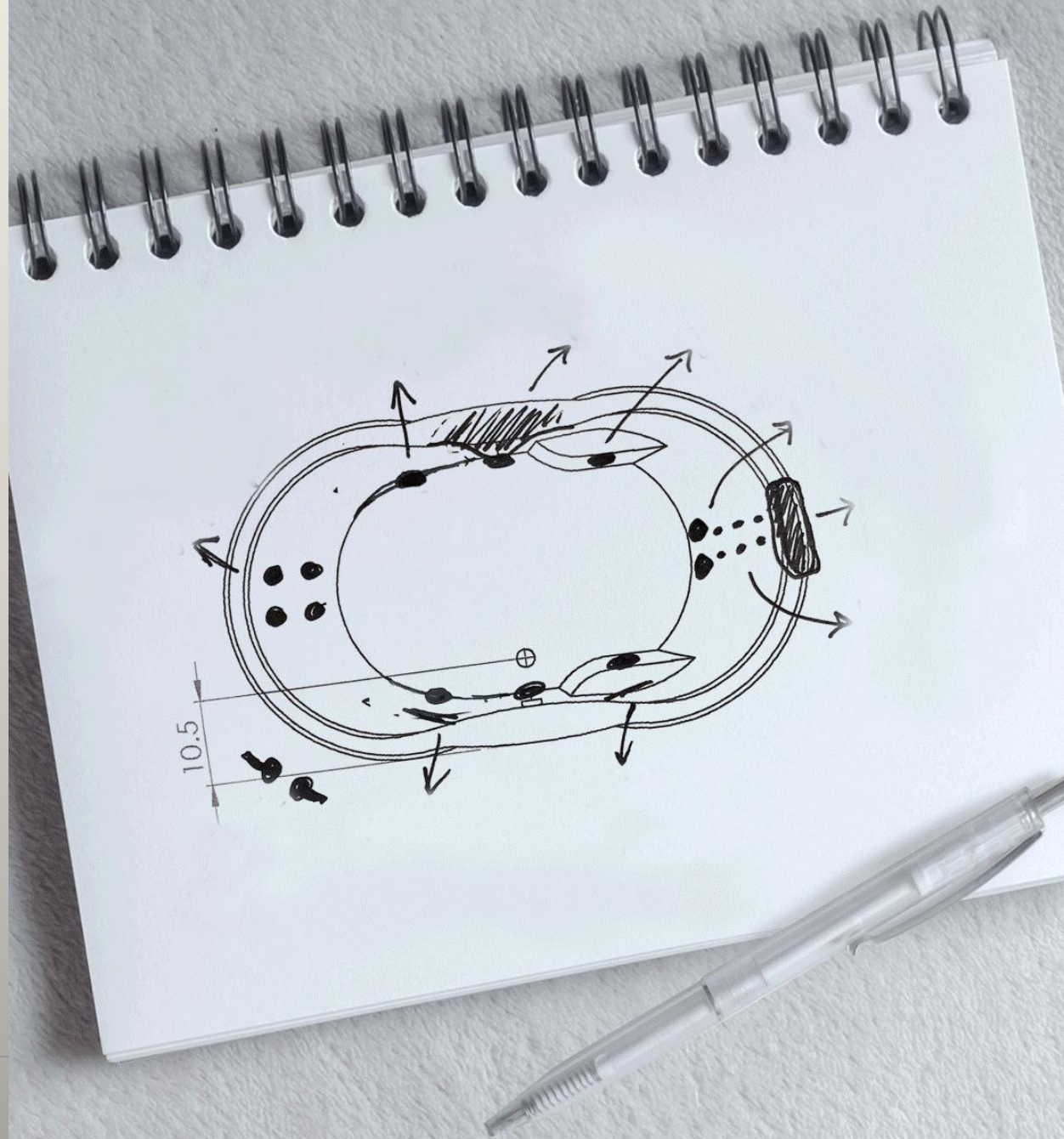

ROBOTICS & INNOVATION

Robotics Meet Hand Craftsmanship

- With state-of-the-art robotics in both California and Georgia, Hydro Systems has streamlined our manufacturing
- The efficiency has allowed our production team to focus on the systems installation without compromising the hand-detailing and hand-finishing of our tubs while helping shorten lead times so projects stay on budget



ANSON FREESTANDING TUB

Metro Collection

66"L x 35"W x 24"D

Solid Surface Freestanding Bathtub

NEW!



PICASSO WHIRLPOOL TUB

Designer Collection

72"L x 40"W x 27"D

Seamless Acrylic Freestanding Bathtub

Fully integrated whirlpool system concealed within the skirt and a unique flush access panel located behind the ergonomic backrest, making it visually unobtrusive without interruption of the tub's sculptural silhouette



HYDROFILL

Designed as an alternative to traditional tub fillers

- Includes factory installed check valve
- Connect water supply line to ¾" check valve on tub
- Fill rate up to 20 gpm
(Estimated water Flow is going to be per faucet used and water pressure at each household).
- Requires a custom located inlet for filling tub
Must specify location on tub for inlet
- Factory installed for onsite connection to incoming water supply
- Single port fill for soaker tubs
- Whirlpool tub jets used for optional filling



HYDROFILL

- A. Roman Tub less spout for cleaner minimal look /optional to use Volume Control Valves for Deck or Wall Mount
- B. Water inlet connection Dual Check Valve per Code $\frac{3}{4}$ "IPS pipe thread to connect to copper, cpvc, or pex
- C. HydroFill port

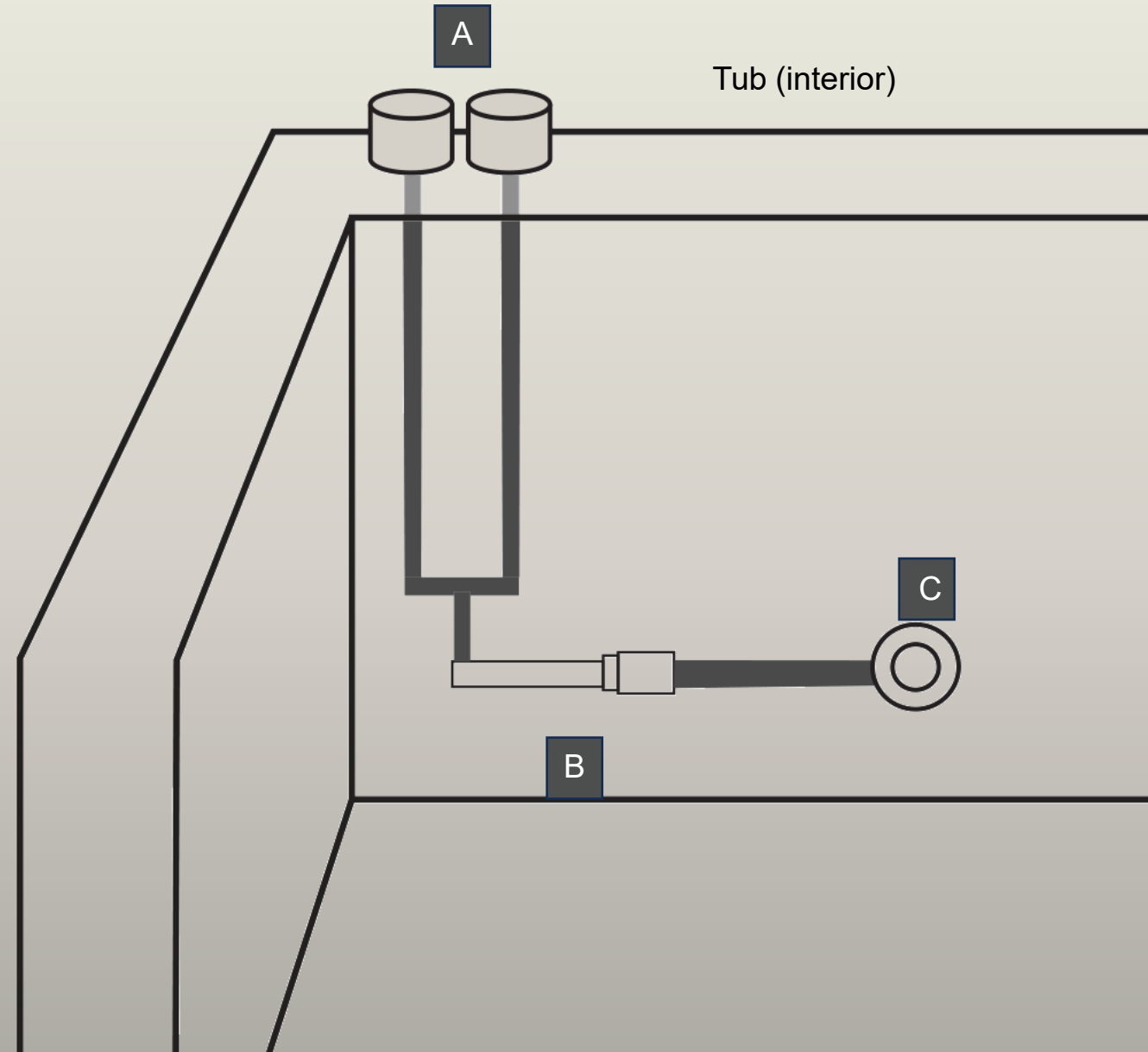

COLD PLUNGE

Essential Amenity for the Home Spa

- Cold Plunge, by Hydro Systems is a new cold hydrotherapy system that is available on virtually any Hydro Systems bathtubs
- Cold water therapy is the practice of soaking in water that is 59°F (15°C) or less
- Benefits of this state-of-the-art spa and wellness experience are known to include:
 - Reduced pain and inflammation
 - Faster post-workout muscle and joint recovery

Other possible benefits include:

- Strengthening of the immune system
- Enhanced mindfulness
- Improved blood circulation



**COLD
PLUNGE**

Available on **ALL**
Freestanding, Drop-in
Alcove Tubs

COLD PLUNGE

HYDRO SYSTEMS Cold Plunge has been recognized by industry professionals in the bathroom and wellness category

- Available on **ANY** Hydro Systems' bathtub
- Can be included with other tub options
- UV and Ozone sanitized fresh water
- No Chemicals
- Pre-program for on-demand use
- Control temperature down to 40 degrees F
- Option to add a Custom Tower to hide piping and wires



2024 Product Award Winner



COLD PLUNGE

Chiller Unit

- Power on to program unit
- Set desired temperature to the exact degree
- Keypad with control box
- 110 v, 20amps
- Cools water down at an average rate of 4-6 degrees per hour until reaching desired or programmed temperature
- System stays on until you turn it off
- Integrated Ozone UV light sanitizes water throughout each use
- Water can stay in tub for 3-5 days

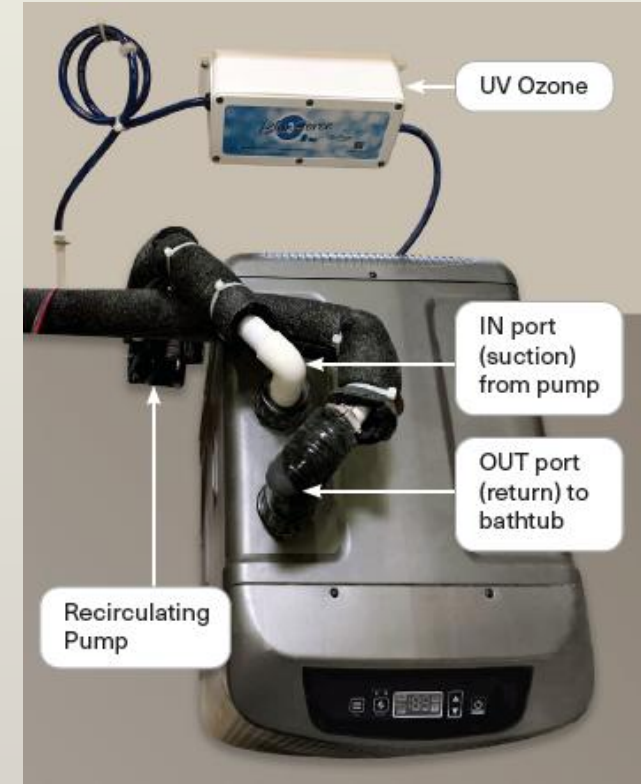



HYDRO
SYSTEMS

1 SUCTION

Creates smooth, soft, light water
circulation movement

1 JET

**Integrated UV Ozone
sanitizes water while
system is running**

INSTALLING COLD PLUNGE

- Insulated pipes are recommended
- Chiller Unit is 21" x 15" x 26"
- Enclosure needs to be 30" x 30" x 30" for adequate ventilation
- If installing Chiller outside, build enclosure to cover unit from weather
- A tray underneath the Chiller is recommended
- Make sure Chiller Unit is properly ventilated
 - Omits about 100' temperature in heat
 - Similar sound like portable AC unit
- Recirculating Pump
MUST BE LEVEL WITH SUCTION ON TUB



Chiller unit placed next to tub with access panel located behind wall

INSTALLING COLD PLUNGE

- Insulated pipes are recommended
- Chiller Unit is 21" x 15" x 26"
- Enclosure needs to be 30" x 30" x 30" for adequate ventilation
- If installing Chiller outside, build enclosure to cover unit from weather
- A tray underneath the Chiller is recommended
- Make sure Chiller Unit is properly ventilated
 - Omits about 100' temperature in heat
 - Similar sound like portable AC unit
- Recirculating Pump
MUST BE LEVEL WITH SUCTION ON TUB



SPECIFYING COLD PLUNGE

- Order form available for specifying Cold Plunge
- No standard location, must specify jet & suction on tub
- Suggested Layouts: Minimum of 3 ft. and no further than 8 ft. from tub
- Level with bathtub
- Positioning Right, Left or Center

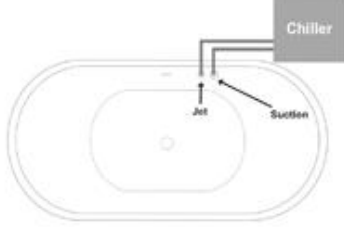
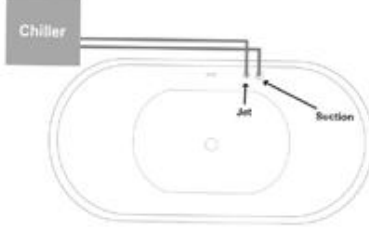
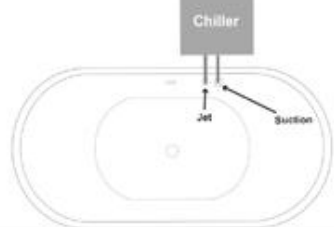
Hydro Systems Cold Plunge System Installation Form		Technical Support support@hydrosystem.com Phone: 861-775-0688 www.hydrosystem.com
<p>Before placing order, consider the following:</p> <ul style="list-style-type: none"> • Determine Chiller Unit placement • Chiller must be within 8 ft of tub • Chiller cannot fit within a Hydro Systems Tower • A tower can help to conceal exposed plumbing • Chiller must be placed within a location that allows for proper ventilation 		<p>BACKSIDE OF TUB</p>  <p>Inlet/Outlet</p> <p>Position of chiller unit will determine inlet/outlet direction</p>
<p>Select position of Chiller Unit:</p> <div style="display: flex; justify-content: space-around;"> <div style="width: 30%;"> <p><input type="checkbox"/> Is the chiller unit to the RIGHT side of the bathtub?</p>  </div> <div style="width: 30%;"> <p><input type="checkbox"/> Is the chiller unit to the LEFT side of the bathtub?</p>  </div> <div style="width: 30%;"> <p><input type="checkbox"/> Is the chiller unit DIRECTLY BEHIND the bathtub?</p>  </div> </div>		
<p>Add the following:</p> <ul style="list-style-type: none"> • Drain position • Overflow position • Suction position • Jet position • Tower (must specify size & location on tub) • L" ___ W" ___ H" ___ 		<p>Dealer Contact</p> <p>Purchase Order _____</p> <p>Date _____</p> <p>Company _____</p> <p>Contact _____</p> <p>Email _____</p> <p>Phone _____</p>
<p>INTERNAL USE</p> <p>Reviewed by _____ Date _____</p> <p>Approved by _____ Date _____</p>		<p>Notes</p> <p>_____</p>
<p>Email completed for to: support@hydrosystem.com</p>		

HYDRO INDULGE

Infuses water with millions of "micro bubbles" (oxygen-rich air molecules)

- Available on virtually any Hydro Systems bathtub
- Micro bubbles: bubbles are 10 microns in diameter – smaller than the pores on your skin
- 20 minutes of daily use offers the following benefits:
 - Helps to exfoliate, cleanse, heal and restore skin
 - May help to improve collagen production, and reduce fine lines/wrinkles
 - May help to improve mood
 - May help to improve skin conditions such as eczema and psoriasis



HYDRO FUSION

Stay warmer longer. No more re-filling or running out of warm water.

- Available on any Hydro Systems bathtub
- Maintains desired water temperature without having to add hot water to the bathtub
- Intuitive, intelligent system monitors and maintains bathwater temperature set by user
- Silently circulates water through a specialized heating pump
- Independent of other tub systems, Hydro Fusion operates with minimal water movement



SPECIFYING HYDRO FUSION OR INDULGE

- Order form available for specifying Hydro Fusion or Hydro Indulge on Freestanding Tubs
- No standard location, must specify jet & suction on tub
- Positioning Right, Left or Center

Hydro Systems Hydro Fusion or Indulge | Installation Form

Technical Support
 support@hydrosystem.com
 Phone: 661-775-0686
 www.hydrosystem.com

Before placing order, consider the following:

- Determine Hydro Fusion or Indulge unit placement
- Both units can fit in a Hydro Systems Tower
- A tower can help to conceal exposed plumbing

Backside tub shown:
Position of unit will determine inlet/outlet direction



Inlet

Outlet

System Dimensions

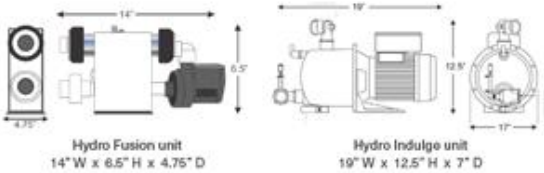

Hydro Fusion unit
14" W x 6.5" H x 4.75" D



Hydro Indulge unit
19" W x 12.5" H x 7" D

Select position of Hydro Fusion or Indulge Unit:

Is the unit to the **RIGHT** side of the bathtub?

Is the unit to the **LEFT** side of the bathtub?

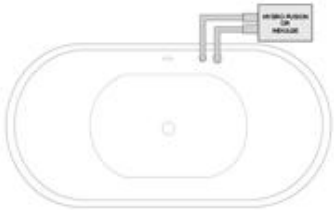
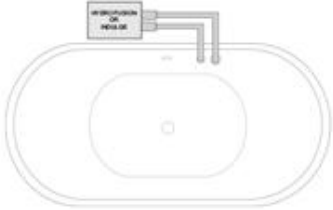
Is the unit **DIRECTLY BEHIND** the bathtub?

Add the following:

- Drain position
- Overflow position
- Inlet position
- Outlet position
- Tower (must specify size & location on tub)

• L" ___ W" ___ H" ___

INTERNAL USE

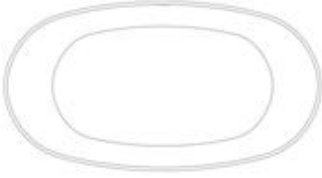
Reviewed by _____ Date _____

Approved by _____ Date _____

Notes

Dealer Contact

Purchase Order _____

Date _____

Company _____

Contact _____

Email _____

Phone _____

Customer Signature

Signature _____

Print name _____

Email completed for to: support@hydrosystem.com

FUSION/ INDULGE INSTALLATION

- Installation of Fusion and Indulge creates exposed plumbing
- Behind walls and built-in tub surrounds with access panels







CHROMATHERAPY LED-LIGHTING

Digitally controlled LED light
bulbs integrated inside the bathtub

Multi-colored rotating or fixed lighting
6 colors include blue, green, red,
orange, purple, violet and white light
Comes standard with two offset lenses
for wider color coverage



MICROMOUNT

Reduces the standard edge profile of the tub to a nominal 1/2"

- Available on all drop-in tubs without a decorative edge
- Makes for an easier transition in and out of the tub
- Sleek, minimalist look
- Highly recommended on all eligible drop-in models

MicroMount



LINEAR OVERFLOW

Seamless design, built-in protection

- Easier installation
- Reducing a possible leak point
- Additional soaking depth



HYDRO BLANKET

Integrated radiant heat panels take the chill off the bath shell

- Panels not visible from the interior of the tub
- Each blanket "zone" overlays a low-voltage panel, approximately 20" x 20" in size
- Available in up to 5 zones
- Hardwired with an on/off control independent from all other controls
- Does not heat up or maintain bathwater temperature

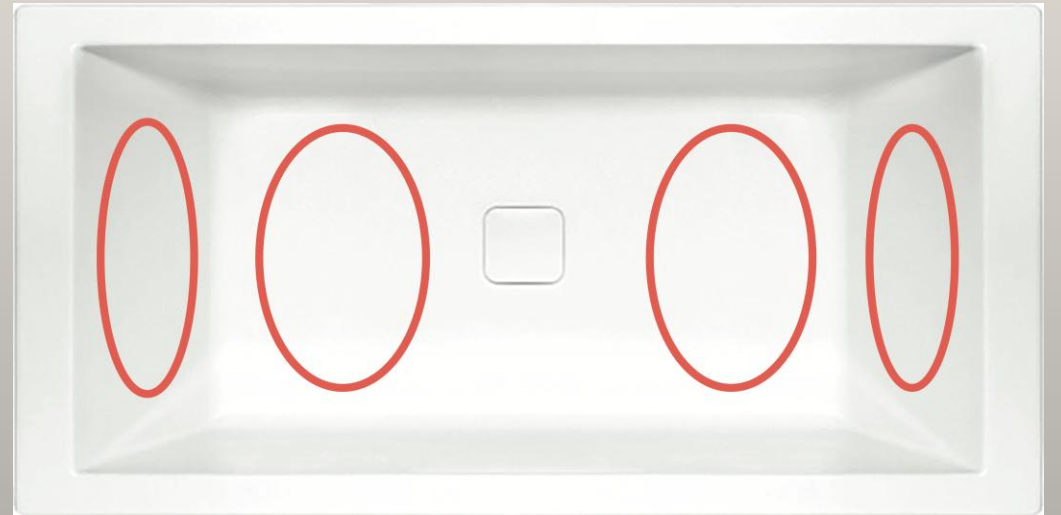
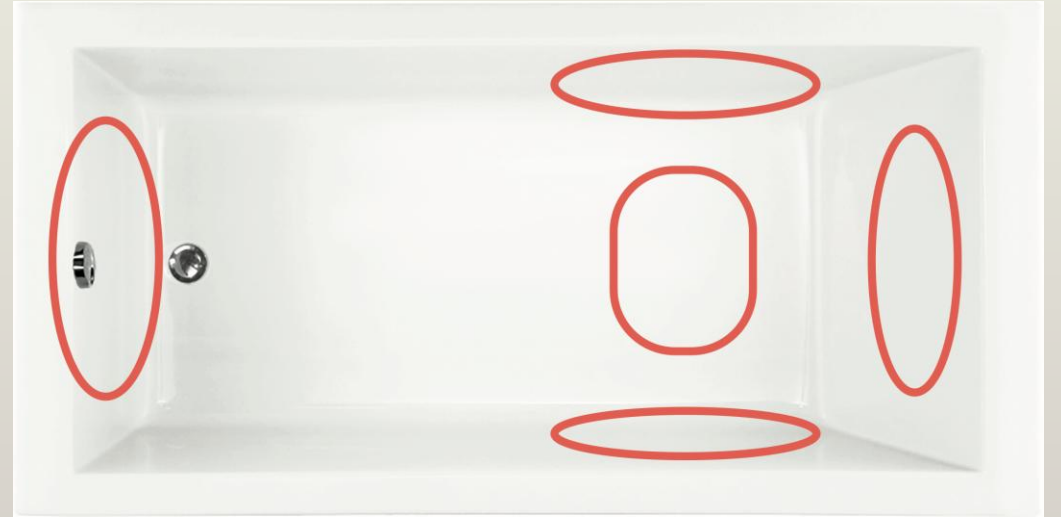

HYDROZONE

Natural ozone sanitizes bath water while the system is operating

- Standard on all Designer, Metro, and STON tubs with a system
- Ozone is a **NATURAL** compound that reverts to oxygen when its work is done, leaving no by-products in the water
- Ozone is **SAFE** and **EFFECTIVE**, made naturally from oxygen. 200 times stronger than bleach
- Operates **MAINTENANCE FREE** for over 9,000 one-hour bathing sessions



NOT YOUR GRANDMAS WHIRLPOOL SYSTEM

All Hydro Systems jetted tubs are made from rigid PVC pipe, it allows water to drain itself out, creating a clean system

Plumbed at a natural slope, so after each use, gravity will point all water to the low points to escape from and not sit within the system for an undetermined length of time



Competitors use flex hose, which allows water to sit in line

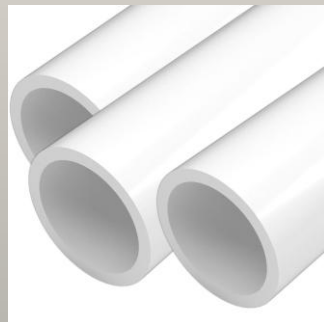

Hydro Systems only uses rigid PVC creating a clean system



WHIRLPOOL JETS

- Ability to custom locate, upgrade, change, or add additional jets to your system (not available on Studio)
- Standard whirlpool jet is directionally and volume adjustable.
- Ability to upgrade to swirling jets
- Add micro therapy jets for hard to reach locations such as armrests



THERMAL AIR

Therapeutic massage from head to toe

- Holes spaced 2” apart (most competitors 3” apart)
- Smaller holes allow bubbles to reach the middle of the tub for a more aggressive therapy
- All thermal air tubs purge after each use, leaving no water in the lines.
- Heated backrest included on Designer Tubs
- Variable speed blower with 6 speeds/3 modes
 - Blowing
 - Pulse
 - Wave mode that goes up and down with intensity





JET SYSTEM

Therapeutic jets for massage akin to deep tissue massage

Powerful massaging jets provide a deep, invigorating massage to relax tight muscles, rejuvenate muscular tissue and release your body's natural painkillers



THERMAL AIR

Tiny bubbles akin to an effervescent massage

Thousands of tiny bubbles engulf the body in a warm, soothing, therapeutic massage from the top of your neck to the soles of your feet

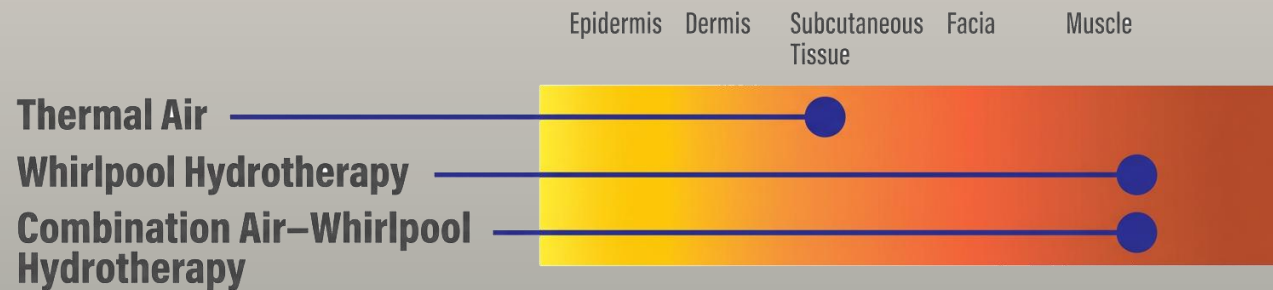

NECK AND BACK MASSAGE

Designed to promote increased flexibility

Neck Masseur



Hydro massaging, direct to the neck with 3 pulse settings

Manual Back Masseur



Allows control of water flow to the whirlpool system or the back massager and allows the blending of both.

Electronic Back Masseur



Utilizes six strategically located jets with electronically controlled systems that enable a “shiatsu” type massage.

CURATED COLORS



15 HydroLuxe SS
Premium Colors

TUB GUIDE

Improved organizational structure for specifying products

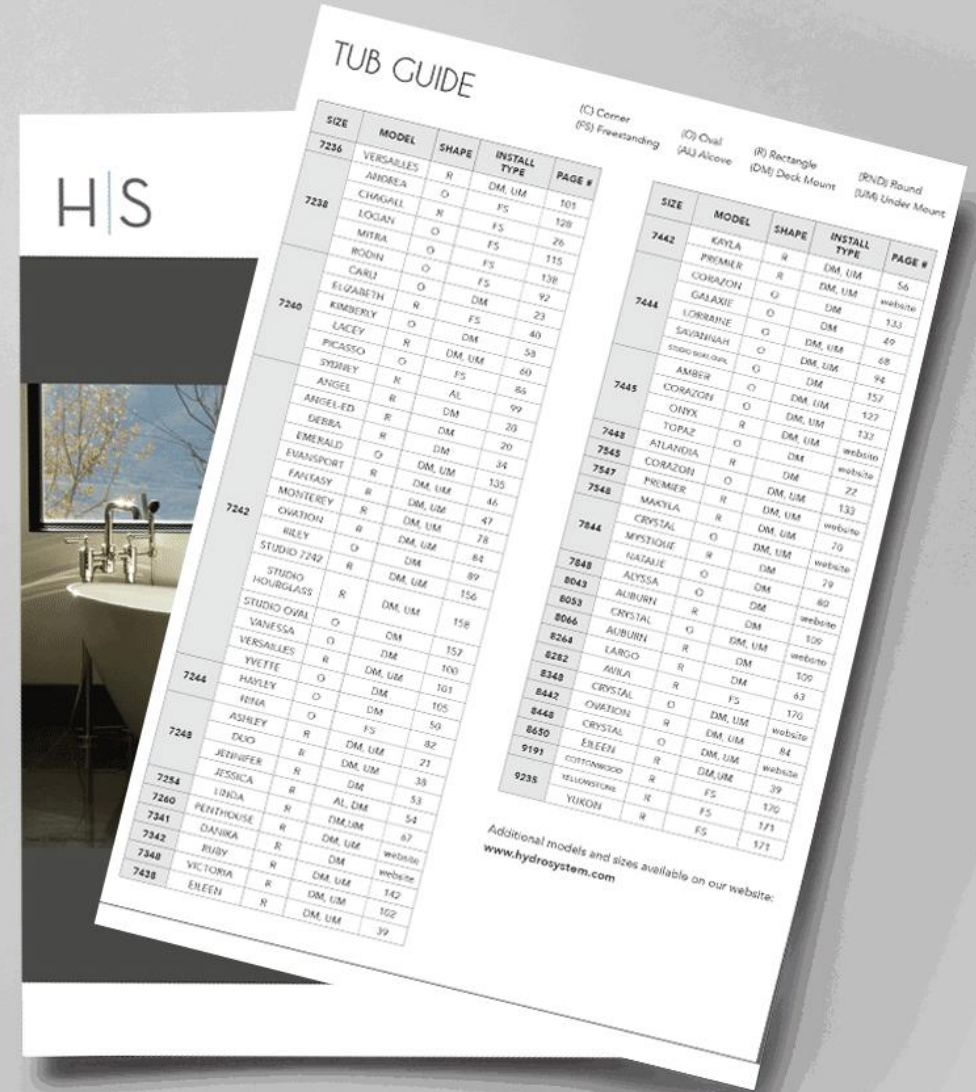

KEY REFERENCE OPTION

- Page 6 of Catalog
- Most Popular Tub Options
- Concise Definitions

KEY OPTION REFERENCE GUIDE

BACK MASSEUSE

Shiatsu Electronic or Manual diverter controlled, the 6-jet system allows you to sit back and have a back massage while in your tub.

CHROMATHERAPY

Utilizes different color light cycling throughout your bathing experience to help create changes in both your mental and physical well being.

COLD PLUNGE

Use the power of daily cold plunge and go beyond the traditional bathing experience and enjoy the benefits of cold water therapy. Ability to reduce bathing temperature to 39 degrees.

CUSTOM JET TYPE, QUANTITY & LOCATION

Pick and choose exactly how many jets you want, where you want them located, and what type of jet (standard, jumbo, therapeutic, swirling for any whirlpool tub).

CUSTOM PUMP/BLOWER LOCATION

Customize the location of the pump and/or blower (some restrictions apply), must include drawing.

HYDRO EXPRESS

Move your order up the front of the line to get it manufactured quicker. Does not change any additional freight costs.

HYDRO FILL

Integrated spout is factory-installed on an inside wall of the tub, allowing for alternate option from traditional filler spout for filling your tub. Available on all alcove/drop-in models.

HYDRO FUSION

A circulation heater that can be added to any drop-in tub. Designed to operate with virtually no water movement while offering an endless supply of warm soothing water to prolong the bathing experience.

HYDROZONE

Like bathing in bottled water. Introduces natural ozone to the water when you run the Hydrotherapy system which immediately sanitizes and cleanses the water.

INDULGE

Infuses water with millions of micro sized oxygen rich micro bubbles to help cleanse, heal, and restore skin. Improves collagen production that can help reduce wrinkles and even ease symptoms from several skin disorders.

INTEGRAL TILE FLANGE

Available on select non-oval tubs. Please specify which sides flange will need to be added to.

LINEAR DRAIN

Creates a sleek & stylish look while giving the bather one additional inch of soaking depth vs normal drain.

MICRO MOUNT

The micro mount reduces the standard edge profile of the tub to a nominal 1/2". Not available on tub models with edge detail.

MOLDED ARMREST

Choose 2 for eligible end drain and 2-4 for eligible center drain models.

NECK MASSEUSE PILLOW

Similar to the Back Masseuse, but for the neck, while you lay your head on a soft pillow. Choose 3 speeds depending on your needs.

SKIRTS

We can add as many skirts as you'd like to most rectangular drop-in tubs so that you can create your own style or make it fit any application. Seamed or seamless, the opportunities are endless – peninsula, corner, freestanding – if you can dream it, we can build it.

TOWER

Can be added to any of our freestanding bathtubs, allowing you to use traditional Roman tub faucets, hide select equipment, or exposed plumbing. Must specify size when ordering.

TUB FINISH

Choose to have your tub with a polished finish (standard) or matte, choose a combination polished/matte finish, or even add a metallic finish to the outside of your tub.

OTHER AVAILABLE PRODUCTS

Bathroom & laundry sinks, shower pans, freestanding outdoor cold/hot plunge, pet spas, walk-in-tubs.

COLD PLUNGE, FUSION & INDULGE

When ordering a freestanding tub with Cold Plunge, Fusion, or Indulge, a drawing for equipment location must be included.

COLLECTION REFERENCE

- Color-coded Collections
- Freight
- Systems Available
- Linear Drain/Waste and Overflow
- Warranty
- Pumps
- Hydrozone

	DESIGNER COLLECTION	METRO COLLECTION	STON COLLECTION	STUDIO COLLECTION
MATERIAL	Acrylic & Gel Coat	Hydroluxe SS™	Hydroluxe SS™	Acrylic & Gel Coat
FREIGHT	FFA	\$200 net	\$200 net	FOB
SYSTEMS AVAILABLE	Whirlpool, Thermal Air, & Combo	Thermal Air	Whirlpool, Thermal Air, & Combo	Whirlpool & Thermal Air
LINEAR DRAIN	Optional/Cost	Standard	Optional/Cost (Drop-In Only)	Standard on a few models
STANDARD LINEAR DRAIN FINISH	Chrome	Color Matched	Color Matched	Chrome
CABLE WASTE/OVERFLOW INCLUDED	Yes/PC standard, all finishes no cost, except gold	N/A	Yes (Drop-In models only)	No
WARRANTY	99 Years	10 Years	10 Years	5 Years
CUSTOM PUMP/BLOWER LOCATION	Yes	Yes	Yes	\$240
WHIRLPOOL PUMP	2.25 HP	N/A	2.25 HP	1.25 HP
HYDROZONE	Included with System	Included with System	Included with System	\$555
HYDRO EXPRESS (NET COST)	Drop-In - \$300 Freestanding - \$500	Yes - \$500	Drop-In - \$300 Freestanding - \$500	Drop-In - \$300 Freestanding - \$500

Quick Ship does not affect/replace normal freight costs. Quick Ship just gets your tub's manufacturing lead time reduced

ELECTRICAL REQUIREMENTS

BATHTUB & FITTING COLORS

GEL COAT BATHTUB COLORS

Standard Colors: White | Almond | Biscuit | Bone
Gel Coat colors match all manufacturers fixture colors.
Custom color matching is available at \$ 485 additional list price per order.

ACRYLIC BATHTUB COLORS

Standard Colors: White | Biscuit | Bone
Premium Colors: Black | Sterling Silver
\$ 480 additional list price
\$ 1,350 additional list price (freestanding)
(additional lead time required)

HYDROLUXE SS™ BATHTUB COLOR

Standard Colors: White | Almond | Biscuit
Premium Colors: Black | Carmine Red | Concrete Grey
Distant Blue | Grey Beige | Moss Green | Orange
Brown | Pastel Violet | Purple Violet | Red Orange
Sapphire Blue | Signal Orange | Stone Grey
Tarpaulin Grey | Terra Brown

Custom colors available on all Hydroluxe SS™ bathtubs (Please check with Hydro Systems for pricing and lead time).

When ordering two-tone color tub, please specify which color is interior and exterior, plus finish for each color.

WHIRLPOOL JET COLORS

Whirlpool system fittings include jet trim and suction cover, and are available in the following color matched colors:

Biscuit | Silver | Black | White | Bone

COLOR MATCH POLICY

Hydro Systems uses colors developed by the gel-coat and acrylic manufacturers that match the colors used by bathroom fixture manufacturers as closely as possible. In a few cases it has been found that the color or shading of bathroom fixtures varies depending upon the time and location of manufacture.

Hydro Systems also finds that the colors and shading of cast iron, china or plastic fixtures sometimes appear to look different than gel-coat or acrylic as a result of different surface textures, finishes or room lighting. Due to these conditions, Hydro Systems assumes no responsibility for color variations between its bathtubs and products of other manufacturers.

Check with factory on availability before ordering. If color is not listed, check with factory for availability. Color match jets not available for all premium colors.

ELECTRICAL REQUIREMENTS

OPTION	VOLTS	AMPS	CIRCUIT REQUIREMENTS
Whirlpool	115	13	One 20 amp dedicated GFCI protected
Thermal Air	115	8	One 15 amp dedicated GFCI protected
Chromatherapy	115	1	Shares circuit when ordered w/ system. On tub only, one 15 amp dedicated GFCI protected.
Cold Plunge	115	13	One 15 amp dedicated GFCI protected
Combo System	115	13 pump/8 blower	One 20 amp, and One 15 amp dedicated GFCI protected (each)
Hydro Blanket	120	5 per control	One 15 amp dedicated GFCI protected per control
Hydro Indulge	115	8	One 15 amp dedicated GFCI protected
Inline Heater 1500	115	12.5	One 15 amp dedicated GFCI protected
Inline Heater 600W *	115	6	Shares circuit with whirlpool pump *
Fusion (1500W)	115	12.5	One 15 amp dedicated GFCI protected
Fusion (600W)	115	6	One 15 amp dedicated GFCI protected
BMS (Thermal Air) **	115	12.2	One 20 amp dedicated GFCI protected

* Shares circuit with whirlpool pump

** Back Masseur System with Thermal Air system only

SYSTEM WORKSHEET

- Fillable pdf available online

P.O. WORKSHEET

Date: _____ Company: _____
 P.O. #: _____ Address: _____
 Ordered by: _____ Phone: _____

SYSTEM INFORMATION

Tub Model: _____
 Drain LH or RH (if applicable): _____
 Color/Finish of W/O: _____
 Color of Tub: _____
 Finish of Tub (Polish, Matte / Inside, Outside): _____

SHIPPING ADDRESS Job Site Dealer

Company: _____
 Address: _____
 Phone: _____

TUB OPTIONS

- Back Masseur I - Quantity: _____ \$ _____
Finish: _____
- Back Masseur II - Finish: _____ \$ _____
(Only 1 Back Masseur II per tub)
- Cold Plunge \$ _____
- Export Crate \$ _____
- Extra High Density \$ _____
- Grab Bars - Finish: _____ \$ _____
Style of Bar: _____
- Hydro Blanket - Number of zones: _____ \$ _____
(Note zone locations on diagram)
- HydroCoat \$ _____
- HYDRO EXPRESS \$ _____
- Hydro Fill \$ _____
- HydroFusion - Type: _____ \$ _____
- Hydro Indulge \$ _____
- Inline Heater \$ _____
 _____ 110V 12.5 Amps/1.5 kW \$ _____
 _____ 110V 6.0 Amps/0.75 kW \$ _____
 _____ 220V 12.0 Amps/1.5 kW Mood Light \$ _____
- Additional Jet - Type: _____ \$ _____
Quantity: _____
- Jet Upgrade - Type: _____ \$ _____
Quantity: _____
- Plating for jets - Finish: _____ \$ _____
- Micro Therapy Jet - \$ _____

- Quantity: _____ Finish: _____
- Job Site Delivery \$ _____
 - LED Chromatherapy light \$ _____
 - Low Water Protection \$ _____
 - Micro Mount \$ _____
 - Molded Arm Rest - Quantity: _____ \$ _____
 - Neck Masseur Pillow Quantity: _____ \$ _____
 - Padded Head Rest (Black only) \$ _____
 - Pump Upgrade - 110V to 220V \$ _____
 - Variable Speed Pump (110V only) \$ _____
 - Remote Control \$ _____
 - Skirt - Type: _____ LH / RH \$ _____
Quantity: _____ Seamed / Seamless
 - Tile Flange - Molded \$ _____
(Note positioning of flanges on diagram)
 - Walk In Finish Upgrade - Finish: _____ \$ _____
 - Waste and Overflow: Integral / Linear \$ _____
Solid Brass Drain Upgrade
 - Waterfall Fill Spout (Integrally Molded) \$ _____
 - Recirculating Spout Option \$ _____
 - Inline Heater - Type: _____ \$ _____
 - Recirculation System (Auburn model only) \$ _____
 - Standard Equipment Locations
 - See diagram for Equipment Locations
- TOTAL \$ _____**

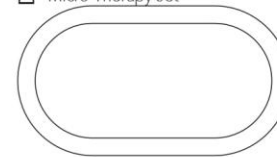

PLEASE SHOW:

- Pump location & access
- Tub drain
- Molded flanges
- Jet locations
- Tub overflow
- Other options

Customer Approval: _____ Date: _____

OUTDOOR COLLECTION

Dual-functionality

Designed with 2 bathing wells that can be hot and cold simultaneously
(Available on Avila and Cottonwood models)

Easy Installation

Set up in place, fill up and turn on

Can be installed outside in any environment

Chromatherapy (Available on Avila, Cottonwood, Yellowstone models)

Pop-up Waterfalls (Available on Avila, Cottonwood, Yellowstone models)

Powerful Jets

Hydrozone included

Hydrozone UV light can be added

Bluetooth Enabled (Available on Avila and Cottonwood models)

Chill water down to 37° F



Heat water up to 104° F

OUTDOOR COLLECTION



Powerful Jets



Chromatherapy



Pop-up Waterfalls



Hydro Soft Touch Control Panels



Cabinet Options



Chestnut



Driftwood



Graphite

Acrylic Options



Sterling



Midnight Canyon

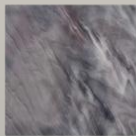

Storm Cloud



Smoky Mountain

Installation and Technical Support

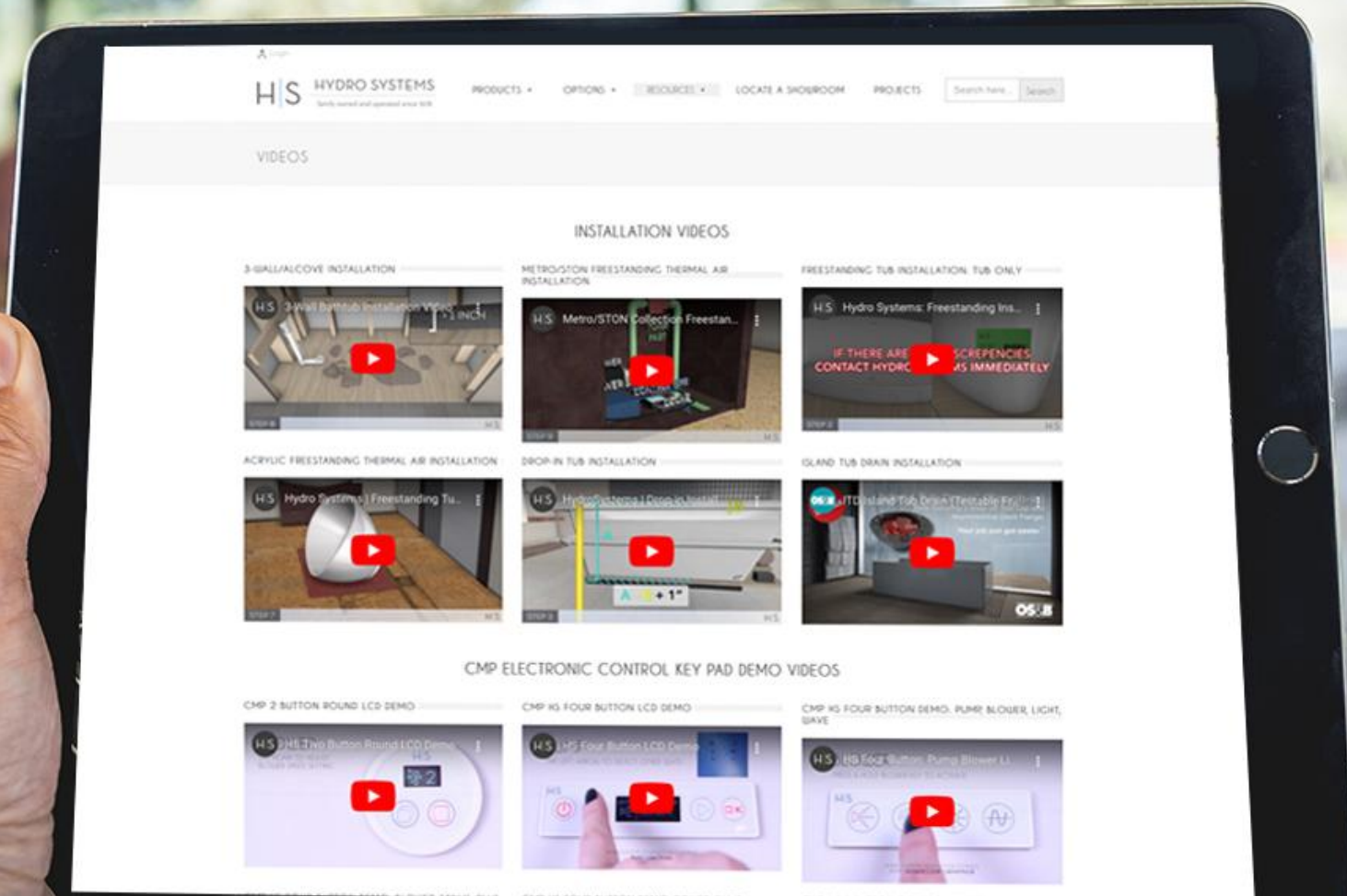

<https://hydrosystem.com/technical-information/videos/>

Thank you.

