



EM ELECTRIC MIRROR®

Company Overview

OUR STORY

From the Garage to the Global Leader



“My family and I founded this company on the simple idea of offering the very best products, backed by the very best warranties, and supported by the very best team – and we’ve never wavered from that commitment.”



Jim Mischel
JIM MISCHEL | CEO
ELECTRIC MIRROR

EM
ELECTRIC MIRROR®

Video – click on play

AN AMERICAN ORIGINAL

A man wearing a dark blue hoodie with 'EM ELECTRIC' on the chest, safety glasses, and gloves is working on a light fixture assembly. He is holding a small component in his right hand. The background shows a factory setting with a forklift and wooden pallets.

The brand

Family owned

Made in America with U.S. and global components

125,000 square foot facility

Global leader for over 27 years

50 design and utility patents to date

1.5 million products in use daily

Distributed in over 100 countries

2 brands to choose from - Electric Mirror & Cordova

The product

7 yr warranty

Easiest installation in industry - 2 piece chassis

Huge selection

Customization available on most products

WHY CHOOSE ELECTRIC MIRROR?

YOU'LL BE IN GOOD COMPANY.

Google

SHANGRI-LA
HOTELS and RESORTS

 sphere

ST REGIS



 WEIDNER
APARTMENT HOMES

THE ALICE

ARSOVA

MANDALAY BAY
RESORT AND CASINO, LAS VEGAS

St. Jude Children's
Research Hospital
Finding cures. Saving children.
ALSAC • DANNY THOMAS, FOUNDER

RAFFLES
LE ROYAL MONCEAU PARIS

Disney

COWBOYS

NOBU
HOTELS

LOCKHEED MARTIN 

ROSEWOOD

AvalonBay
COMMUNITIES

amazon

 KAISER
PERMANENTE.

THE TAJ MAHAL PALACE
MUMBAI

DELTA
SKY CLUB

ROCKEFELLER CENTER®

NORDSTROM



THE PHOENICIAN
SCOTTSDALE

ROLLS
ROYCE

Allegro

Goldman
Sachs

MASTERS
TOURNAMENT

JPMorganChase

MONDRIAN

Hospitality · Residential Single Family · Commercial · Industrial · Corporate · Education · Healthcare · Senior Living · Multi-Family

WHY CHOOSE ELECTRIC MIRROR?

HOTEL GUESTS EVERYWHERE LOVE US.

LUXURY



UPPER UPSCALE



UPSCALE



UPPER MIDSCALE



EM

ELECTRIC MIRROR®



RESIDENTIAL



HOSPITALITY



COMMERCIAL

LIGHTED MIRROR TECHNOLOGY

From mirrors made specifically for bathrooms, to vanishing mirrors engineered to optimize mirror technology, our mirror transcends all expectations.



BACK-LIT MIRRORS
WITH TASK LIGHTING



BACK-LIT MIRROR
WITH WALL-GLOW ONLY



BACK-LIT MIRROR WITH
TASK LIGHTING & WALL-GLOW



FRAME-LIT WITH INWARD
FACING DIRECTIONAL LIGHTING



BACK-LIT MIRRORS WITH TASK LIGHTING

- Enclosed Chassis
- Frosted on the front of the mirror (not touching the edge)
- Great for task lighting (all lighting on the front)
- Dimmable by Forward Phase wall dimmer (D2)
- Ava (capacitive touch button) available as a standard upgrade
- Custom sizes available
- Defogger option

BACK-LIT MIRRORS WITH TASK LIGHTING

•Integrity •Aria •Fusion •Bela •Eternity •Saratoga

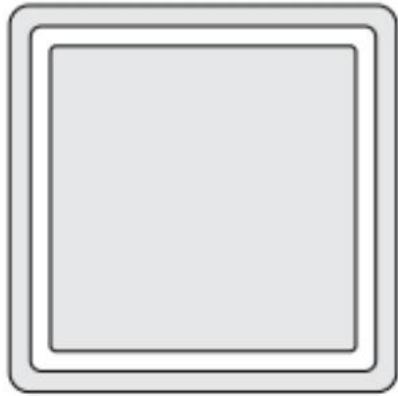

Aria™

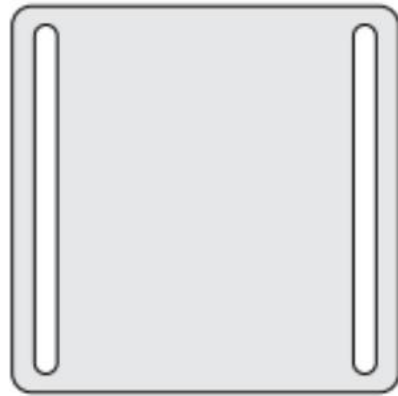

Bela™

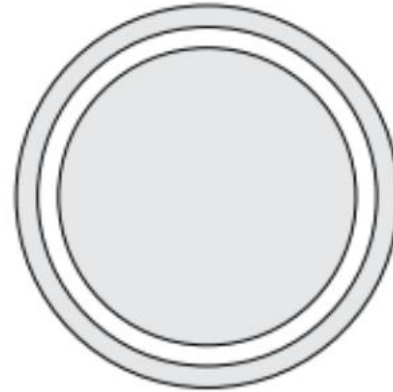

Eternity™

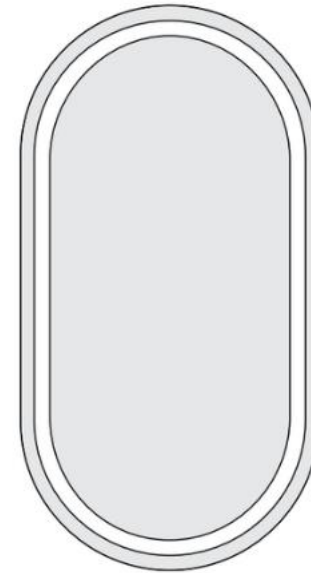

Saratoga™

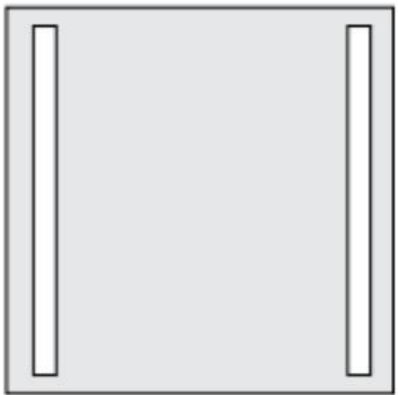

Fusion™

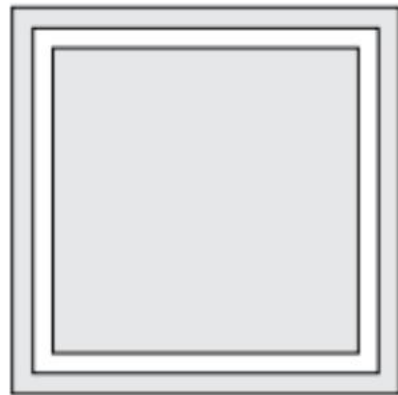

Integrity™

BACK-LIT MIRROR WITH WALL-GLOW ONLY

- Keen & defogger option
- Custom sizes available
- Controlled by phase/triac dimming wall switch



BACK-LIT MIRROR WITH WALL-GLOW ONLY

▪Luna ▪Serenity



LUNA



SERENITY

BACK-LIT MIRROR WITH TASK LIGHTING & WALL-GLOW

- Dimmable by Forward Phase wall dimmer (D2)
- Keen & defogger option
- Custom sizes available



BACK-LIT MIRROR WITH TASK LIGHTING & WALL-GLOW

▪Eyla ▪Novo ▪Silhouette ▪Trinity

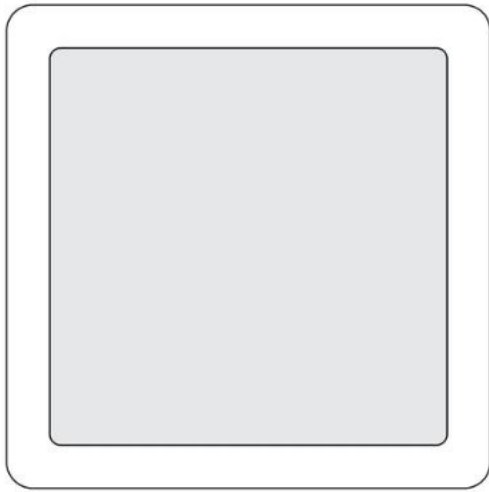

Eyla™

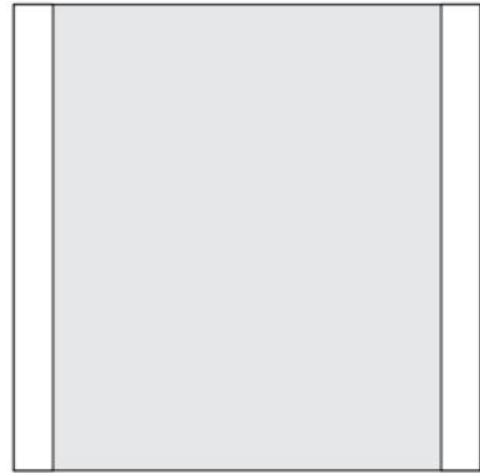

Novo™

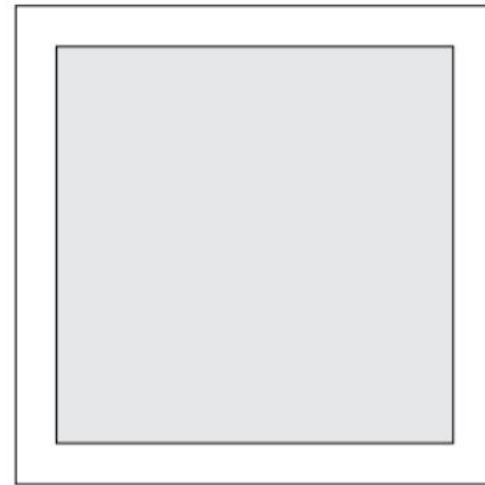

Silhouette™

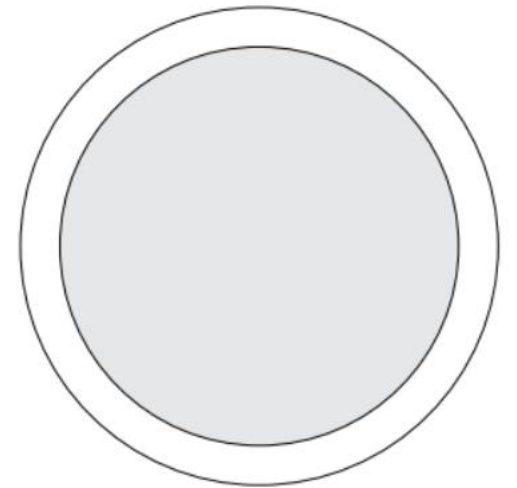

Trinity™

FRAME-LIT WITH INWARD FACING DIRECTIONAL LIGHTING

- Keen & defogger option
- Custom sizes available
Only on Radiance
- Controlled by phase/triac dimming
wall switch



FRAME-LIT WITH INWARD FACING DIRECTIONAL LIGHTING

BRILLANCE™

EMINENCE™

RADIANCE™



- Features integrated task lighting and a soft wall glow
- Features dual Keen buttons to control both technologies
- Requires on/off switch (cannot use dimmer wall switch)

- Front lit only
- For dimming, can use wall dimmer switch
- Keen (dimming) option available with button (as custom)

FRAME-LIT MIRRORS

Unlike our back-lit mirrors, these frame-lit mirrors feature diffused LED lighting positioned in front of the mirror glass, creating a striking border of light along the inside edge of the frame.

With a sleek profile and angled directional lighting, these mirrors provide brilliant facial illumination, creating fewer shadows and an impressively sharp reflection.



Brushed Brass
BR-02



Etched Chrome
CH-04



Matte Black
BK-05



Brushed Brass
BR-02



Matte Black
BK-05



Brushed Brass
BR-02



Matte Black
BK-05

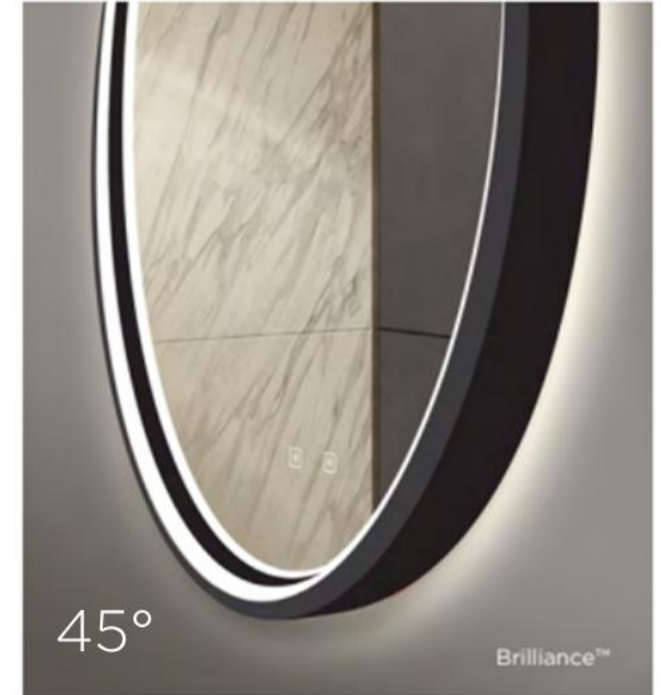

LED LIGHTING TECHNOLOGY



COLOR ACCURACY



CRI 80
Color Deficient Reflection

CRI 90
Natural Color Reflection

- Industry-leading 90+ CRI
- More flattering and comfortable light color
- In-house testing to measure true light color rendering

EFFICACY & EFFICIENCY



- 90% plus power factor = brighter task lighting for makeup application, shaving, and grooming
- Industry-leading high-output LEDs with 1280 lumens/foot
- Energy-saving 140+ lumens/watt

LIFESPAN

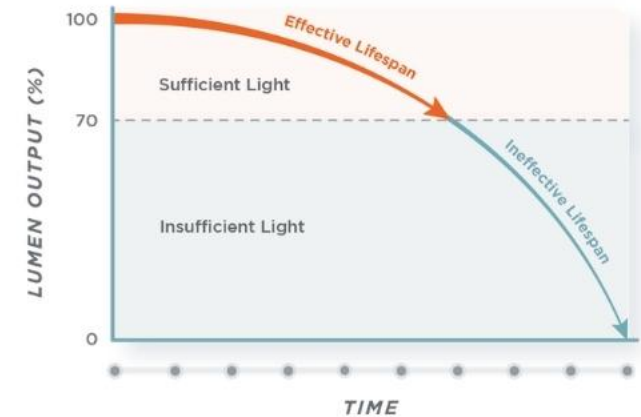

- 50,000 - 120,000-hour LEDs
- Tested to L₇₀

TECHNOLOGY - DIMMING AND COLOR TEMPERATURE

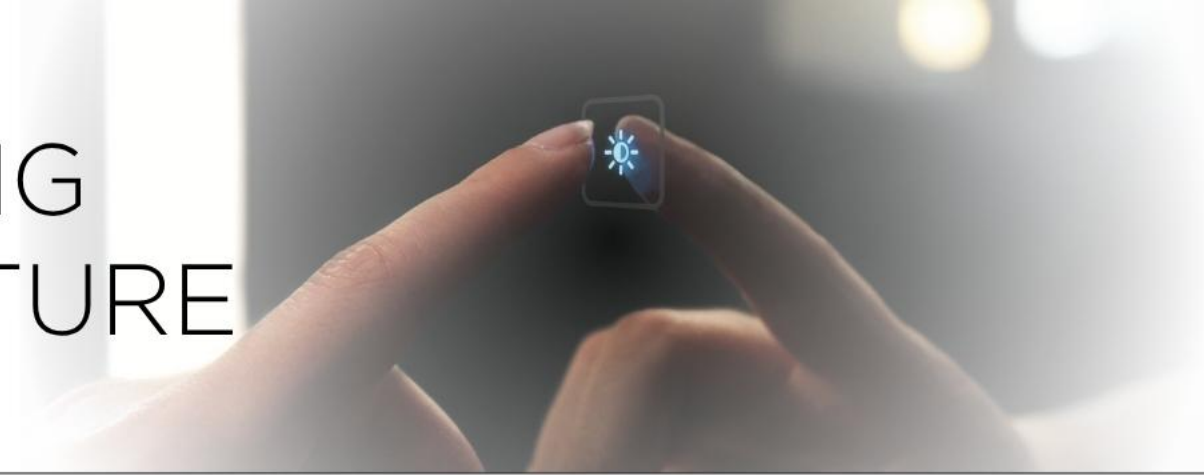

Ava™

Controls both dimming and color temperature

Keen™

Controls dimming only

- A on/off wall switch can be used with both Ava and Keen – recommended
- Ability to also turn off lights on mirror with both Ava & Keen
- A Wall dimming switch can ONLY be used if do not have Ava or Keen

AVA – TEMPERATURE & DIMMING TECHNOLOGY



Create ideal lighting for the moment

- Combined with standard integrated dimming, allows you to pick color and brightness
- Tunable LED light gives you freedom pick the right light for any occasion
- Standard on some designs with an optional AVA upgrade on others



Start at 2700 and top up to 5000 and back down. Hold for Nightflow on/off.

2,700K | 3,000K | 3,500K | 4,000K | 5,000K

Ava™

Integrity, Aria, Fusion Bela, Eternity, Saratoga

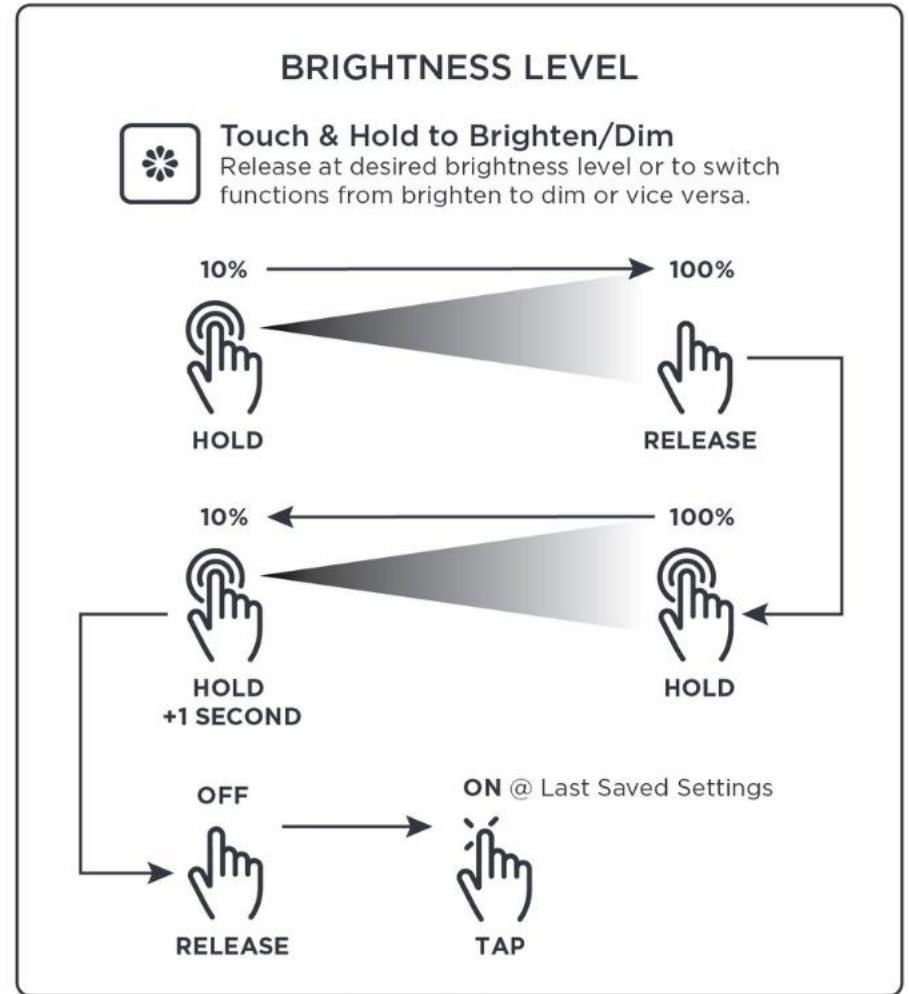
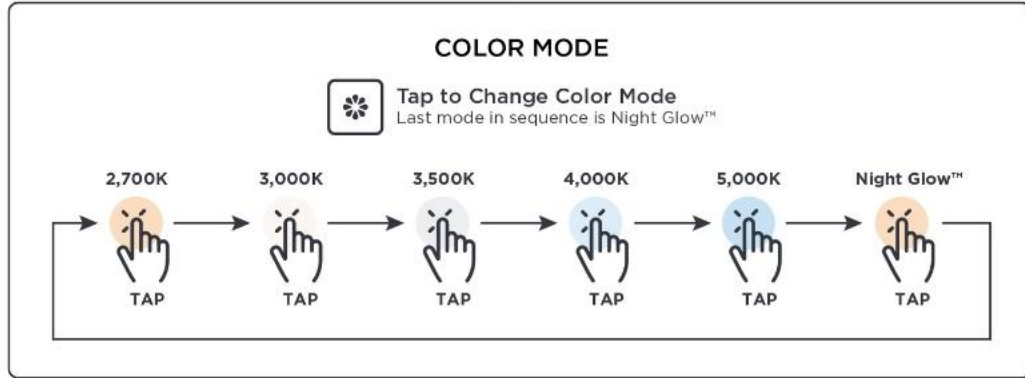

KEEN DIMMING TECHNOLOGY

Keen Provides range of dimming light levels to satisfy your needs:

- Lighting initiates at full brightness and dims down and back up by touching and holding the Keen™ icon
- Night Glow mode provides just enough lighting to safely guide you when the room is dark, and the Eye-Sensitivity Adjustment technology automatically reduces the light level as your eyes adjust to low light



BRIGHT LIGHTING

Ideal for tasks such as hair styling and shaving.

STANDARD LIGHTING

Good for general room illumination.

SOFT LIGHTING

Great for creating a relaxing atmosphere.

NIGHT GLOW LIGHTING

Convenient for guiding you when the room is dark.

Keen™



Switch On
Starts at 100% Brightness.

MODE



Tap to Change Lighting Mode

ON (100%)

Night Glow™

OFF

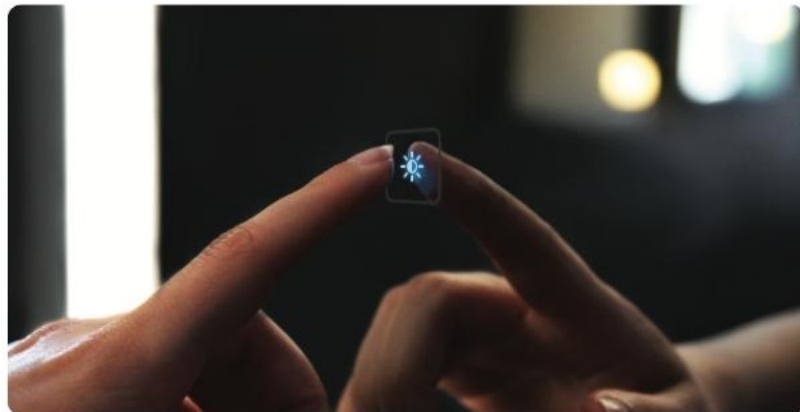
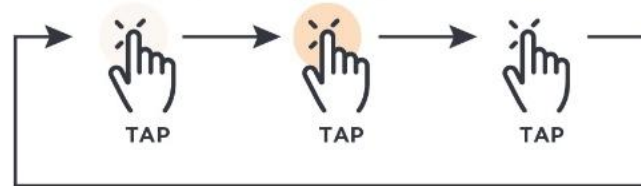

BRIGHTNESS LEVEL



Touch & Hold to Dim/Brighten

Release at desired brightness level or to switch functions from dim to brighten or vice versa.

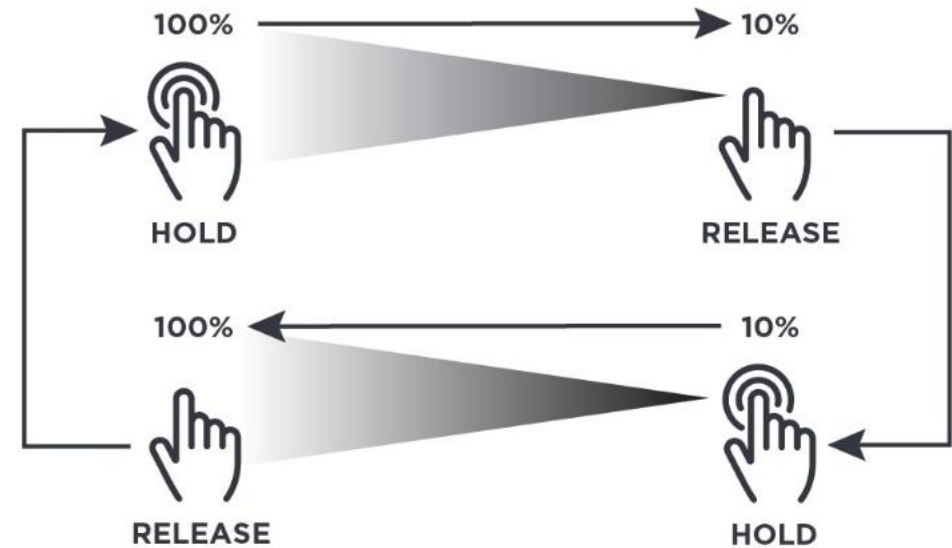

PRODUCT SEGMENTS



LIGHTED MIRRORS

WARDROBE MIRRORS

MAKEUP MIRRORS

MEDICINE CABINETS

FOG FREE MIRRORS

TV MIRRORS

TV COVERS



LIGHTED MIRRORS

- 19 designs
- Multiple sizes & finishes
- Most come standard with Ava™
- Wall-glow available on multiple models
- Defogger option
- Optional dimming switch on wall can be installed



WARDROBE MIRRORS



- 6 designs
- Multiple sizes & finishes
- One touch dimming available
- Ava™ and Keen™ available
- Optional dimming switch on wall can be installed

MAKEUP MIRRORS



- 5 designs
- Multiple finishes
- Forward facing lighting available
- Up/Down tilt
- 5X magnification



MEDICINE CABINETS



- 3 designs
- Multiple sizes
- Right or left swing doors available
- Integrated defogger
- Adjustable glass shelves
- 2 electrical outlet and 2 USB ports
- Soft Close
- Available to be gang mounted

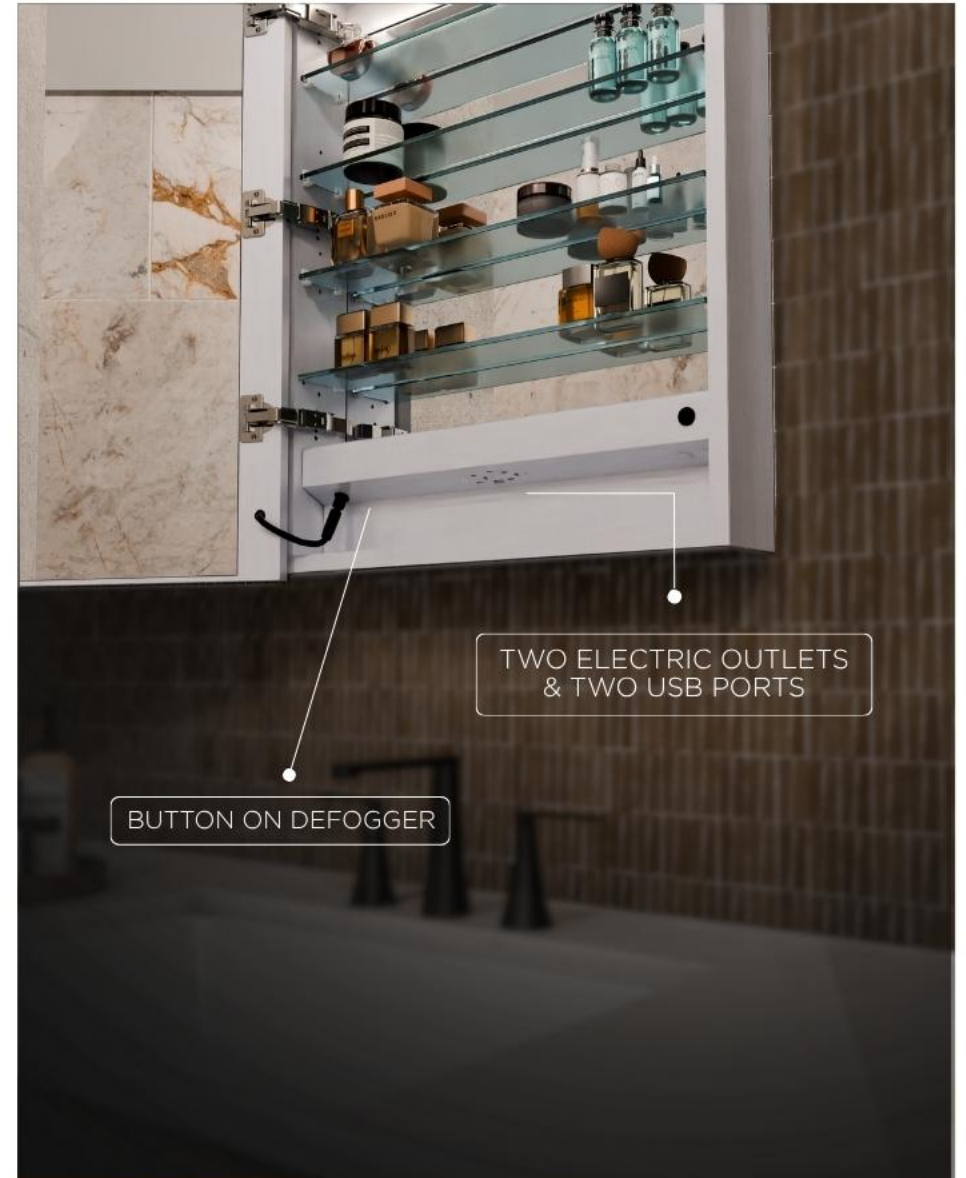

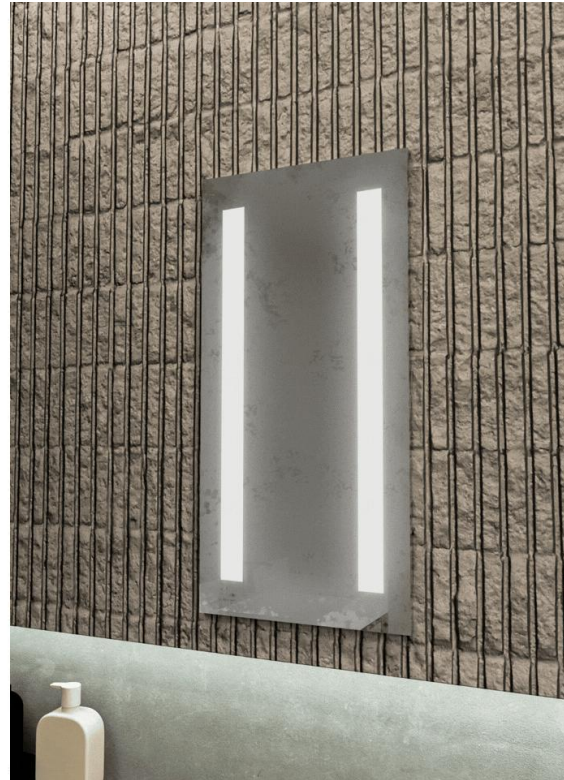

FOG FREE MIRRORS

- 2 designs
- 3 sizes available
- Keen™ & Ava™ options available
- Forward facing task lighting
- Integrated defogger
- Available down light

MIRROR TVS



- 4 designs
- 15.6" or 21.5" TV sizes available
- Multiple size mirrors
- Forward facing task lighting and dimming available
- Integrated speakers
- Multiple options for look when TV is off (Iris/Spectrum)

GLASS TYPES

SPECTRUM • *Standard*
• *Grey box when TV is off*



IRIS • *Used for Eclipse TV cover*
• *Turns entire TV into a mirror*





TV COVERS

- 5 sizes
- Covers TVs – 32” – 75”
- Glare resistant
- Universal design – fits virtually all flat screen TVs
- Brushed Black finish

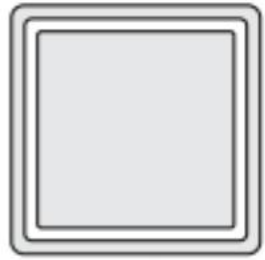

Aria™



Bela™

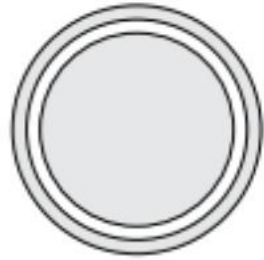

Eternity™



Eyla™

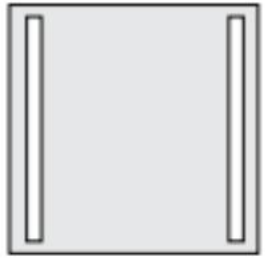

Fusion™

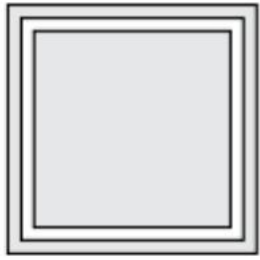

Integrity™



Loft™

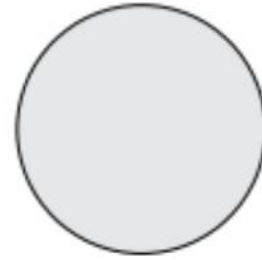

Luna™

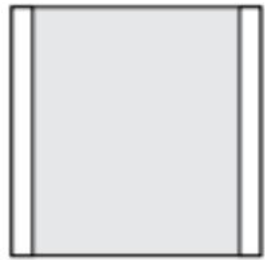

Novo™



Radiance™



Saratoga™



Serenity™

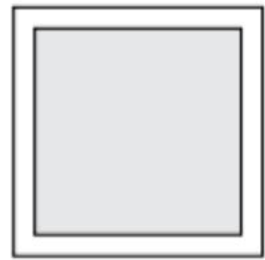

Silhouette™

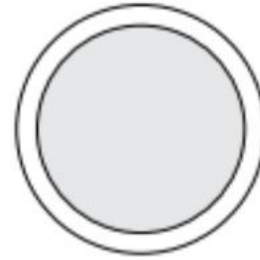

Trinity™

CUSTOMIZE THESE
MIRRORS TO VIRTUALLY
ANY WIDTH OR HEIGHT

- Heights from 20" to 80"
- Approval required over 80"
- Add 15.6" or 21.5" TV
- Add Ava color tuning
- Add Keen dimming
- Add a Defogger
- Finish option available on Radiance™

WHY CHOOSE ELECTRIC MIRROR?

Our mirrors are specifically created to protect against heat, humidity, corrosion, and scratching to give you years of beautiful, clear, smooth, accurate, and non-distorted reflection.

OmegaMirror™

- All Electric Mirrors utilize this technology
- Engineered specifically for bathroom
- Resists clouding, desilvering & black spot corrosion

ALL ELECTRIC MIRRORS HAVE THE SAME LEVEL OF QUALITY

- Acid test - submerged for 20 hrs
- Alkaline resistance test - submerged for 20 hrs
- 480 hrs of external CASS testing
- Adhesives test at high moisture conditions
- Machinal Shear test - subjected to 500 lbs/sq inch to make sure hanger doesn't separate from mirror

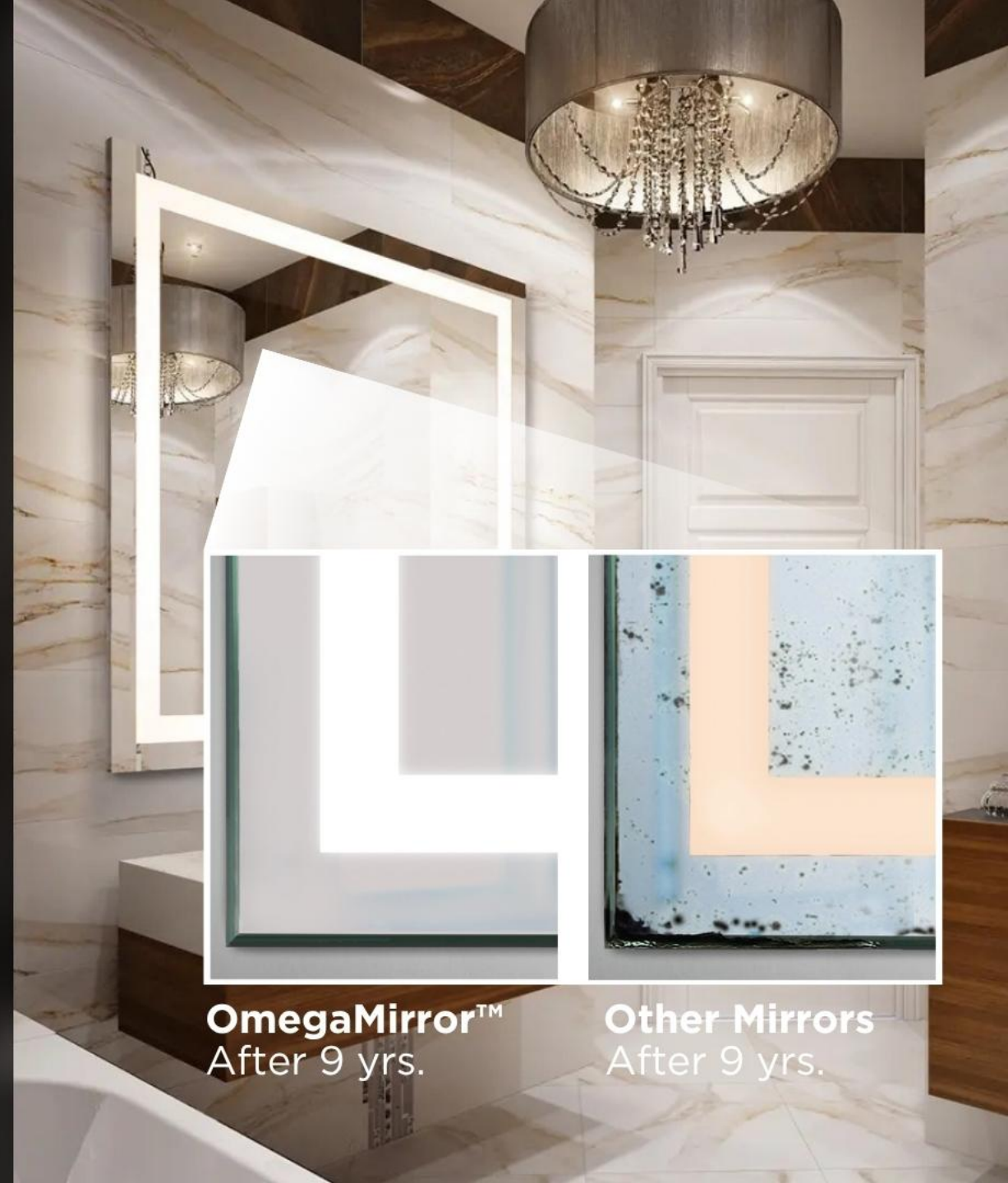

OmegaMirror™
After 9 yrs.

Other Mirrors
After 9 yrs.

INSTALLATION

Does not include Brilliance™, Eminence™ and Radiance™ which are 1 piece models

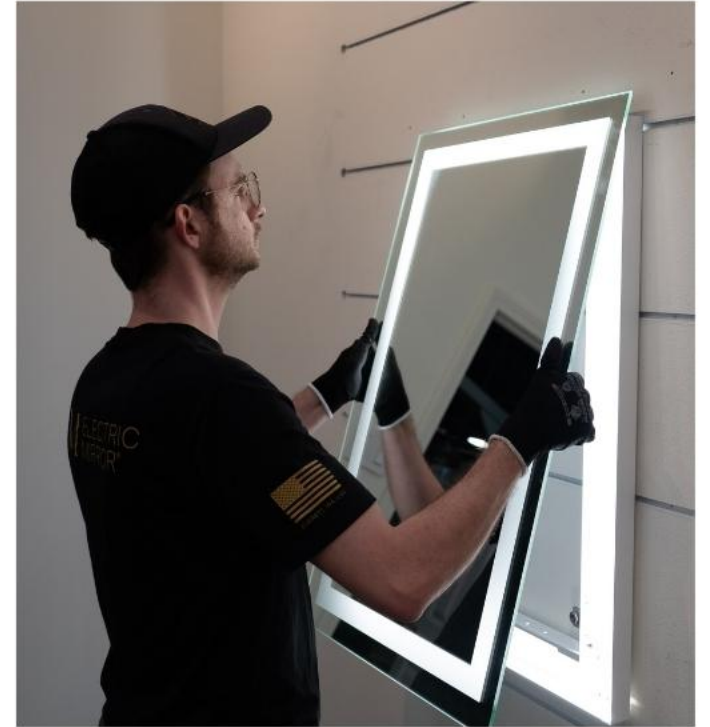

- Installation - 1 person job, depending on size
- Ease of serviceability
- Magnet on glass hold bottom flush against chassis
- In case of issues due to storm or power surge, it is easy to replace drivers or LEDs.



EM ELECTRIC
MIRROR

EM
ELECTRIC MIRROR®

PRICEBOOKS

CORDOVA™
BY ELECTRIC MIRROR



Aria™ Lighted Mirror



The Aria™ offers a delicate dichotomy of design for any room requiring a unique new look: the romantic curves of rounded corners combined with the exacting look of a symmetrical inset border of light.

EM ELECTRIC
MIRROR®

Size (W" x H" x D")	S&H	BASE MODEL ¹			BASE MODEL WITH AVA ¹		
		Price	In Stock	Model #	Price	In Stock	Model #
24 x 36 x 1.75	S \$70	\$2,273	Yes	ARI-2436	\$2,365	Yes	ARI-2436-AK
36 x 36 x 1.75	M \$140	\$2,500	Yes	ARI-3636	\$2,765	Yes	ARI-3636-AK
48 x 36 x 1.75	M \$140	\$3,170	Yes	ARI-4836	\$3,332	Yes	ARI-4836-AK
60 x 36 x 1.75	L \$210	\$3,299	Yes	ARI-6036	\$3,456	Yes	ARI-6036-AK

FEATURES AND BENEFITS

- OmegaMirror™ corrosion-resistant, 480-hour CASS-tested proprietary mirror glass
- Environmentally-leading, lead-free, copper-free mirror glass composition
- Fast lead times
- Easy installation
- Title 24 compliant
- JAB-2022 compliant
- 7-year limited warranty
- Patent: www.electrictmirror.com/patents
- Made in America with U.S. and global components

AVAILABLE OPTIONS

- Ava™ touch-tunable white + dimming technology^{1,2}
- Defogger²
- Custom sizes

LIGHTING SPECIFICATIONS

- Best-in-class illumination: 1,280 initial lumens/foot
- Superior color rendering: 90+ CRI
- High-density design: 54 LEDs/foot
- High efficacy: 140 lumens/watt
- Color temperature (CCT): 3,000K
- LED L₇₀ Lifespan (calculated): 52,000-hours
- Extended longevity: replaceable LEDs

SAFETY SPECIFICATIONS

- Entire assembly meets UL/cUL standards
- International certifications
- Safety-backed mirror

INSTALLATION SPECIFICATIONS

- 120-277VAC hardwire electrical connection; provide 36" whip; junction box not required
- Chassis should be mounted to wall studs; mounting holes are provided
- Controlled by phase/triac dimming wall switch (by others)
- Installation wiring may be different on mirrors equipped with additional options
- Fixture can only be hung in the WxH orientation as shown; fixture is not field-interchangeable

¹Standard model numbers shown. For additional options, see page 154 or contact residential@electrictmirror.com.

²See technology specification sheets for more details.

PRICEBOOK
ELECTRIC MIRROR

PRICEBOOK ELECTRIC MIRROR

FREIGHT CHARGE
FOR EACH MIRROR SIZE

IF IT'S A STOCKING ITEM

SOME MODELS COME
STANDARD WITH AVA

Size (W" x H" x D")	S&H	BASE MODEL ¹			BASE MODEL WITH AVA ¹		
		Price	In Stock	Model #	Price	In Stock	Model #
24 x 36 x 1.75	S \$70	\$2,198	Yes	INT-2436	\$2,241	Yes	INT-2436-AK
30 x 42 x 1.75	M \$140	\$2,408	Yes	INT-3042	\$2,619	Yes	INT-3042-AK
36 x 36 x 1.75	M \$140	\$2,425	Yes	INT-3636	\$2,630	Yes	INT-3636-AK
36 x 42 x 1.75	M \$140	\$2,538	Yes	INT-3642	\$2,738	Yes	INT-3642-AK
42 x 36 x 1.75	M \$140	\$2,538	Yes	INT-4236	\$2,738	Yes	INT-4236-AK
42 x 42 x 1.75	L \$210	\$2,938	Yes	INT-4242	\$2,894	Yes	INT-4242-AK
48 x 36 x 1.75	M \$140	\$3,019	Yes	INT-4836	\$2,975	Yes	INT-4836-AK
54 x 42 x 1.75	L \$210	\$3,148	Yes	INT-5442	\$3,224	Yes	INT-5442-AK
60 x 36 x 1.75	L \$210	\$3,148	Yes	INT-6036	\$3,224	Yes	INT-6036-AK
66 x 42 x 1.75	L \$210	\$3,764	Yes	INT-6642	\$3,451	Yes	INT-6642-AK
72 x 42 x 1.75	L \$210	\$3,829	Yes	INT-7242	\$4,342	Yes	INT-7242-AK

SHOWING ALL STANDARD SIZES
- NOTE: CAN CUSTOMIZE SIZES

See our coordinating Integrity™ Wardrobe Mirror on page 126.

RETAIL/LIST PRICE

MODEL NUMBERS

PRICEBOOK ELECTRIC MIRROR

IF MIRROR CAN BE CUSTOMIZED

GENERAL SPECS FOR MIRROR

FEATURES AND BENEFITS

- OmegaMirror™ corrosion-resistant, 480-hour CASS-tested proprietary mirror glass
- Environmentally-leading, lead-free, copper-free mirror glass composition
- Fast lead times
- Easy installation
- Title 24 compliant
- JA8-2022 compliant
- 7-year limited warranty
- Patent: www.electricmirror.com/patents
- Made in America with U.S. and global components

AVAILABLE OPTIONS

- Keen™ one-touch energy-saving dimming technology¹
- Defogger²

WHICH OPTIONS CAN BE ADDED TO MIRROR

- Custom sizes

LIGHTING SPECIFICATIONS

- Best-in-class illumination: 1,280 initial lumens/foot
- Superior color rendering: 90+ CRI
- High-density design: 54 LEDs/foot
- High efficacy: 140 lumens/watt
- Color temperature (CCT): 3,000K
- LED L₇₀ Lifespan (calculated): 52,000-hours
- Extended longevity: replaceable LEDs

SAFETY SPECIFICATIONS

- Entire assembly meets UL/cUL standards
- International certifications
- Safety-backed mirror

INSTALLATION SPECIFICATIONS

- 120 or 277VAC hardwire electrical connection; direct wire from behind power box or provide whip to reach side knockout; junction box not required
- Fixture should be mounted to wall studs; wall cleat provided
- Controlled by phase/triac dimming wall switch (by others)
- Installation wiring may be different on mirrors equipped with additional options

KEY POINTS ON INSTALLATION

More detailed info can be found in installation instructions and spec sheets.

Price Guide Index

Lighted Mirrors

Product	Model #	Size (W" x H" x D")	Price	In Stock	S&H	Technology	Page
Aria	ARI-2436	24 x 36 x 1.75	\$2,273	Yes	\$70	N/A	44
Aria	ARI-3636	36 x 36 x 1.75	\$2,500	Yes	\$140	N/A	44
Aria	ARI-4836	48 x 36 x 1.75	\$3,170	Yes	\$140	N/A	44
Aria	ARI-6036	60 x 36 x 1.75	\$3,299	Yes	\$210	N/A	44
Aria with Ava	ARI-2436-AK	24 x 36 x 1.75	\$2,365	Yes	\$70	Ava	44
Aria with Ava	ARI-3636-AK	36 x 36 x 1.75	\$2,765	Yes	\$140	Ava	44
Aria with Ava	ARI-4836-AK	48 x 36 x 1.75	\$3,332	Yes	\$140	Ava	44
Aria with Ava	ARI-6036-AK	60 x 36 x 1.75	\$3,456	Yes	\$210	Ava	44
Barcelona	BAR-3641	36.50 x 41.50 x 2.17	\$3,673	Yes	\$140	N/A	46
Bela	BEL-2442	24 x 42 x 1.75	\$2,214	Yes	\$140	N/A	48
Bela	BEL-3642	36 x 42 x 1.75	\$2,792	Yes	\$140	N/A	48
Bela with Ava	BEL-2442-AK	24 x 42 x 1.75	\$2,560	Yes	\$140	Ava	48
Bela with Ava	BEL-3642-AK	36 x 42 x 1.75	\$3,143	Yes	\$140	Ava	48
Brilliance	BRI-2436-BK05	24 x 36 x 2.13	\$1,841	Yes	\$70	Touch Dimming	50
Brilliance	BRI-30-BK05	30 diameter x 2.09	\$1,771	Yes	\$70	Touch Dimming	50
Brilliance	BRI-36-BK05	36 diameter x 2.09	\$2,020	Yes	\$140	Touch Dimming	50
Brilliance	BRI-2436-BRO2	24 x 36 x 2.13	\$2,036	Yes	\$70	Touch Dimming	50
Brilliance	BRI-30-O2V-BRO2	30 diameter x 2.09	\$2,068	Yes	\$140	Touch Dimming	50
Brilliance	BRI-36-O2V-BRO2	36 diameter x 2.09	\$2,230	Yes	\$70	Touch Dimming	50
Element	ELE60-2436-BK05	24 x 36 x 2.75	Call for Price	No	INQUIRE	N/A	52
Element	ELE60-3042-BK05	30 x 42 x 2.75	Call for Price	No	INQUIRE	N/A	52
Element	ELE60-2436-SS02	24 x 36 x 2.75	Call for Price	No	INQUIRE	N/A	52
Element	ELE60-3042-SS02	30 x 42 x 2.75	Call for Price	No	INQUIRE	N/A	52
Element	ELE60-2436-SS01	24 x 36 x 2.75	Call for Price	No	INQUIRE	N/A	52
Element	ELE60-3042-SS02	30 x 42 x 2.75	Call for Price	No	INQUIRE	N/A	52
Element	ELE72-2436-BK05	24 x 36 x 2.75	Call for Price	No	INQUIRE	N/A	52
Element	ELE72-3042-BK05	30 x 42 x 2.75	Call for Price	No	INQUIRE	N/A	52
Element	ELE72-2436-SS02	24 x 36 x 2.75	Call for Price	No	INQUIRE	N/A	52
Element	ELE72-3042-SS02	30 x 42 x 2.75	Call for Price	No	INQUIRE	N/A	52
Element	ELE72-2436-SS01	24 x 36 x 2.75	Call for Price	No	INQUIRE	N/A	52
Element	ELE72-3042-SS02	30 x 42 x 2.75	Call for Price	No	INQUIRE	N/A	52
Eminence	EMN-2436-BK05	24 x 36 x 2.76	\$2,381	Yes	\$70	N/A	56
Eminence	EMN-3042-BK05	30 x 42 x 2.76	\$2,527	Yes	\$70	N/A	56
Eminence	EMN-2436-BRO2	24 x 36 x 2.76	\$2,759	No	\$140	Ava	56
Eminence	EMN-3042-BK02	30 x 42 x 2.76	\$2,900	No	\$140	Ava	56
Eternity	ETE-2130	21 x 30 x 1.75	\$2,381	Yes	\$70	N/A	56
Eternity	ETE-30	30 diameter x 1.75	\$2,527	Yes	\$70	N/A	56
Eternity	ETE-36	36 diameter x 1.75	\$2,759	No	\$140	Ava	56
Eternity with Ava	ETE-2130-AK	21 x 30 x 1.75	\$2,381	Yes	\$70	Ava	56
Eternity with Ava	ETE-30-AK	30 diameter x 1.75	\$2,527	Yes	\$70	Ava	56
Eternity with Ava	ETE-36-AK	36 diameter x 1.75	\$2,759	No	\$140	Ava	56
Eyla	EYL-2436	24 x 36 x 1.75	\$2,533	Yes	\$70	N/A	58
Eyla	EYL-3636	36 x 36 x 1.75	\$2,792	Yes	\$140	N/A	58
Eyla	EYL-4836	48 x 36 x 1.75	\$3,548	Yes	\$140	N/A	58
Eyla	EYL-6036	60 x 36 x 1.75	\$3,694	Yes	\$140	N/A	58

• Chart in back of pricebook with all info on each mirror

Product	Model #	Size (W" x H" x D")	Price	In Stock	S&H	Technology	Page
Aria	ARI-2436	24 x 36 x 1.75	\$2,273	Yes	\$70	N/A	44
Aria	ARI-3636	36 x 36 x 1.75	\$2,500	Yes	\$140	N/A	44
Aria	ARI-4836	48 x 36 x 1.75	\$3,170	Yes	\$140	N/A	44
Aria	ARI-6036	60 x 36 x 1.75	\$3,299	Yes	\$210	N/A	44
Aria with Ava	ARI-2436-AK	24 x 36 x 1.75	\$2,365	Yes	\$70	Ava	44

PRICEBOOK ELECTRIC MIRROR

CORDOVA™

BY ELECTRIC MIRROR



Charisma™



Grandeur™



Harmony™



Mystique™

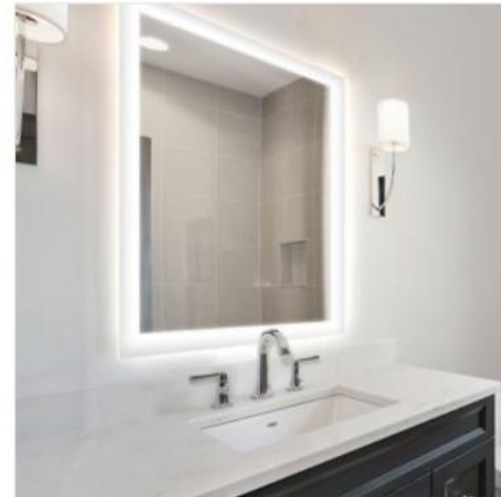

Prestige™



Unity™

- Competitive price
- List Price Range - \$ 650 - \$1,200
- 3 yr warranty
- 6 designs
 - Multiple sizes
- Dimming is standard- Must have wall switch
- Product stocked in Everett, WA

CORDOVAMIRRORS.COM



RESIDENTIAL

HOSPITALITY

MULTIFAMILY

CORDOVA™
BY ELECTRIC MIRROR

[Lighted Mirrors](#)

[Showroom Locator](#)

[Product Specifications](#)

[Installation Instructions](#)

[About Us](#)

[Customer Support](#)

Contemporary Design.
Natural Lighting.
Competitive Price.

Home



CORDOVA PRICE BINDER



CORDOVA[™]
HOME

Contemporary design. Natural lighting. Competitive price.

Unity Lighted Mirror

Create a sense of Unity™ between light and mirror with the concentric design of a precision inset pattern of light surrounded by a bold reflective border

Model	Size (inches)	Lumens	Price
UNY-2436	24w x 36h x 1.71d	4,320	\$655
UNY-3042	30w x 42h x 1.71d	5,400	\$730
UNY-3636	36w x 36h x 1.71d	5,400	\$770
UNY-3642	36w x 42h x 1.71d	5,940	\$820
UNY-4836	48w x 36h x 1.71d	6,480	\$990

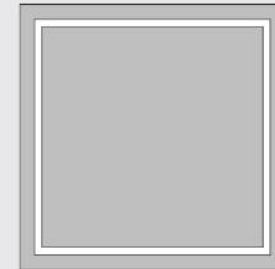

FEATURES AND BENEFITS

- Lead-free, copper-free, corrosion-resistant PrimeMirror™ glass
- Forward-facing task lighting
- Forward-phase dimming technology
- Suitable for damp bathroom environments
- Energy efficient
- Easy installation
- Title 24 compliant
- 3-year limited warranty
- Covered by one or more patents
- Designed in America and sourced globally

LIGHTING SPECIFICATIONS

- Natural-looking LED light color
- CRI: 90+
- CCT: 3,000 Kelvin
- 540 initial lumens per foot
- Maximum raw 96 lumens per watt efficacy
- Calculated L₉₀ 50,000-hour LED lifespan

SAFETY SPECIFICATIONS

- Entire assembly meets UL/cUL standards
- Safety-backed mirror

SAFETY SPECIFICATIONS

- 120V-240V hardwire electrical connection; provide 36" whip; junction box not required
- Fixture should be mounted to wall studs; wall cleat provided
- Controlled by forward-phase dimming wall switch
- Fixture can only be hung in the WxH orientation as shown; fixture is not field-interchangeable

Initial lumens are calculated based on the LED strip.

In-stock Unity lighted mirrors ship within one week. See Shipping and Handling page for information.

For complete Terms and Conditions, Warranty, Return Policy, and Freight Claim Policies, visit CordovaMirrors.com.

PACKAGING



EM ELECTRIC
MIRROR®



VANITIES
BY ELECTRIC MIRROR®

VANITY PRODUCT LAUNCH

SAVANNAH™ List Price: \$5,490.00

VANITIES
BY ELECTRIC MIRROR®

FINISHES:



BRUSHED BRASS
BR-02



POLISHED CHROME
CH-01



BLANCO CARRARA QUARTZ
QT-1021

COUNTERTOP OPTIONS:

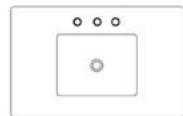

3-HOLE WIDESPREAD FAUCET

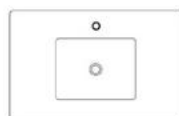

SINGLE HOLE FAUCET



WALL MOUNT FAUCET

DIMENSIONS:

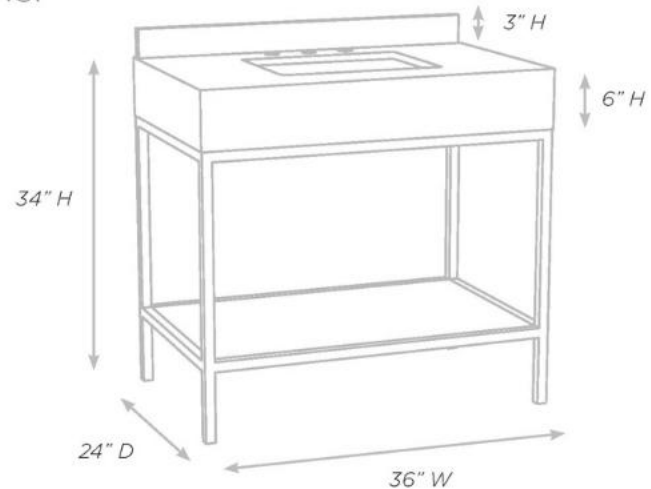

SAVANNAH™ | POLISHED CHROME

MONTEREY™ List Price: \$6,490.00

VANITIES
BY ELECTRIC MIRROR®

FINISHES:



SABRE OAK
WD-1019



LUXE OAK
WD-1020



**BLANCO CARRARA
QUARTZ**
QT-1021

COUNTERTOP OPTIONS:

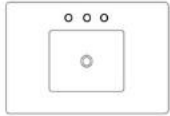

**3-HOLE WIDESPREAD
FAUCET**

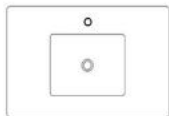

SINGLE HOLE FAUCET

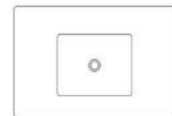

WALL MOUNT FAUCET

DIMENSIONS:

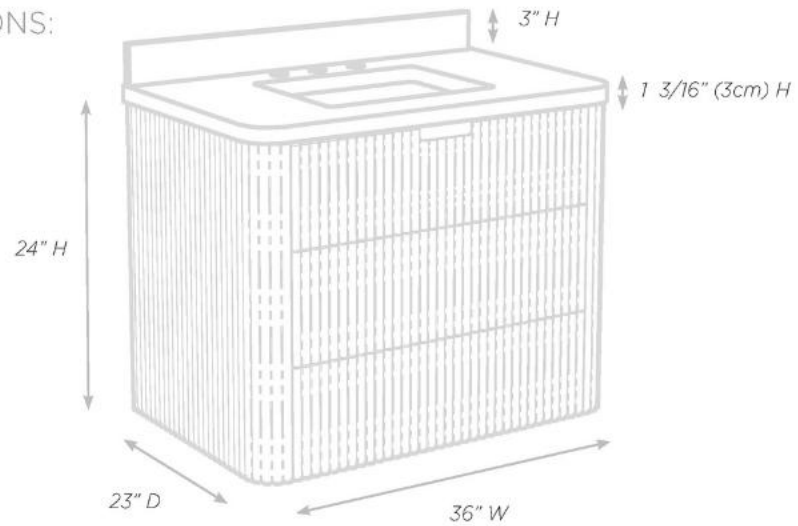

MONTEREY™ | LUXE OAK



SHOWROOM TOOL KIT



- Finish Sample Box
 - Wood Finish Samples
 - Metal Finishes Kit
 - Quartz Countertop Finish Sample
- Product Brochure (printed and digital)
- Pricing Guide (printed and digital)



RESIDENTIAL VANITIES | PRICING GUIDE

VANITIES BY ELECTRIC MIRROR™

Savannah™
List price: \$5,490.00
W: 36" x D: 23" x H: 34"

SVH-36-CH-01-FHD	\$5,490.00	Polished chrome, sink not drilled for faucet hole
SVH-36-CH-01-FH	\$5,490.00	Polished chrome, sink drilled for a single hole faucet
SVH-36-CH-01-FH2	\$5,490.00	Polished chrome, sink drilled for a 2-hole faucet
SVH-36-8802-FHD	\$5,490.00	Brushed brass, sink not drilled for faucet hole
SVH-36-8802-FH	\$5,490.00	Brushed brass, sink drilled for a single hole faucet
SVH-36-8802-FH2	\$5,490.00	Brushed brass, sink drilled for a 2-hole faucet

Montreux™
List price: \$6,480.00
W: 35.5" x D: 22.75" x H: 23.5"

MCH-36-WOOD-01-FHD	\$6,480.00	Sable Oak, sink not drilled for faucet hole
MCH-36-WOOD-01-FH	\$6,480.00	Sable Oak, sink drilled for a single hole faucet
MCH-36-WOOD-01-FH2	\$6,480.00	Sable Oak, sink drilled for a 2-hole faucet
MCH-36-WOOD-02-FHD	\$6,480.00	Luxe Oak, sink not drilled for faucet hole
MCH-36-WOOD-02-FH	\$6,480.00	Luxe Oak, sink drilled for a single hole faucet
MCH-36-WOOD-02-FH2	\$6,480.00	Luxe Oak, sink drilled for a 2-hole faucet

EM ELECTRIC MIRROR™

RESIDENTIAL VANITIES | PRODUCT BOOK

Shipping Cost Savannah/Montreux™ Vary by Size Fragile Fee \$350.00/TV \$1

SPIFF PROGRAM

REWARD CLAIMS

Earn Your Reward

\$25.00	Electric Mirror Lighted Mirrors
\$25.00	Electric Mirror Custom Lighted Mirrors
\$30.00	Electric Mirror Mirrored Cabinets
\$50.00	Electric Mirror Lighted TV Mirrors
\$50.00	Electric Mirror Isola Lighted Mirror
\$50.00	Electric Mirror New Products Launched in April 2026 <i>(see sheet below for model #)</i>
\$100.00	Electric Mirror Vanity

Claim Your Reward

Go to <https://www.electrictmirror.com/residential-dealer-sales-reward-program/> and fill out the online form completely and click the Submit button. Claim forms must be submitted by the 15th of the month after the order is placed.



2026 Electric Mirror Sales Rewards SPIFF Program

REWARDS PROGRAM OVERVIEW

You're invited to participate in our exclusive Sales Reward Program. Simply showcase our products to your customers and be rewarded for each sale you generate!



\$25 Reward

Electric Mirror Lighted Mirrors



\$25 Reward

Electric Mirror Custom Lighted Mirrors



\$30 Reward

Electric Mirror Mirrored Cabinets



\$50 Reward

Electric Mirror Lighted TV Mirrors



\$50 Reward

Electric Mirror Isola Lighted Mirror



\$100 Reward

Electric Mirror Vanities



\$50 Reward

Electric Mirror New Products



IMAP Policy

Internet Minimum Advertised Price (IMAP) Policy – Effective February 1, 2026



1. PURPOSE AND SCOPE

Electric Mirror (“The Company”) has unilaterally adopted this Internet Minimum Advertised Price Policy (“IMAP Policy”). This Policy applies to all distributors, dealers, showrooms, e-commerce resellers, and any other parties (“Resellers”) that advertise or sell Electric Mirror products to end users in North America.

This Policy is non-negotiable and adopted unilaterally; it is not an agreement or contract with any Reseller.

2. IMAP PRICING

Products subject to this policy are listed in The Company’s current Retail Price list or as otherwise provided in writing by The Company. Resellers may not advertise or promote IMAP-covered products at prices less than 25% below the Retail Price list, unless otherwise communicated in writing by The Company.

3. ADVERTISING AND PROMOTION

“Advertising” includes, but is not limited to, online marketing, price promotion visible to the public, website listings, third-party marketplaces, email campaigns, banner ads, paid search listings, Google Shopping feeds, affiliate or sponsored marketing channels under the Reseller’s control and any other electronic communication displaying price information, and product bundles, and package deals, and phrases such as “add to cart to see price,” “price too low to show,” “instant rebate,”

Advertising and promotion do not include:

- In-store displays
- Signage, and product price markings
- Price quotes
- Internet site “checkout” pages where the consumer makes the final purchase and payment elections



4. ENFORCEMENT

If The Company determines that a Reseller has violated the IMAP Policy, The Company may, at its sole discretion, take one or more of the following actions:

- First Violation: Written notice with a three-day window to correct.
- Second Violation within 12 months: Written notice with three days to correct.
- Third Violation within 12 months: No shipment of orders for a period of 30 days after correction.
- Fourth Violation within 12 months: EM will take such further action as it deems, in its sole discretion, to be reasonable and appropriate, up to and including holding all orders and termination of account.

Any violating Advertising that has not been removed or withdrawn within three business days of being notified by The Company shall be deemed a further violation of this Enforcement paragraph.

The Company reserves the right to determine whether a violation has occurred, to interpret this Policy, and to modify or suspend enforcement at any time, in its sole discretion.

5. UNILATERAL NATURE OF POLICY

This Policy is adopted unilaterally by Electric Mirror. The Company does not seek, and will not accept, any agreement or assurance of compliance from any Reseller. Resellers are free to determine their actual resale prices; this Policy only governs advertised prices.

6. POLICY MODIFICATIONS

The Company may modify, suspend, or terminate this Policy at any time. Any updates will be communicated in writing or electronically and become effective upon issuance.

7. CONFIDENTIALITY

The terms of this IMAP policy are confidential and may not be disclosed to other parties.





Search ...

EM

ELECTRIC MIRROR®

HOSPITALITY

RESIDENTIAL

COMMERCIAL

UPDATED
LUXURY WEBSITE

AMERICAN LUXURY™ FOR
INSPIRING SPACES

DISCOVER OUR MIRRORS & VANITIES

SEARCH BAR

CONTACT US



Q Search ...

EM RESIDENTIAL

FEATURED PROJECTS | FIND A SHOWROOM | CONTACT OUR TEAM | CHANNEL ▾ | HOME

Lighted Mirrors | Vanities | Frame-Lit Collection | Wardrobe Mirrors | Medicine Cabinets | In Shower Fog Free | Mirror TVs | Makeup Mirrors | Living Space | Custom Capabilities | Technology

NAVIGATION BAR



RESIDENTIAL

EASE OF USE

Home / Residential / Lighted Mirrors

LIGHTED MIRRORS

SEARCH BY TYPE OF MIRROR
TO SEE ALL COLLECTIONS



Integrity™ Lighted Mirror



Isola™ Lighted Mirror



Brilliance™ Lighted Mirror

WEBSITE

Home / Residential / Lighted Mirrors / Integrity™ Lighted Mirror



INTEGRITY™ LIGHTED MIRROR

Integrity™ adds glimmering light and tasteful grace to any space while making a powerful impression. Featuring smooth polished edges and a brilliant inner frame of frosted light, this radiant marvel is as stylish as it is functional.

CONSULT WITH OUR TEAM

FIND A SHOWROOM

SEE ALL LIST PRICING AND MODEL NUMBERS

SPECIFICATION SHEET



LIGHTING FEATURES & BENEFITS



FIND OUT MORE INFO

GENERAL FEATURES & BENEFITS



AVAILABLE OPTIONS



- Ava™ touch-tunable white • dimming technology ¹
- Defogger
- Custom sizes

¹ See technology specification sheets for more details

STANDARD SIZES, MODEL NUMBERS, & LIST PRICING



24" W x 36" H x 1.75" D (610mm W x 914mm H x 44mm D)

- INT-2436 \$2,198
- INT-2436-AK \$2,241

WARRANTY

7 YEARS



ELECTRIC MIRROR® WARRANTY: RESIDENTIAL

The Leader in Mirror Technology and Luxury Bathroom Product Solutions
7-Year Limited Warranty
Effective May 19, 2025

It's pretty simple. Luxury means luxury; we will support our products with the following amazing limited warranty.

Electric Mirror warranty periods for its products, excluding Cordova products, are set forth below and start at the date of sale.

- **Back Lit Mirrors:** Seven years.
- **Back Lit Mirrors with TVs:** Seven years excluding TVs as covered below.
- **Front Lit Mirrors:** Seven years.
- **Front Lit Mirrors with TVs:** Seven years excluding TVs as covered below.
- **Fog Free In-Shower Mirrors:** Three years.
- **Entertainment Mirror TVs:** Three years excluding TVs as covered below.
- **TV Covers:** Three years.
- **Mirrored Cabinets:** Three years.
- **Smart Mirrors:** Three years, excluding software as covered below.
- **Smart Mirrors with Integrated Lighting:** Three years, excluding software as covered below.
- **Waterproof TVs:** Two years.
- **Vanities:** Two years.
- **Makeup Mirrors:** One year.
- **Other Options and Features:** All options and features, including but not limited to capacitive touch controls, Alexa connectivity, speakers, clocks, mirrors used with clocks, nightlights, motion sensors, defoggers, decorative frames, and structural frames including frames with integrated lighting, are warranted for three years.
- **Specialty Mirror:** All specialty mirror including Iris, Spectrum, and V Mirror, and mirror with etched, sand blasted, laser etched, or other designs, or mirror with printed or painted designs are warranted for three years.
- **TV Technology:** All TVs 22" and under in size are warranted for three years. All TVs larger than 22" are warranted for two years.
- **Smart Mirror Displays:** All smart mirror displays are warranted for three years.
- **Software:** All software is warranted for one year.

This limited warranty ("Warranty") applies to all products and components ("Product") in Electric Mirror's Residential channel at the time of sale. It does not include Cordova products. This Warranty may be modified from time to time, and the applicable Warranty for a particular Product will be made available upon request to Electric Mirror.

If any Product of the original purchaser is shown to have defects in materials or workmanship that inhibit the functionality of the Product, and is reported in writing within the Warranty Period, Electric Mirror will, at its option, either: 1) Provide new or refurbished parts to Purchaser, 2) repair the Product with new or refurbished parts at its manufacturing facility, 3) replace the Product with a new or refurbished Product, or 4) refund an amount equal of the pro rata share of the Product's purchase price, determined by the remainder of the Warranty Period.



41 (425) 776-4046 | ELECTRICMIRROR.COM | 6001 ASSOCIATED BLVD., SUITE 301, EVERETT, WA 98203

Time Periods and Extension: All time periods are from the date of sale. Parts or Product replaced under Warranty does not extend the original Warranty.

Repair or Replacement Time Value: Warranty Periods have a time value that begins with one hundred percent replacement value and ends with fifty percent replacement value at the end of the Warranty Period.

ASTM Standard: All Electric Mirror brand mirrors will meet or exceed ASTM C1503-08 with a 24" blemish intensity.

Inspection: Electric Mirror reserves the right to examine all failed Product components and determine, in its sole discretion, whether any Product components are defective and covered under this Warranty.

Claims Procedure: Claims under this Warranty must be made through the dealer where the purchase occurred. After receiving a Return Material Authorization Number and shipping instructions, the Product must be promptly returned at Purchaser's expense to Electric Mirror.

Exceptions to Warranty:

- This Warranty does not cover removal, installation, or freight costs of Products.
- This Warranty shall not extend to anyone other than the original Purchaser of the Electric Mirror Product.
- Normal wear and tear, slight black edging, and slight de-silvering are not covered by this Warranty.
- Scratches that occur on frames including frames of Front Lit mirrors after installation are not covered by this Warranty.
- Blemishes, marks, or light reflections visible behind frames are not covered by this Warranty.
- Electric Mirror does not warrant its electronic components to be compatible with future variations and technology standards, home automation, light control, wall controls nor does it warrant reverse compatibility of software. It is Purchaser's responsibility to test and verify compatibility.
- Lighted Mirrors equipped with Alexa connectivity require customers to separately purchase an Alexa device to operate the mirror's voice control lighting. The customer's Alexa device is not warranted by Electric Mirror.
- Electric Mirror does not warrant that its TVs or Smart Mirror displays will integrate with cable, satellite, STB (Set-Top-Box), IPTV providers or home automation systems at present or in the future. It is Purchaser's responsibility to test and verify compatibility.
- Electric Mirror does not warrant that its Smart Mirror digital components are Play Protect Certified.
- Electric Mirror does not warrant that replacement TVs for Entertainment TVs or TV Covers are compatible with original TV mounting methods.
- Electric Mirror does not warrant third-party software, or data, or executable files being uploaded to any electronic components of Product, and Purchaser understands and agrees that the use of them is done at their own discretion and risk and that Purchaser is solely responsible for any damages that may result, including loss of data or damage to their computer system. It is up to Purchaser to take precautions to protect its data from malware, such as viruses, worms, Trojan horses, and other potentially destructive programs. Electric Mirror is not liable for data or security breaches.
- Electric Mirror does not warrant that software or internet connectivity, even if sold or embedded in its Smart Mirrors, will operate uninterrupted or error free.
- Electric Mirror does not warrant that its products will work with other software applications, third party application download sites, or third-party devices.
- Electric Mirror warrants mirror to be within 1/8" of tolerance.
- if stored prior to installation, mirrors must be kept in a dry indoor environment between 45 and 85 degrees Fahrenheit or this Warranty is void. Electric Mirror Products must be installed by a qualified, licensed electrician and operated under suitable environmental conditions and in accordance with the latest National Electrical Code.
- This Warranty will not apply in the event of conditions demonstrating abnormal use or stress, such as operating temperatures in excess of maximum rated temperatures or abnormally high humidity, under/over voltage conditions, excessive switching cycles or operating hours, dirty or cracked

EXCEPTIONS

- Fog free mirrors – 3 yrs
- Mirror TVs & TV Covers – 3 yrs
- Mirrored Cabinets – 3 yrs
- Cordova – 3 yrs
- Vanities – 2 yrs

- sockets, improper grounding, improper LED or driver installation, or what is considered normal wear and tear.
- This Warranty is void in the event the product is damaged in transit, or if damage or failure is caused by abuse, misuse, abnormal usage, storage of products in an improper environment, faulty installation, failure to follow installation instructions or Care and Cleaning instructions, damage in an accident, improper maintenance, or any repair. After the expiration of the Warranty period, Electric Mirror has no further obligation under any warranty, either expressed or implied, including the implied warranty of merchantability.
 - Vanities:**
 - Stone Tops – Cracking, chipping, or staining from harsh cleaning agents, impact damage, or improper sealing and maintenance. Tops must be sealed immediately after installation and maintained as per sealant's recommended schedule for warranty coverage.
 - Solid Surface – Scratching, cracking, or discoloration caused by abrasive cleaning tools, high heat exposure, or contact with harsh chemicals.
 - Wood and Laminate – Damage from excessive humidity, moisture, direct sunlight, high humidity, or extreme temperature fluctuations, leading to warping or fading, is not covered under this warranty.
 - Warranties for mirror glass will be void if corrosive or ammonia-based cleaning products are used, and if the edges or back of the mirror are not kept dry.
 - This Warranty does not cover incorrect field measurements.
 - This Warranty does not include coverage of light leaks or nightlight lumen output levels or lighting output levels.

Limitation of Liability: Electric Mirror will not, under any circumstance, whether as a result of breach of contract or warranty, tort, or otherwise, be liable for any incidental, special, or consequential damages, including lost profits or revenues or any other costs or damages. Any liability against Electric Mirror under any implied warranty, including the warranty of merchantability, is expressly limited to the terms of this Warranty and shall under no circumstances exceed the price paid to Electric Mirror for the Product. Some states do not allow limitations on how long an implied warranty lasts or do not allow the exclusion or limitation of incidental or consequential damages, so the above limitations or exclusions may not apply. This Warranty grants specific legal rights. Other rights, which vary from state to state, may also be applicable.

Damage in Transit: Electric Mirror will replace any of its Products damaged in transit if notified prior to installation and within 15 days of receipt of shipment if shipment was through one of Electric Mirror's own carriers. Notification of damaged goods must include a copy of the Proof of Delivery and a description of the damaged goods, as well as pictures taken prior to installation. If Products arrive visibly damaged, the extent of damage must be clearly detailed on the Proof of Delivery receipt.

Exclusive Remedy: This Warranty sets forth the exclusive remedies of a Warranty claimant, and the exclusive liabilities and obligations of Electric Mirror, with respect to allegations of a defective Product.

Electric Mirror
6001 Associated Blvd
Suite 301
Everett, WA 98203 USA
T: 425.776.4046
F: 425.494.8200
www.electricmirror.com

Version 8 EMR

41 (425) 776-4046 | ELECTRICMIRROR.COM | 6001 ASSOCIATED BLVD., SUITE 301, EVERETT, WA 98203

POLICY

Return Policy

- Must be A1 product
- Request RGA within 90 days of delivery
- 25% Restock fee
- Must be in original, unopened boxes

Shipping Damage Policy

- Damage must be reported within 15 days
- Take pics of damage
- Contact customer service
- Residential@electricmirror.com
- EM will provide Claim Info Form (CIF) to be filled out by dealer

Freight Policy

- Pricing only applies to contiguous US (AK & HI excluded)
- Below pricing in chart is for a single mirror
- For 2 or more extra small/small, add individual fees together.
- For 2 medium/large, freight is flat \$250
- For 3 or more medium/large, freight is FFA

XS <i>Extra Small</i>	S <i>Small</i>	M <i>Medium</i>	L <i>Large</i>
\$12	\$70	\$140	\$210

Free Freight Allowed

- FFA only applies to shipping in contiguous US (AK & HI excluded)
- Applies to net orders \$2,500 or greater
- Excludes: custom mirrors, mirror TVs, and mirrors over 42" tall

Drop Ship Policy

- Will drop ship to contiguous US (AK & HI excluded)
- If drop shipping multiple products, a single fee for the largest size will apply
- Drop ship fee still applies to orders that qualify for FFA

XS <i>Extra Small</i>	S <i>Small</i>	M <i>Medium</i>	L <i>Large</i>
+\$10	+\$55	+\$125	+\$175

EM ELECTRIC
MIRROR®

THANK YOU



residential@electricmirror.com



425.776.4946

EM ELECTRIC
MIRROR®

