

Q3/Q4 2021 *Effective July 1, 2021*



Product Catalog

Q3/Q4 2021

Pro-VS Products	ii	Platinum HD-TVI DVRs	P14	Access Control	P33
Platinum NVRs	iv	Platinum HD-TVI Cameras	P16	Wireless Solutions	P38
Platinum IP Cameras	P3	Sapphire Products	P21	Accessories	P42
Platinum IP PTZ Cameras	P13	Intercom	P30		

Designed For GOVERNMENT PROJECTS

Find the IP Solution for
Your Next Federal Project



Includes NVRs and
Additional Accessories



SKU	VSN7104-P4	VSN7208-P8	VSN7216-P16	VSN7432-P16	VSN7864-R NEW
Series	Pro-VS	Pro-VS	Pro-VS	Pro-VS	Pro-VS
Video Input	4CH IP@80Mbps	8CH IP@160Mbps	16CH IP@160Mbps	32CH IP@160Mbps	64CH IP@384Mbps
Video Output	HDMI up to 4K(3840x2160)/ VGA up to 1080P	HDMI up to 4K(3840x2160)/ VGA up to 1080P	HDMI up to 4K(3840x2160)/ VGA up to 1080P	HDMI up to 4K(3840x2160)/ VGA up to 1080P	HDMI1 up to 4K / HDMI2 up to 4K / VGA up to 1080P
Max. Recording Resolution	Up to 8MP(3840x2160)	Up to 8MP(3840x2160)	Up to 8MP(3840x2160)	Up to 8MP(3840x2160)	Up to 12MP (4247x2826)
Decoding Format	Ultra 265/H.265/H.264	Ultra 265/H.265/H.264	Ultra 265/H.265/H.264	Ultra 265/H.265/H.264	Ultra 265/H.265/H.264
Decoding Capability	1CH@4K / 4CH@1080P	2CH@4K / 8CH@1080P	2CH@4K / 8CH@1080P	2CH@4K / 8CH@1080P	2CH@12MP / 4CH@4K / 16CH@1080P
Max. Playback Resolution	Up to 8MP(3840x2160)	Up to 8MP(3840x2160)	Up to 8MP(3840x2160)	Up to 8MP(3840x2160)	Up to 12MP (4247x2826)
Audio In/Out	1CH/1CH, RCA	1CH/1CH, RCA	1CH/1CH, RCA	1CH/1CH, RCA	1CH/1CH, RCA
Alarm In/Out	-	4CH/1CH	4CH/1CH	16CH/4CH	16CH/4CH
Built-in PoE	4CH	8CH	16CH	16CH	16CH
Network	10/100M, 1 RJ45	10M/100M/1000M, 1 RJ45	10/100/1000M, 1 RJ45	10/100/1000M, 1 RJ45	10/100/1000M, 2 RJ45
Storage	1 SATA up to 10TB each	2 SATA up to 10TB each	2 SATA up to 10TB each	4 SATA up to 14TB each	8 SATA up to 10TB each; RAID 0,1,5,6,10; eSATA
Backup	1 USB 2.0, 1 USB 3.0	1 USB 2.0, 1 USB 3.0	1 USB 2.0, 1 USB 3.0	1 USB 2.0, 1 USB 3.0	2 USB 2.0, 1 USB 3.0
Dimensions	10.2"(W)x9.4"(D)x1.9"(H)	14.9"(W)x12.4"(D)x2.1"(H)	14.9"(W)x12.4"(D)x2.1"(H)	15.7"(W)x14.2"(D)x2.9"(H)	17.4"(W)x16.8"(D)x3.5"(H)
Recorder Case	Mini 1U	1U	1U	1.5U	2U
Accessory	-	Rack Mount (VSRM72) Sold Separately	Rack Mount (VSRM72) Sold Separately	Rack Mount Included	Rack Mount Included

Fixed Lens



SKU	VSIP3442W-28MA	VSIP3182W-28	VSIP7442W-28S	VSIP7182W-28	VSIP8442W-28MA	VSIP8182W-28
Resolution	4MP , 2688x1520@30fps	8MP , 3840x2160@20fps	4MP , 2592x1520@30fps	8MP , 3840x2160@20fps	4MP , 2592x1520@30fps	8MP , 3840x2160@20fps
Fixed Lens	2.8mm	2.8mm	2.8mm	2.8mm	2.8mm	2.8mm
Lux	0.01 Lux @ F2.0	0.05 Lux @ F2.0	0.01 Lux @ F2.0	0.05 Lux @ F2.0	0.01 Lux @ F2.0	0.05 Lux @ F2.0
Compression	Ultra 265/H.265/H.264	Ultra 265/H.265/H.264	Ultra 265/H.265/H.264	Ultra 265/H.265/H.264	Ultra 265/H.265/H.264	Ultra 265/H.265/H.264
IR	Smart IR LED up to 98ft	Smart IR LED up to 98ft	Smart IR LED up to 98ft	Smart IR LED up to 98ft	Smart IR LED up to 98ft	Smart IR LED up to 98ft
Feature	True WDR 120dB, 3D DNR, BLC, HLC, Defog	True WDR 120dB, 3D DNR, BLC, HLC, Defog	True WDR 120dB, 3D DNR, BLC, HLC, Defog	True WDR 120dB, 3D DNR, BLC, HLC, Defog	True WDR 120dB, 3D DNR, BLC, HLC, Defog	True WDR 120dB, 3D DNR, BLC, HLC, Defog
Audio	Built-in Mic	-	Audio In/Out	-	Built-in Mic	-
Alarm	-	-	Alarm In/Out	-	-	-
Storage	MicroSD up to 256GB, Automatic Network Replenishment	-	MicroSD up to 256GB, Automatic Network Replenishment	-	MicroSD up to 256GB, Automatic Network Replenishment	-
Axis	3 Axis	3 Axis	3 Axis	3 Axis	3 Axis	3 Axis
Rating	IP67, 2KV Surge Protection	IP67, 2KV Surge Protection	IP67, IK10 Vandal Proof, 2KV Surge Protection	IP67, IK10 Vandal Proof, 2KV Surge Protection	IP67, 2KV Surge Protection	IP67, 2KV Surge Protection
Power	DC 12V, PoE	DC 12V, PoE	DC 12V, PoE	DC 12V, PoE	DC 12V, PoE	DC 12V, PoE

Vari-focal Lens



SKU	VSIP7643W-SZ	VSIP9643W-SZ
Resolution	4MP , 2592x1520@30fps	4MP , 2592x1520@30fps
Variocall Lens	2.8 - 12mm, Auto Focus Motorized Zoom Lens	2.8 - 12mm, Auto Focus Motorized Zoom Lens
Lux	0.003 Lux @ F1.6	0.003 Lux @ F1.6
Compression	Ultra 265/H.265/H.264	Ultra 265/H.265/H.264
IR	Smart IR LED up to 98ft	Smart IR LED up to 164ft
Feature	True WDR 120dB, 3D DNR, BLC, HLC, Digital Defog	True WDR 120dB, 3D DNR, BLC, HLC, Digital Defog
Audio	Audio In/Out	Audio In/Out
Alarm	Alarm In/Out	Alarm In/Out
Storage	MicroSD up to 256GB, Automatic Network Replenishment	MicroSD up to 256GB, Automatic Network Replenishment
Axis	3 Axis	3 Axis
Rating	IP67, IK10 Vandal Proof, 6KV Surge Protection	IP67, 6KV Surge Protection
Power	DC 12V, PoE	DC 12V, PoE

Accessories

VSJB742	VSJB842	VSWM342	VSWM763	VSPM963
Junction Box for VSIP3442W-28MA, VSIP3182W-28, VSIP7442W-28S and VSIP7182W-28	Junction Box for VSIP8442W-28MA, VSIP8182W-28	Wall Mount for VSIP3442W-28MA, VSIP7442W-28S, VSIP3182W-28, VSIP7182W-28	Wall Mount for VSIP7643W-SZ	Pole Mount for VSIP9643W-SZ

PLATINUM NVR



Featuring

Western Digital Device Analytics
Proactive Management
of Storage Devices

Supported by
LTS NVRs



LONG-DISTANCE BUILT-IN PoE

Powered Up to 820ft with
High Ethernet Speed

MULTI-CAMERA CONFIGURATION

Support Multiple Camera Surveillance
Channels and Configure through NVR Interface

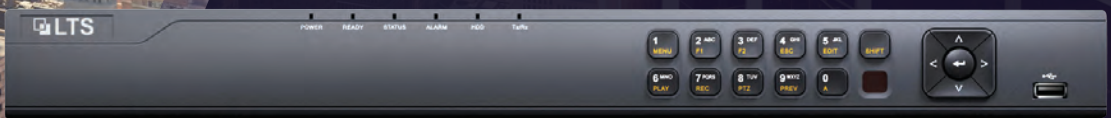



SKU	LTN8704Q-P4 LTN8704Q-P4N	LTN8708Q-P8 LTN8708Q-P8N	LTN8708K-P8	LTN8608-P8	LTN8716K-P16	LTN8616-P16
Series	Professional Level	Professional Level	Professional Level	Professional Level	Professional Level	Professional Level
Video Input	4CH IP@40Mbps	8CH IP@80Mbps	8CH IP@80Mbps	8CH IP@80Mbps	16CH IP@160Mbps	16CH IP@160Mbps
Recording	2MP	4CH@30fps/CH	8CH@30fps/CH	8CH@30fps/CH	16CH@30fps/CH	16CH@30fps/CH
	4MP	4CH@20fps/CH	8CH@20fps/CH	8CH@20fps/CH	16CH@30fps/CH	16CH@30fps/CH
	8MP	4CH@15fps/CH	8CH@15fps/CH	8CH@20fps/CH	16CH@20fps/CH	16CH@20fps/CH
Video Output	HDMI up to 4K(3840x2160) / VGA up to 1080P		HDMI up to 4K(3840x2160), VGA up to 1080P	HDMI up to 4K(3840x2160), VGA up to 1080P, CVBS	HDMI up to 4K(3840x2160), VGA up to 1080P	HDMI up to 4K(3840x2160), VGA up to 1080P, CVBS
Max. Recording Resolution	Up to 4K, 8MP(3840x2160)	Up to 4K, 8MP(3840x2160)	Up to 4K, 8MP(3840x2160)	Up to 12MP(4000x3072)	Up to 4K, 8MP(3840x2160)	Up to 12MP(4000x3072)
Decoding Format	H.265/H.265+/H.264/H.264+	H.265/H.265+/H.264/H.264+	H.265/H.265+/H.264/H.264+	H.265/H.265+/H.264/H.264+	H.265/H.265+/H.264/H.264+	H.265/H.265+/H.264/H.264+
Decoding Capability	1CH@4K / 4CH@1080P	1CH@4K / 4CH@1080P	2CH@4K / 8CH@1080P	2CH@4K / 8CH@1080P	2CH@4K / 8CH@1080P	4CH@4K / 16CH@1080P
Max. Playback Resolution	Up to 4K, 8MP(3840x2160)	Up to 4K, 8MP(3840x2160)	Up to 4K, 8MP(3840x2160)	Up to 12MP(4000x3072)	Up to 4K, 8MP(3840x2160)	Up to 12MP(4000x3072)
Audio In/Out	1CH/1CH, RCA	1CH/1CH, RCA	1CH/1CH, RCA	1CH/1CH, RCA	1CH/1CH, RCA	1CH/1CH, RCA
Alarm In/Out	-	-	4/1	4/1	4/1	4/1
Built-in PoE	4CH	8CH	8CH	8CH	16CH	16CH
Network	10/100/1000M, 1 RJ45	10/100/1000M, 1 RJ45	10/100/1000M, 1 RJ45	10/100/1000M, 1 RJ45	10/100/1000M, 1 RJ45	10/100/1000M, 1 RJ45
Storage	1 SATA up to 6TB, NAS, IP SAN	2 SATA up to 12TB, NAS, IP SAN	2 SATA up to 12TB, NAS, IP SAN	2 SATA up to 16TB, NAS, IP SAN	2 SATA up to 12TB, NAS, IP SAN	2 SATA up to 16TB, NAS, IP SAN
Support Fisheye#	-	-	-	6	-	6
Support POS#	-	-	-	4 (TCP)	-	8 (TCP)
Backup	2 USB 2.0	2 USB 2.0	1 USB 2.0, 1 USB 3.0	1 USB 2.0, 1 USB 3.0	1 USB 2.0, 1 USB 3.0	1 USB 2.0, 1 USB 3.0
Dimensions	12.4"(W)x9.1"(D)x1.8"(H)	15"(W)x12.4"(D)x1.8"(H)	15"(W)x12.4"(D)x1.8"(H)	15"(W)x12.4"(D)x1.8"(H)	15"(W)x12.4"(D)x1.8"(H)	15"(W)x12.4"(D)x1.8"(H)



SKU	LTN8916H	LTN8916H-P16	LTN8932H	LTN8932H-P16	LTN8932H-P24
Series	Enterprise Level	Enterprise Level	Enterprise Level	Enterprise Level	Enterprise Level
Video Input	16CH IP@160Mbps	16CH IP@160Mbps	32CH IP@256Mbps	32CH IP@256Mbps	32CH IP@256Mbps
Recording	2MP	16CH@30fps/CH	16CH@30fps/CH	32CH@30fps/CH	32CH@30fps/CH
	4MP	16CH@30fps/CH	16CH@30fps/CH	32CH@30fps/CH	32CH@30fps/CH
	8MP	16CH@20fps/CH	16CH@20fps/CH	32CH@20fps/CH	32CH@20fps/CH
Video Output	HDMI1 up to 4K(3840x2160), HDMI2/VGA up to 1920x1080P, CVBS up to 704x480		HDMI1 up to 4K(3840x2160), HDMI2/VGA up to 1920x1080P, CVBS up to 704x480		
Max. Recording Resolution	Up to 12MP(4000x3072)		Up to 12MP(4000x3072)		
Decoding Format	H.265/H.265+/H.264/H.264+		H.265/H.265+/H.264/H.264+		
Decoding Capability	4CH@4K / 16CH@1080P		4CH@4K / 16CH@1080P		
Max. Playback Resolution	Up to 12MP(4000x3072)		Up to 12MP(4000x3072)		
Audio In/Out	1CH/1CH, RCA		1CH/1CH, RCA		
Alarm In/Out	16/4		16/4		
Built-in PoE	-	16CH	-	16CH	24CH
Network	10/100/1000M, 2 RJ45		10/100/1000M, 1 RJ45		
Storage	4 SATA up to 32TB, eSATA, NAS, IP SAN		4 SATA up to 32TB, eSATA, NAS, IP SAN		
Support Fisheye Camera#	8		8		
Support POS#	8 (TCP or RS232)		16 (TCP or RS232)		
Backup	2 USB 2.0, 1 USB 3.0, eSATA, DVD-RW		2 USB 2.0, 1 USB 3.0, eSATA, DVD-RW		
Dimensions	17.5"(W)x15.3"(D)x2.8"(H)		17.5"(W)x15.3"(D)x2.8"(H)		



SKU	LTN8608D-P8	LTN8616D-P16	LTN8964-8	LTN8964-R	LTN07128-R16	LTN07256-R16	
Series	Enterprise Level	Enterprise Level	Enterprise Level	Enterprise Level	Enterprise Level	Enterprise Level	
Video Input	8CH IP@80Mbps	16CH IP@160Mbps	64CH IP@320Mbps	64CH IP@320Mbps	128CH IP@768Mbps	256CH IP@768Mbps	
Recording	2MP	8CH@30fps/CH	16CH@30fps/CH	64CH@30fps/CH	64CH@30fps/CH	128CH@30fps/CH	256CH@15fps
	4MP	8CH@30fps/CH	16CH@30fps/CH	64CH@20fps/CH	64CH@20fps/CH	128CH@20fps/CH	256CH@10fps
	8MP	8CH@20fps/CH	16CH@20fps/CH	64CH@15fps/CH	64CH@15fps/CH	128CH@12fps/CH	256CH@6fps
Video Output	HDMI up to 4K(3840x2160), VGA up to 1920x1080P, CVBS		HDMI1 up to 4K(3840x2160) / VGA1 up to 2K(2560x1440), HDMI2/VGA2 up to 1080P		HDMI1 up to 4K / VGA up to 1080P; HDMI2 up to 4K(4096x2160)		
Max. Recording Resolution	Up to 12MP(4000x3072)	Up to 12MP(4000x3072)	Up to 12MP(4000 x 3072)	Up to 12MP(4000x3072)	Up to 12MP(4000x3072)	Up to 12MP(4000x3072)	
Decoding Format	H.265/H.265+/H.264/H.264+	H.265/H.265+/H.264/H.264+	H.265/H.265+/H.264/H.264+	H.265/H.265+/H.264/H.264+	H.265/H.265+/H.264/H.264+	H.265/H.265+/H.264/H.264+	
Decoding Capability	3CH@4K / 12CH@1080P	3CH@4K / 12CH@1080P	4CH@4K / 16CH@1080P	4CH@4K / 16CH@1080P	5CH@4K / 20CH@1080P	5CH@4K / 20CH@1080P	
Max. Playback Resolution	Up to 12MP(4000x3072)	Up to 12MP(4000x3072)	Up to 12MP(4000x3072)	Up to 12MP(4000x3072)	Up to 12MP(4000x3072)	Up to 12MP(4000x3072)	
Deep Learning Support	4CH Human/Vehicle Detection		-	-	-	-	
Audio In/Out	1CH/1CH, RCA	1CH/1CH, RCA	1CH/2CH, RCA	1CH/2CH, RCA	1CH/1CH, RCA	1CH/1CH, RCA	
Alarm In/Out	4CH/1CH	4CH/1CH	16CH/4CH	16CH/4CH	48CH/24CH	48CH/24CH	
Built-in PoE	8CH	16CH	-	-	-	-	
Network	10/100/1000M, 1 RJ45	10/100/1000M, 1 RJ45	10/100/1000M, 2 RJ45	10/100/1000M, 2 RJ45	1000M, 4 RJ45, 4 Fiber Optic		
Storage	2 SATA up to 16TB, NAS, IP SAN		8 SATA up to 80TB, eSATA, NAS, IP SAN, RAID 0/1/5/6/10		16 SATA up to 160TB, NAS, IP SAN, RAID 0/1/5/6/10		
Support Fisheye Camera#	6	6	8	8	16	16	
Hot Swap HDD	-	-	-	Yes	Yes	Yes	
Support POS#	4 (TCP)	8 (TCP)	16 (TCP or RS232)	16 (TCP or RS232)	16 (TCP)	16 (TCP)	
Backup	1 USB 2.0, 1 USB 3.0	1 USB 2.0, 1 USB 3.0	3 USB 2.0, 1 USB 3.0, eSATA	3 USB 2.0, 1 USB 3.0, eSATA	2 USB 2.0, 2 USB 3.0	2 USB 2.0, 2 USB 3.0	
Dimensions	15"(W)x12.4"(D)x1.8"(H)	15"(W)x12.4"(D)x1.8"(H)	17.5"(W)x18.5"(D)x3.5"(H)	17.5"(W)x18.5"(D)x3.5"(H)	17.5" (W)x19.4"(D)x 5.7"(H)	17.5" (W)x19.4"(D)x 5.7"(H)	



SKU	LTN8704K-HT	LTN8708K-HT	LTN8716K-HT
Series	Hybrid	Hybrid	Hybrid
Analog Video Input	4CH up to 5MP HD-TVI4.0/AHD/CVI/960H	8CH up to 4K/8MP HD-TVI4.0/AHD/CVI/960H	16CH up to 4K/8MP HD-TVI4.0/AHD/CVI/960H
IPC Input	4CH up to 8MP(3072x2048)	8CH up to 8MP(3072x2048)	16CH up to 8MP(3072x2048)
Bandwidth	96Mbps	128Mbps	128Mbps
Video Output	VGA/HDMI up to 1080P, CVBS	HDMI up to 4K(3820x2160) / VGA up to 1080P, CVBS	HDMI up to 4K(3820x2160) / VGA up to 1080P, CVBS
Max. Recording Resolution	Up to 4K, 8MP(3840x2160)	Up to 4K, 8MP(3840x2160)	Up to 4K, 8MP(3840x2160)
Decoding Format	H.265/H.265+/H.264/H.264+	H.265/H.265+/H.264/H.264+	H.265/H.265+/H.264/H.264+
Max. Playback Resolution	Up to 4K, 8MP(3840x2160)	Up to 4K, 8MP(3840x2160)	Up to 4K, 8MP(3840x2160)
Audio In/Out	4CH/1CH, RCA	4CH/1CH, RCA	4CH/1CH, RCA
Alarm In/Out	4CH/1CH	8CH/4CH	16CH/4CH
Network	10/100/1000M, 1 RJ45	10/100/1000M, 1 RJ45	10/100/1000M, 1 RJ45
Storage	1 SATA up to 8TB, NAS, IP SAN	2 SATA up to 16TB, NAS, IP SAN	2 SATA up to 16TB, NAS, IP SAN
Support POS#	-	-	4 (TCP)
Backup	2 USB 2.0	1 USB 2.0, 1 USB 3.0	1 USB 2.0, 1 USB 3.0
Dimensions	12.4"(W)x9.1"(D)x1.8"(H)	15"(W)x12.4"(D)x1.8"(H)	15"(W)x12.4"(D)x1.8"(H)

PLATINUM IP CAMERA



Featured Products

Color247 IP Camera

See both indoor and outdoor environments in full color detail, even through the cover of darkness.

Thermal IP Camera

Detect abnormal heat signatures and prevent fires and explosions in high-risk areas for factories and warehouses.

Multi-Lens IP Camera

Get an easy-to-install, full 360-degree range of view with four times the 5MP video resolution in up to 4 live view streams.

Smart Tracking PTZ IP Cameras

Inspect designated targets with movement-based detection, ideal for high-traffic areas such as warehouses, parking lots, along with public streets and buildings such as school campuses.

License Plate Recognition IP Camera

Install real-time license plate recognition technology, with data searchable from IP Camera and NVR.

COLOR247 IP CAMERAS

Surveillance Solutions in 24/7 Color



Color247 IP Cameras



SKU	CMIP3C42W-28M CMIP3C42W-M CMIP3C42W-6M	CMIP3C42WB-28M CMIP3C42WB-M	CMIP3C42W-28MDA CMIP3C42W-MDA CMIP3C42WB-28MDA	CMIP8C42W-28M	CMIP8C42W-28MDA	CMIP9C42NW-M (Junction Box Included)	CMIP9C42W-28MD
Resolution	4MP, 2560x1440@24fps	4MP, 2560x1440@24fps	4MP, 2688x1520@30fps	4MP, 2560x1440@24fps	4MP, 2688x1520@30fps	4MP, 2688x1520@30fps	4MP, 2688x1520@30fps
Fixed Lens	2.8mm 4mm 6mm	2.8mm 4mm	2.8mm 4mm	2.8mm	2.8mm	4mm	2.8mm
Lux	0.0014 Lux @ F1.0 Ultra Low Lux	0.0014 Lux @ F1.0 Ultra Low Lux	0.0005 Lux @ F1.0 Ultra Low Lux	0.0014 Lux @ F1.0 Ultra Low Lux	0.0005 Lux @ F1.0 Ultra Low Lux	0.0014 Lux @ F1.0 Ultra Low Lux	0.0005 Lux @ F1.0 Ultra Low Lux
Compression	H.265/H.265+	H.265/H.265+	H.265/H.265+	H.265/H.265+	H.265/H.265+	H.265/H.265+	H.265/H.265+
Image Sensor	1/1.8" Progressive Scan CMOS	1/1.8" Progressive Scan CMOS	1/1.8" Progressive Scan CMOS	1/1.8" Progressive Scan CMOS	1/1.8" Progressive Scan CMOS	1/1.8" Progressive Scan CMOS	1/1.8" Progressive Scan CMOS
Features	True WDR 120dB	True WDR 120dB	True WDR 130dB	True WDR 120dB	True WDR 130dB	True WDR 120dB	True WDR 130dB
Audio In/Out	-	-	Built-in Microphone	-	Built-in Microphone	-	-
Storage	MicroSD Card Slot up to 128GB	MicroSD Card Slot up to 128GB	MicroSD Card Slot up to 256GB	MicroSD Card Slot up to 128GB	MicroSD Card Slot up to 256GB	MicroSD Card Slot up to 128GB	MicroSD Card Slot up to 256GB
Rating	IP67	IP67	IP67	IP67	IP67	IP67	IP67
Power	DC 12V, PoE	DC 12V, PoE	DC 12V, PoE	DC 12V, PoE	DC 12V, PoE	DC 12V, PoE	DC 12V, PoE

Accessories for CMIP3CXX

LTB701	LTB701B	LTB701-A	LTB701B-A	LTB342-140	LTB342-JBOX	LTB342-140B
Junction Box (White/Black) for CMIP3CxxM		Junction Box (White/Black) for CMIP3CxxMDA		Wall Mount	Junction Box for Wall Mount	Wall Mount with Junction Box

Accessories for 8CXX

LTB801	LTB801-A
Junction Box for CMIP8C42W-28M	Junction Box for CMIP8C42W-28MDA

■ Dome Fixed Lens

SKU	CMIP7042-28M	CMIP7042W-28MA NEW	CMIP7342W-28M CMIP7342WB-28M	CMIP7342W-M CMIP7342W-6M
Resolution	4MP , 2560x1440@20fps	4MP , 2560x1440@20fps	4MP , 2688x1520@30fps	4MP , 2688x1520@30fps
Fixed Lens	2.8mm	2.8mm	2.8mm	4mm 6mm
Lux	0.028 Lux @ F2.0	0.01 Lux @ F2.0	0.018 Lux @ F1.6	0.018 Lux @ F1.6
Compression	H.265/H.265+	H.265/H.265+	H.265/H.265+	H.265/H.265+
IR	IR LED up to 100ft	IR LED up to 98ft	Matrix IR LED up to 100ft	Matrix IR LED up to 100ft
Feature	DWDR, 3D DNR, BLC	True WDR 120dB, 3D DNR, BLC	True WDR 120dB, 3D DNR, BLC	True WDR 120dB, 3D DNR, BLC
Audio In/Out	-	Built-in Microphone	-	-
Storage	MicroSD/SDHC/SDXC Slot up to 256GB (Snapshot Only)	MicroSD Slot up to 256GB	MicroSD/SDHC/SDXC Slot up to 128GB	MicroSD/SDHC/SDXC Slot up to 128GB
Axis	2 Axis	2 Axis	3 Axis	3 Axis
Rating	IP67, IK10 Vandal Proof	IP67, IK10 Vandal Proof	IP67, IK10 Vandal Proof	IP67, IK10 Vandal Proof
Power	DC 12V, PoE	DC 12V, PoE	DC 12V, PoE	DC 12V, PoE

■ Dome Fixed Lens

SKU	CMIP7362W-28M CMIP7362WB-28M	CMIP7382NW-28M CMIP7382NW-M	CMIP7382W-28SH
Resolution	6MP , 3072x2048@20fps	8MP , 3840x2160@15fps	8MP , 3840x2160@20fps
Fixed Lens	2.8mm	2.8mm 4mm	2.8mm
Lux	0.028 Lux @ F2.0	0.028 Lux @ F2.0	0.028 Lux @ F2.0
Compression	H.265/H.265+	H.265/H.265+	H.265/H.265+
IR	Matrix IR LED up to 100ft	Matrix IR LED up to 100ft	Matrix IR LED up to 100ft
Feature	True WDR 120dB, 3D DNR, BLC	True WDR 120dB, 3D DNR, BLC	True WDR 120dB, 3D DNR, BLC, 1080P HDMI Video Output
Storage	MicroSD up to 128GB, Automatic Network Replenishment	MicroSD up to 128GB, Automatic Network Replenishment	MicroSD up to 128GB, Automatic Network Replenishment
Axis	3 Axis	3 Axis	3 Axis
Rating	IP67, IK10 Vandal Proof	IP67, IK10 Vandal Proof	IK10 Vandal Proof
Power	DC 12V, PoE	DC 12V, PoE	DC 12V, PoE

Accessories for CMIP70xxM, 73XX
For CMIP70xxMA

LTB347	LTB347B	LTB347H	LTB349	LTB348	LTB348B	LTB742-120
Junction Box (White/Black)		Junction Box for CMIP7382W-28SH	Angled Ceiling Mount (15°)	Wall Mount (White/Black)		Wall Mount for CMIP7042W-28MA
LTB342-110	LTB342-110B	LTB376	LTB378	LTB379		
Wall Mount	Wall Mount with Junction Box	Pendant Mount 22°(56cm)	Pole Mount	Corner Mount		

Mini Dome Fixed Lens



SKU	CMIP3142NW-28S	CMIP3142NW-28SWIFI	CMIP3162NW-28S
Resolution	4MP , 2688x1520@30fps	4MP , 2688x1520@30fps	6MP , 3072x2048@20fps
Fixed Lens	2.8mm	2.8mm	2.8mm
Lux	0.018 Lux @ F1.6	0.018 Lux @ F1.6	0.028 lux @ F2.0
Compression	H.265/H.265+	H.265/H.265+	H.265/H.265+
IR	Matrix IR LED up to 33ft	Matrix IR LED up to 33ft	Matrix IR LED up to 33ft
Feature	True WDR 120dB, 3D DNR, BLC	True WDR 120dB, 3D DNR, BLC	True WDR 120dB, 3D DNR, BLC
Audio In/Out	Built-in Microphone & Audio Out	Built-in Microphone & Audio Out	Built-in Microphone & Audio Out
Alarm In/Out	Yes	Yes	Yes
Built-in Wi-Fi	-	Yes	-
Storage	MicroSD Card Slot up to 128GB, Automatic Network Replenishment	MicroSD Card Slot up to 128GB, Automatic Network Replenishment	MicroSD Card Slot up to 128GB, Automatic Network Replenishment
Axis	3 Axis	3 Axis	3 Axis
Rating	IP66, IK8 Vandal Proof	IP66, IK8 Vandal Proof	IP66, IK8 Vandal Proof
Power	DC 12V, PoE	DC 12V, PoE	DC 12V, PoE

Wi-Fi IP Camera



SKU	CMIP8942NW-28SWIFI
Resolution	4MP , 2688x1520@30fps
Fixed Lens	2.8mm
Lux	0.018 Lux @ F1.6
Compression	H.265/H.265+
IR	Matrix IR LED up to 33ft
Feature	True WDR 120dB, 3D DNR, BLC
Audio	Built-in Mic and Speaker
Alarm In/Out	Alarm In/Out
Built-in Wi-Fi	Yes
Storage	MicroSD Card Slot Up to 128GB, Auto Network Replenishment
Axis	3 Axis
Power	DC 12V, PoE

Video Doorbell IP Camera



SKU	LTH-7132-WIFI
Resolution	3MP , 2048x1536@30fps
Fixed Lens	2.2mm
View	180° Panoramic View
Compression	Smart H.264 Compression
IR	IR up to 16ft
Feature	DWDR, 3D DNR
Audio	Built-in Mic and Speaker
Built-in Wi-Fi	Yes
Storage	MicroSD Card Slot Up to 128GB
Rating	IP65
Power	AC 8V~AC 24V
Accessories	3 Interchangeable Color Faceplates (White/Black/Coral)

Accessories for CMIP31XX

LTB742-120	LTB378	LTB379
Wall Mount for CMIP31XX	Pole Mount for CMIP31XX	Corner Mount for CMIP31XX

Dome Vari-focal Lens



SKU	CMIP7043W-MZ	CMIP7043NW-MZ NEW	CMIP7243NW-SZ	CMIP7263NW-SZ	CMIP7283NW-SZ
Resolution	4MP, 2560x1440@20fps	4MP, 2560x1440@20fps	4MP, 2688x1520@30fps	6MP, 3072x2048@20fps	8MP, 3840x2160@15fps
Variofocal Lens	2.8 - 12mm VF Motorized Lens	2.8 - 12mm VF Motorized Lens	2.8 - 12mm VF Motorized Lens	2.8 - 12mm VF Motorized Lens	2.8 - 12mm VF Motorized Lens
Lux	0.018 Lux @ F1.6	0.005Lux @ F1.6	0.018 Lux @ F1.6	0.018 Lux @ F1.6	0.018 Lux @ F1.6
Compression	H.265/H.265+	H.265/H.265+	H.265/H.265+	H.265/H.265+	H.265/H.265+
IR	Matrix IR LED up to 100ft	Matrix IR LED up to 100ft	Matrix IR LED up to 100ft	Matrix IR LED up to 100ft	Matrix IR LED up to 100ft
Smart Focus	Yes	Yes	Yes	Yes	Yes
Feature	True WDR 120dB, 3D DNR, BLC	True WDR 120dB, 3D DNR, BLC	True WDR 120dB, 3D DNR, BLC	True WDR 120dB, 3D DNR, BLC	True WDR 120dB, 3D DNR, BLC
Storage	MicroSD/SDHC/SDXC Card Slot up to 128GB (Snapshot Only)	MicroSD/SDHC/SDXC Card Slot up to 256GB	MicroSD/SDHC/SDXC Card Slot up to 128GB, Auto Network Replenishment	MicroSD/SDHC/SDXC Card Slot up to 128GB, Auto Network Replenishment	MicroSD/SDHC/SDXC Card Slot up to 128GB, Auto Network Replenishment
Axis	3 Axis	3 Axis	3 Axis	3 Axis	3 Axis
Audio	-	-	Audio In/Out	Audio In/Out	Audio In/Out
Alarm	-	-	Alarm In/Out	Alarm In/Out	Alarm In/Out
Rating	IP67, IK10 Vandal Proof	IP67, IK10 Vandal Proof	IP67, IK10 Vandal Proof	IP67, IK10 Vandal Proof	IP67, IK10 Vandal Proof
Power	DC 12V, PoE	DC 12V, PoE	DC 12V, PoE	DC 12V, PoE	DC 12V, PoE

Turret Fixed Lens



SKU	CMIP1022-28M	CMIP1042-28M	CMIP1042W-28MA NEW	CMIP3322W-28M CMIP3322W-M	CMIP3342W-28M CMIP3342W-M	CMIP3342WB-28M	CMIP3342W-28MA
Resolution	2MP, 1920x1080@30fps	4MP, 2560x1440@20fps	4MP, 2560x1440@20fps	2MP, 1920x1080@30fps	4MP, 2688x1520@30fps	4MP, 2688x1520@30fps	4MP, 2688x1520@30fps
Fixed Lens	2.8mm	2.8mm	2.8mm	2.8mm 4mm	2.8mm 4mm	2.8mm	2.8mm
Lux	0.028 Lux @ F2.0	0.028 Lux @ F2.0	0.01 Lux @ F2.0	0.028 Lux @ F2.0	0.028 Lux @ F2.0	0.028 Lux @ F2.0	0.018 Lux @ F1.6
Compression	H.265/H.265+	H.265/H.265+	H.265/H.265+	H.265/H.265+	H.265/H.265+	H.265/H.265+	H.265/H.265+
IR	Matrix IR LED up to 100ft	Matrix IR LED up to 100ft	Matrix IR LED up to 98ft	Matrix IR LED up to 100ft	Matrix IR LED up to 100ft	Matrix IR LED up to 100ft	Matrix IR LED up to 100ft
Audio In/Out	-	-	Built-in Microphone	-	-	-	Built-in Microphone
Storage	MicroSD Card Slot up to 256GB (Snapshot Only)		MicroSD Card Slot up to 256GB	MicroSD Card Slot up to 128GB, Auto Network Replenishment			
Features	DWDR, 3D DNR, BLC	DWDR, 3D DNR, BLC	True WDR 120dB, 3D DNR, BLC	True WDR 120dB, 3D DNR, BLC			
Rating	IP67	IP67	IP67	IP67	IP67	IP67	IP66
Power	DC 12V, PoE	DC 12V, PoE	DC 12V, PoE	DC 12V, PoE	DC 12V, PoE	DC 12V, PoE	DC 12V, PoE

Accessories for CMIP70XX

LTB701	LTB342-135	LTB342-JBOX	LTB342-135B	LTB381	LTB378	LTB379
Junction Box	Wall Mount	Junction Box for Wall Mount	Wall Mount with Junction Box	Pendant Mount 22" (56cm)	Pole Mount	Corner Mount

Accessories for CMIP72XX

LTB342-155	LTB342-JBOX	LTB781	LTB388	LTB389
Wall Mount	Junction Box for Wall Mount	Pendant Mount 22" (56cm)	Pole Mount	Corner Mount

Accessories for 10XX and 33XX

LTB03-W	LTB03-B	LTB307	LTB307B	LTB301	LTB342-JBOX	LTB371	LTB378	LTB379
Junction Box (White/Black)		Junction Box (White/Black)		Wall Mount	Junction Box for Wall Mount	Pendant Mount 21.5" (55cm)	Pole Mount	Corner Mount

PLATINUM IP CAMERA



SKU	CMIP3362W-28M CMIP3362W-M	CMIP3362WB-28M	CMIP1382W-28MA	CMIP1382NW-28MA NEW	CMIP3382NW-28M CMIP3382NW-M	CMIP3382NW-28MA
Resolution	6MP , 3072x2048@20fps	6MP , 3072x2048@20fps	8MP , 3840x2160@15fps	8MP , 3840x2160@15fps	8MP , 3840x2160@15fps	8MP , 3840x2160@15fps
Fixed Lens	2.8mm 4mm	2.8mm	2.8mm	2.8mm	2.8mm 4mm	2.8mm
Lux	0.028 lux @ F2.0	0.028 lux @ F2.0	0.01 lux @ F2.0	0.01 lux @ F2.0	0.028 lux @ F2.0	0.028 lux @ F2.0
Compression	H.265/H.265+	H.265/H.265+	H.265/H.265+	H.265/H.265+	H.265/H.265+	H.265/H.265+
IR	Matrix IR LED up to 100ft	Matrix IR LED up to 100ft	Matrix IR LED up to 98ft	Matrix IR LED up to 98ft	Matrix IR LED up to 100ft	Matrix IR LED up to 100ft
Audio In/Out	-	-	Built-in Microphone	Built-in Microphone	-	Built-in Microphone
Storage	MicroSD Card Slot up to 128GB, Auto Network Replenishment	MicroSD Card Slot up to 128GB, Auto Network Replenishment	MicroSD Card Slot up to 256GB	MicroSD Card Slot up to 256GB	MicroSD Card Slot up to 128GB, Auto Network Replenishment	MicroSD Card Slot up to 128GB, Auto Network Replenishment
Features	True WDR 120dB, 3D DNR, BLC		True WDR 120dB, 3D DNR, BLC		True WDR 120dB, 3D DNR, BLC	
Rating	IP67	IP67	IP67	IP67	IP67	IP66
Power	DC 12V, PoE	DC 12V, PoE	DC 12V, PoE	DC 12V, PoE	DC 12V, PoE	DC 12V, PoE

Turret Vari-focal Lens



SKU	CMIP1043W-MZ	CMIP1043NW-MZ NEW	CMIP3263NW-SZ	CMIP3283NW-SZ
Resolution	4MP , 2560x1440@20fps	4MP , 2560x1440@30fps	6MP , 3072x2048@20fps	8MP , 3820x2160@15fps
Vari-focal Lens	2.8 - 12mm VF Motorized Lens	2.8 - 12mm VF Motorized Lens	2.8 - 12mm VF Motorized Lens	2.8 - 12mm VF Motorized Lens
Lux	0.02 Lux @ F1.6	0.005 Lux @ F1.6	0.018 Lux @ F1.6	0.018 Lux @ F1.6
Smart Focus	Yes	Yes	Yes	Yes
Compression	H.265/H.265+	H.265/H.265+	H.265/H.265+	H.265/H.265+
IR	Matrix IR LED up to 100ft	Matrix IR LED up to 100ft	Matrix IR LED up to 100ft	Matrix IR LED up to 100ft
Storage	MicroSD Card Slot up to 128GB (Snapshot Only)	MicroSD Card Slot up to 256GB	MicroSD Card Slot up to 128GB, Auto Network Replenishment	MicroSD Card Slot up to 128GB, Auto Network Replenishment
Features	True WDR 120dB, 3D DNR, BLC	True WDR 120dB, 3D DNR, BLC	True WDR 120dB, 3D DNR, BLC	True WDR 120dB, 3D DNR, BLC
Audio In/Out	-	-	Yes	Yes
Alarm In/Out	-	-	Yes	Yes
Rating	IP67	IP67	IP67, IK10	IP67, IK10
Power	DC 12V, PoE	DC 12V, PoE	DC 12V, PoE	DC 12V, PoE

Accessories for CMIP33XX/CMIP1382NW-18MA

LTB03-W	LTB03-B	LTB307	LTB307B	LTB301	LTB342-JBOX	LTB371	LTB378	LTB379
Junction Box (White)	Junction Box (Black)	Junction Box (White)	Junction Box (Black)	Wall Mount	Junction Box for Wall Mount	Pendant Mount 21.5' (55cm)	Pole Mount	Corner Mount

Accessories for 10XX, 32XX

LTB307	LTB301	LTB342-140	LTB342-JBOX	LTB342-140B	LTB341	LTB371	LTB378	LTB379
Junction Box for CMIP10XX	Wall Mount for CMIP10XX	Wall Mount for CMIP32XX	Junction Box for Wall Mount	Wall Mount w/Junction Box for CMIP32XX	Pendant Mount for CMIP32XX (22' / 56cm)	Pendant Mount (21.5' / 55cm)	Pole Mount	Corner Mount

Mini Bullet Fixed Lens

SKU	CMIP8022-28M	CMIP8042-28M	CMIP8042W-28MA NEW	CMIP8342W-28M CMIP8342W-M	CMIP8342WB-28M	CMIP8362W-28M
Resolution	2MP , 1920x1080@30fps	4MP , 2560x1440@20fps	4MP , 2560x1440@20fps	4MP , 2688x1520@30fps	4MP , 2688x1520@30fps	6MP , 3072x2048@20fps
Fixed Lens	2.8mm	2.8mm	2.8mm	2.8mm 4mm	2.8mm	2.8mm
Lux	0.028 Lux @ F2.0	0.028 Lux @ F2.0	0.01 Lux @ F2.0	0.018 Lux @ F1.6	0.018 Lux @ F1.6	0.028 Lux @ F2.0
Compression	H.265/H.265+	H.265/H.265+	H.265/H.265+	H.265/H.265+	H.265/H.265+	H.265/H.265+
IR	Matrix IR LED up to 100ft	Matrix IR LED up to 100ft	Matrix IR LED up to 98ft	Matrix IR LED up to 100ft	Matrix IR LED up to 100ft	Matrix IR LED up to 100ft
Audio In/Out	-	-	Built-in Microphone	-	-	-
Storage	MicroSD/SDHC/SDXC Card Slot up to 128GB (Snapshot only)		MicroSD Card Slot up to 256GB	MicroSD/SDHC/SDXC Card Slot up to 128GB, Auto Network Replenishment		
Features	DWDR, 3D DNR, BLC	DWDR, 3D DNR, BLC	True WDR 120dB, 3D DNR, BLC	True WDR 120dB, 3D DNR, BLC	True WDR 120dB, 3D DNR, BLC	True WDR 120dB, 3D DNR, BLC
Rating	IP67	IP67	IP67	IP67	IP67	IP67
Power	DC 12V, PoE	DC 12V, PoE	DC 12V, PoE	DC 12V, PoE	DC 12V, PoE	DC 12V, PoE

Bullet Fixed Lens

SKU	CMIP9342W-28M CMIP9342W-M CMIP9342W-6M	CMIP9362W-28M CMIP9362W-M CMIP9362W-6M	CMIP9382NW-28M CMIP9382NW-M
Resolution	4MP , 2688x1520@30fps	6MP , 3072x2048@20fps	8MP , 3820x2160@15fps
Fixed Lens	2.8mm 4mm 6mm	2.8mm 4mm 6mm	2.8mm 4mm
Lux	0.018 Lux @ F1.6	0.028 lux @ F2.0	0.028 Lux @ F1.6
Compression	H.265/H.265+	H.265/H.265+	H.265/H.265+
IR	Matrix IR LED up to 165ft	Matrix IR LED up to 165ft	Matrix IR LED up to 165ft
Storage	MicroSD/SDHC/SDXC Card Slot up to 128GB, Auto Network Replenishment	MicroSD/SDHC/SDXC Card Slot up to 128GB, Auto Network Replenishment	MicroSD/SDHC/SDXC Card Slot up to 128GB, Auto Network Replenishment
Features	True WDR 120dB, 3D DNR, BLC	True WDR 120dB, 3D DNR, BLC	True WDR 120dB, 3D DNR, BLC
Rating	IP67	IP67	IP67
Power	DC 12V, PoE	DC 12V, PoE	DC 12V, PoE

Accessories for CMIP80XX, 83XX

LTB345	LTB345B
Junction Box (White)	Junction Box (Black)

Accessories for CMIP93XX

LTB378	LTB379
Pole Mount	Corner Mount

MSDX64GUI3CL10-CA1	MSDX128GUI3CL10-CA1	MSDX64GUI3V30G-RA1
 <ul style="list-style-type: none"> • ADATA Premier ONE 64GB/128GB microSD • 3D NAND Inside, Ultra HD 8K, 4K and 3D/VR Recording • R/W: Up to 275MB/155MB per Second • UHS-II U3 Class 10 V90 • -25°C to 85°C • Adapter Included • Lifetime Warranty 		 <ul style="list-style-type: none"> • ADATA Premier PRO 64GB microSD • MLC Inside, Ultra HD 4K Recording • R/W: Up to 95MB/90MB per Second • UHS-I U3 Class 10 V30 • -25°C to 85°C • Adapter Included • Lifetime Warranty

PLATINUM IP CAMERA



Bullet Vari-focal Lens



Junction Box Included



Junction Box Included



Junction Box Included



SKU	CMIP8043W-MZ	CMIP8043NW-MZ NEW	CMIP9743NW-SZ	CMIP9763NW-SZ	CMIP9783NW-SZ	CMIP9243-SZ NEW
Resolution	4MP , 2560x1440@20fps	4MP , 2560x1440@20fps	4MP , 2688x1520@30fps	6MP , 3072x2048@20fps	8MP , 3820x2160@15fps	4MP , 2560x1440@30fps
Varifocal Lens	2.8 - 12mm Varifocal Motorized Lens	2.8 - 12mm Varifocal Motorized Lens	2.8 - 12mm Varifocal Motorized Lens	2.8 - 12mm Varifocal Motorized Lens	2.8 - 12mm Varifocal Motorized Lens	4.7 - 94mm Auto Focus Varifocal Lens
Lux	0.018Lux @ F1.6	0.005 Lux @ F1.6	0.018 Lux @ F1.6	0.018 Lux @ F1.6	0.018 Lux @ F1.6	0.007 Lux @F1.2
Smart Focus	Yes	Yes	Yes	Yes	Yes	Yes
Compression	H.265/H.265+	H.265/H.265+	H.265/H.265+	H.265/H.265+	H.265/H.265+	H.265/H.265+
IR	Matrix IR LED up to 100ft	Matrix IR LED up to 165ft	Matrix IR LED up to 165ft	Matrix IR LED up to 165ft	Matrix IR LED up to 165ft	IR up to 492ft
Storage	MicroSD Card Slot up to 128GB (Snapshot only)	MicroSD Card Slot up to 256GB	MicroSD Card Slot up to 128GB, Auto Network Replenishment	MicroSD Card Slot up to 128GB, Auto Network Replenishment	MicroSD Card Slot up to 128GB, Auto Network Replenishment	MicroSD Card Slot up to 128GB, Auto Network Replenishment
Features	True WDR 120 dB, 3D DNR, BLC	True WDR 120 dB, 3D DNR, BLC	True WDR 120dB, 3D DNR, BLC	True WDR 120dB, 3D DNR, BLC	True WDR 120dB, 3D DNR, BLC	105dB WDR, 3D DNR, BLC
Audio, Alarm	-	-	3.5mm Audio Jack I/O, Alarm I/O	3.5mm Audio Jack I/O, Alarm I/O	3.5mm Audio Jack I/O, Alarm I/O	Audio I/O, Alarm I/O
Rating	IP67	IP67	IP67	IP67	IP67	IP67
Power	DC 12V, PoE	DC 12V, PoE	DC 12V, PoE	DC 12V, PoE	DC 12V, PoE	DC 12V, PoE

Accessories

LTB801	LTB378	LTB379
Junction Box for CMIP80XX	Pole Mount	Corner Mount

Thermal IP Camera



SKU	CMIP3T22W1-2M	CMIP9T221-3M
Image Sensor	160x120@25fps Thermal Image Sensor	160x120@25fps Thermal Image Sensor
Thermal Lens	1.8mm Fixed Lens	3.1mm Fixed Lens
Optical Resolution	1920x1080@30fps	1920x1080@30fps
Optical Lens	2.1mm Fixed Lens	4mm Fixed Lens
Storage	MicroSD Card Slot up to 256GB	MicroSD Card Slot up to 128GB
WDR	True WDR 120dB	True WDR 120dB
Rating	IP67	IP67

Accessories

LTB701	LTB801	LTB342-140
Junction Box for CMIP3TXX	Junction Box for CMIP9TXX	Wall Mount for CMIP3TXX
LTB342-JBOX	LTB342-140B	LTB341
Junction Box for Wall Mount	Wall Mount with Junction Box for CMIP3TXX	Pendant Mount (22"/56cm) for CMIP3TXX
LTB378		LTB379
Pole Mount		Corner Mount

Fisheye IP Camera

SKU	CMIP7562NF-SE	CMIP75122NF-SE
Resolution	6MP , 3072x2048@30fps	12MP , 4000x3000@20fps
Fixed Lens	1.27mm	2mm
View	360° Fisheye and 180° Panoramic View	360° Fisheye and 180° Panoramic View
Mode	Multiple Viewing Modes and Virtual PTZ	Multiple Viewing Modes and Virtual PTZ
Compression	H.265/H.265+	H.265/H.265+
IR	Low-Light, IR up to 50ft	Low-Light, IR up to 50ft
Storage	MicroSD Card Slot up to 256GB	MicroSD Card Slot up to 256GB
Features	DWDR	DWDR
Heatmap	Heat Map for Motion Analytics	Heat Map for Motion Analytics
Audio	Built-in Microphone, Audio I/O	Built-in Microphone, Audio I/O
Rating	IP67, IK10 Vandal Proof	IP67, IK10 Vandal Proof
Scenarios	Outdoor/Indoor	Outdoor/Indoor
Power	DC12V, PoE	DC12V, PoE

Accessories for Fisheye IPC

LTB756	LTB342-JBOX
Wall Mount	Junction Box for Wall Mount
LTB759	LTB755
Ceiling Mount 22" (56cm)	Inclined Ceiling/Wall Mount
LTB378	LTB379
Pole Mount	Corner Mount

License Plate Recognition IP Camera

Junction Box Included

SKU	CMIP7923LPR-22	CMIP7923WLPR-32R
Resolution	2MP , 1920x1080@30fps	2MP , 1920x1080@60fps
Varifocal Lens	6 - 22mm Auto Focus VF Motorized Lens	8 - 32mm Auto Focus VF Motorized Lens
Lux	0.005 Lux @ F1.2, 0 Lux with White Light	0.002 Lux @ F1.2, 0 Lux with IR
IR	4 White Lights for Night Vision	Matrix IR up to 328ft
Features	True WDR 120dB, 3D DNR, BLC, HLC	True WDR 140dB, BLC, HLC
License Plate Recognition	-	Capture Rate > 98%, Recognition Rate > 96%, Searchable from IP Camera & NVR
Storage	MicroSD Card Slot up to 128GB	MicroSD Card Slot up to 256GB
Audio	1 Input (Line in/Mic in), 1 Output, Terminal Block	-
Alarm	1 Input, 1 Output, Terminal Block	2 Input, 2 Output
Rating	IP67, IK10	IP67, IK10

Accessories for License Plate IPC

LTB801	LTB378	LTB379
Junction Box for CMIP7923LPR-22	Pole Mount	Corner Mount

Multi-lens IP Camera



SKU	CMIP7553W4-SZ8
Resolution	20MP Multi-Lens (4 x 5MP), 2560x1920@25fps
Variofocal Lens	2.8 - 8mm Motorized Lens, Auto Focus, 4 Flexible Lens
Compression	Advanced Compression H.265/H.265+
Features	True WDR 120dB, IR up to 98ft(30m), BLC, HLC, 3D DNR, Defog, EIS
Storage	MicroSD Card Slot up to 128GB, Auto Network Replenishment
Audio	1 Input (line in), 1 Output (line out), Mono Sound
Alarm	2 Inputs, 2 Outputs
Outdoor Rating	IP67
Vandal Proof	IK10
Power	DC12V/AC 24V, 22W; PoE+ (802.3at), 19W Class4

Covert IP Camera



SKU	CMIP182W-28
Resolution	2MP , 1920x1080@30fps Pinhole Camera
Fixed Lens	2.8mm Fixed Lens
Compression	H.265/H.265+
Features	True WDR 120dB
Audio	1 Input (line in)
Power	DC12V

Accessories for Multi-lens IPC

LTB762N	LTB751-20	LTB751	LTB742	LTB397	LTB378
Wall Mount	Pendant Mount 7.8" (20cm)	Pendant Mount 20" (50cm)	Parapet Wall Mount	Corner Mount	Pole Mount

Palm-size PTZ IP Camera



SKU	PTZIP202WX4IR	PTZIP204WX4IR	PTZIP204NW-X4IR
Resolution	2MP , 1920x1080P@30fps	4MP , 2560x1440P@30fps	
Image Sensor	1/3" CMOS	1/3" CMOS	
Compression	H.265/H.265+/H.264/H.264+	H.265/H.265+/H.264/H.264+	
Lux	0.005 Lux @ F1.6 Ultra Low Lux	0.005 Lux @ F1.6 Ultra Low Lux	
Lens & Zoom	2.8 - 12mm, 4x Optical Zoom, Auto Focus	2.8 - 12mm, 4x Optical Zoom, Auto Focus	
IR Technology	IR LEDs up to 66ft, Auto Intensity Adjustment	IR LEDs up to 66ft, Auto Intensity Adjustment	
Movement Range	Pan 0° to 330°, Tilt 0° to 90°	Pan 0° to 330°, Tilt 0° to 90°	
Features	True WDR 120dB, 3D DNR, HLC, BLC, EIS	True WDR 120dB, 3D DNR, HLC, BLC, EIS	
Audio	Audio I/O	Audio I/O	
Storage	MicroSD Card Slot up to 256GB, ANR	MicroSD Card Slot up to 256GB, ANR	
Outdoor Rating	IK10 Vandal Proof, IP66, Lightning/Surge Protection	IK10 Vandal Proof, IP66, Lightning/Surge Protection	
Power	DC 12V, PoE (802.3 af) Max 12W	DC 12V, PoE (802.3 af) Max 12W	
Dimensions	2.5" (Φ) Outdoor/Indoor	2.5" (Φ) Outdoor/Indoor	
Accessory	PoE Injector and Wall Mount (LTB202) Sold Separately	PoE Injector and Wall Mount (LTB202) Sold Separately	

Accessories

LTB202
Wall Mount
LTB773
Pendant Mount 7.8" (20cm)
LTB774
Pendant Mount 78" (200cm)



SKU	PTZIP412X15WIR	PTZIP414X25WIR PTZIP414NW-X25IR	PTZIP514X25WIR	PTZIP772X32WIR	PTZIP688X36
Resolution	2.1MP 1080P, 1920x1080P@30fps	4MP , 2560x1440@30fps	4MP , 2560x1440@30fps	2.1MP 1080P, 1920x1080P@60fps	4K/8MP , 4096x2160@30fps
Image Sensor	1/2.8" CMOS	1/2.5" CMOS	1/2.8" CMOS	1/2.8" CMOS	2/3" CMOS
Lens & Zoom	5 - 75mm, 15x Optical Zoom, Auto Focus	4.8 - 120mm, 25x Optical Zoom, Auto Focus	4.8 - 120mm, 25x Optical Zoom, Auto Focus	4.8 - 153mm, 32x Optical Zoom, Auto Focus	7.5 - 270mm, 36x Optical Zoom, Auto Focus
Lux	0.005 Lux @ F1.6 Ultra Low Lux	0.005 Lux @ F1.6 Ultra Low Lux	0.005 Lux @ F1.6 Ultra Low Lux	0.005 Lux @ F1.6 Ultra Low Lux	0.005 Lux @ F1.6 Ultra Low Lux
Compression	H.265/H.265+/H.264/H.264+	H.265/H.265+/H.264/H.264+	H.265/H.265+/H.264/H.264+	H.265/H.265+/H.264/H.264+	H.265/H.265+/H.264/H.264+
IR Technology	IR LEDs up to 164ft, Auto Intensity Adjustment	IR LEDs up to 164ft, Auto Intensity Adjustment	IR LEDs up to 492ft, Auto Intensity Adjustment	IR LEDs up to 492ft, Auto Intensity Adjustment	-
Smart Tracking	Yes	Yes	Yes	Yes	Yes
Storage	MicroSD Card Slot up to 256GB, Auto Network Replenishment	MicroSD Card Slot up to 256GB, Auto Network Replenishment	MicroSD Card Slot up to 256GB, Auto Network Replenishment	MicroSD Card Slot up to 256GB, Auto Network Replenishment	MicroSD Card Slot up to 256GB, Auto Network Replenishment
Movement Range	-5° to 90°(Auto-flip)	-5° to 90°(Auto-flip)	-15° to 90°(Auto-flip)	-15° to 90°(Auto-flip)	-20° to 90°(Auto-flip)
Image Enhancement	True WDR 120dB, 3D DNR, HLC, BLC, Defog, EIS	True WDR 120dB, 3D DNR, HLC, BLC, Defog, EIS	True WDR 120dB, 3D DNR, HLC, BLC, Defog, EIS	True WDR 120dB, 3D DNR, HLC, BLC, Defog, EIS	DWDR, 3D DNR, HLC, BLC, Defog
Audio & Alarm	Audio I/O, Alarm I/O	Audio I/O, Alarm I/O	Audio I/O, Alarm I/O	Audio I/O, Alarm I/O	Audio I/O, Alarm I/O
Outdoor Rating	IK10, IP66 Lightning/Surge Protection	IK10, IP66 Lightning / Surge Protection	IP66 Lightning / Surge Protection	IP66 Lightning / Surge Protection	IK10, IP67 Lightning / Surge Protection
Power	DC 12V, PoE+(802.3 at, class4), Max 18W	DC 12V, PoE+(802.3 at, class4), Max 18W	AC 24V, High PoE Max 40W	AC 24V, High PoE Max 40W	AC 24V, High PoE Max 50W
Dimensions	4" (Φ)	4" (Φ)	5" (Φ)	7" (Φ)	6" (Φ)
Accessories	Wall Mount Bracket (LTB412) Included, PoE+ (30W) Sold Separately		Wall Mount Bracket (LTB762N) Included, High PoE Injector (60W) Sold Separately	Wall Mount Bracket (LTB762N) Included, High PoE Injector (60W) Included	Wall Mount Bracket (LTB688-B) Included, High PoE Injector (60W) Sold Separately

Accessories

LTB762N	LTB412	LTB342-JBOX	
Wall Mount for PTZ51XX/PTZIP77XX	Wall Mount for PTZIP41XX	Junction Box for Wall Mount LTB412	
LTB378	LTB397	LTB751-20	
Pole Mount	Corner Mount	Pendant Mount 7.8" (20cm)	
LTB751	LTB742	POE-I100GH	POE-PTZP160N
Pendant Mount 20" (50cm)	Parapet Wall Mount	PoE+ (30W)	High PoE + (60W)

PLATINUM DVR

5-in-1 DVR

Supports All Video Formats

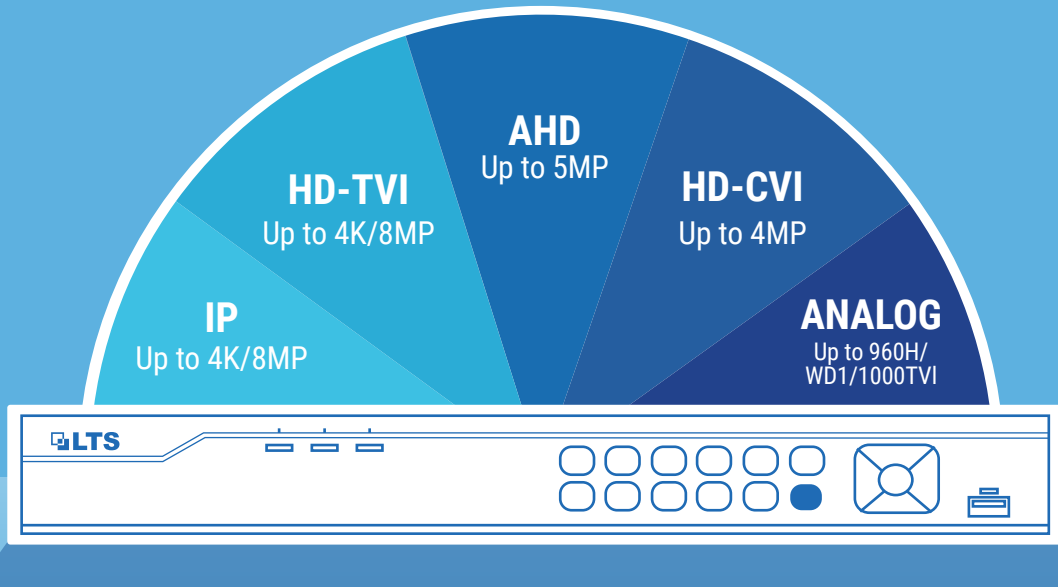

SKU	LTD8304K-ET	LTD8308K-ETC	LTD8316K-ET	LTD8304M-ET NEW	LTD8308M-ETC NEW	LTD8316M-ET NEW
Series	Advanced Level	Advanced Level	Advanced Level	Advanced Level	Advanced Level	Advanced Level
Analog Video Input	4CH (TVI/AHD/CVI/960H) Channel 1 up to 4MP	8CH (TVI/AHD/CVI/960H) Channel 1&2 up to 4MP	16CH (TVI/AHD/CVI/960H) Channel 1-4 up to 4MP	4CH (TVI/AHD/CVI/960H), up to 4MP	8CH (TVI/AHD/CVI/960H), up to 4MP	16CH (TVI/AHD/CVI/960H), up to 4MP
Record Rate	4MP Lite@15fps, 1080P@15fps	4MP Lite@15fps, 1080P@15fps	4MP Lite@15fps, 1080P@15fps	4MP Lite@15fps, 1080P@15fps	4MP Lite@15fps, 1080P@15fps	4MP Lite@15fps, 1080P@15fps
IPC Input	1CH (up to 5CH), up to 6MP Enhanced IP Mode On: 2CH (up to 6CH), up to 4MP	2CH (up to 10CH), up to 6MP Enhanced IP Mode On: 4CH (up to 12CH), up to 4MP	2CH (up to 18CH), up to 6MP Enhanced IP Mode On: 8CH (up to 24CH), up to 4MP	1CH (up to 5CH), up to 6MP Enhanced IP Mode On: 2CH (up to 6CH), up to 4MP	2CH (up to 10CH), up to 6MP Enhanced IP Mode On: 4CH (up to 12CH), up to 4MP	2CH (up to 18CH), up to 6MP Enhanced IP Mode On: 8CH (up to 24CH), up to 4MP
Video Output	VGA/HDMI up to 1920x1080P, CVBS	VGA/HDMI up to 1920x1080P, CVBS	HDMI up to 4K (3840x2160)/ VGA up to 1080P, CVBS	VGA/HDMI up to 1920x1080P, CVBS	VGA/HDMI up to 1920x1080P, CVBS	VGA/HDMI up to 1920x1080P, CVBS
Decoding Format	H.265/H.265+/H.264/H.264+	H.265/H.265+/H.264/H.264+	H.265/H.265+/H.264/H.264+	H.265/H.265+/H.264/H.264+	H.265/H.265+/H.264/H.264+	H.265/H.265+/H.264/H.264+
Deep Learning Support	-	-	-	2CH Human/Vehicle Detection	4CH Human/Vehicle Detection	4CH Human/Vehicle Detection
Playback Channel	4CH	8CH	16CH	4CH	8CH	16CH
Audio In/Out	1CH/1CH, RCA	1CH/1CH, RCA	1CH/1CH, RCA	1CH/1CH, RCA	1CH/1CH, RCA	1CH/1CH, RCA
Alarm In/Out	-	-	-	-	-	-
Network	10/100M, 1 RJ45	10/100M, 1 RJ45	10/100/1000M, 1 RJ45	10/100M, 1 RJ45	10/100M, 1 RJ45	10/100/1000M, 1 RJ45
Storage	1 SATA up to 10TB	1 SATA up to 10TB	2 SATA up to 20TB	1 SATA up to 10TB	1 SATA up to 10TB	2 SATA up to 20TB
PTZ	1 RS485	1 RS485	1 RS485	1 RS485	1 RS485	1 RS485
Support POS#	-	-	-	-	-	-
USB	2 USB 2.0	2 USB 2.0	1 USB 2.0, 1 USB 3.0	2 USB 2.0	2 USB 2.0	1 USB 2.0, 1 USB 3.0
Dimensions	12.4"(W)x9.1"(D)x1.8"(H)	12.4"(W)x9.5"(D)x1.8"(H)	15"(W)x12.6"(D)x1.9"(H)	12.4"(W)x9.5"(D)x1.8"(H)	12.4"(W)x9.5"(D)x1.8"(H)	15"(W)x12.6"(D)x1.9"(H)



SKU	LTD8504K-ST	LTD8508K-ST	LTD8516K-ST	LTD8504K-DT	LTD8504M-ST NEW	LTD8508M-ST NEW	LTD8516M-ST NEW
Series	Professional Level	Professional Level	Professional Level	Professional Level	Professional Level	Professional Level	Professional Level
Analog Video Input	4CH (HD-TVI/AHD/CVI/960H)	8CH (HD-TVI/AHD/CVI/960H)	16CH (HD-TVI/AHD/CVI/960H)	4CH (HD-TVI/AHD/CVI/960H)	4CH (HD-TVI/AHD/CVI/960H)	8CH (HD-TVI/AHD/CVI/960H)	16CH (HD-TVI/AHD/CVI/960H)
Analog Input	5MP@12fps / 2MP@30fps	8MP@8fps / 5MP@12fps / 2MP@30fps	8MP@8fps / 5MP@12fps / 2MP@30fps	5MP@12fps / 2MP@30fps	1st CH up to 8MP Lite@8fps / 5MP@12fps / 2MP@30fps	8MP@8fps / 5MP@12fps / 2MP@30fps	8MP@8fps / 5MP@12fps / 2MP@30fps
IPC Input	2CH (up to 6CH), up to 8MP Enhanced IP Mode On: 4CH (up to 8CH), up to 4MP	4CH (up to 12CH), up to 8MP Enhanced IP Mode On: 8CH (up to 16CH), up to 4MP	8CH (up to 24CH), up to 8MP Enhanced IP Mode On: 16CH (up to 32CH), up to 4MP	2CH (up to 6CH), up to 8MP Enhanced IP Mode On: 4CH (up to 8CH), up to 4MP	2CH (up to 6CH), up to 8MP Enhanced IP Mode On: 4CH (up to 8CH), up to 4MP	4CH (up to 12CH), up to 8MP Enhanced IP Mode On: 8CH (up to 16CH), up to 4MP	8CH (up to 24CH), up to 8MP Enhanced IP Mode On: 16CH (up to 32CH), up to 4MP
Video Output	HDMI/VGA up to 1080P, CVBS	HDMI up to 4K (3840x2160)/VGA up to 1080P, CVBS	HDMI up to 4K (3840x2160)/VGA up to 1080P, CVBS	HDMI/VGA up to 1080P, CVBS	HDMI up to 2K (2560x1440)/VGA up to 1080P, CVBS	HDMI up to 4K (3840x2160)/VGA up to 1080P, CVBS	HDMI up to 4K (3840x2160)/VGA up to 1080P, CVBS
Decoding Format	H.265/H.265+/H.264/H.264+	H.265/H.265+/H.264/H.264+	H.265/H.265+/H.264/H.264+	H.265/H.265+/H.264/H.264+	H.265/H.265+/H.264/H.264+	H.265/H.265+/H.264/H.264+	H.265/H.265+/H.264/H.264+
Deep Learning Support	-	-	-	4CH Human/Vehicle Detection	2CH Human/Vehicle Detection	4CH Human/Vehicle Detection	4CH Human/Vehicle Detection
Playback Channel	4CH	8CH	16CH	4CH	4CH	8CH	16CH
Audio In/Out	4CH/1CH, RCA	4CH/1CH, RCA	4CH/1CH, RCA	4CH/1CH, RCA	1CH/1CH, RCA	1CH/1CH, RCA	1CH/1CH, RCA
Alarm In/Out	4/1	8/4	16/4	4/1	-	-	-
Network	10/100/1000Mbps, 1 RJ45	10/100/1000Mbps, 1 RJ45	10/100/1000Mbps, 1 RJ45	10/100/1000Mbps, 1 RJ45	10/100Mbps, 1 RJ45	10/100/1000Mbps, 1 RJ45	10/100/1000Mbps, 1 RJ45
Storage	1 SATA up to 10TB, NAS, IP SAN	2 SATA up to 20TB, NAS, IP SAN	2 SATA up to 20TB, NAS, IP SAN	1 SATA up to 10TB, NAS, IP SAN	1 SATA up to 10TB, NAS, IP SAN	2 SATA up to 20TB, NAS, IP SAN	2 SATA up to 20TB, NAS, IP SAN
PTZ	1 RS485	1 RS485	1 RS485	1 RS485	1 RS485	1 RS485	1 RS485
Support POS#	-	-	2 (TCP)	-	-	-	2 (TCP)
USB	2 USB 2.0	1 USB 2.0, 1 USB 3.0	1 USB 2.0, 1 USB 3.0	2 USB 2.0	2 USB 2.0	1 USB 2.0, 1 USB 3.0	1 USB 2.0, 1 USB 3.0
Dimensions	12.4"(W)x9.1"(D)x1.8"(H)	15"(W)x12.4"(D)x1.8"(H)	15"(W)x12.4"(D)x1.8"(H)	12.4"(W)x9.1"(D)x1.8"(H)	12.4"(W)x9.5"(D)x1.8"(H)	15"(W)x12.6"(D)x1.9"(H)	15"(W)x12.6"(D)x1.9"(H)



SKU	LTD9224T-FA	LTD8424K-EA	LTD8432K-EA	LTD8416K-ST	LTD8424K-ST	LTD8432K-ST
Series	Enterprise Level	Enterprise Level	Enterprise Level	Enterprise Level	Enterprise Level	Enterprise Level
Analog Video Input	24CH (HD-TVI)	24CH (HD-TVI/AHD/CVI/960H)	32CH (HD-TVI/AHD/CVI/960H)	16CH (HD-TVI/AHD/CVI/960H)	24CH (HD-TVI/AHD/CVI/960H)	32CH (HD-TVI/AHD/CVI/960H)
Analog Input	2MP@15fps, 720P@30fps	2MP@30fps	2MP@30fps	8MP@8fps / 5MP@12fps / 2MP@30fps		
IPC Input	Up to 16CH 1080P@30fps	16CH (up to 40CH/48CH), up to 6MP Resolution	16CH (up to 40CH/48CH), up to 6MP Resolution	2CH up to 4K/8MP(3840x2160)	8CH up to 4K/8MP(3840x2160)	8CH up to 4K/8MP(3840x2160), Adjustable up to 40CH
Decoding Format	H.264 / H.264+	H.265/H.265+/H.264/H.264+	H.265/H.265+/H.264/H.264+	H.265/H.265+/H.264/H.264+	H.265/H.265+/H.264/H.264+	H.265/H.265+/H.264/H.264+
Video Output	HDMI1/VGA, HDMI2 up to 1080P	HDMI1/VGA1 up to 1080P, HDMI2/VGA2 up to 4K(3840x2160), CVBS (704x480)		HDMI1/VGA up to 1920x1080P, HDMI2 up to 4K (3840x2160), CVBS (704x480)		
Playback Channel	24CH	16CH	16CH	16CH	16CH	16CH
Audio In/Out	16CH/1CH, RCA	4CH/1CH, RCA	4CH/1CH, RCA	4CH/1CH, RCA	4CH/1CH, RCA	4CH/1CH, RCA
Alarm In/Out	16/8	16/4	16/4	16/4	16/4	16/4
Network	10/100/1000Mbps, 2 RJ45	10/100/1000Mbps, 1 RJ45	10/100/1000Mbps, 1 RJ45	10/100/1000Mbps, 2 RJ45	10/100/1000Mbps, 2 RJ45	10/100/1000Mbps, 2 RJ45
Storage	8 SATA up to 48TB, NAS, IP SAN	4 SATA up to 40TB, NAS, IP SAN	4 SATA up to 40TB, NAS, IP SAN	4 SATA up to 40TB, NAS, IP SAN, RAID 0, 1, 5, 6 and 10 Hot Swap		
eSATA	Support	Support	Support	Support	Support	Support
USB	3 USB 2.0	2 USB 2.0, 1 USB 3.0	2 USB 2.0, 1 USB 3.0	2 USB 2.0, 1 USB 3.0	2 USB 2.0, 1 USB 3.0	2 USB 2.0, 1 USB 3.0
PTZ	RS-485 (full-duplex), Keyboard	RS-485 (full-duplex), Keyboard	RS-485 (full-duplex), Keyboard	RS-485 (full-duplex), Keyboard	RS-485 (full-duplex), Keyboard	RS-485 (full-duplex), Keyboard
Support POS#	16 (TCP)	8 (TCP)	8 (TCP)	8 (TCP or RS232)	8 (TCP or RS232)	8 (TCP or RS232)
Dimensions	17.5"(W)x18.5"(D)x3.5"(H)	17.5"(W)x15.3"(D)x2.8"(H)	17.5"(W)x15.3"(D)x2.8"(H)	17.5"(W)x15.3"(D)x2.8"(H)	17.5"(W)x15.3"(D)x2.8"(H)	17.5"(W)x15.3"(D)x2.8"(H)

Featured Products

COLOR247 HD-TVI CAMERAS
Full Color Surveillance, Day and Night

LICENSE PLATE TRACKING HD-TVI CAMERAS
License Plate Capture with IR Up to 131ft



COLOR 247 TRUE WDR 4 FOUR



COLOR 247 TRUE WDR 4 FOUR



COLOR 247 TRUE WDR 4 FOUR



Junction Box Included

COLOR 247 TRUE WDR 4 FOUR



Junction Box Included

COLOR 247 TRUE WDR 4 FOUR

SKU	CMHT1722W-28CF CMHT1722W-CF	CMHT1752W-28CF	CMHR6422W-CF	CMHR9222W-CF	CMHR9252W-28CF
Resolution	2MP , 1920x1080@30fps	5MP , 2560x1944@20fps	2MP , 1920x1080@30fps	2MP , 1920x1080@30fps	5MP , 2560x1944@20fps
Fixed Lens	2.8mm 3.6mm	2.8mm	3.6mm	3.6mm	2.8mm
Lux	0.0005 Lux @ F1.0	0.0005 Lux @ F1.0	0.0005 Lux @ F1.0	0.0005 Lux @ F1.0	0.0005 Lux @ F1.0
IR	Clear White LEDs up to 65ft	Clear White LEDs up to 65ft	Clear White LEDs up to 65ft	Clear White LEDs up to 131ft	Clear White LEDs up to 131ft
WDR	True WDR 130dB	True WDR 130dB	True WDR 130dB	True WDR 130dB	True WDR 130dB
Output	TVI/AHD/CVI/960H Switchable	TVI/AHD/CVI/960H Switchable	TVI/AHD/CVI/960H Switchable	TVI/AHD/CVI/960H Switchable	TVI/AHD/CVI/960H Switchable
IP Rating	IP67	IP67	IP67	IP67	IP67
Power	DC 12V	DC 12V	DC 12V	DC 12V	DC 12V

Accessories

LTB03-W	LTB307	LTB301	LTB342-JBOX	LTB345
Junction Box for CMHT17XX	Junction Box for CMHT17XX	Wall Mount for CMHT17XX	Junction Box for Wall Mount	Universal Junction Box for CMHR64XX

Turret Fixed Lens

SKU	CMHT2122-28F CMHT2122B-28F	CMHT2122F CMHT2122BF	CMHT2722-28	CMHT1722B-28F CMHT1722F	CMHT1722WE-28F CMHT1722WE-F
Resolution	2MP , 1920x1080@30fps	2MP , 1920x1080@30fps	2MP , 1920x1080@30fps	2MP , 1920x1080@30fps	2MP , 1920x1080@30fps
Fixed Lens	2.8mm	3.6mm	2.8mm	2.8mm 3.6mm	2.8mm 3.6mm
Lux	0.01 Lux @ F1.2	0.01 Lux @ F1.2	0.01 Lux @ F1.2	0.01 Lux @ F1.2	0.005 Lux @ F1.2
IR	Up to 65ft	Up to 65ft	Up to 131ft	Matrix IR up to 131ft	Matrix IR up to 197ft
WDR	DWDR	DWDR	-	DWDR	True WDR 120dB
Output	TVI/AHD/CVI/960H Switchable	TVI/AHD/CVI/960H Switchable	HD-TVI	TVI/AHD/CVI/960H Switchable	TVI/AHD/CVI/960H Switchable
IP Rating	IP66	IP66	IP66	IP66	IP67
Power	DC 12V	DC 12V	DC 12V	DC 12V	DC 12V

Accessories

LTB345	LTB345B	LTB03-W	LTB03-B	LTB307	LTB307B	LTB342-110T	LTB301	LTB342-JBOX	LTB371	LTB378	LTB379
Junction Box (White/Black) for CMHT21XX		Junction Box (White/Black) for CMHT27XX, 17XX		Junction Box (White/Black) for CMHT27XX, 17XX		Wall Mount for CMHT21XX	Wall Mount for CMHT27XX, 17XX	Junction Box for Wall Mount LTB301	Pendant Mount 21.5" (55cm) for CMHT27XX, 17XX	Pole Mount	Corner Mount



SKU	CMHT1352N-28F CMHT1352N-F	CMHT1752N-28F CMHT1752N-F	CMHT1752WE-28F	CMHT1782-28F
Resolution	5MP , 2560x1944@20fps	5MP , 2560x1944@20fps	5MP , 2560x1944@20fps	8MP , 3840x2160@15fps
Fixed Lens	2.8mm 3.6mm	2.8mm 3.6mm	2.8mm	2.8mm
Lux	0.01 Lux @ F1.2	0.01 Lux @ F1.2	0.003 Lux @ F1.2	0.01 Lux @ F1.2
IR	Matrix IR up to 65ft	Matrix IR up to 131ft	Matrix IR up to 197ft	Matrix IR up to 197ft
WDR	DWDR	DWDR	True WDR 130dB	DWDR
Output	TVI/AHD/CVI/960H Switchable	TVI/AHD/CVI/960H Switchable	TVI/AHD/CVI/960H Switchable	TVI/AHD/CVI/960H Switchable
IP Rating	IP67	IP67	IP67	IP67
Power	DC 12V	DC 12V	DC 12V	DC 12V

Accessories

LTB345	LTB342-110T	LTB301	LTB307	LTB03-W	LTB371	LTB378	LTB379
Junction Box for CMHT13XX	Wall Mount for CMHT13XX	Wall Mount for CMHT17XX	Junction Box White for CMHT17XX	Junction Box for CMHT17XX	Pendant Mount 21.5" (55cm) for CMHT17XX	Pole Mount	Corner Mount

Turret Vari-focal Lens



SKU	CMHT1823	CMHT1923WE-ZF	CMHT1953N-ZF
Resolution	2MP , 1920x1080@30fps	2MP , 1920x1080@30fps	5MP , 2560x1944@20fps
Varifoca Lens	2.8 - 12mm Varifocal Lens	2.7 - 13.5mm Varifocal Motorized Lens, Auto Focus	2.7 - 13.5mm Varifocal Motorized Lens, Auto Focus
Lux	0.01 Lux @ F1.2	0.003 Lux @ F1.2	0.01 Lux @ F1.2
IR	Up to 131ft	Matrix IR up to 197ft	Matrix IR up to 131ft
WDR	-	True WDR 130dB	DWDR
Output	HD-TVI	TVI/AHD/CVI/960H Switchable	TVI/AHD/CVI/960H Switchable
IP Rating	IP66	IP67	IP67
Power	DC 12V	DC 12V	DC 12V

Accessories

LTB307	LTB307B	LTB301	LTB342-JBOX	LTB378	LTB379
Junction Box (White)	Junction Box (Black)	Wall Mount	Junction Box for Wall Mount	Pole Mount	Corner Mount

Dome Fixed Lens



SKU	CMHD7422-28 CMHD7422B-28	CMHD7422 CMHD7422B	CMHD7322WE-28F	CMHD7352N-28F	CMHD7352WE-28F	CMHD7382-28F
Resolution	2MP , 1920x1080@30fps		2MP , 1920x1080@30fps	5MP , 2560x1944@20fps	5MP , 2560x1944@20fps	8MP , 3840x2160@15fps
Fixed Lens	2.8mm	3.6mm	2.8mm	2.8mm	2.8mm	2.8mm
Lux	0.01 Lux @ F1.2		0.003 Lux @ F1.2	0.01 Lux @ F1.2	0.003 Lux @ F1.2	0.01 Lux @ F1.2
IR	Up to 65ft, Smart IR		Matrix IR up to 98ft	Matrix IR up to 65ft	Matrix IR up to 98ft	Matrix IR up to 98ft
WDR	-		True WDR 130dB	DWDR	True WDR 130dB	DWDR
Output	HD-TVI		TVI/AHD/CVI/960H Switchable	TVI/AHD/CVI/960H Switchable	TVI/AHD/CVI/960H Switchable	TVI/AHD/CVI/960H Switchable
Rating	IP66, IK10		IP67, IK10	IP67, IK10	IP67, IK10	IP67, IK10
Axis	3-Axis		3-Axis	3-Axis	3-Axis	3-Axis
Power	DC 12V		DC 12V	DC 12V	DC 12V	DC 12V

Accessories

LTB347	LTB347B	LTB349	LTB348	LTB348B	LTB342-110	LTB342-110B	LTB376	LTB378	LTB379
Junction Box (White/Black)		Angled Ceiling Mount (15°)	Wall Mount (White/Black)		Wall Mount	Wall Mount with Junction Box	Pendant Mount 22"(56cm)	Pole Mount	Corner Mount



SKU	CMHD3523DWE-ZF	CMHD3553DN-ZF
Resolution	2MP , 1920x1080@30fps	5MP , 2560x1944@20fps
Varifocal Lens	2.7 - 13.5mm Varifocal Motorized Lens, Auto Focus	2.7 - 13.5mm Varifocal Motorized Lens
Lux	0.003 Lux @ F1.2	0.01 Lux @ F1.2
IR	Matrix IR up to 197ft	Matrix IR up to 197ft
WDR	True WDR 130dB	DWDR
Output	TVI/AHD/CVI/960H Switchable	TVI/AHD/CVI/960H Switchable
Rating	IK10, IP67	IK10, IP67
Axis	3 Axis	3 Axis
Power	DC 12V, AC 24V	DC 12V, AC 24V

LTB342-140	LTB342-JBOX	LTB342-140B
Wall Mount	Junction Box for Wall Mount	Wall Mount with Junction Box
LTB378	LTB379	LTB340
Pole Mount	Corner Mount	In-Ceiling Mount



SKU	CMHR6222	CMHR6422WE-28F	CMHR6452N-28F
Resolution	2MP , 1920x1080@30fps	2MP , 1920x1080@30fps	5MP , 2560x1944@20fps
Fixed Lens	3.6mm	2.8mm	2.8mm
Lux	0.01 Lux @ F1.2	0.003 Lux @ F1.2	0.01 Lux @ F1.2
IR	IR up to 65ft	Matrix IR up to 100ft	Matrix IR up to 65ft
WDR	-	True WDR 130dB	DWDR
Output	HD-TVI	TVI/AHD/CVI/960H Switchable	TVI/AHD/CVI/960H Switchable
IP Rating	IP66	IP67	IP67
Power	DC 12V	DC 12V	DC 12V

LTB345
Junction Box (White)
LTB345B
Junction Box (Black)



SKU	CMHR9422N-F	CMHR9222WE-28F	CMHR9252N-28FN	CMHR9252N-6F	CMHR9252WE-28F	CMHR9282-28F
Resolution	2MP , 1920x1080@30fps	2MP , 1920x1080@30fps	5MP , 2560x1944@20fps	5MP , 2560x1944@20fps	5MP , 2560x1944@20fps	8MP , 3840x2160@15fps
Fixed Lens	3.6mm	2.8mm	2.8mm	6mm	2.8mm	2.8mm
Lux	0.01 Lux @ F1.2	0.003 Lux @ F1.2	0.01 Lux @ F1.2	0.01 Lux @ F1.2	0.003 Lux @ F1.2	0.01 Lux @ F1.2
IR	Matrix IR up to 131ft	Matrix IR up to 197ft	Matrix IR up to 131ft	Matrix IR up to 131ft	Matrix IR up to 197ft	Matrix IR up to 197ft
WDR	DWDR	True WDR 130dB	DWDR	DWDR	True WDR 130dB	DWDR
Output	TVI/AHD/CVI/960H Switchable	TVI/AHD/CVI/960H Switchable	TVI/AHD/CVI/960H Switchable	TVI/AHD/CVI/960H Switchable	TVI/AHD/CVI/960H Switchable	TVI/AHD/CVI/960H Switchable
IP Rating	IP67	IP67	IP67	IP67	IP67	IP67
Power	DC 12V	DC 12V	DC 12V	DC 12V	DC 12V	DC 12V
Accessory	Junction Box Included	Junction Box Included	-	Junction Box Included	Junction Box Included	Junction Box Included

Bullet Vari-focal Lens



SKU	CMHR9323D	CMHR9623DWE-ZF	CMHR9653DN-ZF	CMHR6123DWA
Resolution	2MP , 1920x1080@30fps	2MP , 1920x1080@30fps	5MP , 2560x1944@20fps	2MP , 1920x1080@30fps
Vari-focal Lens	2.8 - 12mm Varifocal Lens	2.7 - 13.5mm Varifocal Motorized Lens, Auto Focus	2.7 - 13.5mm Varifocal Motorized Lens	5 - 50mm Varifocal Lens, Auto Focus
Lux	0.01 Lux @ F1.2	0.003 Lux @ F1.2, Ultra Low Lux	0.01 Lux @ F1.2	0.01 Lux @ F1.2
IR	IR up to 165ft	Matrix IR up to 263ft	Matrix IR up to 131ft	Matrix IR up to 360ft
WDR	-	True WDR 130dB	DWDR	True WDR 120dB
Output	HD-TVI	TVI/AHD/CVI/960H Switchable	TVI/AHD/CVI/960H Switchable	HD-TVI, CVBS Output
IP Rating	IP66	IP67	IP67	IP66
Power	DC 12V, AC 24V	DC 12V, AC 24V	DC 12V, AC 24V	DC 12V, AC 24V
Accessory	Junction Box Included	Junction Box Included	Junction Box Included	Junction Box Included

License Plate Recognition HD-TVI Camera

SKU	LPR100
Resolution	1.3MP , HD License Plate Capture 1280x960@30fps
Vari-focal Lens	6 - 22mm VF Motorized Lens
Lux	0.001 Lux
IR	6 Clear White Lights up to 131ft
Feature	CVBS Output
Output	HD-TVI
Power	DC 12V
IP Rating	IP66



*LTB100 Wall Mount Included



HD-TVI Covert Camera



SKU	CM1922T	CM1924T	CM1925T-IR
Resolution	2MP , 1920x1080P@30fps	2MP , 1920x1080P@30fps	2MP , 1920x1080P@30fps
Fixed Lens	3.7mm Pinhole Lens	3.7mm Pinhole Lens	3.7mm Pinhole Lens
IR	-	-	IR LEDs up to 50ft, Smart IR
Output	TVI/AHD/CVI/960H Switchable	TVI/AHD/CVI/960H Switchable	TVI/AHD/CVI/960H Switchable
Power	DC 12V	DC 12V	DC 12V

Sapphire NVR



4K VIDEO OUTPUT AND RECORDING RESOLUTION
No More Missed Details

Sapphire IP Camera



Color247 Camera
See Nighttime and Low-Light Environments
Shine with Full Color Detail.



Starlight Camera
Get Exceptional Video Quality at Night

Network Video Recorder



SKU	LTN6104-P4	LTN6208-P8	LTN6208N-P8 NEW	LTN6216-P16	LTN6216N-P16 NEW
Video Input	4CH IP@80Mbps	8CH IP@200Mbps	8CH IP@160Mbps	16CH IP@200Mbps	16CH IP@160Mbps
Video Output	HDMI up to 4K(3840x2160) / VGA up to 1080P	HDMI up to 4K(3840x2160) / VGA up to 1080P		HDMI up to 4K(3840x2160) / VGA up to 1080P	
Max. Recording Resolution	Up to 4K, 8MP (3840x2160)	Up to 4K, 8MP (3840x2160)		Up to 4K, 8MP (3840x2160)	
Decoding Format	H.265/H.264	H.265/H.264		H.265/H.264	
Max. Playback Resolution	Up to 4K, 8MP (3840x2160)	Up to 4K, 8MP (3840x2160)		Up to 4K, 8MP (3840x2160)	
Audio In/Out	1CH/1CH, RCA	1CH/1CH, RCA		1CH/1CH, RCA	
Alarm In/Out	-	4CH/2CH		4CH/2CH	
Built-in PoE	4CH	8CH		16CH	
Network	10/100Mbps, 1 RJ45	10/100/1000Mbps, 1 RJ45		10/100/1000Mbps, 1 RJ45	
Storage	1 SATA up to 6TB	2 SATA up to 12TB		2 SATA up to 12TB	
Backup	2 USB 2.0	1 USB 2.0, 1 USB 3.0		1 USB 2.0, 1 USB 3.0	
Dimensions	10.2"(W)x8.9"(D)x1.9"(H)	14.8"(W)x12.9"(D)x2.1"(H)		14.8"(W)x12.9"(D)x2.1"(H)	



SKU	LTN6416	LTN6416-P16 NVR-P16-16P-4VA	LTN6432
Video Input	16CH IP@200Mbps	16CH IP@200Mbps	32CH IP@200Mbps
Video Output	HDMI up to 4K(3840x2160) / VGA up to 1080P	HDMI up to 4K(3840x2160) / VGA up to 1080P	HDMI up to 4K(3840x2160) / VGA up to 1080P
Max. Recording Resolution	Up to 4K, 8MP (3840x2160)	Up to 4K, 8MP (3840x2160)	Up to 4K, 8MP (3840x2160)
Decoding Format	H.265/H.264	H.265/H.264	H.265/H.264
Max. Playback Resolution	Up to 4K, 8MP (3840x2160)	Up to 4K, 8MP (3840x2160)	Up to 4K, 8MP (3840x2160)
Audio In/Out	1CH/1CH, RCA	1CH/1CH, RCA	1CH/1CH, RCA
Alarm In/Out	16CH/4CH	16CH/4CH	16CH/4CH
Built-in PoE	-	16CH	-
Network	10/100/1000Mbps, 2 RJ45	10/100/1000Mbps, 1 RJ45	10/100/1000Mbps, 2 RJ45
Storage	4 SATA up to 24TB	4 SATA up to 24TB	4 SATA up to 24TB
Backup	1 USB 2.0, 1 USB 3.0	1 USB 2.0, 1 USB 3.0	1 USB 2.0, 1 USB 3.0
Dimensions	17.3"(W)x16.2"(D)x3.0"(H)	17.3"(W)x16.2"(D)x3.0"(H)	17.3"(W)x16.2"(D)x3.0"(H)



SKU	NVR-P32-16P-4VA	LTN6832	LTN6864-R
Video Input	32CH IP@200Mbps	32CH IP@320Mbps	64CH IP@384Mbps
Video Output	HDMI up to 4K(3840x2160) / VGA up to 1080P	HDMI 1 up to 4K(3840x2160) / VGA 1 up to 1080P, HDMI 2 up to 4K(3840x2160) / VGA 2 up to 1080P	HDMI 1 up to 4K(3840x2160) / VGA 1 up to 1080P, HDMI 2 up to 4K(3840x2160) / VGA 2 up to 1080P
Max. Recording Resolution	Up to 4K, 8MP (3840x2160)	Up to 12MP	Up to 12MP
Decoding Format	H.265/H.264	Smart H.265+/H.265/Smart H.264+/H.264/MJPEG	H.265/H.264/MJPEG
Max. Playback Resolution	Up to 4K, 8MP (3840x2160)	Up to 4K, 8MP (3840x2160)	Up to 4K, 8MP (3840x2160)
Audio In/Out	1CH/1CH, RCA	1CH/1CH, RCA	1CH/1CH, RCA
Alarm In/Out	16CH/4CH	16CH/6CH	16CH/8CH
Built-in PoE	16CH	-	-
Network	10/100/1000Mbps, 1 RJ45	10/100/1000Mbps, 2 RJ45	10/100/1000Mbps, 2 RJ45
Storage	4 SATA up to 24TB	8 SATA up to 80TB, 1 eSATA	8 SATA up to 64TB, 1 eSATA, RAID 0/1/5/10
Backup	1 USB 2.0, 1 USB 3.0	2 USB 2.0, 2 USB 3.0	2 USB 2.0, 2 USB 3.0
Dimensions	17.3"(W)x16.2"(D)x3.0"(H)	17.5"(W)x17.7"(D)x3.7"(H)	17.5"(W)x18"(D)x3.7"(H)

SAPPHIRE IP CAMERA



Color247 IP Camera



SKU	LTDHIP3542NW-28ISMLC	LTDHIP3542W-36ISMLC	LTDHIP7542W-36MC	LTDHIP8542W-28MLC LTDHIP8542W-36MLC
Resolution	4MP, 2688x1520@30fps	4MP, 2688x1520@30fps	4MP, 2688x1520@30fps	4MP, 2688x1520@30fps
Fixed Lens	2.8mm	3.6mm	3.6mm	2.8mm 3.6mm
Lux	0.003 Lux @ F1.0	0.002 Lux @ F1.6	0.001 Lux @ F1.0	0.002 Lux @ F1.6
Compression	H.265+/H.265/H.264+/H.264/MJPEG	H.265+/H.265/H.264+/H.264/MJPEG	H.265+/H.265/H.264+/H.264/MJPEG	H.265+/H.265/H.264+/H.264/MJPEG
Image Sensor	1/2.7" 4MP Progressive Scan CMOS	1/1.8" 4MP Progressive Scan CMOS	1/1.8" 4MP Progressive Scan CMOS	1/1.8" 4MP Progressive Scan CMOS
Features	SMD, True WDR 120dB, LED up to 98ft	SMD, True WDR 140dB, LED up to 66ft	SMD, True WDR 140dB	SMD, True WDR 140dB, LED up to 66ft
Audio In/Out	Built-in Mic	Built-in Mic	1CH/1CH	1CH/1CH
Alarm In/Out	-	-	1CH/1CH	1CH/1CH
Storage	MicroSD Card Slot up to 256GB	MicroSD Card Slot up to 256GB	MicroSD Card Slot up to 256GB	MicroSD Card Slot up to 256GB
Rating	IP67	IP67	IP67, IK10	IP67, IK10
Accessories	Junction Box : PFA130-E Wall Mount : PFB204W	Junction Box : PFA130-E Wall Mount : PFB204W	Junction Box : PFA137 Wall Mount : PFB203W	Junction Box : PFA130-E



SMD-Push Notification

Reduce False Alarms and Receive Instant Notifications

SMD IP Camera



SKU	LTDHIP3742W-28ISMD	LTDHIP3742W-36ISMD	LTDHIP3942W-28ISMD	LTDHIP7742W-28MD	LTDHIP7742W-36MD
Resolution	4MP , 2688x1520@30fps		4MP , 2688x1520@30fps	4MP , 2688x1520@30fps	
Fixed Lens	2.8mm	3.6mm	2.8mm	2.8mm	3.6mm
Lux	0.005 Lux @ F1.6		0.005 Lux @ F1.6	0.005 Lux @ F1.6	
Compression	H.265+/H.265/H.264+/H.264/MJPEG		H.265+/H.265/H.264+/H.264/MJPEG	H.265+/H.265/H.264+/H.264/MJPEG	
Image Sensor	1/3" 4MP Progressive Scan CMOS		1/3" 4MP Progressive Scan CMOS	1/3" 4MP Progressive Scan CMOS	
Features	SMD, True WDR 120dB, IR up to 165ft		SMD, True WDR 120dB, IR up to 165ft	SMD, True WDR 120dB, IR up to 165ft	
Audio In/Out	Built-in Mic		Built-in Mic	1CH/1CH	
Alarm In/Out	-		-	1CH/1CH	
Storage	MicroSD Card Slot up to 256GB		MicroSD Card Slot up to 256GB	MicroSD Card Slot up to 256GB	
Rating	IP67, IK10		IP67, IK10	IP67, IK10	
Accessories	Junction Box : PFA130-E Wall Mount : PFB203W		Junction Box : PFA139 Wall Mount : PFB204W	Junction Box : PFA136 Wall Mount : PFB203W	

Starlight IP Camera



SKU	LTDHIP3642W-28ISM LTDHIP3642NW-28ISM LTDHIP3642NW-36ISM	LTDHIP3682NW-28ISM LTDHIP3682NW-36ISM	LTDHIP7642NW-28M LTDHIP7642NW-36M	LTDHIP7682NW-28M LTDHIP7682NW-36M	LTDHIP39222W-28ISM
Resolution	4MP , 2560x1440@30fps	8MP , 3840x2160@15fps	4MP , 2560x1440@30fps	8MP , 3840x2160@15fps	4MP Multi-Lens (2x2MP), 1920x1080@30fps
Fixed Lens	2.8mm 3.6mm	2.8mm 3.6mm	2.8mm 3.6mm	2.8mm 3.6mm	2.8mm
Lux	0.008 Lux @ F1.6	0.009 Lux @ F2.0	0.008 Lux @ F1.6	0.009 Lux @ F2.0	0.009 Lux @ F2.0
Compression	H.265+/H.265/H.264+/H.264/MJPEG	H.265+/H.265/H.264+/H.264/MJPEG	H.265+/H.265/H.264+/H.264/MJPEG	H.265+/H.265/H.264+/H.264/MJPEG	H.265/H.264H/MJPEG(Sub Stream)
Image Sensor	1/3" 4MP Progressive CMOS	1/2.7" 8MP Progressive CMOS	1/3" 4MP Progressive CMOS	1/2.7" 8MP Progressive CMOS	Two 1/2.8" 2MP Progressive CMOS
Features	True WDR 120dB, IR up to 98ft	True WDR 120dB, IR up to 98ft	True WDR 120dB, IR up to 98ft	True WDR 120dB, IR up to 98ft	True WDR 120dB, 2 x 110° Angle of View, IR up to 66ft
Audio In/Out	Built-in Mic	Built-in Mic	-	-	Built-in Mic
Storage	MicroSD Card Slot up to 256GB	MicroSD Card Slot up to 256GB	MicroSD Card Slot up to 256GB	MicroSD Card Slot up to 256GB	MicroSD Card Slot up to 128GB
Rating	IP67	IP67	IP67, IK10	IP67, IK10	IP67, IK10
Accessories	Junction Box : PFA130-E Wall Mount : PFB203W	Junction Box : PFA130-E Wall Mount : PFB203W	Junction Box : PFA136 Wall Mount : PFB203W	Junction Box : PFA136 Wall Mount : PFB203W	Junction Box : PFA137 Wall Mount : PFB203W

Dual Lens

Fixed Lens IP Camera



SKU	IP-6EB-F28-PAL IP-6EB-F36-PAL	LTDHIP3682W-4ISM IP-8EB-F40-PAL	LTDHIP7662W-28M LTDHIP7662W-36M IP-6DM-F36-PAL	IP-8DM-F40-PAL	IP-8BL-F40-PBL
Resolution	6MP , 3072x2048@20fps	8MP , 3840x2160@15fps	6MP , 3072x2048@20fps	8MP , 3840x2160@15fps	8MP , 3840x2160@15fps
Fixed Lens	2.8mm 3.6mm	4mm	2.8mm 3.6mm	4mm	4mm
Lux	0.04 Lux @ F1.6	0.07 Lux @ F2.0	0.04 Lux @ F1.6	0.07 Lux @ F2.0	0.07 Lux @ F2.0
Compression	H.265+/H.265/H.264+/H.264	H.265+/H.265/H.264+/H.264	H.265+/H.265/H.264+/H.264	H.265+/H.265/H.264+/H.264	H.265+/H.265/H.264+/H.264
Image Sensor	1/2.9" 6MP Progressive CMOS	1/2.5" 8MP Progressive CMOS	1/2.9" 6MP Progressive CMOS	1/2.5" 8MP Progressive CMOS	1/2.5" 8MP Progressive CMOS
Features	True WDR 120dB, IR up to 164ft	True WDR 120dB, IR up to 164ft	True WDR 120dB, IR up to 98ft	True WDR 120dB, IR up to 98ft	True WDR 120dB, IR up to 131ft
Audio In/Out	Built-in Mic	Built-in Mic	1CH/1CH	1CH/1CH	-
Alarm In/Out	-	-	1CH/1CH	1CH/1CH	-
Storage	MicroSD Card Slot up to 128GB	MicroSD Card Slot up to 128GB	MicroSD Card Slot up to 128GB	MicroSD Card Slot up to 128GB	MicroSD Card Slot up to 128GB
Rating	IP67	IP67	IP67, IK10	IP67, IK10	IP67
Accessories	Junction Box : PFA130-E Wall Mount : PFB204W	Junction Box : PFA130-E Wall Mount : PFB204W	Junction Box : PFA136 Wall Mount : PFB203W	Junction Box : PFA136 Wall Mount : PFB203W	Junction Box : PFA130-E

Motorized Lens IP Camera



SKU	LTDHIP3663W-ISZ	LTDHIP3683W-ISZ	LTDHIP7663W-SZ	LTDHIP7683W-SZ
Resolution	6MP , 3072x2048@20fps	8MP , 3840x2160@15fps	6MP , 3072x2048@20fps	8MP , 3840x2160@15fps
Varifocal Lens	2.7 - 13.5mm Varifocal Motorized Lens	2.7 - 12mm Varifocal Motorized Lens	2.7 - 13.5mm Varifocal Motorized Lens	2.7 - 12mm Varifocal Motorized Lens
Lux	0.03 Lux @ F1.4	0.05 Lux @ F1.4	0.03 Lux @ F1.4	0.05 Lux @ F1.4
Compression	H.265+/H.265/H.264+/H.264	H.265+/H.265/H.264+/H.264	H.265+/H.265/H.264+/H.264	H.265+/H.265/H.264+/H.264
Image Sensor	1/2.9" 6MP Progressive CMOS	1/2.5" 8MP Progressive CMOS	1/2.9" 6MP Progressive CMOS	1/2.5" 8MP Progressive CMOS
Features	True WDR 120dB, IR up to 164ft	True WDR 120dB, IR up to 164ft	True WDR 120dB, IR up to 164ft	True WDR 120dB, IR up to 164ft
Audio In/Out	Built-in Mic	Built-in Mic	1CH/1CH	1CH/1CH
Alarm In/Out	-	-	1CH/1CH	1CH/1CH
Storage	MicroSD Card Slot up to 128GB	MicroSD Card Slot up to 128GB	MicroSD Card Slot up to 128GB	MicroSD Card Slot up to 128GB
Rating	IP67	IP67	IP67, IK10	IP67, IK10
Accessories	Junction Box Included Wall Mount : PFB203W	Junction Box Included Wall Mount : PFB203W	Junction Box Included Wall Mount : PFB203W	Junction Box Included Wall Mount : PFB203W

Accessories

PFA136	PFA134	PFA130-E	PFA137	PFA139	PFB203W	PFB204W
Junction Box for LTDHIP76XX	Junction Box for LTDHIP8652W-36, LTDHCR66XX	Junction Box for LTDHIP8682, 8662, 3682, 3662, 3252, DHCT3642	Junction Box for LTDHIP39222W, LTDHIP75XXW	Junction Box for LTDHIP3942W	Wall Mount Bracket for LTDHIP76XX, LTDHIP36XX, LTDHIP32XX	Wall Mount Bracket for LTDHIP36XX, LTDHCT36XX, LTDHCT26XX

Sapphire DVR

HD-TVI | HD-CVI | IP | AHD | ANALOG

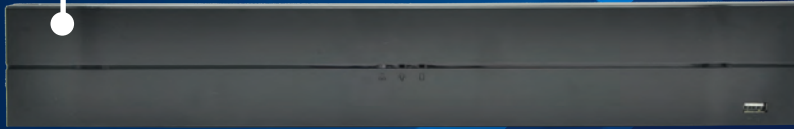

5-in-1 DVR

For All Video Formats

Penta-Brid Digital Video Recorder



H.265+ FIVE



H.265+ FIVE



H.265+ FIVE

SKU	LTD3104C-PL	LTD3108C-PL PVR-P8-1VC	LTD3216C-PL
Analog Video Input	4CH (HD-TVI/AHD/CVI/960H)	8CH (HD-TVI/AHD/CVI/960H)	16CH (HD-TVI/AHD/CVI/960H)
Record Rate	5MP-N@10fps / 4MP-N@15fps / 2MP@30fps	5MP-N@10fps / 4MP-N@15fps / 2MP@30fps	5MP-N@10fps / 4MP-N@15fps / 2MP@30fps
IPC Input	2CH (up to 6CH), Up to 6MP @24Mbps	4CH (up to 12CH), Up to 6MP @48Mbps	8CH (up to 24CH), Up to 6MP @96Mbps
Video Output	HDMI/VGA up to 1080P	HDMI/VGA up to 1080P	HDMI/VGA up to 1080P
Decoding Format	H.265+/H.265/H.264+/H.264	H.265+/H.265/H.264+/H.264	H.265+/H.265/H.264+/H.264
Playback Channel	4CH	8CH	16CH
Audio In/Out	1CH/1CH, RCA	1CH/1CH, RCA	1CH/1CH, RCA
Network	10/100Mbps, 1 RJ45	10/100Mbps, 1 RJ45	10/100/1000Mbps, 1 RJ45
Storage	1 SATA up to 10TB	1 SATA up to 10TB	2 SATA up to 20TB
PTZ	1 RS485	1 RS485	1 RS485
USB	2 USB 2.0	2 USB 2.0	1 USB 2.0, 1 USB 3.0
Dimensions	12.8"(W)x10"(D)x2.2"(H)	12.8"(W)x10"(D)x2.2"(H)	14.8"(W)x11.3"(D)x2.1"(H)



H.265+ 4K FIVE



H.265+ 4K FIVE



H.265+ 4K FIVE



H.265+ FIVE

SKU	LTD5104C-KL	LTD5208K-KL	LTD5216K-KL	LTD3432D-PL NEW
Analog Video Input	4CH (HD-TVI/AHD/CVI/960H)	8CH (HD-TVI/AHD/CVI/960H)	16CH (HD-TVI/AHD/CVI/960H)	32CH (HD-TVI/AHD/CVI/960H)
Record Rate	1st CH CVI up to 8MP@7fps / 5MP@12fps / 2MP@30fps	CVI up to 8MP@7fps / 5MP@12fps / 2MP@30fps	CVI up to 8MP@7fps / 5MP@12fps / 2MP@30fps	5MP-N@10fps / 4MP-N@15fps / 2MP@30fps
IPC Input	2CH (up to 6CH), Up to 8MP @24Mbps	4CH (up to 12CH), Up to 8MP @48Mbps	8CH (up to 24CH), Up to 8MP @96Mbps	0CH up to 32CH, Up to 8MP @128Mbps
Video Output	HDMI up to 2560x1440 / VGA up to 1080P	HDMI up to 4K / VGA up to 1080P	HDMI up to 4K / VGA up to 1080P	HDMI1 up to 4K, HDMI2/VGA up to 1080P
Decoding Format	H.265+/H.265/H.264+/H.264	H.265+/H.265/H.264+/H.264	H.265+/H.265/H.264+/H.264	AI Coding/H.265+/H.265/H.264+/H.264
SMD Support	-	-	-	16 Analog Channels + IP Channels
Playback Channel	4CH	8CH	16CH	16CH
Audio In/Out	1CH/1CH, RCA	1CH/1CH, RCA	1CH/1CH, RCA	4CH/1CH, BNC
Alarm In/Out	-	-	-	16CH/6CH
Network	10/100Mbps, 1 RJ45	10/100/1000Mbps, 1 RJ45	10/100/1000Mbps, 1 RJ45	10/100/1000Mbps, 1 RJ45
Storage	1 SATA up to 10TB	2 SATA up to 20TB	2 SATA up to 20TB	4 SATA up to 40TB, 1 eSATA
PTZ	1 RS485	1 RS485	1 RS485	1 RS485, 1 RS232
USB	2 USB 2.0	1 USB 2.0, 1 USB 3.0	1 USB 2.0, 1 USB 3.0	1 USB 2.0, 2 USB 3.0
Dimensions	12.8"(W)x10"(D)x2.2"(H)	14.8"(W)x11.3"(D)x2.1"(H)	14.8"(W)x11.3"(D)x2.1"(H)	17.32"(W)x16.54"(D)x2.99"(H)

Sapphire HD-CVI Camera

Color247 HD-CVI Camera

Monitor low-light environments with full color details



Smart Phone Connectivity

- Easy P2P
- Supports push notification
- Multi-user with different permission levels



Color247 CVI Cameras



SKU	LTDHCT3652W-28ISCF	LTDHCT3652W-36ISCF
Resolution	5MP, 2880x1620@25fps	5MP, 2592x1944@20fps
Fixed Lens	2.8mm	3.6mm
Lux	0.001 Lux @ F1.0	0.005 Lux @ F1.2
White LED	Up to 130ft	Up to 130ft
WDR	True WDR 120dB	True WDR 120dB
Audio	Built-in Mic	Built-in Mic
Output	TVI/AHD/CVI/960H Switchable	TVI/AHD/CVI/960H Switchable
Rating	IP67	IP67
Power	DC 12V	DC 12V
Accessory	Junction Box : PFA130-E Wall Mount : PFB204W	Junction Box : PFA130-E Wall Mount : PFB204W

Fixed Lens HD-CVI Camera



SKU	HC-2DM-F28-SAL		HC-4EB-F28-SAL		HC-4EB-F36-SAL	
Resolution	2MP , 1920x1080@30fps		4MP , 2560x1440@30fps		4MP , 2560x1440@30fps	
Fixed Lens	2.8mm		2.8mm		3.6mm	
Lux	0.02 Lux @ F2.0		0.03 Lux @ F2.0		0.03 Lux @ F2.0	
IR	Up to 98ft		Up to 98ft		Up to 98ft	
WDR	DWDR		DWDR		DWDR	
Output	TVI/AHD/CVI/960H Switchable		CVI/960H Switchable		CVI/960H Switchable	
Rating	IP67, IK10		IP67		IP67	
Power	DC 12V		DC 12V		DC 12V	
Accessory	Junction Box : PFA136	Wall Mount : PFB203W	Junction Box : PFA130-E	Wall Mount : PFB204W	Junction Box : PFA130-E	Wall Mount : PFB204W



SKU	LTDHCR6122-28PIR	LTDHCR6142-28PIR	LTDHCR6642-36
Resolution	2MP , 1920x1080@30fps	4MP , 2688x1520@30fps	4MP , 2560x1440@30fps
Fixed Lens	2.8mm	2.8mm	3.6mm
Lux	0.02 Lux @ F2.0	0.03 Lux @ F2.0	0.03 Lux @ F2.0
IR	PIR up to 33ft, 110 degrees, Red LED Alarm	PIR up to 33ft, 110 degrees, Red LED Alarm	Up to 66ft
WDR	DWDR	DWDR	DWDR
Output	CVI/960H Switchable	CVI/960H Switchable	CVI/960H Switchable
Rating	IP67	IP67	IP67
Power	DC 12V	DC 12V	DC 12V
Accessory	Junction Box : PFA134	Junction Box : PFA134	Junction Box : PFA134

Vari-Focal Lens HD-CVI Camera



SKU	LTDHCR9623	LTDHCR9643
Resolution	2MP , 1920x1080@30fps	4MP , 2560x1440@30fps
Varifocal Lens	2.7 - 13.5mm Varifocal Motorized Lens	2.7 - 13.5mm Varifocal Motorized Lens
Lux	0.02 Lux @ F1.3	0.03 Lux @ F1.3
IR	Up to 197ft	Up to 197ft
WDR	DWDR	DWDR
Output	CVI/960H Switchable	CVI/960H Switchable
IP Rating	IP66	IP67
Power	DC 12V	DC 12V
Accessory	Junction Box : PFA130-E	Junction Box : PFA130-E

Western Digital[®] WD PURPLE™ PRO HDD

Make Your Smart Video Smarter

Pro Performance for
Advanced Analytics

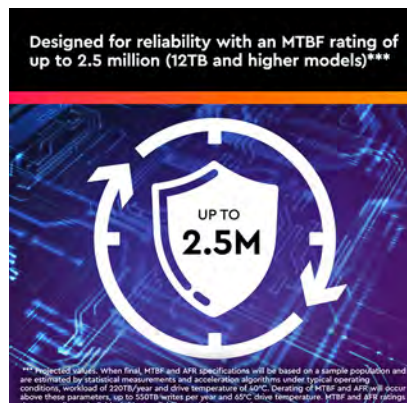



Single-Unit Outdoor Station
LTH-301M-WIFI



**EXPLORE LTS Access Control
and Intercom Solutions**



Multi-Unit Outdoor Station
LTK3410MF

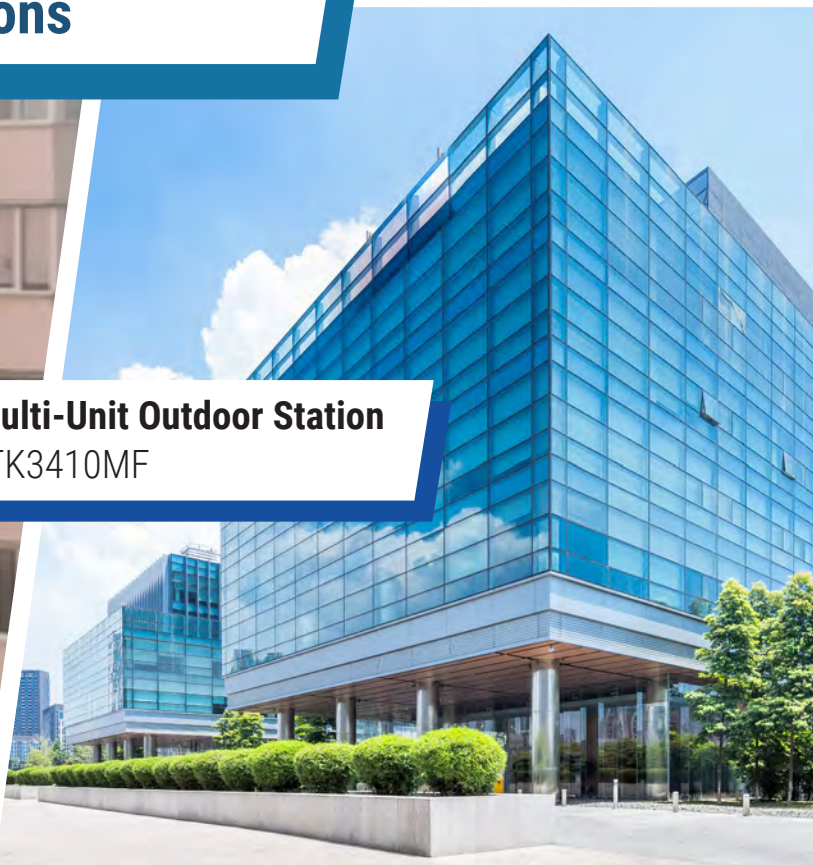

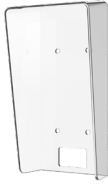

IP Intercom Single-Unit Outdoor Station

LTH-301M-WIFI / LTH-302M-WIFI	LTH-302M-PS
	
<ul style="list-style-type: none"> • 2nd Gen Door Station with True WDR 2MP IPC • Compact 4.7" x 2.2" x 0.8" Design • Mifare Reader and Programmable Calling Button • PoE or TCP/IP with DC12V, IP65 Outdoor 	<ul style="list-style-type: none"> • Protective Shield • For LTH-302M-WIFI and LTH-301M-WIFI • Clear Polycarbonate • Dimensions: 5.90" x 3.13" x 1.91" Design

IP Intercom Multi-Unit Outdoor Station

PoE Extractor for Easy Cabling

LTK3410MF	LTK3607FM	LTK-AQE30E
		
<ul style="list-style-type: none"> • 4" Touchscreen Door Station • Supports up to 500 apartment units • Facial, Card, Keyfob and Code Entry Supported • Call Residents with 4" Touchscreen Digital Keypad • Add Indoor Station for APP Access • TCP/IP, DC 12V, IP65 Outdoor • Can Program from Software or its Touch Screen • Compact 6.79" x 3.27" x 0.89" design • Add LTK-AQE30E for PoE 	<ul style="list-style-type: none"> • 7" Touchscreen Door Station • Supports up to 500 apartment units • Facial, Card, Keyfob and Code Entry Supported • Call Residents with 7" Touchscreen Digital Keypad • Add Indoor Station for APP Access • TCP/IP, DC 12V, IP 65 Outdoor • Can Program from Software or its Touch Screen • Full Size 9.41" x 4.59" x 1.30" • Add LTK-AQE30E for PoE 	<ul style="list-style-type: none"> • PoE Extractor / Splitter • Allows Powering of Non-PoE devices from a PoE Source • 12VDC Output Power Derived from PoE Source • Selectable for 13W or 25W Output • MagnaCare® Lifetime Replacement, No Fault Warranty • UL 294B Listed • UL/CUL 60950-1 • 30W IEEE 802.3at • CSA C22.2 No.205-M1983, Signal Equipment • RoHS Compliant

IP Indoor Stations

2-Wire Indoor Stations

LTH-D301GY-WIFI	LTH-D301GY-WIFI-2	LTH-MD06-2	LTH-D301-DESK
			
<ul style="list-style-type: none"> • IP Video Indoor Station • Configure with 7" Touch Screen • Manage from NVMS V3 PC • Allows APP Access for Door Stations • PoE, DC12V, Wi-Fi • Up to 6 per Apartment Unit 	<ul style="list-style-type: none"> • 2-Wire Video Indoor Station • Configure with 7" Touch Screen • Manage from NVMS V3 PC • Allows Door Station APP Access • Power & Network from MD06-2 • Up to 6 per Apartment Unit 	<ul style="list-style-type: none"> • 6-ch 2-Wire Power Distributor • Provides Power and Network • Up to 6 Indoor/Outdoor Stations • 24V DC Adaptor Included • Surface Mount Bracket Included 	<ul style="list-style-type: none"> • Desk Stand for LTH-D301GY-WIFI and LTH-D301GY-WIFI-2

2 Wire Intercom

2 Wire Intercom Single-Unit Outdoor Station

2 Wire Intercom Multi-Unit Outdoor Station



With Calling Buttons

With Physical Keypad

Main Module: LTH-M201-C-2	Surface/Flush Mount: LTH-M201-1S or LTH-M201-1F	Main Module: LTH-M201-C-2	Nametag Module: LTH-M201-6B	IP/2-Wire: LTH-M201-C-2	Keypad Module: LTH-M201-KP
		Surface/Flush Mount: LTH-M201-2S or LTH-M201-2F		Surface/Flush Mount: LTH-M201-2S or LTH-M201-2F	
<ul style="list-style-type: none"> • 2-Wire 2MP 180° Wide Angle Door Station • Adding Indoor Station allows APP Access • Ideal for Offices, Houses and Stores • Power & Data from a Single Cable • Add LTH-M201-FL for Flush Mount 		<ul style="list-style-type: none"> • 2-Wire 2MP 180° Wide Angle Door Station • Supports up to 500 Apartment Units • Call Residents with Nametag Buttons • Optional LTH-M201-6B-C to block unused buttons • Adding Indoor Station allows APP Access • Power & Data from a Single Cable • Add LTH-M201-FL for Flush Mount 		<ul style="list-style-type: none"> • 2-Wire 2MP 180° Wide Angle Door Station • Supports up to 500 Apartment Units • Call Residents with Physical Keypad • PIN Entry Supported • Adding Indoor Station allows APP Access • Power & Data from a Single Cable • Add LTH-M201-FL for Flush Mount 	

DIY Your Own 2 Wire Door Station:

Modules

LTH-M201-C-2	LTH-M201-KP	LTH-M201-6B	LTH-M201-6B-C
2-Wire Door Station Module	Keypad Module	6 Button Name Tag Module	Cover for Unused Buttons

Brackets for Modular Door Stations

LTH-M201-1S	LTH-M201-2S	LTH-M201-3S	LTH-M201-1F	LTH-M201-2F	LTH-M201-3F	LTH-M201-FL
Surface Mount, 1 Module	Surface Mount, 2 Module	Surface Mount, 3 Module	Flush Mount, 1 Module	Flush Mount, 2 Module	Flush Mount, 3 Module	Secures Flush Mounts *Free with 1F/2F/3F Bracket
*Upgraded Version with Black Backbox that can Work with LTH-M201-FL						

2-Wire Indoor Stations

IP Indoor Stations

LTH-D301GY-WIFI-2	LTH-MD06-2	LTAC1802G-CMR	LTH-D301GY-WIFI	LTH-D301-DESK
<ul style="list-style-type: none"> • 2-Wire Video Indoor Station • Configure with 7" Touch Screen • Manage from NVMS V3 PC • Allows Door Station APP Access • Power & Network from MD06-2 • Up to 6 per Apartment Unit 	<ul style="list-style-type: none"> • 6-ch 2-Wire Power Distributor • Provides Power and Network • Up to 6 Indoor/Outdoor stations • 24V DC Adaptor Included • Surface Mount Bracket Included 	<ul style="list-style-type: none"> • LTS 18/2 2 Wire Cable • 18 AWG, 2 Wires, 1000ft • For Access Control or Intercom • Stranded, Unstranded, CMR Rated 	<ul style="list-style-type: none"> • PoE Video Indoor Station • Configure with 7" Touch Screen • Manage from NVMS V3 PC • Allows Door Station APP Access • Power & Network from PoE • Up to 6 per Apartment Unit 	Desk Stand for LTH-D301GY-WIFI and LTH-D301GY-WIFI-2



Management Software Options

NVMS V3 PC Software + LTS Connect APP	XVMS-8D00R-8CAM Server/Client Software + X-VMS APP	LTKE100ME
 	 	
<ul style="list-style-type: none"> • Manage Surveillance, Access Control and Intercom • Only 1 PC for Access Control Purposes • LTS Connect APP Supports Single Door Controllers and Intercom • LTS Connect APP can Answer and Unlock Doors • Supports up to 1024 Video and 50 Door Channels • Time Attendance, E-Map 	<ul style="list-style-type: none"> • VMS for LTS Surveillance and Access Control • Supports Multiple Users from Computers and Smartphones • Controls Multi-Door+Single Door Controllers and Intercom • Operate Your Entrances from X-VMS APP Remotely • Supports up to 8 Video and 8 Door Channels • Web for Configuration, Software for Operation 	<ul style="list-style-type: none"> • LTS Mifare USB Issuer Work with PC Softwares • Supports both NVMS and X-VMS • Easy Enrolling Cards at Client PC, UL Listed

Multi-Door Controller

LTK2802	LTK2804
	
<ul style="list-style-type: none"> • LTS 2 / 4 Door Controller • Secure Metal Closure with Lock • Supports 4 Wiegand 26/34 bit Readers • Up to 10,000 Cards and 50,000 Events • Build-in 12VDC 8.5A Power Supply 	

Wireless Unlock for Any Electrified Openings

LTK-RT-1	LTK-RT-3
	
<ul style="list-style-type: none"> • Alarm Controls 1 Door Receiver-Transmitter Kit • Additional LTK-RT-1T and LTK-RT-1TW • 1 Receiver with 2 Transmitter Kit • Momentary or Alternative Mode Adjustable 	<ul style="list-style-type: none"> • Alarm Controls 3 Doors Receiver-Transmitter Kit • Additional LTK-RT-1TW • 3 Receivers with 1 Transmitter Kit • Momentary or Alternative Mode Adjustable

Card Readers for LTS Controllers

LTK1101M	LTK1101MK	LTK1107M	LTK1107MK	LTK1104M	LTK1104MK
					
<ul style="list-style-type: none"> • LTS Single Gang Reader • Wiegand 26/34 Selectable • Mifare Classic • IP 64 Weatherproof • -K Model Comes with Keypad 		<ul style="list-style-type: none"> • LTS Slim Reader • Wiegand 26/34 Selectable • Mifare Classic • IP 65 Weatherproof • -K Model Comes with Keypad 		<ul style="list-style-type: none"> • LTS Vandal-Proof Reader • Wiegand 26/34 Selectable • Mifare Classic • IP 65 Weatherproof • IK10, Metal Housing • -K Model Comes with Keypad 	

Mifare Credentials

LTKC1356M	LTKF1356M	LTKF1356M-T
		
LTS Mifare Card	LTS Mifare Keyfob	LTS Mifare Thick Keyfob
<ul style="list-style-type: none"> • 13.56 Mifare Classic • 8 Digit and 10 Digit # Printed 		

Cable for Access Control and Intercom

LTAC1802G-CMR	LTAC1806G-CMR	LTAC1822Y-CMR
		
<ul style="list-style-type: none"> • LTS 18/2 Access Control Cable • 18 AWG, 2 Wires, 1000ft • For Access Control or Intercom 	<ul style="list-style-type: none"> • LTS 18/6 Reader Cable 500ft • 18 AWG, 6 Wire • Shielded, Stranded 	<ul style="list-style-type: none"> • LTS All-in-One Banana Peel Cable 500ft • 18/4 for Maglock or Strike Power Circuit • 22/2 and 22/4 for Exit Devices or Sensors

Alarm Controls and Securitron Maglocks and Accessories

LTK-600S	LTK-1200S	LTK-600WP	LTK-1200WP	LTK-600D	LTK-1200D	LTK-AM3370	LTK-AM6370
<ul style="list-style-type: none"> Alarm Controls Maglock 600lb / 1200lb Holding Force, UL294 and UL10C Add AM3370 / AM6370 if Door Opens Inwards 		<ul style="list-style-type: none"> Alarm Controls Waterproof Maglock 600lb / 1200lb, Swinging or Sliding Gate Add AM3370/6370 as Gate Bracket 		<ul style="list-style-type: none"> Alarm Controls Double Door Maglock 600lb / 1200lb Holding Force, UL294 and UL10C Add AM3375/6375 if Door Opens Inwards Alternatively, Add 2x AM3370/6370 		<ul style="list-style-type: none"> Alarm Controls LZ Bracket For Mounting Maglocks onto Inward Swinging Doors AM3370 for 600 Series AM6370 for 1200 Series 	

Add Two Means of Egress to Your Maglock Installation

LTK-TS-2	LTK-TS-2-2	LTK-TS-2T	LTK-NTS-1	LTK-TS-14	LTK-TS-60		
<ul style="list-style-type: none"> Alarm Controls Green Push Button 2" SQ Illuminated "Push to Exit" UL294 Listed TS-2 is SPDT; TS-2-2 is DPDT TS-2T is SPDT with 2-45s Timer 		<ul style="list-style-type: none"> Alarm Control No Touch Sensor 1-35s Timer Single Gang Stainless Steel Wall Plate SPDT 		<ul style="list-style-type: none"> Alarm Control Push Button 2-60s Pneumatic Timer 1.5" Green or 2.5" Red Mushroom Button "Push To Exit" UL294 Listed SPDT 			
LTK-SREX-100		LTK-XMS		LTK-REB-1	LTKREX-W	LTKREX-B	
<ul style="list-style-type: none"> Alarm Controls REX Motion Sensor DPDT UL294 Listed, 3 Years Warranty 		<ul style="list-style-type: none"> Securitron Adjustable Pattern RTE Motion Sensor NC Only UL294 Listed, Lifetime Warranty 		<ul style="list-style-type: none"> Alarm Controls Pushbar & Door Loop DPDT 34.5" Pushbar, 18" Door Loop Included 		<ul style="list-style-type: none"> LTS Motion RTE Motion Sensor NC Only DC12V, White (-W) and Black (-B) 	

Get a Certified Power Supply that Can Integrate with Fire Alarm

LTK-AQD4-4C1R1	LTK-AQD6-8F8R2	LTK-AQL6-B100R8E1	LTK-AQS1216-16F16R2
12 or 24VDC 4A with 4 PTC Output		12VDC 16A with 16 Fuse Output	
12 or 24VDC 6A with 8 Fuse Output		12 and 24VDC 6A with 8 Fuse Output	
<ul style="list-style-type: none"> Securitron AQ Series Power Supply with MagnaCare® Lifetime Replacement, No Fault Warranty Protected Outputs with Alarm Interface, Cuts Off Power of Maglocks from the Source when Fire Alarm Triggered UL294, UL603, ULC-S318, ULC-S533 Listed RoHS Compliant and REACH Compliant 			

*All ASSA ABLLOY ESH Products, including HES, Securitron, Adams Rite and Alarm Controls products are available to order through LTS.



Select Electrical Strikes According to Existing Door Hardware

Electrical Strike for Cylindrical Latch

LTK-5000C	LTK-8000C	LTK-AES-300-12	LTK-AES-300-24	LTK-7400-628
<ul style="list-style-type: none"> HES 5000C Complete Pac 501 and 501A Face Plates Included ANSI Metal Jambos or Aluminum Frames Dual Voltage 12V/24V DC/AC UL1034, UL294 Listed 	<ul style="list-style-type: none"> HES 8000C Complete Pac 801 and 801A Face Plates Included Easy Installation, No Cutting on ANSI Frames Dual Voltage 12V/24V DC/AC UL1034, UL294 Listed 	<ul style="list-style-type: none"> Alarm Controls AES-300 Strike All Face Plates Included Ultra Compact for Minimum Wood Frame Cutting LTK-AES-300-12: 12VDC/AC LTK-AES-300-24: 24VDC/AC UL1034 Listed 	<ul style="list-style-type: none"> Adams Rite 7400 Strike Handles Up to 25lb Preload Handles Up to 25lb Pressure Exerted on Doors 12V/24V DC UL1034, UL294 Listed 	

For Mortise Latch

Most Versatile

LTK-1500C	LTK-1600CS
<ul style="list-style-type: none"> HES 1500 Strike with 1J, 1K, 1KD and 1KM Face Plates Stainless Steel Construction with 10-Year No-Fault Warranty Dual Voltage 12V/24V DC/AC UL294, UL10C 3 Hours 	<ul style="list-style-type: none"> HES 1600 Strike with Multiple Face Plates and Deadbolt Brackets Stainless Steel Construction with 10-Year No-Fault Warranty Dual Voltage 12V/24V DC/AC Accommodates Locks Designed for 4-7/8" Strike Plate UL294, UL10C 3 Hours

Add Mounting Tabs for Hollow Metal and Aluminum Door Frames

HES Strike Metal Template Kit

LTK-152	LTK-HESCUT-MTK
<ul style="list-style-type: none"> HES 152: Universal Mounting Tabs Mount Inside Hollow Metal and Aluminum Jambos Compatible with 5000, 8000, 7400, 1500, 1600 and More 	<ul style="list-style-type: none"> For Installing 1500, 1600, 1006, 4500, 5000, 5200, 7000 and 7501 Electric Strikes Meant for 4-7/8" ANSI Jamb Preparation Only Free with Purchase of Any 2 HES Strikes (Excluding 9000 Series)*

For RIM Exit Devices (Push Bar)

LTK-9400	LTK-9600	LTK-9500	LTK-9000-MTK
<ul style="list-style-type: none"> HES 9000 Series Slim-Line Strike Surface Mounted, No Cutting Needed 	<ul style="list-style-type: none"> For 1/2" Pullman Latch UL294 Listed 	<ul style="list-style-type: none"> For 3/4" Pullman Latch UL294, UL10C 3 Hours Fire Rated 	<ul style="list-style-type: none"> For Aligning Latchbolts of the Rim Exit Device with 9400, 9500, 9600, 9700 or 9800 Series Electric Strike Free with Purchase of Any 2 HES 9000 Strikes*

*All ASSA ABLOY ESH Products, including HES, Securitron, Adams Rite and Alarm Controls products are available to order through LTS.





LAVIEW AND HUGOLOG



Featured Products



**LaView**

LV-PYN11-G32		LV-PWFL6	
			
<ul style="list-style-type: none"> • 1080P HD Camera with Night Vision • 2.8mm Lens • 9600mAh Battery Recharge via USB • 32GB WD Purple Micro SD Pre-installed • 2.4GHz Wi-Fi Network • Motion Detection 	<ul style="list-style-type: none"> • Microphone and Speaker • Two-Way Audio • Cloud Storage Available • Magnetic Easy Mounting 	<ul style="list-style-type: none"> • 120° Wide View • 1080P HD Camera with 2 LED and IR • 2.8mm Lens • 2600 Lumen • AC 100-240V • 2.4GHz Wi-Fi Network 	<ul style="list-style-type: none"> • Motion Detection • Microphone and Speaker • Two-Way Audio • Cloud Storage Available
LVA-PUMSD32G-L		LVA-PUMSD64G-L	
			
<ul style="list-style-type: none"> • Ultra-Eurance for Continuous Recording • Storage: 32GB • Operating Temperature -13°F to 185°F 		<ul style="list-style-type: none"> • Ultra-Eurance for Continuous Recording • Storage: 64GB • Operating Temperature -13°F to 185°F 	
		LVA-PUMSD128G-L	
			
		<ul style="list-style-type: none"> • Ultra-Eurance for Continuous Recording • Storage: 128GB • Operating Temperature -13°F to 185°F 	

Hugolog

HU01-BLK		HU01-SNL		HU02-BLK		HU02-SNL	
							
<ul style="list-style-type: none"> • Electronic Deadbolt Lock • Door Entry with Code/Key • Motorized Auto-Locking • IP54 Waterproof 		<ul style="list-style-type: none"> • PIN entry with Physical Key Backup • 4 AA Batteries • Available in Satin Nickel or Black 		<ul style="list-style-type: none"> • Electronic Deadbolt Lock • Door Entry with Code/Key • Motorized Auto-Locking • IP54 Waterproof 		<ul style="list-style-type: none"> • PIN entry with Physical Key Backup • 4 AA Batteries • Available in Satin Nickel or Black 	
HU03-ORB		HU03-SNL		HU04-ORB		HU04-SNL	
							
<ul style="list-style-type: none"> • Smart Lock with Touchscreen • Door Entry with Code/Key • Motorized Auto-Locking • IP54 Waterproof • Remote Wireless Control Available with Free Mobile App and Bluetooth Hub • Available in Satin Nickel or Rubbed Bronze 		<ul style="list-style-type: none"> • Smart Lock with Touchscreen • Door Entry with Code/Key • Motorized Auto-Locking • IP54 Waterproof • Remote Wireless Control Available with Free Mobile App and Bluetooth Hub • Available in Satin Nickel or Rubbed Bronze 		<ul style="list-style-type: none"> • Smart Lock Bluetooth Gateway • Works with HU03 and HU04 Smart Lock • Wireless Connection to Smart Lock and Wi-Fi • Remote Control Smart Lock over Internet 			

Programming & Design
PROFESSIONAL CONSULTING AVAILABLE FOR airMAX®



Starting from \$25, Call your rep for details



SERVICE CODE :
UBNT-SERVICE

airMAX® WIRELESS

NanoBeam / LiteBeam / PowerBeam

UBNT-NBE-M5-16	UBNT-NBE-M5-19	UBNT-NBE-5AC-GEN2	UBNT-LBE-5AC-GEN2	UBNT-LAP-120-US	UBNT-PBE-5AC-GEN2
5 GHz NanoBeam M5 <ul style="list-style-type: none"> • 16dBi, 150+ Mbps, 10+ km • (1) 10/100 Ethernet Port • 35° Beamwidth • 24V, 0.2A PoE Adapter Included 	5 GHz NanoBeam M5 <ul style="list-style-type: none"> • 19dBi, 150+ Mbps, 15+ km • (1) 10/100 Ethernet Port • 25° Beamwidth • 24V, 0.2A PoE Adapter Included 	5 GHz NanoBeam AC, Gen2 <ul style="list-style-type: none"> • 19dBi, 450+ Mbps, 15+ km • (2) 10/100/1000 Ethernet Ports • Wi-Fi for Management • 15° Beamwidth • 24V, 0.5A Gigabit PoE Adapter Included 	5 GHz LiteBeam AC, Gen2 <ul style="list-style-type: none"> • 23dBi, 450+ Mbps, 10+ km • (1) 10/100/1000 Ethernet Port • 15° Beamwidth • 24V, 0.3A Gigabit PoE Adapter Included 	5 GHz LiteBeam AC AP, 120° <ul style="list-style-type: none"> • 16dBi, 450+ Mbps, 10+ km • (1) 10/100/1000 Ethernet Port • 15° Beamwidth • 24V, 0.5A Gigabit PoE Adapter Included 	5 GHz PowerBeam AC, Gen2 <ul style="list-style-type: none"> • 25dBi, 450+ Mbps, 25+ km • (1) 10/100/1000 Ethernet Port • 15° Beamwidth • 24V, 0.5A Gigabit PoE Adapter Included

NanoStation

UBNT-LOCOM2-US	UBNT-LOCOM5-US	UBNT-NSM2	UBNT-NSM5	UBNT-NS-5AC-US	UBNT-NS-WM
2.4 GHz NanoStation LocoM2 <ul style="list-style-type: none"> • 8.5dBi, 150+ Mbps, 5+ km • (1) 10/100 Ethernet Port • 60° Beamwidth • 24V, 0.2A PoE Adapter Included 	5 GHz NanoStation LocoM5 <ul style="list-style-type: none"> • 13dBi, 150+ Mbps, 10+ km • (1) 10/100 Ethernet Port • 45° Beamwidth • 24V, 0.2A PoE Adapter Included 	2.4 GHz NanoStation M2 <ul style="list-style-type: none"> • 11dBi, 150+ Mbps, 13+ km • (2) 10/100 Ethernet Ports • 55° Beamwidth • 24V, 0.2A PoE Adapter Included 	5 GHz NanoStation M5 <ul style="list-style-type: none"> • 14.6-16.1dBi, 150+ Mbps, 15+ km • (2) 10/100 Ethernet Ports • 43° Beamwidth • 24V, 0.2A PoE Adapter Included 	5 GHz NanoStation AC <ul style="list-style-type: none"> • 16dBi, 450+ Mbps, 15+ km • (2) 10/100/1000Mbps Ethernet Ports • 45° Beamwidth • 24V, 0.5A Gigabit PoE Supply Included • Wall Mount Kit (Optional) UBNT-NS-WM 	Wall Mount Kit Used for NanoStation

Rocket & Antenna













UBNT-ROCKET-M5	UBNT-R5AC-LITE	UBNT-AMO-5G10	UBNT-AMO-5G13	UBNT-UB-AM
5 GHz Rocket M5 BaseStation <ul style="list-style-type: none"> • 150+ Mbps • (1) 10/100Mbps Ethernet Port • 24V, 1A PoE Adapter Included 	5 GHz Rocket AC BaseStation <ul style="list-style-type: none"> • 500+ Mbps • (1) 10/100/1000Mbps • 24V, 0.5A Gigabit PoE Adapter Included 	5 GHz airMAX Omni Antenna <ul style="list-style-type: none"> • 10dBi • 360° Coverage, 2x2 MIMO Performance 	5 GHz airMAX Omni Antenna <ul style="list-style-type: none"> • 13dBi • 360° Coverage, 2x2 MIMO Performance 	Universal Antenna Mount

Accessories

UBNT-POE-24-12W-G UBNT-POE-24-24W-G	UBNT-N-SW	UBNT-ETH-SP-G2	UBNT-ACB-ISP	UBNT-ACB-AC
PoE Injector <ul style="list-style-type: none"> • Gigabit LAN Port • 0.5A/1.0A@24VDC • 12W/24W • Support 24V Passive PoE 	NanoSwitch <ul style="list-style-type: none"> • Outdoor 4-port Gigabit Switch with PoE Passthrough 	Ethernet Surge Protector, Gen 2	airCube ISP Home WiFi AP <ul style="list-style-type: none"> • (4) 10/100 Fast Ethernet Ports • 24V PoE Passthrough for airMAX CPE • 300Mbps@2.4 GHz • Powered by 24V Passive PoE or 2A Micro USB Adapter • Power Adapter Not Included 	airCube AC Home WiFi AP <ul style="list-style-type: none"> • (4) Gigabit Ethernet Ports • 24V PoE Passthrough for airMAX CPE • 300Mbps@2.4 GHz / 867Mbps@5 GHz • Powered by Power Adapter or PoE 24V In on LAN Port 1 • 24V, 1A PoE Adapter Included



UniFi® ROUTING SWITCHING WIRELESS

UBNT-UAP-AC-LITE-US	UBNT-UAP-AC-LR-US	UBNT-UAP-AC-PRO-US	UBNT-UAP-AC-HD-US
			
<p>UniFi AP, AC LITE</p> <ul style="list-style-type: none"> • Ø160 x 31.45mm • (1) 10/100/1000 Ethernet Port • 300Mbps@2.4GHz • 867Mbps@5GHz • 802.3af/A PoE & 24V PoE • 24V, 0.5A Gigabit PoE Adapter • Up to 400ft, Indoor • 250+ Users 	<p>UniFi AP, AC Long Range</p> <ul style="list-style-type: none"> • Ø175.7 x 43.2mm • (1) 10/100/1000 Ethernet Port • 450Mbps@2.4GHz • 867Mbps@5GHz • 802.3af/A PoE & 24V PoE • 24V, 0.5A Gigabit PoE Adapter • Up to 600ft, Indoor • 250+ Users 	<p>UniFi AP, AC PRO</p> <ul style="list-style-type: none"> • Ø196.7 x 35mm • (2) 10/100/1000 Ethernet Ports • 450Mbps@2.4GHz • 1300Mbps@5GHz • 802.3af PoE/802.3at PoE+ • UniFi Switch (PoE) • Up to 400ft, Indoor/Outdoor • 250+ Users 	<p>UniFi AP, AC HD</p> <ul style="list-style-type: none"> • Ø220 x 48.1mm • (2) 10/100/1000 Ethernet Ports • 800Mbps@2.4GHz • 1733Mbps@5GHz • 802.3af PoE • Up to 400ft, Indoor/Outdoor • 500+ Users
UBNT-UAP-AC-SHD-US	UBNT-UAP-AC-M-US	UBNT-UMA-D-US	UBNT-UAP-AC-M-PRO-US
			
<p>UniFi AP, AC SHD</p> <ul style="list-style-type: none"> • Ø220 x 48.1mm • (2) 10/100/1000 Ethernet Ports • 800Mbps@2.4GHz • 1700Mbps@5GHz • 802.3at PoE+ • UniFi Switch (PoE) • Up to 600ft Indoor/Outdoor (Covered) • 1000+ Concurrent Clients • PoE Switch Not Included 	<p>UniFi AP, AC MESH</p> <ul style="list-style-type: none"> • 139.7 x 86.7 x 25.75mm • (1) 10/100/1000 Ethernet Port • 802.3af/A PoE & 24V PoE • 24V, 0.5A Gigabit PoE Adapter • Up to 600ft, Indoor/Outdoor • 250+ Users 	<p>Directional Dual-Band Antenna</p> <ul style="list-style-type: none"> • 201.3 x 128.0 x 32.5mm • (1) 10/100/1000 Ethernet Port • Beamwidth - 2.4GHz 90°, 5GHz 45° • Indoor/Outdoor • <i>Optional Mesh Antenna Designed to Work with the UniFi® AC Mesh AP</i> 	<p>UniFi AP, AC MESH PRO</p> <ul style="list-style-type: none"> • 343.2 x 181.2 x 60.2mm • (2) 10/100/1000 Ethernet Ports • 802.3af PoE • Built-in Antenna • 48V, 0.5A PoE Gigabit Adapter (Included) • Up to 600ft, Outdoor • 250+ Users
UBNT-UAP-AC-IW	UBNT-UC-CK	UBNT-UCK-G2	UBNT-UCK-G2-PLUS
			
<p>UniFi AP, AC In-Wall</p> <ul style="list-style-type: none"> • 139.7 x 86.7 x 25.75mm • (3) 10/100/1000 Ethernet Ports • (1) Uplink, (2) Switch Ports • 300Mbps@2.4GHz • 867Mbps@5GHz • 802.3at PoE+ • UniFi PoE Switch (Not Included) • Indoor • 250+ Concurrent Clients 	<p>UniFi Cloud Key, Controller Hybrid Cloud</p> <ul style="list-style-type: none"> • 21.7 x 43.4 x 121.9mm • (1) 10/100/1000 Ethernet Port • 802.3af PoE or Micro-USB 5V, Minimum 1A • 48V 802.3af or Passive PoE • Connect up to 1 USG • Connect up to 1 USW (UniFi Switch) • Connect up to 23 Aps • 1000 Connected Clients 	<p>UniFi Cloud Key Gen2</p> <ul style="list-style-type: none"> • 27.10 x 46.80 x 119.75mm • (1) 10/100/1000 Ethernet Port • 802.3af PoE or Micro-USB 5V, Minimum 1A • Connect up to 1 USG • Connect up to 10 USW (UniFi Switch) • 2000 Connected Clients 	<p>UniFi Cloud Key Plus</p> <ul style="list-style-type: none"> • 131.16 x 27.10 x 134.20mm • (1) 10/100/1000 Ethernet Port • 802.3af PoE; Quick Charge 2.0/3.0 Power Adapter (9VDC, 2A) • Connect up to 1 USG • Connect up to 10 USW (UniFi Switch) • Connect up to 40 Aps • 2000 Connected Clients • 1 TB 2.5" SATA HDD (User-Upgradeable*)



UniFi® ROUTING SWITCHING

UBNT-USG	UBNT-USG-PRO-4-US	UBNT-US-8	UBNT-US-8-60W	UBNT-US-24	UBNT-US-48
Gateway Router <ul style="list-style-type: none"> • (3) Gigabit Ethernet Ports • (1) RJ45 Serial Port • 512 MB DDR2 RAM System Memory • 2GB On-Board Flash Storage • 7W 	Enterprise Gateway Router <ul style="list-style-type: none"> • (2) Gigabit Ethernet Ports • (2) Gigabit RJ45/SFP Combo Ports • (1) RJ45 Serial Port • 2 GB DDR3 RAM System Memory • 4 GB On-Board Flash Storage, 40W 	8 Port Managed Switch <ul style="list-style-type: none"> • (8) Gigabit Ethernet Ports • (1) PoE Passthrough Port • 12W • Power via DC 48V Power Adapter or PoE Input 	8 Port Managed Switch-4PoE <ul style="list-style-type: none"> • (8) Gigabit Ethernet Ports • (4) Auto-Sensing 802.3af PoE Ports • 15W Output per PoE Port 	24 Port Managed Switch <ul style="list-style-type: none"> • (24) Gigabit Ethernet Ports • (2) SFP Ports • (1) Serial Console Port • 25W, Rack-Mountable 	48 Port Managed Switch <ul style="list-style-type: none"> • (48) Gigabit Ethernet Ports • (2) SFP+ Ports • (2) SFP Ports • (1) Serial Console Port • 56W, Rack-Mountable
UBNT-POE-24-12W-G UBNT-POE-24-24W-G	UBNT-POE-48-24W-G	UBNT-US-8-150W-US	UBNT-US-16-150W	UBNT-US-24-250W	UBNT-US-48-500W
PoE injector <ul style="list-style-type: none"> • Gigabit LAN Port • 0.5A/1.0A @24VDC • 12W/24W • Support 24V Passive PoE 	PoE injector <ul style="list-style-type: none"> • Gigabit LAN Port • 0.5A@48VDC • 24W • Support 48V Passive PoE 	8 Port Managed PoE Switch <ul style="list-style-type: none"> • (8) Gigabit PoE Ports • (2) SFP Ports • 150W, Desktop-Mountable • Supports PoE+ IEEE 802.3at/af and 24V Passive PoE 	16 Port Managed PoE Switch <ul style="list-style-type: none"> • (16) Gigabit PoE Ports • (2) SFP Ports • (1) Serial Console Port • 150W, Rack-Mountable • Supports PoE+ IEEE 802.3at/af and 24V Passive PoE 	24 Port Managed PoE Switch <ul style="list-style-type: none"> • (24) Gigabit PoE Ports • (2) SFP Ports • (1) Serial Console Port • 250W, Rack-Mountable • Supports PoE+ IEEE 802.3at/af and 24V Passive PoE 	48 Port Managed PoE Switch <ul style="list-style-type: none"> • (48) Gigabit PoE Ports • (2) SFP+ Ports + (2) SFP Ports • (1) Serial Console Port • 500W, Rack-Mountable • Supports PoE+ IEEE 802.3at/af and 24V Passive PoE







EdgeMAX® ROUTING SWITCHING

UBNT-ER-X-US	UBNT-ER-X-SFP-US	UBNT-ERLITE-3	UBNT-ER-12	UBNT-ES-24-LITE
EdgeRouter X <ul style="list-style-type: none"> • (5) Gigabit Ethernet ports • Passive PoE Passthrough Option • 256MB RAM System Memory • 256MB Storage, 5W • Powered via 12VDC, 0.5A Power Adapter or 24V Passive PoE 	EdgeRouter X SFP <ul style="list-style-type: none"> • (5) Gigabit Ethernet Ports • Passive 24V PoE Output, 50W • (1) SFP Port • 256MB RAM System Memory • 256MB Storage, 5W 	EdgeRouter Lite <ul style="list-style-type: none"> • (3) Gigabit Ethernet Ports • (1) RJ45 Serial Port • 512 MB RAM System Memory • 2GB On-Board Flash Storage • 7W 	EdgeRouter 12 <ul style="list-style-type: none"> • (10) Gigabit Ethernet Ports • (2) SFP Ports • (1) RJ45 Serial Port • 1 GB DDR3 RAM System Memory • 4GB On-Board Flash Storage • 20W 	24 Port Managed Switch <ul style="list-style-type: none"> • (24) Gigabit Ethernet Ports • (2) SFP Ports • (1) Serial Console Port • 25W, Rack-Mountable
UBNT-ES-5XP	UBNT-ES-16-150W	UBNT-ES-24-250W	UBNT-ES-48-500W UBNT-ES-48-750W	
5 Port Managed PoE Switch XP <ul style="list-style-type: none"> • (5) Gigabit PoE Ports • (1) 10/100 Ethernet Management Port • 60W • Support 24V Passive PoE 	16 Port Managed PoE Switch <ul style="list-style-type: none"> • (16) Gigabit PoE Ports • (2) SFP Ports • (1) Serial Console Port • 150W, Rack-Mountable • Supports PoE+ IEEE 802.3at/af and 24V Passive PoE 	24 Port Managed PoE Switch <ul style="list-style-type: none"> • (24) Gigabit PoE Ports • (2) SFP Ports • (1) Serial Console Port • 250W, Rack-Mountable • Supports PoE+ IEEE 802.3at/af and 24V Passive PoE 	48 Port Managed PoE Switch <ul style="list-style-type: none"> • (48) Gigabit PoE Ports • (2) SFP+ Ports • (2) SFP Ports • (1) Serial Console Port • 500W/750W, Rack-Mountable • Supports PoE+ IEEE 802.3at/af and 24V Passive PoE 	

Unmanaged Megabit PoE Switch

Long Range Transmission for wider coverage
 Extends Distance up to 820ft. 2X Traditional PoE cabling distance
 Easy plug-and-play connection





Megabit PoE

POE-SW401N	POE-SW401S	POE-SW801N	POE-SW1602N	POE-SW2402N
				
<ul style="list-style-type: none"> • 4 Port PoE Switch with 1 Port Uplink • 60W, 802.3af/at • 10/100Mbps, Up to 820ft • UL Listed 	<ul style="list-style-type: none"> • 4 Port PoE Switch with 1 Port Uplink • 60W, 802.3af/at • 10/100Mbps, Up to 820ft • UL Listed • Network Topology Management, Alarm Push, Network Health Monitor 	<ul style="list-style-type: none"> • 8 Port PoE Switch with 1 Port Uplink • 110W, 802.3af/at • 10/100Mbps, Up to 820ft • UL Listed 	<ul style="list-style-type: none"> • 16 Port PoE Switch with 2 Gb Uplink • 230W, 802.3af/at • 10/100Mbps, Up to 820ft • UL Listed 	<ul style="list-style-type: none"> • 24 Port PoE Switch with 2 Gb Uplink and 2 SFP Ports • 370W, 802.3af/at, • 10/100Mbps, Up to 820ft • UL Listed

Unmanaged Gigabit PoE Injector/Switch

Wired connection speed up to 1,000 Mbps
 Gigabit Ethernet autosensing ports

Gigabit PoE

POE-I100GF	POE-I100GT	POE-SW802EG	POE-SW1604EG	POE-SW2404EG
				
<ul style="list-style-type: none"> • Single Port Gigabit Injector • 15W, 802.3af • 10/100/1000Mbps 	<ul style="list-style-type: none"> • Single Port Gigabit Injector • 30W, 802.3af/at • 10/100/1000Mbps 	<ul style="list-style-type: none"> • 8 Port Gigabit PoE Switch • 120W, 802.3af/at • 10/100/1000Mbps 	<ul style="list-style-type: none"> • 16 Port Gigabit PoE Switch with 4 Gb Uplink • 265W, 802.3af/at • 10/100/1000Mbps 	<ul style="list-style-type: none"> • 24 Port Gigabit PoE Switch with 4 Gb Uplink • 420W, 802.3af/at • 10/100/1000Mbps

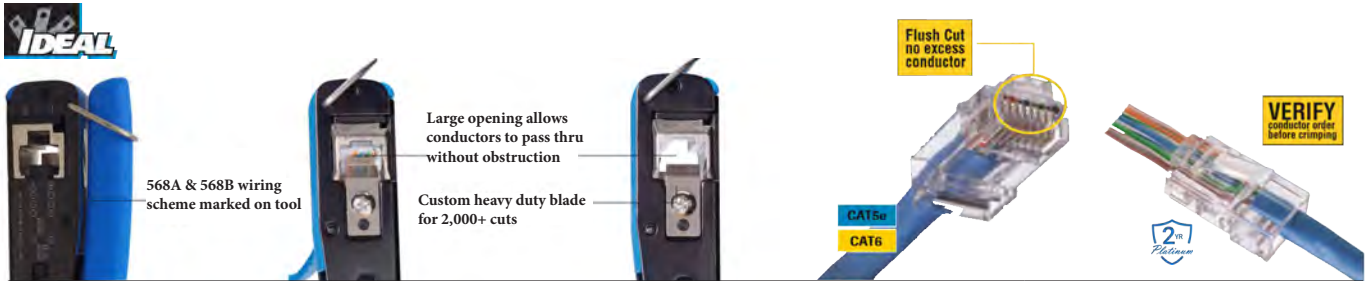

IDEAL Tools and Connectors

IDEAL-85-372E/ IDEAL-85-377E	IDEAL-30-495	IDEAL-35-088	IDEAL-45-074
 <p>*Sold Per Piece MPN #85-372 / MPN #85-377</p>	 <p>MPN #30-495</p>	 <p>MPN #35-088</p>	 <p>MPN #45-074</p>
• CAT5e/CAT6 Feed-Thru Modular Plugs	• FT-45™ Feed-Thru Modular Plug Crimp Tool Crimps Feed-Thru, Standard and Shielded	• Snips with Stripping Notch	• Data T@-Cutter
IDEAL-89-1047E	IDEAL-30-793	IDEAL-33-632	IDEAL-45-605
 <p>*Sold Per Piece MPN #89-1047</p>	 <p>MPN #30-793</p>	 <p>MPN #33-632</p>	 <p>MPN #45-605</p>
• InSITE™ RG-59 BNC Compression Connectors Window Ensures Proper Cable Insertion	• OmniSeal™ PRO XL Compression Tool	• LinearX@3 Compression Tool	• PrepPRO® Coax/UTP Cable Stripper













Testers

LTA-X48M



- 4.3" IPS Touch Screen
- 960x540 Resolution
- 5-1 Multi-Purpose Camera Tester
- 8MP IP, 5MP TVI, 4MP AHD, 4MP CVI, Analog Test
- H.265/H.264
- 4K Video Display via Mainstream
- Built-in WIFI
- HDMI Input & Output

Power Strips and Extension Cords



LTPE1610/LTPE1625 LTPE1650/LTPE16100	LTPE1225-L3/LTPE1250-L3/ LTPE12100-L3	LTPE1420-3	LTPS0802/LTPS0806/LTPS0812
 	 	 	 
• 10/25/50/100ft, 16/3C SJTW Extension Cord • Orange Single Outlet, UL Listed	• 25/50/100ft, 12/3C SJTW Extension Cord • Yellow 6ft Cord, Triple Outlet Lighted when Power is On, UL Listed	• 20ft 14/3C Indoor Extension Cord • Orange Cord, Triple Outlet with Sliding Cover Feature, UL Listed	• 8 Outlet Power Strips • White, 2/6/12ft Cord, UL Listed
LTPS0606-M	LTPS0806-M	LTPS0806-A	LTPS1215-A
	 		
• 6 Outlet Metal Case Outlet Strips • Yellow, 6ft Cord, ETL listed	• 8 Outlet Metal Case Outlet Strips • Yellow, 6ft Cord, UL listed	• 8 Way Aluminum Alloy Case Power Bar • 6ft Cord, ETL listed	• 12 Way Aluminum Alloy Case Power Bar • 15ft Cord, ETL listed







Power Adapters







PS120V0800	PS120V1000	PS120V2000	PS120V3000
<ul style="list-style-type: none"> • 800mA • DC 12V 	<ul style="list-style-type: none"> • 1000mA • DC 12V 	<ul style="list-style-type: none"> • 2000mA • DC 12V 	<ul style="list-style-type: none"> • 3000mA • DC 12V
TS5-6W	PS240V1000	PS240V3000	DV-AT12015-D01
<ul style="list-style-type: none"> • 5000mA • DC 12V 	<ul style="list-style-type: none"> • 1000mA • AC 24V 	<ul style="list-style-type: none"> • 3000mA • AC 24V 	<ul style="list-style-type: none"> • 1500mA (Max) • AC 24V to DC 12V











Power Supplies







PS120V5-D	DV-AT1207M-D09	DV-AT1209A-D9P	DV-AT1212A-D18P	DV-AT1220A-D18P	
<ul style="list-style-type: none"> • 4 Port; 5 Amp • Protection: PTC • DC 12V 	<ul style="list-style-type: none"> • 9 Port; 7 Amp • Protection: PTC • DC 12V 	<ul style="list-style-type: none"> • 9 Port; 9 Amp • Protection: PTC • DC 12V 	<ul style="list-style-type: none"> • 18 Port; 12 Amp • Protection: PTC • DC 12V 	<ul style="list-style-type: none"> • 18 Port; 20 Amp • Protection: PTC • DC 12V 	
DV-RT1224A-D24	DV-RT1232A-D32	DV-AC2408A-D07	DV-AC2412A-D10	DV-AT1205A-D07	DV-AT1209A-D9
<ul style="list-style-type: none"> • 24 Port; 24 Amp • Protection: PTC • DC 12V 	<ul style="list-style-type: none"> • 32 Port; 32 Amp • Protection: PTC • DC 12V 	<ul style="list-style-type: none"> • 9 Port; 8 Amp • Protection: PTC • AC 24V 	<ul style="list-style-type: none"> • 18 Port; 12 Amp • Protection: PTC • AC 24V 	<ul style="list-style-type: none"> • 4 Port; 5 Amp • Protection: PTC • DC 12V 	<ul style="list-style-type: none"> • 9 Port; 9 Amp • Protection: Fuse • DC 12V
DV-AT1212A-D18	DV-AT1210A-D07	DV-AT1210A-D10	DV-AT1215A-D10	DV-AT1232A-D18	DV-AT1232A-D27
<ul style="list-style-type: none"> • 18 Port; 12 Amp • Protection: Fuse • DC 12V 	<ul style="list-style-type: none"> • 9 Port; 10 Amp • Protection: Fuse • DC 12V 	<ul style="list-style-type: none"> • 18 Port; 10 Amp • Protection: Fuse • DC 12V 	<ul style="list-style-type: none"> • 18 Port; 18 Amp • Protection: Fuse • DC 12V 	<ul style="list-style-type: none"> • 18 Port; 32 Amp • Protection: Fuse • DC 12V 	<ul style="list-style-type: none"> • 27 Port; 32 Amp • Protection: Fuse • DC 12V

Passive Video Balun Transceivers		IP Passive Extender over Coax
LTAB4020T 	LTAB4030TP 	LTAB8050C 
<ul style="list-style-type: none"> • 1-Ch HD Passive Video Balun for 3/4/5MP HD-TVI, CVI, AHD and CVBS 	<ul style="list-style-type: none"> • 1-Ch HD Video & Power Balun for 3/4/5MP HD-TVI, CVI, AHD and CVBS 	<ul style="list-style-type: none"> • 1-ch Passive IP Extender over Coax • Support 8MP/4K IP Camera up to 500ft, 10/100Mbps speed







Warning Signs					DVR Lockboxes
LTSTICKER 	LTSIGNB 	LTSIGNA 	LTSIGNOD 	ACS-801 	
<ul style="list-style-type: none"> • Warning Sticker Decal • Weather-Resistant 	<ul style="list-style-type: none"> • 9"(W) x 11"(H) 	<ul style="list-style-type: none"> • 11"(W) x 18"(H) 	<ul style="list-style-type: none"> • Sign Outdoor 10.5" x 10.5" 	<ul style="list-style-type: none"> • Solar Power (No Battery Needed) • Actively Flashing LCD 	
					LT-DVRLB18-18-5 LT-DVRLB21-21-8 LT-DVRLB21-24-8 LTBHWB (Wall Mount Bracket)

Monitor Brackets				CCTV Monitors	
LTMB1026 	LTMB1737 	LTMB2655 	LTMB3270 	M-185JPGM8 	M-215JPGM8 
<ul style="list-style-type: none"> • Monitor Bracket • For 10"-26" Screen Size • Distance to Wall 35-390mm • Max Loading Weight 10Kg 	<ul style="list-style-type: none"> • Monitor Bracket • For 17"-37" Screen Size • Distance to Wall 35-380mm • Max Loading Weight 30Kg 	<ul style="list-style-type: none"> • Monitor Bracket • For 26"-55" Screen Size • Distance to Wall 7mm • Max Loading Weight 50Kg 	<ul style="list-style-type: none"> • Monitor Bracket • For 32"-70" Screen Size • Distance to Wall 70-390mm • Max Loading Weight 75Kg 	<ul style="list-style-type: none"> • Monitors Come with: Remote, BNC, HDMI & VGA Inputs 	

Connectors										
LTA1001	LTA1002	LTA1003	LTA1004	LTA1005	LTA1006	LTA1007	LTA1013	LTA1014	LTA1016	KY5E110
										
<ul style="list-style-type: none"> • BNC Twist-On RG59 Male (20pcs/pack) 	<ul style="list-style-type: none"> • BNC Male to RCA Female (20pcs/pack) 	<ul style="list-style-type: none"> • BNC Female to RCA Male (20pcs/pack) 	<ul style="list-style-type: none"> • BNC Male to RCA Male (20pcs/pack) 	<ul style="list-style-type: none"> • BNC Coupler Female to Female (20pcs/pack) 	<ul style="list-style-type: none"> • BNC Compression for RG59 (20pcs/pack) 	<ul style="list-style-type: none"> • BNC Male Crimp-on (20pcs/pack) 	<ul style="list-style-type: none"> • BNC Male to 2 BNC Female (20pcs/pack) 	<ul style="list-style-type: none"> • RJ45 8P8C Cat5e Crimp Connector 	<ul style="list-style-type: none"> • RJ45 8P8C Cat6 Crimp Connector 	<ul style="list-style-type: none"> • Enhanced Cat5e Keystone Jack

LT-CT601W/ LT-CT601B LT-CT801W/LT-CT801B LT-CT1201W/LT-CT1201B	LTAC3005/LTAC3110 LTAC3125/LTAC3150	LTA2003	LTAC3100	LTA2017 LTA2013	LTA2004 LTA2014	LTA2010 LTA2008
						
<ul style="list-style-type: none"> • Cable Tie (100 pcs/pack) • 6" White/Black • 8" White/Black • 12" White/Black 	<ul style="list-style-type: none"> • HDMI w/Ethernet • 4.5/10/25/50ft Cable • Hi-Speed 1080P/3D, 100% Triple Shield 24K • Gold Plated w/Nylon Jacket 	<ul style="list-style-type: none"> • Terminal Connector • 9 Terminal, DC & AC • Connector/Splitter 	<ul style="list-style-type: none"> • 100ft HDMI Cable • Hi-Speed 1080P with USB Booster 26AWG 	<ul style="list-style-type: none"> • DC Power Connector • LTA2017-Male • LTA2013-Female (20pcs/pack) 	<ul style="list-style-type: none"> • DC Power Adapter Cable • LTA2004-Male • LTA2014-Female (20pcs/pack) 	<ul style="list-style-type: none"> • Male/Female Pigtail • LTA2010-Male • LTA2008-Female



Cables (CAT5e, CAT6, Pre-Made Siamese, Coaxial Siamese)

LTAC5100W-CMR LTAC5100BL-CMR LTAC5100B-CMR	LTAC6250W-CMR LTAC6250BL-CMR LTAC6250B-CMR	LTAC5100B-CMX LTAC6250B-CMX	LTAC6250W-CMP LTAC6250BL-CMP
			
<ul style="list-style-type: none"> • 1000ft CAT5e 99.99% OFC • UL Listed, RoHS Compliant • ISO/IEC11801, ANSI/TIA-568B-C.2 • Pass Fluke Test • CMR Rated • White / Blue / Black 	<ul style="list-style-type: none"> • 1000ft CAT6 99.99% OFC • UL Listed, RoHS Compliant • ISO/IEC11801, ANSI/TIA-568B-C.2 • Pass Fluke Test • CMR Rated • White / Blue / Black 	<ul style="list-style-type: none"> • 1000ft CAT5e/ CAT6 99.99% OFC • ETL Listed, RoHS Compliant • ISO/IEC11801, ANSI/TIA-568B-C.2 • Pass Fluke Test • Outdoor Rated, UV Resistance • Black 	<ul style="list-style-type: none"> • 1000ft CAT6 99.99% OFC • UL Listed, RoHS Compliant • ISO/IEC11801, TIA-568-C.2 • Pass Fluke Test • Plenum Rated, CMP • White / Blue
LTAC2040 LTAC2046	LTAC2031W / LTAC2031B LTAC2033W / LTAC2033B	LTAC2030W / LTAC2030B LTAC2032W / LTAC2032B	LTAC2060W / LTAC2060B LTAC2100W / LTAC2100B LTAC2150W / LTAC2150B
			
<ul style="list-style-type: none"> • 1000ft CCA CAT5e/CAT6 • Commercial Grade Network Cable 	<ul style="list-style-type: none"> • Siamese Coaxial Cable • White / Black Bare Wire • 500ft / 1000ft RG59 Coaxial 95% Braided + 18/2 • 18 AWG CCA Cable 	<ul style="list-style-type: none"> • Siamese Coaxial Cable • White / Black Bare Wire • 500ft / 1000ft RG59 Coaxial 95% Braided + 18/2 • Solid 100% 18 AWG Oxygen Free Copper 	<ul style="list-style-type: none"> • Pre-Made HD Siamese Cable • Includes BNC and Power Connector • 60ft / 100ft / 150ft • Color: White / Black

CAT6 Patch Cable, CAT5e Pre-Made Cable

LTPC6001BL-CMR LTPC6001GN-CMR LTPC6001Y-CMR LTPC6001B-CMR LTPC6001W-CMR	LTPC6003BL-CMR LTPC6003B-CMR LTPC6003W-CMR	LTPC6005BL-CMR LTPC6005B-CMR LTPC6005W-CMR	LTPC6010BL-CMR LTPC6010B-CMR LTPC6010W-CMR	LTAC2042 LTAC2041
				
<ul style="list-style-type: none"> • 1ft CAT6 Patch Cable, 50 Micro Gold Plated 3 • Prong Connector, UL Listed, RoHS Compliant • Pass Fluke Test, CMR Rated • Blue / Green / Yellow / Black / White 	<ul style="list-style-type: none"> • 3ft CAT6 Patch Cable, 50 Micro Gold Plated 3 • Prong Connector, UL Listed, RoHS Compliant • Pass Fluke Test, CMR Rated • Blue / Black / White 	<ul style="list-style-type: none"> • 5ft CAT6 Patch Cable, 50 Micro Gold Plated 3 • Prong Connector, UL Listed, RoHS Compliant • Pass Fluke Test, CMR Rated • Blue / Black / White 	<ul style="list-style-type: none"> • 10ft CAT6 Patch Cable, 50 Micro Gold Plated • 3 Prong Connector, UL Listed, RoHS Compliant • Pass Fluke Test, CMR Rated • Blue / Black / White 	<ul style="list-style-type: none"> • Pre-Made RJ45 CAT5e Cable • LTAC2042-50ft • LTAC2041-100ft

Control Cable

LTAC1802G-CMR	LTAC1806G-CMR	LTAC1822Y-CMR
		
<ul style="list-style-type: none"> • 18 AWG / 2 Conductor Access Control Wire • 1000ft Stranded • 99.99% OFC • Access Control, Intercom and Alarm • CMR Rated, UL Listed • Color: Gray 	<ul style="list-style-type: none"> • 18 AWG 6 Conductor Control Wire • 500ft Stranded • 99.99% OFC • CMR Rated • Shielded ETL • Color: Gray 	<ul style="list-style-type: none"> • 500 ft Stranded Control Cable • 99.99% OFC • 18/4 + 22/2 + 22/4 + 22/6 Combination Cable • Shielded 22/6 • ETL Rated, CMR Rated • Color: Yellow

Try Out LTS High Quality OFC Cable

Our CAT5e and CAT 6 cables have Pass FLUKE Permanent Link Test

What is OFC?

OFC stand for Oxygen-Free Copper. Type of copper that electrolytically refined to reduce the level of oxygen to .001% or below.

Why OFC?

OFC give you high ductility, electrical and thermal conductivity.

What is FLUKE Permanet link test?

FLUKE Permanet link Test guaranteed to meet the NEXT, FEXT and Return Loss requirements of the ANSI/TIA-568-C.2 or ISO/IEC 11801:2011 for the network cables.

Cables (DC Power, VGA, Microphone)

LTA2005	LTA2006	LTA2011	LTA2018	LTAS06	LTA2001	LTA2002	LTAV3010/LTAV3025 LTAV3050/LTAV3100
<ul style="list-style-type: none"> • DC Power Splitter • 1 Female to 2 Male 	<ul style="list-style-type: none"> • DC Power Splitter • 1 Male to 2 Female 	<ul style="list-style-type: none"> • DC Power Splitter • 1 Female to 4 Male 	<ul style="list-style-type: none"> • DC Power Splitter • 1 Female to 8 Male 	<ul style="list-style-type: none"> • High Sensitivity Audio Monitor Mic • Bug Range: 30 sq. meters • Frequency: 100-5500Hz 	<ul style="list-style-type: none"> • 12" Microphone w/ Power Cable • Microphone with Amplifier 	<ul style="list-style-type: none"> • 45" Microphone w/ Video & Power • Microphone with Amplifier 	<ul style="list-style-type: none"> • VGA Extension Cable 10ft / 25ft / 50ft / 100ft

Converters, Splitters, Extenders

LTAH2100E	LTAH014LN	LTAH018L
<ul style="list-style-type: none"> • USB RJ45 Extender • UBS2, USB A Female • Plug & Play • Cable Type: CAT5, 5E, 6, UTP Extend Distance to 150ft 	<ul style="list-style-type: none"> • 1 In/4 Out HDMI Splitter • Support HDMI 1.3 • Support 1080P • HDCP & 3D Support 	<ul style="list-style-type: none"> • 1 In/8 Out HDMI Splitter • 8 Identical HDMI Outputs • Up to 225MHz • Support 3D

LTAH3100E	LTAH1070E	LTAH1070EK	LTAH5100T	LTAH5300T
<ul style="list-style-type: none"> • VGA/Audio RJ45 Extender • Video Type: VGA • Support 1920x1440 • 1x Stereo Audio (R/L) • Extend Distance to 900ft 	<ul style="list-style-type: none"> • HDMI Extender 1080P • Supports 1080P Up to 165ft • DC 5V/1A, Power Adaptor Included 	<ul style="list-style-type: none"> • HDMI Extender 4K • Supports 4K up to 115ft • Supports 1080P up to 230ft • USB 2.0, Connect with Keyboard/Mouse • Support PoE Power Supply, No Need for Extra Power at RX Side Maximum Transmission Distance is 230ft • DC12V/1A, Power Adaptor Included 	<ul style="list-style-type: none"> • HD-TVI To HDMI Converter • Input: 1xHD-TVI • Output: 1xHDMI, 1xHD-TVI Loop Out 	<ul style="list-style-type: none"> • HD-TVI Distributor • Input: 1xHD-TVI • Output: 3xHD-TVI

Tools

T201WS	T203MS	T205CM	LTA-T206S	LTA-T208CS	LTA-T207C
<ul style="list-style-type: none"> • Coaxial Cable Stripper • Cut & Strip Coaxial Cable • Durable Delrin Material • Rotating Ring 	<ul style="list-style-type: none"> • Wire Stripper • Strip Wire (12 - 22 gauge) with One Pull of Trigger • Built-in Ruler Splicer with Auto Adjust 	<ul style="list-style-type: none"> • Professional Crimping Tool • BNC Compression, F-Type, RCA Connectors • For CATV, DSS sec. and Residential Cable Connection 	<ul style="list-style-type: none"> • 4 in 1 Wire Cutter & Stripper • Easy to Strip & Cut Wire • One Lock Control (Open/Close) • AWG 24.22.20.18.16.14.12 	<ul style="list-style-type: none"> • Multi-Modular Plug Crimp, Strip and Cut Tool • Pro Modular Crimp Tool with Cut and Strip Crimp • Types: 8P8C, 6P6C, 4P4C 	<ul style="list-style-type: none"> • Coaxial Crimping Tool • Hex Tool for BNC F-type Crimp on Connector

Dummy Cameras

DUM-301EB	DUM-501E	DUM-501EB



- Engineered for mainstream surveillance security systems
- AllFrame™ 4K technology enables high-quality recording
- Up to 64 single-stream cameras per drive
- Supports Western Digital Device Analytics™ (WDDA)
- Workload rating up to 180TB year, 3x the rating of desktop drive

Capacity	8TB, 6TB, 4TB, 3TB, 2TB, 1TB
Interface	SATA 6 Gb/s
Form Factor	3.5 inch
MTBF	Up to 1 million hours
Warranty	3 years

- Engineered with advanced capabilities needed for high end smart video solutions
- AllFrame™ AI technology improves ATA streaming to help reduce frame loss and improve overall video playback
- Up to 64 HD single-stream cameras per drive
- Supports an additional 32 AI streams for AI-enabled NVRs
- Supports Western Digital Device Analytics™ (WDDA)
- Workload rating up to 550TB year to support the heavy video data capture and analysis in advanced AI-enabled recorders, video analytics appliances, deep learning analytics servers and cloud-based storage

Capacity	18TB, 14TB, 12TB, 10TB, 8TB
Interface	SATA 6 Gb/s
Form Factor	3.5 inch
MTBF	Up to 2.5 million hours
Warranty	5 years

- Optimized for video surveillance cameras that operate 24/7
- Designed with ultra endurance for continuous operation
- Weather-resistant, humidity resistant, and withstands temperatures from -25°C to 85°C
- Failover local storage, continuous recording, even in case of a temporary camera disconnection
- Supports card health monitor functionality
- Advanced 96-layer 3D NAND Technology

Capacity	1TB, 512GB, 256GB, 128GB, 64GB, 32GB
Interface	SATA 6.0
Form Factor	microSDHC™ (32GB only)/ microSDXD™
Warranty	3 years

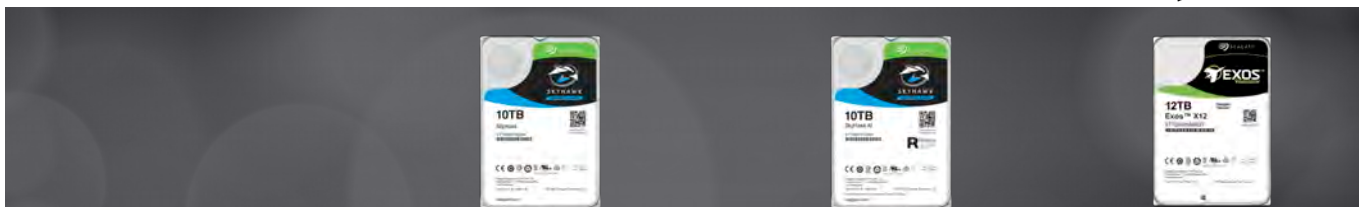

SkyHawk

SkyHawk AI

Exos

	SMB surveillance DVR and NVR	AI-surveillance NVR	Centralized/NVR Analytics
Form Factor	3.5-inch	3.5-inch	3.5-inch
Capacity	1TB, 2TB, 3TB, 4TB, 6TB	8TB, 10TB, 12TB, 16TB, 18TB	2TB, 4TB, 6TB, 8TB, 10TB, 12TB, 14TB, 16TB, 18TB
Health Management	2TB and up	Yes	-
NVR-Ready	Yes (RV Sensors)	Yes (RV Sensors)	Yes (RV Sensors)
# of Cameras Supported	64 Cameras	64 Cameras, 32 AI Streams	-
Workload Rating	180TB/year	550TB/year	550TB/year
Data Recovery Services	3 Years	3 Years	-
Warranty	3-Year Warranty	3-Year Warranty	5-year Warranty

1. Available on capacities above 3TB



Video Solutions for Security Professionals

Texas - Houston

8634 Westpark Dr.
Houston, TX 77063
Tel: 713-587-1800
Email: Support.Houston@LTSecurityinc.com
Sales Office: 8:30am - 6pm (CST): MON - FRI
En LTS Houston hablamos español

New Jersey - Mount Laurel

109 West Park Dr., Suite B & C
Mount Laurel, NJ 08054
Toll Free: 855-835-8889
Tel: 856-780-9888
Email: Support.NewJersey@LTSecurityinc.com
Sales Office: 9am - 6pm (EST): MON - FRI

California - Los Angeles

17333 Freedom Way
City of Industry, CA 91748
Toll Free: 888-587-5871
Tel: 626-435-2838
Email: Support.LosAngeles@LTSecurityinc.com
Sales Office: 8:30am - 6pm (PST): MON - FRI
En LTS California hablamos español

Texas - Dallas

1100 Valwood Pkwy., Suite 112
Carrollton, TX 75006
Tel: 469-289-5780
Email: Support.Dallas@LTSecurityinc.com
Sales Office: 8:30am - 5:30pm (CST): MON - FRI

New Jersey - Pine Brook

26 Chapin Rd., Unit 1103
Pine Brook, NJ 07058
Tel: 973-287-4427
Email: Support.PBNJ@LTSecurityinc.com
Sales Office: 8:30am - 6pm (EST): MON - FRI
After-hour Pickup Available
En LTS Pine Brook hablamos español

California - San Francisco

38507 Cherry St. Suite G
Newark, CA 94560
Toll Free: 888-216-2812
Tel: 510-201-9868
Email: Support.SanFrancisco@LTSecurityinc.com
Sales Office: 9am - 6pm (PST): MON - FRI

Illinois

1951 Landmeier Rd.
Elk Grove Village, IL 60007
Tel: 630-348-8088
Email: Support.Chicago@LTSecurityinc.com
Sales Office: 9am - 6pm (CST): MON - FRI
En LTS Illinois hablamos español

New York

99 Seaview Blvd., Suite 1B
Port Washington, NY 11050
Tel: 646-558-3888
Email: Support.NewYork@LTSecurityinc.com
Sales Office: 8:30am - 5:30pm (EST): MON - FRI
After-hour Pickup Available

Arizona

2850 S. 36th Street, Suite A-7
Phoenix, AZ 85034
Toll Free: 877-284-2890
Tel: 602-903-2220
Email: Support.AZ@LTSecurityinc.com
Sales Office: 8:30am - 5:30pm (MST): MON - FRI

Florida - Miami

8400 NW 25th St., Suite 110
Miami, FL 33122
Tel: 786-693-1813
Email: Support.Florida@LTSecurityinc.com
Sales Office: 8:30am - 6pm (EST): MON - FRI
En LTS Florida hablamos español

Maryland

4501 Forbes Blvd., Suite I
Lanham, MD 20706
Tel: 240-493-8988
Email: Support.Maryland@LTSecurityinc.com
Sales Office: 9am - 6pm (EST): MON - FRI
En LTS Maryland hablamos español

Florida - Orlando

807 S. Orlando Ave., Suite K
Winter Park, FL 32789
Tel: 786-693-1813
Email: Support.Florida@LTSecurityinc.com
Sales Office: 8:30am - 5:30pm (EST): MON - FRI
En LTS Florida hablamos español

Georgia

5933 Peachtree Industrial Blvd, Suite B
Norcross, GA 30092
Tel: 678-710-3788
Email: Support.GA@LTSecurityinc.com
Sales Office: 9am - 6pm (EST): MON - FRI

