



**Kitchen  
Cabinet  
Distributors™**



**PREMIER PRODUCT  
2023 CATALOG**



## Table of Contents

Cabinet Lines	4
Product Comparison	13
Product Specifications	15
Wall Cabinets	16
Base Cabinets	19
Tall Cabinets	23
Vanity Cabinets	24
Moldings & Trim	26
Fillers & Panels	27
Accessories	28
Decorative Hardware	31
Products By Line	33

## Our Vision

We provide thoughtful products and exceptional service to inspire spaces where people love to live.

# Cabinet Lines

Our **Premier Series** offers distinctive touches and superb craftsmanship, satisfying either the traditional or modern design palette with a look to fit any lifestyle.



AS SEEN ON  
PROPERTY BROTHERS  
BUYING+SELLING



SHAKER  
SAND  
(SS)



SHAKER  
DESIGNER  
WHITE SLAB  
(SW)



SHAKER  
DESIGNER  
WHITE 5PC  
(SW)



SHAKER  
ESPRESSO  
(SE)



SHAKER  
KODIAK  
(SK)



BROOKLYN  
MODERN  
GRAY  
(BG)



BROOKLYN  
SLATE  
(BS)



BROOKLYN  
MIDNIGHT  
(BM)



BROOKLYN  
BRIGHT  
WHITE  
(BW)



NAPA  
WHITE  
(NW)



LENOX  
CANVAS  
(LV)

# Shaker

Bright, crisp, and modern, this cabinet has a versatile appeal. The design incorporates the architectural shaker style with pleasing proportions. Shaker White is available with a slab or 5-piece drawer front yielding a contemporary or classic display.

- Full overlay doors provide a seamless aesthetic
- Soft-close doors and drawers prevent slamming
- Dovetail drawer craftsman construction
- Full extension drawers ensure easy access
- Durable solid wood cabinet box and drawers
- Premium Sherwin-Williams® finish delivers a lifetime of beauty
- Full line of accessories and upgrades available



Shaker Designer White

\*Slab



Shaker Designer White

\*5 Piece



Shaker Sand



Shaker Kodiak



Shaker Espresso

# Brooklyn

This transitional door complements a range of style from modern to vintage to traditional. The selection of color options within the Brooklyn line offers a solution for many design needs. Find modern charm in Brooklyn Gray or install a Slate island for the perfect kitchen accent that your guests will love. Brooklyn's classic Bright White finish provides a timeless backdrop for a space that will become a gathering spot for years to come.

- Full overlay doors provide a seamless aesthetic
- Soft-close doors and drawers prevent slamming
- Dovetail drawer craftsman construction
- Full extension drawers ensure easy access
- Solid wood cabinet box and drawers provide exceptional durability
- Premium Sherwin-Williams® finish delivers a lifetime of beauty
- Available with a full line of accessories and upgrades

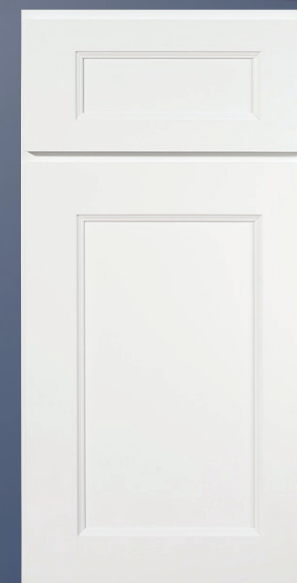

Brooklyn Bright White



Brooklyn Modern Gray



Brooklyn Midnight



Brooklyn Slate

# Napa

The Napa White line is an adaptable option that adds dimension and elegance. The bright white finish and raised center panel provide a charming and traditional feel that is perfect for any home.

- Full overlay doors provide a seamless aesthetic
- Soft-close doors and drawers prevent slamming
- Dovetail drawer craftsman construction
- Full extension drawers ensure easy access
- Solid wood cabinet box and drawers provide exceptional durability
- Sherwin-Williams® finish delivers a lifetime of beauty
- Available with a full line of accessories and upgrades that add style and function



Napa White

# Lenox

This elegant painted door style is constructed from solid wood with applied molding.

- Full overlay doors provide a seamless aesthetic
- Soft-close doors and drawers prevent slamming
- Dovetail drawer craftsman construction
- Full extension drawers ensure easy access
- Solid wood cabinet box and drawers provide exceptional durability
- Premium Sherwin-Williams® finish delivers a lifetime of beauty
- Available with a full line of accessories and upgrades that add style and function



Lenox Canvas





	Shaker Sand	Shaker Espresso	Shaker Designer White	Shaker Kodiak	Brooklyn Modern Gray	Brooklyn Bright White	Brooklyn Slate	Brooklyn Midnight
<b>Cabinet Box</b>	1/2", 7 Ply, Plywood	1/2", 7 Ply, Plywood	1/2", 7 Ply, Plywood	1/2", 7 Ply, Plywood	1/2", 7 Ply, Plywood	1/2", 7 Ply, Plywood	1/2", 7 Ply, Plywood	1/2", 7 Ply, Plywood
<b>Drawer Box</b>	5/8" Solid Wood, Dovetailed	5/8" Solid Wood, Dovetailed	5/8" Solid Wood, Dovetailed	5/8" Solid Wood, Dovetailed	5/8" Solid Wood, Dovetailed	5/8" Solid Wood, Dovetailed	5/8" Solid Wood, Dovetailed	5/8" Solid Wood, Dovetailed
<b>Drawer Slides</b>	Under Mount, Full Extension, Metal, Soft Close w/ Ball Bearings	Under Mount, Full Extension, Metal, Soft Close w/ Ball Bearings	Under Mount, Full Extension, Metal, Soft Close w/ Ball Bearings	Under Mount, Full Extension, Metal, Soft Close w/ Ball Bearings	Under Mount, Full Extension, Metal, Soft Close w/ Ball Bearings	Under Mount, Full Extension, Metal, Soft Close w/ Ball Bearings	Under Mount, Full Extension, Metal, Soft Close w/ Ball Bearings	Under Mount, Full Extension, Metal, Soft Close w/ Ball Bearings
<b>Wood Species</b>	Birch	Birch	Birch	Birch	Birch	Birch	Birch	Birch
<b>Door Hinge</b>	DTC 6 Way Adjustable, Soft Close	DTC 6 Way Adjustable, Soft Close	DTC 6 Way Adjustable, Soft Close	DTC 6 Way Adjustable, Soft Close	DTC 6 Way Adjustable, Soft Close	DTC 6 Way Adjustable, Soft Close	DTC 6 Way Adjustable, Soft Close	DTC 6 Way Adjustable, Soft Close
<b>Shelves</b>	Adjustable, 3/4" Plywood	Adjustable, 3/4" Plywood	Adjustable, 3/4" Plywood	Adjustable, 3/4" Plywood	Adjustable, 3/4" Plywood	Adjustable, 3/4" Plywood	Adjustable, 3/4" Plywood	Adjustable, 3/4" Plywood
<b>Finish Color</b>	Sand	Espresso Stain	Designer White	Kodiak Stain	Modern Gray	Bright White	Slate Stain	Midnight
<b>Exterior Finish</b>	Sand to Match Doors	Espresso to Match Doors	Designer White to Match Doors	Kodiak to Match Doors	Modern Gray to Match Doors	Bright White to Match Doors	Slate to Match Doors	Midnight to Match Doors
<b>Interior Finish</b>	Natural	Natural	Natural	Natural	Natural	Natural	Natural	Natural
<b>Base Reinforcement</b>	3" Plywood Stretchers	3" Plywood Stretchers	3" Plywood Stretchers	3" Plywood Stretchers	3" Plywood Stretchers	3" Plywood Stretchers	3" Plywood Stretchers	3" Plywood Stretchers
<b>Face Frame</b>	1 1/2" Rails and Stiles, Solid Wood	1 1/2" Rails and Stiles, Solid Wood	1 1/2" Rails and Stiles, Solid Wood	1 1/2" Rails and Stiles, Solid Wood	1 1/2" Rails and Stiles, Solid Wood	1 1/2" Rails and Stiles, Solid Wood	1 1/2" Rails and Stiles, Solid Wood	1 1/2" Rails and Stiles, Solid Wood
<b>Full Overlay Door</b>	5-Piece with Solid Center Panel; 3 1/2" Stiles and Rails	5-Piece with Solid Center Panel; 3 1/2" Stiles and Rails	5-Piece with Solid Center Panel; 3 1/2" Stiles and Rails	5-Piece with Solid Center Panel; 3 1/2" Stiles and Rails	5-Piece with Solid Center Panel; 3 1/2" Stiles and Rails	5-Piece with Solid Center Panel; 3 1/2" Stiles and Rails	5-Piece with Solid Center Panel; 3 1/2" Stiles and Rails	5-Piece with Solid Center Panel; 3 1/2" Stiles and Rails
<b>Drawer Head</b>	5 Piece with Solid Center Panel; 2 3/4" Stiles and 2 3/4" Rails	5 Piece with Solid Center Panel; 2 3/4" Stiles and 2 3/4" Rails	5 Piece with Solid Center Panel; 2 3/4" Stiles and 2 3/4" Rails Also available in slab	5 Piece with Solid Center Panel; 2 3/4" Stiles and 2 3/4" Rails	5 Piece with Solid Center Panel; 2 3/4" Stiles and 2 3/4" Rails	5 Piece with Solid Center Panel; 2 3/4" Stiles and 2 3/4" Rails	5 Piece with Solid Center Panel; 2 3/4" Stiles and 2 3/4" Rails	5 Piece with Solid Center Panel; 2 3/4" Stiles and 2 3/4" Rails
<b>Design &amp; Structure</b>	Meets Leading Industry Standards	Meets Leading Industry Standards	Meets Leading Industry Standards	Meets Leading Industry Standards	Meets Leading Industry Standards	Meets Leading Industry Standards	Meets Leading Industry Standards	Meets Leading Industry Standards
<b>Assembly</b>	Glue and Staples, No Cams or Brackets	Glue and Staples, No Cams or Brackets	Glue and Staples, No Cams or Brackets	Glue and Staples, No Cams or Brackets	Glue and Staples, No Cams or Brackets	Glue and Staples, No Cams or Brackets	Glue and Staples, No Cams or Brackets	Glue and Staples, No Cams or Brackets
<b>Toe Kick Depth w/ TK Skin</b>	3.75"	3.75"	3.75"	3.75"	3.75"	3.75"	3.75"	3.75"
<b>Certifications</b>	TSCA VI, CARB, KCMA	TSCA VI, CARB, KCMA	TSCA VI, CARB, KCMA	TSCA VI, CARB, KCMA	TSCA VI, CARB, KCMA	TSCA VI, CARB, KCMA	TSCA VI, CARB, KCMA	TSCA VI, CARB, KCMA



	Napa White	Lenox Canvas
<b>Cabinet Box</b>	1/2", 7 Ply, Plywood	1/2", 7 Ply, Plywood
<b>Drawer Box</b>	5/8" Solid Wood, Dovetailed	5/8" Solid Wood, Dovetailed
<b>Drawer Slides</b>	Under Mount, Full Extension, Metal, Soft Close w/ Ball Bearings	Under Mount, Full Extension, Metal, Soft Close w/ Ball Bearings
<b>Wood Species</b>	Birch	Birch
<b>Door Hinge</b>	DTC 6 Way Adjustable, Soft Close	DTC 6 Way Adjustable, Soft Close
<b>Shelves</b>	Adjustable, 3/4" Plywood	Adjustable, 3/4" Plywood
<b>Finish Color</b>	Bright White	Canvas
<b>Exterior Finish</b>	Bright White to Match Doors	Canvas to Match Doors
<b>Interior Finish</b>	Natural	Natural
<b>Base Reinforcement</b>	3" Plywood Stretchers	3" Plywood Stretchers
<b>Face Frame</b>	1 1/2" Rails and Stiles, Solid Wood	1 1/2" Rails and Stiles, Solid Wood
<b>Full Overlay Door</b>	5-Piece with Solid Center Raised Panel; 3 1/2" Stiles and Rails	9-Piece Raised Panel with Applied Molding
<b>Drawer Head</b>	5 Piece with Solid Center Panel; 2 3/4" Stiles and 2 3/4" Rails	9-Piece Raised Panel with Applied Molding
<b>Design &amp; Structure</b>	Meets Leading Industry Standards	Meets Leading Industry Standards
<b>Assembly</b>	Glue and Staples, No Cams or Brackets	Glue and Staples, No Cams or Brackets
<b>Toe Kick Depth w/ TK Skin</b>	3.75"	3.75"
<b>Certifications</b>	TSCA VI, CARB, KCMA	TSCA VI, CARB, KCMA



# Product Specifications

Wall Cabinets - Base Cabinets - Tall Cabinets - Vanity Cabinets  
Molding & Trim - Fillers & Panels - Decorative Accessories



CREATIVE OPTIONS  
FOR ANY SPACE

## Wall Cabinet Coding

Standard (12" Deep)

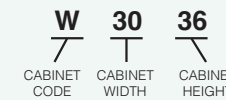

Refrigerator

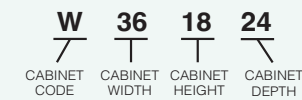

### Notes:

- Standard wall cabinets are 12" deep. Refrigerator cabinets are 24" deep.
- Add door thickness for total cabinet depth.
- Please refer to the Products by Cabinet Line chart to determine which products are carried for each cabinet line.

## 24" High Double Door Wall

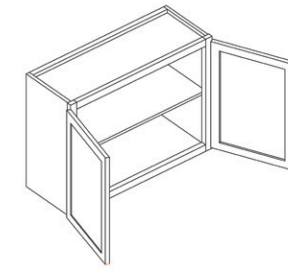

Item Code	Outer Dimensions		
	W	H	D
W3024	30	24	12
W3324	33	24	12
W3624	36	24	12

## 15" Wall Stacking Cabinets with Glass

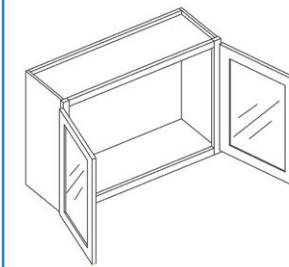

Item Code	Outer Dimensions		
	W	H	D
WS2415-2	24	15	12
WS2715-2	27	15	12
WS3015-2	30	15	12
WS3315-2	33	15	12
WS3615-2	36	15	12

\*Door comes pre-routed with glass insert and finished interior

## 24" Deep Wall (Refrigerator Cabinet)

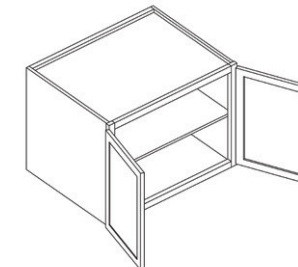

Item Code	Outer Dimensions		
	W	H	D
W331824	33	18	24
W332424	33	24	24
W361824	36	18	24
W362424	36	24	24

\*331824 and 361824 do not have a shelf

## 15" Wall Stacking Cabinets with Glass

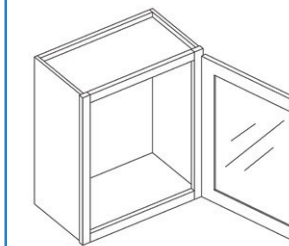

Item Code	Outer Dimensions		
	W	H	D
WS1215	12	15	12
WS1515	15	15	12
WS1815	18	15	12
WS2115	21	15	12

\*Door comes pre-routed with glass insert and finished interior

## 30" Microwave Wall Cabinet

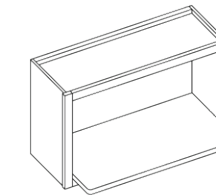

Item Code	Outer Dimensions		
	W	H	D
MWC3018	30	18	12

## 15" Corner Wall Stacking Cabinet with Glass

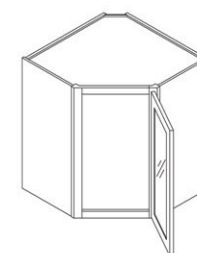

Item Code	Outer Dimensions		
	W	H	D
CWS2415	24	15	12
CWS2715	27	15	15

\*Door comes pre-routed with glass insert and finished interior

## 30" - 36" High Single Door Wall

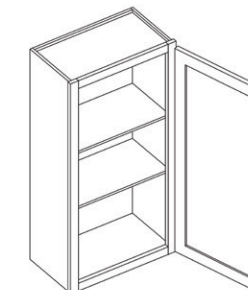

Item Code	Outer Dimensions		
	W	H	D
W930	9	30	12
W1230	12	30	12
W1530	15	30	12
W1830	18	30	12
W2130	21	30	12
W936	9	36	12
W1236	12	36	12
W1536	15	36	12
W1836	18	36	12
W2136	21	36	12

## 12" - 21" High Double Door Wall

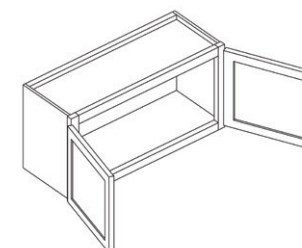

Item Code	Outer Dimensions		
	W	H	D
W3012	30	12	12
W3612	36	12	12
W3015	30	15	12
W3312	33	12	12
W3315	33	15	12
W3615	36	15	12
W3018	30	18	12
W3318	33	18	12
W3618	36	18	12
W3021	30	21	12

## 30" - 36" High Double Door Wall

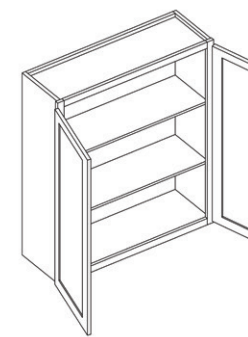

Item Code	Outer Dimensions		
	W	H	D
W2430-2	24	30	12
W2730	27	30	12
W3030	30	30	12
W3330	33	30	12
W3630	36	30	12
W3930	39	30	12
W2436-2	24	36	12
W2736	27	36	12
W3036	30	36	12
W3336	33	36	12
W3636	36	36	12
W3936	39	36	12



### Installing a Blind Wall Cabinet

Proper installation ensures that the doors will open and show correct reveal

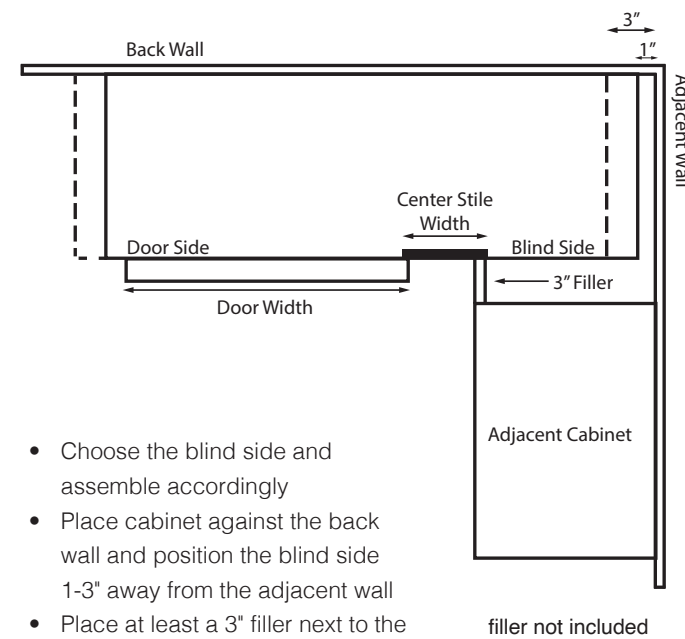

- Choose the blind side and assemble accordingly
- Place cabinet against the back wall and position the blind side 1-3" away from the adjacent wall
- Place at least a 3" filler next to the adjacent cabinet

filler not included

### Wall Tower with 3 Drawers

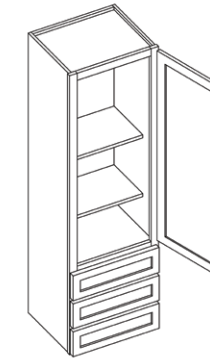

Item Code	Outer Dimensions		
	W	H	D
DWR1548	15	48	15
DWR1554	15	54	15
DWR1560	15	60	15

\*Works great with a vanity

### Wine Rack

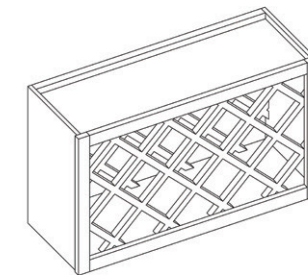

Item Code	Outer Dimensions		
	W	H	D
WR3018	30	18	12

### 30" - 36" High Double Door with Center Stile

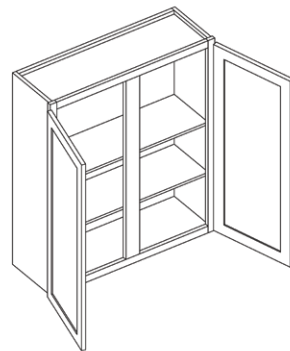

Item Code	Outer Dimensions		
	W	H	D
W4230	42	30	12
W4236	42	36	12

### 42" High Double Door Wall

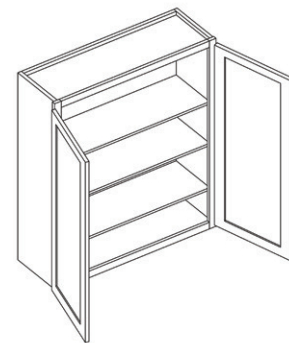

Item Code	Outer Dimensions		
	W	H	D
W2442-2	24	42	12
W2742	27	42	12
W3042	30	42	12
W3342	33	42	12
W3642	36	42	12
W3942	39	42	12

### 30" - 36" High Corner Wall

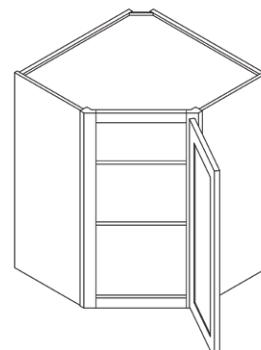

Item Code	Outer Dimensions		
	W	H	D
CW2430	24	30	12
CW2436	24	36	12
CW2736	27	36	15

### 42" High Single Door Wall

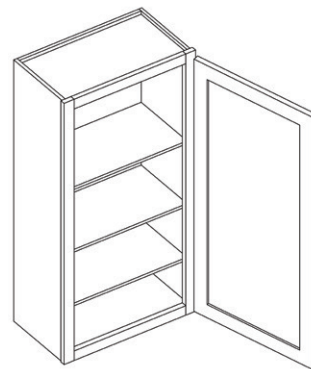

Item Code	Outer Dimensions		
	W	H	D
W942	9	42	12
W1242	12	42	12
W1542	15	42	12
W1842	18	42	12
W2142	21	42	12

### 42" High Double Door Wall with Center Stile

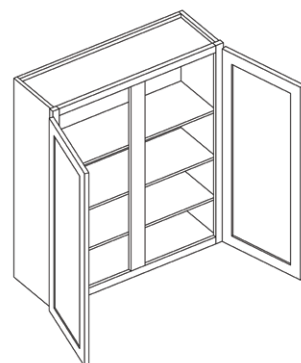

Item Code	Outer Dimensions		
	W	H	D
W4242	42	42	12

### 42" High Corner Wall

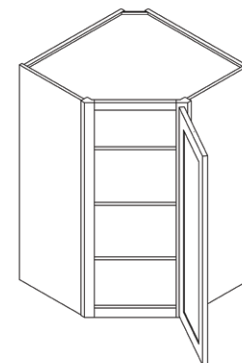

Item Code	Outer Dimensions		
	W	H	D
CW2442	24	42	12
CW2742	27	42	15



### 30" - 36" High Blind Wall

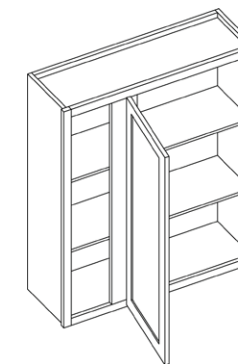

Item Code	Outer Dimensions		
	W	H	D
BW2430	24	30	12
BW3030	30	30	12
BW3630	36	30	12
BW2436	24	36	12
BW3036	30	36	12
BW3636	36	36	12

\*Image shown is hinge left

### 42" High Blind Wall

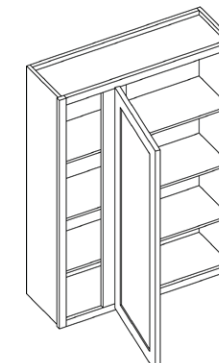

Item Code	Outer Dimensions		
	W	H	D
BW3042	30	42	12
BW3642	36	42	12

\*Image shown is hinge left

Base Cabinet Coding

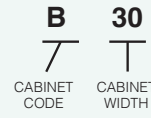

- Notes:
- Standard base cabinets are 24" deep and 34.5" high.
  - Add door thickness for total cabinet depth.
  - Please refer to the Products by Cabinet Line chart to determine which products are carried for each cabinet line.
  - Napa White has a single drawer on all sizes.

Double Door Standard Base with Center Stile

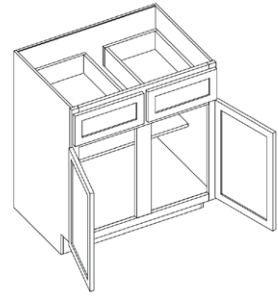

Item Code	Outer Dimensions		
	W	H	D
B42	42	34.5	24

Sink Base

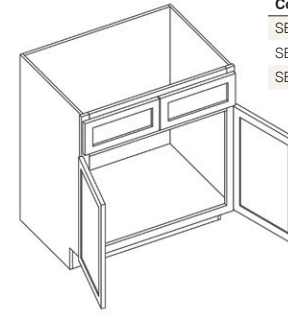

Item Code	Outer Dimensions		
	W	H	D
SB30	30	34.5	24
SB33	33	34.5	24
SB36	36	34.5	24



Microwave Base Cabinet

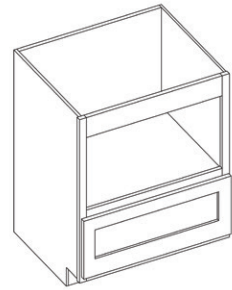

Item Code	Outer Dimensions		
	W	H	D
MBC30	30	34.5	24

\*Finished interior

Double Door Standard Base

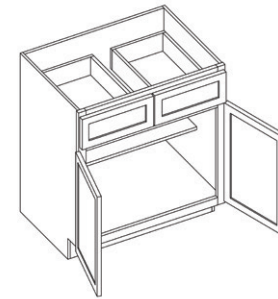

Item Code	Outer Dimensions		
	W	H	D
B24-2*	24	34.5	24
B27	27	34.5	24
B30	30	34.5	24
B33	33	34.5	24
B36	36	34.5	24
B39	39	34.5	24

\*B24-2 has one drawer and two doors  
\*Napa White has a single drawer front on all sizes.

Desk Drawer Base

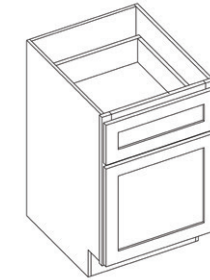

Item Code	Outer Dimensions		
	W	H	D
DDB18	18	29.5	24

Sink Base with Center Stile

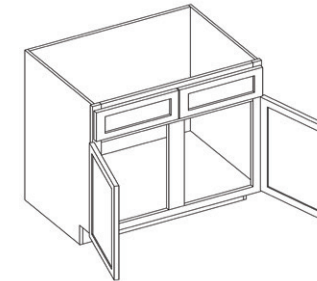

Item Code	Outer Dimensions		
	W	H	D
SB42	42	34.5	24
SB48	48	34.5	24

Single Door Full Height Base

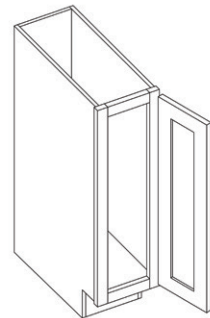

Item Code	Outer Dimensions		
	W	H	D
B09	9	34.5	24

Easy Reach

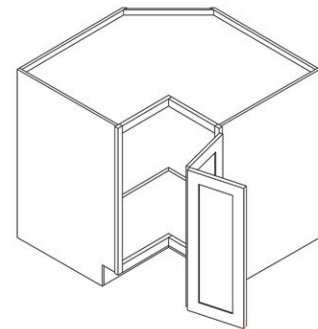

Item Code	Outer Dimensions		
	W	H	D
ER33	33	34.5	24
ER36	36	34.5	24

Cooking Center

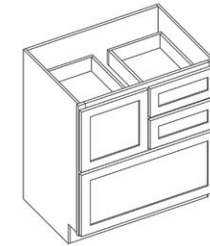

Item Code	Outer Dimensions		
	W	H	D
CC30	30	34.5	24

36" Farm Sink Base

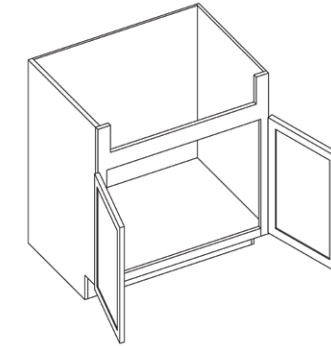

Item Code	Outer Dimensions		
	W	H	D
FSB36	36	34.5	24

\*Height of sink inset is 13.5"

Single Door Standard Base

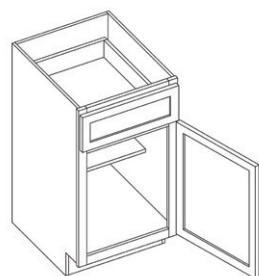

Item Code	Outer Dimensions		
	W	H	D
B12	12	34.5	24
B15	15	34.5	24
B18	18	34.5	24
B21	21	34.5	24

Trash Can Base (Full Height)

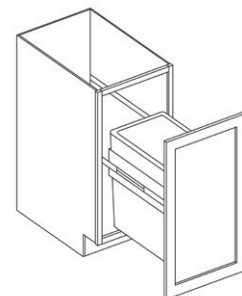

Item Code	Outer Dimensions		
	W	H	D
TRB-1*	18	34.5	24
TRB-2**	18	34.5	24

\*Includes one 50 QT can  
\*\*Includes two 35 QT cans

Drawer Base

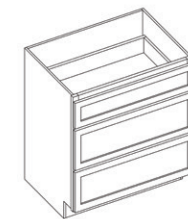

Item Code	Outer Dimensions		
	W	H	D
DB12-3	12	34.5	24
DB15-3	15	34.5	24
DB18-3	18	34.5	24
DB21-3	21	34.5	24
DB24-3	24	34.5	24
DB27-3	27	34.5	24
DB30-3	30	34.5	24
DB33-3	33	34.5	24
DB36-3	36	34.5	24

Drawer Base - 2 Drawer

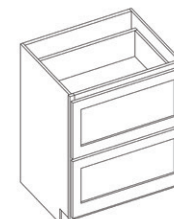

Item Code	Outer Dimensions		
	W	H	D
DB30-2	30	34.5	24
DB36-2	36	34.5	24

Corner Sink Front

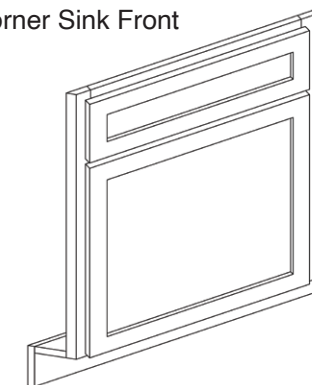

Item Code	Outer Dimensions		
	W	H	D
CSF42	27	34.5	2
CSF-FLOOR*	48	0.5	48

\*Sink floor not pictured and sold separately  
\*Back of face frame measures 27" wide  
NOTE: Hinges not included, to use as a workable door corner hinges are recommended.

36" Blind Base

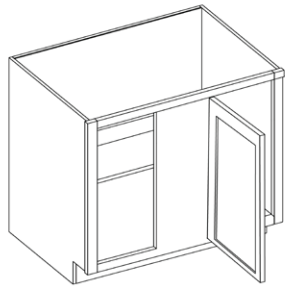

Item Code	Outer Dimensions		
	W	H	D
BB36	30	34.5	24

\*Image shown is hinge left

42" - 48" Blind Base

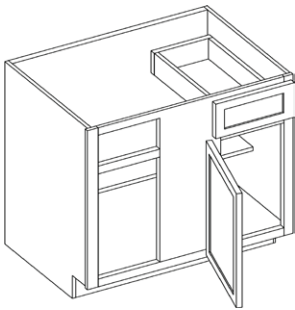

Item Code	Outer Dimensions		
	W	H	D
BB42	36	34.5	24
BB48	48	34.5	24

\*Image shown is hinge left

Installing a Blind Base Cabinet

Proper installation ensures that the drawer will clear hardware, and doors will open, and show correct reveal

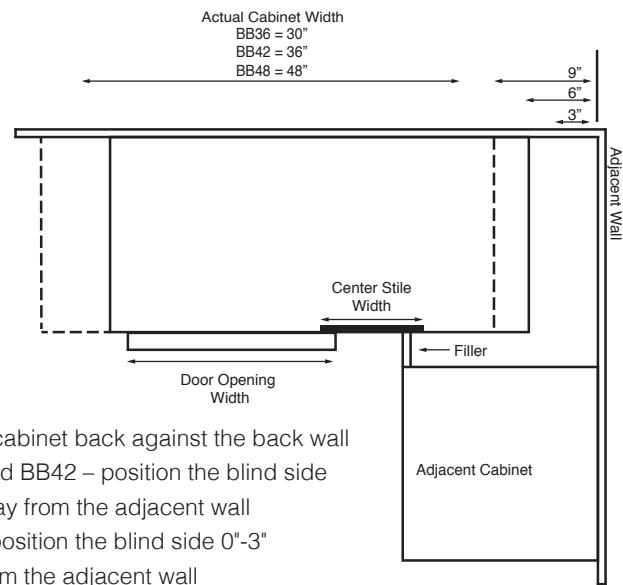

- Place the cabinet back against the back wall
  - BB36 and BB42 – position the blind side 6"-9" away from the adjacent wall
  - BB48 - position the blind side 0"-3" away from the adjacent wall
- Place at least a 3" filler next to adjacent cabinet

\*Filler not included



Tall Cabinet Coding

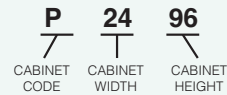

- Notes:
- Standard tall cabinets are 24" deep.
  - Add door thickness for total cabinet depth.
  - Please refer to the Products by Cabinet Line chart to determine which products are carried for each cabinet line.

Single Door Pantry

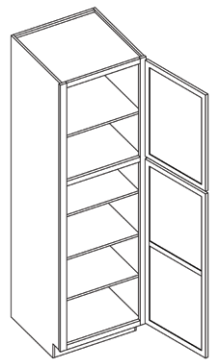

Item Code	Outer Dimensions		
	W	H	D
P1884*	18	84	24
P1890*	18	90	24
P1896**	18	96	24

\*Includes four shelves  
\*\*Includes five shelves

24" and 30" Double Door Pantry

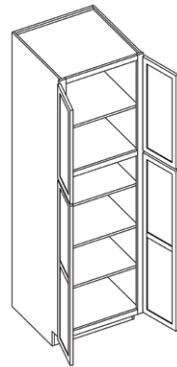

Item Code	Outer Dimensions		
	W	H	D
P2484*	24	84	24
P2490*	24	90	24
P2496**	24	96	24
P3090*	30	90	24
P3096**	30	96	24

\*Includes four shelves  
\*\*Includes five shelves

Oven Cabinet (Includes One Drawer)

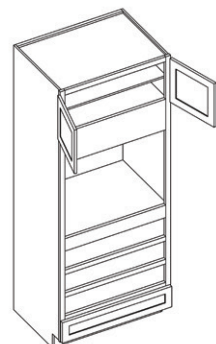

Item Code	Outer Dimensions		
	W	H	D
OC3390	33	90	24
OC3396	33	96	24

\*Includes one drawer



Oven Cabinet Drawer

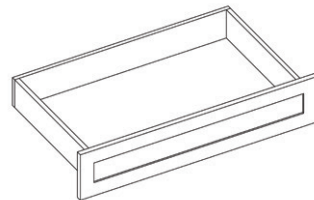

Item Code	Outer Dimensions		
	W	H	D
OCD337	32.5	6.75	24

Oven Cabinet Overlay Panel

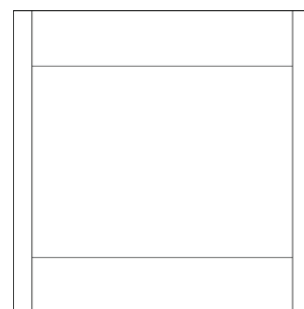

Item Code	Outer Dimensions		
	W	H	D
OP3353	32.5	53	0.75

Vanity Cabinet Coding

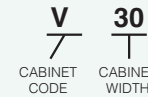

- Notes:
- Standard vanity cabinets are 21" deep.
  - Add door thickness for total cabinet depth.
  - Please refer to the Products by Cabinet Line chart to determine which products are carried for each cabinet line.
  - Napa White has a single drawer on all sizes.

Vanity Combo Cabinet 36"

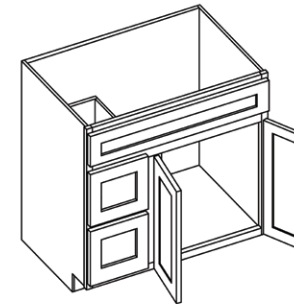

Item Code	Outer Dimensions		
	W	H	D
VSBDR36	36	34.5	21
VSBDL36	36	34.5	21

\*Pictured is the VSBDL36

Vanity Combo Cabinet 30"

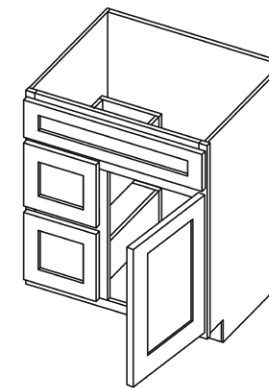

Item Code	Outer Dimensions		
	W	H	D
VSBDR30	30	34.5	21
VSBDL30	30	34.5	21

\*Pictured is the VSBDL30

Single Door Vanity

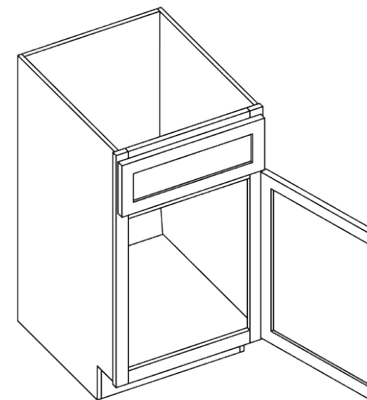

Item Code	Outer Dimensions		
	W	H	D
V21	21	34.5	21



36" Open Shelf Vanity Sink Base

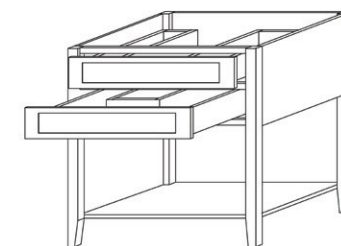

Item Code	Outer Dimensions		
	W	H	D
VSBOS36	36	34.5	21

\*Includes adjustable feet  
\*Total height does not account for adjustable foot height

Double Door Vanity

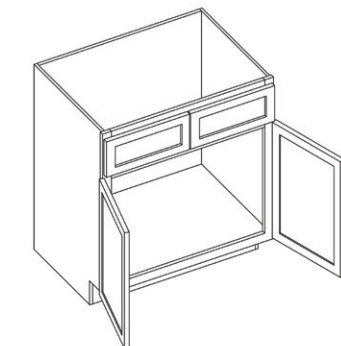

Item Code	Outer Dimensions		
	W	H	D
V24-2"	24	34.5	21
V27	27	34.5	21
V30	30	34.5	21
V33	33	34.5	21
V36	36	34.5	21

\*Has a single drawer front.  
Note: Napa White has a single drawer front on all sizes.

Vanity Drawer Base

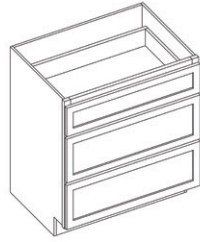

Item Code	Outer Dimensions		
	W	H	D
VDB12	12	34.5	21
VDB15	15	34.5	21
VDB18	18	34.5	21
VDB24	24	34.5	21

Vanity Sink Base

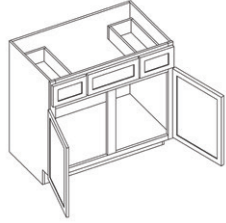

Item Code	Outer Dimensions		
	W	H	D
VSB36	36	34.5	21
VSB42	42	34.5	21
VSB48	48	34.5	21

Single Door Vanity Base

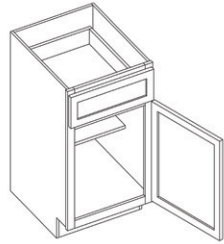

Item Code	Outer Dimensions		
	W	H	D
VB12	12	34.5	21
VB15	15	34.5	21
VB18	18	34.5	21

24" Vanity Drawer

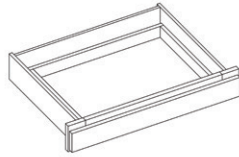

Item Code	Outer Dimensions		
	W	H	D
KD24	23.5	4.75	21

\*Drawer box height is 2"  
NOTE: All drawer fronts will have a slab profile.

36" Vanity Drawer

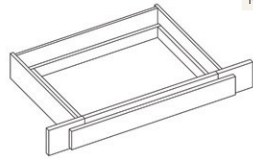

Item Code	Outer Dimensions		
	W	H	D
KD36	29.5	4.75	21

\*Drawer box height is 2"  
\* Sides Trimmable to 30"  
NOTE: All drawer fronts will have a slab profile.



Toe Kick - TKS8

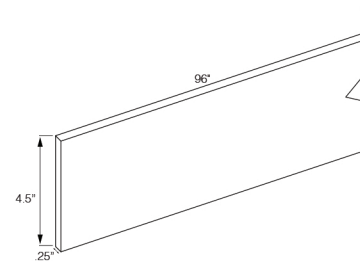

Large Crown Molding - BCM8

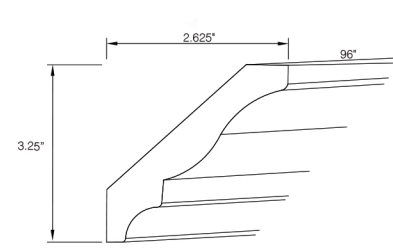

Outside Corner Molding - OCM8

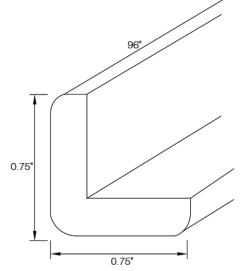

Scribe - SCRIBE

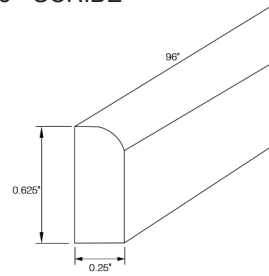

Royal Crown Molding - RCM8

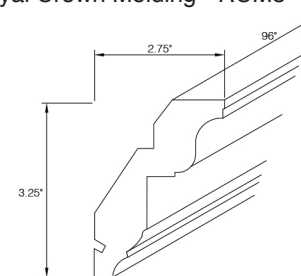

Traditional Light Rail Molding - LRM8

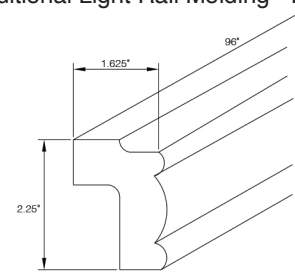

Shoe - SHOE

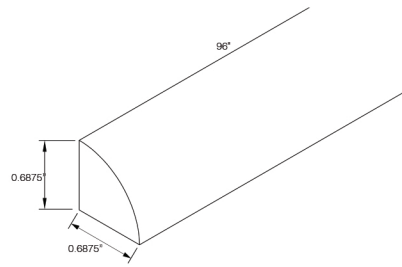

Shaker Crown Molding - SCM8

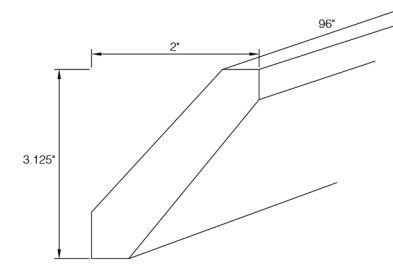

Bottom Edge Molding - BEM8

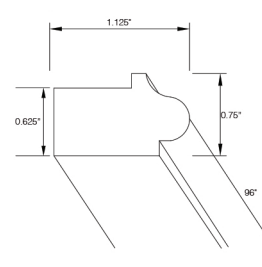

Furniture Base Molding - FBM8

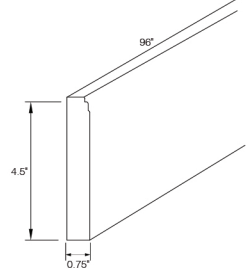

Cove Crown Molding - COM8

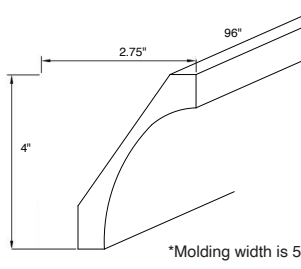

\*Molding width is 5.25"

Traditional Crown Molding - CM8

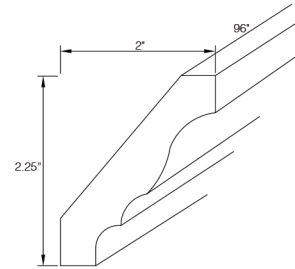

Batten Molding - BAM8

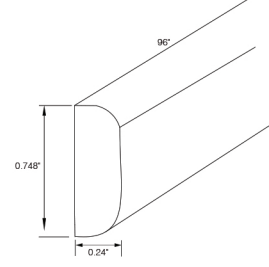



1/2" Thick Finished Plywood Panel



Item Code	Outer Dimensions		
	W	H	D
PSP4896	96	48	0.5

\*Finished one side, natural UV back

Corbel - Basic Medium

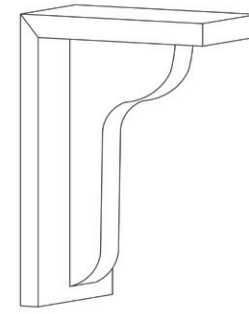

Item Code	Outer Dimensions		
	W	H	D
CORSM	3	10.5	7.5

Corbel - Transitional

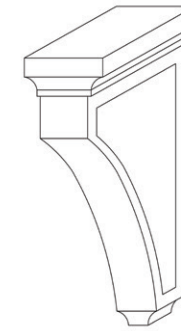

Item Code	Outer Dimensions		
	W	H	D
CORT	3.5	10.5	7

Turned Post

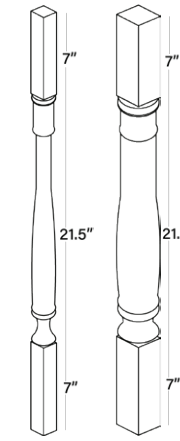

Item Code	Outer Dimensions		
	W	H	D
TPOSTP3	3	35.5	3
TPOSTP5	5	35.5	5

Back Panel - Long Grain Plywood

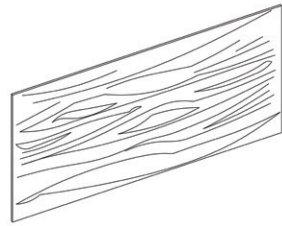

Item Code	Outer Dimensions		
	W	H	D
BPLG4896	48	96	0.25

\*Finished one side, raw back

Bead Board

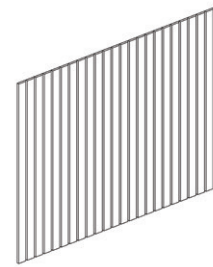

Item Code	Outer Dimensions		
	W	H	D
BBP4842	48	42	0.25

\*Finished one side, raw back

Filler



Item Code	Outer Dimensions		
	W	H	D
F396	3	96	0.75
F696	6	96	0.75

\*All four edges finished

Overlay Filler



Item Code	Outer Dimensions		
	W	H	D
OLF330	2.5	28.75	0.75
OLF336	2.5	34.75	0.75
OLF342	2.5	40.75	0.75
OLF630**	5.5	28.75	0.75

\*All four edges finished  
NOTE: Sizes do not measure true.

Fluted Filler



Item Code	Outer Dimensions		
	W	H	D
FF396	3	96	0.75

\*All four edges finished

Dishwasher End Panel



Item Code	Outer Dimensions		
	W	H	D
DWR3	3	34.5	24

\*0.5" panel thickness  
\*Finished one side, natural UV back

Bunfoot - Transitional

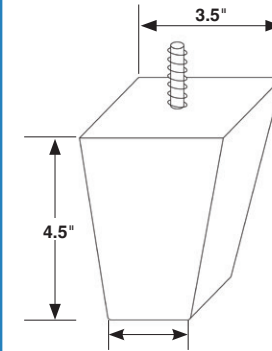

Item Code	Outer Dimensions		
	H	Top	Bottom
TBUNFOOT2	4.5	3.5	2

Bunfoot

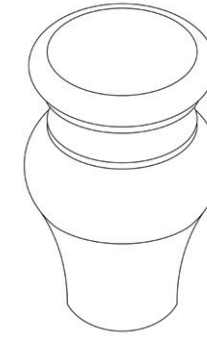

Item Code	Outer Dimensions		
	W	H	D
TBUNFOOT	3	4.5	3

Decorative Base/Wall Panels

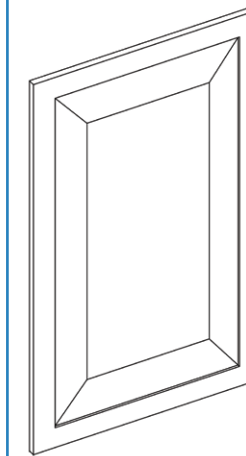

Item Code	Outer Dimensions		
	W	H	D
DWP1215	11.5	13.75	0.75
DWP2415	23.5	13.75	0.75
DWP1230	11.5	28.75	0.75
DWP2430	23.5	28.75	0.75
DWP1236	11.5	34.75	0.75
DWP1242	11.5	40.75	0.75

Tall End Panel



Item Code	Outer Dimensions		
	W	H	D
TEP3096	1.5	96	30

\*0.5" panel thickness  
\*Finished one side, natural UV back

Bookcase End



Item Code	Outer Dimensions		
	W	H	D
BCE1596	1.5	96	15

\*Requires shelf  
\*Shelf clips available  
\*0.5" panel thickness

Shelf



Item Code	Outer Dimensions		
	W	H	D
**SHELF1296	96	0.625	12
***SHELF2496	96	0.625	24

\*3/4" plywood construction  
\*\*Available in natural or painted  
\*\*\*Available in natural only

Furniture Valance

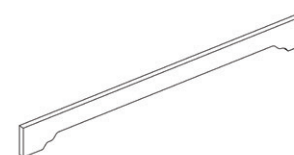

Item Code	Outer Dimensions		
	W	H	D
VFUNR37	37	4.5	0.75



Soft Close Roll Out Tray

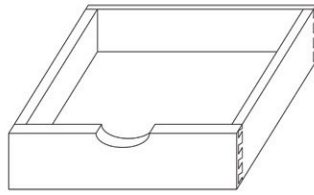

Item Code	Outer Dimensions		
	W	H	D
ROT15-SC	10.125	4	21
ROT18-SC	13.125	4	21
ROT21-SC	16.125	4	21
ROT24-SC	19.125	4	21
ROT27-SC	22.125	4	21
ROT30-SC	25.125	4	21
ROT33-SC	28.125	4	21
ROT36-SC	31.125	4	21

\*Includes two trays & four tracks

Lazy Susan Kit

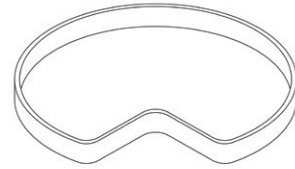

Item Code	Outer Dimensions		
	W	H	D
LSK	29	1.5	29

\*Includes two trays for shelf mounting  
\*Birch plywood construction

Trash Can Insert for B18

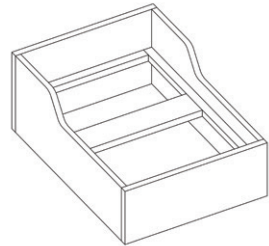

Item Code	Outer Dimensions		
	W	H	D
TCCK*	14.625	4.125	19.75

• Dovetail, solid wood construction  
• Undermount, full extension, soft close slides \*Includes two 35 QT cans

Spice Rack Insert



Item Code	Outer Dimensions		
	W	H	D
SRI9-SC	5.75	24	20.5

\*Fits in the B09

Cutlery Drawer Insert

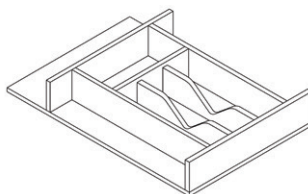

Item Code	Outer Dimensions		
	W	H	D
CDI14	13.375	2.87	19.75
CDI20	19.75	2.87	19.75

Roll Out Tray Usage Guide

Item Code	Designed to Fit
ROT15-SC	B15
ROT18-SC	B18, P1884, P1890, P1896
ROT21-SC	B21
ROT24-SC	B24, P2484, P2490, P2496
ROT27-SC	B27
ROT30-SC	B30, SB30, P3084, P3090, P3096
ROT33-SC	B33, SB33
ROT36-SC	B36, SB36

Spice Rack Door Attachment

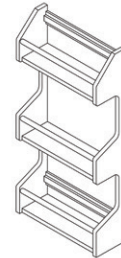

Item Code	Outer Dimensions		
	W	H	D
SRD12	11.5	24	4
SRD15	14.5	24	4

Spice Tray Insert

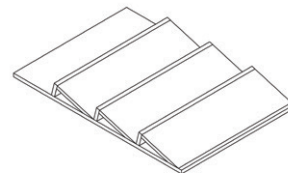

Item Code	Outer Dimensions		
	W	H	D
STI14	13.375	1.094	19.75
STI20	19.75	1.094	19.75

Stemware Rack

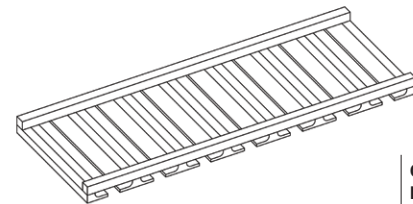

Item Code	Outer Dimensions		
	W	H	D
SWR3012	28.5	1.5	10.5





















PERFECT  
  
 PAIRINGS



Discover The  
 Perfect Pairing  
 Over 200+ Options  
[kcdus.com/hardware](http://kcdus.com/hardware)



Introducing KCD's Decorative Hardware Collection, designed to provide the perfect complement to our cabinet door styles. The expansive assortment of possibilities will make it easy to find the perfect pair.

<p><b>Bar Pull</b>  <small>Shown In Satin Nickel</small></p> 	<p><b>Bar Pull Knob</b>  <small>Shown In Rubbed Oil Bronze</small></p> 	<p><b>Charleston Cup Pull</b>  <small>Shown In Matte Black</small></p> 	<p><b>Charlotte Pull</b>  <small>Shown In Rubbed Oil Bronze</small></p> 
<p><b>Charlotte Square Knob</b>  <small>Shown In Rose Gold</small></p> 	<p><b>Colorado Knob</b>  <small>Shown In Polished Chrome</small></p> 	<p><b>Colorado Square Knob</b>  <small>Shown In Satin Nickel</small></p> 	<p><b>Colorado Pull</b>  <small>Shown In Matte Black</small></p> 
<p><b>Diecast Knob</b>  <small>Shown In Dark Pewter</small></p> 	<p><b>Madison Pull</b>  <small>Shown In Rubbed Oil Bronze</small></p> 	<p><b>Manhattan Pull</b>  <small>Shown In Rose Gold</small></p> 	<p><b>Miami Pull</b>  <small>Shown In Dark Pewter</small></p> 
<p><b>Milan Pull</b>  <small>Shown In Satin Nickel</small></p> 	<p><b>Modern Square Pull</b>  <small>Shown In Matte Black</small></p> 	<p><b>Round Flat Top Knob</b>  <small>Shown In Dark Pewter</small></p> 	<p><b>Rectangular Knob</b>  <small>Shown In Polished Chrome</small></p> 
<p><b>Square Knob – Flat</b>  <small>Shown In Rose Gold</small></p> 	<p><b>Square Knob</b>  <small>Shown In Matte Black</small></p> 	<p><b>Vail Pull</b>  <small>Shown In Polished Chrome</small></p> 	

Available Finishes

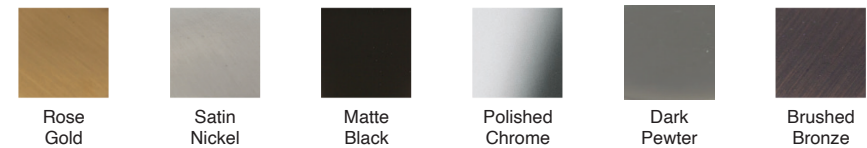



Item Code	Item Description	Shaker Sand	Shaker Designer White	Shaker Espresso	Shaker Kodiak	Brooklyn Modern Gray	Brooklyn Bright White	Brooklyn Slate	Brooklyn Midnight	Napa White	Lenox Canvas
<b>Premier</b>											
<b>Base Cabinets</b>											
DB12-3	Drawer Base Cabinet - 12" W	●	●+	●	●	●	●	●	●	●	●
DB15-3	Drawer Base Cabinet - 15" W	●	●+	●	●	●	●	●	●	●	●
DB18-3	Drawer Base Cabinet - 18" W	●	●+	●	●	●	●	●	●	●	●
DB21-3	Drawer Base Cabinet - 21" W	●	●+	●	●	●	●	●	●	●	●
DB24-3	Drawer Base Cabinet - 24" W	●	●+	●	●	●	●	●	●	●	●
DB27-3	Drawer Base Cabinet - 27" W	●	●+	●	●	●	●	●	●	-	-
DB30-3	Drawer Base Cabinet - 30" W	●	●+	●	●	●	●	●	●	●	●
DB33-3	Drawer Base Cabinet - 33" W	●	●+	●	●	●	●	●	●	-	-
DB36-3	Drawer Base Cabinet - 36" W	●	●+	●	●	●	●	●	●	●	●
DB30-2	2 Drawer Base Cabinet - 30" W	●	●+	●	●	●	●	●	●	●	●
DB36-2	2 Drawer Base Cabinet - 36" W	●	●+	●	●	●	●	●	●	-	-
CC30	Cooking Center Base Cabinet - 30" W	●	●+	●	●	●	●	●	●	●	●
FSB36	Farm Sink Base Cabinet - 36" W	●	●+	●	●	●	●	●	●	●	●
TRB-1	Trash Can Base w/ Full Ht Door -18" W	●	●+	●	●	●	●	●	●	●	●
TRB-2	Trash Can Base w/ Full Ht Door -18" W	●	●+	●	●	●	●	●	●	●	●
SB30	Sink Base Cabinet - 30" W	●	●+	●	●	●	●	●	●	●	●
SB33	Sink Base Cabinet - 33" W	●	●+	●	●	●	●	●	●	●	●
SB36	Sink Base Cabinet - 36" W	●	●+	●	●	●	●	●	●	●	●
SB42	Sink Base Cabinet w/ CS - 42" W	●	●+	●	●	●	●	●	●	●	●
SB48	Sink Base Cabinet w/ CS - 48" W	●	●+	●	●	●	●	●	●	●	-
CSF42	Corner Sink Front for 42" Space - 27" W	●	●+	●	●	●	●	●	●	●	●
CSF-FLOOR	Natural Corner Sink Front Floor 48" x 48"	●	●	●	●	●	●	●	●	●	●
BB36	Blind Base Cabinet for 36" to 39" Space - 30"W	●	●	●	●	●	●	●	●	●	-
BB42	Blind Base Cabinet for 42" to 45" Space - 36" W	●	●+	●	●	●	●	●	●	●	●
BB48	Blind Base Cab for 48" to 51" Space - 48" W	●	●+	●	●	●	●	●	●	●	●
ER33	Easy Reach Base Cabinet - 33" W x 33" D	●	●	●	●	●	●	●	●	●	●
ER36	Easy Reach Base Cabinet - 36" W x 36" D	●	●	●	●	●	●	●	●	●	●
DDB18	Desk Drawer Base - 18" W x 29.5" H x 24" D	●	●+	●	●	●	●	●	●	●	-
MBC30	Microwave Base Cabinet - 30" W	●	●+	●	●	●	●	●	●	●	●
<b>Tall Cabinets</b>											
P1884	Pantry - 18" W x 84" H	●	●	●	●	●	●	●	●	●	●
P1890	Pantry - 18" W x 90" H	●	●	●	●	●	●	●	●	●	●
P1896	Pantry - 18" W x 96" H	●	●	●	●	●	●	●	●	●	●
P2484	Pantry - 24" W x 84" H	●	●	●	●	●	●	●	●	●	●
P2490	Pantry - 24" W x 90" H	●	●	●	●	●	●	●	●	●	●
P2496	Pantry - 24" W x 96" H	●	●	●	●	●	●	●	●	●	●
P3090	Pantry - 30" W x 90" H	●	●	●	●	●	●	●	●	●	●
P3096	Pantry - 30" W x 96" H	●	●	●	●	●	●	●	●	●	●
OC3390	Oven Cabinet - 33" W x 90" H	●	●+	●	●	●	●	●	●	●	●
OC3396	Oven Cabinet - 33" W x 96" H	●	●+	●	●	●	●	●	●	●	●
OP3353	Oven Cabinet Overlay Panel - 33" W x 53" H	●	●	●	●	●	●	●	●	●	●
OCD337	Oven Cabinet Drawer	●	●+	●	●	●	●	●	●	●	●
<b>Vanities</b>											
V21	Single Door Vanity - 21" W	●	●+	●	●	●	●	●	●	-	-
V24-2	Double Door Vanity - 24" W	●	●+	●	●	●	●	●	●	●	●
V27	Double Door Vanity - 27" W	●	●+	●	●	●	●	●	●	●	●
V30	Double Door Vanity - 30" W	●	●+	●	●	●	●	●	●	●	●
V33	Double Door Vanity - 33" W	●	●+	●	●	●	●	●	●	●	●
V36	Double Door Vanity - 36" W	●	●+	●	●	●	●	●	●	●	●
VB12	Single Door Base Vanity - 12" W	●	●+	●	●	●	●	●	●	●	●
VB15	Single Door Base Vanity - 15" W	●	●+	●	●	●	●	●	●	●	●
VB18	Single Door Base Vanity - 18" W	●	●+	●	●	●	●	●	●	●	●

Item Code	Item Description	Shaker Sand	Shaker Designer White	Shaker Espresso	Shaker Kodiak	Brooklyn Modern Gray	Brooklyn Bright White	Brooklyn Slate	Brooklyn Midnight	Napa White	Lenox Canvas
<b>Premier</b>											
<b>Vanities</b>											
VDB12	Vanity Drawer Base - 12" W	●+	●+	●	●	●	●	●	●	●	●
VDB15	Vanity Drawer Base - 15" W	●+	●+	●	●	●	●	●	●	●	●
VDB18	Vanity Drawer Base - 18" W	●+	●+	●	●	●	●	●	●	●	●
VDB24	Vanity Drawer Base - 24" W	●+	●+	●	●	●	●	●	●	●	●
VSB36	Vanity Sink Base - 36" W	●+	●+	●	●	●	●	●	●	●	●
VSB42	Vanity Sink Base - 42" W	●+	●+	●	●	●	●	●	●	●	●
VSB48	Vanity Sink Base - 48" W	●+	●+	●	●	●	●	●	●	●	●
VSBDR30	Vanity Sink Drawer Base Right - 30" W	●+	●+	●	●	●	●	●	●	●	-
VSBDL30	Vanity Sink Drawer Base Left - 30" W	●+	●+	●	●	●	●	●	●	●	-
VSBDR36	Vanity Sink Drawer Base Right - 36" W	●+	●+	●	●	●	●	●	●	●	●
VSBDL36	Vanity Sink Drawer Base Left - 36" W	●+	●+	●	●	●	●	●	●	●	●
KD24	Vanity Drawer - 24" W	●	●	●	●	●	●	●	●	●	●
KD36	Vanity Drawer - 36" W with Adjustable Sides	●	●	●	●	●	●	●	●	●	●
VSOS36	Open Shelf Vanity SB - 36" W	●	●	●	●	●	●	●	●	●	-
<b>Moldings and Trim</b>											
TKS8	Toe Kick	●	●	●	●	●	●	●	●	●	●
SCRIBE	Scribe	●	●	●	●	●	●	●	●	●	●
SHOE	Shoe Molding	●	●	●	●	●	●	●	●	●	●
FBM8	Furniture Base Molding	●	●	●	●	●	●	●	●	●	●
CM8	Traditional Crown Molding	-	-	-	-	●	●	●	●	●	●
BCM8	Large Crown Molding	-	-	-	-	●	●	●	●	●	●
RCM8	Royal Crown Molding	●	●	●	●	●	●	●	●	●	●
SCM8	Shaker Crown Molding	●	●	●	●	-	-	-	-	-	-
COM8	Cove Crown Molding	●	●	●	●	●	●	●	●	●	●
BAM8	Batten Molding	●	●	●	●	●	●	●	●	●	●
OCM8	Outside Corner Molding	●	●	●	●	●	●	●	●	●	●
LRM8	Traditional Light Rail	●	●	●	●	●	●	●	●	●	●
BEM8	Bottom Edge Molding (Narrow Light Rail)	●	●	●	●	●	●	●	●	●	●
<b>Fillers and Panels</b>											
BPLG4896	Back Panel (Long Grain) - 48" W x 96" H	●	●	●	●	●	●	●	●	●	●
BBP4842	Bead Board - 48" W x 42" H x 0.25" D	●	●	●	●	●	●	●	●	●	●
PSP4896	1/2" Thick Finished Plywood Panel 96" W x 48" H	●	●	●	●	●	●	●	●	●	●
DWR3	Dishwasher End Panel 3" W x 34.5" H x 24" D	●	●	●	●	●	●	●	●	●	●
TEP3096	Tall End Panel 1.5" W x 96" H x 30" D	●	●	●	●	●	●	●	●	●	●
BCE1596	Book Case End - 1.5" W x 96" H x 15" D	●	●	●	●	●	●	●	●	●	●
F396	Filler - 3" W x 96" H	●	●	●	●	●	●	●	●	●	●
F696	Filler - 6" W x 96" H	●	●	●	●	●	●	●	●	●	●
OLF330	Overlay Filler - 3" W x 30" H	●	●	●	●	●	●	●	●	●	●
OLF336	Overlay Filler - 3" W x 36" H	●	●	●	●	●	●	●	●	●	●
OLF342	Overlay Filler - 3" W x 42" H	●	●	●	●	●	●	●	●	●	●
OLF630	Overlay Filler - 6" W x 30" H	●	●	●	●	●	●	●	●	●	●
FF396	Fluted Filler - 3" W x 96" H	-	-	-	-	●	●	●	●	●	●

\*All Shaker Designer White drawers are available with either a slab drawer front or 5-Piece drawer front. All 5-Piece SKUs are notated with '5PC' on the Order Form

Item Code	Item Description	Shaker Sand	Shaker Designer White	Shaker Espresso	Shaker Kodiak	Brooklyn Modern Gray	Brooklyn Bright White	Brooklyn Slate	Brooklyn Midnight	Napa White	Lenox Canvas
<b>Premier</b>											
<b>Decorative Accessories</b>											
CORSM	Basic Medium Corbel - 10.5" H	•	•	•	•	•	•	•	•	•	•
CORT	Transitional Corbel 3.5" W x 10.5" H x 7" D	•	•	•	•	•	•	•	•	•	•
TBUNFOOT	Traditional Bunfoot 3" W x 4.5" H x 3" D	•	•	•	•	•	•	•	•	•	•
TBUNFOOT2	Transitional Bunfoot 4.5" H x 3.5" T x 2" B	•	•	•	•	•	•	•	•	•	-
TPOSTP3	Turned Post - 3" W x 35.5" H	•	•	•	•	•	•	•	•	•	•
TPOSTP5	Turned Post - 5" W x 35.5" H	•	•	•	•	•	•	•	•	•	•
VFURN37	Furniture Valance - 37" W	•	•	•	•	•	•	•	•	•	•
VRP42	Raised Panel Valance - 42" W	-	-	-	-	•	•	•	•	•	•
VRP48	Raised Panel Valance - 48" W	-	-	-	-	•	•	•	•	•	•
DWP1215	Decorative Wall Panel - 12" W x 15" H	•	•	•	•	•	•	•	•	•	-
DWP1230	Decorative Wall Panel - 12" W x 30" H	•	•	•	•	•	•	•	•	•	•
DWP1236	Decorative Wall Panel - 12" W x 36" H	•	•	•	•	•	•	•	•	•	•
DWP1242	Decorative Wall Panel - 12" W x 42" H	•	•	•	•	•	•	•	•	•	•
DWP2415	Decorative Wall Panel - 24" W x 15" H	•	•	•	•	•	•	•	•	•	-
DWP2430	Decorative Wall Panel - 24" W x 30" H	•	•	•	•	•	•	•	•	•	•
<b>Attachments and Inserts</b>											
ROT15-SC	Natural Roll Out Tray for 15" Space (2/pkg)	•	•	•	•	•	•	•	•	•	•
ROT18-SC	Natural Roll Out Tray for 18" Space (2/pkg)	•	•	•	•	•	•	•	•	•	•
ROT21-SC	Natural Roll Out Tray for 21" Space (2/pkg)	•	•	•	•	•	•	•	•	•	•
ROT24-SC	Natural Roll Out Tray for 24" Space (2/pkg)	•	•	•	•	•	•	•	•	•	•
ROT27-SC	Natural Roll Out Tray for 27" Space (2/pkg)	•	•	•	•	•	•	•	•	•	•
ROT30-SC	Natural Roll Out Tray for 30" Space (2/pkg)	•	•	•	•	•	•	•	•	•	•
ROT33-SC	Natural Roll Out Tray for 33" Space (2/pkg)	•	•	•	•	•	•	•	•	•	•
ROT36-SC	Natural Roll Out Tray for 36" Space (2/pkg)	•	•	•	•	•	•	•	•	•	•
LSK	Natural Lazy Susan Kit (2/pkg)	•	•	•	•	•	•	•	•	•	•
TCKK	Trash Can Insert for B18 with 2 35 QT Trash Cans	•	•	•	•	•	•	•	•	•	•
SRI9	Natural Spice Rack Insert for B9 Drawer	•	•	•	•	•	•	•	•	•	•
CDI14	Natural Cutlery Drawer Insert for B15/B18	•	•	•	•	•	•	•	•	•	•
CDI20	Natural Cutlery Drawer Insert for B21/B24	•	•	•	•	•	•	•	•	•	•
SRD12	Natural Spice Rack Door Mount for 18" Door	•	•	•	•	•	•	•	•	•	•
SRD15	Natural Spice Rack Door Mount for 21" Door	•	•	•	•	•	•	•	•	•	•
STI14	Natural Spice Tray Drawer Insert for B15/B18	•	•	•	•	•	•	•	•	•	•
STI20	Natural Spice Tray Drawer Insert for B21/B24	•	•	•	•	•	•	•	•	•	•
SWR3012	Stemware Rack	•	•	•	•	•	•	•	•	•	•
<b>Miscellaneous Parts</b>											
SHELF1296	Natural Shelf - 96" W x 12" D	•	•	•	•	•	•	•	•	•	•
SHELF1296	Painted/Stained Shelf - 96" W x 12" D	•	•	•	•	•	•	•	•	•	•
SHELF2496	Natural Shelf - 96" W x 24" D	•	•	•	•	•	•	•	•	•	•
SPRAYCAN	Aerosol Spray Can	•	•	•	•	•	•	•	•	•	•
TUKIT	Touch Up Kit	•	•	•	•	•	•	•	•	•	•
YN-PAB	Plastic Assembly Blocks (100/pkg)	•	•	•	•	•	•	•	•	•	•
YN-BRACKETS	Metal Assembly Bracket (12/pkg)	•	•	•	•	•	•	•	•	•	•
YN-SOFTCLOSE	Soft Close Hinge	•	•	•	•	•	•	•	•	•	•
YN-ERHINGE-SET	Easy Reach Hinges - Includes 2 frame-to-door & 2 door-to-door hinges	•	•	•	•	•	•	•	•	•	•
YN-SOFTCLOSE-CW	Soft Close Corner Wall Hinge	•	•	•	•	•	•	•	•	•	•
YN-BUMPER	Clear bumpers (50/sheet)	•	•	•	•	•	•	•	•	•	•
YN-Drawer Slide-Kitchen	Drawer Slide-Kitchen Pair	•	•	•	•	•	•	•	•	•	•
YN-Drawer Slide-Vanity	Drawer Slide - Vanity Pair	•	•	•	•	•	•	•	•	•	•
YN-SHELF CLIP	Shelf Clip	•	•	•	•	•	•	•	•	•	•

Item Code	Item Description	Shaker Sand	Shaker Designer White	Shaker Espresso	Shaker Kodiak	Brooklyn Modern Gray	Brooklyn Bright White	Brooklyn Slate	Brooklyn Midnight	Napa White	Lenox Canvas
<b>Premier</b>											
<b>Samples &amp; Sales Tools</b>											
Sample Doors-Complete Set with 2 Bags	Sample Door Set - Includes 15"X15" Sample of Each Door	•	•	•	•	•	•	•	•	•	•
Sample B15 Door Front Set	Sample B15 Door Front Set - Includes All B15 Fronts	•	•	•	•	•	•	•	•	•	•
SAMPLE BAG ONLY	Sample Bag Only	•	•	•	•	•	•	•	•	•	•
SAMPLE CART	Carrying Cart for Samples	•	•	•	•	•	•	•	•	•	•
SAMPLE MOLDING SET	Sample Molding Set - Includes Sample of All Molding Types	•	•	•	•	•	•+	•	•	•	•
SAMPLE	Sample Door - 15" W x 15" H	•	•	•	•	•	•	•	•	•	•
SAMPLEB15	B15 Sample Door, Drawer Front & Face Frame	•	•	•	•	•	•	•	•	•	•

\*All Shaker Designer White drawers are available with either a slab drawer front or 5-Piece drawer front. All 5-Piece SKUs are noted with '5PC' on the Order Form

## NOTES:

---

---

---

---

---

---

---

---

---

---

---

---

---

---

---

---

---

---

---

---

---

---

---

---

---

---



## **RALEIGH**

2114 ATLANTIC AVE.  
SUITE 106  
RALEIGH, NC 27604

## **HOUSTON**

600 FALLBROOK DR.  
SUITE 100  
HOUSTON, TX 77038

(833) 229-0009  
WWW.KCDUS.COM

## **RENO**

9585 N VIRGINIA ST.  
SUITE 100  
RENO, NV 89506

## **ORLANDO**

650 HERMIT SMITH RD.  
SUITE 100  
APOPKA, FL 32703