



Anza Valley Welding & Fabrication, Inc.

Trailer Parts Catalog

760-500-3217



Scan for Website

Office@anzavalleywelding.com

WWW.ANZAVALLEYWELDING.COM



Trailer Parts

Contents

- Disclaimer - 1
- Safety Chains, Channel Mounts, Pintle Eyes - 2
- Couplers - 3
- Misc. Parts, Tie Downs, Anchors - 4
- Dump Trailers - 5
- Trucker Winches & Straps, Ramps - 6
- Pintle Hitches, Hitches - 7
- Receiver Tube, Hitch Pins, Reducer Bushings, Universal Hitch - 8
- Fenders - 9
- Jacks, Fifth Wheel Jacks - 10/11
- Rims & Tires - 12/14
- Lug Studs, Lug Nuts, Spare Tire Carriers - 15
- Axles, Axle Kits - 16
- Hanger Kits, Shackles, Bushings - 17
- Spring Kits, Spring Pads - 18
- Bearings, Races, Seals, Dust Caps - 19
- Brakes - 20
- Break-Away switches, Batteries & Chargers, Battery Boxes - 21
- Electrical Components - 21/22
- Lighting - 22/24
- Safety/Work Lighting - 24
- Diagrams - 24/38



Brands We Use



DEMCO



REESE



FULTON



CURT

DRAW-TITE



BLAZER
international



FASTWAY
TRAILER PRODUCTS

TEKONSHA

Deka



PETERSON
MANUFACTURING COMPANY

Trailer Parts

Disclaimer and Terms of Sale

Anza Valley Welding and Fabrication, Inc. ("AVWF, INC.")
Customer ("Customer")

Return Policy

Parts may be returned within ten (10) calendar days of the original purchase date and must be accompanied by the original receipt. Returned parts must be in new, unused, and uninstalled condition. Any part that shows evidence of installation, modification, or use will not be accepted. All returns are subject to inspection and final approval at the sole discretion of AVWF, INC.

Raw Steel Materials

Raw steel products may contain surface rust, mill scale, or an oily protective coating as a result of the manufacturing and storage process at the steel mill. Such conditions are normal and do not compromise or affect the structural integrity, performance, or quality of the material.

Diagrams, Charts, and Technical Information

Any diagrams, charts, measurements, or technical data provided are supplied by third-party manufacturers, suppliers, or vendors for informational purposes only. AVWF, INC. does not warrant or guarantee the accuracy, completeness, or applicability of such information and assumes no liability for errors or omissions.

Part Quality and Defective Parts

AVWF, INC. is not responsible for manufacturing defects in new parts supplied by third-party manufacturers. Defective parts, which are common within the automotive and fabrication industries, will be accepted for return and replaced or refunded as appropriate. No labor costs, reimbursement charges, discounts, credits, or additional compensation will be provided beyond replacement of the defective part or a refund of the original purchase price, at AVWF, INC.'s discretion.

Brands and Product Selection

The brands and parts utilized or offered by AVWF, INC. are selected based on design, strength, quality, manufacturer reputation, and AVWF, INC.'s professional judgment. AVWF, INC. does not receive compensation, sponsorship, or incentives for promoting any brand or product. Product selection is based on over fifteen (15) years of industry experience evaluating performance, reliability, and failure rates.

Special Orders

Approximately ninety-five percent (95%) of parts are special-order items. Availability, lead times, and pricing are subject to change. Customers are encouraged to contact AVWF, INC. for current details prior to placing an order.

Shipping

All special-order parts are subject to shipping charges. Shipping costs are the responsibility of the Customer and will be added to the total invoice.

Professional Qualifications

AVWF, INC. is a professional welding and fabrication company certified in structural welding in accordance with the American Welding Society (AWS) D1.1 Structural Welding Code. AVWF, INC. holds certifications in Automotive, Diesel, and Industrial Technologies, as well as three (3) California State Contractor licenses in Welding and Structural Steel. AVWF, INC. provides professional journeyman-level welding and fabrication services.

Warranty Disclaimer

All parts, materials, products, and services provided by Anza Valley Welding and Fabrication ("AVWF, INC.") are provided "AS IS" and "AS AVAILABLE," unless otherwise expressly stated in writing. AVWF, INC. makes no warranties, express or implied, regarding any products or services, including but not limited to any implied warranties of merchantability, fitness for a particular purpose, workmanship, or non-infringement.

Any manufacturer warranties that may apply are solely the responsibility of the manufacturer. AVWF, INC. does not provide, extend, or administer manufacturer warranties and makes no representation regarding the scope or enforceability of such warranties.

Limitation of Liability

To the fullest extent permitted by law, AVWF, INC. shall not be liable for any indirect, incidental, consequential, special, or punitive damages, including but not limited to loss of profits, loss of use, downtime, loss of business, or personal injury arising out of or related to the sale, installation, use, misuse, or failure of any part, material, or fabricated item. AVWF, INC.'s total liability, whether arising in contract, tort, strict liability, or otherwise, shall be strictly limited to the amount paid by the Customer for the specific part, material, or service giving rise to the claim.

Labor and Installation Disclaimer

AVWF, INC. is not responsible for labor costs, installation charges, removal costs, reinstallation costs, or associated expenses related to defective or failed parts unless expressly agreed to in writing prior to the work being performed.

Customer Responsibility

The Customer acknowledges and agrees that it is their responsibility to ensure that all parts, materials, and fabricated components are suitable for their intended use and application. AVWF, INC. shall not be liable for damages resulting from improper installation, misuse, modification, lack of maintenance, or use outside of the intended design parameters.

Indemnification

The Customer agrees to indemnify, defend, and hold harmless AVWF, INC., its owners, employees, and agents from any and all claims, damages, losses, liabilities, and expenses, including reasonable attorneys' fees, arising out of or related to the Customer's use, resale, installation, or modification of any products or services provided by AVWF, INC.

Governing Law

These terms and conditions shall be governed by and construed in accordance with the laws of the State of California, without regard to its conflict of law principles.

Trailer Parts

Safety Chains



Chain 1/4" GRD 70 Safety 36"
Break Strength : 12,600lbs
Chain Size : 1/4"
Length : 36"
WLL : 3,150lbs
Code: SC143670WSH
Tuff-Tow



Chain 5/16" GRD 70 Safety 36"
Break Strength : 18,000lbs
Chain Size : 5/16"
Length : 36"
WLL : 4,700lbs
Code: SC5163670WCH
Tuff-Tow



Chain 3/8" GRD 70 Safety 36"
Break Strength : 26,400lbs
Chain Size : 3/8"
Length : 36"
WLL : 6,600lbs
Code: SC383670WCH
Tuff-Tow

Channel Mounts



Channel Mount 3 Position
ID : 3"
Pairs of Holes : 4
Size : 3-1/2" X 7-1/2"
Type : 3 Position
Code: CU48610
Curt, Mfg.



Channel Mount 5 Position
ID : 3"
Pairs of Holes : 6
Size : 3-1/2" x 11-3/4"
Type : 5 Position
Code: CU48650
Curt, Mfg.



Nose Plate 3 Position
Pairs of Holes : 4Pr
Size : 7" X 16"
Type : 3 Position
Code: TNP116625750
Buyers

Pintle Lunette Eyes



Lunette Eye Adj 24K 3in ID
Capacity : 24,000lbs
Style : Channel-Mount
Thickness : 1.56"
Width : 2.75" x ID : 3"
Code: CU48660
Curt, Mfg.



Lunette Eye 4-Bolt 35K
Capacity : 35,000lbs
Style : Flush-Mount
Thickness : 1.50"
Width : 4.5" X 4.5" x ID : 2-1/2"
Code: CU48550
Curt, Mfg.



Lunette Eye 4-Bolt 60K
Capacity : 60,000lbs
Style : Flush-Mount
Thickness : 1.63"
Width : 4.5" X 4.5" x ID : 3"
Code: CU48560
Curt, Mfg.

Trailer Parts

Couplers



Coupler 2"x2" 3.5K
Ball Size : 2"
Capacity : 3,500lbs
Color : Zinc
Width : 2"
Code: TTC3001Z
Tuff-Tow



Coupler 2"x2-1/2" 3.5K
Ball Size : 2"
Capacity : 3,500lbs
Color : Zinc
Width : 2-1/2"
Code: TTC3002Z
Tuff-Tow



Coupler 2"x3" 3.5K
Ball Size : 2"
Capacity : 3,500lbs
Color : Zinc
Width : 3"
Code: TTC3003Z
Tuff-Tow



Coupler 2"x3" 5K
Ball Size : 2"
Capacity : 5,000lbs
Color : Zinc
Width : 3"
Code: TTC5003Z
Curt, Mfg.



Coupler 2"x3" 6K
Ball Size : 2"
Capacity : 6,000lbs
Color : Zinc
Width : 3"
Code: Q34600 0301
Fulton



Coupler 2"x3" 10K
Ball Size : 2"
Capacity : 10,000lbs
Color : Zinc
Width : 3"
Demco



Coupler A-Frame 2-5/16" 10K
Ball Size : 2-5/16"
Capacity : 10,000lbs
Color : Primed
Code: CU25200
Curt, Mfg.



Coupler A-Frame 2-5/16" 14K
Ball Size : 2-5/16"
Capacity : 14,000lbs
Color : Primed
Code: TTCA5400
Tuff-Tow



Coupler A-Frame 2in 5K
Ball Size : 2"
Capacity : 5,000lbs
Color : Primed
Code: TTCA5100
Tuff-Tow

Trailer Parts

Misc. Parts



5/16" Safety Chain Retainer

Color : Raw
Chain Size : 5/16"
Style : Weld-On
Code: B5471000
Buyers



3/8" Safety Chain Retainer

Color : Raw
Chain Size : 3/8"
Style : Weld-On
Code: B5471001
Buyers



Channel Mount Bolt Kit (2)

Size : 5/8" x 5-1/2"
Type : Hardware
Code: CU48620
Curt, Mfg.

Tie Downs & Anchors



D-Ring 1/2" Dia. Weld On

Capacity : 4,000lbs
Color : Raw
Diameter : 1/2"
Size : 2.5" x 2.375"
Style : Weld-On
Code: TT38W
Tuff-Tow



D-Ring 5/8" Dia. Weld On

Capacity : 6,000lbs
Color : Raw
Diameter : 5/8"
Size : 3x3"
Style : Weld-On
Code: TT40W
Tuff-Tow



D-Ring 3/4" Dia. Weld On

Capacity : 9,000lbs
Color : Raw
Diameter : 3/4"
Size : 2.5" x 2.375"
Style : Weld-On
Code: TTB46
Tuff-Tow



D-Ring 1" Dia. Weld On

Capacity : 15,500lbs
Color : Raw
Diameter : 1" x Size : 4" x 3"
Style : Weld-On
Code: TTB50
Tuff-Tow



D-Ring 1/2" Dia. Bolt On

Capacity : 4,000lbs
Color : Raw
Dia. : 1/2" x Size : 2.5" x 2.375"
Style : Bolt-On
Code: TT38
Tuff-Tow



D-Ring 1/4" Strap Tie Down

Capacity : .8K
Color : Steel
Dia. : 1/4" x Size : 1" x 1.3125"
Style : Bolt-On
Code: B20
Buyers

Trailer Parts

Dump Trailer Related



Hinge Short Strap w / Zerk

Color : Raw
 Length : 3.85"
 Type : Strap
 Width : 4.33"
 Code: B2426FS
 Buyers



Hinge Long Strap w / Zerk

Color : Raw
 Length : 5.85"
 Type : Strap
 Width : 4.33"
 Code: B2426FSLL
 Buyers



Latch Cam Action Kit

Color : Cast
 Type : Latch
 Code: B2159C
 Buyers



Bar Lock Assembly 36in

Color : Zinc
 Length : 36"
 Type : Latch
 Code: TT1430
 Buyers



Dump Trailer Hoist Hinge Medium

Duty
 Capacity : NA
 Color : Raw
 Size : NA
 Code: TTRH-MHG
 Tuff-Tow



Dump Trailer Hoist Hinge Heavy

Duty
 Capacity : NA
 Color : Raw
 Size : NA
 Code: TTRH-LHG
 Tuff-Tow

Other Models Available



Dump Trailer Hoist Kit 516

Capacity : See Chart
 Color : Raw
 Ram: 5" Dia. x Stroke: 16"
 Style : Weld-On
 Code: TTRH-516-B-KIT
 Tuff-Tow

Dump Compartment Body Length (ft)	Overhang (ft)	RH-310	RH-310	RH-516	RH-516	RH-520	RH-520
		Max Angle 45 degrees PL=52"	Max Angle 50 degrees PL=47"	Max Angle 45 degrees PL=76"	Max Angle 50 degrees PL=67.5"	Max Angle 45 degrees PL=96.75"	Max Angle 50 degrees PL=87.75"
8	1	3.8	3.4				
8	1.5	4.5	4.0				
8	2	5.6	5.0				
9	1	3.1	2.9				
9	1.5	3.8	3.4				
9	2	4.5	4.1				
10	1	2.9	2.4	9.7	8.6	12.4	11.2
10	1.5	3.2	2.9	11.1	9.8	14.1	12.8
10	2	3.8	3.4	12.9	11.5	16.5	14.9
12	1			7.8	6.9	9.9	9.0
12	1.5			8.6	7.7	11.0	9.9
12	2			9.7	8.6	12.4	11.2
14	1			6.5	5.7	8.2	7.5
14	1.5			7.0	6.3	9.0	8.1
14	2			7.8	6.9	9.9	9.0
16	1					7.1	6.4
16	1.5					7.6	6.9

All information above is a general guide. It is trailer manufacturer's responsibility as to overall capacities for a specific trailer design. These calculations are also based on a level/evenly dispersed load.

Trailer Parts

Truck Winches & Straps



Winch Stand 4in Weld-On

Color : Black

Size : 4"

Type : Strap Winch

Style : Weld-On

Code: T41903005

Buyers



Strap w/ Flat Hook

Length : 30'

Width : 4"

WLL : 5,400lbs

Code: T3012YFH

Tuff-Tow



Winch Bar Combination

Color : Silver

Code: B1903065

Tuff-Tow

Ramps



Ramp Torsion Spring LH

Capacity : NA

Color : Raw

Diameter : 5/8"

Size : NA

Code: B3002879

Buyers



Ramp Torsion Spring RH

Capacity : NA

Color : Raw

Diameter : 5/8"

Size : NA

Code: B3002880

Buyers



2" Angle Iron Steel Ramps

Capacity : 5,000lbs

Color : Raw.

Dimensions: 2" x 49" x 14"

Code: 1-05RMP2

TPO



3" Channel Heavy Duty Ramps

Capacity : 8,000lbs

Color : Raw.

Dimensions: 3" x 67" x 18"

Code: 1-08RMP3

TPO



4" Channel Heavy Duty Ramps

Capacity : 10,000lbs

Color : Raw.

Dimensions: 4" x 66" x 18"

Code: 1-10RMP4

TPO

**Custom Fabricated Ramps Available.
Call for Details!**

Trailer Parts

Pintle Hitches



Pintle Combo 2" 8 Ton

Ball Size : 2"
 Bolt Dia : 1/2"
 Bolt Pattern : 1-3/4" x 3-3/8"
 Capacity : 16,000lbs
 Type : Pintle Mount
 Code: 10050
 Buyers



Pintle Combo 2-5/16" 8 Ton

Ball Size : 2-5/16"
 Bolt Dia : 1/2"
 Bolt Pattern : 1-3/4" x 3-3/8"
 Capacity : 16,000lbs
 Type : Pintle Mount
 Code: 10055
 Buyers



Pintle Mount 3 Position

Receiver Size : 2-1/2"
 Capacity : 20,000lbs
 Shank Length : 9-1/2"
 Bolt Pattern : 1-3/4" x 3-3/8"
 Code: PM25812
 Buyers

Hitches

Understanding Hitch Sizes



1 1/4in



2in



2.5in



3in

LENGTH

Distance from the center of the ball hole to the center of the pin hole.



LENGTH

RISE

Distance from the top of the shank to the top of the ball platform.



RISE

DROP

Distance from the top of the shank to the top of the ball platform.



DROP



Mount Tri-Ball 5K-10K

Ball Size : 1-7/8", 2", 2-5/16"
 Capacity : 5K-7.5K-10K
 Receiver Size : 2"
 Shank Length : 7", 8-1/2"
 Code: CU45650
 Curt, Mfg.



Mount Tri-Ball 5K-14K

Ball Size : 1-7/8", 2", 2-5/16"
 Capacity : 5K-10K-14K
 Receiver Size : 2-1/2"
 Shank Length : 7", 8-1/2"
 Code: CU45651
 Curt, Mfg.



Dual Ball Mount Titan 25 K

Ball Size : 2", 2-5/16"
 Capacity : 17K-25K
 Receiver Size : 3"
 Shank Length : 9"
 Code: Q38180
 Draw-Tite

Trailer Parts

Receiver Tube



Receiver Tube 2" x 18"

2" ID
Color : Raw
Length : 18"
Receiver Size : 2"
Code: CU49180
Curt, Mfg



Receiver Tube 2-1/2" x 18"

2-1/2" ID
Color : Raw
Length : 18"
Receiver Size : 2-1/2"
Code: CU49511
Curt, Mfg



Receiver Tube 3" x 18"

3" ID
Color : Raw
Length : 18"
Receiver Size : 3"
Code: CU49180
Curt, Mfg

Hitch Pins



Pin & Clip 5/8"
Color : Zinc
Length : 4"
Pin Dia : 5/8"
Code: CU21581
Curt, Mfg.



Pin & Clip 5 / 8in HD
Color : Zinc
Length : 4.81"
Pin Dia : 5/8"
Code: CU21507
Curt, Mfg.



Receiver Pin w/ Clip 3/4in
For 3 inch
Color : Black
Length : 6"
Pin Dia : 3/4"
Code: Q58388
Reese

Reducer Bushings & Universal Hitch



Receiver Multi Fit 2"
Color : Black
GVW : 20,000lbs
Receiver Size : 2"
Style : Class IV - Bolt On
Code: 1804055
Buyers



Reducer Bushing 2-1/2" to 2"
ID : 2"
Length : 5.75"
Receiver Size : 2-1/2"
Code: RHXA2182
B&W



Reducer Bushing 3" to 2-1/2"
ID : 2.5"
Length : 5.75"
Receiver Size : 3"
Code: RHXA2183
B&W

Trailer Parts

Fenders



Fender 9"x14"x33" Flat 16ga

Gauge : 16
Height : 14"
Length : 33"
Style : Flat
Width : 9"
Code: MFR242
Rockwell American



Fender 9"x34" Flat 14ga

Gauge : 14
Height : 17"
Length : 34"
Style : Flat
Width : 9"
Code: F1F953534C14
Rockwell American



Fender 7.5" x 28.5" Flat 14ga

Gauge : 14
Height : 13"
Length : 28-1/2"
Style : Flat
Width : 7-1/2"
Code: F7542285
Rockwell American



Fender 7.5"x24" Flat 14ga

Gauge : 14
Height : 7-1/2"
Length : 24"
Style : Flat
Width : 7-1/2"
Code: F753024
Rockwell American



Fender 8"x13"x28.5" Flat 16ga

Gauge : 16
Height : 13"
Length : 28-1/2"
Style : Flat
Width : 8"
Code: MFR240
Rockwell American

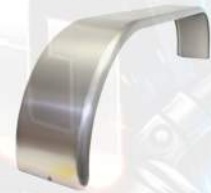

Fender 10"x17"x72" Flat 16ga

Gauge : 16
Height : 17"
Length : 72"
Style : Flat
Width : 10"
Code: MFR238
Rockwell American



Fender 9"x17"x72" Flat 16ga

Gauge : 16
Height : 17"
Length : 72"
Style : Flat
Width : 9"
Code: MFR243
Rockwell American



Fender 9x102 Flat 14ga

Gauge : 14
Height : 17"
Length : 102"
Style : Flat
Width : 9" : 2"
Code: F90102
Rockwell American



Fender 9x17x102 Flat 16ga

Gauge : 16
Height : 17"
Length : 102"
Style : Flat
Width : 9"
Code: MFR241
Rockwell American

Trailer Parts

Jacks



Jack A-Frame 5K TW
Weight Cap : 5,000lbs
Extended : 25"
Offset : 9"
Retracted : 11"
Style : A-Frame TopWind
Code: TTJA5000T
Tuff-Tow



Jack Sq Mount 5K SW
Weight Cap : 5,000lbs
Extended : 30.1"
Offset : 9.25"
Retracted : 15.1"
Size : 5/8" Pin
Style : Sq Mt Sidewind
Code: Q195362
Bulldog



Jack A-Frame Drop Leg 5K TW
Weight Cap : 5,000lbs
Extended : 37.5"
Case O.D. : 2.255"
Offset : 13.5"
Retracted : 22.5"
Style : Dropleg TopWind
Code: Q195318
Bulldog



Jack Drop Leg 5K SW
Weight Cap : 5,000lbs
Extended : 39.5"
Case O.D. : 2.75"
Retracted : 24.5"
Style : Dropleg Side Wind
Code: TTJD5000S
Tuff-Tow



Jack Drop Leg 8K SW
Weight Cap : 8,000lbs
Extended : 38.5"
Case O.D. : 2.75"
Retracted : 23.5"
Style : Dropleg Sidewind
Code: TTJD7000S
Tuff-Tow



Jack Drop Leg 10K SW
Weight Cap : 10,000lbs
Extended : 41.04"
Case O.D. : 3"
Retracted : 20.92"
Style : Dropleg Sidewind
Code: Q180405
Bulldog



Jack Drop Leg 12K SW
Weight Cap : 12,000lbs
Extended : 54.0"
Case O.D. : 4.015"
Retracted : 28.5"
Style : Dropleg Sidewind
Code: TTJD12000SPRS
Tuff-Tow



Jack Drop Leg 15K SW
Weight Cap : 15,000lbs
Extended : 41.875"
Case O.D. : 4.3125"
Retracted : 27.125"
Style : Dropleg Sidewind
Code: TTJD15000SPRS
Tuff-Tow



Jack Drop Leg 25K SW
Weight Cap : 25,000lbs
Extended : 54.5"
Case O.D. : 4"
Retracted : 28.5"
Style : Dropleg Sidewind
Code: Q182701
Bulldog

Trailer Parts

Jack Parts



Handle Top Wind
w/ Nut & Bolt
Style : A-Frame TopWind
Code: TJA2000HD
Tuff-Tow



Handle 12K Jack
w/ Nut & Bolt
Style : Sq Mt Sidewind
Code: TTJD12HD
Tuff-Tow



Handle 25K Jack
w/ Nut & Bolt
Style : Sq Mt Sidewind
Code: QB00102
Bulldog



Jack Foot 2K-5K
Weight Cap : 5,000lbs
Color : Zinc
Code: Q500244
Bulldog

Fifth Wheel Jacks



Jack Landing Gear BK
Weight Cap : 16,000lbs
Extended : NA
Case O.D. : NA
Retracted : NA
Style : Dropleg Sidewind
Code: Q500162
Bulldog



Jack 5th Wheel Power- Pair BK
Weight Cap : 16,000lbs
Extended : NA
Case O.D. : NA
Retracted : NA
Style : Dropleg Sidewind
Code: Q500708
Bulldog



Gear Box 3:1 Reduction
Style : Dropleg Sidewind BK
Code: TTRVLGRDBOX
Bulldog



Handle Manual
Style : Handle
Code: TTRVLGHDL
Tuff-Tow

Trailer Parts

Rims & Tires

When Ordering:

You need to know your rim style, tire size, bolt pattern.



Mod = Modular Rim Style



Spk = Spoke Rim Style

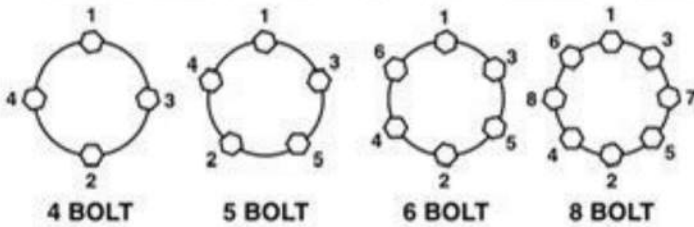

Maximum Wheel Fastener Torque

The wheel mounting studs used on Dexter axles conform to the SAE standards for grade 8. The maximum torque level that can be safely applied to these studs is listed in the following chart:

Stud Size	Maximum Torque
1/2"-20 UNF, class 2A	120 Ft. Lbs.
9/16"-18 UNF, class 2A	170 Ft. Lbs.
5/8"-18 UNF, class 2A	325 Ft. Lbs.

12" Rim



TW530-12C 440 Spk Wht
 Bolt Pattern : 4 on 4
 Color : White
 OD : 21.9"
 Offset : 0"
 Pilot Hole : 2.625"
 Section Width : 5.4"
 Tire Ply : C 6ply
 Tire Type : Bias
 Wheel Size : 12"
 Wheel Style : Spoke
 Weight Cap : 1,045lbs
 Code: TW53012C440WS
 Generic



TW530-12C 545 Mod Wht
 Bolt Pattern : 5 on 4.5
 Color : White
 OD : 21.4"
 Offset : 0"
 Pilot Hole : 2.875"
 Section Width : 5.5"
 Tire Ply : C 6ply
 Tire Type : Bias
 Wheel Size : 12"
 Wheel Style : Modular
 Weight Cap : 1,045lbs
 Code: TW53012C545MW
 Generic

Trailer Parts

Rims & Tires Cont'd.

15" Rim - 205 Series



TW205-75R15C 550 Spk Wht

Bolt Pattern : 5 on 5

Color : White

OD : 27"

Offset : 0"

Pilot Hole : 3.30"

Section Width : 8.1"

Tire Ply : 0 8ply

Tire Type : Radial

Wheel Size : 15"

Wheel Style : Spoke

Weight Cap : 1,870lbs

Code: TW20515R5505SWG

Generic



TW205-75R15D 555 Spk Wht

Bolt Pattern : 5 on 5.5

Color : White

OD : 27.3"

Offset : 0

Pilot Hole : 4.2"

Section Width : 7.8"

Tire Ply : 0 8ply

Tire Type : Radial

Wheel Size : 15"

Wheel Style : Spoke

Weight Cap : 1,820lbs

Code: TW20515R5555SW

Generic



TW205-75R15D 655 Mod Wht

Bolt Pattern : 6 on 5.5

Color : White

OD : 27"

Offset : 0"

Pilot Hole : 4.29"

Section Width : 8.1"

Tire Ply : 0 8ply

Tire Type : Radial

Wheel Size : 15"

Wheel Style : Modular

Weight Cap : 2,150lbs

Code: TW20515R655MWGL

Generic

15" Rim - 225 Series



TW225-75R15D 545 Mod Wht

Bolt Pattern : 5 on 4.5

Color : White

OD : 28.3"

Offset : 0"

Pilot Hole : 3.30"

Section Width : 8.7"

Tire Ply : 0 8ply

Tire Type : Bias

Wheel Size : 15"

Wheel Style : Modular

Weight Cap : 2,540lbs

Code: TW22575D15545MW

Generic



TW225-75R15D 550 Spk Wht

Bolt Pattern : 5 on 5

Color : White

OD : 28.3"

Offset : 0"

Pilot Hole : 3.30"

Section Width : 8.6"

Tire Ply : 0 8ply

Tire Type : Bias

Wheel Size : 15"

Wheel Style : Spoke

Weight Cap : 2,540lbs

Code: TW2257515D5505WS

Generic



TW225-75R15E 655 Spk Wht

Bolt Pattern : 6 on 5.5

Color : White

OD : 28.3"

Offset : 0"

Pilot Hole : 4.28"

Section Width : 8.8"

Tire Ply : E 10ply

Tire Type : Radial

Wheel Size : 15"

Wheel Style : Spoke

Weight Cap : 2,600lbs

Code: TW22515R6555SW

Generic

Trailer Parts

Rims & Tires Cont'd.

16" Rim - 235 Series - 6 Lug



TW235-80R16E 655 Spk Wht
Bolt Pattern : 6 on 5.5
Color : White
OD : 30.8"
Offset : 0"
Pilot Hole : 5.125"
Section Width : 9.5"
Tire Ply : E 10ply
Tire Type : Radial
Wheel Size : 16"
Wheel Style : Spoke
Weight Cap : 3,520lbs
Code: TW23580R16655SWGL
Generic



TW235-80R16E 655 Mod Wht
Bolt Pattern : 6 on 5.5
Color : White
OD : 31.2"
Offset : 0"
Pilot Hole : 4.29"
Section Width : 9"
Tire Ply : E 10ply
Tire Type : Radial
Wheel Size : 16"
Wheel Style : Modular
Weight Cap : 3,140lbs
Code: TW23580R16655MWGL
Generic



TW235-85R16G 655 Mod Slv
Bolt Pattern : 6 on 5.5
Color : Silver
OD : 31"
Offset : 0"
Pilot Hole : 4.29"
Section Width : 8.8"
Tire Ply : G 14ply
Tire Type : Radial
Wheel Size : 16"
Wheel Style : Modular
Weight Cap : 3,140lbs
Code: TW23585R16655SM
Generic

16" Rim - 235 Series - 8 Lug



TW235-80R16E 865 Spk Wht
Bolt Pattern : 8 on 6.5
Color : White
OD : 30.8"
Offset : 0"
Pilot Hole : 5.125"
Section Width : 9.5"
Tire Ply : E 10ply
Tire Type : Radial
Wheel Size : 16"
Wheel Style : Spoke
Weight Cap : 3,520lbs
Code: TW23580R16865SWGL
Generic



TW235-80R16E 865 Mod Wht
Bolt Pattern : 8 on 6.5
Color : White
OD : 31.7"
Offset : 0"
Pilot Hole : 5.125"
Section Width : 9"
Tire Ply : E 10ply
Tire Type : Radial
Wheel Size : 16"
Wheel Style : Modular
Weight Cap : 3,520lbs
Code: TW23580R16865MWGL
Generic



TW235-80R16G 865 Mod Wht
Bolt Pattern : 8 on 6.5
Color : White
OD : 30.8"
Offset : .50"
Pilot Hole : 5.15"
Section Width : 9.3"
Tire Ply : G 14ply
Tire Type : Radial
Wheel Size : 16"
Wheel Style : Modular
Weight Cap : 4,400lbs
Code: TW23580R16G865MW
Generic

Trailer Parts

Lug Studs

How to Order Studs!

Provide the following information when ordering new studs.



Wheel Stud 1/2" x 1-13/16"

Bolt Dia : 1/2"
Length : 1.81"
Spline Length : 0.32
Spline OD : 0.612
Thread : 20
Code: D7-122
Dexter



Wheel Stud 9/16" x 2"

Bolt Dia : 9/16"
Length : 2"
Spline Length : 0.25
Spline OD : 0.69
Thread : 18
Code: D7-223
Dexter

We can special order
any trailer wheel stud!

Lug Nuts



Nut Wheel 1/2"-20 60deg Bulge

Length : 1.72"
Style : Acorn
Thread : 1/2"-20 TPI
Code: 090654
Excalibur



Nut Wheel 1/2"-20 60deg Bulge

Length : 1.88"
Style : Acorn
Thread : 1/2"-20 TPI
Code: 090651
Excalibur



Nut Wheel 9/16"-18 60deg Bulge

Length : 1.72"
Style : Acorn
Thread : 9/16"-18 TPI
Code: 090653
Excalibur

Spare Tire Carrier



Carrier Spare Tire 545 & 440

Color : Silver
Rim Size : 12"
Style : Bolt On
Code: STC100
Tuff-Tow



Spare Tire, Carrier, Stake Pocket

Color : Black
Rim Size : 15"/16"
Style : Slip In Stake Pocket
Code: 5201012
Buyers

Trailer Parts

Axles

How to Order Replacement Axles!

Provide the following information when ordering new axles.

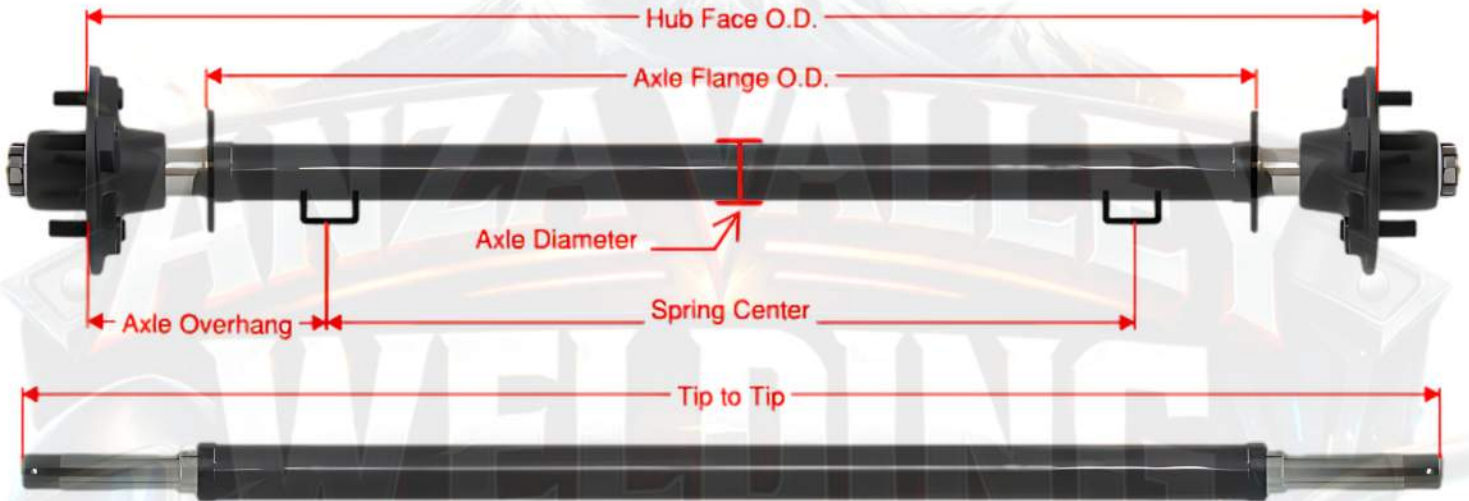

Axles and related components are Special Order and depend on Availability. Call for Details!

Axle Kits



3500 lb TK Heavy Duty Tandem Axle Kit - 7K

Capacity (Axle Series)

Color : Black

Capacity : 7,000lbs

Style: Eye to Eye Spprings

Code: 35DHDAKTTK6146545

TK, Dexter, Lippert

We can get Axle kits for the following capacities with or without brakes:

2,000lb light duty applications up to 24,000lb heavy duty capacities.

Call for Details!

Trailer Parts

Hanger Kits



Hanger Kit Single Eye
 Capacity : 2K-7K
 Spring Width : 1.75in
 Type : Single Axle
 Code: H1125
 Tuff-Tow



Hanger Kit Tandem Eye Drop / EQ
 Capacity : 3.5K-7K
 Spring Width : 1.75in
 Type : Tandem Axle
 Code: H10020
 Tuff-Tow



Hanger Kit Single Slip 10K-15K
 Capacity : 10-15K
 Spring Width : 3in
 Type : Single Axle
 Code: HAP-103-00
 Dexter

Shackles



Shackle Link Assy Short Zinc
 Color : Zinc
 Gauge : 1/2"
 Length : 2.25"
 Code: 018-026-05
 Dexter



Shackle Link Assy Long Zinc
 Color : Zinc
 Gauge : 1/2"
 Length : 3.12"
 Code: 018-027-05
 Dexter



Shackle Link 2.25in x 4 per Kit
 Color : Mill Finish
 Gauge : 4
 Length : 2.25"
 Code: TTSL2250
 Tuff-Tow

Bushings



Bushing 11 / 16 OD 9 / 16 ID
 Bolt Hole : 9/16"
 Length : 1.75"
 OD : .69"
 Type : Spring
 Code: 9160S
 Generic



Bushing 11 / 16 OD 9 / 16 ID
 Bolt Hole : 9/16"
 Length : 2"
 OD : .69"
 Type : Spring
 Code: NB-20
 Generic



Bushing 3 / 4 OD 9 / 16 ID
 Bolt Hole : 9/16"
 Length : 1.75"
 OD : .75"
 Type : Spring
 Code: 9160
 Generic

Trailer Parts

Spring Kits

How to Order Replacment Springs!

Provide the following information when ordering new springs.

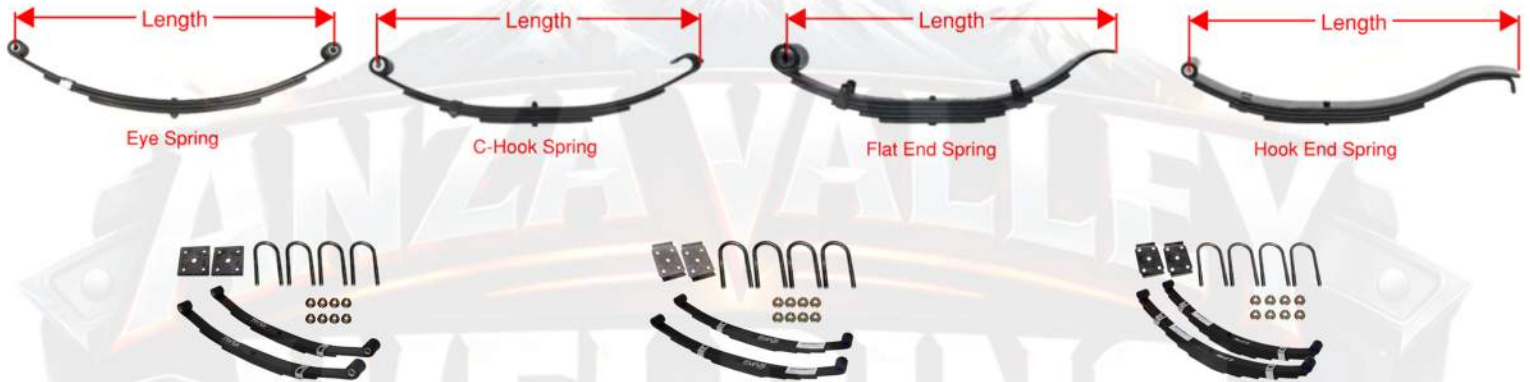

Spring & Hardware Kit 2K Pair

Axle Dia : 1-3/4"
Capacity : 2K Pair
Spring Width : 1-3/4"
Leaves: 3
Code: LC213187
Generic

Spring & Hardware Kit 3.5K Pair

Axle Dia : 2-3/8"
Capacity : 3.5K Pair
Spring Width : 1-3/4"
Leaves: 4
Code: LC213188
Generic

Spring & Hardware Kit 7K Pair

Axle Dia : 3"
Capacity : 7K Pair
Spring Width : 1-3/4"
Leaves: 7
Code: LC213193
Generic

We can get ALL springs including items not shown here in the catalog.
Call Us for your specific needs and details!

Spring Pads



Pad Spring 1-3 / 4in RD

GVW : 2K Trailers
Axle Dia : 1-3/4"
Spring Width : 1-3/4"
Style : Round Axle
Code: LC139875
Generic



Pad Spring 2-3 / 8in RD

GVW : 3.5K Trailers
Axle Dia : 2-3/8"
Spring Width : 1-3/4"
Style : Round Axle
Code: LC177044
Generic



Pad Spring 3in 7K

GVW : 7K Trailers
Axle Dia : 3"
Spring Width : 2"
Style : Round Axle
Code: 003-001-02
Generic

Trailer Parts

Bearing, Races, Seals, Dust Caps

How to Order Replacement Parts!

Provide the following information when ordering:



Style
EZ Lube Cap



Style
Oil Cap



Style
Solid Cap

Capacity	Inner		Outer		Seal	ID / OD	Cap, Solid	Cap, EZ Lube	OD
	Bearing	Race	Bearing	Race					
1,800lbs 1in Spindle	L44643	L44610	L44643	L44610	AB12192	1.25in x 1.98in	092102	9210101	1.98in
2,000lbs 1-1/16in Spindle	L44649	L44610	L44649	L44610	LC139514 (AB15192)	1.50in x 1.98in	092102	9210101	1.98in
3,500lbs	L68149	68111	L44649	L44610	LC122087 (AB17255)	1.72in x 2.56in	092102	9210101	1.98in
5,200/6,000lbs *	25580	25520	15123	15245	LC122088 (AB22333)	2.25in x 3.37in	35150	9210102	2.44in
5,200/6,000lbs *	25580	25520	15123	15245	AB21334	2.125in x 3.37in	35150	9210102	2.44in
7,000lbs *	25580	25520	14125A	14276	LC122088 (AB22333)	2.25in x 3.37in	605D	9210103	2.72in
7,000lbs *	25580	25520	14125A	14276	AB21334	2.125in x 3.37in	605D	9210103	2.72in
<i>*NOTE: 5.2k, 6k & 7k Axles use either 2.125in or 2.250in ID Seal</i>							<i>Rubber Plug For EZ Lube Ca p: LC122065</i>		
KIT1	L44649	>	L44649	>	LC139514	1.50in x 1.98in	>	9210101	1.98in
KIT2	L44643	>	L44643	>	AB12192	1.25in x 1.98in	>	9210101	1.98in
KIT3	L68149	>	L44649	>	LC122087	1.72in x 2.56in	>	9210101	1.98in
KIT6	25580	>	15123	>	LC122088	2.25in x 3.37in	>	9210102	2.44in
					AB21334	2.125in x 3.37in			
KIT8	25580	>	14125A	>	LC122088	2.25in x 3.37in	>	9210103	2.72in
					AB21334	2.125in x 3.37in			

We can get AG bearings Kits Also!

**Not all items shown that we can supply.
Call Us for your specific needs and details!**

Equalizers



**Equalizer Curved 7-3 / 4 in
(EQ-E1)**
Bolt Hole : 9/16"
Height : 2.88"
Length : 7.75"
Code: LC122106
Generic



**Equalizer Curved 5-3 / 4 in
(EQ-104)**
Bolt Hole : 9/16"
Height : 2"
Length : 5.75"
Code: LC126460
Generic



**Equalizer Curved 6-1 / 8 in
(EQ-356)**
Bolt Hole : 9/16"
Height : 2.5"
Length : 6.13"
Code: 91356
Generic

Trailer Parts

Brakes

How to Order Replacment Parts!
Provide the following information when ordering:



Style: (FSA) Stamped
 Forward Self Adjusting - The brakes will automatically adjust to maintain their optimal position.



Style: (STD) Stamped
 Manual Adjusting.

Supply the following:

- Trailer manufacturer, model #, GVW
- Outside diameter of brake shoes
- Pilot Hole diameter in center of backing hub
- Brake Shoe Width
- Driver Side (Left) or Passenger Side (Right)
- Style of Backing Plate
- Axle tag information

Due to the large amount of variations of brakes, all brakes & backing plates are special order items.

Call Us for your specific needs and details!

Bar Stock Spindles



Round Bar Stock Spindles

Part Number	Description	Stub Dia.	Length	Cap (1)	Use Brg Kit #
R104-BT12	Round BT8 1" grind	1.25in	8-1/4in	1,000lbs	KIT2
R204-BT12	Round BT8 1" grind	1.50in	8-1/4in	1,000lbs	KIT2
R104-BT116	Round BT16 1-1/16" grind *(Seal #)	1.25in	8-1/4in	1,250lbs	KIT1 *(AB12192)
R204-BT16	Round BT16 1-1/16" grind	1.50in	8-1/4in	1,250lbs	KIT1
R204-84	Round #84	1.50in	8-7/8in	1,750lbs	KIT3
R206-84	Round #84	1.75in	10-3/4in	1,750lbs	KIT3
R305-84	Round #84	1.75in	8-1/4in	1,750lbs	KIT3
R406-42	Round #42	2.00in	11-1/8in	3,500lbs	KIT6 (7k: KIT8)
R506-42	Round #42	2.25in	11in	3,500lbs	KIT6 (7k: KIT8)

Square Bar Stock Spindles

SP204BT12	Square BT8 1" grind	1.50in	8-1/4in	1,000lbs	KIT2
SP204BT116	Square BT16 1-1/16" grind	1.50in	8-1/4in	1,250lbs	KIT1
SP20484	Square #84	1.50in	8-1/4in	1,750lbs	KIT3
SP-20484F-725	Square #84 w/brake flange	1.50in	7-1/4in	1,750lbs	KIT3
SP355-84	Square #84	1.75in	11in	1,750lbs	KIT3
SP406-42	Square #42	2.00in	11in	3,500lbs	KIT6 (7k: KIT8)
SP-50642F-SQNW	Square #42 w/brake flange	2.00in	11in	3,500lbs	KIT6 (7k: KIT8)

Ag Specialty

AGS-3560E	Round AG Spindle	1.75in	12in	3,560lbs	KIT660
AGS-6000F	Round AG Spindle	2.75in	14in	6,000lbs	KIT880

Trailer Parts

Break-Away Switches



Break-Away Switch
Code: TTBS1
Tuff-Tow



Break-Away Switch
Code: FW80-00-2060
FastWay



Break-Away Zip Cable
Code: FW80-01-2160
Fastway

Batteries & Chargers & Kits



Battery 12V Sealed
Height : 4"
Length : 3.75"
Volts : 12v
Width : 2.75"
Code: 1242
Tuff-Tow



Break-Away Kit
w / Charger & Battery Meter
Code: TA955
Generic



Battery Charger 12V
Color : Black
Volts : 12V
Code: TTSL2250
Curt

Electrical Components



Terminal Box 7 Term Covered
Code: TT54-10-170P
Tuff-Tow



Plug 4-Flat 48in Trailer End
Length : 48"
Package Type : Pkg
Placement : Trailer
Style : 4-Way Flat
Code: TT4WP
Tuff-Tow



Plug 7-Way RV 3ft Cable
Length : 3'
Placement : Trailer
Style : 7-Way Flat
Code: H20042
Hopkins

Trailer Parts

Electrical Components Con't.



Vehicle 4-Way/7-Way Flat

Code: H47185

Hopkins



Adapter 7-Way to 4-Way Flat

Code: 724B

Tuff-Tow



Tester Emulator 7-Way Trailer

Code: Q6562

Tekonsha

Lighting



Light LED Stop / Tail Kit

Submersible : Yes

Color : Red

Diode Qty. : 11

Harness Length : 20'

Style : 2 Stud

Code: C7423

Blazer



Light LED Stop / Tail Kit

Submersible : Yes

Color : Red

Diode Qty. : 12

Length : 25'

Style : 2 Stud

Code: TTL740KP

Tuff-Tow



Light LED Stop / Mag.Tail Kit

Submersible : No

Color : Red

Diode Qty. : NA

Length : NA

Style : Magnetic

Code: C6304

Blazer



Amber LED Clearance Light

Color : Amber

Diode Qty. : 2

Size : 4-1/16x15/16"

Style : Surface

Code: V169KA

Peterson



Red LED Clearance Light

Color : Red

Diode Qty. : 2

Size : 4-1/16x15/16"

Style : Surface

Code: V169KR

Peterson



Rear Light Bar LED

Color : Red

Diode Qty. : 6

Size : 16-1/4x1-1/4"

Style : Surface

Code: H20042

Peterson

Trailer Parts

Lighting Con't.



LED Turn Kit
Color : Amber
Diode Qty. : 10
Size : 6-1/2"
Style : Grommet
Code: TTL210KAP
Tuff-Tow



LED Stop / Turn / Tail Kit
Color : Red
Diode Qty. : 20
Package Type : Mfg Pk
Size : 6-1/2"
Style : Grommet
Code: B5626520
Buyers



LED Back Up Kit
Color : White
Diode Qty. : 24
Size : 6-1/2"
Style : Grommet
Code: B5626324
Buyers



Light LED Clearance
Color : Red
Diode Qty. : 6
Size : 4x3/4"
Style : Surface
Code: TTL506RP
Tuff-Tow



Light LED Clearance
Color : Amber
Diode Qty. : 6
Size : 4x3/4"
Style : Surface
Code: TTL506A
Tuff-Tow



Plug Tail Light Male
Code: B421-491
Peterson



Amber LED Clearance Light
Color : Amber
Diode Qty. : 3
Size : 2"
Style : Grommet
Code: TTL003KAP
Tuff-Tow



Red LED Clearance Light
Color : Red
Diode Qty. : 3
Size : 2"
Style : Grommet
Code: TTL003KRP
Tuff-Tow



Plug Clearance Light Male
Code: 142-49
Peterson

Trailer Parts

Lighting Con't.



LED License w / Bracket

Color : Black
Diode Qty. : 6
Style : Surface
Code: TTL135106BP
Tuff-Tow



Grommet Oval

Color: Black
Length : 6-1/2"
Code: TTL210G
Tuff-Tow



Grommet Round

Color: Black
Diameter : 2"
Code: TTL003G
Tuff-Tow



Light Box

Color : Black
Code: LB38B
Buyers



Clearence Light Bracket

Color: Black
Hole Diameter: 2"
Code: 146-092
Peterson



Tail Light Bracket

Color: Black
Hole Diameter: 6-1/2"
Code: 421-09
Buyers

Safety/Work Lighting



Light LED Utility

Color : White
Diode Qty. : 3
Size : 3/4"
Style : Grommet
Code: TTL903C
Tuff-Tow



Light LED Work

Color : Clear
Size : 4"
Style : Post
Code: CWL505
Blazer



Light Bar LED

Color : Clear
Diode Qty. : 16-24
Size : 14"
Style : Surface
Code: 195CWL513
Blazer

Trailer Parts

Vehicle Wiring Color Chart

BRAKE CONTROL INFORMATION									
CROSS-REFERENCE BRAKE CONTROL WIRING GUIDE									
WIRE FUNCTIONS		12 VOLTS	STOPLIGHT	GROUND	TRAILER BRAKES	ILLUMINATION			
BRAKE CONTROL WIRE COLOR		BLACK	RED	WHITE	BLUE	NOT USED			
MAKE	MODEL - YEAR	VEHICLE O.E.M. WIRE COLOR							
CHEVY / GMC	2007 (New Body Style) - 2013	RED	LT BLUE	WHITE	WHITE	DARK BLUE	BROWN		
CHEVY / GMC	1999 - 2007 (Classic Body Style)	RED	LIGHT BLUE	BLACK	BLACK	DARK BLUE	BROWN		
GMC	Pickups 2014-15	RED	YELLOW	BLUE	WHITE	BLACK	BLUE	NOT USED	
GMC	SUV Tahoe / Suburban	PINK	BLUE	WHITE	BLACK	BLUE	NOT USED		
DODGE	2009-2012	RED	YELLOW	WHITE	VIOLET	BLACK	DRK GREEN	DARK GREEN	NOT USED
DODGE	2003-2008	RED	WHITE	BLUE	WHITE	BLACK	GREEN	BLUE	NOT USED
DODGE	1997-2002	RED	WHITE		BLACK	BLACK	BLUE	NOT USED	
FORD	F-250 / 350 2009-2015	RED	BROWN	BLUE	ORANGE	BLACK	GRAY	BLUE	NOT USED
FORD	F-150 2009-2015	RED or RED	GRAY	GREEN	YEL GRN	WHITE	BROWN	BLUE	NOT USED
FORD	F-150 1994-2008	RED	LIGHT GREEN		WHITE	BLACK	WHITE	DARK BLUE	BROWN
TOYOTA / LEXUS	2003-2012	BLACK	GREEN	YELLOW	BLACK	WHITE	BLUE	RED	GREEN

Wire Sizing Chart

Amps @ 12 Volts	LENGTH OF WIRE American Wire Gauge (AWG)						
	3'	5'	7'	10'	15'	20'	25'
0 to 1	18	18	18	18	18	18	18
1.5	18	18	18	18	18	18	18
2	18	18	18	18	18	18	18
3	18	18	18	18	18	18	18
4	18	18	18	18	18	18	18
5	18	18	18	18	18	18	18
6	18	18	18	18	18	18	16
7	18	18	18	18	18	18	16
8	18	18	18	18	18	16	16
10	18	18	18	18	16	16	14
11	18	18	18	18	16	16	14
12	18	18	18	18	16	16	14
15	18	18	18	18	14	14	12
18	18	18	16	16	14	14	12
20	18	18	16	16	14	12	10
22	18	18	16	14	12	12	10
24	18	18	16	14	12	12	10
30	18	16	14	12	10	10	10
36	16	14	14	12	10	10	10
40	16	14	12	12	10	10	8
50	16	14	12	10	10	10	8
100	12	12	10	10	6	6	4
150	10	10	8	8	4	4	2
200	10	8	8	6	4	4	2

Trailer Parts

Color Chart

TRAILER WIRE COLOR CODES 7 WAY UTILITY TRADITIONAL SAE (COLORS COORDINATE WITH WIRING DIAGRAM)			
Color	Function	Suggested Min. Wire gauge	Description
White	Ground	12	Ground for All electrical Functions.
Brown	Tail Lamps Running Lights Side Markers	16	Power for all normally ON lamps, Tail, Running & Side marker lights.
Yellow	Left Brake Light Left Turn Signal	16	Multi-function signal for the Left Side Rear Tail Lamp
Green	Right Brake Light Right Turn Signal	16	Multi-function signal for the Right Side Rear Tail Lamp
Blue	Brake	12	Electric Brakes Control Power
Red or Black	Battery	12	Vehicle Power +12V For trailer battery charging & accessories
Purple	Back Up Reverse	16	Back Up Lamps on Trailer Tail Lights / Hydraulic Brake Disengagement

TRAILER WIRE COLOR CODES 7 WAY RV (COLORS COORDINATE WITH WIRING DIAGRAM)			
Color	Function	Suggested Min. Wire gauge	Description
White	Ground	12	Ground for All electrical Functions.
Green	Tail Lamps Running Lights Side Markers	16	Power for all normally ON lamps, Tail, Running & Side marker lights.
Red	Left Brake Light Left Turn Signal	16	Multi-function signal for the Left Side Rear Tail Lamp
Brown	Right Brake Light Right Turn Signal	16	Multi-function signal for the Right Side Rear Tail Lamp
Blue	Brake	12	Electric Brakes Control Power
Black	Battery	12	Vehicle Power +12V For trailer battery charging & accessories
Yellow	Back Up Reverse	16	Back Up Lamps on Trailer Tail Lights / Hydraulic Brake Disengagement

7-Way Junction Box

& FABRICATION

TRAILER WIRE COLOR CODES COLORS COORDINATE WITH WIRING DIAGRAM					
Connector Style	Pin	Function	Color	Description	
7-Pin	4-Pin	1	Ground	White	Ground for All electrical Functions.
		2	Tail Lamps Running Lights Side Markers	Brown	Power for all normally ON lamps, Tail, Running & Side marker lights.
		3	Left Brake Light Left Turn Signal	Yellow	Multi-function signal for the Left Side Rear Tail Lamp
		4	Right Brake Light Right Turn Signal	Green	Multi-function signal for the Right Side Rear Tail Lamp
	5	Brake	Blue	Electric Brakes Control Power or Hydraulic Brake Disengagement (5-Pin only)	
	6	Battery	Red	Vehicle Power +12V For trailer battery charging & accessories	
	7	Back Up	Purple	Back Up Lamps on Trailer Tail Lights / Hydraulic Brake Disengagement	

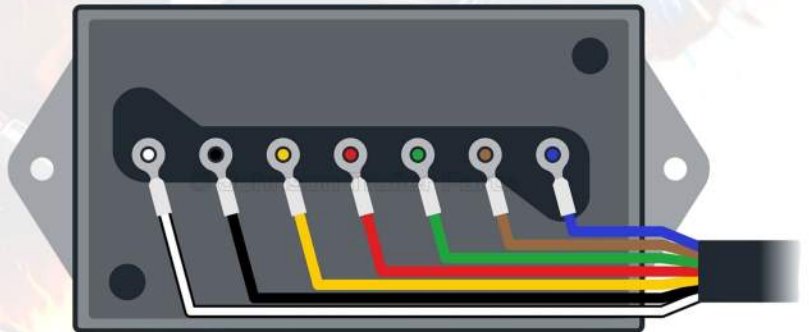

- White Post : Ground
- Black Post : 12V Hot
- Yellow Post : Reverse Lights
- Red Post : Left Turn
- Green Post : Tail Markers/ Running Lights
- Brown Post : Right Turn
- Blue Post : Brake Controller

Trailer Parts

6 & 7 Way Plug Wiring

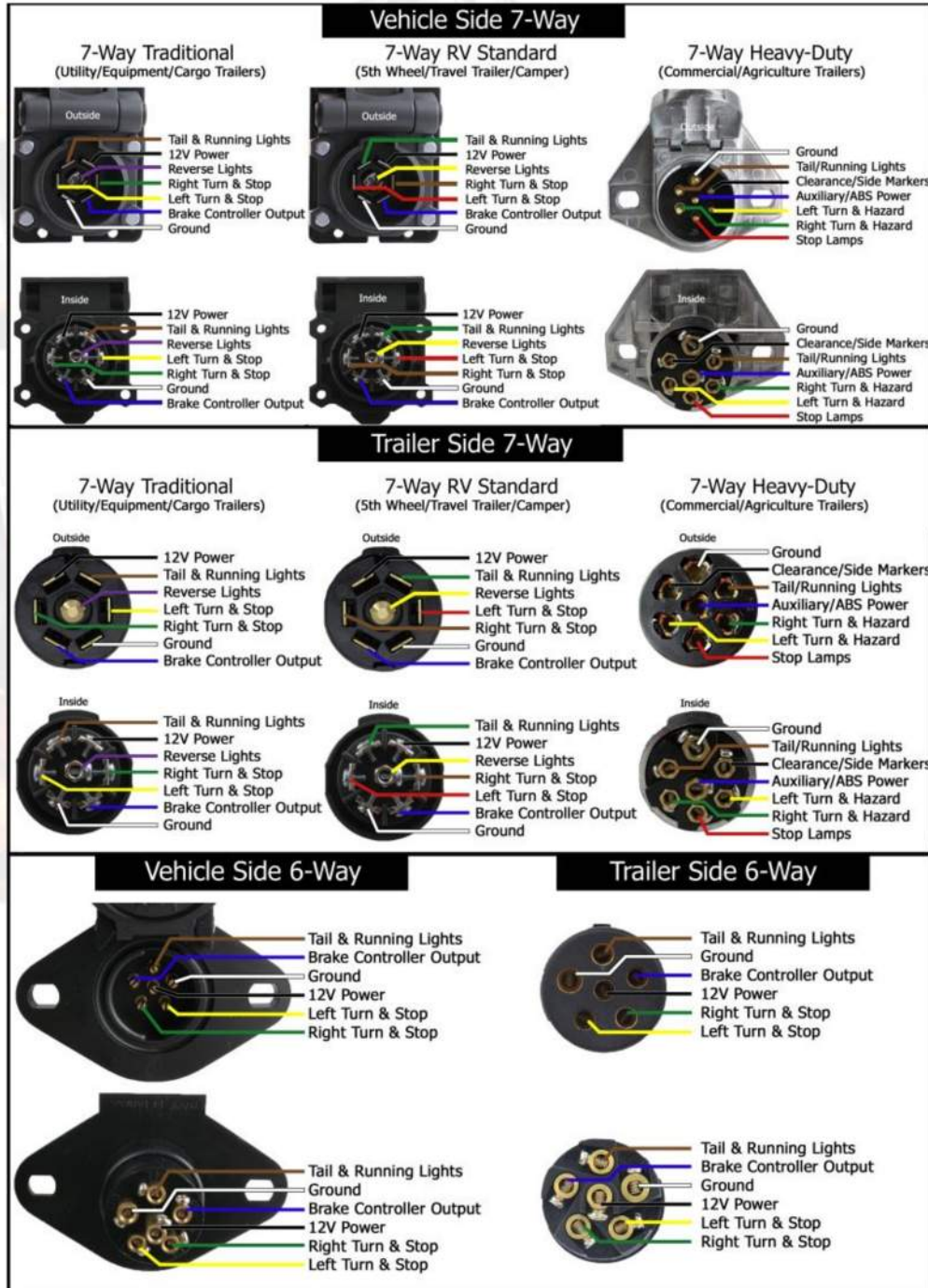

Trailer Parts

Trailer/Vehicle Plug Wiring Diagrams

VEHICLE SIDE

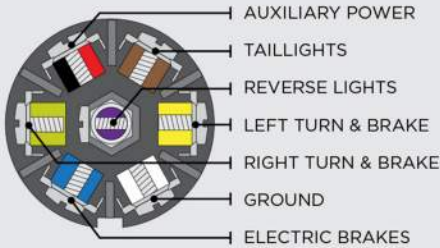

7 BLADE (SAE STANDARD)

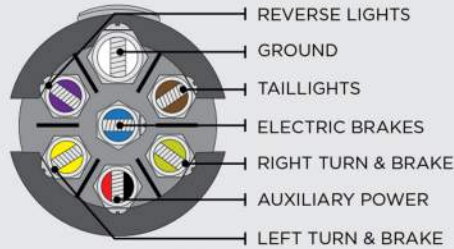

7 ROUND

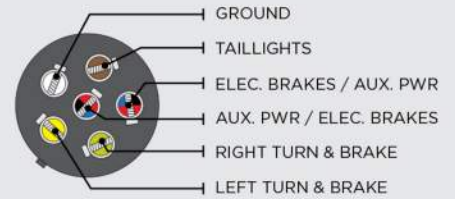

6 ROUND

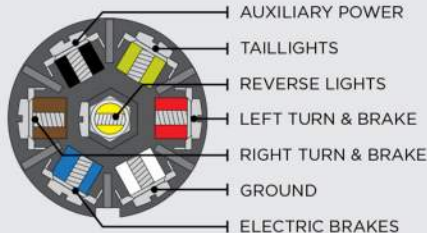

7 BLADE (RV STANDARD)

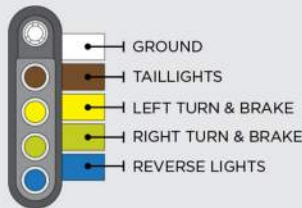

5 FLAT



4 FLAT



4 ROUND

TRAILER SIDE

TM

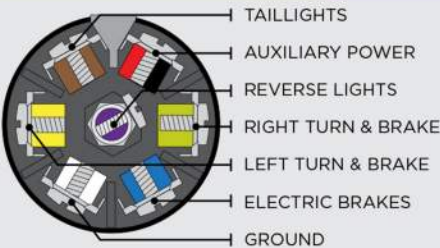

7 BLADE (SAE STANDARD)

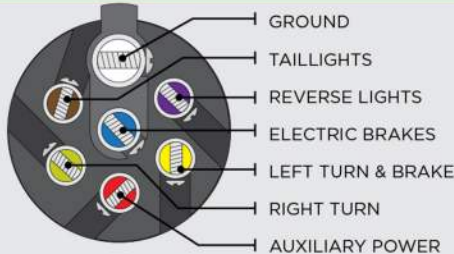

7 ROUND



6 ROUND

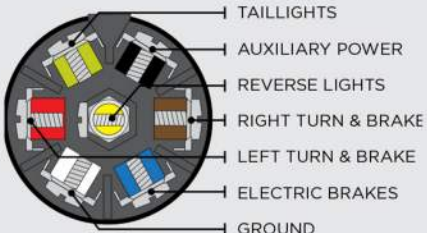

7 BLADE (RV STANDARD)

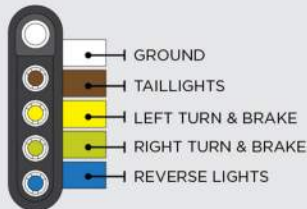

5 FLAT

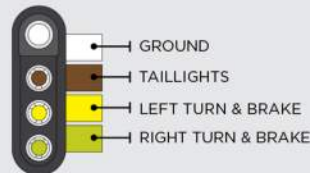

4 FLAT



4 ROUND

Trailer Parts

Trailer Wiring

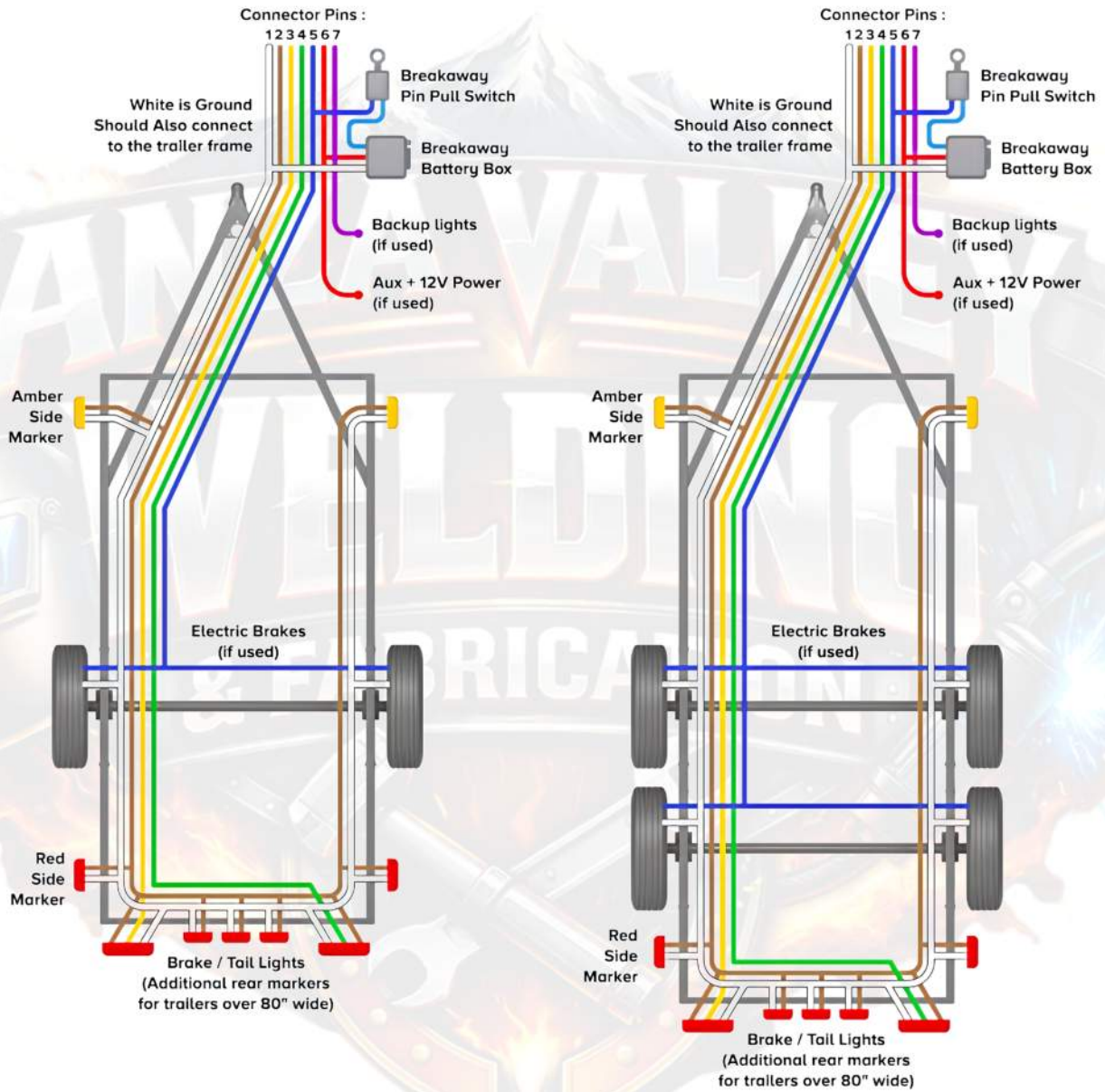

LEFT TURN

RIGHT TURN

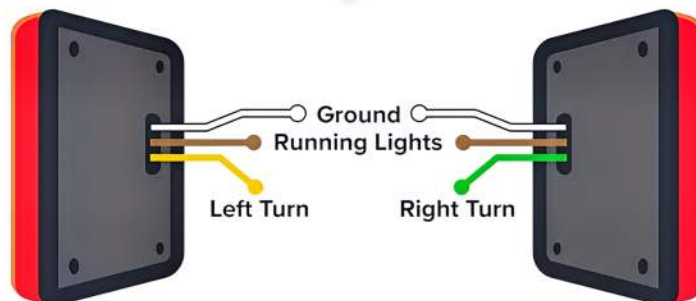

Trailer Parts

Break-Away & Battery Charging

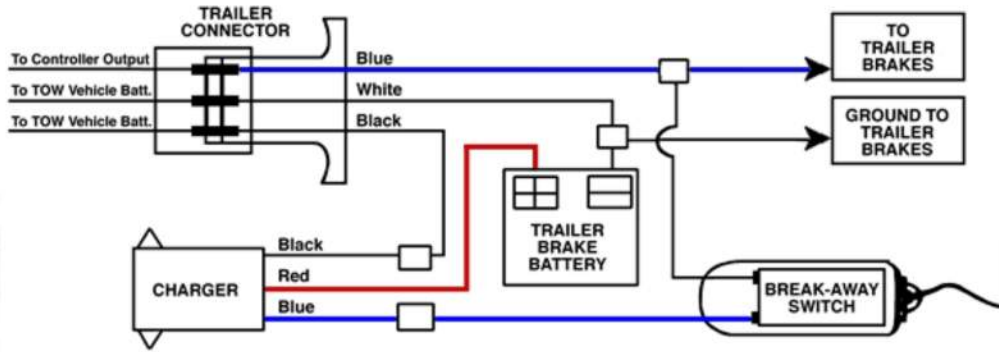

BA10-140

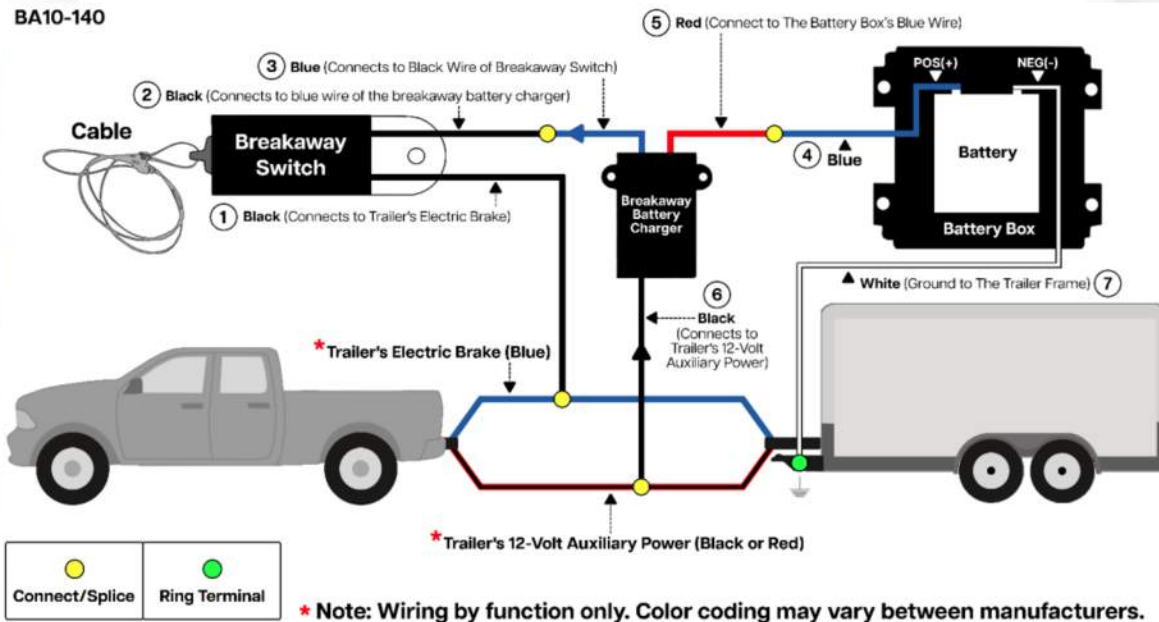

BA10-150

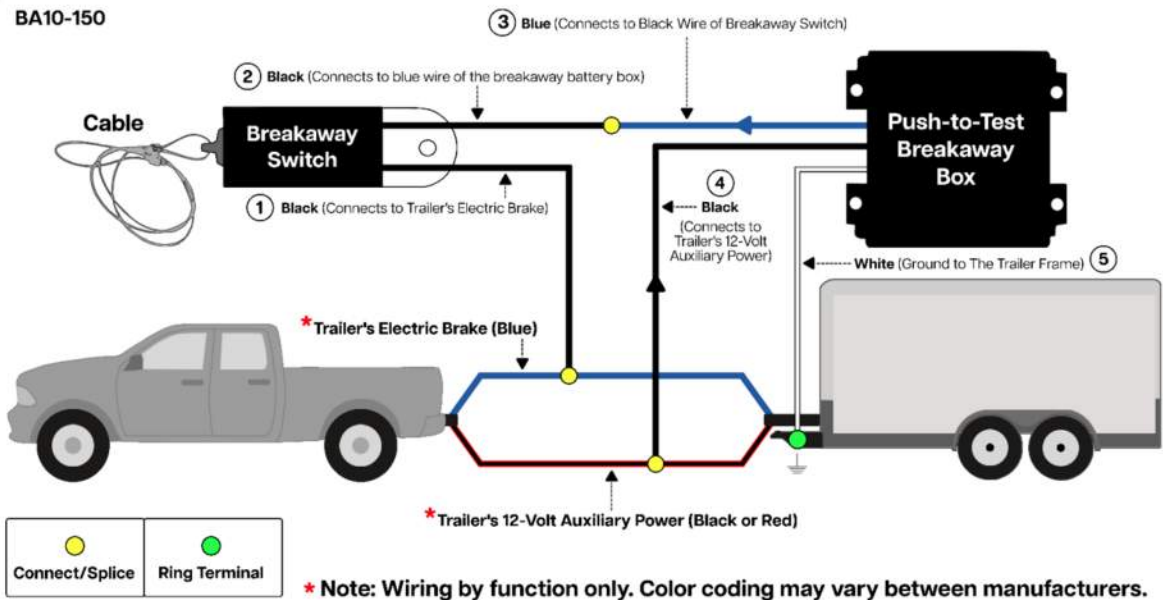

Trailer Parts

Relay Wiring Diagram

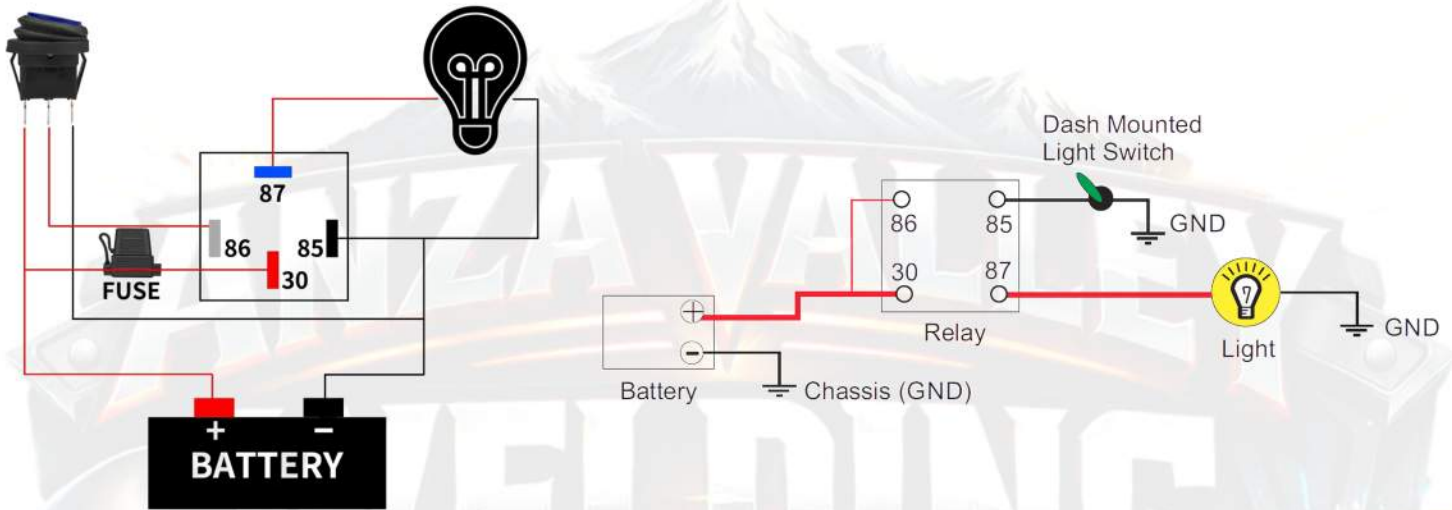

Micro Relay Wiring Diagram

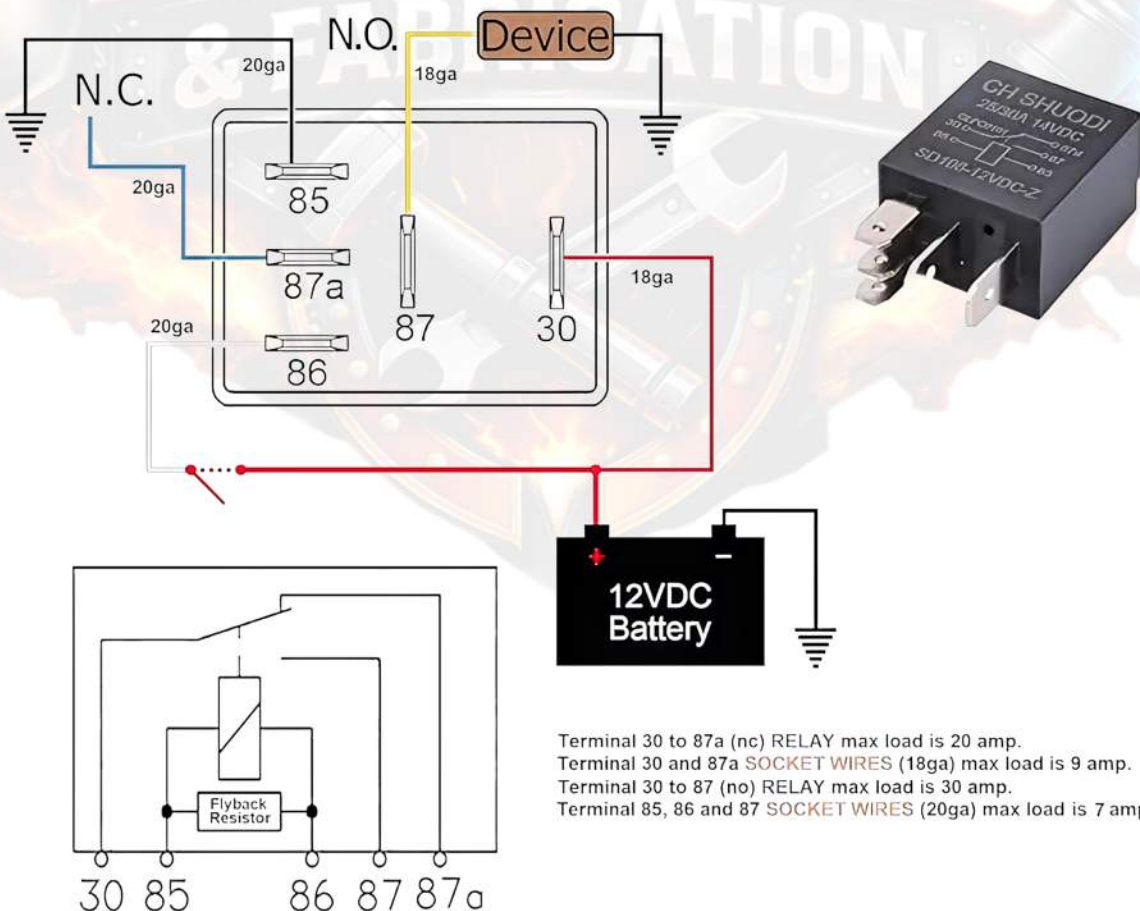

Trailer Parts

Ball Mount Drop/Rise Calculation

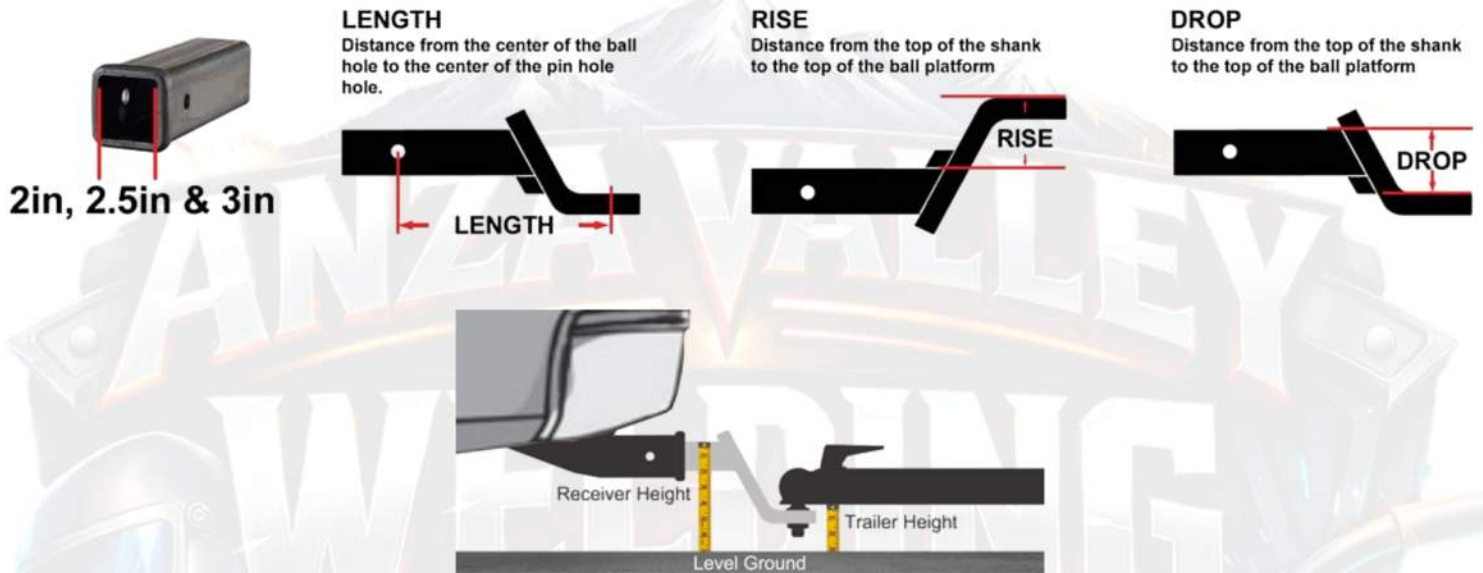

If Receiver is Higher from the ground than your trailer:
 $\text{Receiver Height} - \text{Tongue Height} = \text{Amount of Drop in Hitch Required.}$

If Receiver is Lower from the ground than your trailer:
 $\text{Tongue Height} - \text{Receiver Height} = \text{Amount of Rise in Hitch Required.}$

Example Below:

Determine Ball Mount (Drop or Rise)

1. Measure from the ground to the top of the inside of your receiver hitch.
2. Measure from the ground to the bottom of the trailer coupler.

Receiver Height:

Trailer Height:

Drop: 3"

Trailer Parts

How to measure 5-Lug Axles Bolt Patterns

OPTION 1 Direct Measurement

Measure from the center to the center of each stud as shown in diagram
Must be exact, No room for error



5 Lug Bolt Pattern Diagram

OPTION 2 Cross Measurement

Measure from the outside of 1 stud to the center of the 3rd stud.
Make sure you skip a stud, as shown in the diagram.
This will show the exact inch

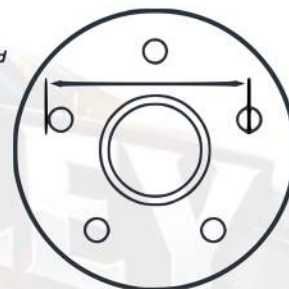

5 Lug Bolt Pattern Diagram

If "A" Equals:

Measurement	Bolt Pattern Use
2 5/8"	5 Lug on 4.5" Bolt Pattern
2 3/4"	5 Lug on 4.75" Bolt Pattern
2 15/16" or 3"	5 Lug on 5" Bolt Pattern
3 1/4"	5 Lug on 5.5" Bolt Pattern

Measurement & Bolt Pattern Use
5 Lug on 4-1/2" Bolt Pattern (most common)
5 Lug on 4 3/4" Bolt Pattern
5 Lug on 5" Bolt Pattern (second most common)
5 Lug on 5-1/2" Bolt Pattern

How to measure Axle Bolt Pattern

HOW TO MEASURE BOLT PATTERN?

4-LUG

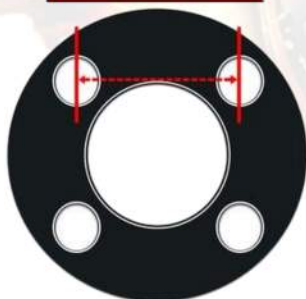

- Pick two bolt holes directly across from each other.
- Measure from the **center** of one hole, to the **center** of the second hole.
- Common 4-lug bolt pattern on trailer wheels: **(4 on 4")**.

6-LUG



- Pick two bolt holes directly across from each other.
- Measure from the **center** of one hole, to the **center** of the second hole.
- Common 6-lug bolt pattern on trailer wheels: **(6 on 5.5")**.

8-LUG



- Pick two bolt holes directly across from each other.
- Measure from the **center** of one hole, to the **center** of the second hole.
- Common 8-lug bolt pattern on trailer wheels: **(8 on 6.5")**.

Trailer Parts

Axle Components



Trailer Parts

Hanger Location Guide - Tuff-Tow Specific

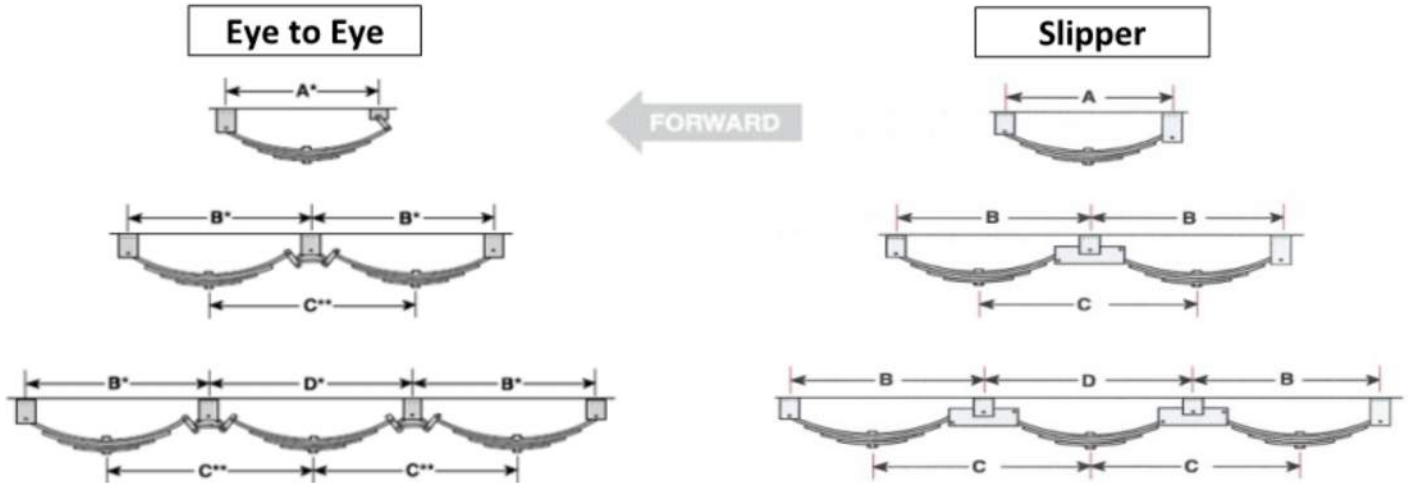



Eye To Eye Spring						Hanger Location			
Axle	Hanger kit P/N	Brand	Capacity	Spring Length	Spring Width	A	B	C	D
SINGLE	H1001	Tuff-Tow	2K-7K	25-1/4in	1-3/4in	25-1/8in			
SINGLE	H1001	Tuff-Tow	2K-7K	26in	1-3/4in	25-7/8in			
SINGLE	H1125	Tuff-Tow	2K-7K	25-1/4in	1-3/4in	25-1/8in			
TANDEM	H1002	Tuff-Tow	2K-7K	25-1/4in	1-3/4in		29-1/2in	33-1/2in	
TANDEM	H1002	Tuff-Tow	2K-7K	26in	1-3/4in		30-1/8in	34-1/4in	
TANDEM	H1002D	Tuff-Tow	2K-7K	25-1/4in	1-3/4in		29-1/2in	33-1/2in	
TANDEM	H1002D	Tuff-Tow	2K-7K	26in	1-3/4in		30-1/4in	35in	
TANDEM	H2125	Tuff-Tow	2K-7K	25-1/4in	1-3/4in		29-1/2in	33-1/2in	
TANDEM	H2257	Tuff-Tow	3.5K-7K	26in	1-3/4in			35in	
TANDEM	H2257L	Tuff-Tow	3.5K-7K	26in	1-3/4in			35in	
TRIPLE	H1003	Tuff-Tow	2K-7K	25-1/4in	1-3/4in		29-3/8in	33-1/2in	33-1/2in
TRIPLE	H1003	Tuff-Tow	2K-7K	26in	1-3/4in		30-1/8in	34-1/4in	34-1/4in
TRIPLE	H3001	Tuff-Tow	2K-7K	25-1/4in	1-3/4in		29-1/2in	33-1/2in	34in
TRIPLE	H3002	Tuff-Tow	2K-7K	25-1/4in	1-3/4in		29-1/2in	33-1/2in	34in



Slipper Spring						Hanger Location			
Axle	Hanger kit P/N	Brand	Capacity	Spring Length	Spring Width	A	B	C	D
SINGLE	HSL2001	Tuff-Tow	2K-7K	25in	1-3/4in	24in			
SINGLE	H1125SL	Tuff-Tow	2K-7K	25in	1-3/4in	24in			
SINGLE	H1375SL	Tuff-Tow	5K-8K	26-1/4in	2in	24-1/2in			
TANDEM	H237513SL	Tuff-Tow	5K-8K	26-1/4in	2in		30-1/4in	36in	
TANDEM	H237511SL	Tuff-Tow	5K-8K	26-1/4in	2in		29-1/4in	34in	
TRIPLE	H3003SL	Tuff-Tow	5K-8K	26-1/4in	2in		29-1/4in	35in	33in
TRIPLE	H3004SL	Tuff-Tow	5K-8K	26-1/4in	2in		30-1/4in	36in	35-1/2in





Trailer Parts

Bearing Kits per Springle ID

		Round Bar Stock Spindles				
Part Number	Description	Stub Dia.	Length	Cap (1)	Use Brg Kit #	
R104-BT12	Round BT8 1" grind	1.25in	8-1/4in	1,000lbs	KIT2	
R204-BT12	Round BT8 1" grind	1.50in	8-1/4in	1,000lbs	KIT2	
R104-BT116	Round BT16 1-1/16" grind *(Seal #)	1.25in	8-1/4in	1,250lbs	KIT11 *(AB12192)	
R204-BT16	Round BT16 1-1/16" grind	1.50in	8-1/4in	1,250lbs	KIT1	
R204-84	Round #84	1.50in	8-7/8in	1,750lbs	KIT3	
R206-84	Round #84	1.75in	10-3/4in	1,750lbs	KIT3	
R305-84	Round #84	1.75in	8-1/4in	1,750lbs	KIT3	
R406-42	Round #42	2.00in	11-1/8in	3,500lbs	KIT6 (7k: KIT8)	
R506-42	Round #42	2.25in	11in	3,500lbs	KIT6 (7k: KIT8)	

		Square Bar Stock Spindles				
Part Number	Description	Stub Dia.	Length	Cap (1)	Use Brg Kit #	
SP204BT12	Square BT8 1" grind	1.50in	8-1/4in	1,000lbs	KIT2	
SP204BT116	Square BT16 1-1/16" grind	1.50in	8-1/4in	1,250lbs	KIT1	
SP20484	Square #84	1.50in	8-1/4in	1,750lbs	KIT3	
SP-20484F-725	Square #84 w/brake flange	1.50in	7-1/4in	1,750lbs	KIT3	
SP355-84	Square #84	1.75in	11in	1,750lbs	KIT3	
SP406-42	Square #42	2.00in	11in	3,500lbs	KIT6 (7k: KIT8)	
SP-50642F-SQNW	Square #42 w/brake flange	2.00in	11in	3,500lbs	KIT6 (7k: KIT8)	

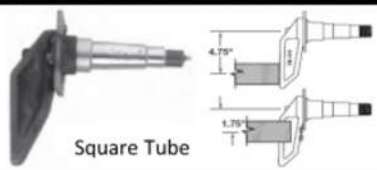
		Ag Specialty				
Part Number	Description	Stub Dia.	Length	Cap (1)	Use Brg Kit #	
AGS-3560E	Round AG Spindle	1.75in	12in	3,560lbs	KIT660	
AGS-6000F	Round AG Spindle	2.75in	14in	6,000lbs	KIT880	

Hot Forged Butt Weld Axle Spindles						
		Straight Axle Spindles w/Brake Flange				
Part Number	Description	Stub Dia.	Length	Cap (1)	Use Brg Kit #	
SPHFIF84LZ	Round Axle #84 (2-3/8" tube) w/zirk	1.95in	X	1,750lbs	KIT3	
SPHFIFB42LZ225	Round Axle #42 (3" tube) w/zirk	2.45in	X	3,500lbs	KIT6 (7k: KIT8)	
		Drop Axle Spindles w/Brake Flange				
	Square Tube				Round Tube	
SP-TB-175FNW	Square Axle #84 (2" X 2" or 2" X 3")	2.00in	1-3/4 4-3/4	1,750lbs	KIT3	
SP-TT-175F	Round Axle #84 (2-3/8" tube)	1.95in	4in Drop	1,750lbs	KIT3	
SP-TT-175AF	Round Axle #84 (3" tube)	2.45in	4in Drop	1,750lbs	KIT3	
SP-UT-300FNW225	Round Axle #42 (3" tube)	2.45in	4in Drop	3,000lbs	KIT6	

Trailer Parts

Decimal Equivalents

METRIC - GREEN		FRACTIONAL - RED		WIRE GAGE - PURPLE		LETTER SIZE - BLUE			
DRILL SIZE	DECIMAL INCHES	DRILL SIZE	DECIMAL INCHES	DRILL SIZE	DECIMAL INCHES	DRILL SIZE	DECIMAL INCHES		
0.3mm	.0118	1.75mm	.0689	4.1mm	.1614	L	.2900	33/64	.5156
0.32mm	.0126	50	.0700	4.2mm	.1654	7.4mm	.2913	13.2mm	.5197
80	.0135	1.8mm	.0709	19	.1660	M	.2950	17/32	.5312
0.35mm	.0138	1.85mm	.0728	4.3mm	.1693	7.5mm	.2953	13.5mm	.5315
79	.0145	49	.0730	18	.1695	19/64	.2969	13.8mm	.5433
0.38mm	.0150	1.9mm	.0748	11/64	.1719	7.6mm	.2992	35/64	.5469
0.4mm	.0157	48	.0760	17	.1730	N	.3020	14.0mm	.5512
78	.0160	1.95mm	.0768	4.4mm	.1732	7.7mm	.3031	14.25mm	.5610
0.42mm	.0165	5/64	.0781	16	.1770	7.8mm	.3071	9/16	.5625
0.45mm	.0177	47	.0785	4.5mm	.1772	7.9mm	.3110	14.5mm	.5709
77	.0180	2.0mm	.0787	15	.1800	5/16	.3125	37/64	.5781
0.48mm	.0189	2.05mm	.0807	4.6mm	.1811	8.0mm	.3150	14.75mm	.5807
0.5mm	.0197	46	.0810	14	.1820	O	.3160	15.0mm	.5906
76	.0200	45	.0820	4.7mm	.1850	8.1mm	.3189	19/32	.5938
75	.0210	2.1mm	.0827	13	.1875	8.2mm	.3228	15.25mm	.6004
0.55mm	.0217	2.15mm	.0846	4.8mm	.1890	P	.3230	39/64	.6094
74	.0225	44	.0860	11	.1910	8.3mm	.3268	15.5mm	.6102
0.6mm	.0236	2.2mm	.0866	4.9mm	.1929	21/64	.3281	15.75mm	.6201
73	.0240	2.25mm	.0886	10	.1935	8.4mm	.3307	5/8	.6250
0.62mm	.0244	43	.0890	9	.1960	Q	.3320	16.0mm	.6299
72	.0250	2.3mm	.0906	5.0mm	.1969	8.5mm	.3346	16.25mm	.6398
0.65mm	.0256	2.35mm	.0925	8	.1990	8.6mm	.3386	41/64	.6406
71	.0260	42	.0935	5.1mm	.2008	R	.3390	16.5mm	.6496
0.7mm	.0276	3/32	.0938	7	.2010	8.7mm	.3425	21/32	.6562
70	.0280	2.4mm	.0945	13/64	.2031	8.8mm	.3438	16.75mm	.6594
69	.0292	41	.0960	6	.2040	S	.3465	17.0mm	.6693
0.75mm	.0295	2.45mm	.0965	5.2mm	.2047	8.9mm	.3480	43/64	.6719
68	.0310	40	.0980	5	.2055	9.0mm	.3504	17.25mm	.6791
0.8mm	.0315	2.5mm	.0984	5.3mm	.2087	T	.3543	17.5mm	.6875
1/32	.0312	39	.0995	4	.2090	9.1mm	.3580	45/64	.7031
67	.0320	38	.1015	5.4mm	.2126	23/64	.3583	18.0mm	.7087
66	.0330	2.6mm	.1024	3	.2130	9.2mm	.3594	23/32	.7188
0.85mm	.0335	37	.1040	5.5mm	.2165	9.3mm	.3622	18.5mm	.7283
65	.0350	2.7mm	.1063	7/32	.2188	U	.3661	47/64	.7344
0.9mm	.0354	36	.1065	5.6mm	.2205	9.4mm	.3680	19.0mm	.7480
64	.0360	7/64	.1094	2	.2210	9.5mm	.3701	3/4	.7500
63	.0370	35	.1100	5.7mm	.2244	3/8	.3740	49/64	.7656
0.95mm	.0374	2.8mm	.1102	1	.2280	V	.3750	19.5mm	.7677
62	.0380	34	.1110	5.8mm	.2283	9.6mm	.3770	25/32	.7812
61	.0390	33	.1130	5.9mm	.2323	9.7mm	.3780	20.0mm	.7874
1.0mm	.0394	2.9mm	.1142	A	.2340	9.8mm	.3819	51/64	.7969
60	.0400	32	.1160	15/64	.2344	9.9mm	.3858	20.5mm	.8071
59	.0410	3.0mm	.1181	6.0mm	.2362	W	.3860	13/16	.8125
1.05mm	.0413	31	.1200	B	.2380	10.0mm	.3898	21.0mm	.8268
58	.0420	3.1mm	.1220	6.1mm	.2402	25/64	.3906	53/64	.8281
57	.0430	1/8	.1250	C	.2420	10.2mm	.3937	27/32	.8438
1.1mm	.0433	3.2mm	.1260	6.2mm	.2441	X	.3970	21.5mm	.8465
1.15mm	.0453	30	.1285	D	.2460	10.3mm	.4016	55/64	.8594
56	.0465	3.3mm	.1299	6.3mm	.2480	Y	.4040	22.0mm	.8661
3/64	.0469	3.4mm	.1339	1/4	.2500	13/32	.4062	7/8	.8750
1.2mm	.0472	29	.1360	6.4mm	.2520	Z	.4130	22.5mm	.8858
1.25mm	.0492	3.5mm	.1378	6.5mm	.2559	10.5mm	.4134	57/64	.8906
1.3mm	.0512	28	.1405	F	.2570	27/64	.4219	23.0mm	.9055
55	.0520	9/64	.1406	6.6mm	.2598	10.8mm	.4252	29/32	.9062
1.35mm	.0531	3.6mm	.1417	G	.2610	11.0mm	.4331	59/64	.9219
54	.0550	27	.1440	6.7mm	.2638	7/16	.4375	23.5mm	.9252
1.4mm	.0551	3.7mm	.1457	17/64	.2656	11.2mm	.4409	15/16	.9375
1.45mm	.0571	26	.1470	H	.2660	11.5mm	.4528	24.0mm	.9449
1.5mm	.0591	25	.1495	6.8mm	.2677	29/64	.4531	61/64	.9531
53	.0595	3.8mm	.1496	6.9mm	.2717	11.8mm	.4646	24.5mm	.9646
1.55mm	.0610	24	.1520	I	.2720	15/32	.4688	31/32	.9688
1.6mm	.0625	3.9mm	.1535	7.0mm	.2756	12.0mm	.4724	25.0mm	.9843
1/16	.0625	23	.1540	J	.2770	12.2mm	.4803	63/64	.9844
52	.0630	5/32	.1562	7.1mm	.2795	31/64	.4844	1"	1.0000
1.65mm	.0635	22	.1570	K	.2810	12.5mm	.4921		
1.7mm	.0650	4.0mm	.1575	9/32	.2812	1/2	.5000		
51	.0669	21	.1590	7.2mm	.2835	12.8mm	.5039		
	.0670	20	.1610	7.3mm	.2874	13.0mm	.5118		