

FIG. 1

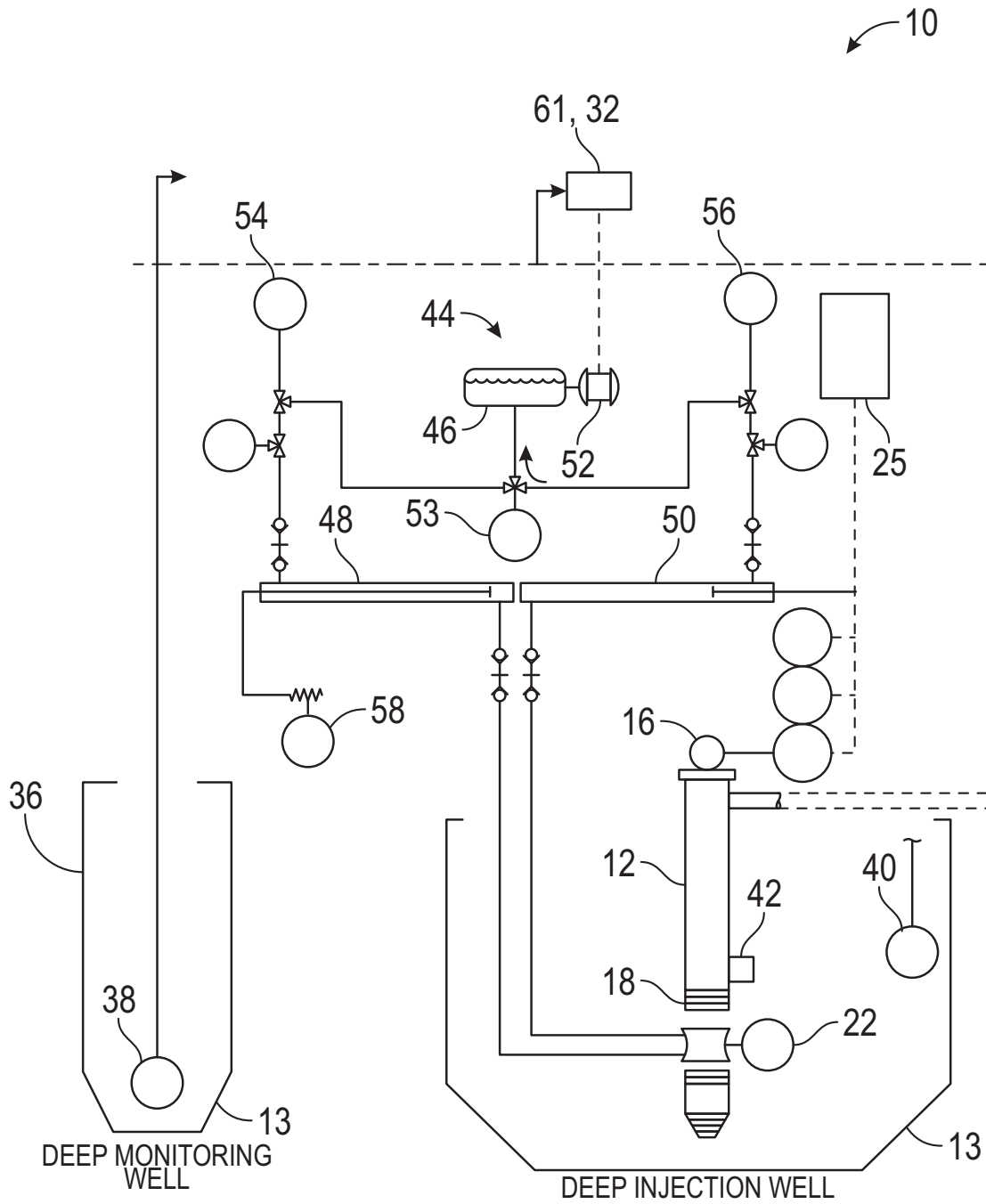

FIG. 2

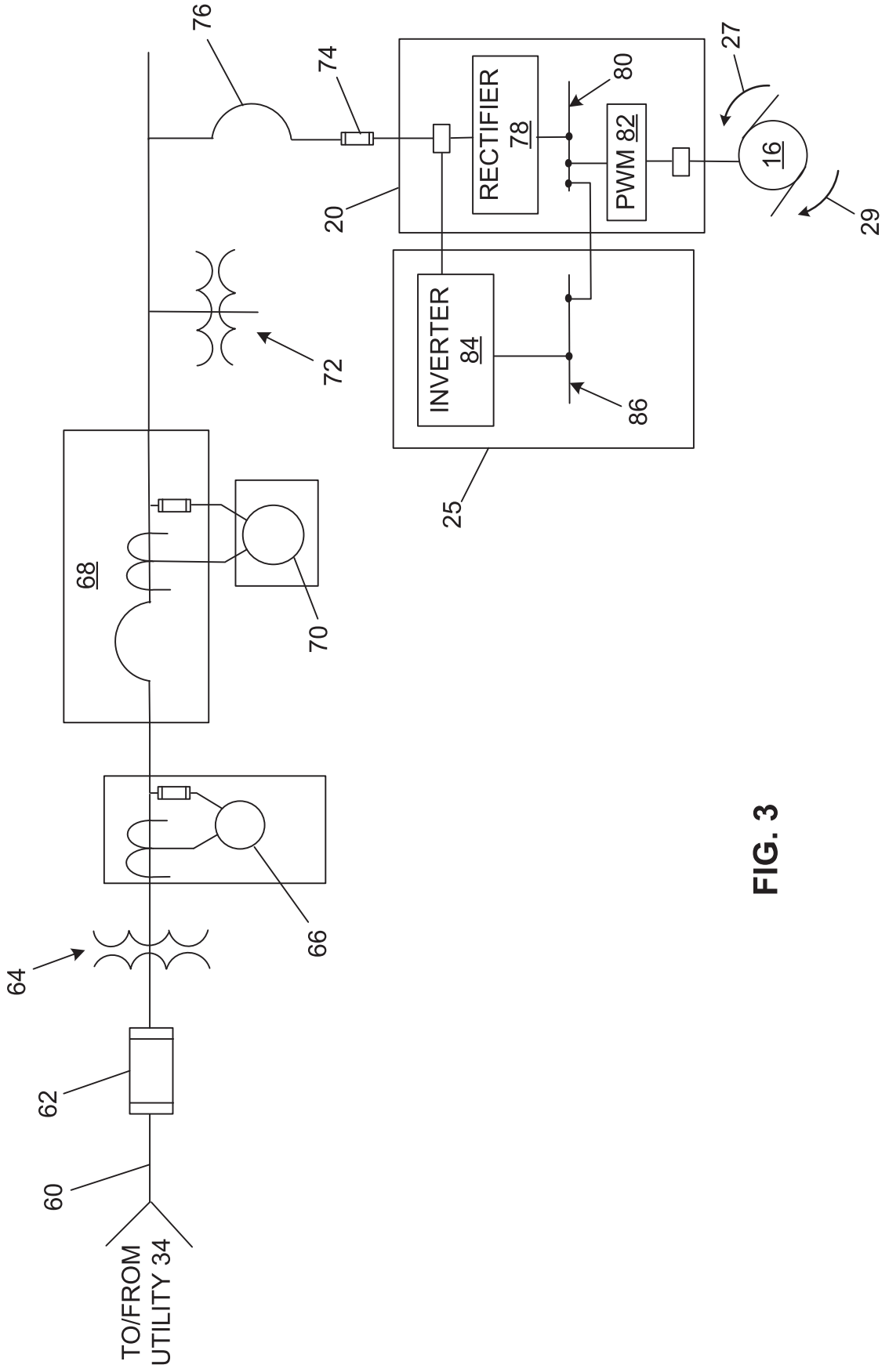

FIG. 3

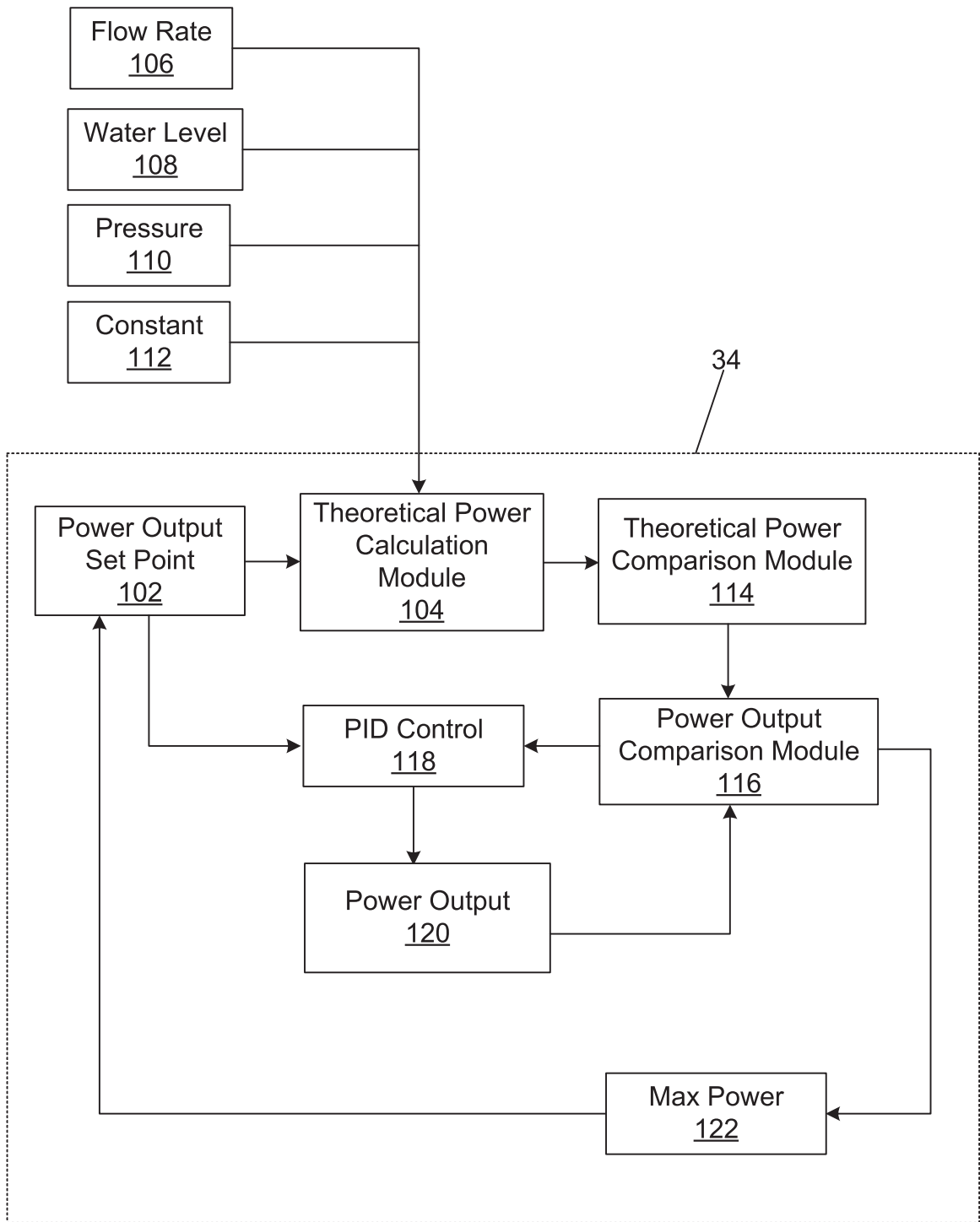

FIG. 4

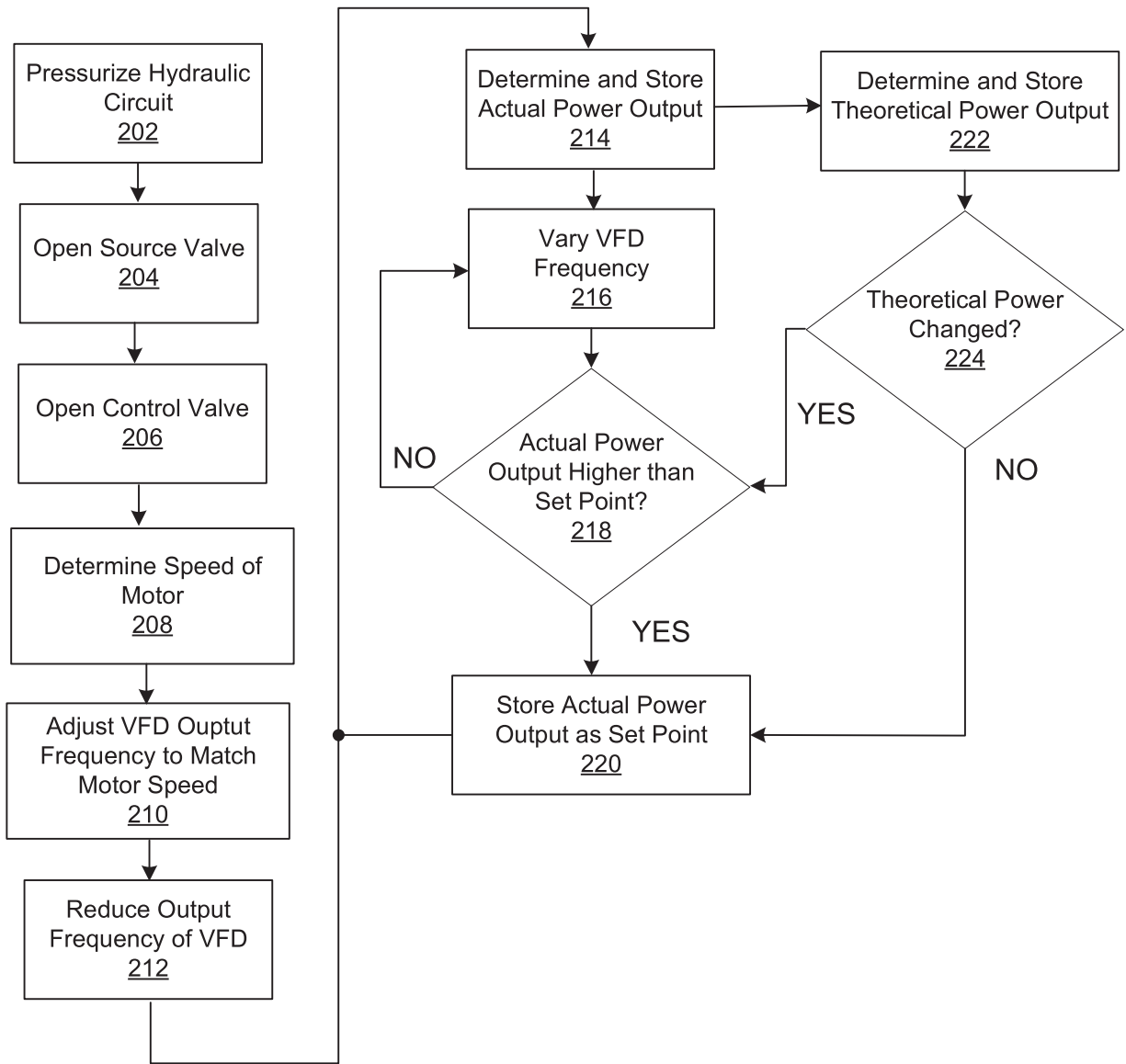

FIG. 5

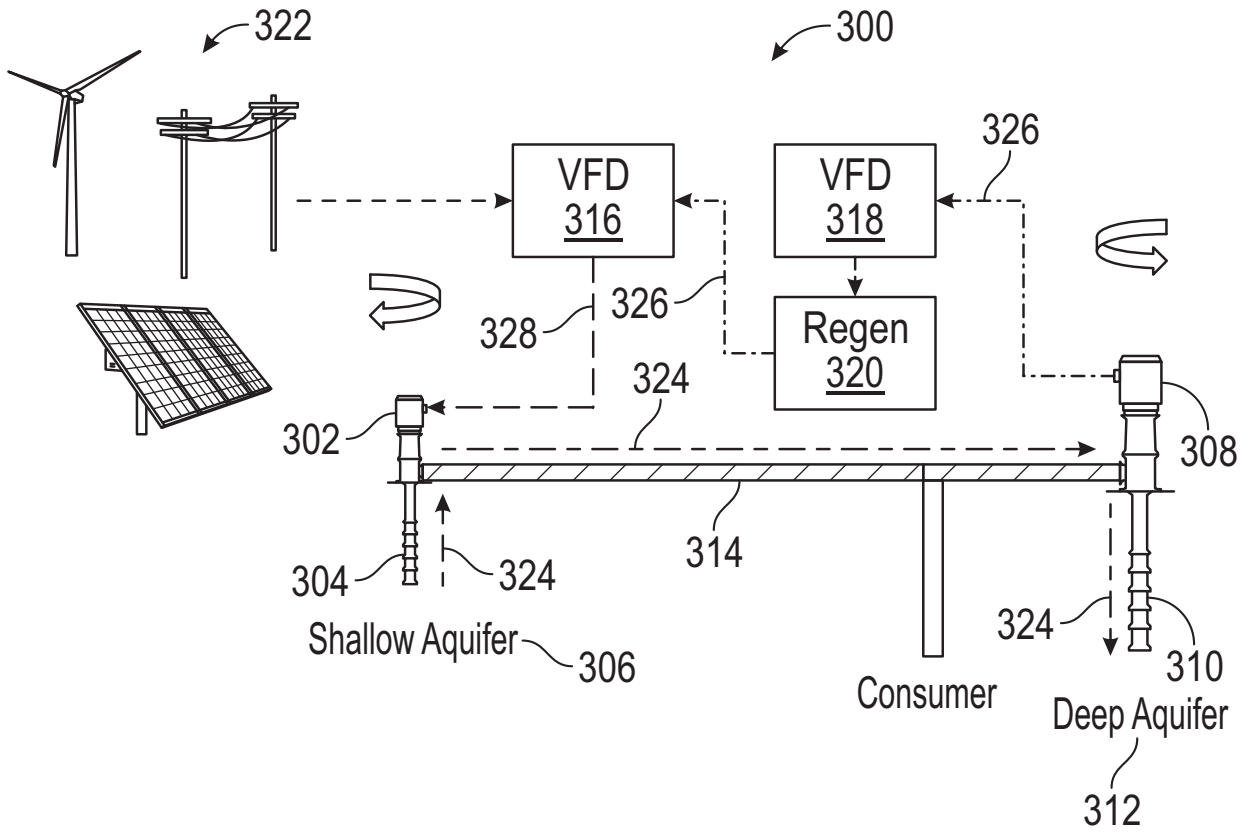

FIG. 6

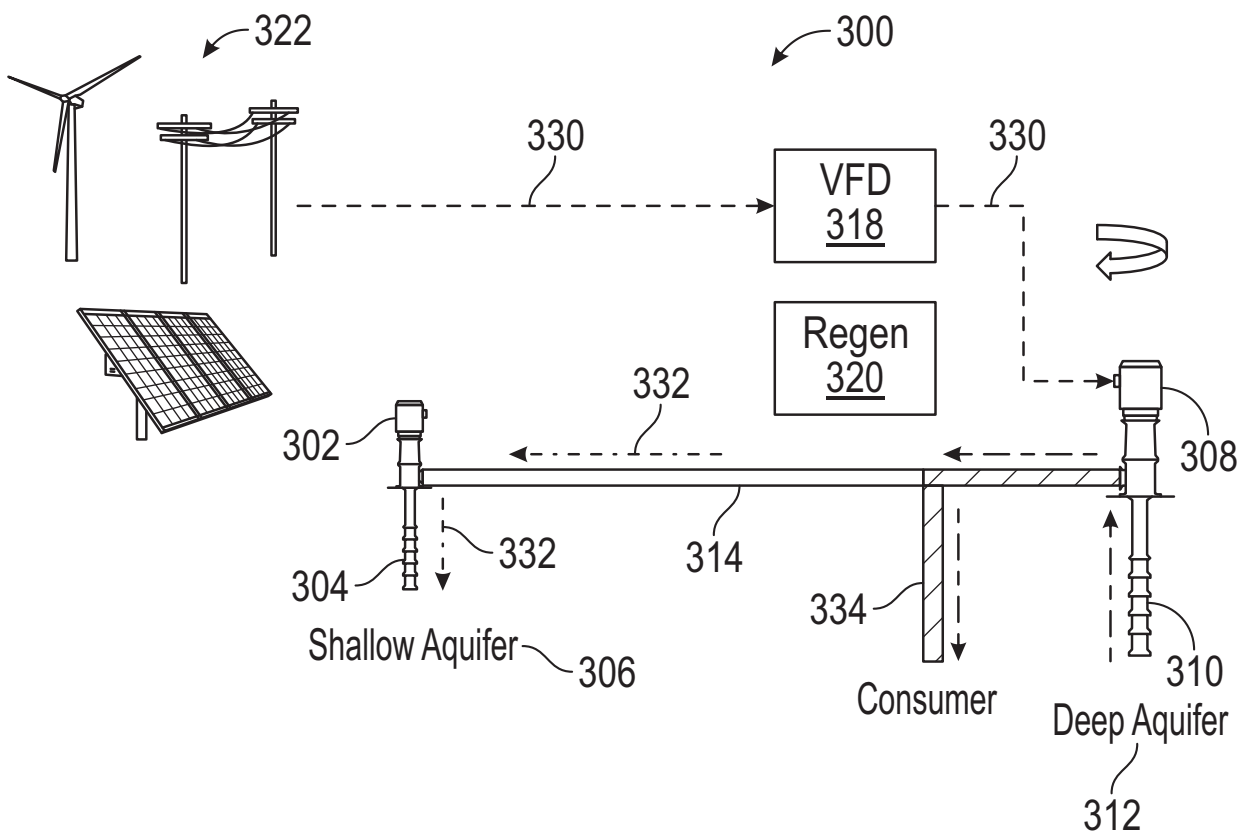

FIG. 7

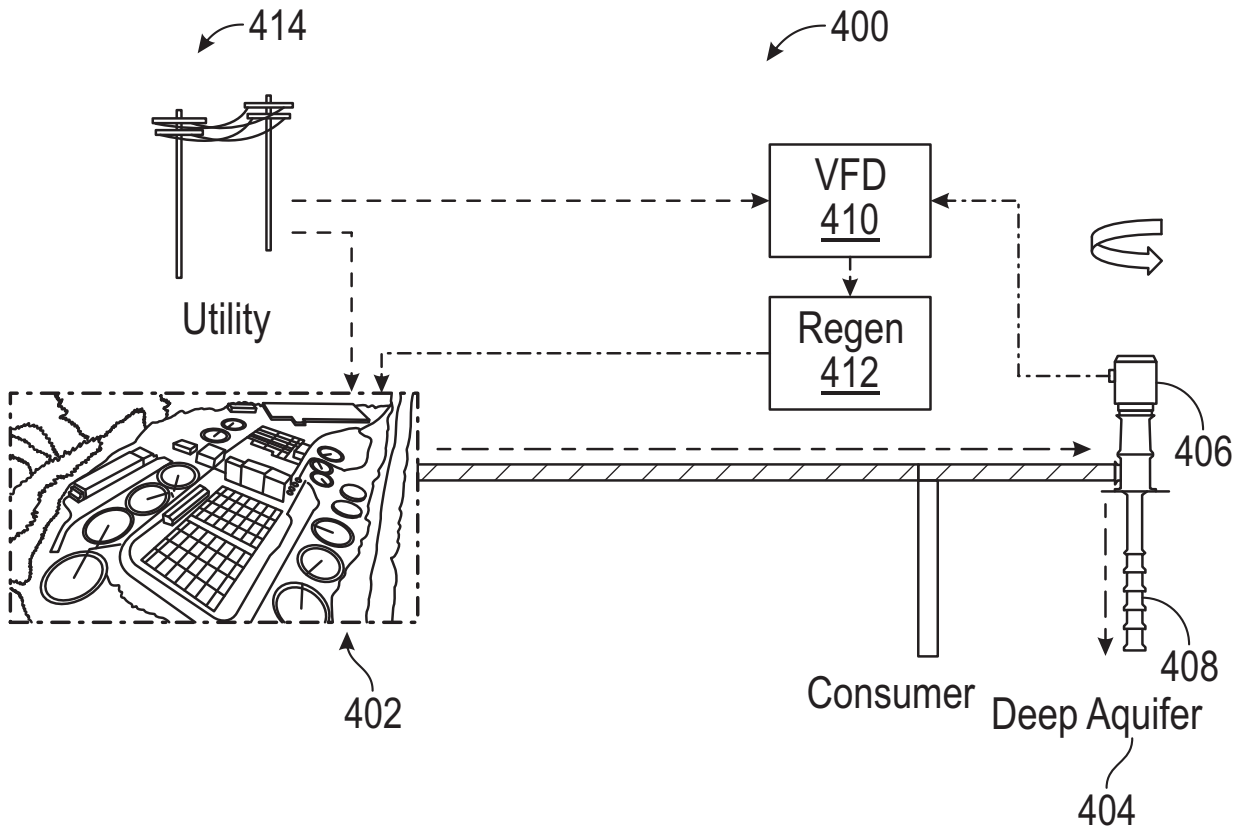

FIG. 8

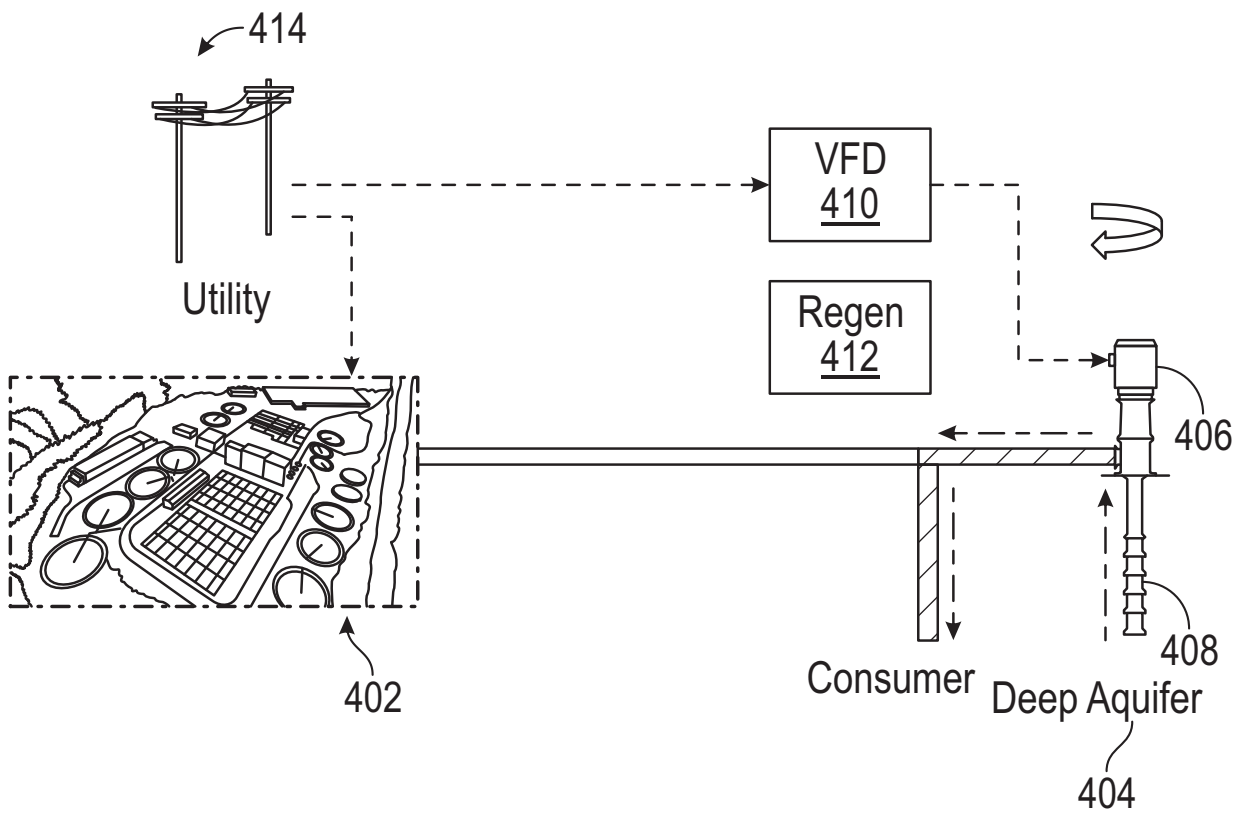

FIG. 9

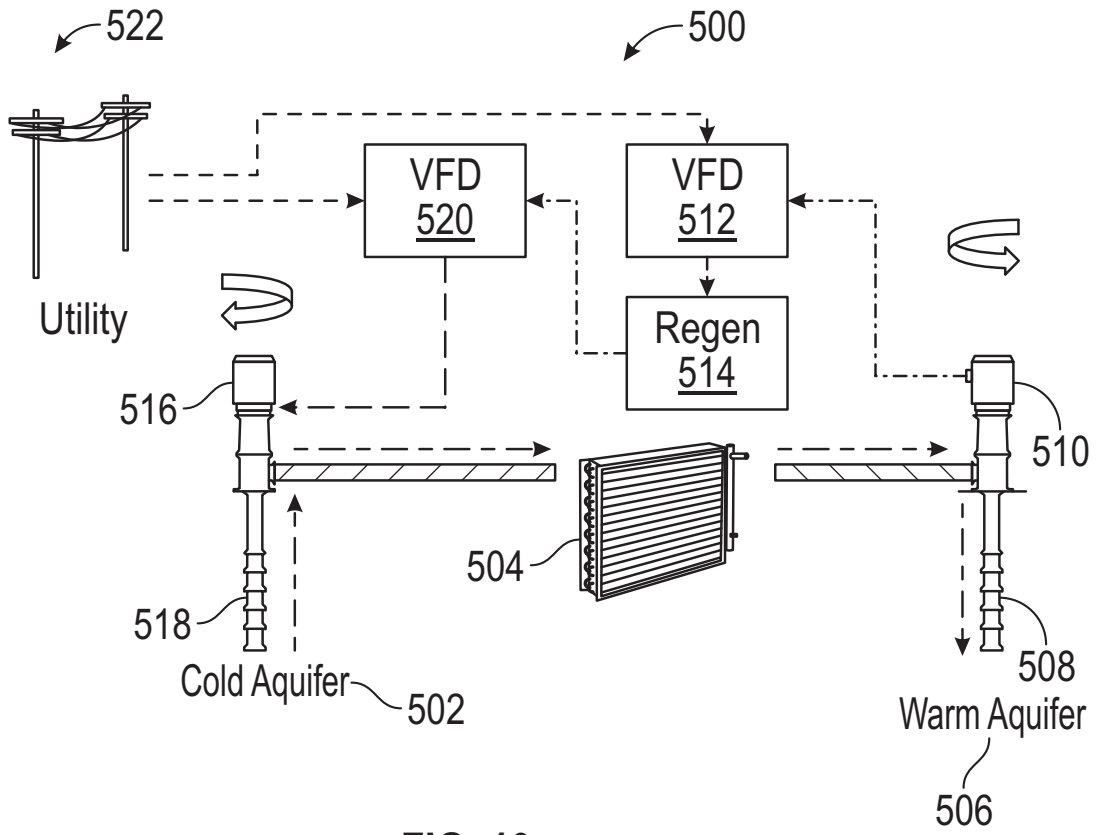

FIG. 10

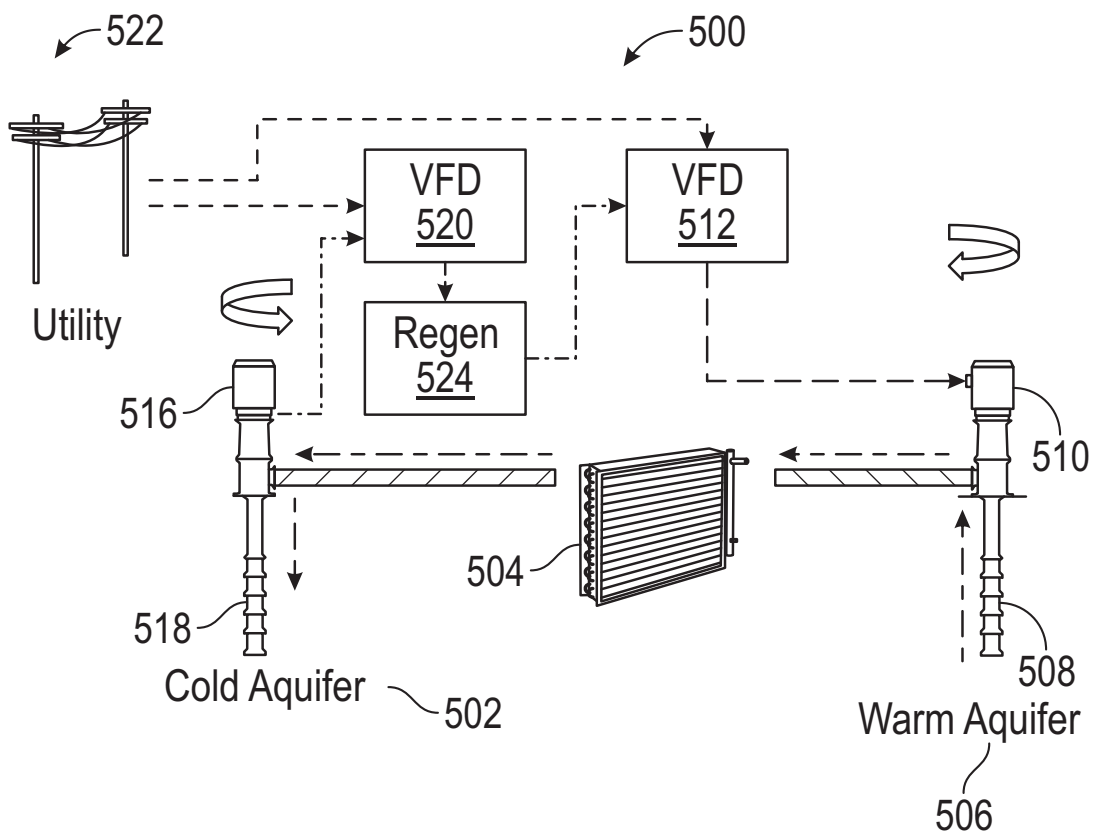

FIG. 11



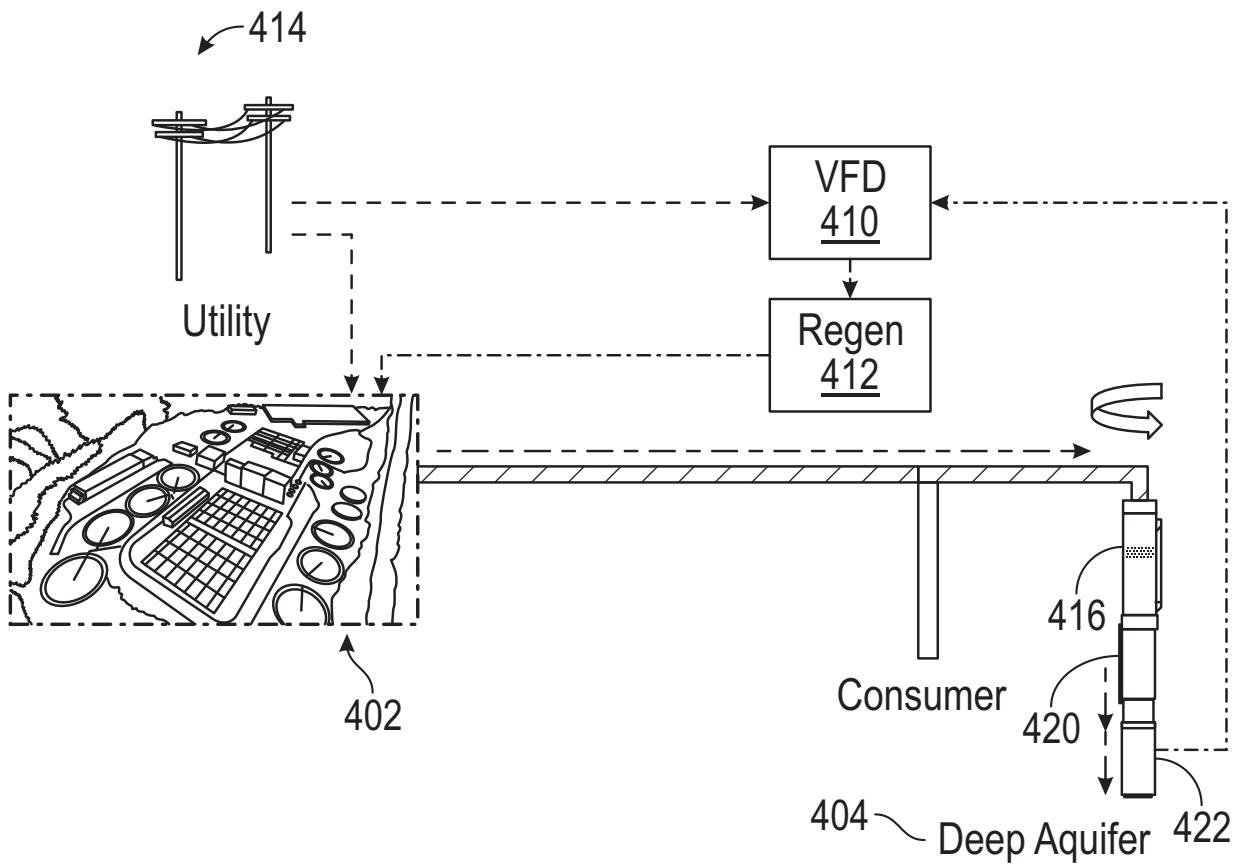

FIG. 12

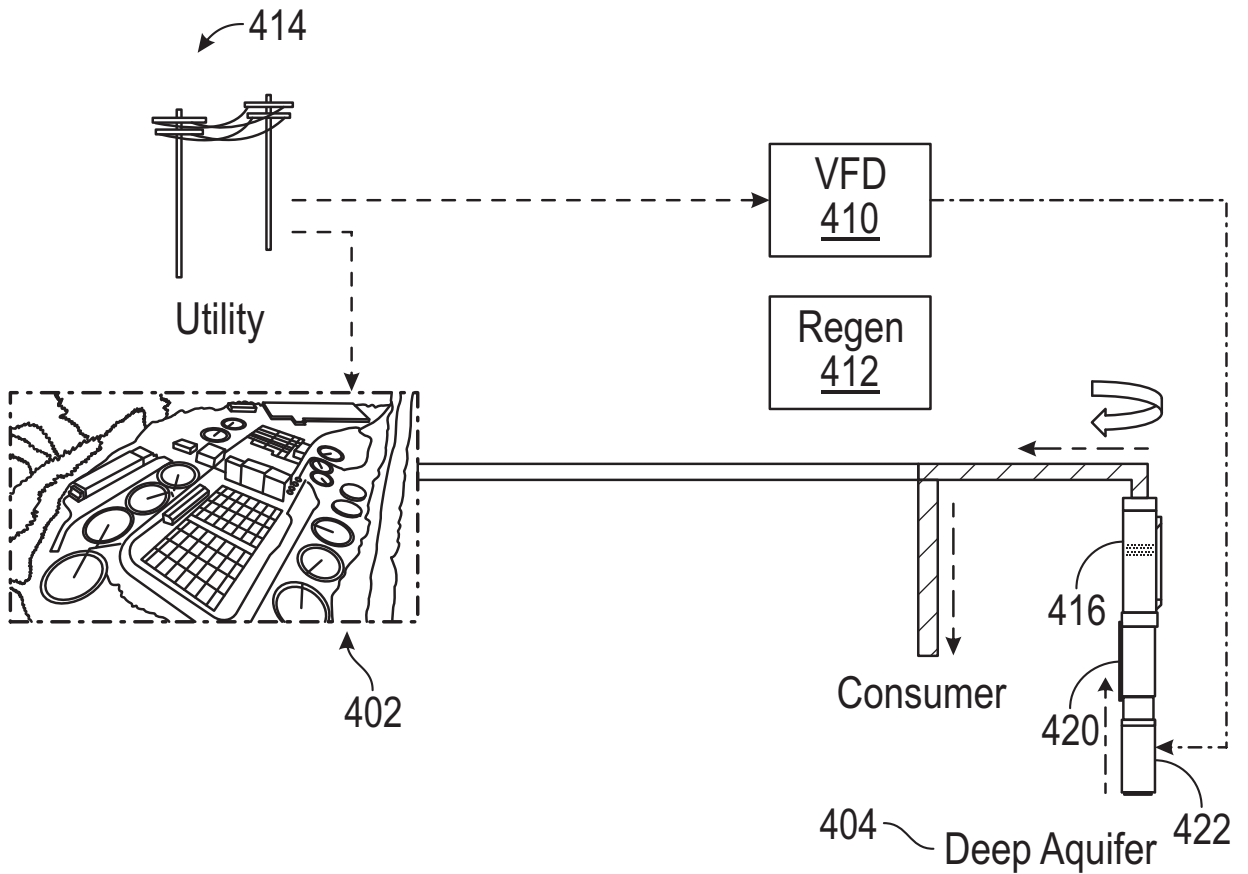

FIG. 13

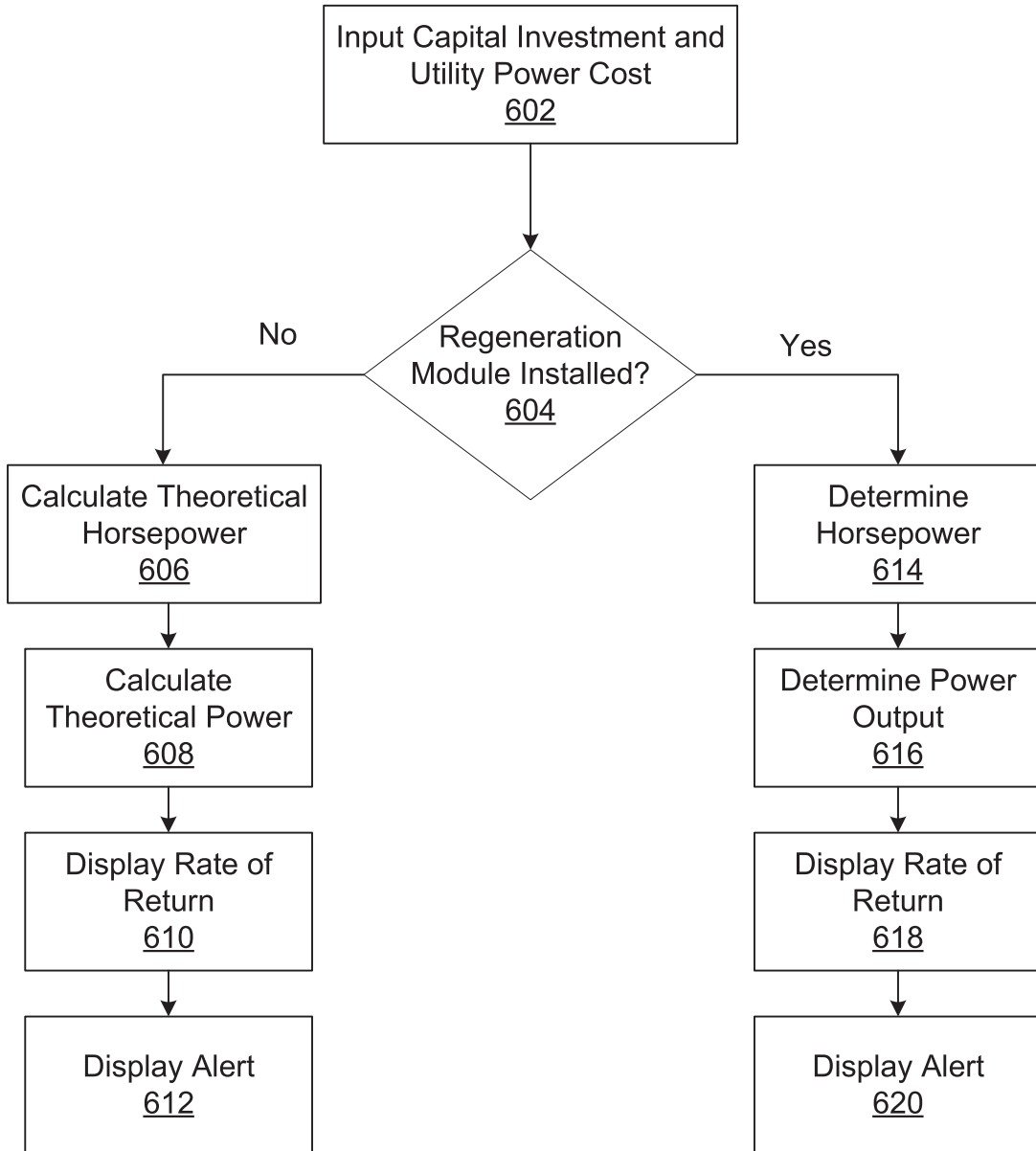

FIG. 14

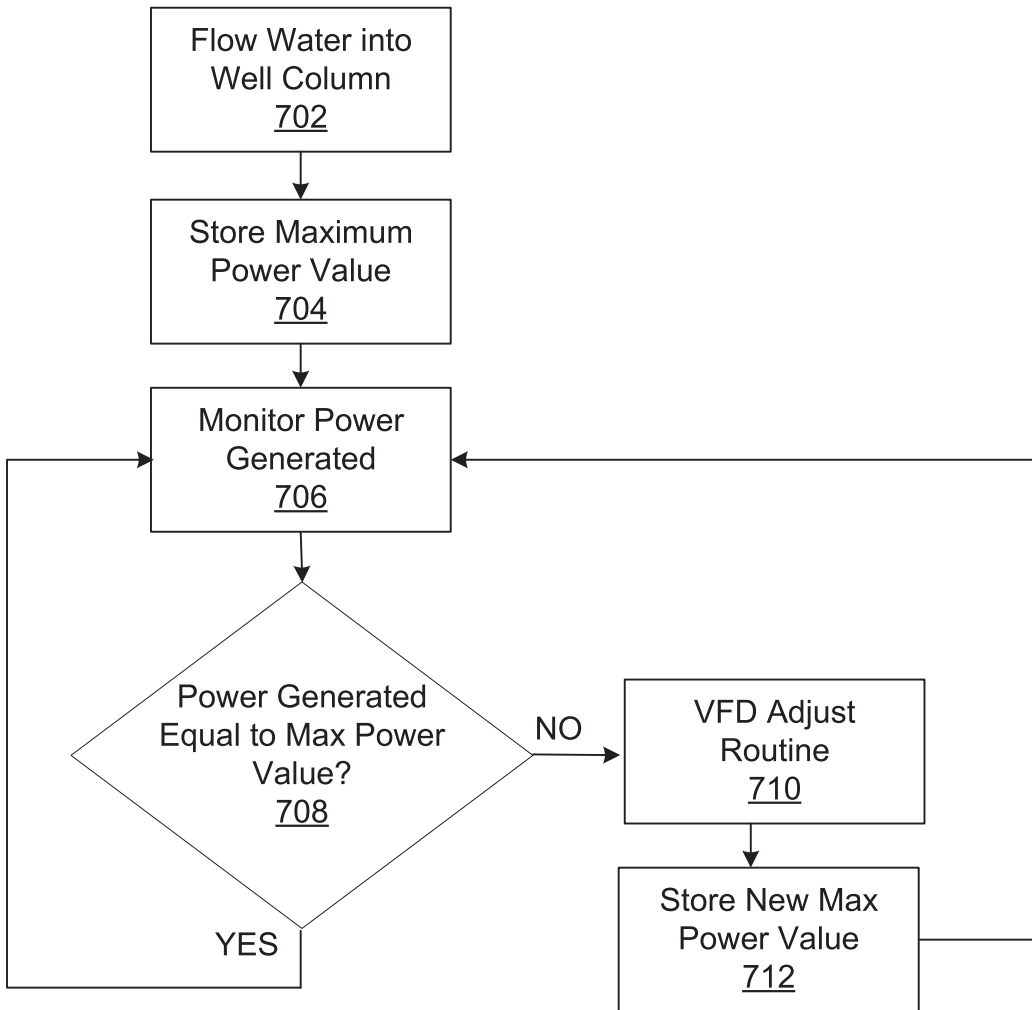

FIG. 15

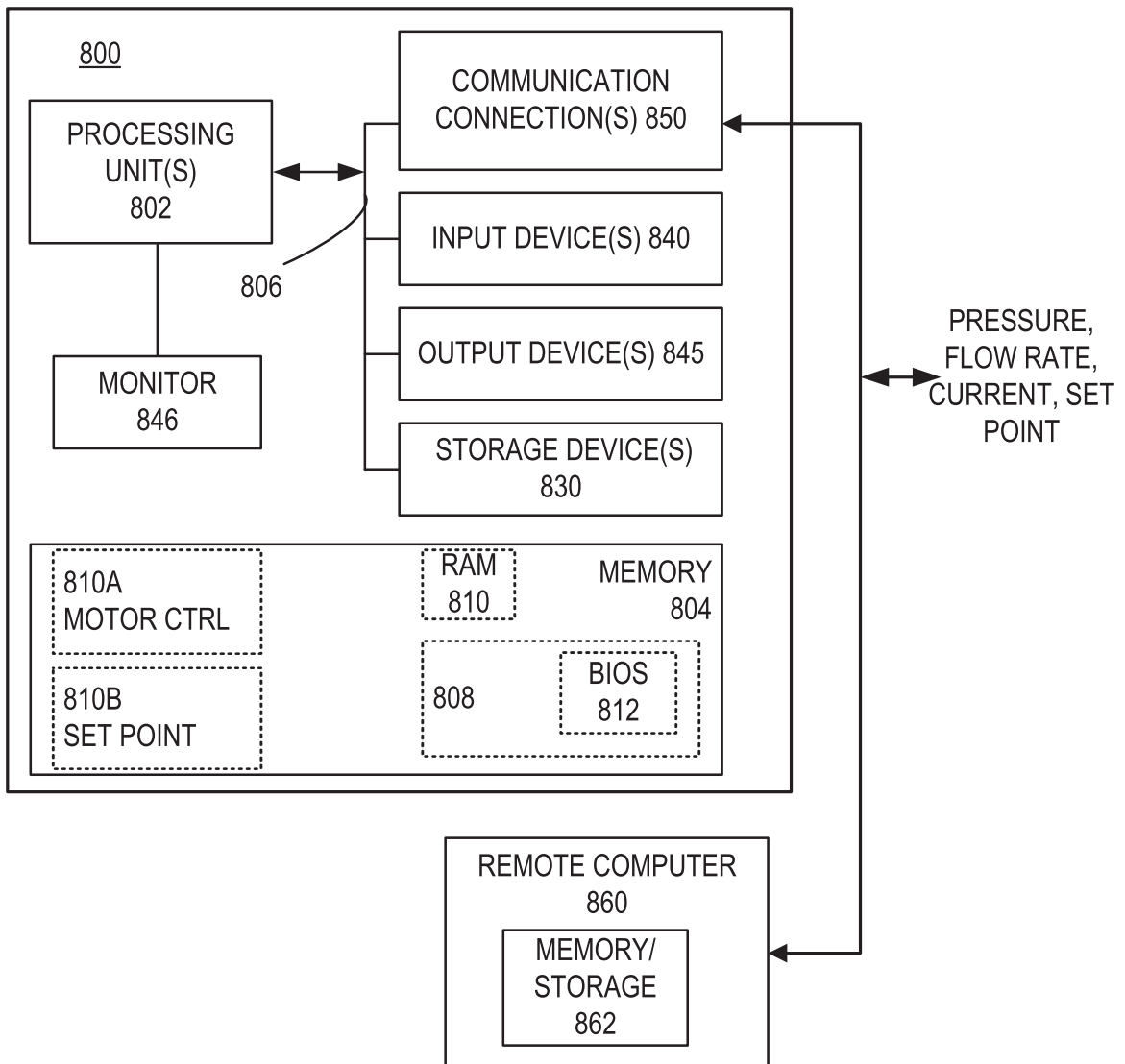
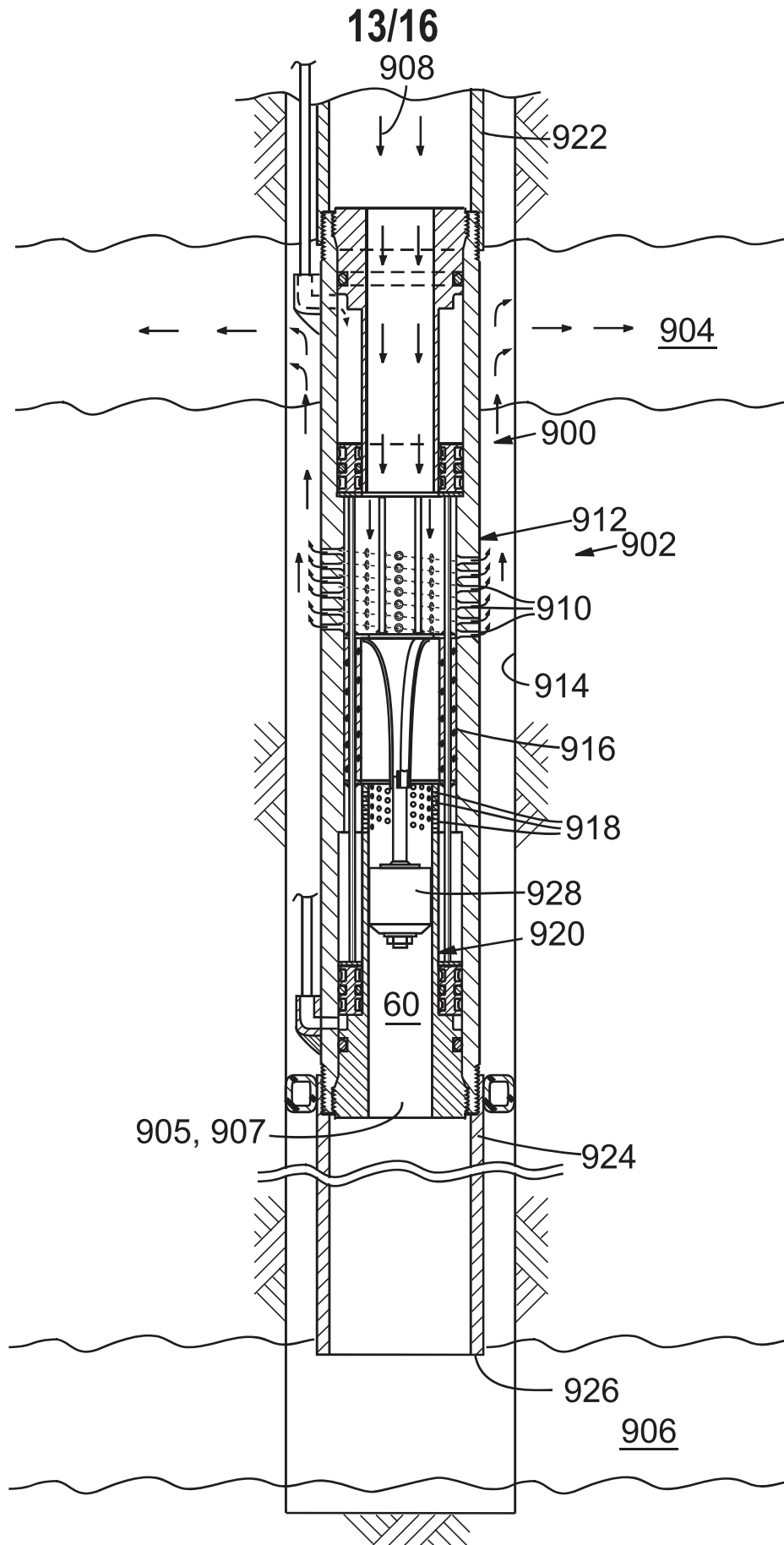

FIG. 16



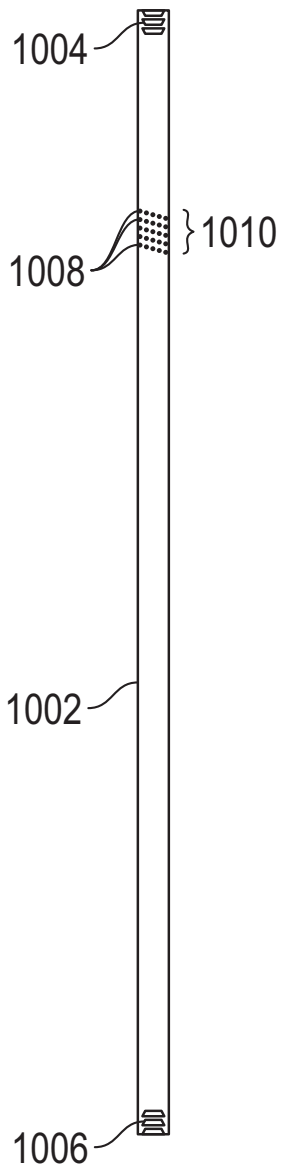

FIG. 18

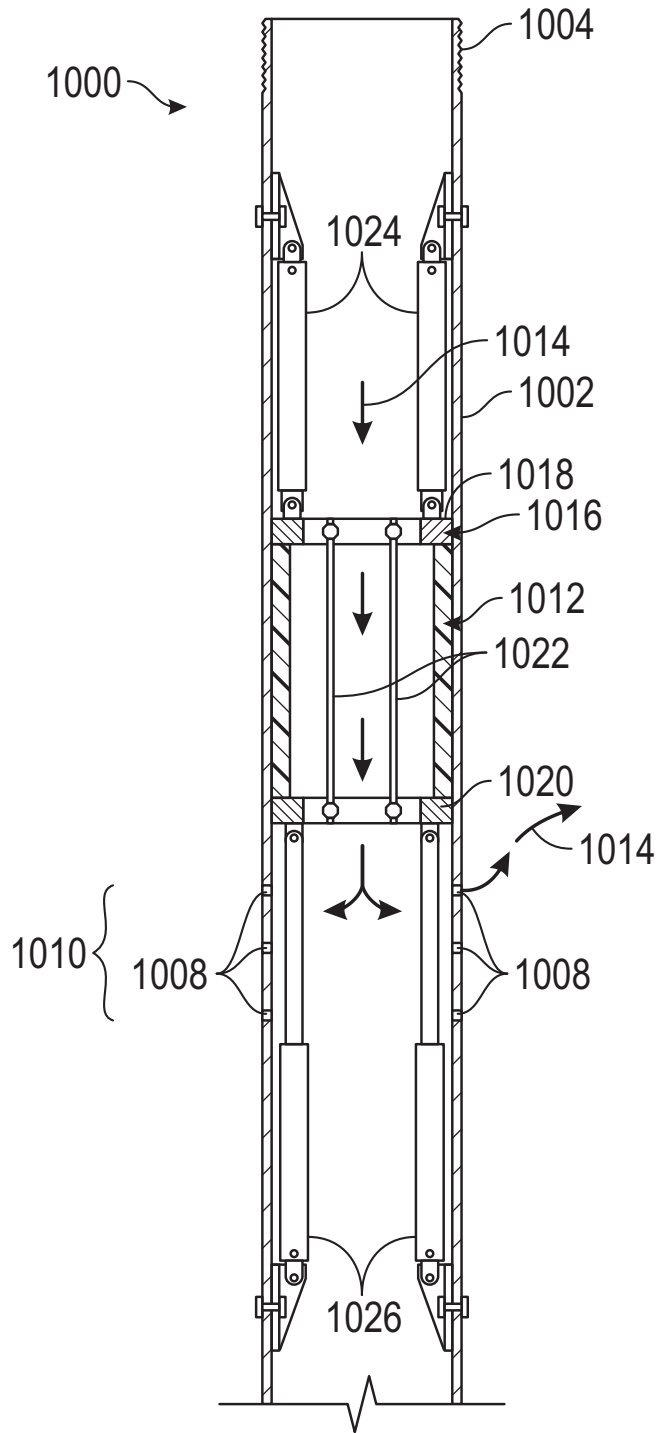

FIG. 19

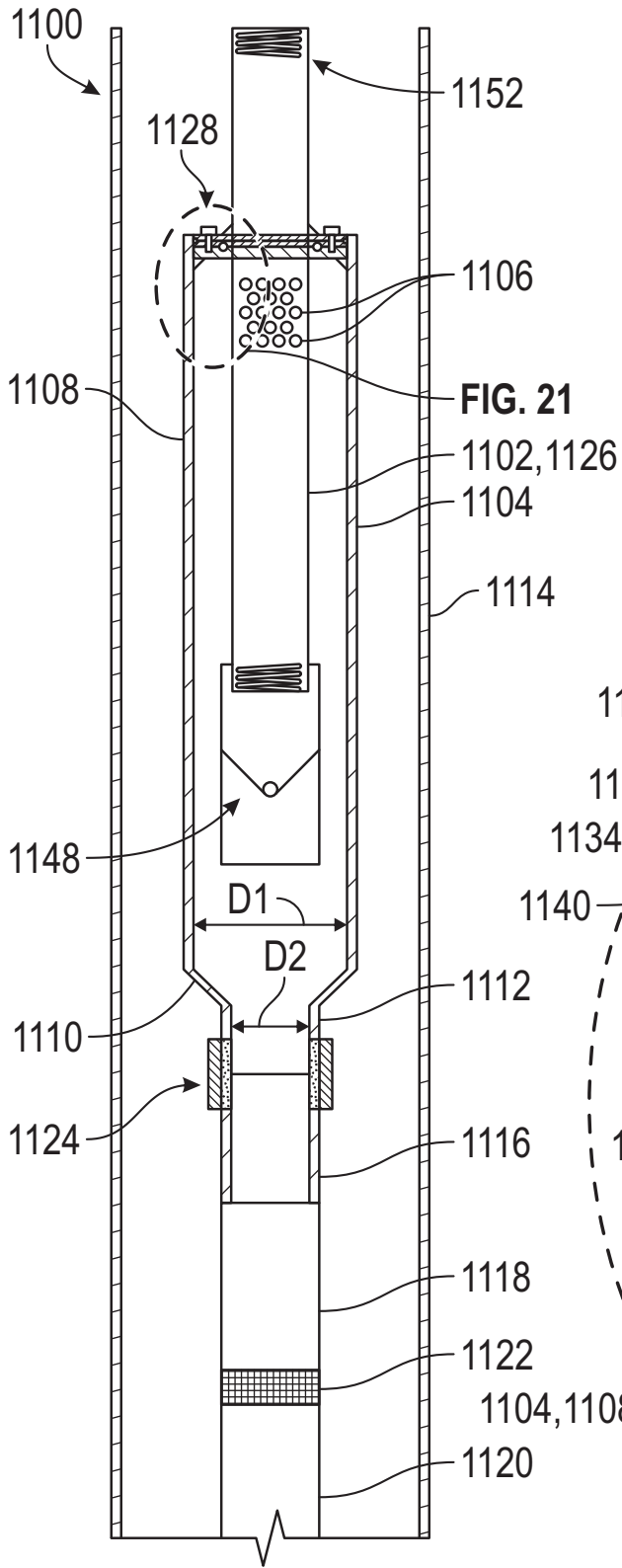

FIG. 20

FIG. 21

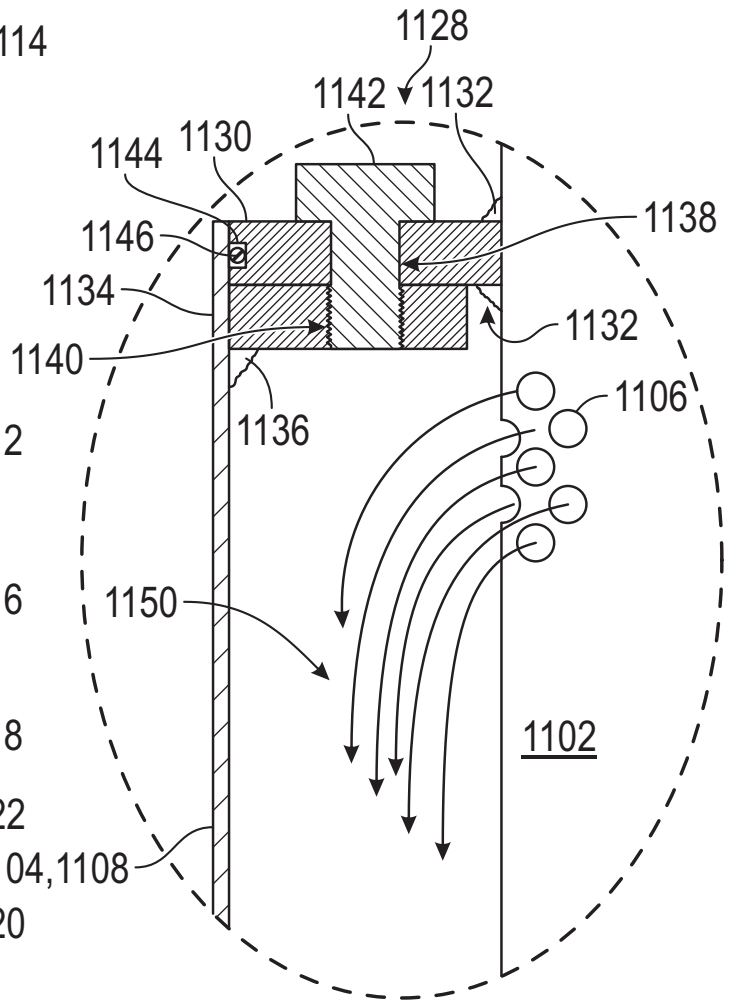

FIG. 21

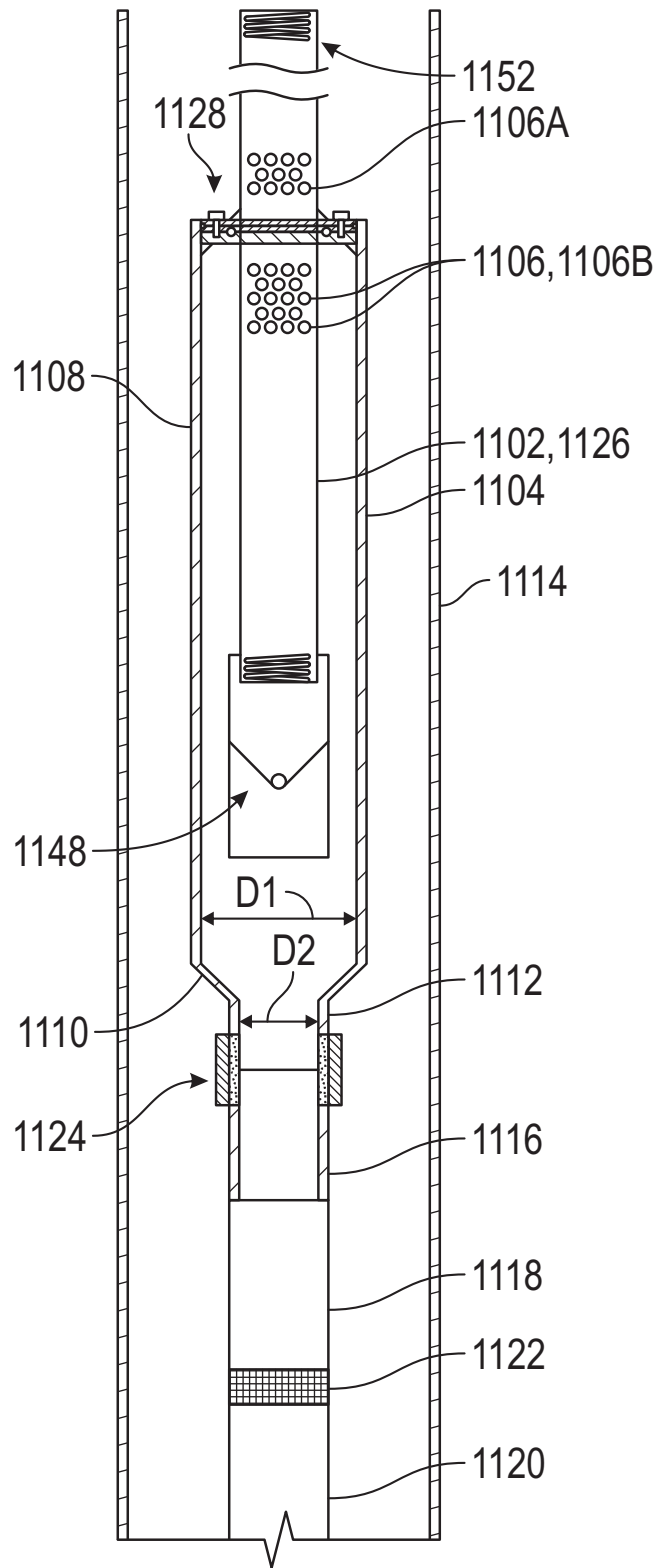

FIG. 22