



Kawneer UK Ltd
Astmoor Road, Astmoor Industrial Estate
Runcorn, Cheshire WA7 1QQ, United Kingdom
Tel: +44 (0) 1928 502500 Fax: +44 (0) 1928 502501

London Office
12 Berwick Street
Soho
London W1F 0PN
Tel: +44 (0) 207 287 5911
Email: kuk.kawneer@arconic.com
www.kawneer.co.uk

Other brochures available on request from Kawneer are:

- Architectural Aluminium Systems Finishes
- Door Systems
- Framing Systems
- Unitised Curtain Wall Systems
- AA®130 Brise Soleil System
Solar Shading for Reduced Solar Heat Gain
- Window Systems
- Juliet Balcony
- LouvreShield
- Sliding Solutions
- Residential Aluminium Glazing Systems
- Specialist Horizontal Sliding Window Solutions for your Healthcare Project
- Fire Resistant Systems
- The Architects Guide to Aluminium in Building
- Sustainability
- Maintenance and Cleaning



Kawneer's continuous development and engineering programmes may bring about product changes. Kawneer reserves the right to introduce without notice such changes which will not detract from the product's performance
© KAWNEER UK LTD



CURTAIN WALL SYSTEMS





BTR Towers, Erie Basin, Salford Quays

Architect: Sheppard Robson

Photo: David Millington Photography

Contents

Curtain Wall Design Considerations	4
Zone or Mullion Drained?	5
Curtain Wall Product Characteristics/Regulations	6
AA®100 50mm Curtain Wall System	8, 12-27
AA®110 65mm Curtain Wall System	10, 12-27
Windows and Doors into Curtain Walling	28
AA®100 and AA®110 Concealed Vent (CV)	34
AA®100 and AA®110 Horizontally Capped (HC) and AA®100 and AA®110 Vertically Capped (VC) Gasket System	38
AA®100 and AA®110 Structurally Silicone Glazed (SSG)	52
AA®100 and AA®110 PFL	58
Case Study – Citylabs 2.0, Manchester	64
Supporting Your Projects	66

Today's fast paced construction schedules demand it all – design innovation, flexibility, high quality, fast installation, simplified fabrication and superior performance. Kawneer's curtain wall systems have been designed and engineered to meet these demands and more.

Our curtain wall systems have been tested and assessed in accordance with the relevant BS EN and Centre for Window and Cladding Technology (CWCT) Curtain Wall Standards.



Curtain Wall Design Considerations

Please note this is for guidance only

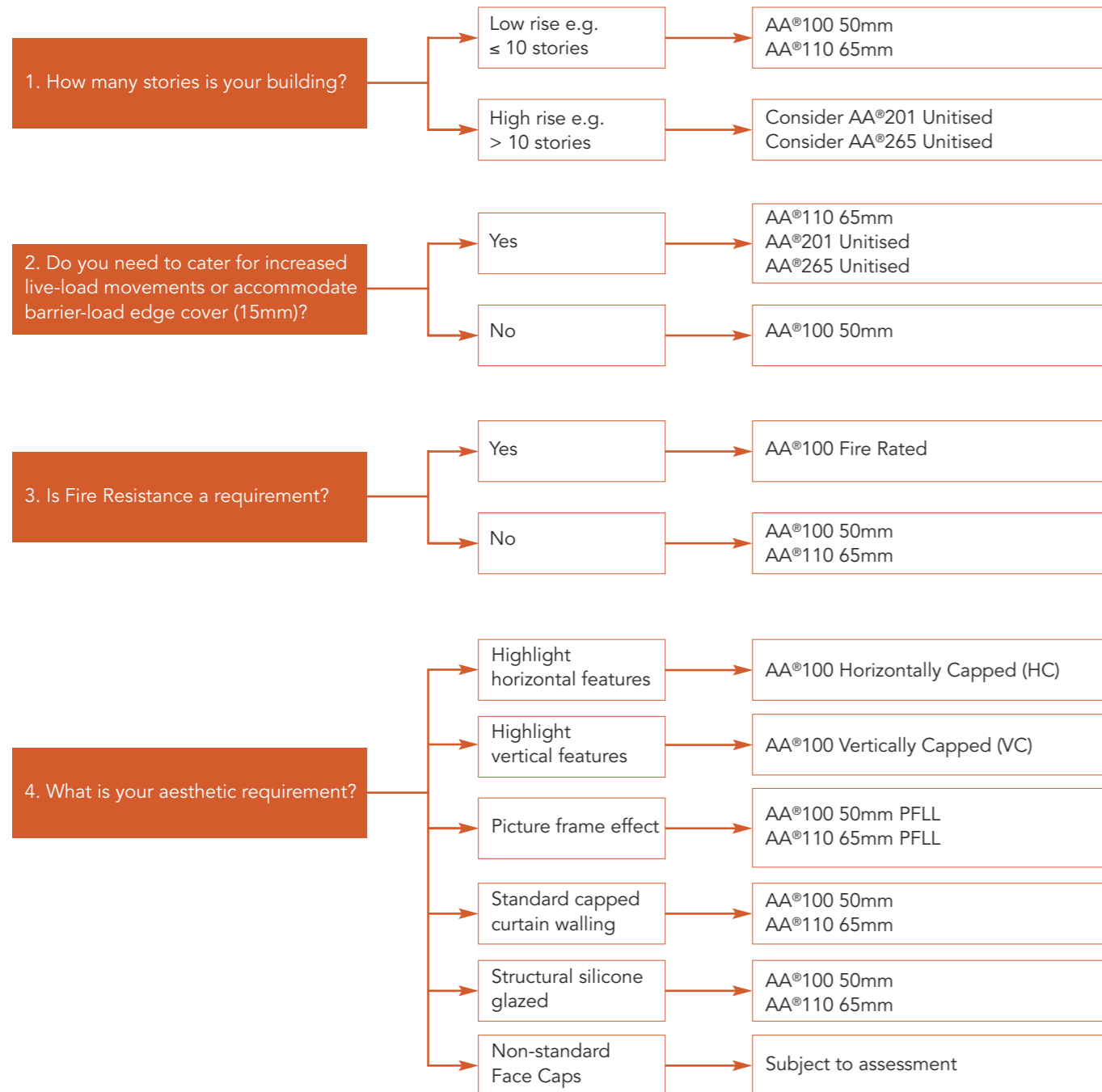

Zone or Mullion Drained?

Zone Drainage

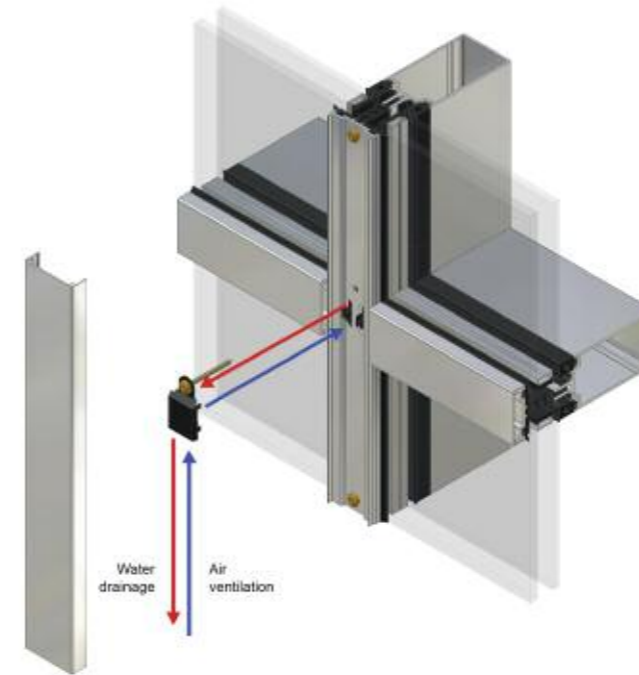

Zone drainage systems feature simple butt jointed mullions and transoms, with each panel acting as an individual unit. Drainage and ventilation slots are located in the vertical pressure plate. Transoms are square cut at the ends to incorporate EPDM mouldings and gaskets to maintain each zone.

Transoms are fitted with a 'Batman gasket' to maintain the thermal performance.

Benefits

- Each panel is individually pressure equalised and drained via its transom, enabling the curtain wall to quickly react to fluctuating wind pressure

Mullion Drainage



Mullion (or point) drainage systems feature overlapping joints. Drainage and ventilation slots are located in the vertical pressure plate. Transoms are overlapped to the mullion which incorporates an EPDM gasket to seal between mullion and transom.

Transoms are fitted with a 'Batman gasket' to maintain the thermal performance.

Benefits

- Suitable for slope glazing



Curtain Wall Product Characteristics/Regulations

System	BS EN 13830 & CWCT Test	Expansion Joint	Facets	Barrier Loading required?	Concealed Vent
AA®100	✓	✓	✓	✓*	✓
AA®100 HC	✓		✓	✓	✓
AA®100 VC	✓	☎	✓	✓	✓
AA®100 Slope Glazing	✓		✓		
AA®100 SSG	✓		☎	✓	☎
AA®100 PFL	☎				
AA®100 Fire Resistant	BS 476-22, Pr EN 1364-3	✓			
AA®110	✓	✓**	✓	✓	✓
AA®110 HC	CWCT Assessment	✓	✓	✓	✓
AA®110 VC	CWCT Assessment	✓	✓	✓	✓
AA®110 SSG	CWCT Assessment	✓▲	☎	✓	☎
AA®110 Slope Glazing	☎		✓	✓	
AA®110 PFL	☎			✓	
AA®201 Unitised	✓	✓	☎	✓	☎
AA®201 Unitised HC/VC	✓	✓	☎	✓	☎
AA®201 Unitised SSG	✓	✓	☎	✓	☎
AA®265 Unitised	✓	✓	☎	✓	☎

Key
 ✓ = Available ☎ = Project dependant; contact our advisory line * = Subject to Structural Assessment
 ** = For the +/- 15mm AA®110 Large Movement Joint, see pages 10-11 and contact the Technical Services Team for advice
 ▲ = For the +/- 5mm AA®110 SSG Large Movement Joint, see pages 52-53 and contact the Technical Services Team for advice
 HC = Horizontally Capped VC = Vertically Capped SSG = Structurally Silicone Glazed PFL = Picture Frame Look-Alike
 Note: HI version cannot be faceted

Thermal compliance in line with current Building Regulations	Compatibility with Kawneer Doors and Windows	HI Option	Glazing	Drainage Method	Acoustic Performance Doc E
✓	✓	✓	Upto 40mm - 50mm	Zone or Mullion Drained	✓
✓	✓	✓	Upto 40mm - 50mm	Zone or Mullion Drained	✓
✓	✓	✓	Upto 40mm - 50mm	Zone or Mullion Drained	✓
✓	✓		Upto 40mm - 50mm	Mullion Drained	✓
✓	✓		Upto 4mm - 40mm	Mullion Drained	
✓	✓	✓	Upto 40mm - 50mm	Zone or Mullion Drained	
✓	✓	✓	Upto 40mm - 50mm	Zone Drained	
✓	✓		Upto 40mm - 50mm	Zone or Mullion Drained	✓
✓	✓		Upto 50mm	Zone or Mullion Drained	✓
✓	✓		Upto 50mm	Zone or Mullion Drained	✓
✓	✓		Upto 4mm - 40mm	Mullion Drained	
✓	✓		Upto 40mm - 50mm	Mullion Drained	✓
✓	✓		Upto 40mm - 50mm	Zone or Mullion Drained	
✓	✓		Infill panels/glass upto 32mm	Zone Drained	✓
✓	✓		Infill panels/glass upto 32mm	Zone Drained	✓
✓	✓		Infill panels/glass upto 32mm	Zone Drained	✓
✓	✓		Upto 50mm	Zone Drained	

Key
 ✓ = Available ☎ = Project dependant; contact our advisory line * = Subject to Structural Assessment
 ** = For the +/- 15mm AA®110 Large Movement Joint, see pages 10-11 and contact the Technical Services Team for advice
 ▲ = For the +/- 5mm AA®110 SSG Large Movement Joint, see pages 52-53 and contact the Technical Services Team for advice
 HC = Horizontally Capped VC = Vertically Capped SSG = Structurally Silicone Glazed PFL = Picture Frame Look-Alike
 Note: HI version cannot be faceted



Criminal Justice Centre, Aberdeen
 Architect: Ryder Architecture

AA®100 50mm Curtain Wall System

Introduction

A stick-frame assembly with weather performance achieved by drainage and ventilation of the glazing rebates. Drainage and ventilation occurs at every mullion and transom connection in a zone drained system and at the base and above mullion joints in a mullion drained system.

The system is available in a variety of mullion depths which combined with several thermal break options, including an enhanced thermal performance option, and aesthetic external capping allows a specifier the flexibility of design to make their own statement. The system has outstanding performance and its ease of installation makes it possible to suit individual project requirements.

The AA®100 is suitable for vertical and sloped applications including faceted walls.

Design Considerations

A comprehensive range of mullions and transoms allow façades to be designed with minimal structural support. The selection of mullion is dependent on several factors:

- The span (the distance between the fixings to supporting structure)
- The mullion centres (up to 3.0m using AA®100 curtain walling)*
- Windload (up to 2400 Pa)
- Maximum weight of infill (up to 600kg)
- The deflection limitations of the glazing system
- The drainage method required; i.e. zone or mullion

Guidance on this element of the curtain wall design should be sought from the Kawneer Architectural Services Team.

* For mullion centres greater than 3.0m contact the Technical Services Team at Runcorn.

Product Features and Benefits

- Concealed zone drainage - each pane acts as an individual self-draining unit or mullion drainage - ventilation and drainage via the mullions
- Glazing up to 50mm
- Large choice of face caps to enable total design flexibility to suite your individual aesthetic requirements
- Bespoke face caps available (subject to approval)
- Fire resistant solution providing uniformity of the façade in accordance with Pr EN 1364-3, with up to 30 minutes integrity and insulation
- Patented transom overlap detail which gives the uniform aesthetic finish

- Market leading product tested and certified in accordance with CWCT Sequence B
- Range of mullion, transom and face cap options with 50mm sightlines
- Enhanced thermal performance to meet or exceed current Building Regulations
- Incorporates AA®130 Brise Soleil System
- Facilitates the integration of opening window products including a concealed vent option
- HC/VC gasket system provided as an alternative to structural glazed solutions

AA®100 HC/VC (Horizontal/Vertical Cap)

The Horizontal/Vertical Cap provides the specifier the opportunity to highlight the horizontal or vertical features across the building envelope and gives the building its individual signature. The variety of distinctive face caps gives total flexibility in design. The system has been exclusively designed, developed and supplied by Kawneer, with installation contracts carried out by approved Dealers.

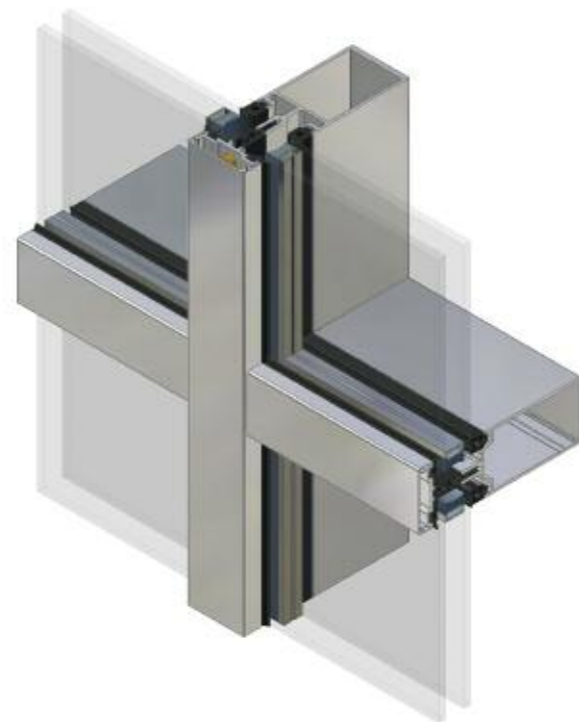

AA®100 50mm

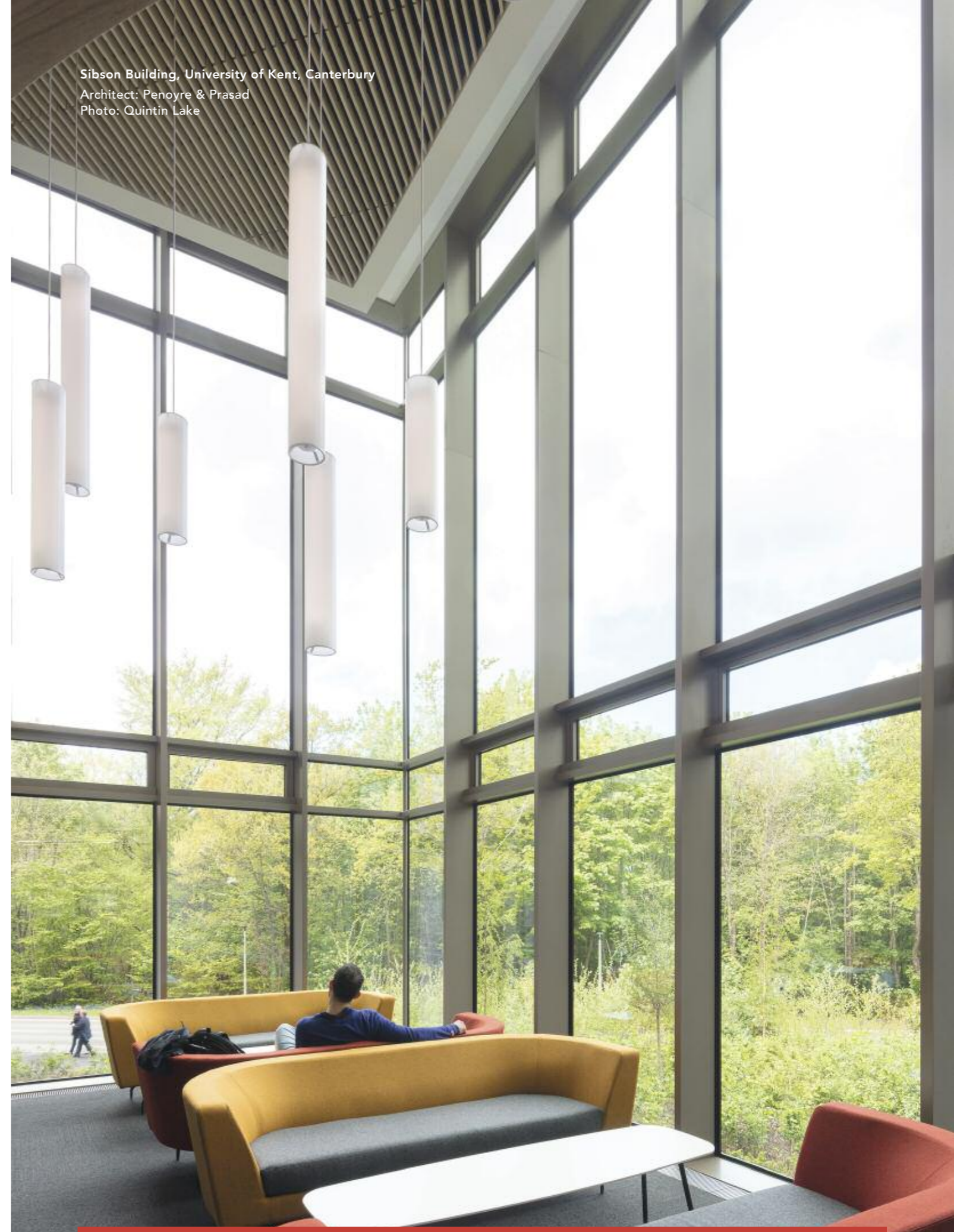

Sibson Building, University of Kent, Canterbury

Architect: Penoyre & Prasad

Photo: Quintin Lake

AA®110 65mm Curtain Wall System

Introduction

The AA®110 65mm curtain wall system is designed as a stick-frame assembly with weather performance achieved by drainage and ventilation of the glazing rebates. Drainage and ventilation occurs at every mullion and transom connection in a zone drained system and at the base and above mullion joints in a mullion drained system. The system is available in a variety of mullion depths which combined with several thermal break options and aesthetic external capping provide flexibility of design, outstanding performance and ease of installation to suit individual project requirements.

The AA®110 is suitable for vertical and sloped applications including faceted walls. A deeper glazing rebate meets the requirements for barrier loading and enables facades to stand up to high levels of building movement.

Allowances for slab deflection of +/- 15mm can be achieved. Large glass panels can be used allowing more natural light penetration. In addition, less metal results in an aesthetically pleasing building – on the whole better for both the environment and the building occupier.

The system has been exclusively designed, developed and supplied by Kawneer, with installation contracts carried out by approved Dealers.

Design Considerations

A comprehensive range of mullions and transoms allow façades to be designed with minimal structural support. The selection of mullion is dependent on several factors:

- The span (the distance between the fixings to supporting structure)
- The mullion centres (up to 3.5m using AA®110 curtain walling)*
- Windload (up to 2400 Pa)
- Maximum weight of infill (up to 600kg)
- The deflection limitations of the glazing system
- The drainage method required; i.e. zone or mullion
- Floor slab live load deflection

Guidance on this element of the curtain wall design should be sought from the Kawneer Architectural Services Team.

* For mullion centres greater than 3.5m contact the Technical Services Team at Runcorn.

Product Features and Benefits

- Concealed zone drainage – each pane acts as an individual self-draining unit or mullion drainage – ventilation and drainage via the mullions
- Fully capped (zone drained and mullion drained with wide choice of facecap options)
- Bespoke face caps available (subject to approval)
- Glazing up to 50mm
- Thermal performance to meet or exceed current Building Regulations
- Incorporates AA®130 Brise Soleil System

- Tested and certified in accordance with CWCT Sequence B
- Range of mullion, transom and face cap options with 65mm sightlines
- Facilitates the integration of opening window products including a concealed vent option
- A range of thermal break options are available
- Offers a cost effective solution for barrier loading
- Floor slab live load deflection of +/- 15mm is achievable**

** Contact the Technical Services Department at Runcorn for advice.

AA®110 HC/VC (Horizontal/Vertical Cap)

The Horizontal/Vertical Cap provides the specifier the opportunity to highlight the horizontal or vertical features across the building envelope and gives the building its individual signature. The variety of distinctive face caps gives total flexibility in design. The system has been exclusively designed, developed and supplied by Kawneer, with installation contracts carried out by approved Dealers.



AA®110 Large Movement Joint

Increased Building Movement Allowance

Introduction

Glazing and cladding systems need to be designed to allow for building movement without compromising the performance or safety of the system.

The consequences of failing to provide sufficient allowance for in-service building movement can range from a reduction in weather performance to glass breakage and significant system failure.

One of the main complexities in designing a façade is the accommodation of slab movement/deflection.

Due to the extension of structural spans seen in today's building designs, slab deflection is increasing. This places additional demands on the façade design team to accommodate movement between slab and façade.



When building designs require façades to withstand high slab deflections one solution is to incorporate unitised curtain wall systems which, due to their construction, can provide greater movement allowance. However, unitised curtain walling is most appropriate for large façades and are generally only undertaken by specialist fabricators and installers.

Conventional stick curtain walling is widely specified in the UK and offers a cost-effective façade solution particularly on buildings which do not have a requirement for significant movement allowance.

AA®110 Large Movement Joint

Kawneer have recognised that a capacity for greater movement allowance within a stick curtain walling system would extend the scope of applications for which such systems can be specified. The AA®110 has been developed to accommodate up to +/-15mm differential vertical movement between the façade and the supporting sub-structure.

This has been achieved through the design of an expansion joint for connecting vertical mullions. The joint, located at each slab level and therefore concealed by spandrel glass or panels, uses specialised engineered foam seals which expand and contract with the movement of the structure. In conjunction with this, a unique transom profile at each floor level provides allowance for the increased movement of the spandrel infill whilst maintaining air and weathertightness of the façade. Also incorporated into the design is a bespoke breather membrane which directs any ingress into the glazing rebates to the internal drainage channels.



CWCT Dynamic Test

The system has undergone rigorous testing during its development to ensure performance in all UK conditions. Working closely with the CWCT an enhanced version of the Standard for Systemised Building Envelope: Sequence B test program was successfully carried out. This included testing while the expansion joint was in compression, extension and in the neutral position.

Technical Support

Kawneer offers a Façade Workshop consisting of a team of specialists who work collaboratively with developers, architects and engineers during the early stages of a project. This unique design and consultancy service, working across every aspect of the façade, ensures the design intent is realised on all projects.

AA®100 50mm and AA®110 65mm Zone Drained Façade Applications

Typical Elevations

Full details can be downloaded from our website www.kawneer.co.uk

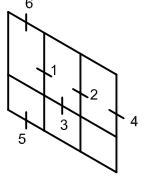
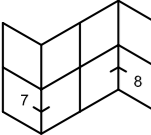
Elevation	Title	Website cad ref no.
	1 Intermediate Mullion	H1 02.01
	2 Expansion Mullion	H1 03.01
	3 Intermediate Transom	H1 04.01
	4 Jamb detail (generic)	H1 10.01
	5 Cill detail (generic)	H1 11.01
	6 Head detail (generic)	H1 12.01
	7 External Corner	H1 05.01
	8 Internal Corner	H1 06.01

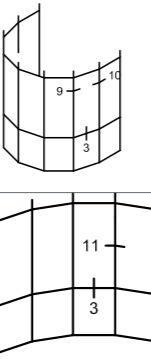
Elevation	Title	Website cad ref no.
	3 Intermediate Transom	H1 04.01
	9 Convex Faceted Mullion	H1 07.01
	10 Convex Faceted Mullion	H1 08.01
	11 Convex Faceted Mullion	H1 09.01

AA®100 50mm and AA®110 65mm Zone Drained Façade

Full details can be downloaded from our website www.kawneer.co.uk

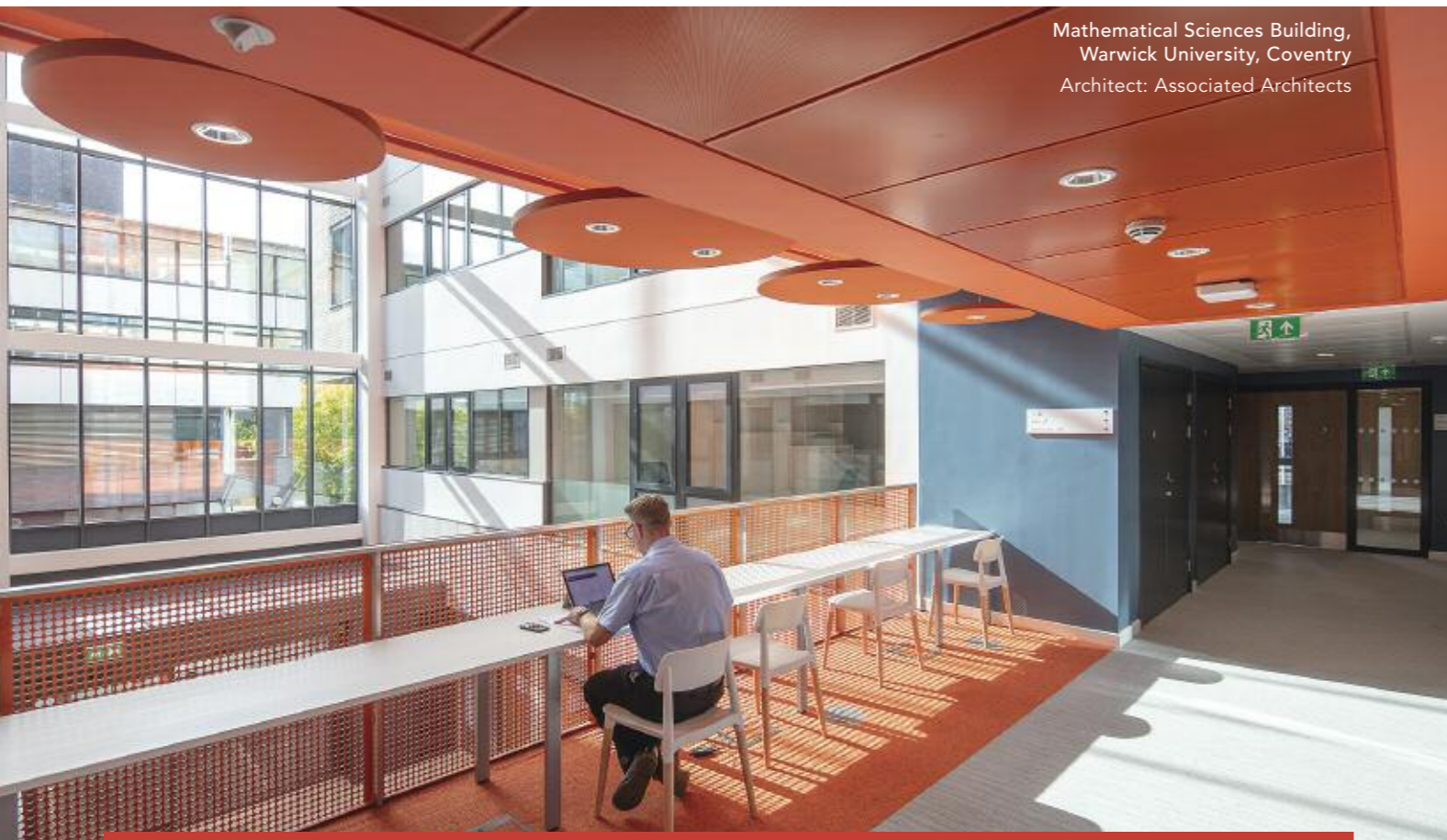
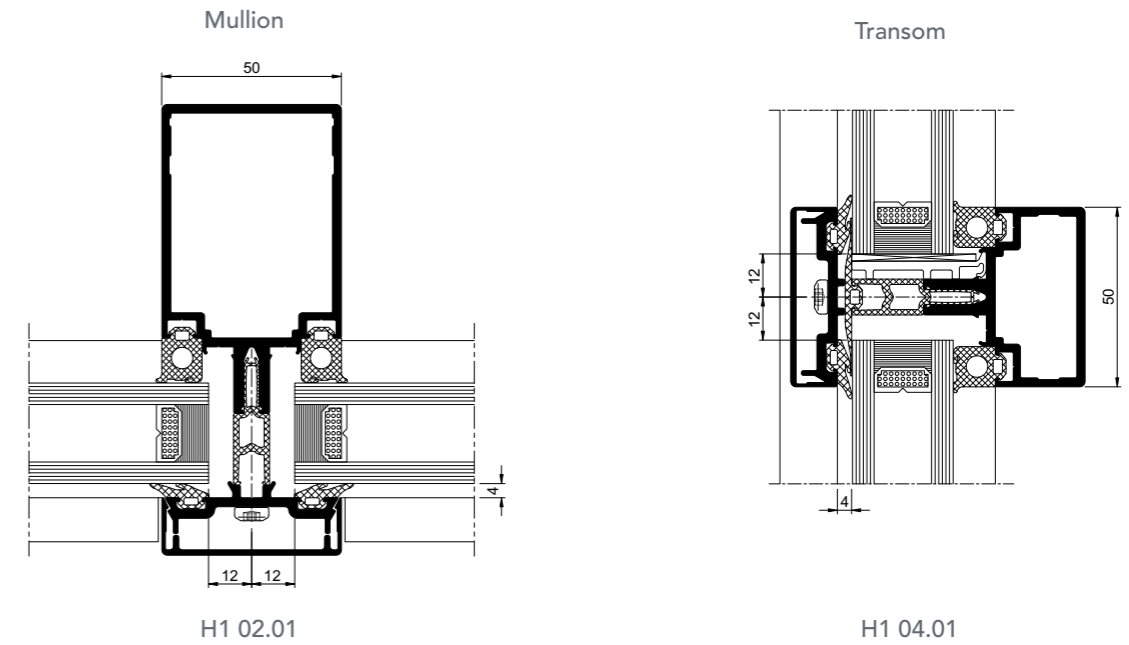

AA®100 50mm and AA®110 65mm Zone Drained Façade

Full details can be downloaded from our website www.kawneer.co.uk

External Corner

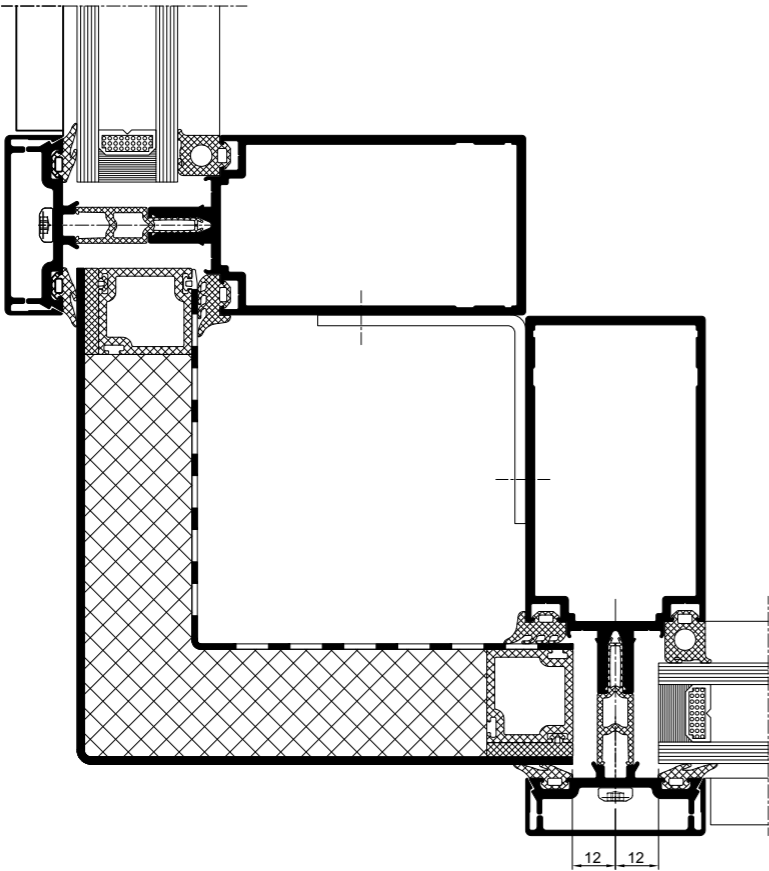

H1 05.01

AA®100 50mm and AA®110 65mm Zone Drained Façade

Full details can be downloaded from our website www.kawneer.co.uk

Internal Corner

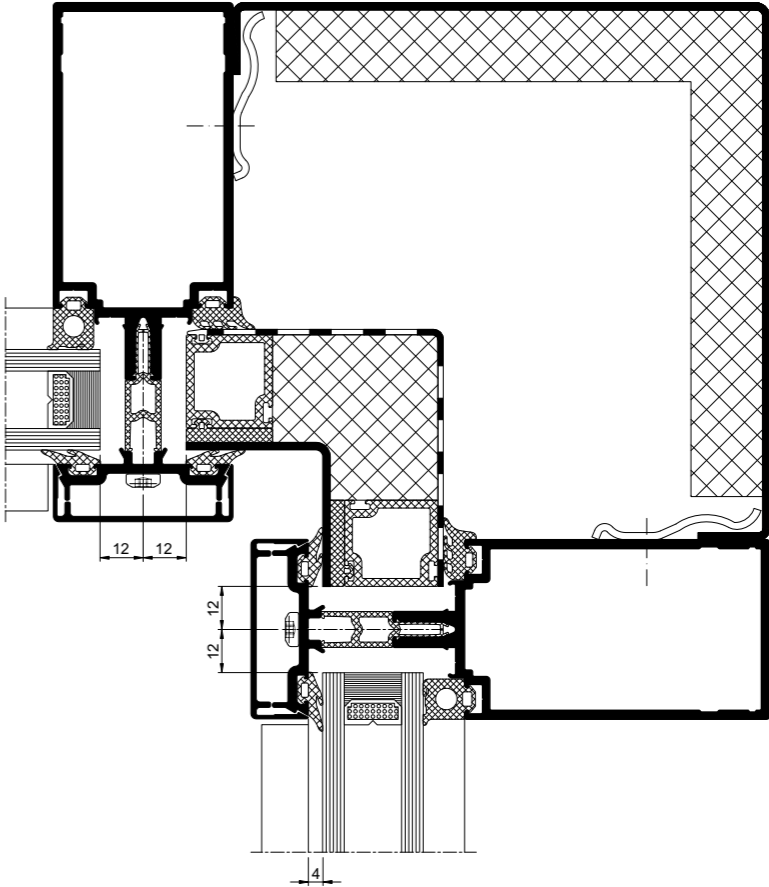

H1 06.01

AA®100 50mm and AA®110 65mm Zone Drained Façade

Full details can be downloaded from our website www.kawneer.co.uk

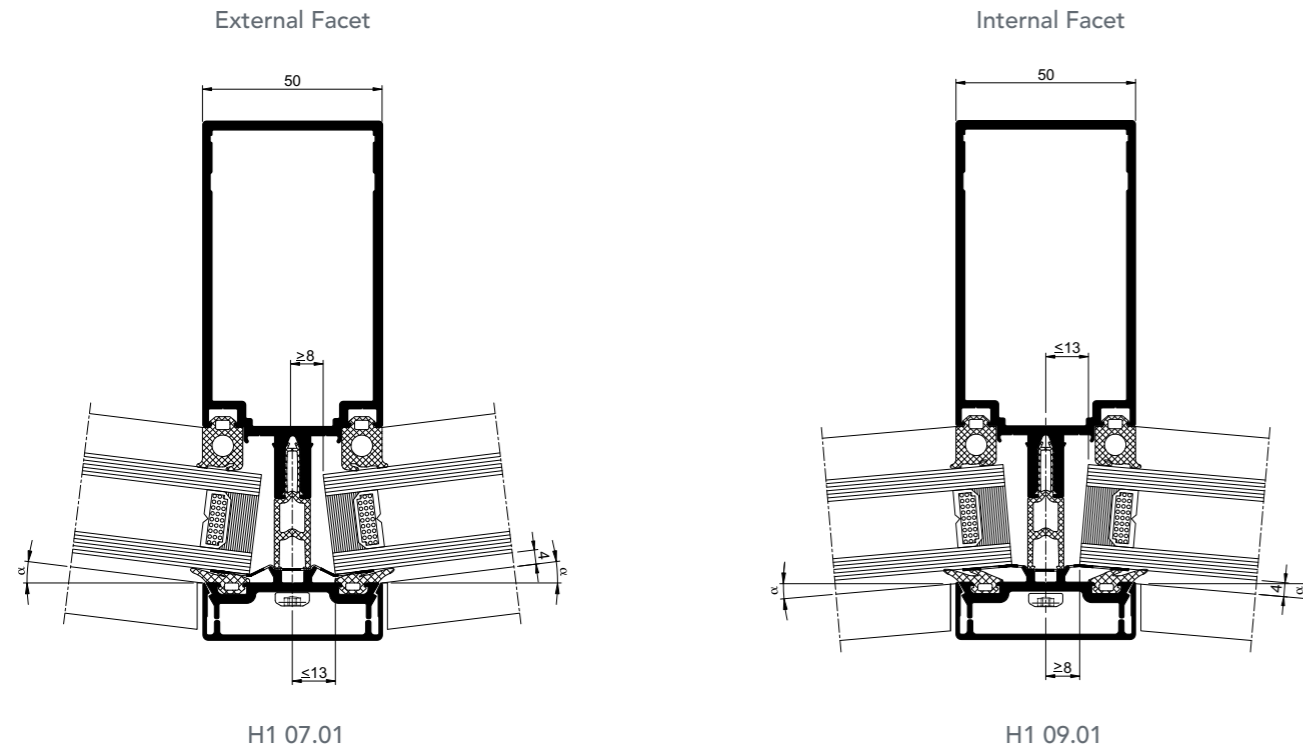

AA®100 50mm and AA®110 65mm Zone Drained Façade

Full details can be downloaded from our website www.kawneer.co.uk

Jamb Interface Detail (Example)

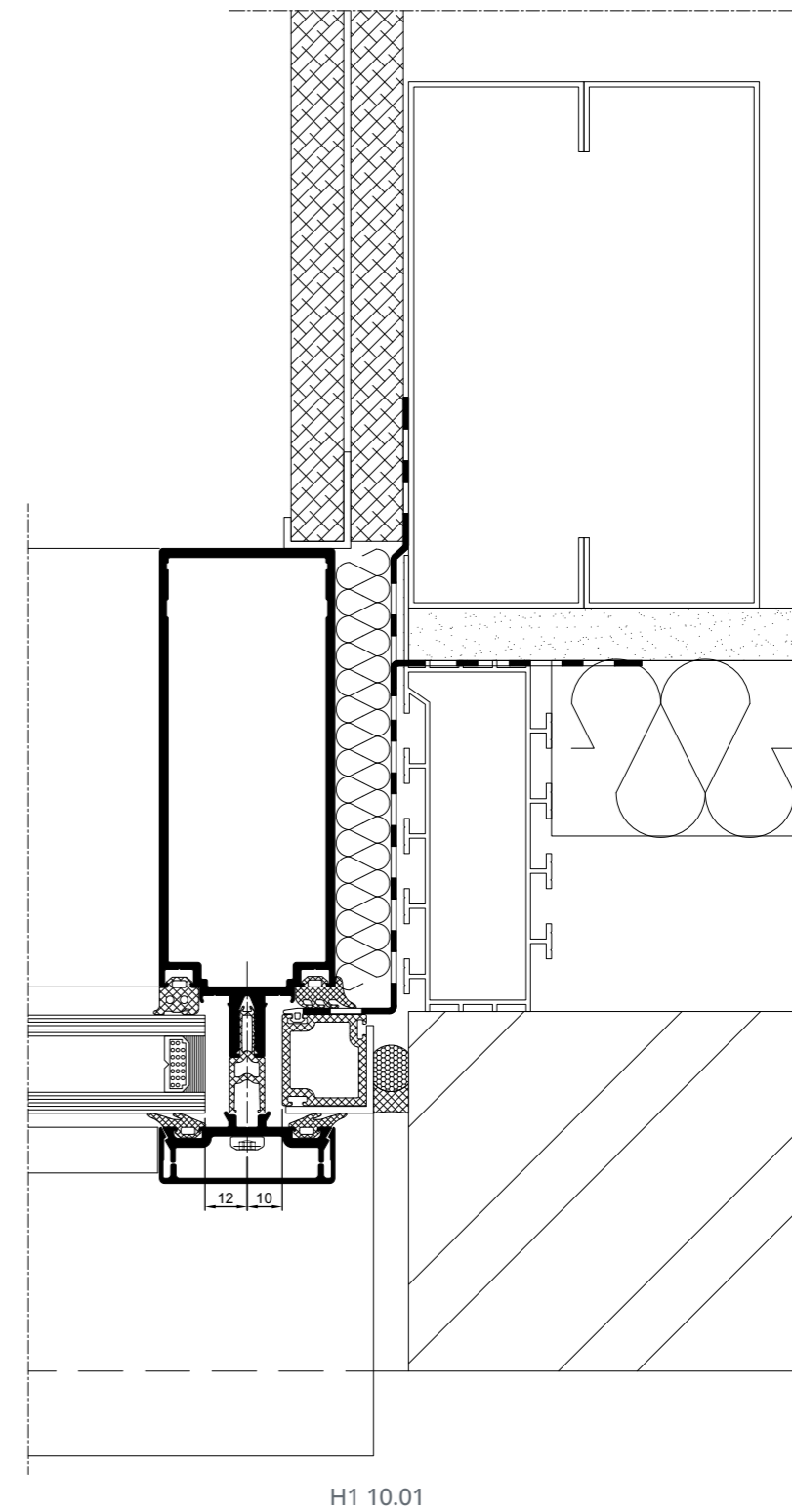

Canolfan S4C Yr Egin, University of Wales, Carmarthen
Architect: BDP
Photo: © Craig Auckland/fotohaus



AA®100 50mm and AA®110 65mm Zone Drained Façade

Full details can be downloaded from our website www.kawneer.co.uk

Head Detail

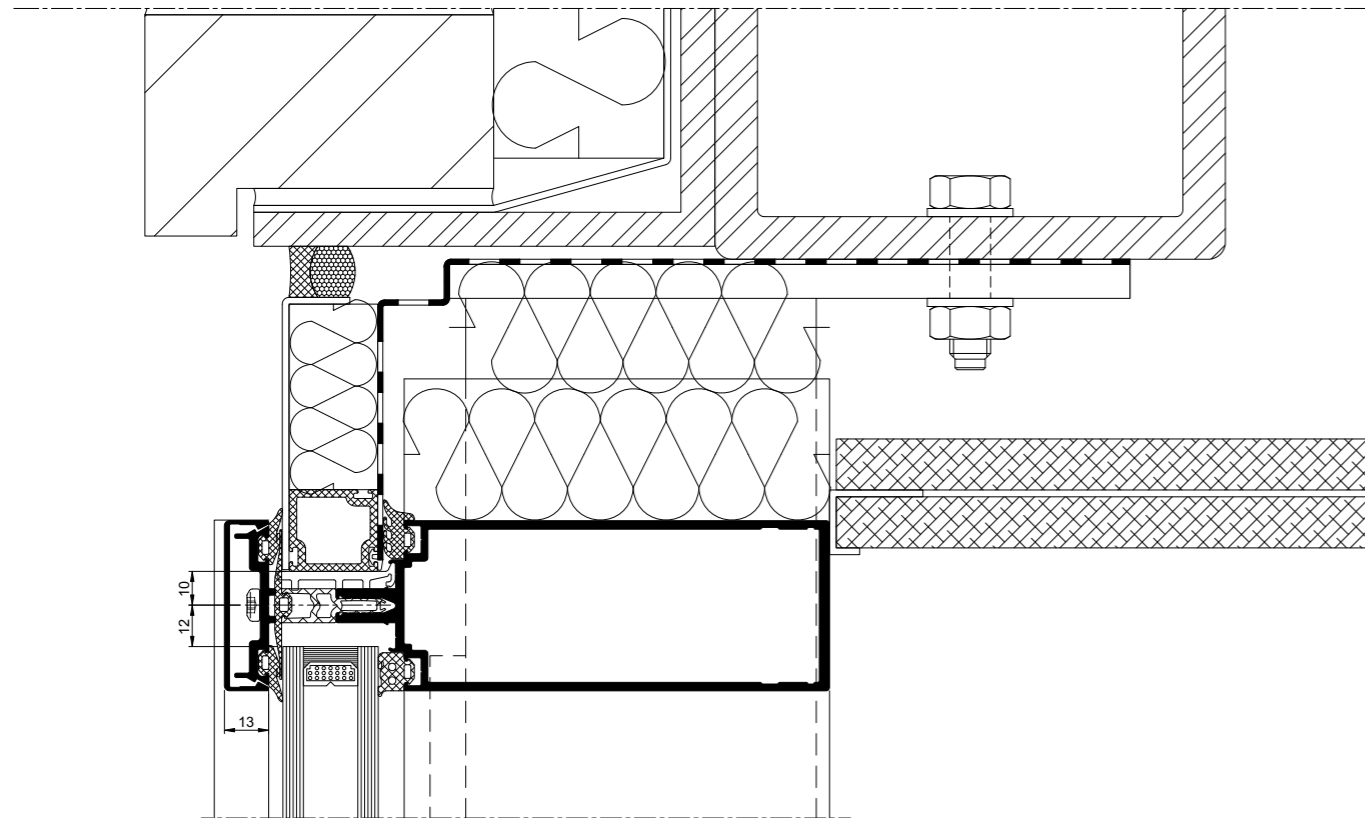

H1 12.01

AA®100 50mm and AA®110 65mm Zone Drained Façade

Full details can be downloaded from our website www.kawneer.co.uk

Cill Detail

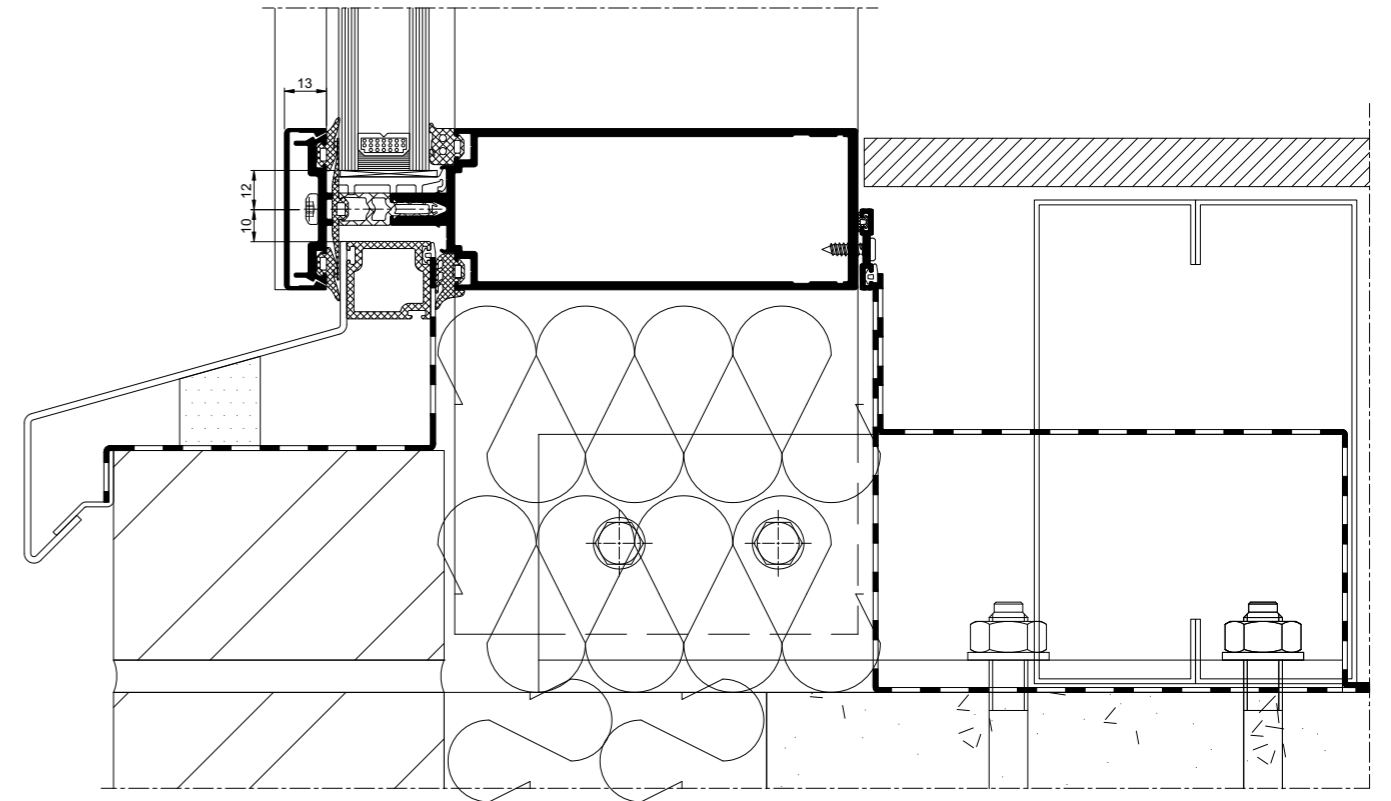

H1 11.01

AA®100 50mm and AA®110 65mm Mullion Drained Façade and Roof Applications

Typical Elevations

Full details can be downloaded from our website www.kawneer.co.uk

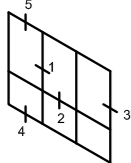
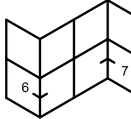
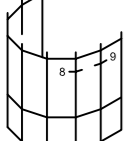
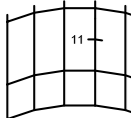
Elevation	Title	Website cad ref no.
	1 Intermediate Mullion	H2 02.01
	2 Intermediate Transom	H2 03.01
	3 Jamb detail (generic)	H2 26.01
	4 Cill detail (generic)	H2 25.01
	5 Head detail (generic)	H2 24.01
	6 External Corner	H2 08.01
	7 Internal Corner	H2 09.01
	8 Convex Faceted Mullion	H2 10.01, H2 11.01, H2 12.01
	9 Convex Faceted Mullion	H2 11.01
	10 Concave Faceted Mullion	H2 22.01, H2 23.01

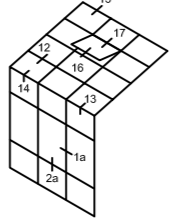
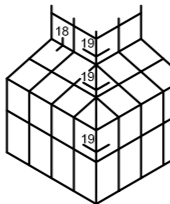
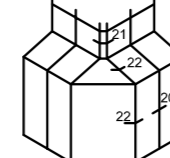
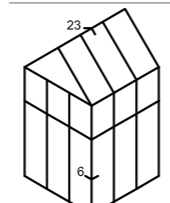
Elevation	Title	Website cad ref no.
	1a Intermediate Mullion	H2 02.01
	2a Intermediate Transom	H2 03.01
	12 Intermediate Purlin	H2 04.01
	13 Eaves (slope - vertical)	H2 06.01, H2 07.01
	14 Eaves Gutter	H2 19.01
	15 Wall Plate	H2 20.01
	16 Slope Vent (lower end)	H2 17.01
17 Slope Vent (upper end)	H2 18.01	
	18 Vertical - slope connection	H2 05.01
	19 Hip	H2 13.01
	20 Intermediate Mullion Corner	H2 14.01
	21 Corner	H2 15.01
	22 Hip / Facet	H2 16.01
	6 External Corner	H2 08.01
	23 Ridge	H2 27.01

AA®100 50mm and AA®110 65mm Mullion Drained Façade and Roof

Full details can be downloaded from our website www.kawneer.co.uk

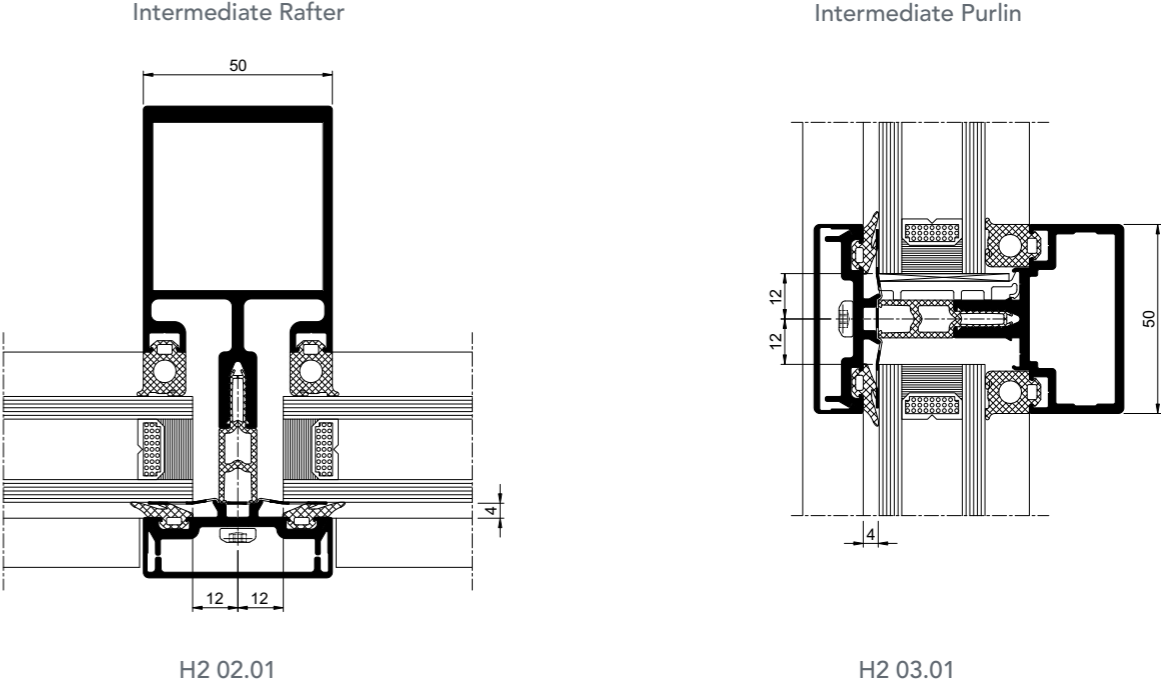

AA®100 50mm and AA®110 65mm Mullion Drained Façade and Roof

Full details can be downloaded from our website www.kawneer.co.uk

Purlin

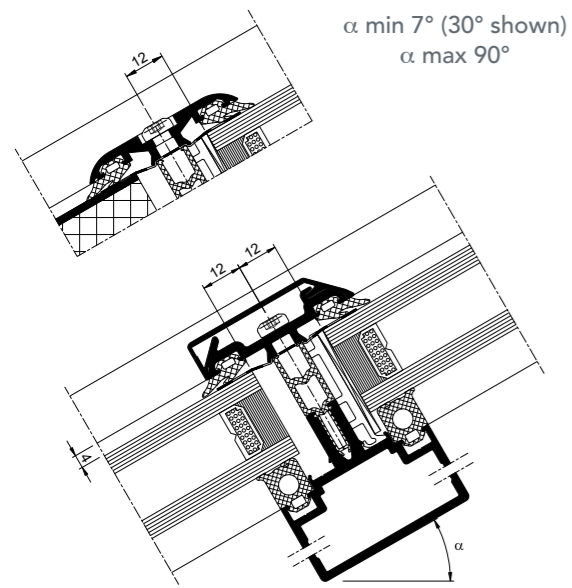

α min = 15°

H2 04.01

Slope/Vertical Connection

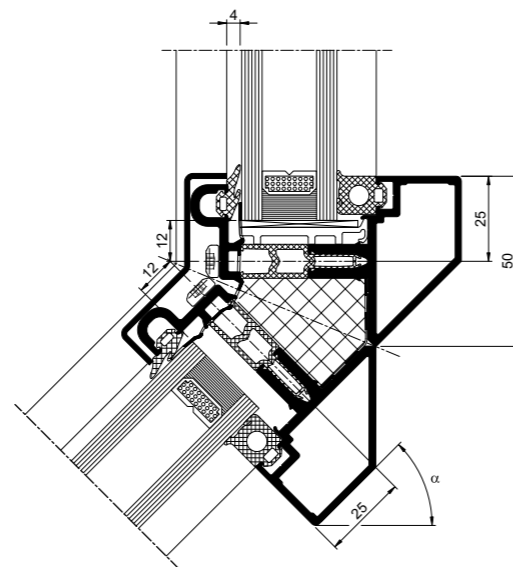

α min = 40° thermal break 16mm
 α min = 45° thermal break 20mm
 α min = 50° thermal break 26mm
 α min = 55° thermal break 36mm
 α max = 90°

H2 05.01

AA®100 50mm and AA®110 65mm Mullion Drained Façade and Roof

Full details can be downloaded from our website www.kawneer.co.uk

Eaves Detail (7° to 90° Pitch)

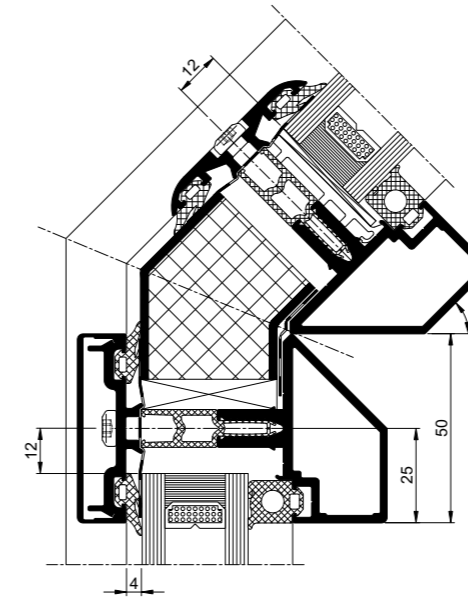

α min = 7°
 α max = 90°

H2 07.01

Eaves Detail (15° to 90° Pitch)

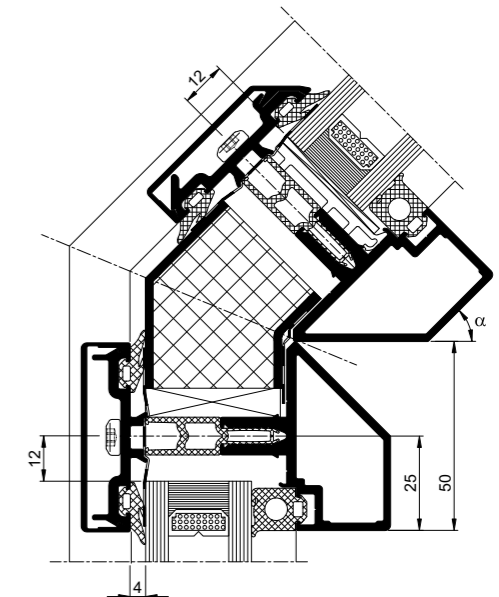

α min = 15°
 (45° shown)
 α max = 90°

H2 06.01

AA®100 50mm and AA®110 65mm Mullion Drained Façade and Roof

Full details can be downloaded from our website www.kawneer.co.uk

Apex (Generic)

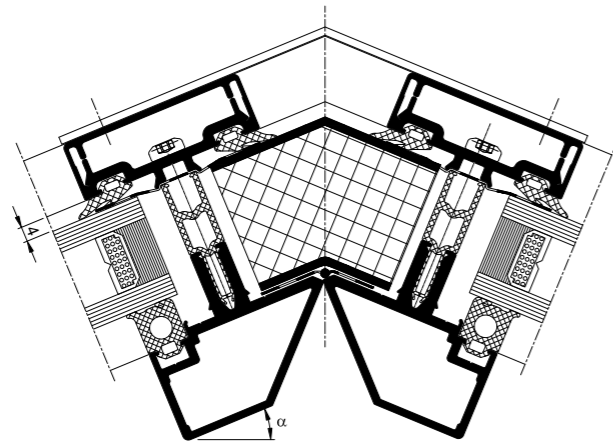

α min = 5°
 α max = 45°

H2 27.01

British Gas at Oxford Business Park
Architect: Frank Shaw Associates
Photo: Martin Cleveland Photography



London Designer Outlet, Wembley, North London
Architect: Leslie Jones Architects
Photo: London Designer Outlet

AA®100 50mm and AA®110 65mm Mullion Drained Façade and Roof

Full details can be downloaded from our website www.kawneer.co.uk

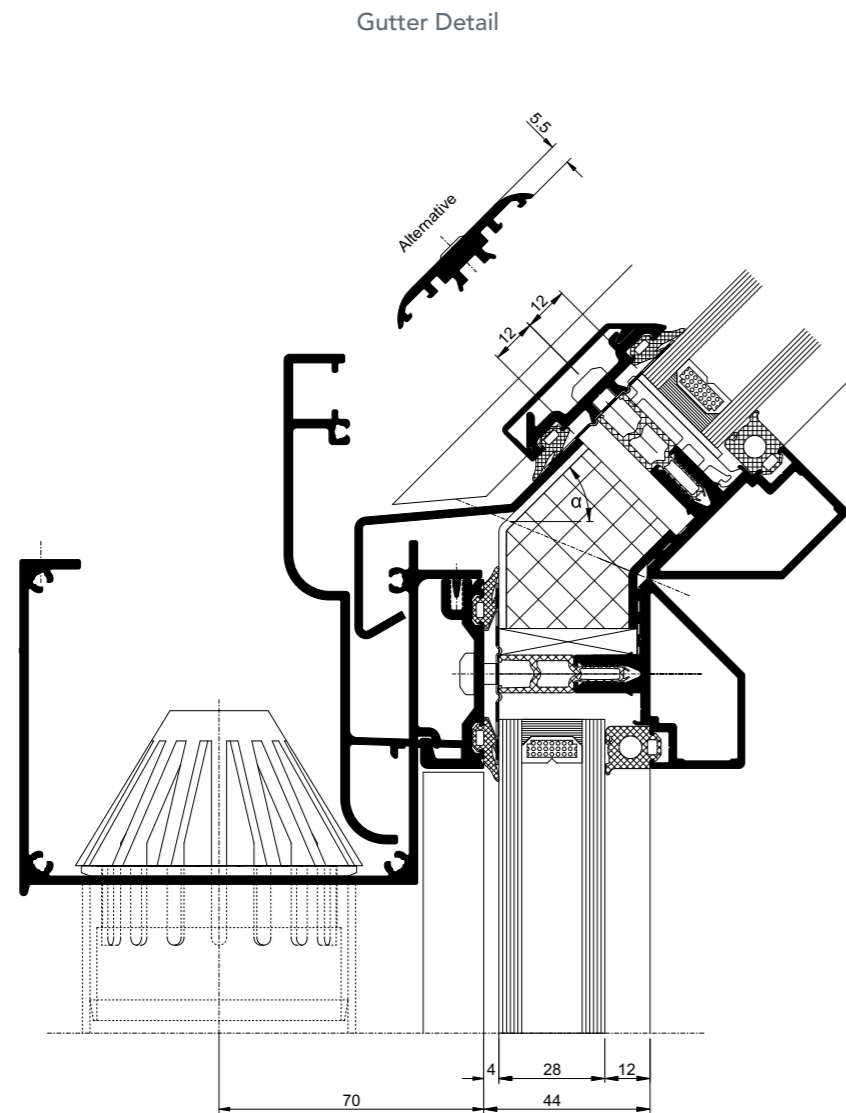

α min 7° -172 158
 α min 15° -127 818
 α max 45°

H2 19.01

AA®100 50mm and AA®110 65mm Mullion Drained Façade and Roof

Full details can be downloaded from our website www.kawneer.co.uk

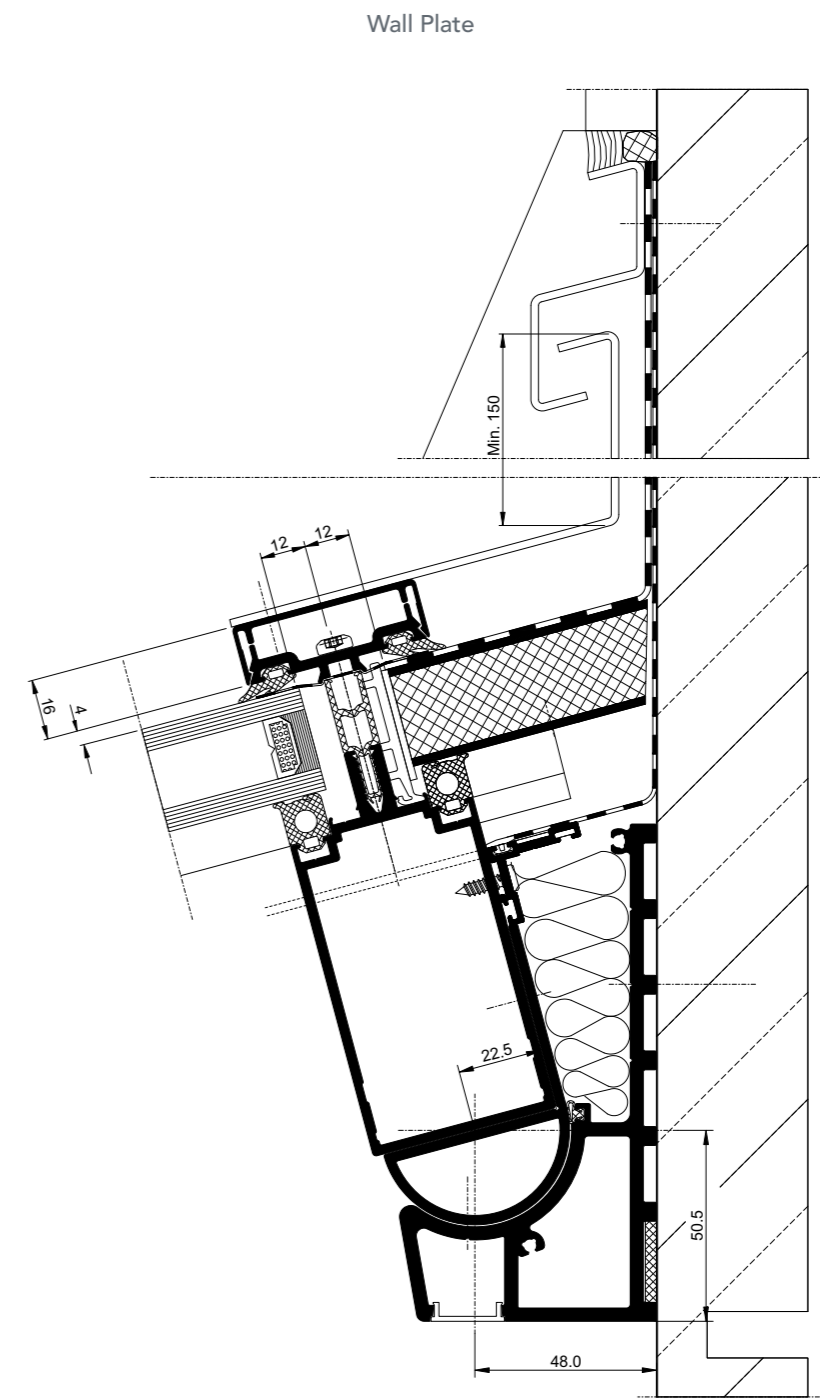

α min 7°
 α max 45°

H2 20.01

Windows and Doors into Curtain Walling

Introduction

Ventilation through curtain walling facades can be achieved with the introduction of opening windows into the screens' design. All window options from the AA®720, AA®540 and AA®3610 systems include perimeter adaptors enabling them to be simply glazed into the curtain wall.

Additionally, the AA®100 CV 'Concealed Vent' is designed specifically for the AA®100 curtain walling system. Utilising a structurally bonded double glazed unit, it allows the windows to be installed into the façade with no obvious external indication of their location.

The AA®100 and AA®110 systems can also offer a purpose designed window for slope glazing installations. As well as natural ventilation this vent can be used for smoke ventilation and has been tested to BS EN 12101-2.

Through the incorporation of perimeter adaptors, it is also possible to install doors from the AA®720 range and the AA®545 door directly into the curtain walling façade. Adaptors are also available for installing the AA®190 TB heavy/severe door into curtain walling.

Design Considerations

The Kawneer window range offers a ventilation solution to satisfy all project requirements.

When considering the type of window to install it is necessary to consider the following points:

- Height and width size limits are different for each window type
- Required free air area for each window
- Thermal performance

Product Features and Benefits

- Inward opening and outward opening window inserts available
- Vertical sliding window inserts for optimum ventilation configuration
- Automation of windows is possible
- AA®720 windows offer frames with a range of thermal performance
- All windows are weather tested to BS 6375
- AA®720 Tiltturn tested to CWCT standard
- AA®100 Slope Vent tested to BS EN 12101-2 for smoke ventilation
- Full range of door locking and function options

Windows and Doors into Curtain Walling Applications

Typical Elevations

Full details can be downloaded from our website www.kawneer.co.uk

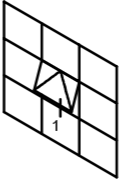
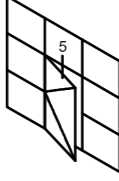
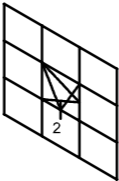
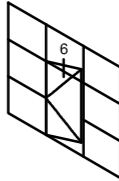
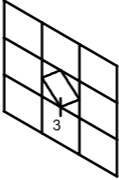
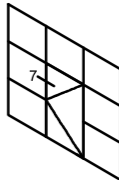
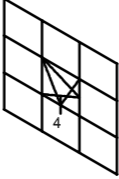
Elevation	Title	Website cad ref no.	Elevation	Title	Website cad ref no.
	1 Top Hung Vent	H3 05.01		5 Open Out Door	H3 09.01
	2 Tiltturn Vent	H3 06.01		6 Open In Door	H3 10.01
	3 Pivot Vent	H3 07.01		7 Dual Action Door	H3 11.01
	4 Integral Tiltturn Vent	H3 08.01			



Templeman Library, University of Kent
 Architect: Penoyre & Prasad
 Photo: Quintin Lake



Windows and Doors into Curtain Walling

Full details can be downloaded from our website www.kawneer.co.uk

AA®100 including an
AA®720 Casement

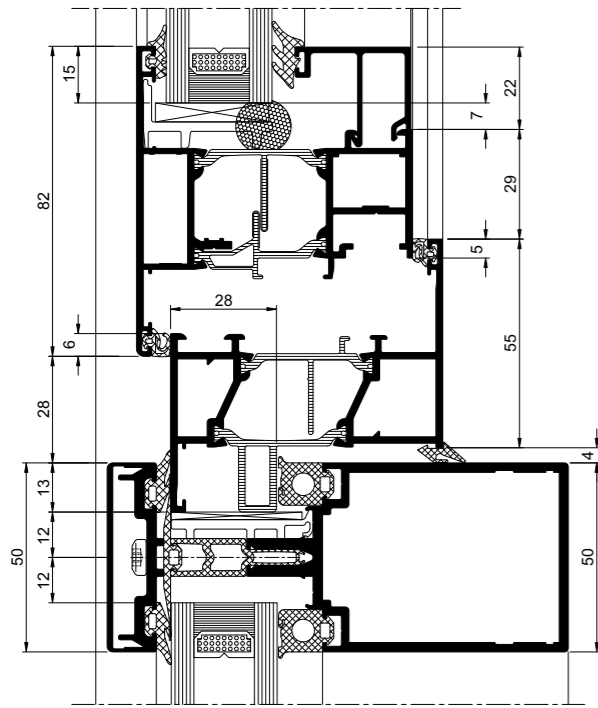

H3 05.01

AA®100 including an
AA®720 Pivot

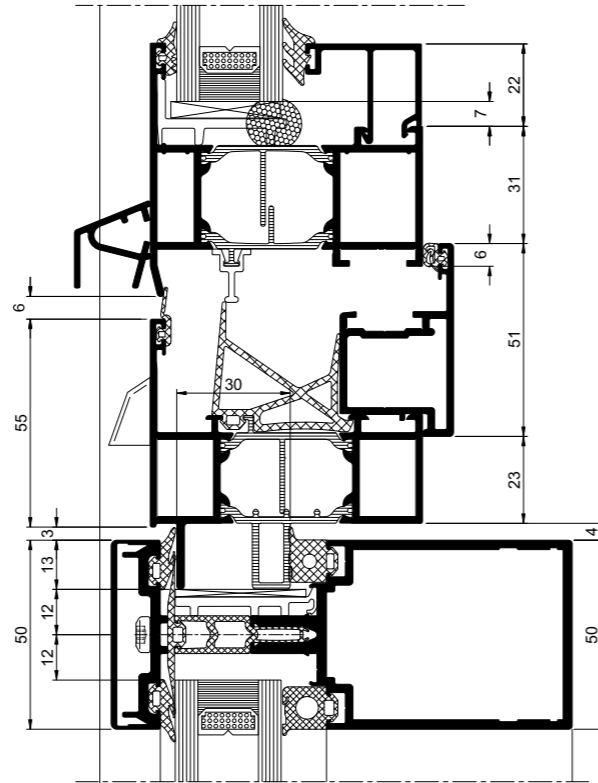

H3 07.01

Windows and Doors into Curtain Walling

Full details can be downloaded from our website www.kawneer.co.uk

AA®100 including an
AA®720 Tiltturn

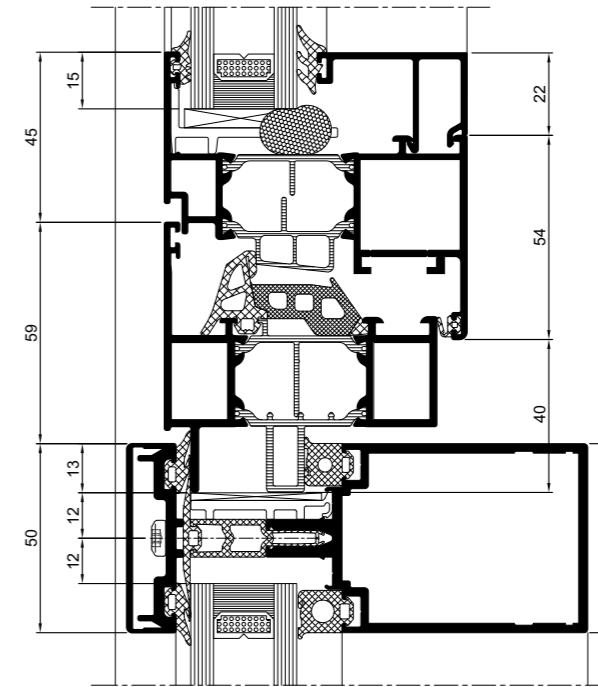

H3 06.01



Windows and Doors into Curtain Walling

Full details can be downloaded from our website www.kawneer.co.uk

AA®100 including an
Inward Opening AA®720 Door

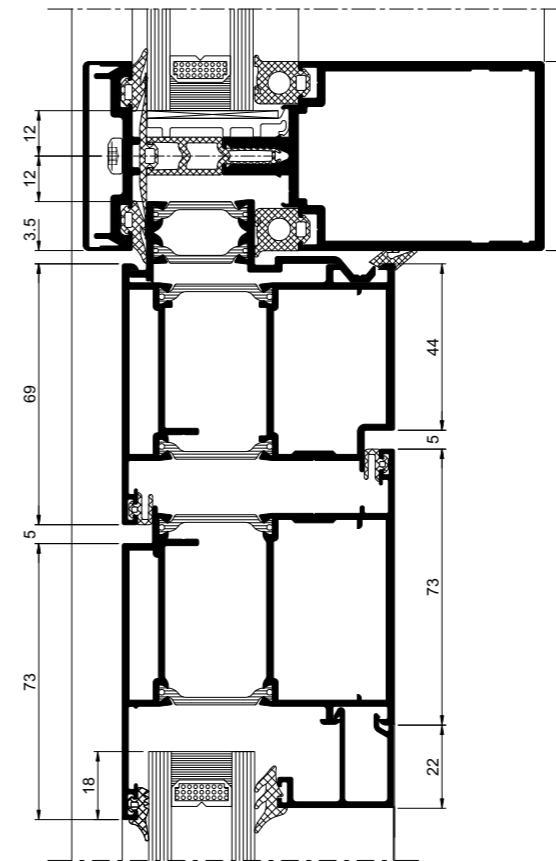

H3 10.01

AA®100 including an
Outward Opening AA®720 Door

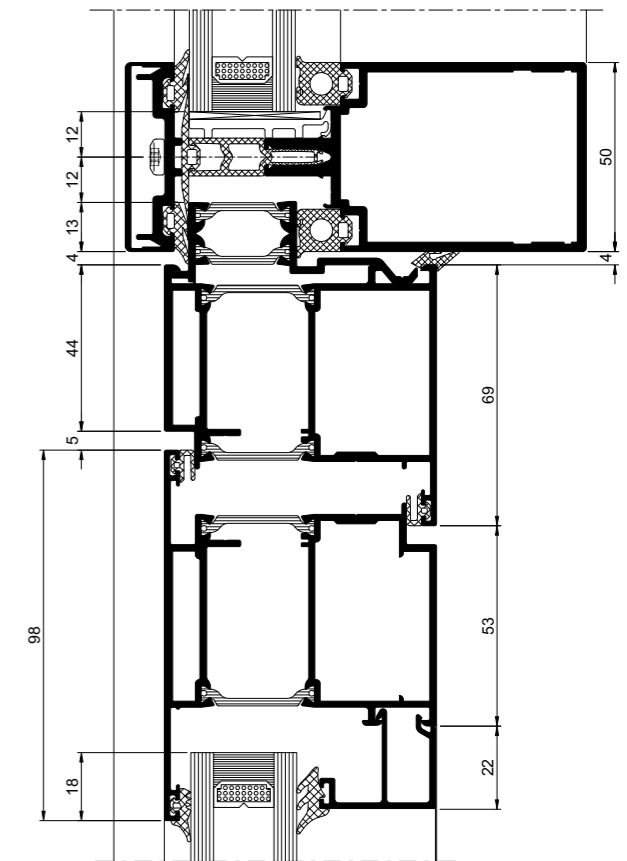

H3 09.01

AA®100 and AA®110 Concealed Vent (CV)

Introduction

The new AA®100 and AA®110 Concealed Vent is designed to suite with the AA®100 and AA®110 systems in either capped or SSG variants. The Concealed Vent provides architectural flexibility and freedom to maintain flush seamless visuals externally, with no visible aluminium framing, whilst providing occupancy comfort where ventilation requirements are a key driver.

The Concealed Vent is now available as a top hung vent or as a parallel opening window. Both window types have the option to be manually operated or motorised. As part of our system development, the Concealed Vent underwent full CWCT Sequence B testing as part of a larger curtain wall assembly, so carries proven weather performance.

With a fresh design, and enhanced features, the system can now carry glazing up to 50mm in the capped system. Motorised operation of the vents is now also possible using chain drives and integrated locking drives, which can now also be neatly concealed giving a seamless internal finish with concealed hardware.

As a system designed for integration into our curtain wall system, the window has been security tested to EN 1627 to RC2, therefore carrying the same security classification as our AA®100 and AA®110 curtain wall systems.

Product Features and Benefits

- Suites with AA®100 and AA®110 systems in either capped or SSG variants
- Top Hung or Parallel Opening Vent (POV) options
- Glazing up to 50mm
- Manual or motorised operation with concealed hardware option
- RC2 Security tested to EN 1627
- Thermal performance to meet current Building Regulations
- Tested and certified in accordance with CWCT Sequence B and relevant UK/EN Standards
- Silicone Bonded Vent*
- Top Hung option on Friction stay maximum size 2400mm(W) or 2500mm(H)
- Parallel Opening stays for maximum size 2000mm(W) or 3000mm(H)
- Maximum weight 180kg

* Contact our Technical Services Department for further information.



AA®100 and AA®110 Concealed Vent Open Out

Full details can be downloaded from our website www.kawneer.co.uk

Head Detail

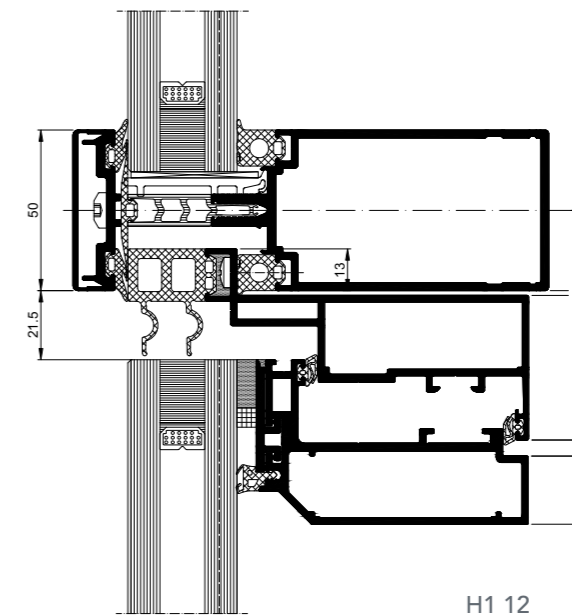

Cill Detail

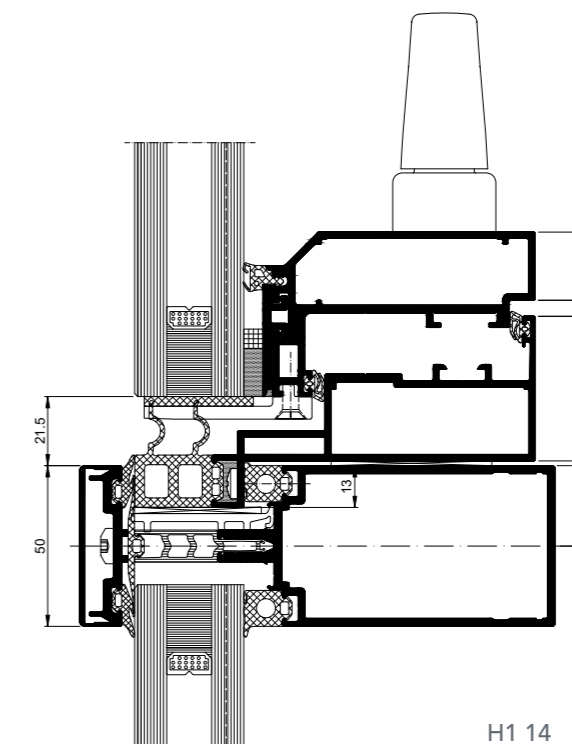

AA®100 and AA®110 Concealed Vent Open Out

Full details can be downloaded from our website www.kawneer.co.uk

Jamb Detail – Zone Drained

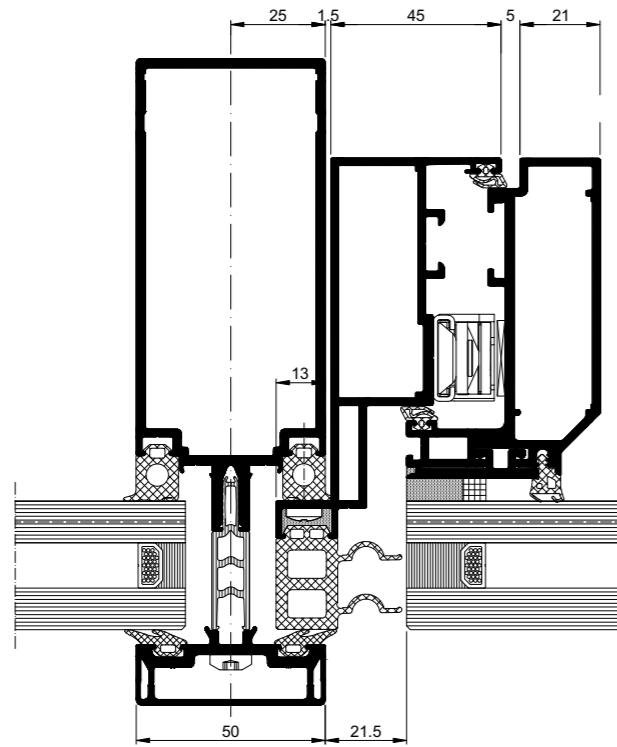

H1 6

AA®100 and AA®110 Sloped Vent Details

Full details can be downloaded from our website www.kawneer.co.uk

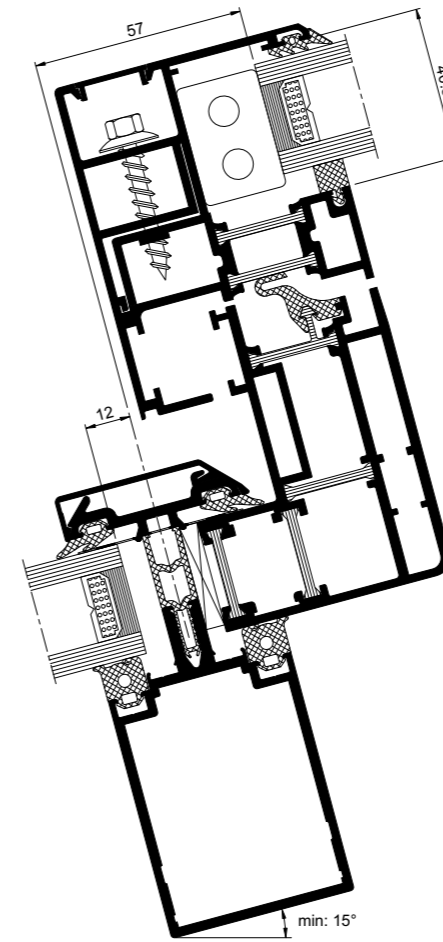

H2 17.01

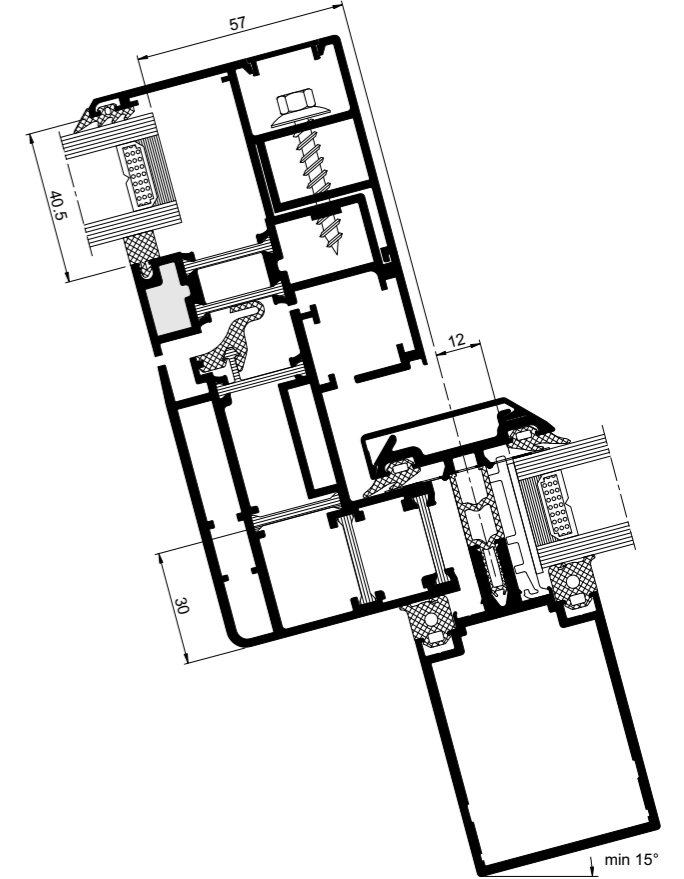

H2 18.01

AA®100/AA®110

Max glass area	2.15m ²	Min height	600mm
Max height	1800mm	Min width	500mm
Max width	1500mm	Max glass thickness	34mm (units)
Min glass thickness	16mm (units)	Min roof angle	15°

AA®100 and AA®110 Horizontally Capped (HC) and AA®100 and AA®110 Vertically Capped (VC) Gasket System

Introduction

The AA®100 and AA®110 HC/VC options provide the specifier with an alternative to traditional (SSG) Structurally glazed silicone joints.

The low profile EPDM gasket system enables specifiers to maintain the look of a structurally glazed system whilst maintaining the benefits of a capped system.

On an AA®100/AA®110 HC façade the vertical glazing joints are secured and sealed with a discreet pressure plate and EPDM cover gasket. The horizontal face caps run continuously across the glazing and are enhanced by the unobtrusive vertical gasket system.

On an AA®100/AA®110 VC façade utilises the same principle but with the EPDM gasket in a horizontal application between vertical caps.

In addition, we are also able to offer a wide variety of face caps to accentuate the visual look of the building facade, giving the building its own individual signature.

The system has been exclusively designed, developed and supplied by Kawneer in conjunction with our approved Dealer network.

Product Features and Benefits

- Cost effective alternative to traditional SSG structurally glazed silicone joints
- Retains all of the full range of AA®100 and AA®110 mullions and transoms
- Large range of face caps available to compliment the discreet EPDM gasket
- Improved installation speeds compared to traditional SSG
- Ease of glass replacement due to pressure plate / gasket arrangement
- Maximum glazing up to 50mm
- Maximum infill weight 600kg
- Market leading product tested and certified to CWCT Sequence B

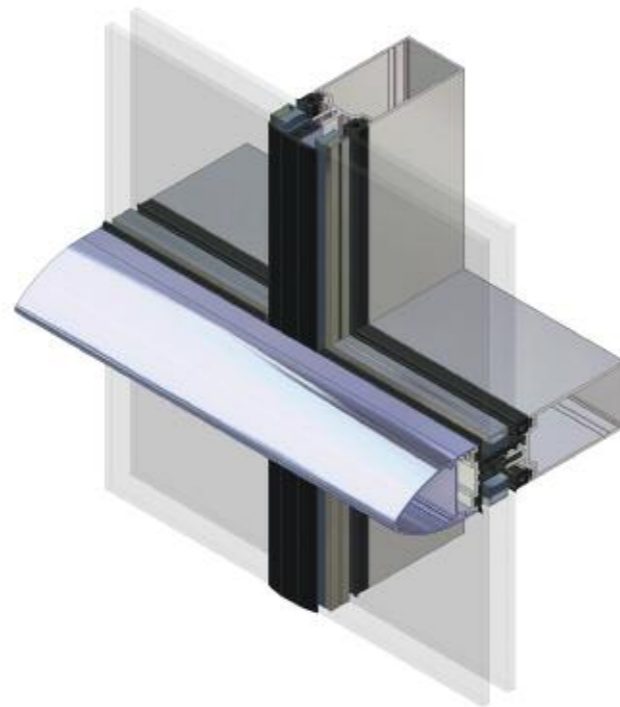

AA®100 50mm Horizontal Cap (HC)

AA®100 Horizontally Capped (HC) Applications

Typical Elevations

Full details can be downloaded from our website www.kawneer.co.uk

Elevation	Title	Website cad ref no.	
	1	Head Detail (generic)	H4 02.01
	2	Intermediate Transom	H4 03.01
	3	Cill Detail (generic)	H4 04.01
	4	Jamb Detail (generic)	H4 05.01, H4 06.01
	5	Intermediate Mullion	H4 07.01



AA®100 Horizontally Capped (HC)

Full details can be downloaded from our website www.kawneer.co.uk

Head Detail (Generic)

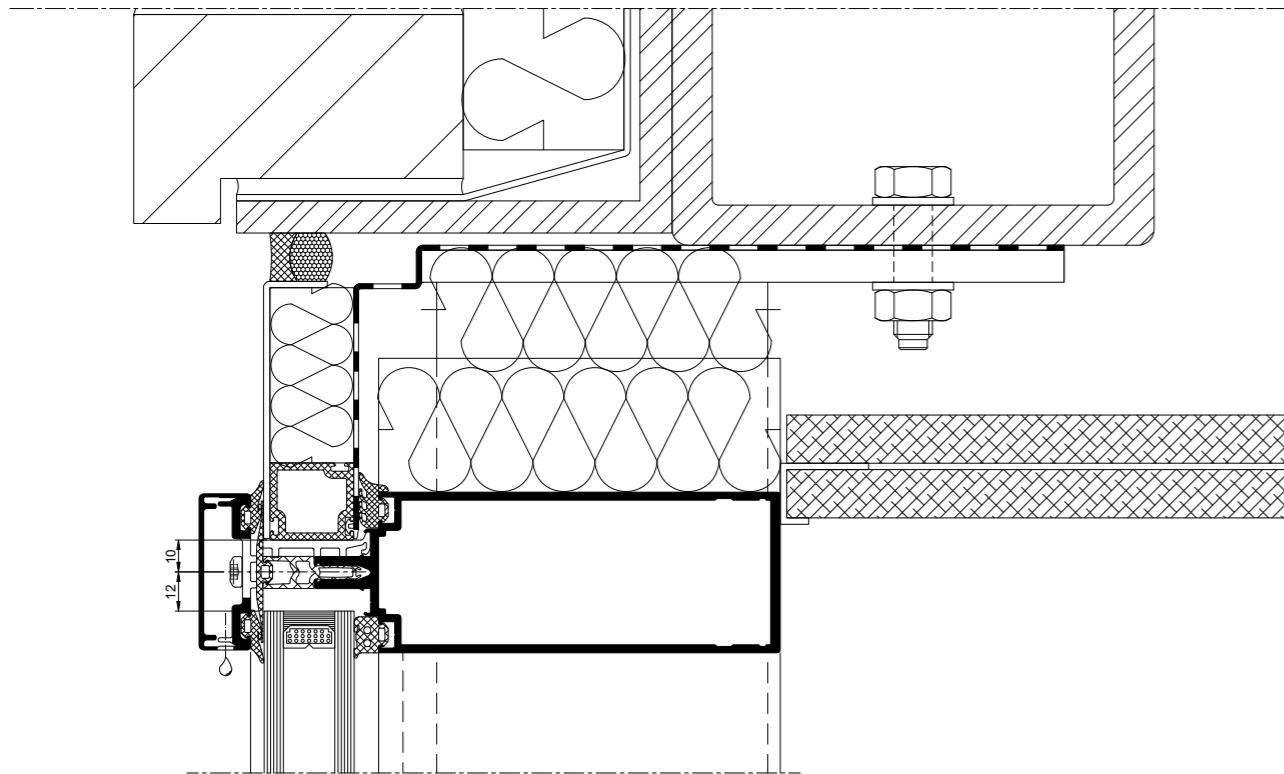

H4 02.01

AA®100 Horizontally Capped (HC)

Full details can be downloaded from our website www.kawneer.co.uk

Transom Detail

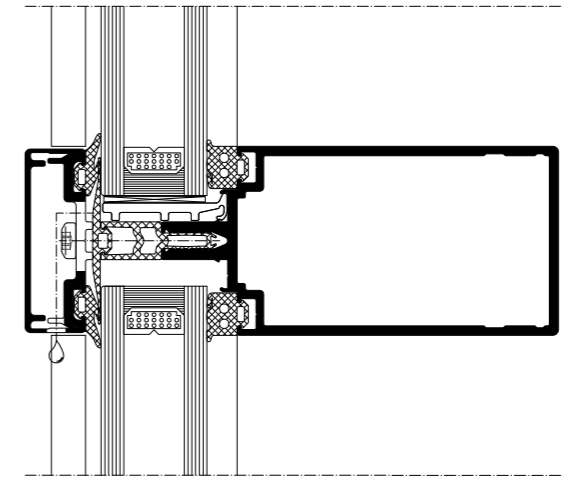

H4 03.01



AA®100 Horizontally Capped (HC)

Full details can be downloaded from our website www.kawneer.co.uk

Cill Detail (Generic)

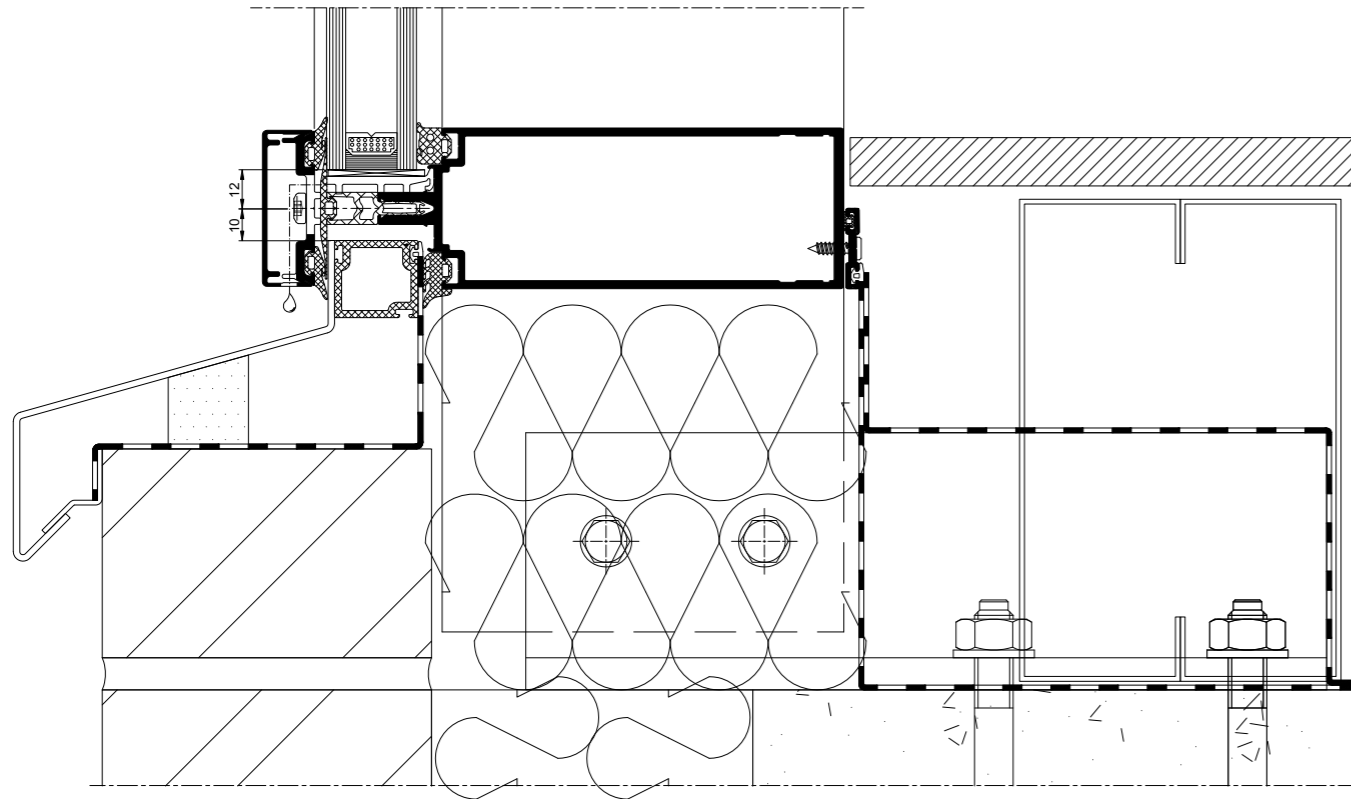

H4 04.01

AA®100 Horizontally Capped (HC)

Full details can be downloaded from our website www.kawneer.co.uk

Jamb Detail (Generic)

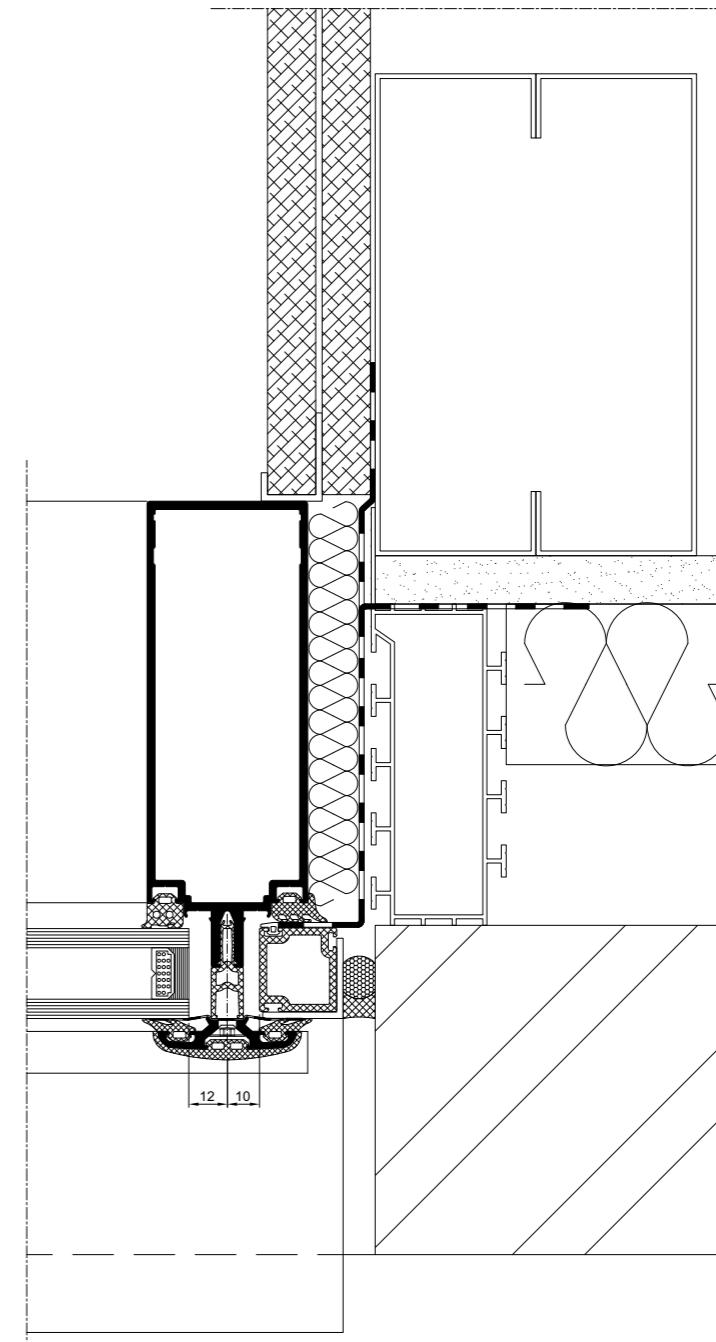

H4 05.01

AA®100 Horizontally Capped (HC)

Full details can be downloaded from our website www.kawneer.co.uk

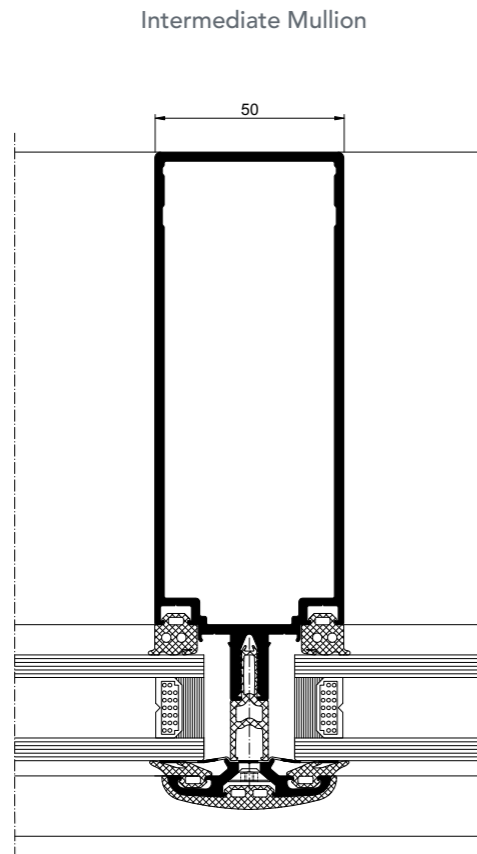

H4 07.01



AA®100 Vertically Capped (VC) Applications

Typical Elevations

Full details can be downloaded from our website www.kawneer.co.uk

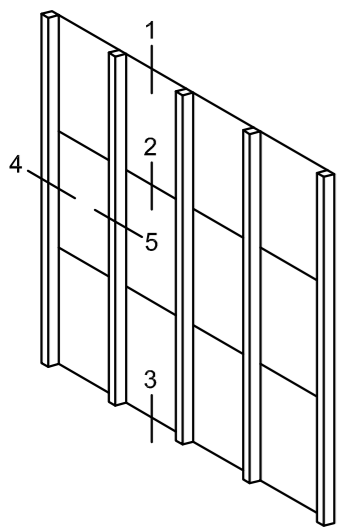
Elevation	Title	Website cad ref no.
	1 Head Detail (generic)	H4 10.01, H4 11.01
	2 Intermediate Transom	H4 12.01
	3 Cill Detail (generic)	H4 13.01, H4 14.01
	4 Jamb Detail (generic)	H4 15.01, H4 16.01
	5 Intermediate Mullion	H4 17.01, H4 18.01

John Roan School, London
 Architect: John McAslan + Partners
 Photo: John McAslan + Partners / Hufton+Crow



AA®100 Vertically Capped (VC)

Full details can be downloaded from our website www.kawneer.co.uk

Head Detail (Generic)

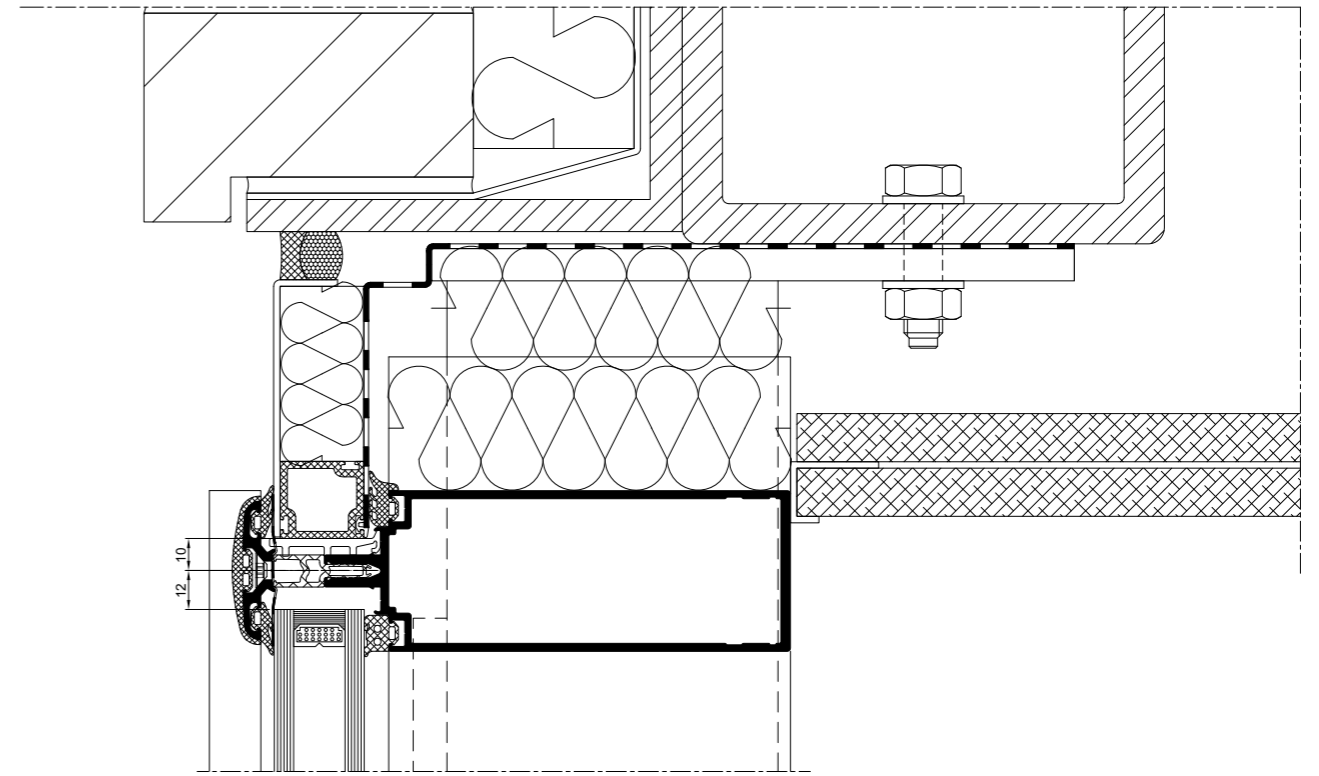

H4 10.01

AA®100 Vertically Capped (VC)

Full details can be downloaded from our website www.kawneer.co.uk

Transom Detail

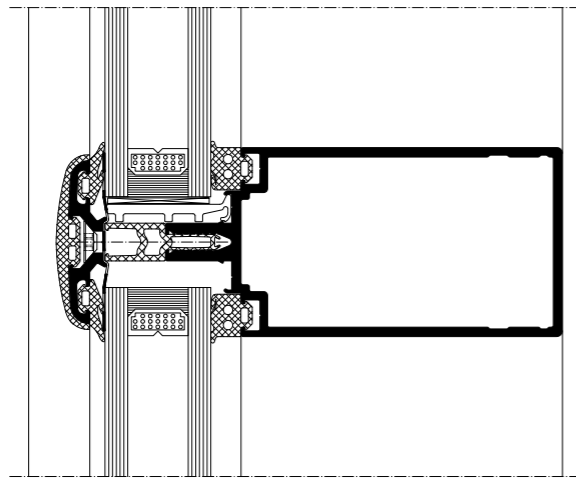

H4 12.01



AA®100 Vertically Capped (VC)

Full details can be downloaded from our website www.kawneer.co.uk

Cill Detail (Generic)

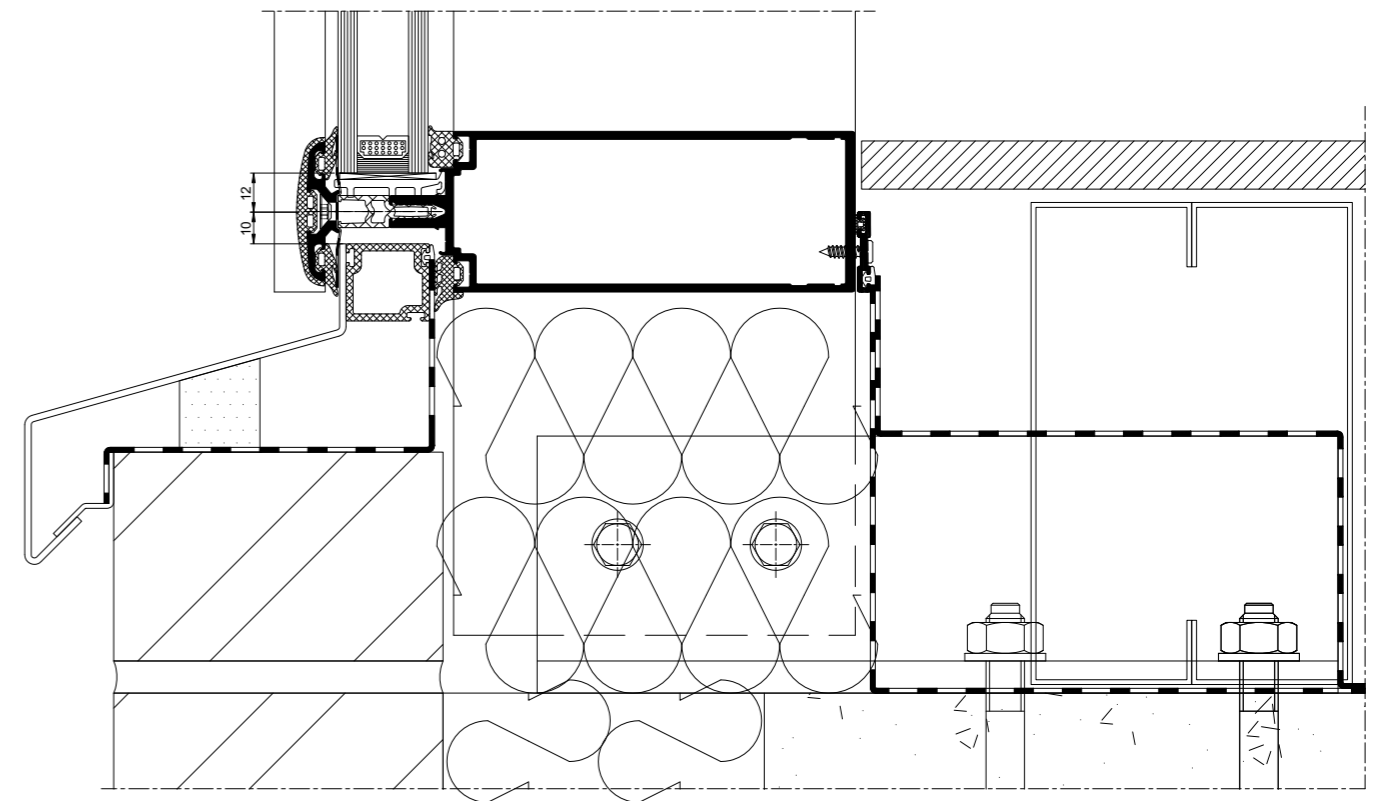

H4 13.01

AA®100 Vertically Capped (VC)

Full details can be downloaded from our website www.kawneer.co.uk

Jamb Detail (Generic)

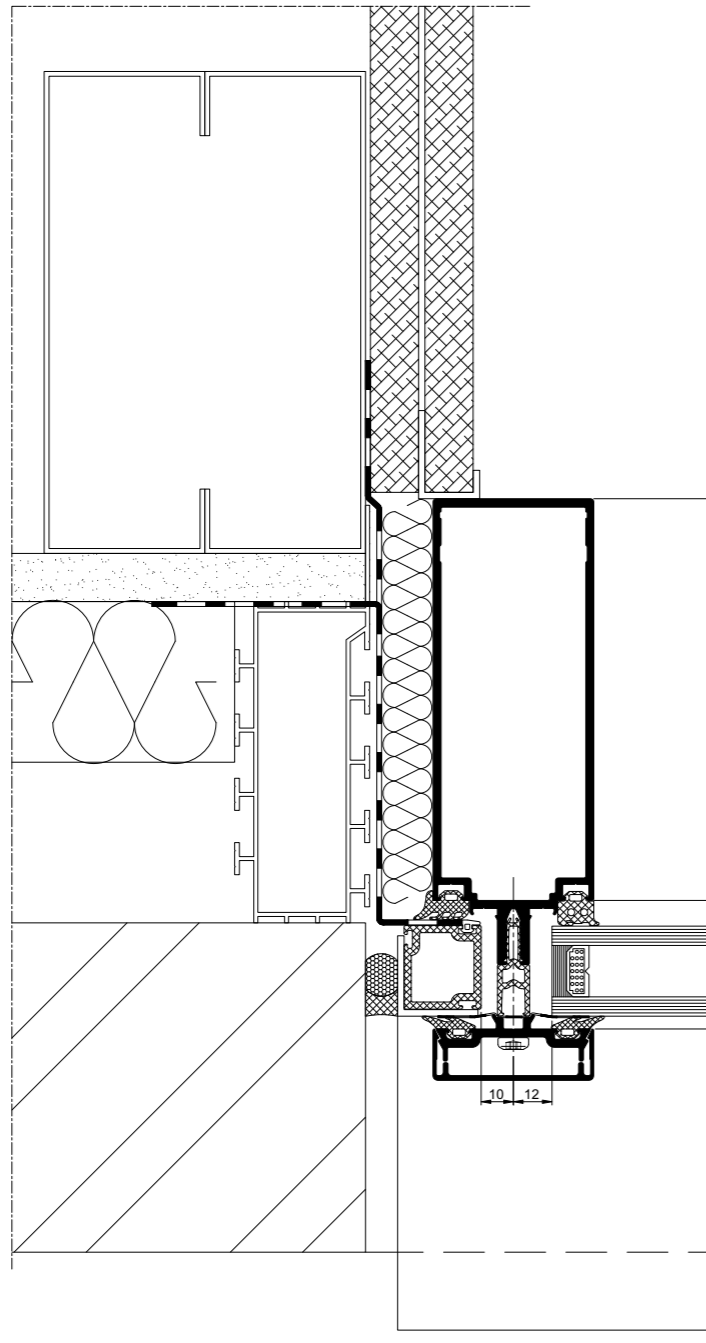

H4 15.01

AA®100 Vertically Capped (VC)

Full details can be downloaded from our website www.kawneer.co.uk

Intermediate Mullion

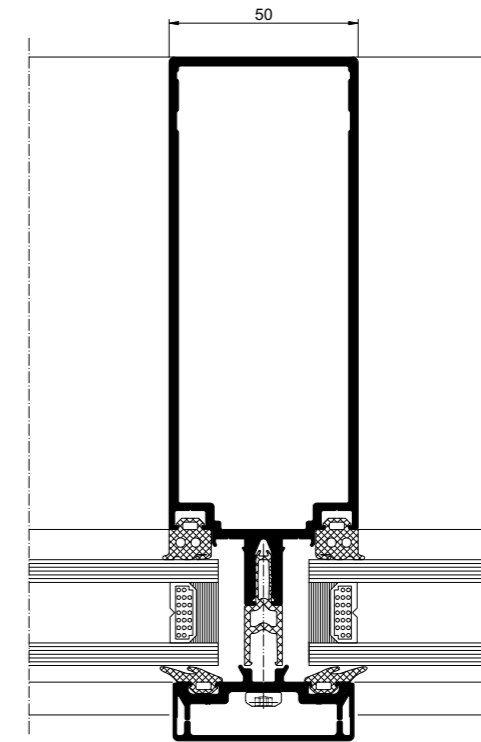

H4 17.01

AA[®]100 and AA[®]110 Structurally Silicone Glazed (SSG)

Introduction

The AA[®]100 and AA[®]110 SSG is a variant of our flagship AA[®]100 and AA[®]110 curtain wall systems, which allows glazing of the curtain walling to be achieved without the use of conventional pressure plate and face caps, giving an aesthetically pleasing appearance with flush glazing to the exterior.

The grid construction replicates the AA[®]100 and AA[®]110 mullion drained system, so carries the same ease of installation. The flush external appearance is provided by specially manufactured insulated glazing units constructed with the use of structural silicone sealant and contain an integrated channel profile around the perimeter of the glazing cavity. Toggle clips positioned on the mullions and transoms locate into the channel profile to provide the mechanical retention to secure the pane to the curtain wall. The glazing unit is deadload supported by the transom using a combination of setting blocks and glass supports, additionally the final aesthetics of the façade is enhanced by use of a flush seal between the glass units by means of a UV resistant weatherproofing silicone sealant.

In a further development available only in the AA[®]110 SSG system, we have recently introduced an enhanced movement joint, providing +/- 5mm of vertical movement. This will provide market leading movement capabilities whilst maintaining the flush silicone glazed external appearance.

Architects and specifiers can now benefit from increased design flexibility where typically modern construction methods would rule out the use of a typical SSG system*.

Product Features and Benefits

- Dry jointing method using specially designed EPDM moulding
- Mullion drainage
- Glazing from 26mm to 37mm for increased design flexibility
- Thermal performance can meet current Building Regulations
- Tested and certified in accordance with CWCT Sequence B
- Maximised structural capability and design with a range of mullions and transoms
- Integration with both AA[®]100 and AA[®]110 curtain wall systems
- Glazing retained using a toggle system
- Silicone sealed glass to glass joint
- Maximum screen height of 16m in AA[®]100 SSG
- +/- 5mm movement joint available in AA[®]110 SSG variant, with enhanced toggle and glazing options*

* Contact our Technical Services Department for further information.



AA[®]100 SSG



AA[®]110 SSG Large Movement Joint



Increased Building Movement Allowance

Introduction

Glazing and cladding systems need to be designed to allow for building movement without compromising the performance or safety of the system.

The consequences of failing to provide sufficient allowance for in-service building movement can range from a reduction in weather performance to glass breakage and significant system failure.

One of the main complexities in designing a façade is the accommodation of slab movement/deflection.

Due to the extension of structural spans seen in today's building designs, slab deflection is increasing. This places additional demands on the façade design team to accommodate movement between slab and façade.



When building designs require facades to withstand high slab deflections one solution is to incorporate unitised curtain wall systems which, due to their construction, can provide greater movement allowance. However, unitised curtain walling is most appropriate for large facades and are generally only undertaken by specialist fabricators and installers.

Conventional stick curtain walling is widely specified in the UK and offers a cost-effective façade solution particularly on buildings which do not have a requirement for significant movement allowance.

AA[®]110 SSG Enhanced Movement Joint

Page 11 details our AA[®]110 capped system which has been developed to accommodate up to +/- 15mm differential vertical movement between the façade and the supporting sub-structure.

This development was designed for use in a traditional capped system, where principally increased movement is accommodated through a combination of the space within the system glazing cavity and through the design of a unique expansion joint for connecting vertical mullions.

SSG systems differ slightly in their glazing retention methodology, so movement limits are defined by relevant standards, so the engagement limits of the toggle within the channel are often the limiting factor. Naturally, movement capabilities are reduced when comparing to the AA[®]110 capped variant. The AA[®]110 SSG enhanced movement joint utilises similar technology to our capped movement joint, using the engineered expanding foam seals, in conjunction with a deeper toggle channel and extended toggle profile. This allows increased vertical movement capabilities of +/- 5mm whilst maintaining the required toggle engagement.



CWCT Dynamic Test

The system has undergone rigorous testing during its development to ensure performance in all UK conditions. Working closely with the CWCT an enhanced version of the Standard for Systemised Building Envelope: Sequence B test program was successfully carried out. This included testing while the expansion joint was in compression, extension and in the neutral position.

Technical Support

Kawneer offers a Façade Workshop consisting of a team of specialists who work collaboratively with developers, architects and engineers during the early stages of a project. This unique design and consultancy service, working across every aspect of the façade, ensures the design intent is realised on all projects.

AA®100 Structurally Silicone Glazed (SSG) Applications

Typical Elevations

Full details can be downloaded from our website www.kawneer.co.uk

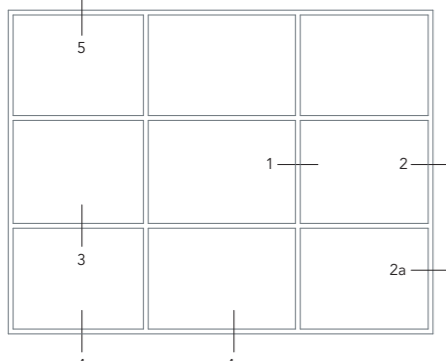
Elevation	Title	Website cad ref no.
	1 Mullion	AA®100 SSG H 02.01
	2 Jamb Interface	AA®100 SSG H 03.01
	2a Jamb Interface with Face Cap	AA®100 SSG H 04.01
	3 Transom	AA®100 SSG H 05.01
	4 Cill	AA®100 SSG H 06.01
	4a Capped Cill	AA®100 SSG H 06.01
	5 Head	AA®100 SSG H 08.01

BBC Cymru, Cardiff
 Architect: Foster + Partners
 Photo: Hannah Gasparutti/Foster + Partners



AA®100 and AA®110 Structurally Silicone Glazed (SSG)

Full details can be downloaded from our website www.kawneer.co.uk

Mullion Detail

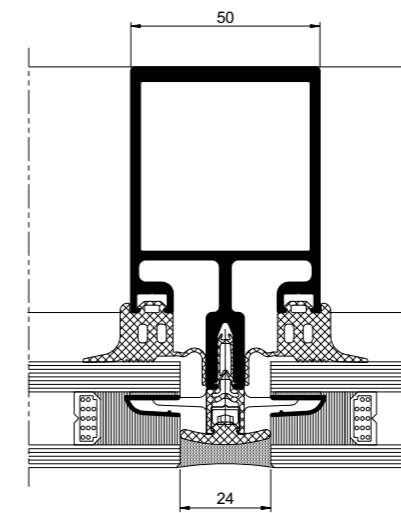

H 02.01

Jamb Interface

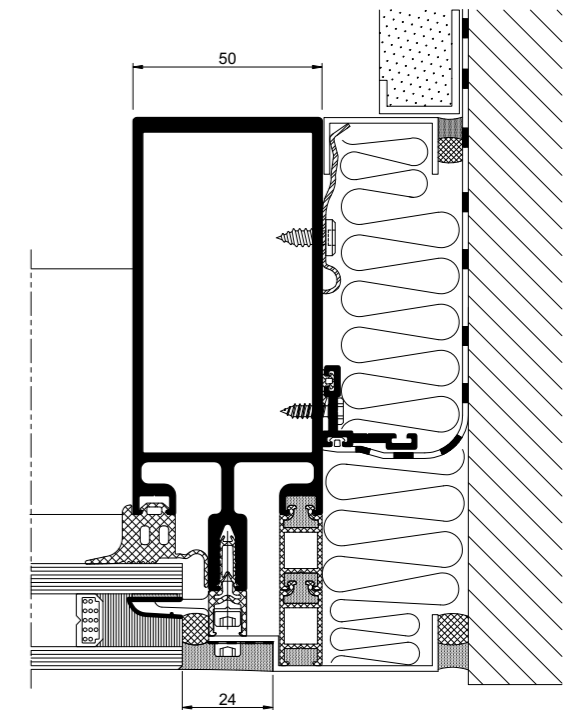

H 03.01

Transom Detail

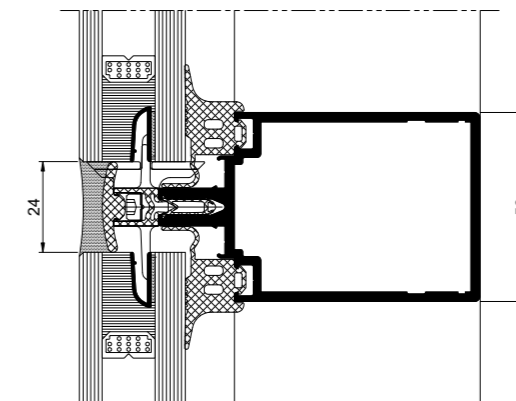

H 05.01

AA®100 Structurally Silicone Glazed (SSG)

Full details can be downloaded from our website www.kawneer.co.uk

Head Detail (Example)

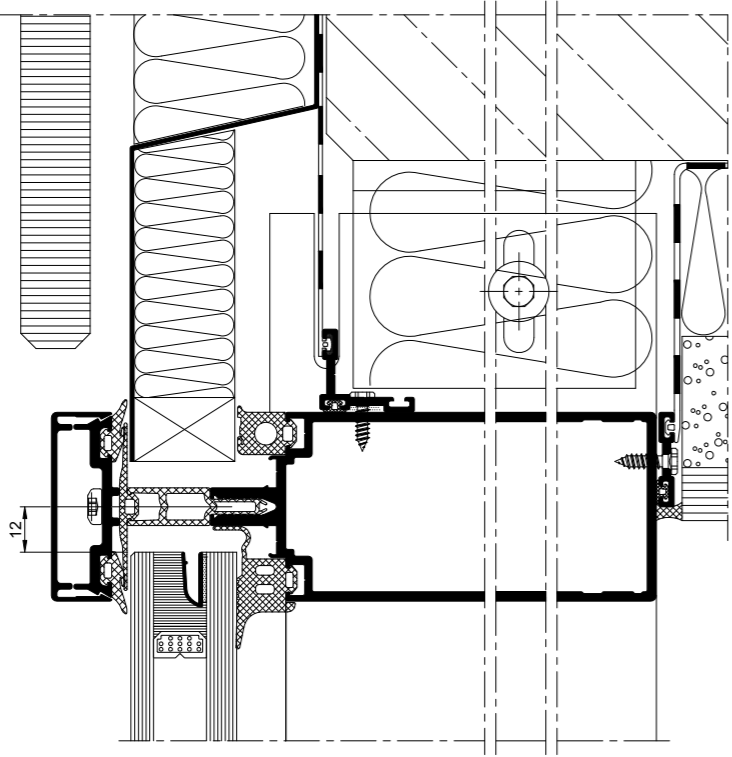

H 08.01

AA®100 Structurally Silicone Glazed (SSG)

Full details can be downloaded from our website www.kawneer.co.uk

Cill Detail

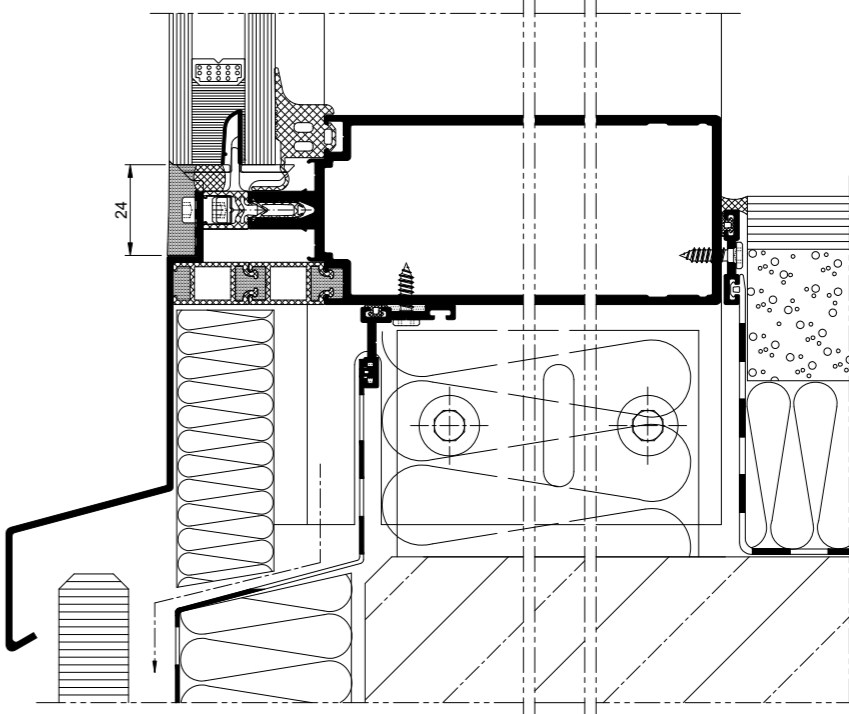

H 06.01

AA®100 and AA®110 PFL

Introduction

A curtain walling system that looks like a picture frame system but is quicker and easier to install using the traditional stick build system. The PFL system is suitable where the build characteristics of a typical semi-unitised picture frame system are not essential or possible and where installation can be achieved in one stage resulting in time reduction, a benefit for both contractors and installers.

The PFL system was developed with just three new parts to suite with the CWCT tested AA®100 50mm and AA®110 65mm dry jointed curtain walling systems.

An external pressure plate, face cap and weatherseal enables the system to provide all the robust aesthetics of a picture frame system on a proven grid, which integrates totally with the AA®100 and AA®110 existing systems.



AA®100 and AA®110 PFL

Full details can be downloaded from our website www.kawneer.co.uk

Jamb Detail (Generic)

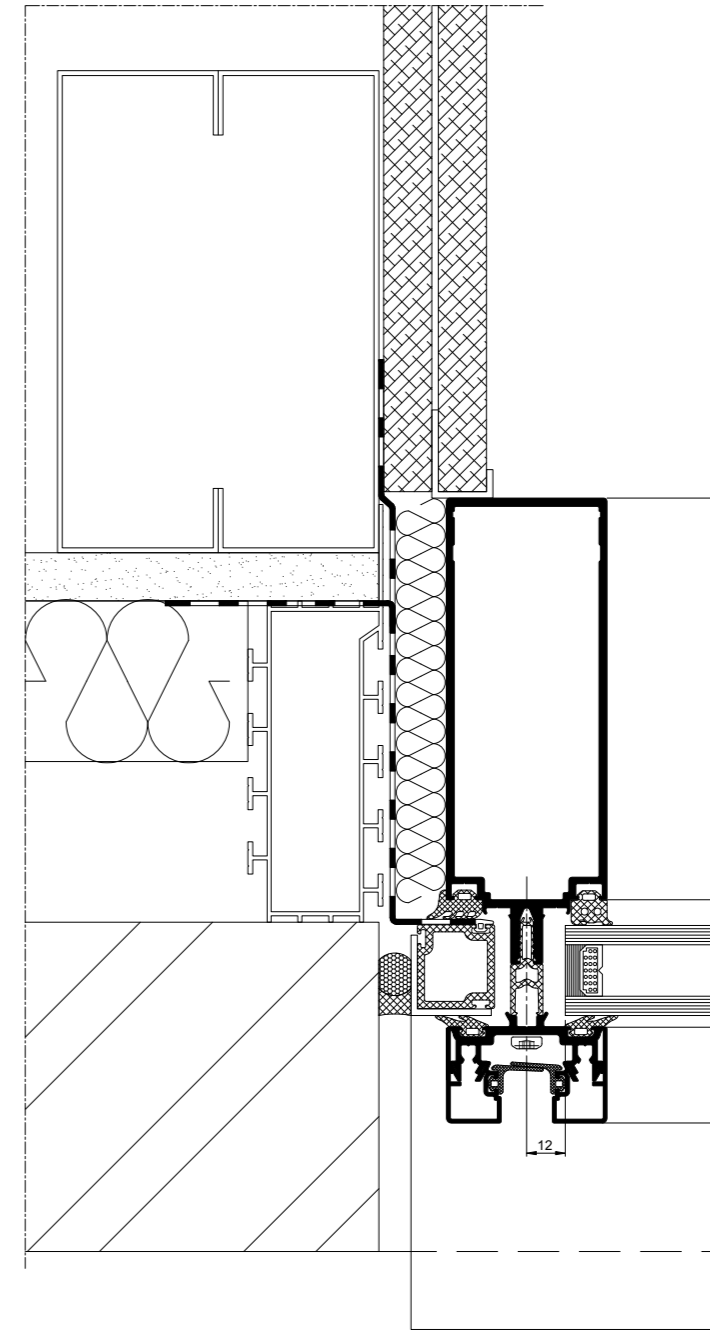

H6 02.01

AA®100 and AA®110 PFL Applications

Typical Elevations

Full details can be downloaded from our website www.kawneer.co.uk

Elevation	Title	Website cad ref no.
	1 Jamb Detail (generic)	H6 02.01
	2 Intermediate Mullion	H6 03.01
	3 Cill Detail (generic)	H6 04.01
	4 Intermediate Transom	H6 05.01
	5 Head Detail (generic)	H6 06.01

AA®100 and AA®110 PFL

Full details can be downloaded from our website www.kawneer.co.uk

Intermediate Mullion

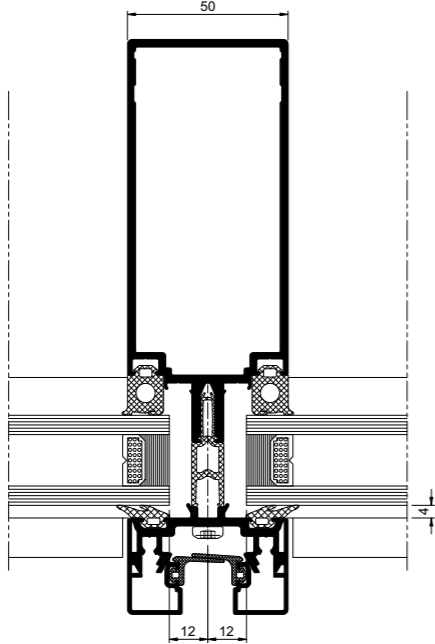

H6 03.01

AA®100 and AA®110 PFL

Full details can be downloaded from our website www.kawneer.co.uk

Intermediate Transom

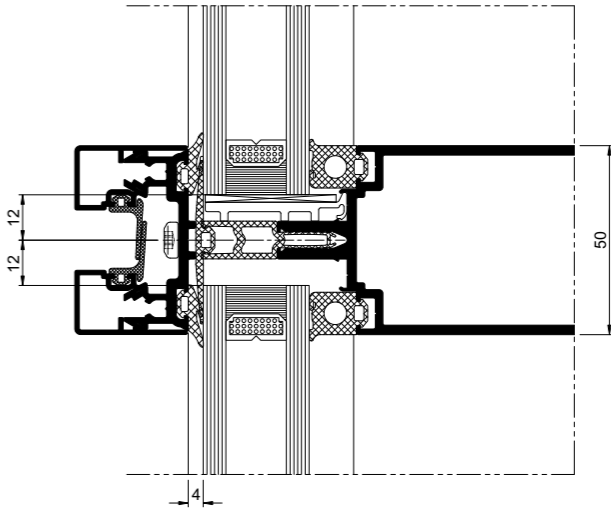

H6 05.01

AA®100 and AA®110 PFL

Full details can be downloaded from our website www.kawneer.co.uk

Head Detail (Generic)

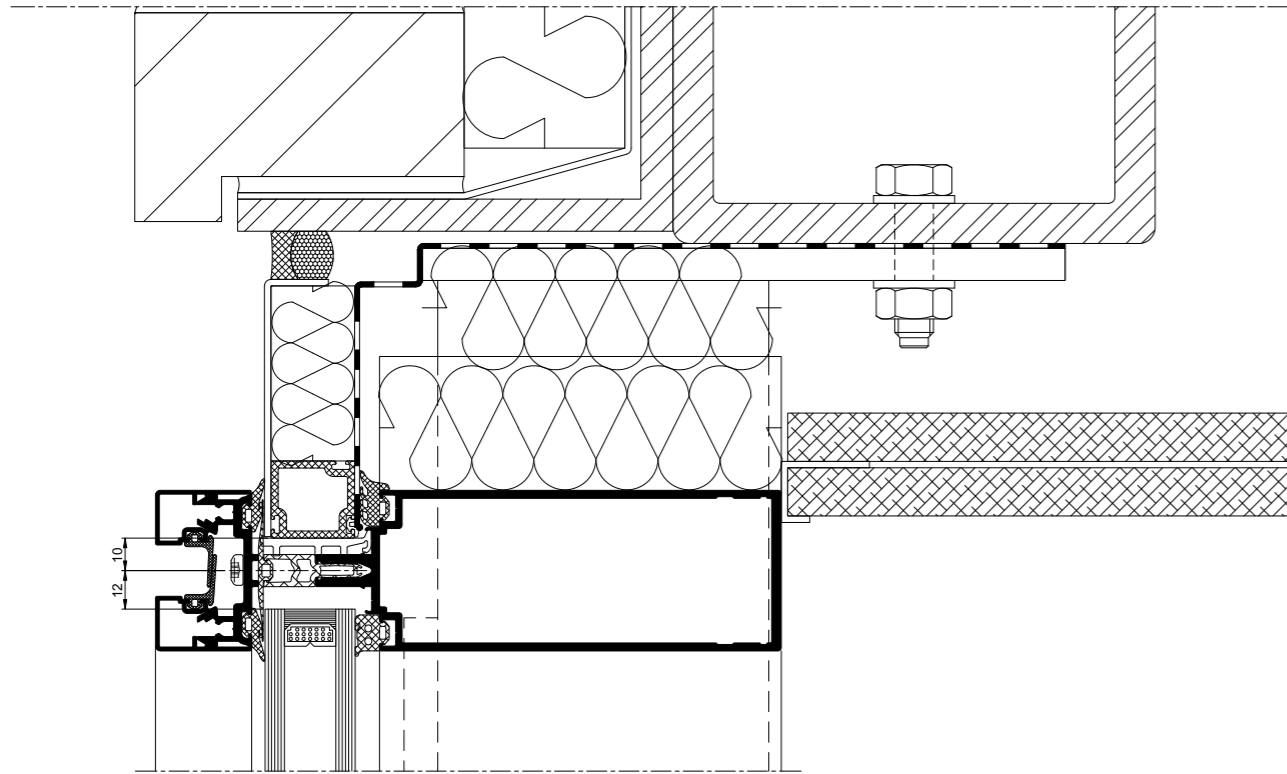

H6 06.01

AA®100 and AA®110 PFL

Full details can be downloaded from our website www.kawneer.co.uk

Cill Detail (Generic)

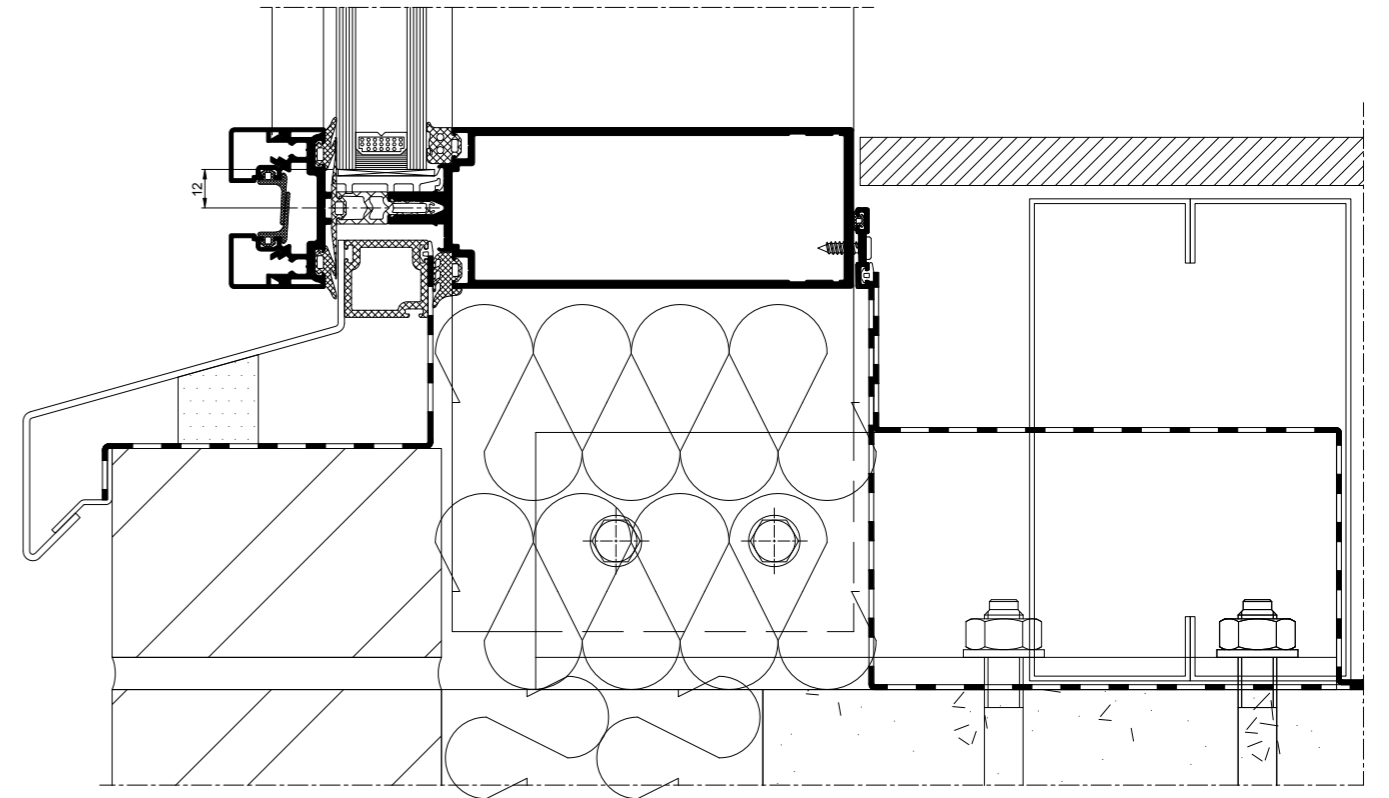

H6 04.01

Case Study - Citylabs 2.0, Manchester

Kawneer curtain walling holds a unique key to a gateway building.

Meeting a quartet of criteria, Kawneer's AA®110 SSG (Structurally Silicone Glazed) and AA®100 capped aluminium curtain walling almost completely wraps the new £25 million Citylabs 2.0 development within the Oxford Road Corridor innovation district in Manchester, at the gateway to Europe's largest clinical-academic campus.

Citylabs 2.0 is part of a £95 million expansion to the Citylabs campus which is located at Manchester University NHS Foundation Trust's (MFT) Oxford Road hub and is a partnership between MFT and the UK's leading property provider to the science and tech sector, Bruntwood SciTech. The project builds on the success of Citylabs 1.0 which opened in 2014 and is fully-let, and Citylabs 2.0 will provide world-class lab and office space for global diagnostics company QIAGEN who have 100% pre-let the building for their Global Centre of Excellence for Precision Medicine.



Kawneer's AA®110 SSG curtain walling with flush silicone sightlines has been used throughout, while the AA®100 version with 50mm sightlines features on the ground floor entrance of the 8,500m² state-of-the-art building designed by frequent Kawneer specifiers, architects Sheppard Robson.

The practice conceived Citylabs 2.0 as a block of accommodation with one elevational treatment, with recessed areas carved out of the main block clad in alternative materials. To realise this concept, the main body was formed in the Kawneer AA®110 flush cap-less curtain walling, with a digitally printed design to the glazing.

The concrete frame of the building provides clear open floor plates to support different work typologies while the post-tensioned floor slabs provide clear, uninterrupted soffits for ease of services distribution.

The recesses at level 5 and the plant room are clad in ribbed fibre cement panels, the recess on the Hathersage Road elevation is clad in louvres, and the recess to the main entrance is the Kawneer full-height AA®100 curtain walling with accentuated vertical caps. The set back edges, and entrance canopy soffit, are clad in a bright coloured red anodized metal panel.

Sheppard Robson associate Mary-Ann Crompton said: "The sub-contractor chose Kawneer as the best product to realise the design intent and it achieved the required performance specification in terms of aesthetics, thermal, acoustic and movement requirements."

The AA®110 SSG curtain walling, with its wider 65mm back box, is typically specified to minimise building movement and at Citylabs 2.0 was complemented by the fritted glazing and spandrel panels.

"The existing adjacent buildings are Grade 2 listed and the cutbacks to Citylabs 2.0 have been organised to respond to the location and scale of them. The etched design to the glazing refers to details within the retained chapel which is to be refurbished as part of further future developments for Citylabs 3.0. The glazed elements of the curtain walling form the major component of the elevational design and has helped to fulfil the aesthetic aspirations for the project. In addition, aluminium is totally recyclable and is therefore a good material to use. This characteristic helps towards achieving a sustainable design."

The Kawneer systems were installed for main contractor Sir Robert McAlpine over six months by teams of up to eight people from Kawneer-approved specialist sub-contractor Bennett Architectural Aluminium Solutions.

Director Rob Bennett said: "The project was fully enclosed in Kawneer curtain wall. It was a large project for us and had to be installed within 25 weeks. The AA®110 curtain walling allowed increased building movement capability. "The glass on it was quite unique. We worked with the architect and designed a frit pattern that was used as part of solar control. It has a very unique whirl and is quite striking."

Mary-Ann said: "We have used Kawneer on many of our projects over the years and have found that the technical and sales departments are very helpful with providing information at the early stages of design."

Businesses which locate to Citylabs have direct access to MFT's specialist clinical resources and expertise from researchers, clinicians and procurement teams as well as Bruntwood SciTech's specialist growth support and events programme, including access to funding, talent, new markets and academic connections.



Photos: Adrian Lambert



Supporting Your Projects



Authorities

- ISO 9001
Quality Management System
- BS EN 12020
Extruded precision aluminium profiles
- BS EN 12206-1
Paint and varnishes. Coating of aluminium and aluminium alloys for architectural purposes
- BS 3987
Specification for anodic coatings
- BS 4255 Part 1
Specification for non-cellular gaskets
- CWCT
Sequence B Standard for Systemised Building Envelopes
- BS EN 12152
Curtain Walling. Air Permeability. Performance requirements and classifications
- BS EN 12153
Curtain Walling. Air Permeability. Test method
- BS EN 12154
Curtain Walling. Watertightness. Performance requirements and classifications

- BS EN 12155
Curtain Walling. Watertightness. Laboratory test under static pressure
- BS EN 13116
Curtain Walling. Resistance to Windload. Performance requirements
- BS EN 12179
Curtain Walling. Resistance to Windload. Test method
- BS EN 14019
Curtain Walling impact resistance. Performance requirements
- BS 476-22
Fire tests on building materials and structures
- EN 1991-1-1
Eurocode 1: Actions on structures – Part 1-1: General actions – Densities, self-weight, imposed loads for buildings
- EN 1991-1-4
Eurocode 1: Actions on structures – Part 1-4: General actions – Wind actions
- EN 1363-1
Fire Resistance tests – Part 1: General requirements
- EN 1364-1
Fire resistance tests on non-loadbearing elements – Part 1: Walls
- EN 1364-3
Fire resistance tests on non-loadbearing elements – Part 3: Curtain Walling
- EN 13830
Product standard curtain walls

Project Assistance

Kawneer's regionally based team of Architectural Advisers and the Architectural Services Team based at our Head Office in Runcorn are able to provide project advice and support:

Tel: 01928 502604 / Fax: 01928 502512
Email: kawneerAST@arconic.com

Information on Kawneer's extensive range of Curtain Wall, Window, Framing, Door, Fire Resistant and Sliding Solutions can also be obtained from our Head Office by calling:

Tel: 01928 502612

Kawneer UK Ltd is part of Arconic Building and Construction Systems, and enjoys the extensive resources of the entire Arconic organisation, allied to the specific glazing systems experience of Kawneer's many operations around the world. As a result of this our partners and customers have direct access to one of the largest pools of technical expertise in the construction industry.

A full range of guaranteed colours available

Established in the UK for over 50 years and powder coating profiles at its Runcorn base for 40 years, Kawneer has deep knowledge and experience in the specification and application of colour and paint systems.

The existing powder coating facility was converted to 'chrome free' – the first existing plant in the UK to be upgraded to this environmentally friendlier pre-treatment system – which gave Kawneer additional impetus to become a QUALICOAT approved applicator.

Quality and consistency of quality continues to be the main feature of QUALICOAT UK & Ireland, which includes third party testing of all certified powder formulations and pre-treatment systems that make up the QUALICOAT approval process. Kawneer has achieved 'Seaside' specification standard with this third party accreditation programme.

Kawneer Permacover™ is a high quality polyester powder paint finish, offering a wide range of solid and metallic colours providing outstanding resistance to environmental conditions. Kawneer Permacover™ has a 15 year gloss and 30 year matt and metallic guarantees subject to application and Kawneer acceptance in marine, industrial, swimming pools or other aggressive atmospheres.

To ensure the highest quality finish, powder coating is carried out in house as part of our single-source responsibility.

Kawneer Permanodic® is a range of subtle anodised colours which have been specifically developed for architectural glazing systems. Kawneer Permanodic® is a tried and tested anodising process, proven in accelerated laboratory tests, extensive field trials and contract experience. Subject to compliance with Kawneer's requirements, a 25 year finishes guarantee can be obtained.



John Bradfield Centre, Cambridge
Architect: Aukett Swanke

