



Kawneer UK Ltd
Astmoor Road, Astmoor Industrial Estate
Runcorn, Cheshire WA7 1QQ, United Kingdom
Tel: +44 (0) 1928 502500 Fax: +44 (0) 1928 502501

London Office
12 Berwick Street
Soho
London W1F 0PN
Tel: +44 (0) 207 287 5911

Email: kuk.kawneer@arconic.com
www.kawneer.co.uk

Other brochures available on request from Kawneer are:

- Architectural Aluminium Systems Finishes
- Door Systems
- Framing Systems
- Curtain Wall Systems
- Unitised Curtain Wall Systems
- AA®130 Brise Soleil System
Solar Shading for Reduced Solar Heat Gain
- Window Systems
- Juliet Balcony
- LouvreShield
- Residential Aluminium Glazing Systems
- Fire Resistant Systems
- The Architects Guide to Aluminium in Building
- Sustainability
- Maintenance and Cleaning

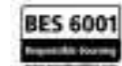

Kawneer's continuous development and engineering programmes may bring about product changes. Kawneer reserves the right to introduce without notice such changes which will not detract from the product's performance
© KAWNEER UK LTD



SLIDING SOLUTIONS





One The Elephant, London, SE1
Architect: Squire & Partners
Photo: James Balston

Contents

Sliding Solutions Product Selector	4
AA®3720 Folding/Sliding Door	6
AA®3572 Lift/Slide Door	14
AA®4110 Lift/Slide and Sliding Patio Door	22
AA®3110 Horizontal Sliding Window	30
AA®3610/AA®3610LS Vertical Sliding Windows	36
Supporting Your Projects	42

Sliding Solutions Product Selector

	AA®3720 Folding/Sliding Door	AA®3572 Lift/Slide Door	AA®4110 Lift/Slide and Sliding Patio Door	AA®3110 Horizontal Slider	AA®3610/AA®3610LS Vertical Slider
Applications					
New build	■	■	■	■	■
Refurbishment	■	■	■	■	■
Key Features					
BRE Green Guide Rating°	A				
Optimum ventilation	■	■	■	■	■
Dual colour option	■	■	■	■	■
Punched openings	■	■	■	■	■
Triple Glazing	■+	■+			
Bead glazing	■	■	■		■
Wrap around glazing				■	
100mm restriction				■	■
Choice of Panel/Sash	■			■	■
Trickle ventilation	■		■		■
Suites with AA®100/AA®110 curtain walling	□	□	□	■	■
Suites with AA®720 Range	■	■			
Suites with 451PT framing					■
Performance					
Weather performance (BS 6375)	■	■	■	■	■
Security to PAS 24:2016	■	■	■	■	■
Document F compliant*†	■	■	■	■	■
Document L compliant†	■	■	■	■	■
Accessories					
Locking handle	■	■	■-	■	■
Espagnolette locking				■	
Multi-point locking	■	■	■-	■	
Releasable and fixed restrictors available				■	■
Window Types					
Horizontal Sliding	■	■	■	■	
Vertical Sliding					■

Notes:

- * When fitted with trickle vent
- † Dependant on window size and configuration
- + Optional/Limited
- ° Corresponds to the BRE Global Green Guide online generic specification for windows and achieves a summary rating of A for non-domestic schemes. www.thegreenguide.org.uk Element Number 1231500007
- Subject to detail/assessment
- Lift/Slide only



AA®3720 Folding/Sliding Door

Introduction

The AA®3720 Folding/Sliding Door is a solution for projects that demand the highest levels of thermal and weathering performance at a competitive price.

The AA®3720 uses advanced thermal break technology, ensuring thermal efficiency and full compliance with Approved Document L. The polyamide thermal break allows for single and dual colour options. The use of extruded gasket profiles and drain and ventilate strategy enable the system to achieve its weathering performance.

The AA®3720 provides a door with market leading capabilities, equally suited to the discerning home owner or installed in commercial premises that wish to enhance their environment.

Our product development team focused on market demands to produce a door with high performance and innovation offering:

- Aesthetic Appeal
- Especially Slim Sightlines
- Simplified Fabrication
- Patented Features

Product Features and Benefits

- Highly insulated profiles with U_f -values as low as 1.8 W/m^2K for frame/vent combinations - uw-values as low as 1.0 W/m^2K at the maximum panel size (using 0.7 W/m^2K triple glazing and warm edge technology)
- A range of door configurations in either open-in or open-out stack variants - total flexibility for all project applications

- Panel sizes upto 1200mm(W) & 2930mm(H)** - Can achieve solutions in the most demanding of applications
- Slim sightlines - no floating mullions - Reduced metal content and increased fabrication efficiency
- Stainless steel rollers for smooth and effortless operation
- Choice of threshold options - continuity between internal and external spaces. Rebated, low and sunken track options to add further design capability
- Innovative design features - patented technology providing premium product performance
- Suites with the AA®720 Window Series - total design flexibility offering total project solutions

** Dependant upon glass size and weight

Construction

Weathering is achieved by the use of EPDM gaskets and woolpile. The door is designed to be pressure equalised and fully drained.

Security*

The AA®3720 Folding/Sliding Door has been independently tested to PAS 24:2016.

* Does not refer to standard hardware, security hardware required



Independently Weather Performance Tested to BS 6375-1: 2015

	Air Infiltration BS EN 12207: 2000	Watertightness BS EN 12208: 2000	Wind Resistance BS EN 12210: 2000
AA®3720 Folding/Sliding Door	Class 3 (600 Pa)	Class E750 (750 Pa)	Class A5 (1600 Pa)

All Windows comply with Operation and Strength Test BS 6375 Pt2: 2015

Details of the Kawneer product tests are available from the Technical Services Department at Runcorn.

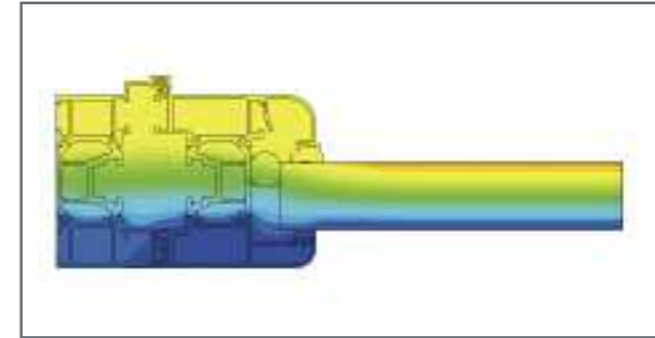

Standard Thermal Variant - Open Out

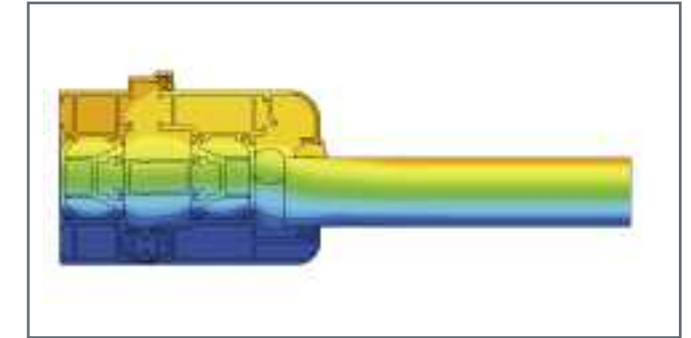

Enhanced Thermal Variant - Open Out

Enhanced Thermal Option



The addition of simple thermal shields divides the thermal chambers further to improve the thermal performance with minimal additional cost or fabrication. Enhancements of 0.1 W/m^2K are possible with this addition.



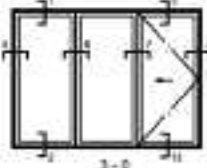
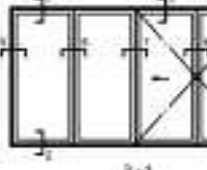
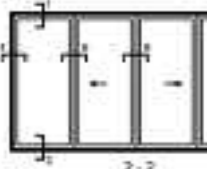

AA®3720 Folding/Sliding Door Applications

Typical Elevations

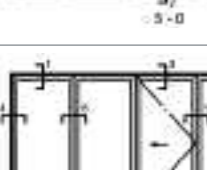
Full details can be downloaded from our website www.kawneer.co.uk

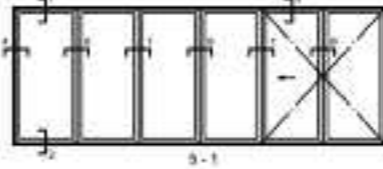
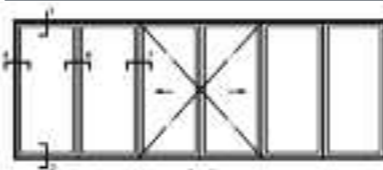
Elevation	Title	Website CAD ref. no.	
		Open-out	Open-in
	1, 3 Head 2 Threshold 4 Frame, panel with hinge 5 Frame, panel with latch lock / handle 6 Internal hinge / handle with shoot bolt 7 Panel / panel, roller set double & hinge 13 Cill arrangement	H1 03.01, H1 07.01, H1 25.01 H1 04.01, H1 05.01, H1 06.01 H1 08.01, H1 09.01 H1 10.01 H1 11.01, H1 12.01 H1 13.01, H1 14.01 H1 24.01	H2 03.01, H2 07.01 H2 04.01, H2 05.01, H2 06.01 H2 08.01, H2 09.01 H2 10.01 H2 11.01, H2 12.01 H2 13.01, H2 14.01 H2 15.01
	1, 3 Head 2 Threshold 4 Frame, panel with hinge 6 Internal hinge / handle with shoot bolt 7 Panel / panel, roller set double & hinge 8 Panel / panel, latch lock / handles / shoot bolt	H1 03.01, H1 07.01, H1 25.01 H1 04.01, H1 05.01, H1 06.01 H1 08.01, H1 09.01 H1 11.01, H1 12.01 H1 13.01, H1 14.01 H1 15.01	H2 03.01, H2 07.01 H2 04.01, H2 05.01, H2 06.01 H2 08.01, H2 09.01 H2 11.01, H2 12.01 H2 13.01, H2 14.01 H2 15.01
	1 Head 2 Threshold 4 Frame, panel with hinge 6 Internal hinge / handle with shoot bolt 9 Panel / panel, latchless lock	H1 03.01, H1 25.01 H1 04.01, H1 05.01, H1 06.01 H1 08.01, H1 09.01 H1 11.01, H1 12.01 H1 16.01, H1 17.01	H2 03.01 H2 04.01, H2 05.01, H2 06.01 H2 08.01, H2 09.01 H2 11.01, H2 12.01 H2 16.01, H2 17.01
	1 Head 2 Threshold 4 Frame, panel with hinge 6 Internal hinge / handle with shoot bolt 7 Panel / panel, roller set double & hinge 11 Frame / panel, latchless lock	H1 03.01, H1 25.01 H1 04.01, H1 05.01, H1 06.01 H1 08.01, H1 09.01 H1 11.01, H1 12.01 H1 13.01, H1 14.01 H1 20.01, H1 21.01	H2 03.01 H2 04.01, H2 05.01, H2 06.01 H2 08.01, H2 09.01 H2 11.01, H2 12.01 H2 13.01, H2 14.01 H2 20.01, H2 21.01
	1, 3 Head 2 Threshold 4 Frame, panel with hinge 5 Frame, panel with latch lock / handle 6 Internal hinge / handle with shoot bolt 7 Panel / panel, roller set double & hinge 13 Cill arrangement	H1 03.01, H1 07.01, H1 25.01 H1 04.01, H1 05.01, H1 06.01 H1 08.01, H1 09.01 H1 10.01 H1 11.01, H1 12.01 H1 13.01, H1 14.01 H1 24.01	H2 03.01, H2 07.01 H2 04.01, H2 05.01, H2 06.01 H2 08.01, H2 09.01 H2 10.01 H2 11.01, H2 12.01 H2 13.01, H2 14.01 H2 15.01
	1, 3 Head 2 Threshold 4 Frame, panel with hinge 6 Internal hinge / handle with shoot bolt 7 Panel / panel, roller set double & hinge 10 Panel / panel, latch lock, roller set single	H1 03.01, H1 07.01, H1 25.01 H1 04.01, H1 05.01, H1 06.01 H1 08.01, H1 09.01 H1 11.01, H1 12.01 H1 13.01, H1 14.01 H1 18.01, H1 19.01	H2 03.01, H2 07.01 H2 04.01, H2 05.01, H2 06.01 H2 08.01, H2 09.01 H2 11.01, H2 12.01 H2 13.01, H2 14.01 H2 18.01, H2 19.01

Elevation	Title	Website CAD ref. no.	
		Open-out	Open-in
	1, 3 Head 2 Threshold 4 Frame, panel with hinge 6 Internal hinge / handle with shoot bolt 7 Panel / panel, roller set double & hinge 8 Panel / panel, latch lock / handles / shoot bolt	H1 03.01, H1 07.01, H1 25.01 H1 04.01, H1 05.01, H1 06.01 H1 08.01, H1 09.01 H1 11.01, H1 12.01 H1 13.01, H1 14.01 H1 15.01	H2 03.01, H2 07.01 H2 04.01, H2 05.01, H2 06.01 H2 08.01, H2 09.01 H2 11.01, H2 12.01 H2 13.01, H2 14.01 H2 15.01
	1 Head 2 Threshold 4 Frame, panel with hinge 6 Internal hinge / handle with shoot bolt 7 Panel / panel, roller set double & hinge	H1 03.01, H1 25.01 H1 04.01, H1 05.01, H1 06.01 H1 08.01, H1 09.01 H1 11.01, H1 12.01 H1 13.01, H1 14.01	H2 03.01 H2 04.01, H2 05.01, H2 06.01 H2 08.01, H2 09.01 H2 11.01, H2 12.01 H2 13.01, H2 14.01
	4 Frame, panel with hinge 6 Internal hinge / handle with shoot bolt 15 Panel corner post 90°	H1 08.01, H1 09.01 H1 11.01, H1 12.01 H1 26.01	H2 03.01 H2 04.01, H2 05.01, H2 06.01 H2 13.01, H2 14.01



AA®3720 Folding/Sliding Door

Full details can be downloaded from our website www.kawneer.co.uk

Head Detail - Rebated Frame

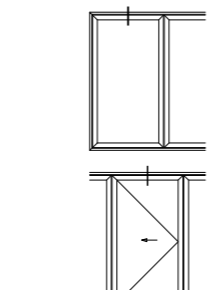
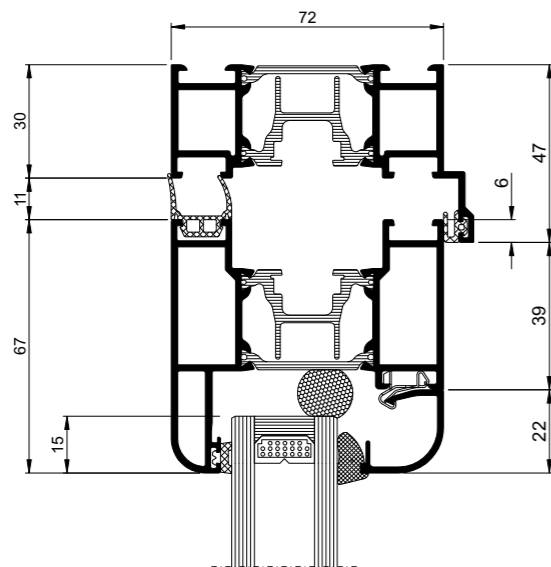

Viewed Externally
H1 03.01

Cill Detail - Rebated Threshold

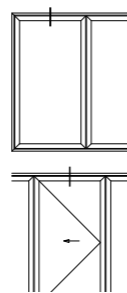
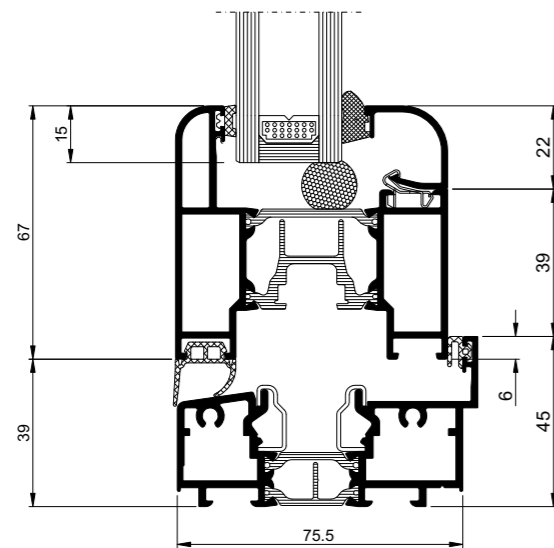

Viewed Externally
H1 04.01

AA®3720 Folding/Sliding Door

Full details can be downloaded from our website www.kawneer.co.uk

Latch Lock Panel Detail

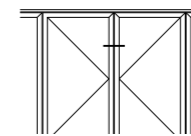
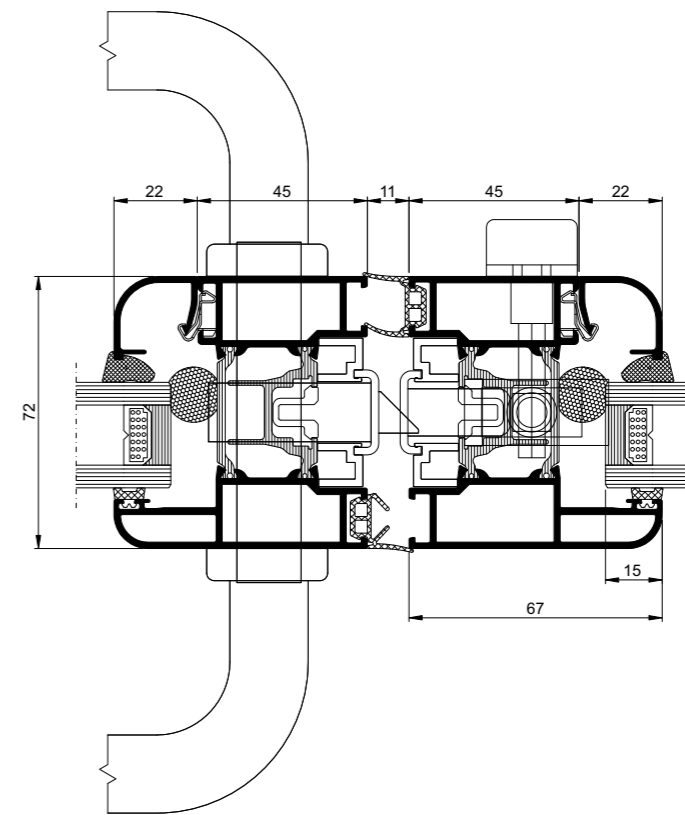

Viewed Externally
H1 15.01

AA®3720 Folding/Sliding Door

Full details can be downloaded from our website www.kawneer.co.uk

Shoot Bolt Locking Panel Detail

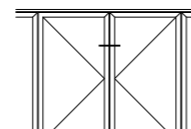
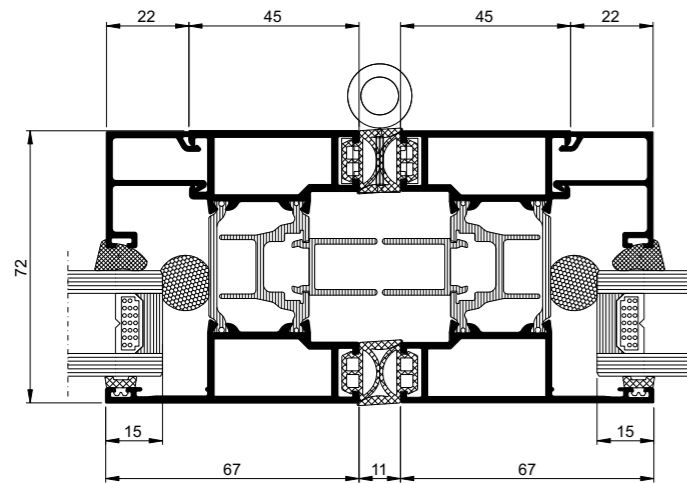

Viewed Externally
H1 12.01

Jamb Detail

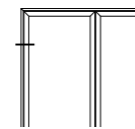
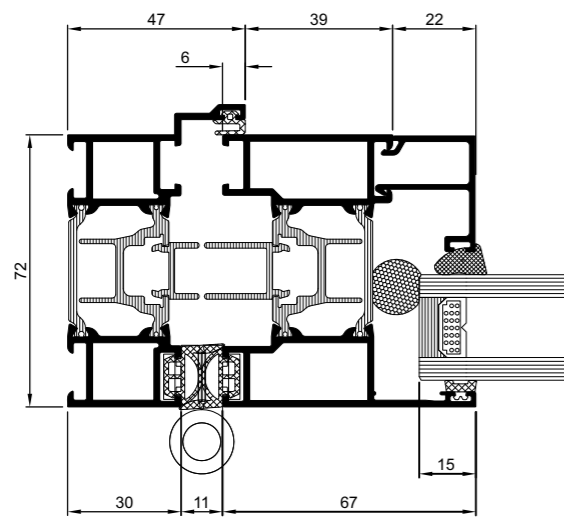

Viewed Externally
H1 09.01



AA®3572 Lift/Slide Door

Introduction

The AA®3572 Lift/Slide Door is a solution for projects that demand the highest levels of thermal and weathering performance.

The AA®3572 thermally insulated system delivers optimum levels of quality and performance with the lift/slide technology providing effortless operation enabling maximum panel sizes up to 3m x 3m with maximum weights up to 400kg.

Robust profiles with high insulation values enable large areas of glass for freedom of design. The option of slim meeting stiles allow the system to remain unobtrusive. As a sliding system, it is an ideal space saving solution where safety is a consideration and projecting swing doors are undesirable.

The double EPDM gasket with continuous rebate provides exceptional weathering performance and high levels of sound reduction.

Product Features and Benefits

- Highly insulated profiles with U_f -values as low as 1.8 W/m²K for frame/vent combinations - uw-values as low as **0.8 W/m²K** at the maximum panel size (using 0.6 W/m²K triple glazing and Swisspacer V bar)
- Panel sizes up to 3m x 3m can achieve large, uninterrupted areas of glazing
- Panel weights up to 400kg - can easily accommodate triple and acoustic glazing up to 56mm
- 2 and 3 track options - arrangements with up to 6 panels

- In line sliding operation for safe operation with no interference with internal finishes
- Stainless steel rollers offer smooth and effortless operation
- Low profile thresholds giving continuity between internal and external spaces
- Suites with the AA®720 Window Series and AA®100/AA®110 Curtain Walling Systems with total design flexibility offering total project solutions

Construction

Two track and three track lifting/sliding system. The AA®3572 is a multi-chamber thermally efficient system depending on construction type with 1, 2 or 3 insulation zones and is manufactured from high quality aluminium 6063T6 alloys in accordance with BS EN 12020.

Thermal Performance*

The AA®3572 Lift/Slide Door achieves a Double Glazed U-value of 1.4 W/m²K and a Triple Glazed U-value of 0.83 W/m²K.

* U-values based on 2 pane assembly measuring 2180mm x 2350mm (BS EN: 10077) using 1.1 W/m²K double glazing or 0.6 W/m²K triple glazing with Swisspacer V bar.

Security**

The AA®3572 Lift/Slide Door has been independently tested to PAS 24:2016.

** Does not refer to standard hardware, security hardware required



Independently Weather Performance Tested to BS 6375-1: 2015

	Air Infiltration BS EN 12207: 2000	Watertightness BS EN 12208: 2000	Wind Resistance BS EN 12210: 2000
AA®3572 Lift/Slide Door	Class 4 (600 Pa)	Class 9A (600 Pa)	Class C3 (1200 Pa)

Details of the Kawneer product tests are available from the Technical Services Department at Runcorn.



AA®3572 Lift/Slide Door Applications

Typical Elevations

Full details can be downloaded from our website www.kawneer.co.uk

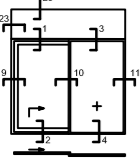
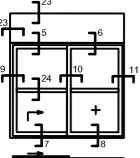
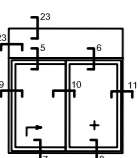
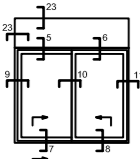
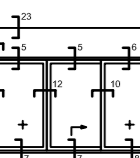
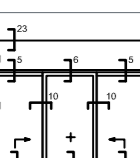
Elevation	Title	Website CAD ref. no.
	Scheme A 1 Sliding Panel inside 1 Fixed Panel outside 1 Fanlight (optional)	1 Sliding Vent - Head H01.04, H03.01 2 Sliding Vent - Cill H01.05 3 Fixed Panel - Head H01.06 4 Fixed Panel - Cill H01.07 9 Sliding Vent - Lock Jamb H01.12 10 Sliding Vent/Fixed Panel Interlock H01.13 11 Fixed Panel Jamb H01.14 23 Fanlight Frame H03.02
	Scheme A 1 Sliding Panel inside (with optional muntin) 1 Fixed Vent outside (with optional sash transom) 1 Fanlight (optional)	5 Sliding Vent - Head H01.08, H03.01 6 Fixed Panel - Head H01.09 7 Sliding Vent - Cill H01.10 8 Fixed Panel - Cill H01.11 9 Sliding Vent - Lock Jamb H01.12 10 Sliding Vent/Fixed Panel Interlock H01.13 11 Fixed Panel Jamb H01.14 24 Muntin H03.03 23 Fanlight Frame H03.02
	Scheme A 1 Sliding Panel inside 1 Fixed Vent outside 1 Fanlight (optional)	5 Sliding Vent - Head H01.08, H03.01 6 Fixed Panel - Head H01.09 7 Sliding Vent - Cill H01.10 8 Fixed Panel - Cill H01.11 9 Sliding Vent - Lock Jamb H01.12 10 Sliding Vent/Fixed Panel Interlock H01.13 11 Fixed Panel Jamb H01.14 23 Fanlight Frame H03.02
	Scheme D 1 Sliding Panel inside 1 Sliding Panel outside 1 Fanlight (optional)	5 Sliding Vent - Head H01.08, H03.01 6 Fixed Panel - Head H01.09 7 Sliding Vent - Cill H01.10 8 Fixed Panel - Cill H01.11 9 Sliding Vent - Lock Jamb H01.12 10 Sliding Vent/Fixed Panel Interlock H01.13 11 Fixed Panel Jamb H01.14 23 Fanlight Frame H03.02
	Scheme G 1 Fixed Vent inside 1 Sliding Panel inside 1 Fixed Vent outside 1 Fanlight (optional)	5 Sliding Vent - Head H01.08, H03.01 6 Fixed Panel - Head H01.09 7 Sliding Vent - Cill H01.10 8 Fixed Panel - Cill H01.11 9 Sliding Vent - Lock Jamb H01.12 10 Sliding Vent/Fixed Panel Interlock H01.13 11 Fixed Panel Jamb H01.14 12 Meeting Stile H01.15 23 Fanlight Frame H03.02
	Scheme H 1 Sliding Panel inside 1 Fixed Vent outside 1 Sliding Panel inside 1 Fanlight (optional)	2 Sliding Vent - Cill H01.05 5 Sliding Vent - Head H01.08, H03.01 6 Fixed Panel - Head H01.09 7 Sliding Vent - Cill H01.10 8 Fixed Panel - Cill H01.11 9 Sliding Vent - Lock Jamb H01.12 10 Sliding Vent/Fixed Panel Interlock H01.13 23 Fanlight Frame H03.02

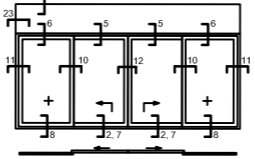
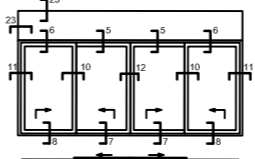
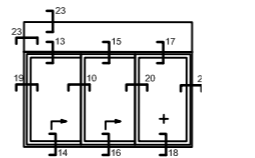
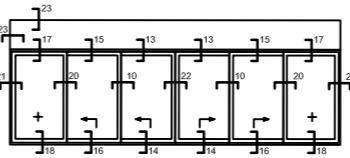
Elevation	Title	Website CAD ref. no.
	Scheme C 1 Fixed Vent outside 2 Sliding Panels inside 1 Fixed Vent outside 1 Fanlight (optional)	2 Sliding Vent - Cill H01.05 5 Sliding Vent - Head H01.08, H03.01 6 Fixed Panel - Head H01.09 7 Sliding Vent - Cill H01.10 8 Fixed Panel - Cill H01.11 10 Sliding Vent/Fixed Panel Interlock H01.13 11 Fixed Panel Jamb H01.14 12 Meeting Stile H01.15 23 Fanlight Frame H03.02
	Scheme F 1 Sliding Panel outside 2 Sliding Panels inside 1 Sliding Panel outside 1 Fanlight (optional)	5 Sliding Vent - Head H01.08, H03.01 6 Fixed Panel - Head H01.09 7 Sliding Vent - Cill H01.10 8 Fixed Panel - Cill H01.11 10 Sliding Vent/Fixed Panel Interlock H01.13 11 Fixed Panel Jamb H01.14 12 Meeting Stile H01.15 23 Fanlight Frame H03.02
	Scheme E 1 Sliding Panel inside 1 Sliding Panel centre 1 Fixed Vent outside 1 Fanlight (optional)	10 Sliding Vent/Fixed Panel Interlock H01.13 13 Sliding Vent inside - Head H02.02 14 Sliding Vent inside - Cill H02.03 15 Sliding Vent centre - Head H02.04 16 Sliding Vent centre - Cill H02.05 17 Fixed Panel outside - Head H02.06 18 Fixed Panel outside - Cill H02.07 19 Sliding Vent inside - Jamb H02.10 20 Sliding Vent/Fixed Panel Interlock H02.11 21 Fixed Panel outside - Jamb H02.12 23 Fanlight Frame H03.02
	Scheme L 1 Fixed Vent outside 1 Sliding Panel centre 2 Sliding Panels inside 1 Sliding Panel centre 1 Fixed Vent outside 1 Fanlight (optional)	10 Sliding Vent/Fixed Panel Interlock H01.13 13 Sliding Vent inside - Head H02.02 14 Sliding Vent inside - Cill H02.03 15 Sliding Vent centre - Head H02.04 16 Sliding Vent centre - Cill H02.05 17 Fixed Panel outside - Head H02.06 18 Fixed Panel outside - Cill H02.07 20 Sliding Vent/Fixed Panel Interlock H02.11 21 Fixed Panel outside - Jamb H02.12 22 Meeting Stile H02.14 23 Fanlight Frame H03.02



AA®3572 Lift/Slide Door

Full details can be downloaded from our website www.kawneer.co.uk

Head and Cill Detail – Scheme A

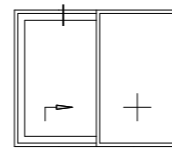
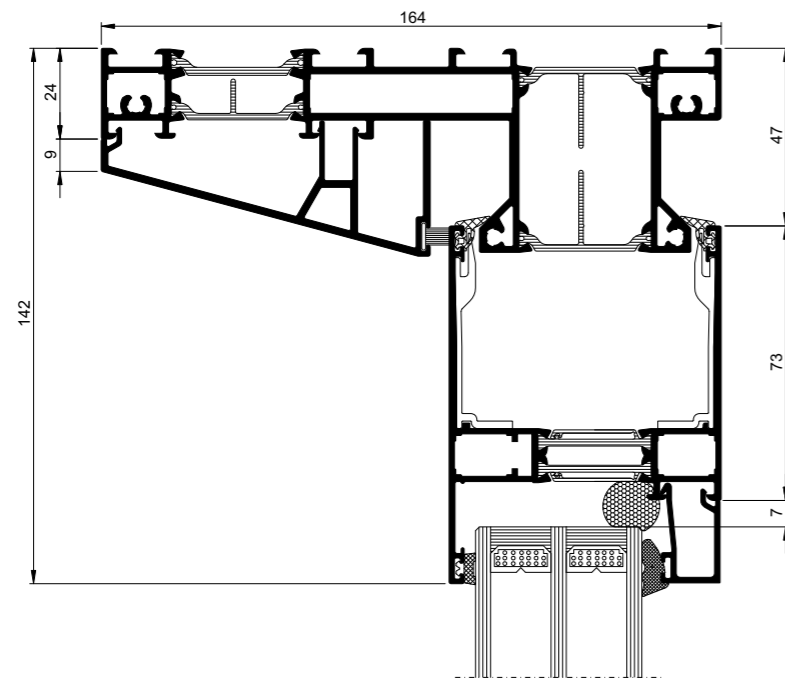

H01.04

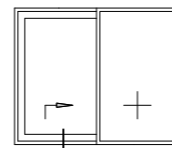
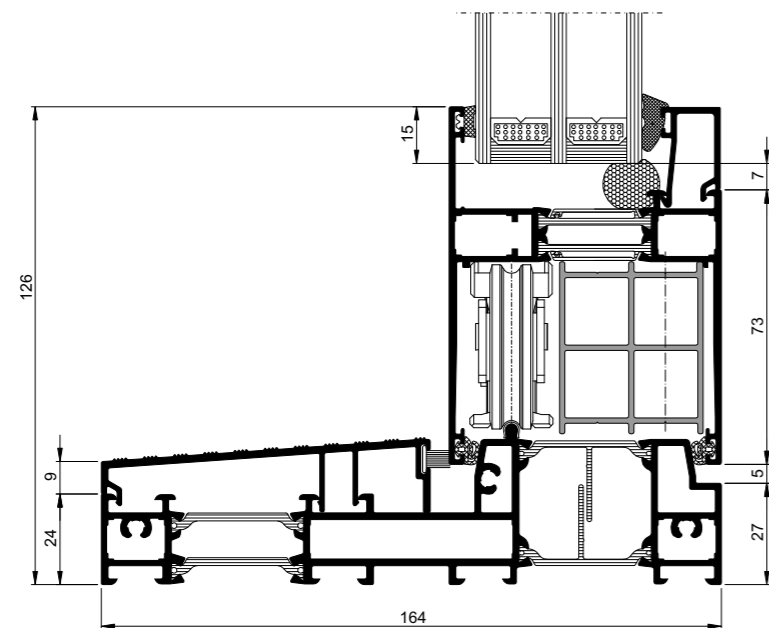

H01.05

AA®3572 Lift/Slide Door

Full details can be downloaded from our website www.kawneer.co.uk

Interlock Detail

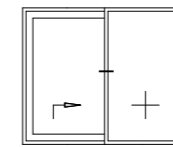
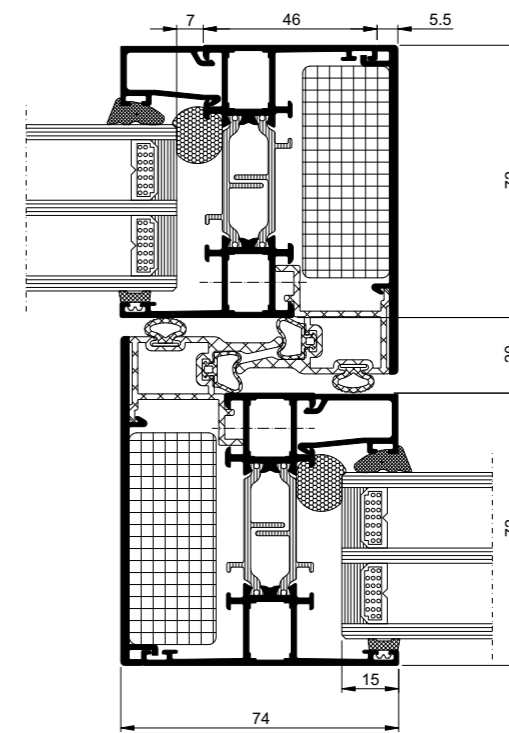

H01.13

AA®3572 Lift/Slide Door

Full details can be downloaded from our website www.kawneer.co.uk

Fixed Panel Options

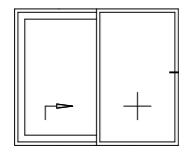
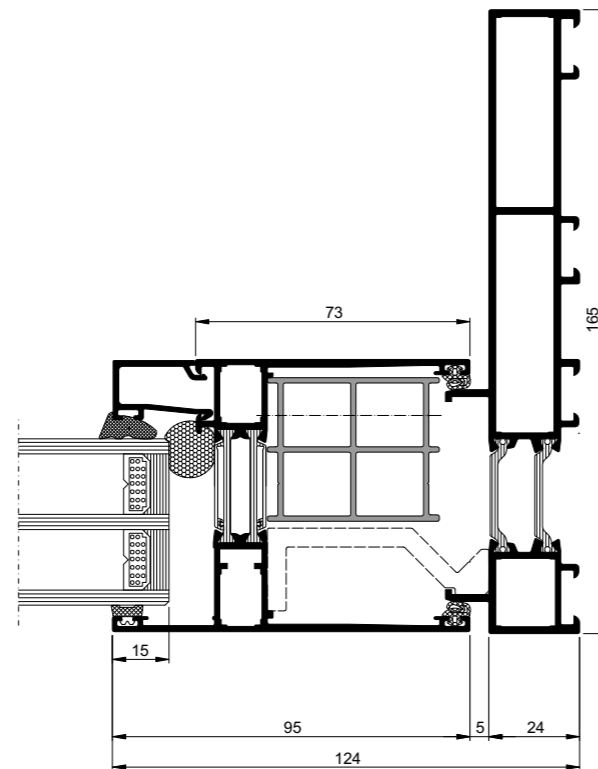
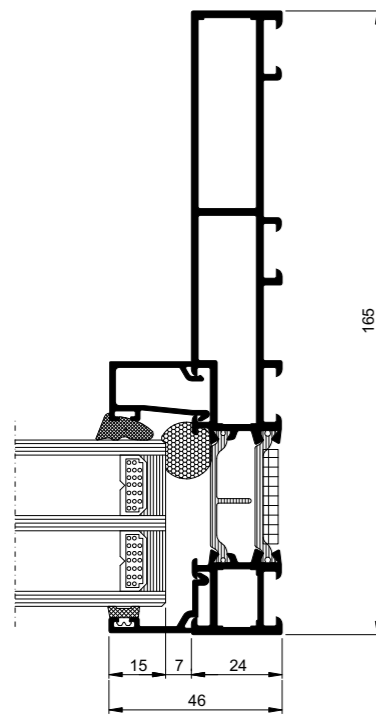

H01.14

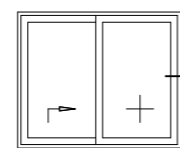

H01.14

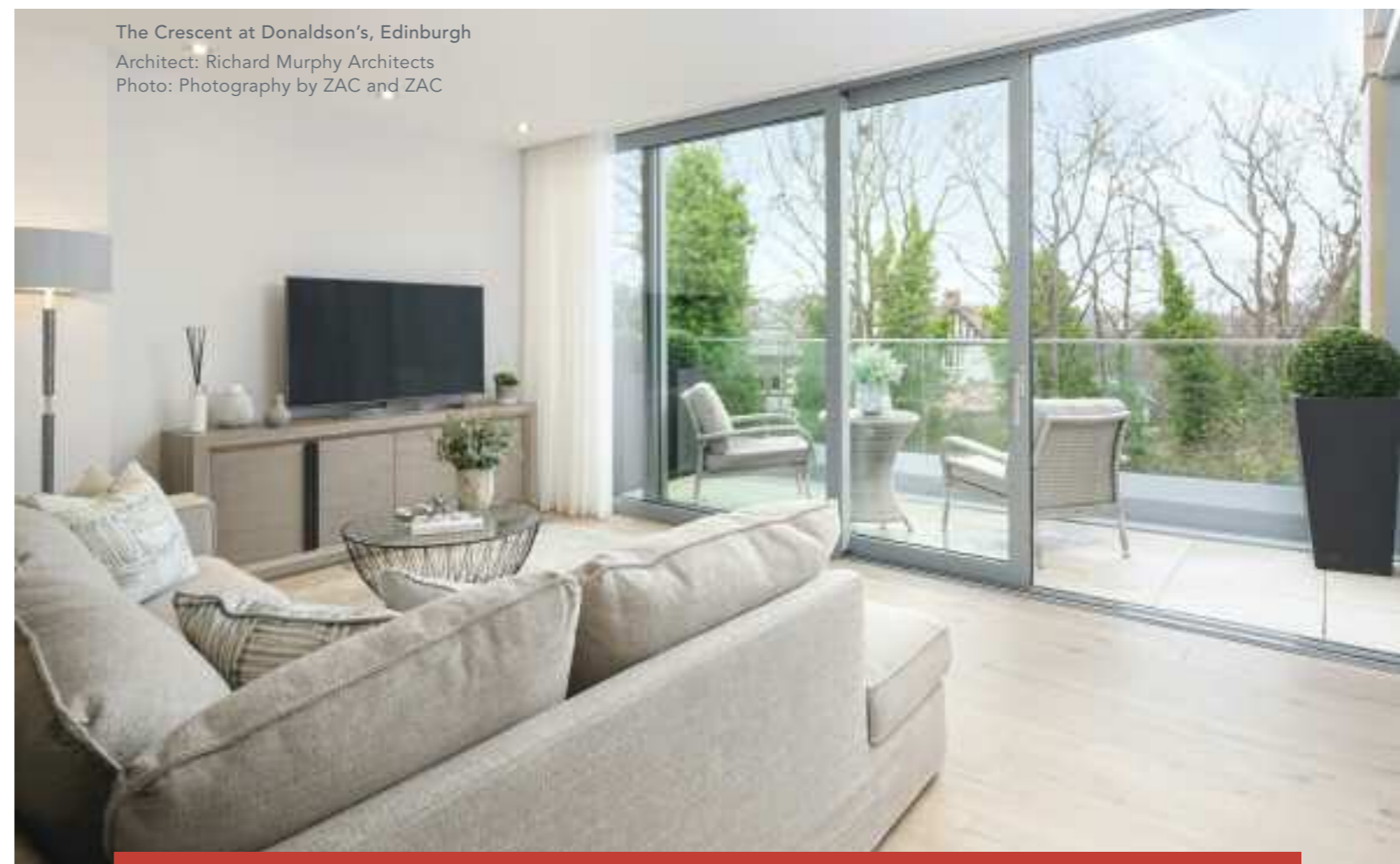

AA®4110 Lift/Slide and Sliding Patio Door

Introduction

The AA®4110 Lift/Slide and Sliding Patio Door is a solution for projects that demand the highest levels of thermal and weathering performance. It is a cost-effective sliding system, ideal for both residential and light commercial applications.

The AA®4110 thermally insulated system delivers optimum levels of quality and performance with the lift/slide technology providing effortless operation enabling maximum panel sizes up to 3m x 3m with maximum weights up to 160kg sliding and 250kg lift/slide.

Two and three track options are available with a variety of panel configurations and the adjustable, precision engineered stainless steel rollers, provide a smooth and effortless action which can be maintained for larger, heavier panels with the lift/slide hardware.

Product Features and Benefits

- Available as parallel slide or lift/slide options
- Panel sizes up to 3m x 3m
- Panel weights up to 160kg sliding and 250kg lift/slide can accommodate glazing from 28mm to 36mm
- Two and three track options – arrangements with up to 6 panels
- Stainless steel rollers offer smooth and effortless operation
- Beaded sash frame for onsite glazing
- Dual colour option for specification of a different colour finish inside and outside

Construction

The AA®4110 is a multi-chamber thermally efficient system available in two or three track options. The panel and outer frames have mitred corner constructions using cleats and corner braces which can be crimped or pinned. Weathering is achieved by the use of EPDM gaskets and woolpile. The system is fully drained and ventilated.

Thermal Performance*

The AA®4110 Slider achieves a Double Glazed U-value of 1.8 W/m²K and a Triple Glazed U-value of 1.5 W/m²K.

* U-values based on 2 pane assembly measuring 2500mm x 2500mm (BS EN: 10077) using 1.0 W/m²K double glazing or 0.7 W/m²K triple glazing with Swisspacer Ultimate.



Zeeburgerbaai, Amsterdam
 Architect: Attika Architekten
 Photo: Dirk Verwoerd – Lighthouse Productions



Independently Weather Performance Tested to BS 6375-1: 2015

	Air Infiltration BS EN 12207: 2000	Watertightness BS EN 12208: 2000	Wind Resistance BS EN 12210: 2000
AA®4110 Lift/Slide and Sliding Patio Door	Class 4 (600 Pa)	Class 6A (250 Pa)	Class C3 (1800 Pa)

Details of the Kawneer product tests are available from the Technical Services Department at Runcorn.

AA®4110 Lift/Slide and Sliding Patio Door Applications

Typical Elevations

Full details can be downloaded from our website www.kawneer.co.uk

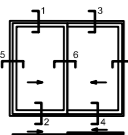
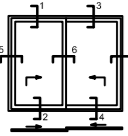
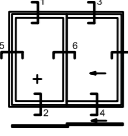
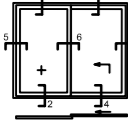
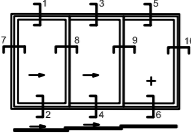
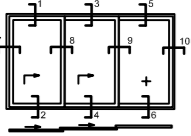
Elevation	Title	Website CAD ref. no.
2-Track Section Detail - AA®4110 Product Manual		
	Scheme D	1 Sliding Panel (outer track) - Head H01.01
	1 Sliding Panel (inside track)	2 Sliding Panel (outer track) - Cill H01.01
	1 Sliding Panel (outside track)	3 Sliding Panel (inner track) - Head H01.01
		4 Sliding Panel (inner track) - Cill H01.01
		5 Sliding Panel (outer track) - Lock Jamb H01.01
		6 Sliding Panel Interlock H01.01
		7 Sliding Panel (inner track) - Lock Jamb H01.01
	Scheme D	1 Sliding Vent (outer track) - Head H02.01
	1 Lift & Sliding Panel (inside track)	2 Sliding Vent (outer track) - Cill H02.01
	1 Lift & Sliding Panel (outside track)	3 Sliding Panel (inner track) - Head H02.01
		4 Sliding Panel (inner track) - Cill H02.01
		5 Sliding Panel (outer track) - Lock Jamb H02.01
		6 Sliding Panel Interlock H02.01
		7 Sliding Panel (inner track) - Lock Jamb H02.01
	Scheme A	1 Fixed 'dummy' Panel (outer track) - Head H03.01
	1 Sliding Panel (inside track)	2 Fixed 'dummy' Panel (outer track) - Cill H03.01
	1 Fixed Panel (outside track)	3 Sliding Panel (inner track) - Head H03.01
		4 Sliding Panel (inner track) - Cill H03.01
		5 Fixed 'dummy' Panel (outer track) - Jamb H03.01
		6 Sliding Panel Interlock H03.01
		7 Sliding Panel (inner track) - Lock Jamb H03.01
	Scheme A	1 Fixed 'dummy' Panel (outer track) - Head H04.01
	1 Lift & Sliding Panel (inside track)	2 Fixed 'dummy' Panel (outer track) - Cill H04.01
	1 Fixed Panel (outside track)	3 Sliding Panel (inner track) - Head H04.01
		4 Sliding Panel (inner track) - Cill H04.01
		5 Fixed 'dummy' Panel (outer track) - Jamb H04.01
		6 Sliding Panel Interlock H04.01
		7 Sliding Panel (inner track) - Lock Jamb H04.01
3-Track Section Detail - AA®4110 Supplement		
	Scheme E	1 Sliding Panel (outer track) - Head H01.01
	1 Fixed 'dummy' Panel (inside track)	2 Sliding Panel (outer track) - Cill H01.01
	1 Sliding Panel (centre track)	3 Sliding Panel (centre track) - Head H01.01
	1 Sliding Panel (outside track)	4 Sliding Panel (centre track) - Cill H01.01
		5 Fixed 'dummy' Panel (inner track) - Head H01.01
		6 Fixed 'dummy' Panel (inner track) - Cill H01.01
		7 Sliding Panel (outer track) - Lock Jamb H01.01
		8 Sliding Panel Interlock H01.01
		9 Sliding Panel Interlock H01.01
		10 Fixed 'dummy' Panel (inner track) - Jamb H01.01
	Scheme E	1 Sliding Panel (outer track) - Head H01.02
	1 Fixed 'dummy' Panel (inside track)	2 Sliding Panel (outer track) - Cill H01.02
	1 Lift & Sliding Panel (centre track)	3 Sliding Panel (centre track) - Head H01.02
	1 Lift & Sliding Panel (outside track)	4 Sliding Panel (centre track) - Cill H01.02
		5 Fixed 'dummy' Panel (inner track) - Head H01.02
		6 Fixed 'dummy' Panel (inner track) - Cill H01.02
		7 Sliding Panel (outer track) - Lock Jamb H01.02
		8 Sliding Panel Interlock H01.02
		9 Sliding Panel Interlock H01.02
		10 Fixed 'dummy' Panel (inner track) - Jamb H01.02

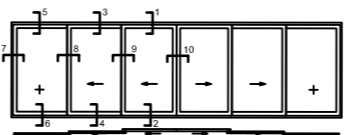
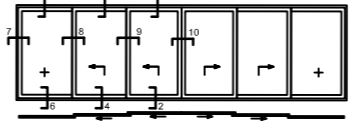
Elevation	Title	Website CAD ref. no.
	Scheme L	1 Sliding Panel (inner track) - Head H01.03
	2 Fixed 'dummy' Panels (outside track)	2 Sliding Panel (inner track) - Cill H01.03
	2 Sliding Panels (centre track)	3 Sliding Panel (centre track) - Head H01.03
	2 Sliding Panels (inside track)	4 Sliding Panel (centre track) - Cill H01.03
		5 Fixed 'dummy' Panel (outer track) - Head H01.03
		6 Fixed 'dummy' Panel (outer track) - Cill H01.03
		7 Fixed 'dummy' Panel (outer track) - Jamb H01.03
		8 Sliding Panel Interlock H01.03
		9 Sliding Panel Interlock H01.03
		10 Sliding Panel (inner track) - Meeting Stile H01.03
	Scheme L	1 Sliding Panel (inner track) - Head H01.04
	2 Fixed 'dummy' Panels (outside track)	2 Sliding Panel (inner track) - Cill H01.04
	2 Lift & Sliding Panels (centre track)	3 Sliding Panel (centre track) - Head H01.04
	2 Lift & Sliding Panels (inside track)	4 Sliding Panel (centre track) - Cill H01.04
		5 Fixed 'dummy' Panel (outer track) - Head H01.04
		6 Fixed 'dummy' Panel (outer track) - Cill H01.04
		7 Fixed 'dummy' Panel (outer track) - Jamb H01.04
		8 Sliding Panel Interlock H01.04
		9 Sliding Panel Interlock H01.04
		10 Sliding Panel (inner track) - Meeting Stile H01.04



AA®4110 Lift/Slide and Sliding Patio Door

Full details can be downloaded from our website www.kawneer.co.uk

Sliding Door

Head and Cill Detail – 2-Track

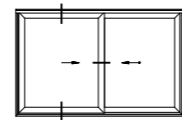
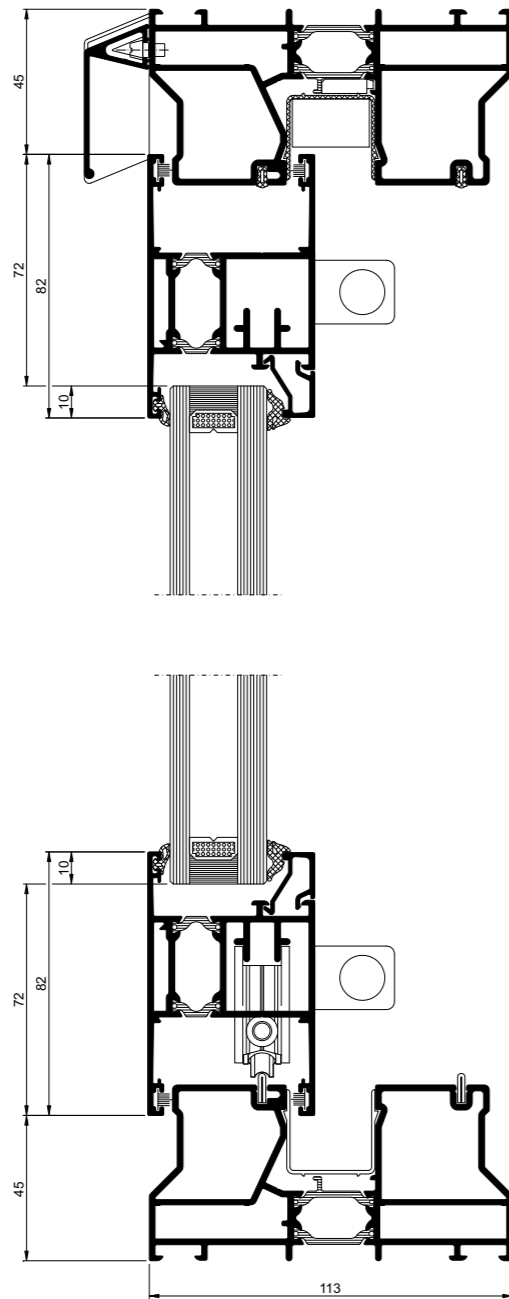

Viewed Externally
H01.01

AA®4110 Lift/Slide and Sliding Patio Door

Full details can be downloaded from our website www.kawneer.co.uk

Sliding Door

Interlock Detail

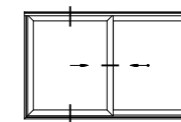
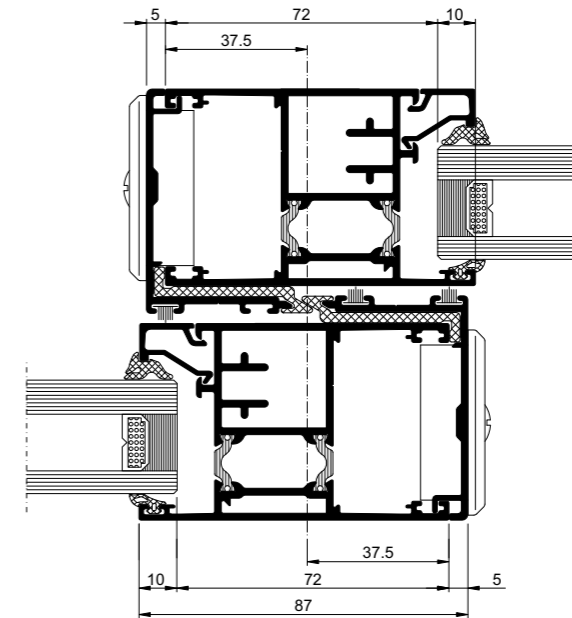

Viewed Externally
H01.01

AA®4110 Lift/Slide and Sliding Patio Door

Full details can be downloaded from our website www.kawneer.co.uk

Lift/Slide Door

Head and Cill Detail – 2-Track

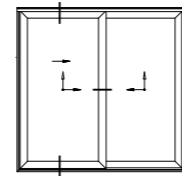
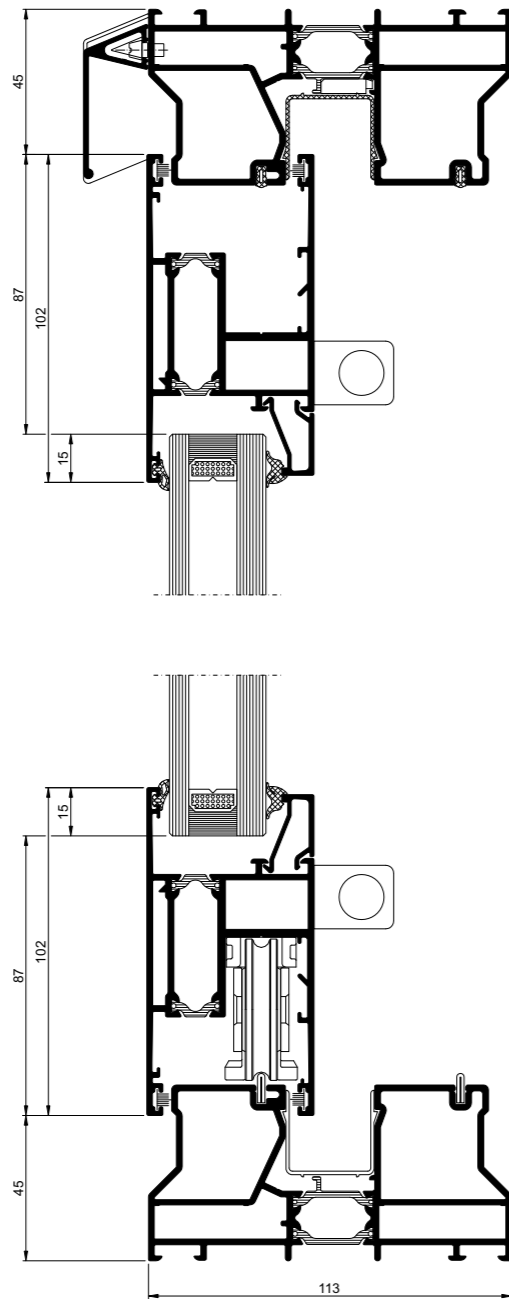

Viewed Externally
H02.01

AA®4110 Lift/Slide and Sliding Patio Door

Full details can be downloaded from our website www.kawneer.co.uk

Lift/Slide Door

Interlock Detail

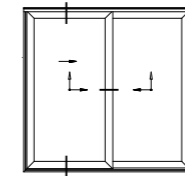
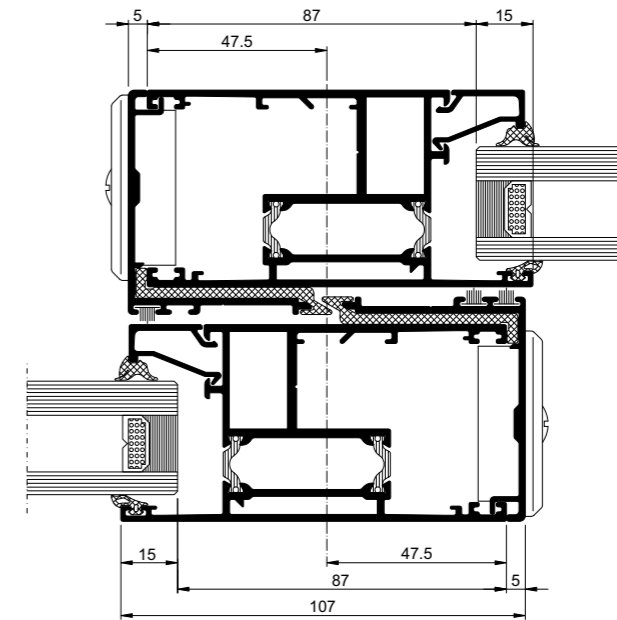

Viewed Externally
H02.01

AA®3110 Horizontal Sliding Window

Introduction

The AA®3110 horizontal sliding window is designed to meet the needs of any project that requires maximum ventilation, including general healthcare applications and mental health facilities. The AA®3110 horizontal sliding window has been designed to ensure that the needs of the user are paramount with its easy to operate functions and compliance with the HTM 55 regulations.

The AA®3110 is the product that you can specify with confidence when specifying demanding healthcare projects.

Product Features and Benefits

- Unique perforated wrap around glazing gasket, required when an anti-ligature solution is essential when handling demanding hospital projects
- Stainless steel track with adjustable wheels, offering smooth operation designed with the end user in mind
- Concealed locking mechanism
- Option for operation from both inside and outside offering a project solution for balcony applications
- Double or single sliding including 3 or 4 door and window options offering total flexibility for all project applications
- Self regulation ventilator in line with wind pressure, ideal to maximise air flow and ensure comfort for the occupants
- Dual colour option for specification of a different colour finish inside and outside
- Window when open does not project into the building, ideal when safety is a consideration on a project
- Accommodates glazing up to 33mm. Suitable for specialist and safety glazing and interstitial blinds

- Maximum panel height is 2.7m
- Maximum panel width is approximately 2.0m
- Maximum panel weight is 200kg
- Improved thermal performance can meet current Building Regulations

Construction

Weathering is achieved by the use of EPDM gaskets and woolpile. The window is designed to be pressure equalised and fully drained.

Configurations

The AA®3110 offers various design configurations, below are a few typical examples:



Sliding sash/ fixed frame



a. Sliding sash/ fixed frame 4 part
b. Sliding sash/ fixed frame with side light
c. Sliding sash

Security*

The AA®3110 Horizontal Sliding Window has been independently tested to PAS 24:2016.

* Does not refer to standard hardware, security hardware required



Independently Weather Performance Tested to BS 6375-1: 2015

	Air Infiltration BS EN 12207: 2000	Watertightness BS EN 12208: 2000	Wind Resistance BS EN 12210: 2000
AA®3110 Horizontal Slider	Class 3 (600 Pa)	Class 9A (600 Pa)	Class B5 (2000 Pa)

Performance is dependent on frame and panel combinations.

Details of the Kawneer product tests are available from the Technical Services Department at Runcorn.

AA®3110 Horizontal Sliding Window Applications

Typical Elevations

Full details can be downloaded from our website www.kawneer.co.uk

Elevation	Title	Website CAD ref. no.	Elevation	Title	Website CAD ref. no.
	1, 2, 3, 4 Sliding sash/ fixed frame 2-part single track - inside slide	H01.01		1, 2, 3, 4, 5, 6, 7, 8, 9, 10, 11 Sliding sash/ fixed frame with side light 2-part single track - inside slide	H12.01
	1, 2, 3, 4, 6, 7 Sliding sash/ fixed frame 3-part single track - inside slide	H04.01		1, 2, 3, 4, 5, 6, 6a, 7 Sliding sash/ fixed frame with fixing lugs 2-part single track - inside slide	H13.01
	1, 2, 3, 4, 6, 7, 8 Sliding sash/ fixed frame 3-part single track - inside slide	H05.01		1, 2, 3, 4, 5, 6, 6a, 7 Sliding sash frame 2-part double track - double slide	H14.01
	1, 2, 3, 4, 6, 7, 8, 9 Sliding sash/ fixed frame 4-part with meeting stiles single track - inside slide	H07.01		1, 2, 3, 4, 5, 6, 7, 8, 9, 10, 11 Sliding sash frame 2-part double track - double slide over fixed light	H15.01
	1, 2, 3, 4, 5, 6, 7, 8, 9, 10, 11 Sliding sash/ fixed frame with fan light 2-part single track - inside slide	H09.01		1, 2, 3, 4, 5, 6, 7, 8, 9, 10, 11 Sliding sash/ fixed frame 2-part double track - double slide with fan light	H16.01
	1, 2, 3, 4, 5, 6, 7, 8, 9, 10, 11 Sliding sash/ fixed frame 2-part single track - inside slide over a fixed light	H10.01			



AA®3110 Horizontal Sliding Window

Full details can be downloaded from our website www.kawneer.co.uk

Standard Drainage Option

Sash/Fixed Frame 2-Panel / Single Track – Inside Slide

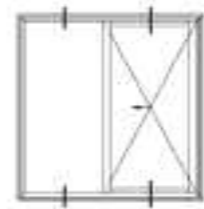
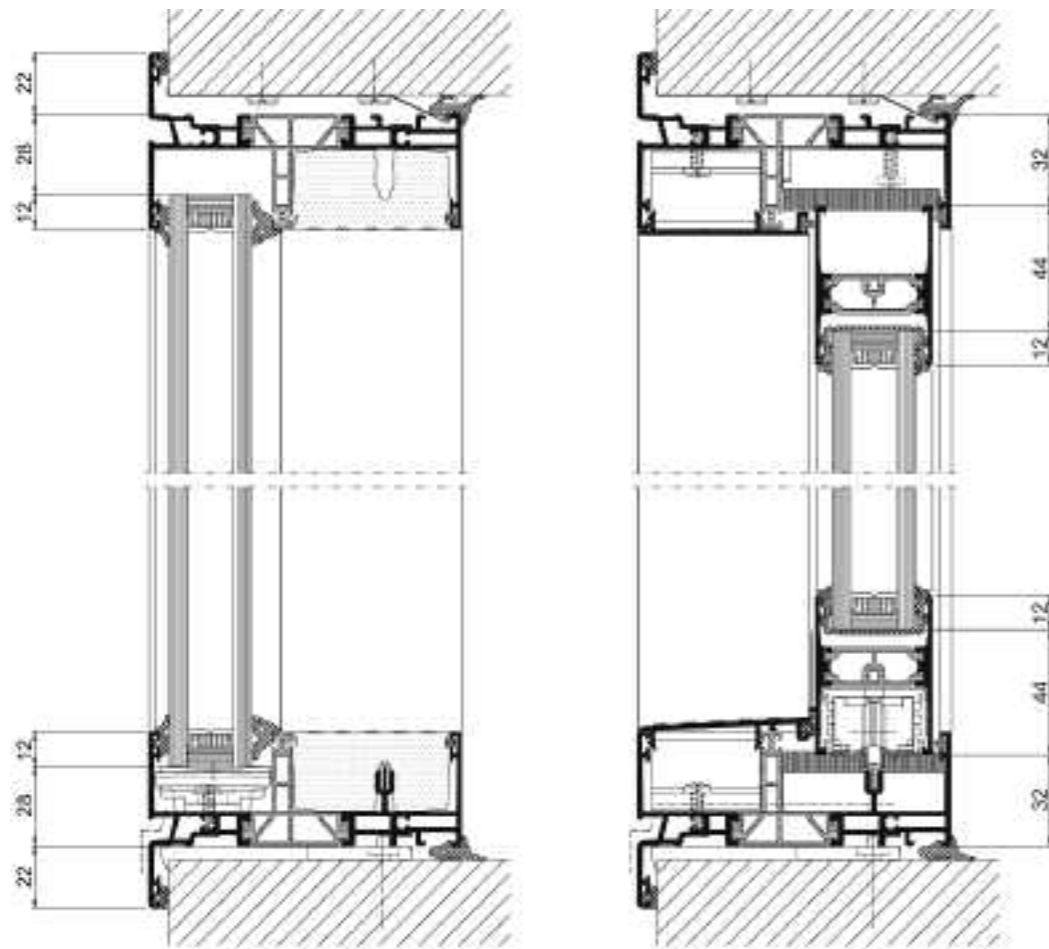

Viewed externally
H01.01

AA®3110 Horizontal Sliding Window

Full details can be downloaded from our website www.kawneer.co.uk

Standard Drainage Option

Sash/Fixed Frame 2-Panel / Single Track – Inside Slide

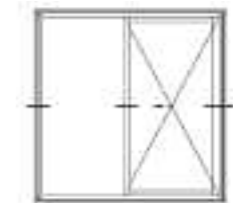
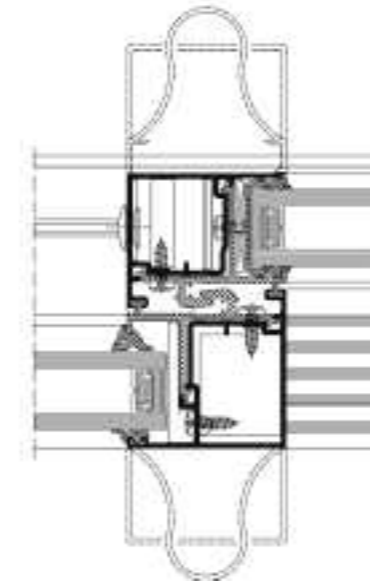
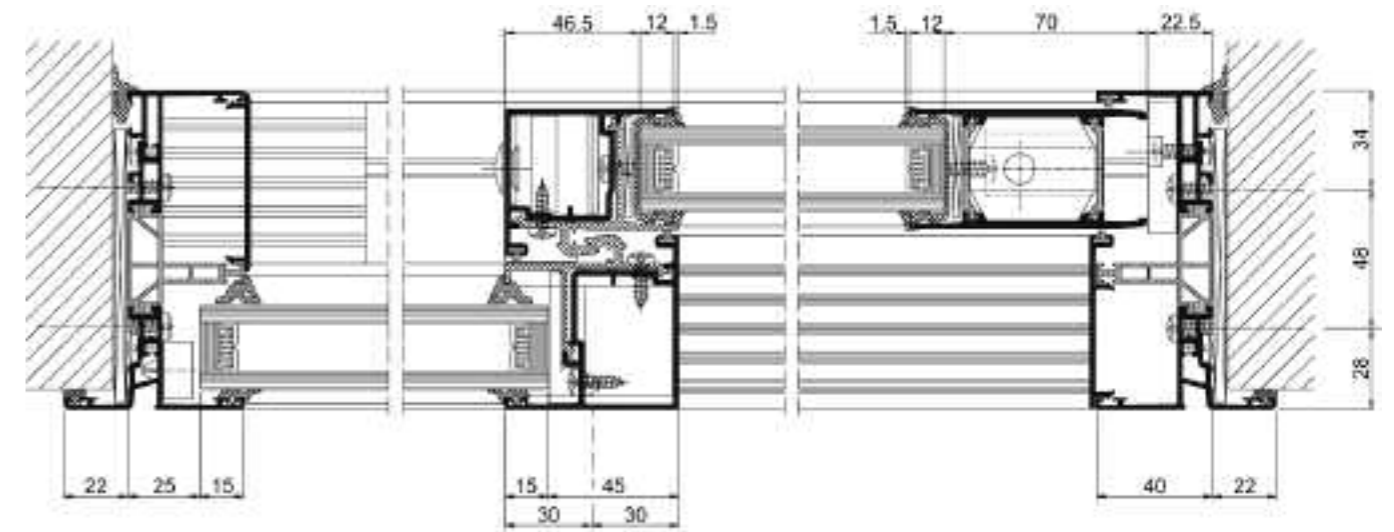

Viewed externally
H01.01

AA®3110 Horizontal Sliding Window

Full details can be downloaded from our website www.kawneer.co.uk

Concealed Drainage Option

Sash/Fixed Frame 3-Panel / Single Track – Inside Slide

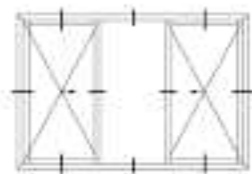
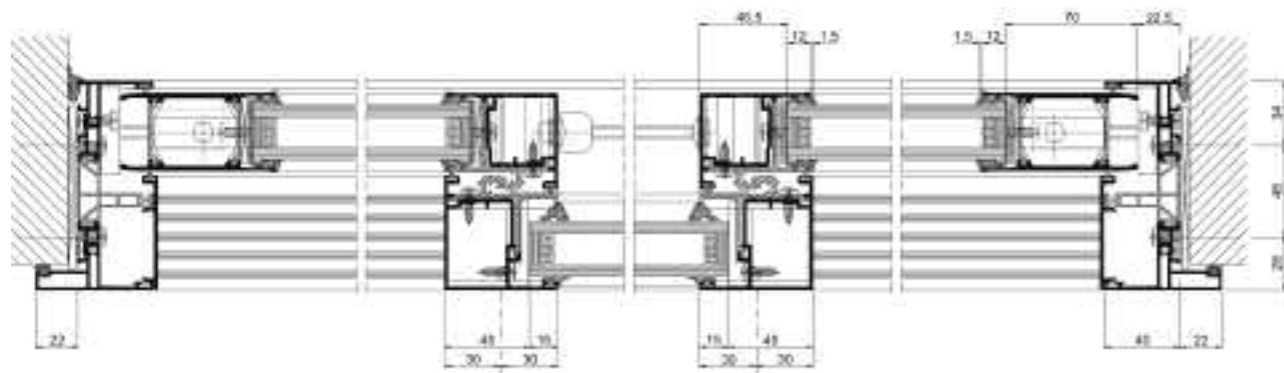
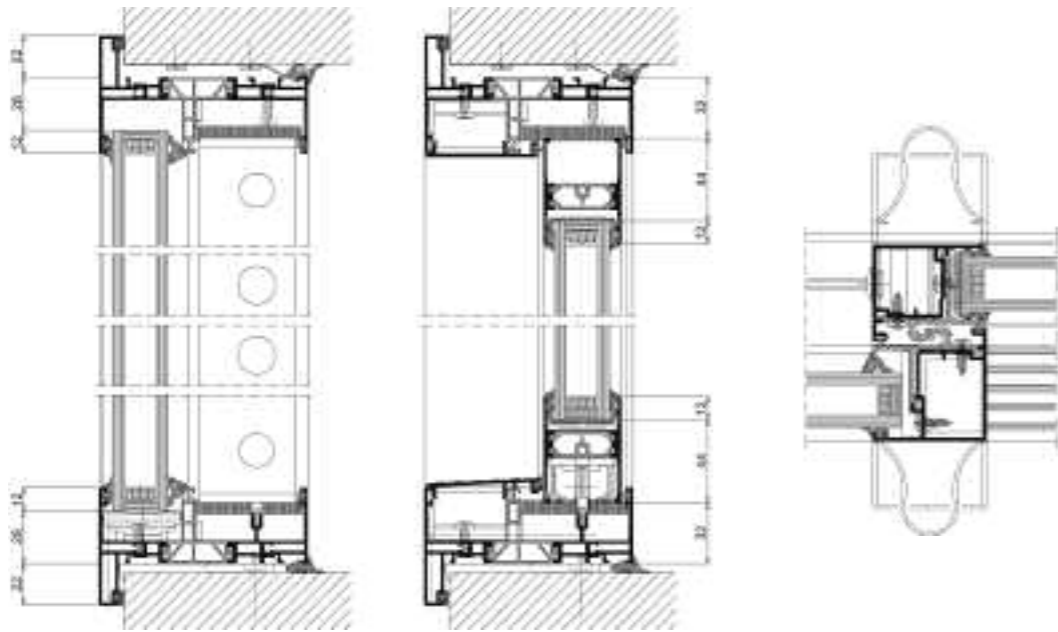

Viewed Externally
H04.01



AA®3110 Window with fixed lights above and below



AA®3610/AA®3610LS Vertical Sliding Windows

Introduction

The AA®3610 and AA®3610LS are the products to specify if maximum ventilation is critical to your project requirements. The ease of operation together with the optimum air flow make these windows ideal for schools and hospitals. The systems offer a fully integrated, flexible thermally broken vertical slider that has been designed with performance and aesthetics in mind.

Thermal insulation is achieved by utilising a unique polyamide thermal break design to give ultimate weather and thermal performance and smooth operation.

The AA®3610LS is a unique solution which opens the top and bottom sashes simultaneously allowing stale air out of the top of the window whilst allowing cool fresh air to be drawn in via the bottom.

Product Features and Benefits

- Vertical Sliding window featuring linked, double sliding and fixed lights for total flexibility for all project applications. Punched openings coupled or composite units can be accommodated
- Bead glazing from 24mm-32mm can be accommodated, options to comply with thermal and safety glass
- Option of integral muntin bar can help to replicate traditional wooden sash windows
- Concealed drainage offering better aesthetics
- Option of integral handle pull offering clean aesthetics
- Unique interlock design offering exceptional weathering and thermal performance

- Flush opening with no intrusion into or out of the building with no damage or interference with internal furnishings or blinds and offering added safety in use in ground floor applications

- Suites with Kawneer Curtain Wall and Framing products offering total design flexibility and total project solutions

Robust Solution

The AA®3610LS has been successfully cycle tested to represent over 75 years of use, so you can be sure that when you specify it your maintenance costs will be kept to a minimum.

Construction

Construction of both the AA®3610 and AA®3610LS are square cut screw spline joinery for consistent fabrication.

Weathering is achieved by the use of EPDM gaskets – all with non shrinkage cord. The window is designed to be pressure equalised and fully drained.

Security*

The AA®3610 Vertical Sliding Window has been independently tested to PAS 24:2016.

** Does not refer to standard hardware, security hardware required*



Independently Weather Performance Tested to BS 6375-1: 2015

	Air Infiltration BS EN 12207: 2000	Watertightness BS EN 12208: 2000	Wind Resistance BS EN 12210: 2000
AA®3610 Vertical Slider	Class 3 (600 Pa)	Class 9A (600 Pa)	Class B5 (2000 Pa)

Details of the Kawneer product tests are available from the Technical Services Department at Runcorn.

Product Selector

Performance	AA®3610	AA®3610LS
Torso and Ultra lift solutions available offering smooth operation to suite all project applications	■	
Single sliding option	■	
Locking fitch catch hardware available offering security in line with PAS 24: 2016*	■	
Option to open at 100mm, can comply with HTM 55 and BS 8213	■	
Ease of use, one operation gives high and low single sided ventilation, not reliant on the occupant opening multiple vents		■
High level ventilation at no extra cost, negates the need for actuators or remote operation gear to be fitted		■
Tested to equivalent of 75 years keeping maintenance costs to a minimum		■
Option of trickle ventilation	■	■

** Does not refer to standard hardware, security hardware required*

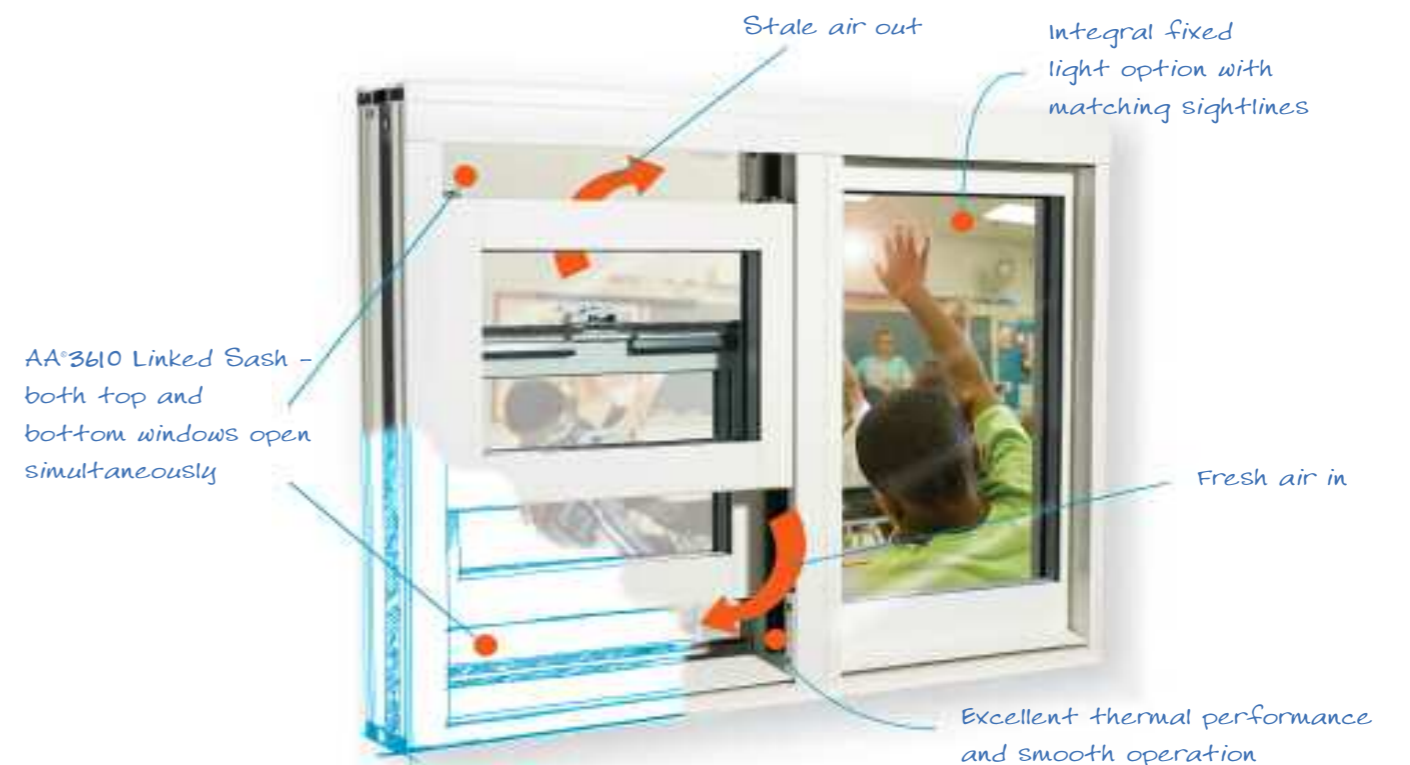

AA®3610/AA®3610LS Vertical Sliding Windows Applications

Typical Elevations

Full details can be downloaded from our website www.kawneer.co.uk

Elevation	Title	Website CAD ref. no.	Elevation	Title	Website CAD ref. no.
	1 1a Cill detail with sub cill	H02.01 H03.01		13,14 13a Coupling - vertical slider/ fixed light	H19.01 H20.01
	2 2a Head detail 1 2b Head detail 2 2c Head detail (trickle vent in sash)	H04.01 H05.01 H06.01 H07.01		15 15a Fixed light/ fixed light	H21.01 H22.01
	3 Interlock detail	H08.01		16 Cill detail in AA®100 curtain walling	H23.01
	4, 5 Jamb details	H10.01		17 Head detail in AA®100 curtain walling	H24.01
	8, 9 Coupling	H12.01		18 Jamb detail in AA®100 curtain walling	H25.01
	8a Coupling	H13.01			
	10 Cill - fixed light	H14.01			
	10a Cill and sub cill-fixed light	H15.01			
	11 Head - fixed light	H16.01			
	11a Head - fixed light with trickle vent	H17.01			
	12 Jamb - fixed light	H18.01			

AA®3610/AA®3610LS Vertical Sliding Windows

Full details can be downloaded from our website www.kawneer.co.uk

Head Detail

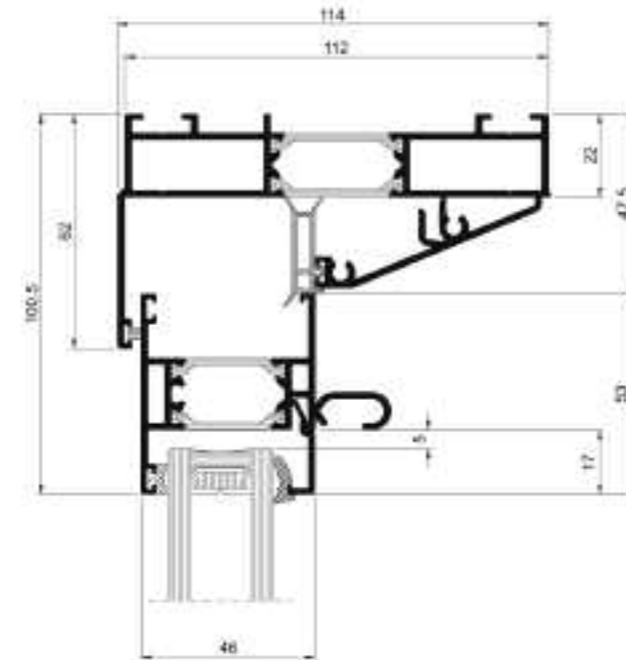

H04.01

Cill Detail

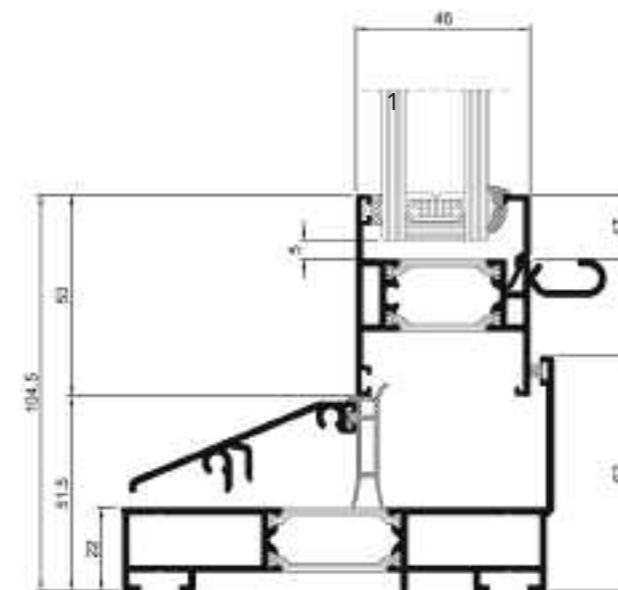

H02.01

AA®3610/AA®3610LS Vertical Sliding Windows

Full details can be downloaded from our website www.kawneer.co.uk

Meeting Rail

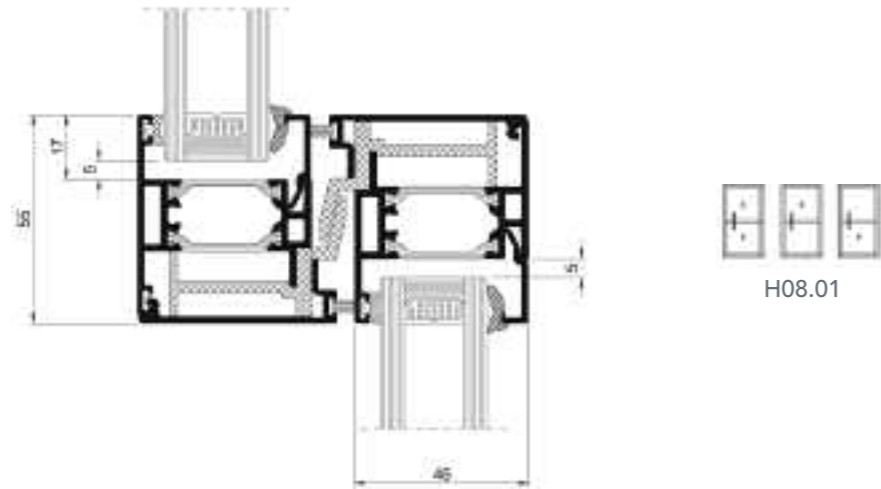

Coupling – Vertical Slider/Fixed Light

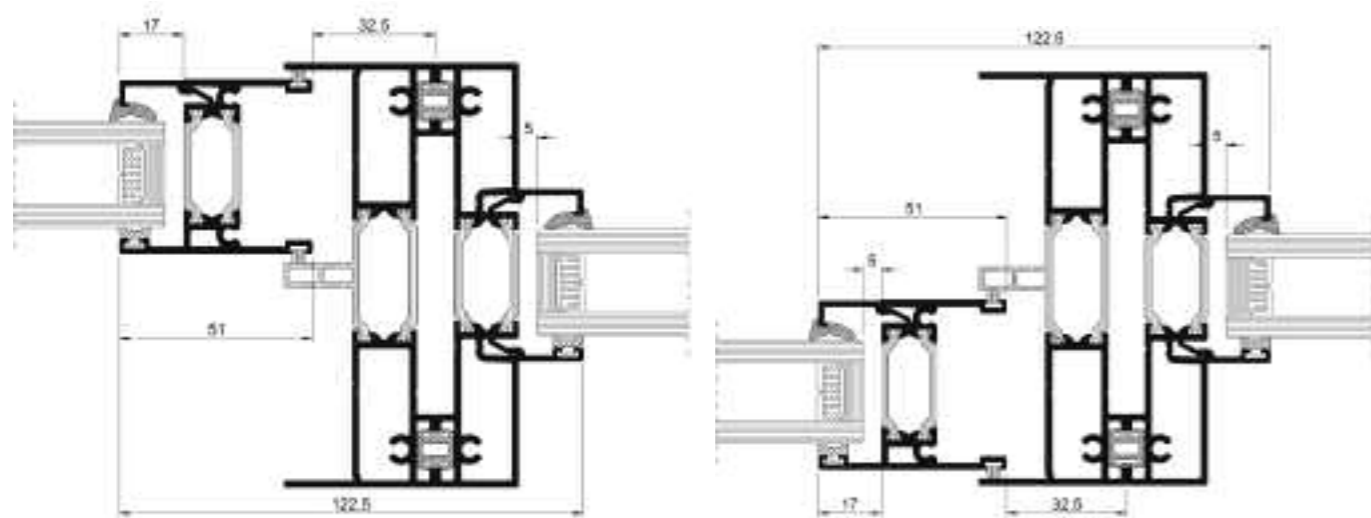

H19.01



H19.01

AA®3610/AA®3610LS Vertical Sliding Windows

Full details can be downloaded from our website www.kawneer.co.uk

Head Detail into Curtain Wall

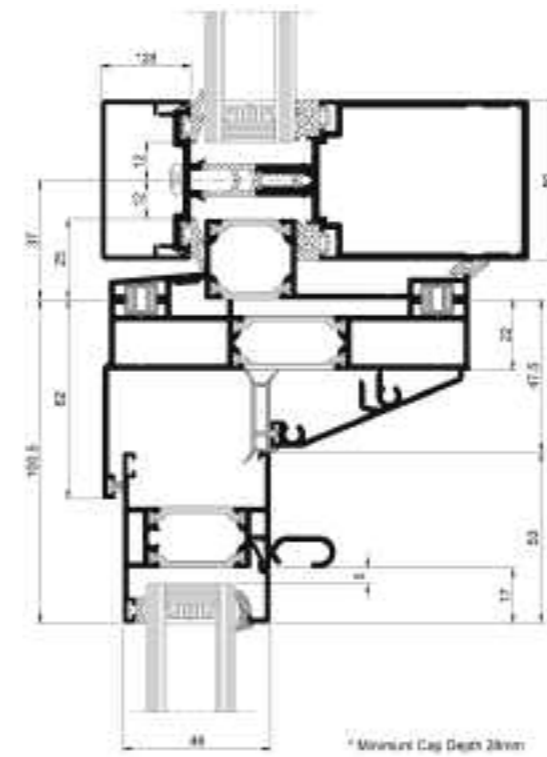

Cill Detail into Curtain Wall

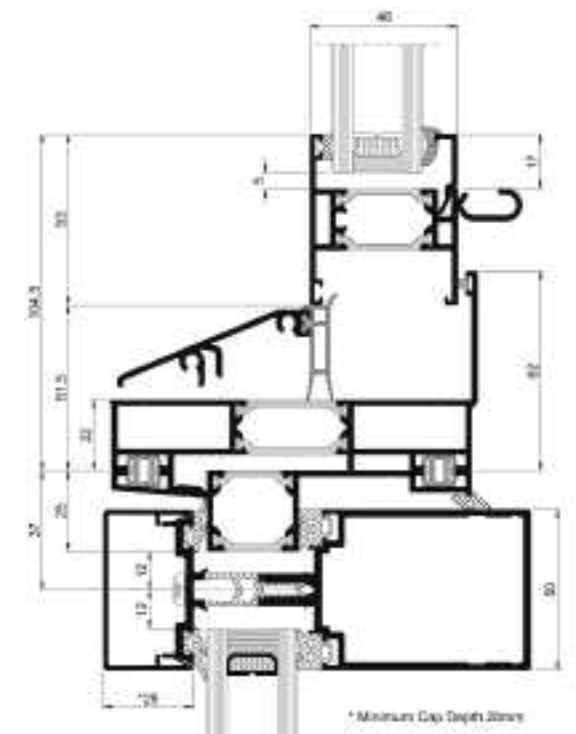

Supporting Your Projects



Authorities

- ISO 9001
Quality Management System
- BS EN 12020
Extruded precision aluminium profiles
- BS EN 12206-1
Paint and varnishes. Coating of aluminium and aluminium alloys for architectural purposes
- BS 3987
Specification for anodic coatings
- BS 6375 Part 1
Classification for weathertightness
- BS 6375 Part 2
Specification for operation and strength
- BS 4873
Specification for aluminium alloy windows and doorsets
- PAS 24
Enhanced security performance requirements for doorsets and windows in the UK
- BS 4255 Part 1
Specification for non-cellular gaskets

A full range of guaranteed colours available

Established in the UK for over 50 years and powder coating profiles at its Runcorn base for 40 years, Kawneer has deep knowledge and experience in the specification and application of colour and paint systems.

The existing powder coating facility was converted to 'chrome free' – the first existing plant in the UK to be upgraded to this environmentally friendlier pre-treatment system – which gave Kawneer additional impetus to become a QUALICOAT approved applicator.

Quality and consistency of quality continues to be the main feature of QUALICOAT UK & Ireland, which includes third party testing of all certified powder formulations and pre-treatment systems that make up the QUALICOAT approval process. Kawneer has achieved 'Seaside' specification standard with this third party accreditation programme.

Kawneer Permacover™ is a high quality polyester powder paint finish, offering a wide range of solid and metallic colours providing outstanding resistance to environmental conditions. Kawneer Permacover™ has a 15 year gloss and 30 year matt and metallic guarantees subject to application and Kawneer acceptance in marine, industrial, swimming pools or other aggressive atmospheres.

To ensure the highest quality finish, powder coating is carried out in house as part of our single-source responsibility.

Kawneer Permanodic® is a range of subtle anodised colours which have been specifically developed for architectural glazing systems. Kawneer Permanodic® is a tried and tested anodising process, proven in accelerated laboratory tests, extensive field trials and contract experience. Subject to compliance with Kawneer's requirements, a 25 year finishes guarantee can be obtained.

Project Assistance

Kawneer's regionally based team of Architectural Advisers and the Architectural Services Team based at our Head Office in Runcorn are able to provide project advice and support:

Tel: 01928 502604 / Fax: 01928 502512
Email: kawneerAST@arconic.com

Information on Kawneer's extensive range of Curtain Wall, Window, Framing, Door, Fire Resistant and Sliding Solutions can also be obtained from our Head Office by calling:

Tel: 01928 502612

Kawneer UK Ltd is part of Arconic Building and Construction Systems, and enjoys the extensive resources of the entire Arconic organisation, allied to the specific glazing systems experience of Kawneer's many operations around the world. As a result of this our partners and customers have direct access to one of the largest pools of technical expertise in the construction industry.

Kingston Riverside, London
Architect: Sprunt
Photo: Positive Image Photography

