

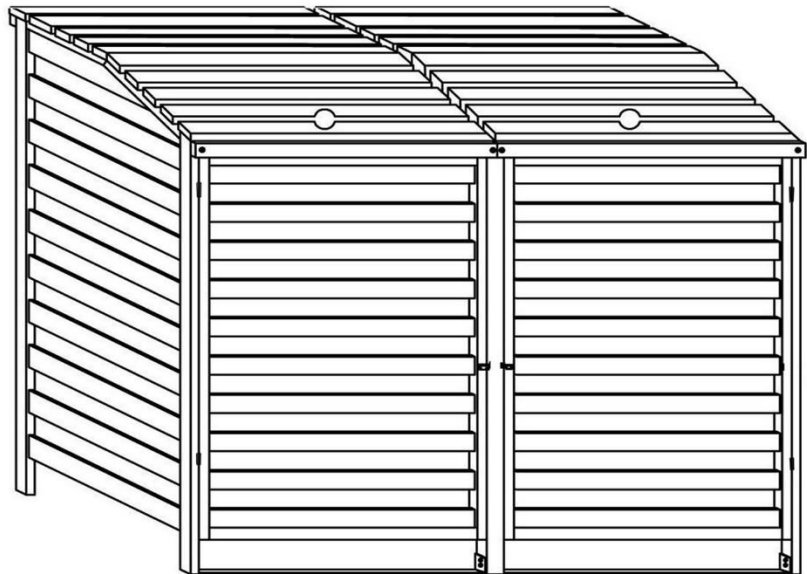

Please read all the instructions throughly before starting assembly .



INSTRUCTION MANUAL

Double Wheelie Bin Store

BG240D

Before Assembly

1. Check for damaged parts. Any part that appears damaged should be carefully checked to determine that it can be assembled properly and perform its function.
2. Install on flat level hardstanding surface.
3. Caution Sharp pointed screws. May be dangerous. Take care.
4. Not Suitable for small children. Do not allow children to play in, or near. Keep children away.
5. Always check for animals. Make sure animals don't get trapped.
6. Position in sensible well lit place to avoid tripping .

Timber, Safety and Care Instructions

Our product is manufactured from premium timber with great care in selecting machining and treating the timber before it is sold to you. Bear in mind that timber is a natural product and may experience changes throughout the course of its life. It may:

1. Develop openings (gaps, slits, apertures , cracks) along the line of the grain. This occurs due to moisture content between internal and outer surfaces of the timber. It is totally acceptable and will not affect the integral strength, life or guarantee of the product.
2. Over time the wood will fade in colour due to UV bleaching from sunlight, however this can easily be prevented with a yearly coat of your preferred wood treatment / wood stain.
3. Warp and distort its shape. Any distortion will be slight and will not affect the safety or enjoyment of this product.
4. This unit should be placed on flat level hardstanding surface away from heat source or fires.
Only use to store bins, not for storage of flammable materials/ gas canisters etc.
5. Prevent weathering by applying protective barriers to your timber via proprietary products to maintain its quality.

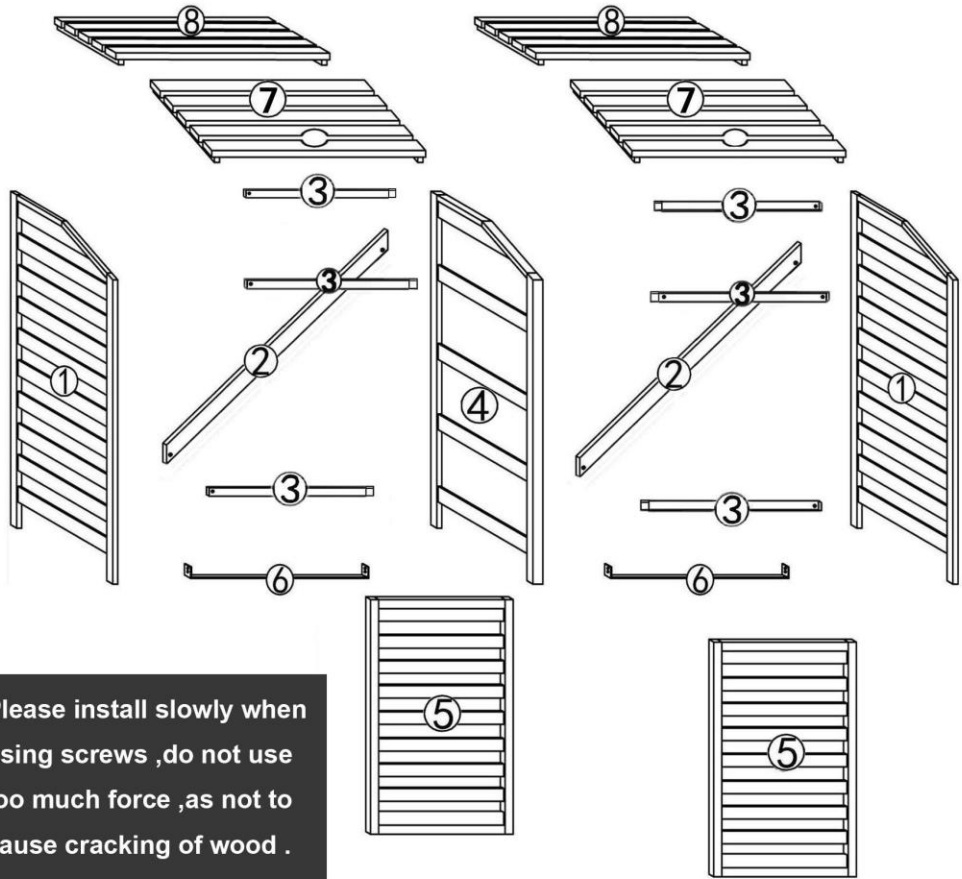
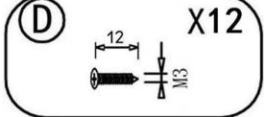
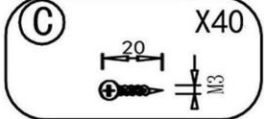
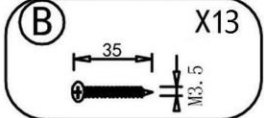
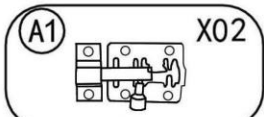

Please install slowly when using screws, do not use too much force, as not to cause cracking of wood.

01

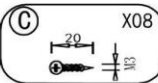
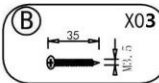

Erection Sequence

1st -- ⑥ 2nd -- ③

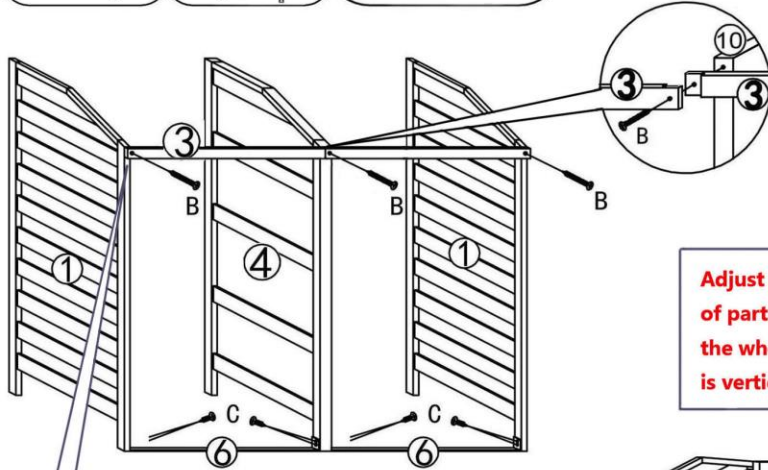

Adjust the position of part ② to make the whole structure is vertical.

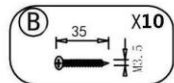

02

5mm

Please leave 5mm gap when assembling.

Please do NOT over tighten the screws to avoid crack.

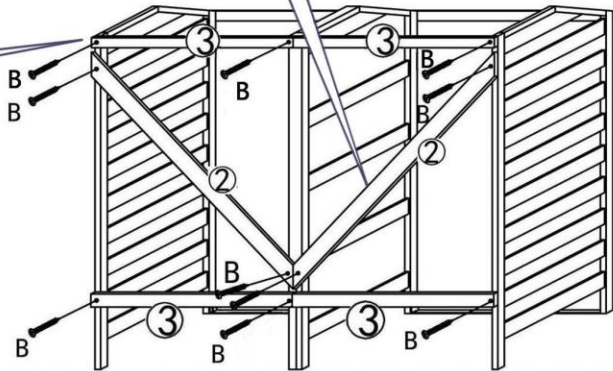

03

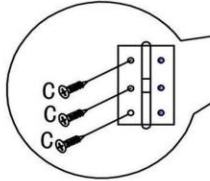
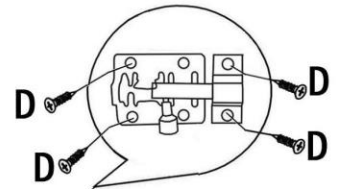
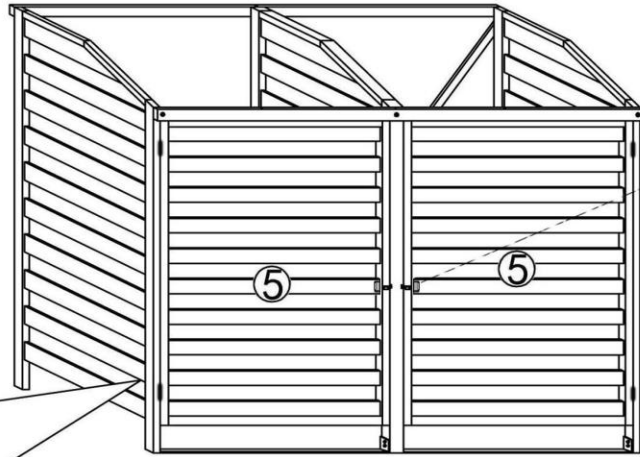
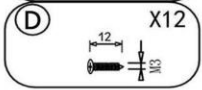
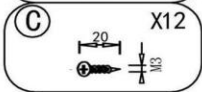
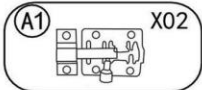

04

