

 **APP Engineering, Inc.**™
PRODUCT CATALOG



Featuring The
APP-601 Multifunction Recorder™
DFR, SER, DDR, PMU, PQ, TW, TIR



RECORDING EQUIPMENT & ACCESSORIES FOR

- Distribution –Sub-transmission –Transmission –Power Plants**
- Wind Power –Solar Power –Industrial Plants**

EXCEEDING NERC PRC-002-02

www.appengineering.com

Mission Statement

APP Engineering's mission is to become a leading provider of multifunction recording instrumentation and analysis software. In this quest, we pledge to provide high quality state of the art equipment and software, superior customer service, and competitive prices.

Our Profile

APP Engineering is an OEM (Original Equipment Manufacture) that specializes in the design, manufacturing, programming, and testing of multifunction recording instruments. Our equipment is primarily used by electric utility companies and large industrial plants to record power line interruptions, faults, disturbances, and power quality. APP Engineering is a customer oriented business with open access to top level management and product design engineers. The Directors of the company bring more than 65 years of combined experience as original equipment manufactures.

Our Quality Policy

APP Engineering, Inc. is committed to meeting customer specifications, customer satisfaction, quality of products, and on time shipments. We will achieve these by complying with the quality management system requirements of ISO9001:2015 and continually improving its effectiveness.

APP Engineering, Inc. is an ISO 9001:2015 - ANSI/ISO/ASQ Q9001-2015 & ISO 27001 Certified Company.

APP Engineering, Inc.
5234 Elmwood Ave
Indianapolis, IN 46203
Phone: 317-536-5300
Fax: 317-536-5301
Email: sales@appengineering.com
www.appengineering.com

Index

APP-601 MULTIFUNCTION RECORDER.....	4-14
SOFTWARE.....	15-16
APP RECORDER & APP CLEARVIEW (ANALYSIS SOFTWARE & COMTRADE VIEWER)	
SPLIT CORE CURRENT TRANSFORMERS.....	17
APP-601 RUGGED COMPUTER.....	18-19
(Use for master station computer or other applications)	
PORTABLE DFR.....	20
APP-702 COMPACT MULTIFUNCTION RECORDER.....	21-22
(Use for permanent installation or portable)	
APP-904 RUGGED KEYBOARD & MONITOR.....	23-24
APP-110 IRIG-B ANALYZER/GENERATOR.....	25
TRAVELING WAVE FAULT LOCATION.....	26-29
w/ TW BOARD & TW CLAMP ON CT	
SPLIT CORE TRIP INDICATING RELAY.....	30

MULTIFUNCTION RECORDER (DME) DFR, SER, DDR, PMU, PQ, TW, TIR



RUGGED COMPUTER CONTROL CHASSIS

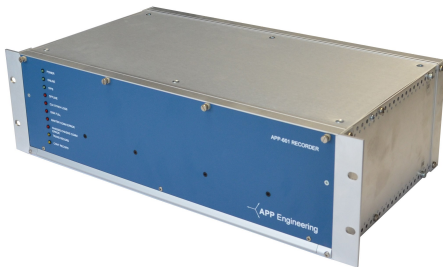

DATA CHASSIS - ANALOG & EVENTS



MONITOR & KEYBOARD CONSOLE
OPTIONAL

MORE VERSATILITY WITH THE APP-601 Recorder

- IP Addressable
- Distributed Or Centralized Architecture
- Expandable To Hundreds of Analog and Event Channels
- Reduced Chassis Depth (9.8")
- No Fans, Option for No Moving Parts
- Increased Operating Temperature Range
- Interoperability with APP-501 Recorder
- Tremendous Configuration and Integration Flexibility
- Multiple Data Chassis, One Easy To Retrieve Record
- Exceeds NERC PRC-002-02 & Regional Requirements
- Lightning and Distance to Fault Correlation
- Redundant Computer Control Option
- Traveling Wave Fault Location Option
- 61850 Goose Capture
- 61850 SV Subscribe



Centralized or Distributed Installation

Applications

- Transmission
- Generation
- Distribution
- Research
- Case studies
- Power Quality Monitoring

Features

Hardware:

- Main hardware
 - Computer Control Chassis (one/system)
 - Data Chassis (usually multiple/system)
 - Monitor & Keyboard Chassis (option)
- Distributed or Centralized architecture
- Place multiple data chassis in a single panel, disperse them among several panels, or different buildings while maintaining a single all encompassing easy to retrieve COMTRADE record.
- Independent data chassis operation, if one chassis stops the others continue to operate
- Ethernet based
- Easy expandability
- All chassis IP configurable
- Fiber optic interface option
- Fanless
- No moving parts (option)
- High operating temperature (option)
- Short data chassis depth (9.8”) for easy physical wiring, rack mountable
- Data aligned to 1PPS within 1usec
- Modulated or un-modulated IRIG-B
- Internal or external 1PPS
- Each analog channel can be configured for voltage or current input
- Wide voltage and current input range
- AC & DC Measuring
- Hot swappable cards
- Internally or externally wetted event cards
- Wide event card voltage range
- Pluggable event and alarm card connectors
- 8 output relays
- Easy plug and unplug power supply board
- Easy access power supply modules
- Easy access embedded computer board
- Excellent EFT and oscillatory immunity
- Simultaneous recording functions
- Traveling Wave Fault Location, Option

Features

Software:

- Windows OS: Win 10 Pro
- Option: Linux OS or Win Server
- Main Software Programs
 - APP Recorder
 - APP ClearView (master station software)
- APP Recorder runs as a service
- APP ClearView is the master station analysis software and can be run locally at the recorder and run remotely on the master station computer
- Communication and file transfer is between APP ClearView and APP Recorder
- Secure protocol between Recorder and Clear-view, password protections, and IP address permission settings
- Network, modem, DNP-3 communications
- Update APP ClearView from APP website
- Update recorder software via APP Clear-View (master station software)
- Simple and intuitive recorder and master station configuration
- Setup the recorder configuration locally or from the master station and download
- View real-time metering, oscillographs, and event status at the recorder or via RDP from the master
- Toggle the recorder power from ClearView
- Mappable Alarm Outputs
- COMTRADE records directly from recorder
- Many automatic task such as; Com Names file naming, PQDIFF format, diagnostics, calling, polling, emailing, pushing records via FTP, record backups, software updates, alarm reporting, trace file generation, and printing
- Many manual functions such as; calling, test run, reboot, reinitialize, and defrag
- File transfer feature allows master station user to delete, cut, copy, or paste any file at the recorder and allows any file transfer between master station and recorder.
- Event channels configurable as DFR, SER, or both.
- Multiple triggers per analog channel
- Cross Triggering Ethernet or Hardware
- Easy PMU Setup, Stream Multiple Line Groups
- IEC 61850 Goose Capture Digital into SER
- IEC 61850 SV Subscribe
- PQDIFF, DNP3, MODBUS
- Auto Instant Cellular Message, sends fault data via Telegram Messenger

Transient Oscillography Recording

Transient recording rates at 60 Hz are 2400, 4800, 9600, 11520, 15360, 16800, 19200, 24000, and 30720 Hz (at 50 Hz up to 25600 Hz). Voltages, currents, and events are recorded before, during, and after the fault. Each data sample is time stamped for convenient protection analysis, circuit breaker operation, clearance times, and waveform overlaying. Hundreds of Analog and Event channels can be simultaneously recorded and contained in a single record.

Transient records can be started by the following analog channel triggers:

- Voltage (over, under, both)
- Over current
- Frequency (over, under, both, step)
- Positive, Negative, and Zero Sequence
- THD
- Harmonics
- Active Power (over, under, both)
- Reactive Power (over, under, both)
- Impulse
- Magnitude
- Unbalance
- Rate of change for all
- Duration setting for all
- PQ: Voltage Sag, Swell, Dip, Surge
- Flicker
- Automatic post fault retriggering

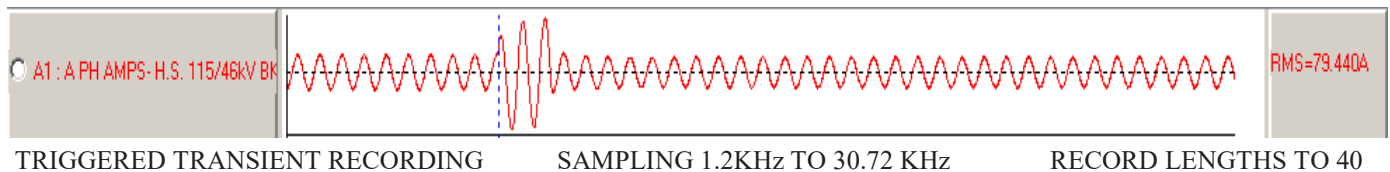

Extended Oscillography Recording

An extended oscillography record is generated each time the recorder trips and creates a transient record. The recording rates are 240, 360, 480, 720, 960, 1440, and 1920 Hz. The maximum record length is 40 minutes. Data is recorded before, during, and after the fault. This feature is useful for calculating a variety of power system quantities, re-close events, and stability status. APP ClearView zoom, drag & drop, and signal converting features allow for fine detail viewing and analysis.

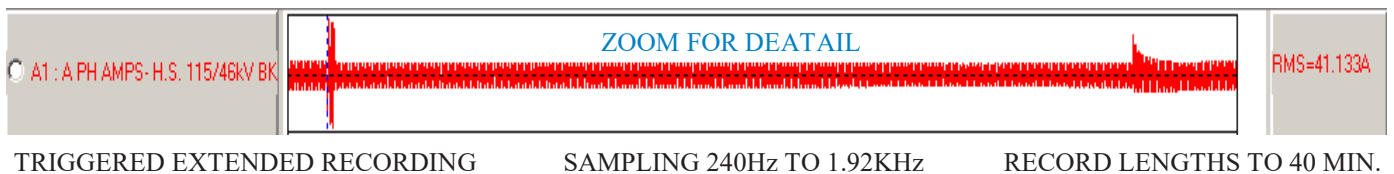

Extended RMS Recording

An extended RMS record is generated each time the recorder trips and creates a transient record. Analog inputs are sampled at 1 sample per cycle or slower. This RMS file is smaller in size and can be retrieved faster than the extended oscillography. Data is recorded before, during, and after the fault.



Continuous RMS, Frequency, and RMS + Phase Recording

All three recordings are enabled with a single setting. Data is recorded up to 99 days in a circular buffer. The user can retrieve any time slice over the recorded period. All channels or specific channels can be retrieved. Subtle events that may not have tripped the recorder can be retrieved and analyzed. By retrieving Phase + RMS data information such as apparent power, active power, reactive power, power factor, and phase impedances can be derived for long periods of time.

Files are automatically packed in COMTRADE format and named using the IEEE Com Names convention. Many APP ClearView features are available for fine detail viewing and analysis. After retrieving records, the Y-Scale can be changed to view very small deviations in RMS, frequency, or phase values.

As shown, Y-Scale set to “optimize” for displaying small changes in amplitude

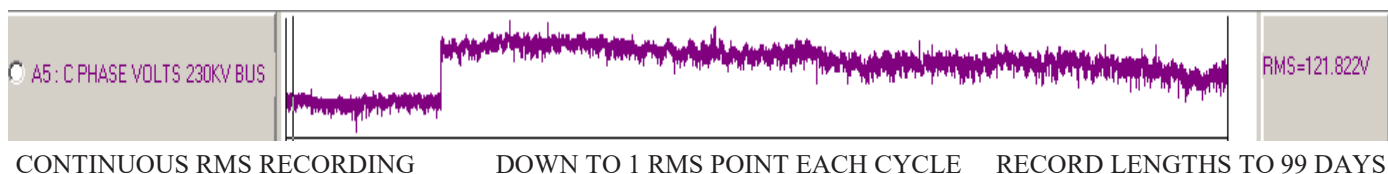

ZOOM FOR DETAIL

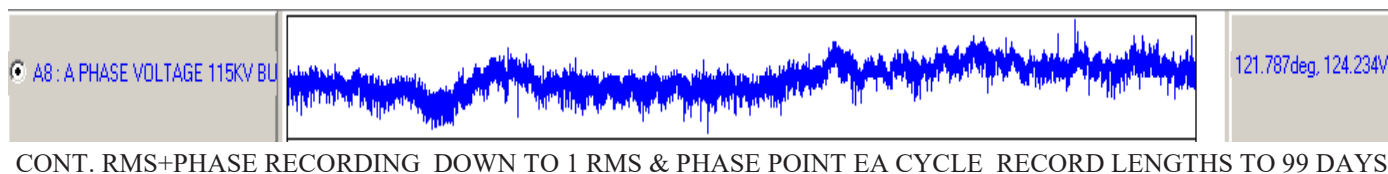
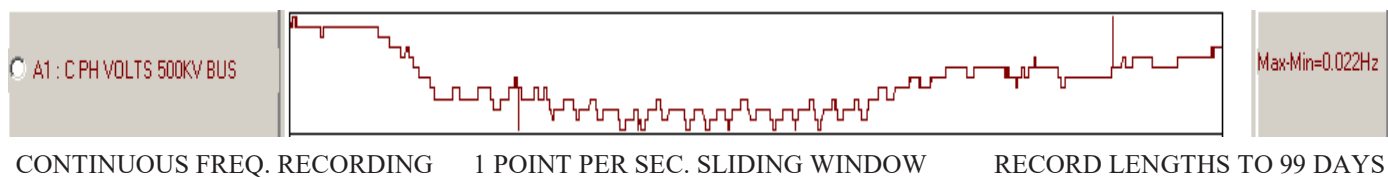

Continuous Oscillography Recording

Continuous oscillography recording rates are 240, 360, 480, 720, 960, 1440, and 1920Hz. Data is recorded in a circular buffer having a typical period of 14 days. The user can retrieve any time slice over the recorded period. All channels or certain channels can be retrieved. Subtle events that may not have tripped the recorder can be retrieved and analyzed. Power and impedance values can be derived. Files are automatically packed in COMTRADE format and named using the IEEE Com Names convention. Many APP ClearView features are available for fine detail viewing and analysis.



Continuous Trending RMS and Frequency

Trends for these 2 continuous recording functions can be recorded for up to 99 days. The user can retrieve any trend time slice for the recorded period. All channels or specific channels can be retrieved. Maximum, Average, and Minimum trend plots are available for the continuous RMS, and Frequency recordings. If a user retrieves trend data they will view 3 plots (Maximum, Average, and Minimum) per channel. As shown below, the Y-Scale in the analysis software can be adjusted to show small changes in amplitude. Daily trend files automatically converted to a COMTRADE record at the end of each day.

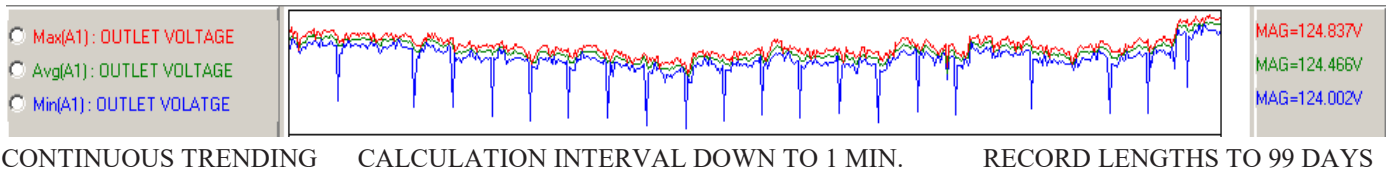

Continuous One Cycle Snap Shot

For your power quality personnel, the APP-601 Recorder can capture a one cycle snap shot every minute (adjustable) at the transient sampling rate. This steady state information can be retrieved and viewed with APP ClearView or any other 3rd party power quality software. The systems ability to automatically put this information in PQDIFF format is useful for viewing with commercially available power quality software. Data is recorded in a circular buffer for up to 99 days. All channels or specific channels can be retrieved.

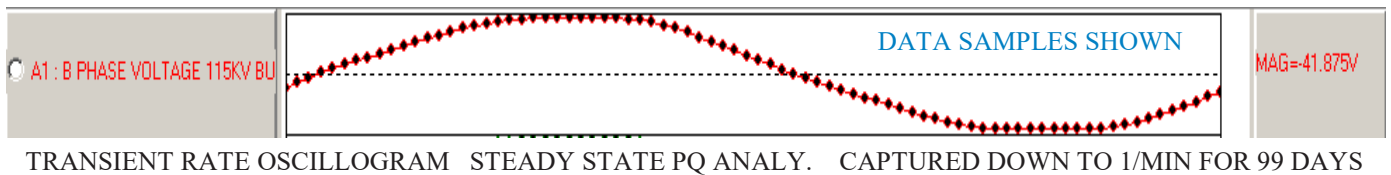

Continuous: Flicker, Harmonics, Unbalance, PQ, MW, MVAR

For your power quality personnel, the APP-601 Recorder can capture Flicker, Harmonics, Unbalance, MW, MVAR and other data once every 10 minutes.

- Flicker (IEC 61000-4-15), P_{ST} Up To 1620 CPM, (13.5Hz)
- Harmonics (IEC 61000-4-7), Max up to 13th and THD, with Max/Avg/Min Plots
- Unbalance (IEC 61000-4-30), 0seq/+seq, with Max/Min/Avg Plots



Hardware Choices (APP-601)

APP-601 DATA CHASSIS

APP-601 COMPUTER CONTROL CHASSIS

APP-904 SLIDING MONITOR & KEYBOARD Console

#1



+



+



- DATA ACQUISITION CHASSIS
- HIGH TEMP RATING
- NO MOVING PARTS
- UP TO 30 ANALOG or 80 EVENT CHANNELS OR MIXTURE, SAMPLE RATE DEPENDENT
- SHORT 9.8" DEPTH
- 1 OR MORE PER SYSTEM
- 3RU

- COMP. CONTROL CHASSIS
- INDUSTRIAL COMP BOARD
- 3x DRIVE BAYS
- RAID 1 HARDWARE CONTROLLER WITH HOT SPARE
- 3X 1TB HDD'S OR SSD OPTION
- MAX 324 ANALOG CH. PLUS HUNDREDS OF EVENTS CH.
- SHORT 9.8" DEPTH
- NO FANS
- SURGE PROTECTED
- HARDENED
- ONE PER SYSTEM
- OPTION: 2ND FOR REDUNDANCY
- 3RU

- OPTIONAL HUMAN INTERFACE
- SLIDE OUT MON. & KEYBRD.
- FLIP UP MONITOR 12.1"
- NO FANS
- SHORT DEPTH
- THREE MONITORING DEPTHS
- 1RU



APP-601 DATA CHASSIS

APP-501 COMPUTER CONTROL CHASSIS

#2

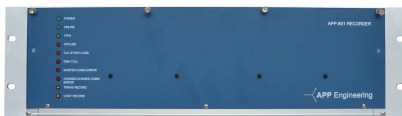

+

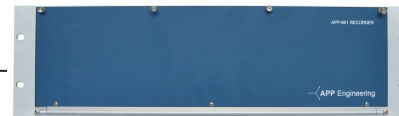

- SAME AS #1

- COMP. CONTROL CHASSIS
- INTEGRATED NOTEBOOK
- INTEGRATED HMI
- PROCESSOR WITH FAN
- 1TB HDD MINIMUM
- SOLID STATE DRIVE OPTION
- HIGH PROCESSING SPEED
- CAPABLE OF RECEIVING DATA FROM HUNDREDS OF ANALOG & EVENT CHANNELS
- LONGER DEPTH 14.6"
- NO EXTENDED TEMP OPT.
- ALL PORTS SURGE PROTECTED
- HARDENED AND FIELD TESTED
- ONE PER SYSTEM
- 3RU



Chassis Layout (APP-601)

APP-601 Computer Control Chassis

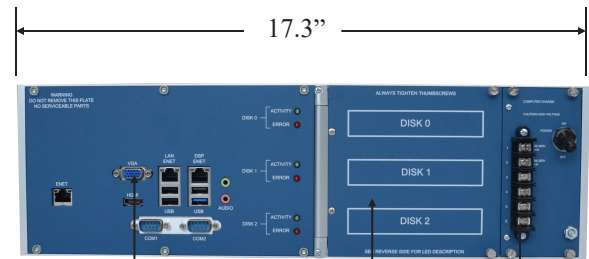
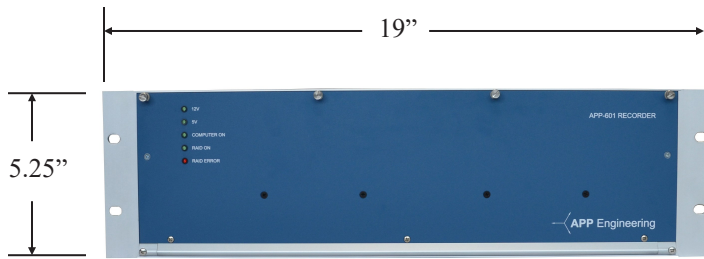

PORTS
ENET(3), HDMI,
USB (4), VGA,
COM (2), AUDIO

DRIVES
3 BAYS, RAID 1,
PLUS HOT SWAPPABLE,
PLUG & PLAY

POWER
120VAC
125VDC
250VDC
See spec.
page for
ranges

APP-601 Data Chassis

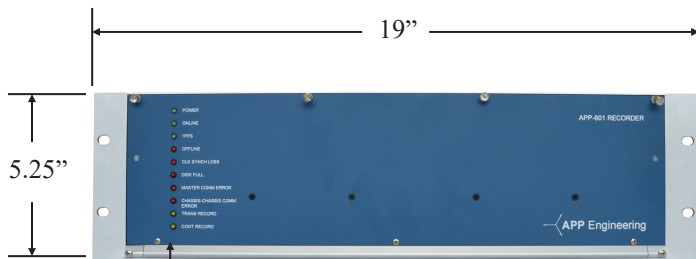

STATUS LED'S

- 10 slots available for Analog or Digital Cards (slots 1-6, 8-11)
- Fill with all Analog Cards for 30 Analog Channels
- Fill with all Digital Cards for 80 Event Channels
- Mix the chassis with a combination of Analog & Digital Cards
- Analog Cards have 3 channels configurable for voltage or current
- Event Cards have 8 channels & pluggable connector
- DSP Card is fixed in the 7th slot
- Alarm Card is fixed in the 12th slot (8 relay outputs)
- Traveling Wave Fault Location Board Option (not shown)
- Sample rate can impact number of analog cards
- Power 120VAC, 125VDC, 250VDC (see spec. page for ranges)

SAMPLE SHOWN

Notes - Power Supply Card in Slot 13

- Term 1 & 2 Power Input Universal
- Term 3 & 4 Power Out for Enet Switch
- Term 5 & 6 Power Out for Comp Chassis

A complete system can have hundreds of analog and digital channels

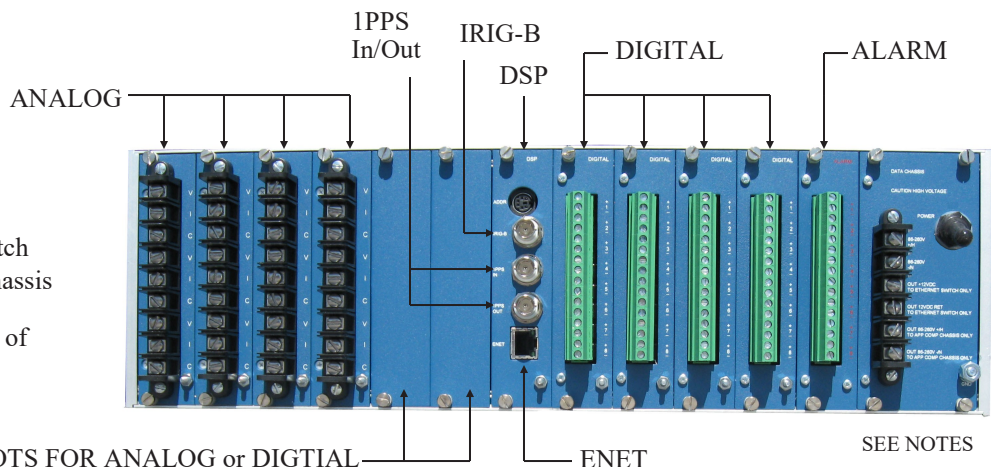

Configurations (APP-601)

Distributed

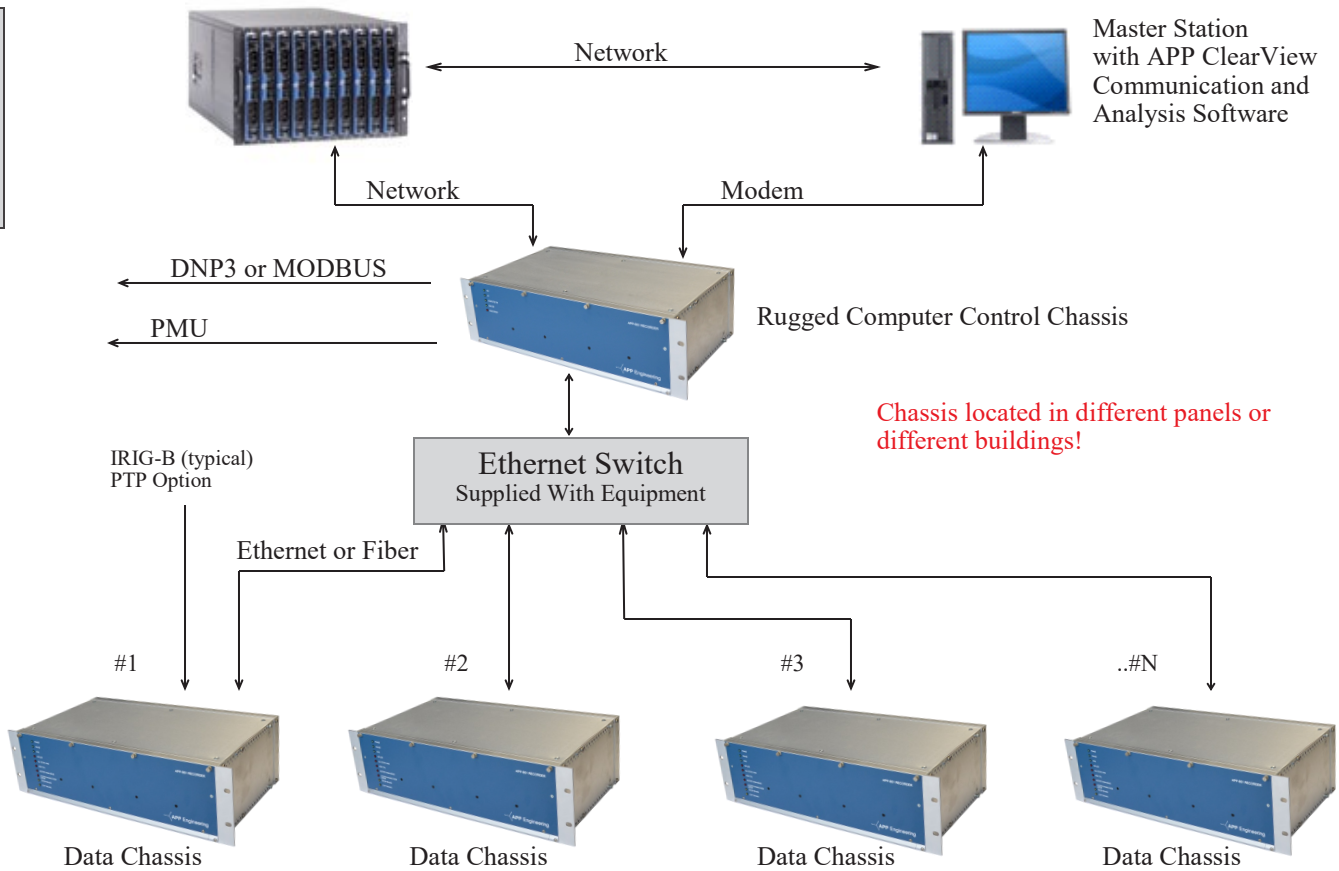

Centralized

Chassis can be arranged with a mixture of centralized and distributed architecture

All or majority of chassis located in the same panel

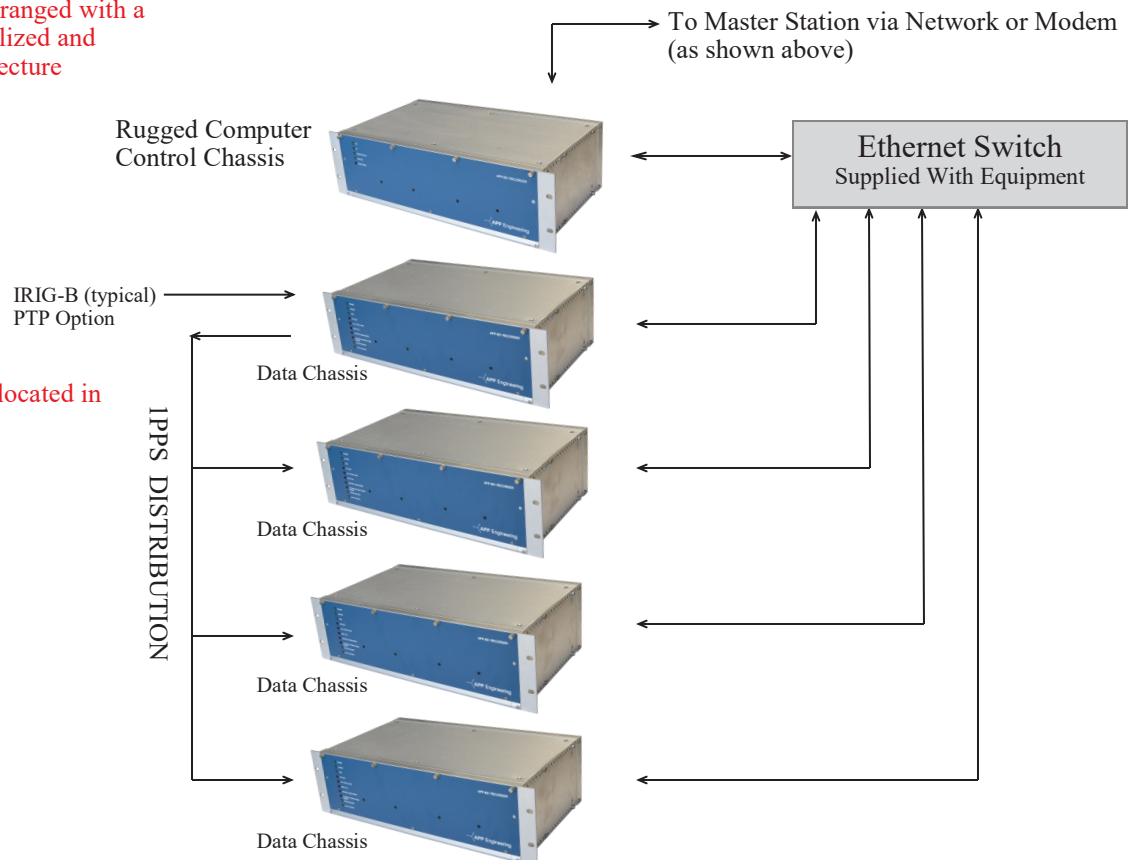

Configurations (APP-601)

Turn-key

Reduce installation time and cost by purchasing a turn-key system.

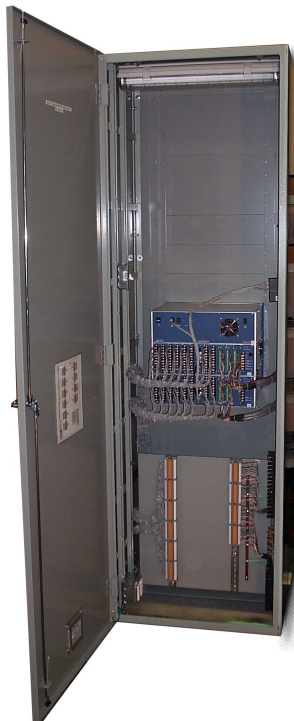

- Any cabinet or panel size
- Manufactured to your specifications
- Analog terminal blocks: straight strap, sliding link, or knife blade
- Event terminal blocks: straight strap, sliding link, or knife blade
- Test Switches
- Lights
- Convenience Receptacles
- Complete Wiring
- Complete software setup
- Comprehensive Testing
- Quick Turn
- Affordable
- Wall Mount Enclosures Available

Specifications (APP-601)

Analog Channels

Voltage:

Up to 30 analog channels per chassis
Up to 440VAC Max
AC or DC Input
Burden 0.045VA@67V, 0.144VA@120V
Accuracy 0.15% of reading + 0.005% of range (typical)

Current:

2mΩ Internal Shunt
Burden 0.05VA@5A, 0.45VA@15A
15A RMS Continuous
140A RMS for 2 sec, 250Arms for 1/2 sec
Accuracy 0.61% of reading + .005% of range (typical)

General:

16 Bit A/D
Data aligned with 1PPS rising edge
Ch to Ch phase angle error <0.004°
Cut-off frequency (-3db) 5KHz
Common Mode Rejection 80dB Min
Temperature Error 70ppm/°C
Channel to channel isolation 3500VDC
Channel to ground isolation 3500VDC

Event Channels

Up to 80 event channels per chassis
Standard input operating range 45-250VDC
(Option 24VDC available)
(Option Cards with Internal Wetting Voltage)
Channel to channel isolation 3500VDC
Channel to ground isolation 3500VDC

Power Supply

Voltage Range: 86 to 370 VDC and
88 to 264 VAC
Frequency Range: 47 to 63 Hz
Overload, Over Voltage,
Over Temperature Protection
Power @ 125VDC and 54 analog channels
and 96 event channels is approximately 140W
Input to ground isolation 3500VDC

Timing

Modulated or Un-modulated IRIG-B
Data aligned to 1PPS within 1usec
1PPS in/out chassis to chassis
Internal 1PPS backup
PTP Option

Communications

Recorder to Master Station Com:

TCP/IP Ethernet 10/100
Fiber (option, Multi or Single Mode)
Modem

Chassis to Chassis Com:

Ethernet 10/100
Fiber (option, Multi or Single Mode)
DNP3/Modbus Com: TCP/IP or RS232
Modbus Com: TCP/IP
PMU Com: Ethernet or RS232
(TCP,UDP,UDP-T,UDP-U)

Status Relays

8 alarm outputs, N.O. or N.C, SPST
Contact ratings: 10A Cont. & Break 0.5A @
125VDC, Break 0.35A @ 250VDC,
Dielectric 5KVac

Alarms (Mappable)

Power, Online, Offline, Clock Sync Loss,
Chassis to Chassis Comm., Master Comm.,
Disk Full, Temperature, Computer,
Transient Record, SOE Record, Disturbance
Record, Continuous Record, Analog Ch,
Comp Health (additional outputs available)

Enclosure

19" Rack x 5.25"H x 9.8D"
(Note, APP-501 Comp Chassis is 14.6" Deep)
Many cabinet/panel sizes available

Compliant Standards

ANSI/IEEE C37.90.1 (Surge Withstand)
IEC 61000-4-2, 4-3, 90.2 (RF Immun., Keying)
IEC 61000-4-17, 90.3 (ESD)
IEC 60255-22-1 Cat III (Osc.)
IEC 60255-22-4 Cat IV (EFT)
IEC 60255-5 (Isolation, Impulse Cat III)
IEC 60068-2 -1 (Cold)
IEC 60068-2-2 (Hot)
IEC 60068-2-30 (Damp Heat)
IEC 61000-4-17 (Pwr. Immunity)
IEC 61000-4-5 (Surge DC Ports)
IEC 61000-4-6:2008 (Immun./Cond. RF)
IEC 61000-4-8 & 4-10 (Mag Field Immun.)
ANSI/IEEE C37.111 (COMTRADE)
ANSI/IEEE C37.232-2007 (Com Names)
IEEE C37.118-2011 (PMU)
Plus More

Environment

Standard temperature range 0 to 55° C
Limiting factor is the computer HDD
Extended temperature option -25 to 70° C
Data Chassis -25 to 70° C standard

Specifications (APP-601)

System Computer Options

APP-601 Computer Control Chassis

Intel Atom Processor Quad-Core
4GB DDR3-1600 RAM
3x SATA-300
Drives Plug and Play, Hot Swappable
3x 10/100/1000 Mbs Ethernet Ports
1x VGA, 1x HDMI
1x Line Out Audio
3x USB 2.0, 1x USB 1.0
RAID 1 plus Hot Spare
Temp Range -20° to 70° C w/ SDD
Power Requirement: 25W 3x HDD, 125VDC
Voltage Range: 86 to 370VDC, 88 to 264VAC
Processes up to 324 Analog Channels
(limitations may apply)
OS: Win10 or Win Server or Linux



APP-601 Computer Chassis

Or

APP-501 Computer Control Chassis

With Cooling Fan
Notebook Computer - Surge Tested
Intel 4-Core 2GHz, 800MHz Buss
4GB RAM or better
1TB HDD Typical for OS and Data
Solid State Drive Option
Processes at least 220 Analog Channels
1x Ethernet 10/100, 1x Ethernet Converter,
1x USB Rear, 3x USB Internal, 1x RS232 Rear
Internal Modem, Integrated 14" Monitor
Integrated Keyboard and Touch Pad
Std Temp Range 5 to 55° C, No Battery
See Picture on Hardware Choices Pages

Optional Monitor & Keyboard Specs

APP-904 Monitor & Keyboard Console

Console, 1RU, (1.75") 19" Rack Mount, 13" Deep
Three Available Mounting Depth, Flush Mount, 2"
Mount, 3.5" Mount,
2", and 3.5" allow for greater monitor tilt angle
Rear Ports: 1 USB Type A, 1 LVI-D, 1 VGA, 1 Three
Pos Power Terminal Block
Universal Power Input 86-370Vdc, or 88-264Vac, 17W
Power Input Frequency Range 47Hz to 63Hz
Operating Temperature Range -25C to 70C
Storage Temperature Range -30C to 80C
Humidity 0 to 85% Non-Condensing
Pull out drawer with 12.1" flip up Industrial TFT, High
Brightness, XGA Monitor, 1024 x 768 Res
Waterproof, Washable Membrane, 104 Key US Layout,
with Touchpad
Auto Power-Off via Windows OS
Convenient Front Grip Handle
Easy Glide Ball Bearing Slides



APP-904 Monitor & Keyboard Console
Optional

Other Recorder Options

Redundant Computer
Extended Temperature Range
Satellite Controlled Clock For Multiple IED's
Traveling Wave Fault Location (Board and CT's)
Computer Upgrade
External HDD or Flash Disk
Recorder Printer
Fiber Optic Chassis To Chassis Interface
Portable Configuration
Clamp On CT
APP ClearView™ Multi-User License
Master Station Computer
Extended Warranty
Service Contract

Software APP Recorder™

The APP Recorder™ Program provides another means for human interface, controls the functionality of the Recorder, and includes many features to make setup quick and easy. APP Recorder runs as a system service. It automatically starts when the recorder is powered up, and automatically restarts if a user exits the program. Permissions, passwords, administrative rights, and allowable IP addresses can be setup to limit access to important settings and sensitive information. Major duties of the APP Recorder program are listed below.

View		Configure	
Fault number	Event Status	Point assignments	Auto-Call-In
Recorder Settings	Analog Trigger Status	Line groups	Passwords
RMS Metering	SER Log	Printing	Emailing
Frequency Metering	Communication Status	Directories	FTP
Phase Metering	Distance to Fault	Auto Backups	PMU

The screenshot shows the APP Recorder software interface. At the top, there's a menu bar with 'File', 'Edit', 'Connect', 'Maintenance', 'Continuous Recording', 'Tools', and 'Help'. Below the menu bar, the title bar reads 'Company - XYZ Plant'. The main window is divided into several sections:

- Status Bar:** Shows 'DISK: 654.1G Free', 'Alarms: OFF', and 'Monitoring income call thru Network'.
- Recorder ID:** 0001
- Next FID:** 12
- #Analog:** 84
- #Events:** 144
- #Triggers:** 150
- DNP3:** ON
- Transient:** ON
- Frequency:** 4800 Hz
- Prefault:** 160 ms
- Postfault:** 500 ms
- Fault Limit:** 500 ms
- Extended:** ON
- Frequency:** 960 Hz
- Prefault:** 10 s
- Postfault:** 10 s
- Fault Limit:** 10 s
- Cont. Oscillograph:** ON
- Frequency:** 960 Hz
- Storage:** 14 days
- Cont. Freq.RMS.Ph:** ON
- #Cycles/Point:** 2
- Storage:** 30 days

Below these settings is a table with columns: Analog Channel Description, RMS, Frequency, and Phase - Phase(A1). The table contains 7 rows of data for various units (A1 through A7).

Analog Channel Description	RMS	Frequency	Phase - Phase(A1)
A1:Unit 4 G5U High Side Va	122.596 V	60.008 Hz	0.000 udeg
A2:Unit 4 G5U High Side Vb	122.819 V	60.008 Hz	0.000 udeg
A3:Unit 4 G5U High Side Vc	122.927 V	60.008 Hz	0.000 udeg
A4:Unit 4 G5U High Side Ia	5.117 A	60.008 Hz	27.467 mdeg
A5:Unit 4 G5U High Side Ib	5.114 A	60.008 Hz	-10.987 mdeg
A6:Unit 4 G5U High Side Ic	5.119 A	60.008 Hz	27.467 mdeg
A7:Unit 4 G5U High Side In	42.941 mA	131.068 Hz	-133.263 deg

At the bottom of the interface, there's a timestamp: '03/09/2018-16:25:30.000000' and a status bar with 'For help, press F1'.

All critical settings can be configured locally or remotely and downloaded

Easy single click software updates via APP ClearView

View real-time phase voltages and currents, analog triggers, event status, and perform any required calibration with the "Oscope Function"

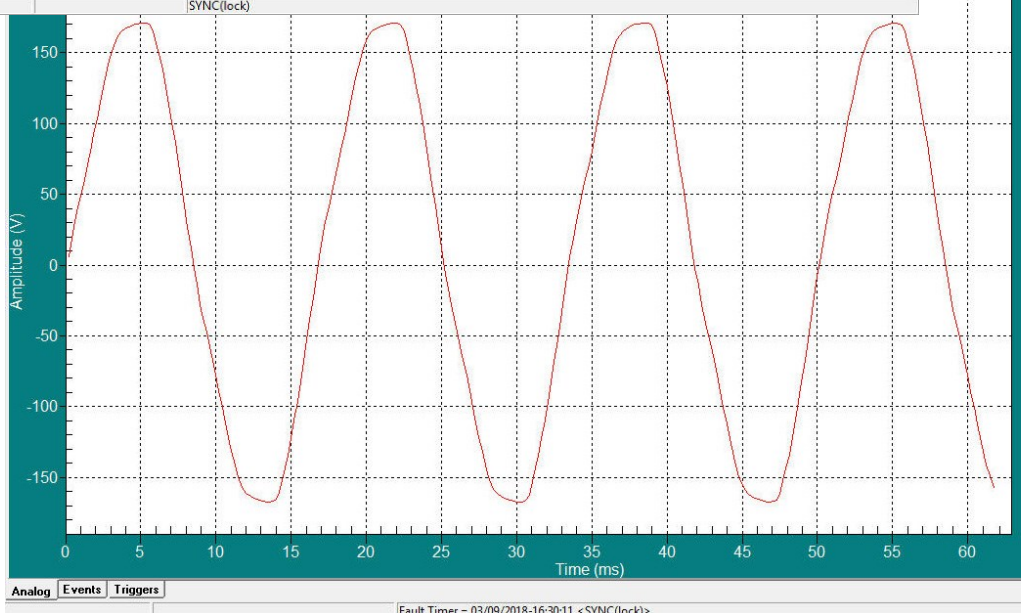

The control panel for the oscilloscope function includes the following settings and controls:

- YScale:** Radio buttons for 'Full Scale (113.00V)', 'Abs. Full Scale (191.35V)', and 'Optimized'.
- Meter:** Radio buttons for 'Primary' and 'Secondary'.
- RMS:** 122.8880V
- Offset:** 0.0055V
- Show Analog Channels:** Chassis#: 1, Analog Channel #: 1, Sequence Of: 1, Show #Cycles: 04.
- Calibrate Offset:** Buttons for 'Calibrate' and 'Un-Calibrate'.
- External Calibration (Slope):** At Secondary: 100 V, Slope Calibrated.
- Calibrate Phase (for Post-Proc):** Ref: A1, 0.000 deg, buttons for 'Calibrate' and 'Un-Calibrate', and a 'Show' checkbox.
- Buttons:** 'Running...', 'Stop', and 'One Shot'.

Software APP ClearView™

One of APP Engineering's premier strengths is our ability to provide time saving, valuable, and user-friendly software. Years of experience in software development, logical algorithm formulation, engineering, mathematics, and customer service, has given us the tools to provide world class software solutions. Our commitment to provide software that is truly valuable is enhanced by our ability to respond quickly to customer requested changes and upgrades.

The APP-601 Recorder™ includes our APP ClearView™ Program and our APP Recorder™ Program. The APP ClearView™ program is run on your master station computer and it is loaded on the recorder for "on the spot" record review and analysis. Use this software to not only view COMTRADE records from your APP Recorder but open any COMTRADE record for viewing and analysis. The APP ClearView™ Program will run on Windows 95, 98, NT, 2000, XP, Vista, 7, 10, or Server. Call or email us today for a demo version of APP ClearView.

APP ClearView™ -summary table

View	Configure	Functions
Fault number	Printing	Easy station selection
Triggered channels	Directories	Manually retrieve data
Fault date	Backups	Auto retrieve data
Fault time	Auto polling	Test runs
Synch status	Passwords	Diagnostics
Event reports	Emailing	Time check
Fault location	Phone numbers	Time synch
Polling report	IP addresses	Recorder restart
Recorder config	Point assignments	Recorder updates
Comm. status	Line groups	Sorting
	Recorder setup	Analysis

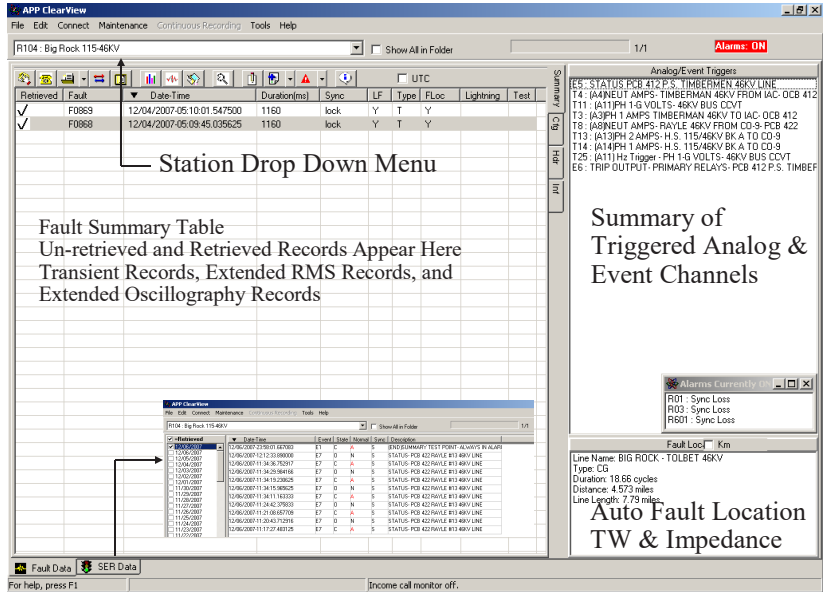

JUST DOUBLE CLICK ON A RETRIEVED FAULT RECORD AND SEE THE DATA IN THE GRAPHICS SCREEN

POWERFUL FAULT ANALYSIS SOFTWARE

APP ClearView™ -analysis

Highlights

Quick viewing of retrieved records
Open any COMTRADE record
Overlay or merge 2 records
Re-Save data in binary or ASCII
Multiple setups for viewing channels
Drag & drop waveforms
Convenient screen resizing
Versatile digital viewing
Easy zoom in, zoom out, Y-scale setup
User annotation drag & drop
Extended printout capabilities
Export

Measurements & Math

Magnitude, RMS, DC, Phase
Frequency, Peak, Average,
Max, Min, Max-Min, Positive
Sequence, Negative Sequence,
Zero Sequence, Add, Subtract,
Invert, Phase shift, Wide Variety
Of Math Functions, FFT,
Vector, Delta Measurements,
Cut, Copy, Paste, Filter Harmonics,
Double Ended Fault
Location

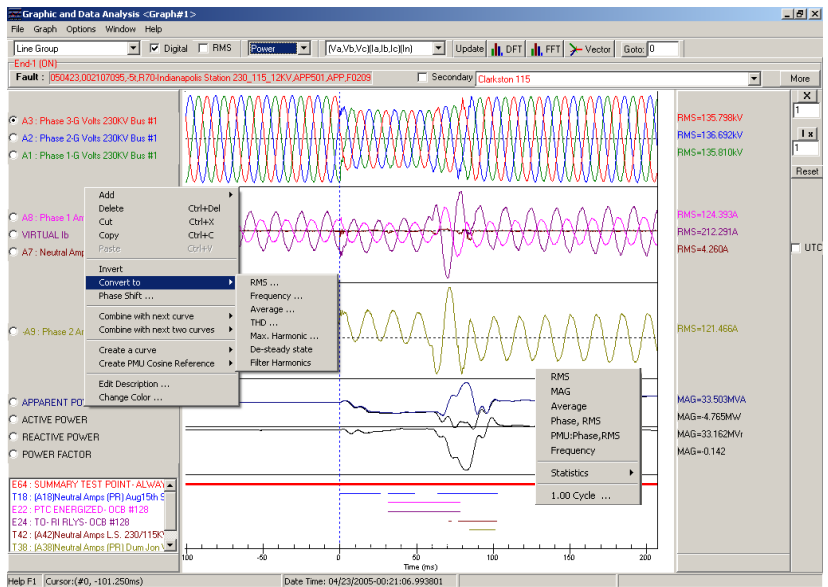
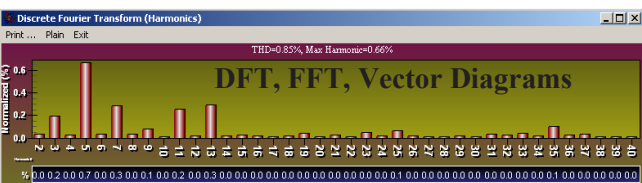

Drag & Drop Waveforms, Open Any COMTRADE Record, Open Multiple Graphics Screens Simultaneously

APP-00848 Split Core Current Transformer™

Applications

- √ Sub-metering
- √ Power Monitoring
- √ Current Measurements
- √ Over/Under Current Sensing

Features

- √ High Accuracy
- √ Low Phase Angle Error
- √ Small Size
- √ Nickel Alloy Core
- √ Removable Leg

Specifications

Standard: 5A=0.5V
 Accuracy: 0.5A to 100A 0.6% @ 60Hz
 Continuous Rating 100A
 Maximum Current 130A
 Max Phase Angle Error: +/-60min @ 60Hz
 Voltage Rating: 600VAC
 Bandwidth: 40Hz to 1KHz
 Operating Temperature: -20°C to 50°C
 Operation: Indoor
 Case Material: ABS Thermoplastic
 Removable Leg Screws: Knurled Nylon
 Overallsize: 2”H x 2.5”W x 1”D
 Conductor Thru Hole Diameter: 0.4”
 50’ Twisted Leads
 Black Wire Pos. W/ Arrow Towards Current Source



Ordering Information

Part Number = APP-00848-500mV
 Output with 5 Amps Through the Primary

APP-00848 Clamp On CT

Tested from 0.5A to 120A @ 60Hz
 Tested and Calibrated with EXTERNAL 100KΩ and 50nF
 to Simulate DFR Analog Channel Input

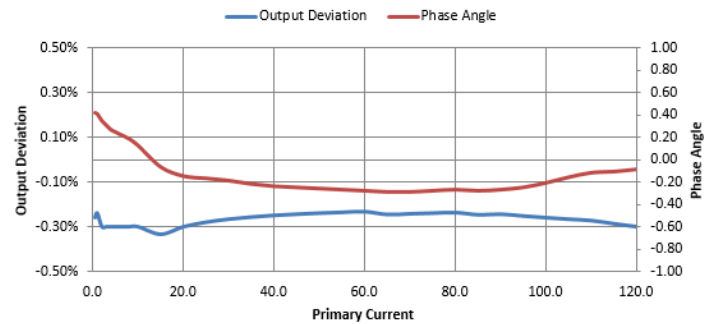

Assembly P/N: APP00849 for 5A=500mV

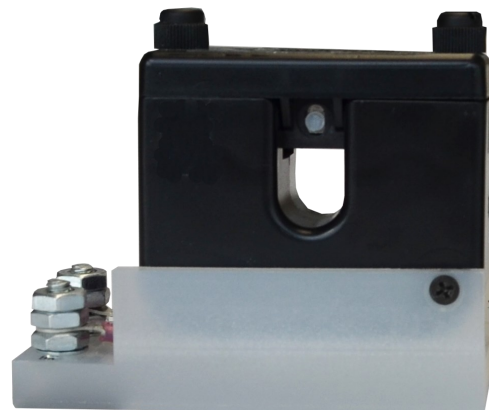

Assembly P/N: APP00851 for 5A=500mV

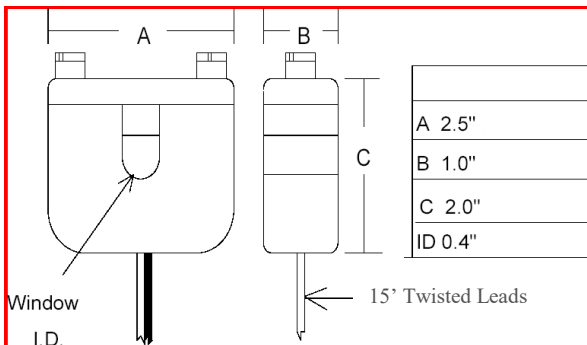

Notes

- Internal resistors are 1/4W.
- Longer lead lengths available.
- Removable leg contains a lapped spring loaded core that mates with the precision core in the main housing.

APP-601 Rugged Computer Chassis™

APP601-C601-00A-00E-N

SIDE VIEW

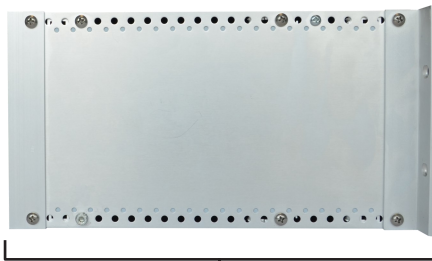

9.8"

FRONT VIEW

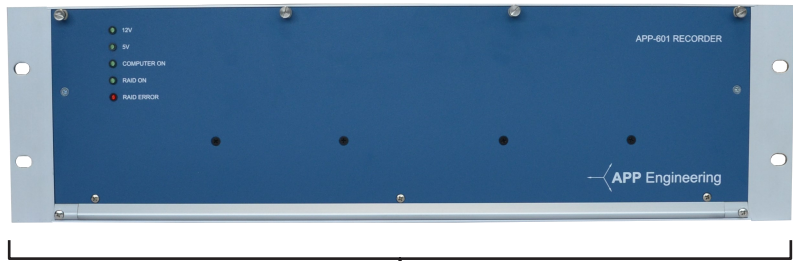

19"

REAR VIEW

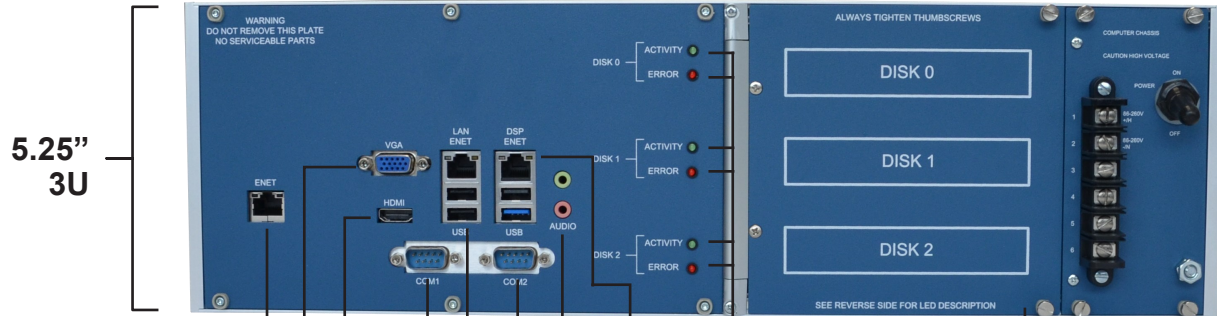

5.25"
3U

Ethernet

VGA

HDMI

RS-232

Ethernet & 2x USB

RS-232

Line-Out & Mic-In

Ethernet & 2x USB

Activity and Error lights for HDDs for easy monitoring and management

Hinged door access to HDDs for easy plug and play maintenance. RAID 1 + Hot Spare

MEETS OR EXCEEDS

- IEEE C37.90.1:2002 (Surge)
- IEC 60255-22-1:2005 (Osc.)
- IEC 60255-22-4:2002 (EFT)
- IEC 60068-2-1 (Cold)
- IEC 60068-2-2 (Hot)
- IEC 60068-2-30 (Damp Humidity)
- IEC 61000-4-6:2008 (Immunity Conducted RF)
- IEC 60255-5:2000 (Impulse, Dielectric, Insulation)
- IEEE C37.90.3-2001 (Electrostatic Discharge)
- IEEE 1613-2009 (100mm Free Fall)
- IEC 60255-21-1:1988 (Vibration)



Use for recorder computer, master station computer, security camera computer or other computer applications.

APP-601 RUGGED COMPUTER CHASSIS TM

SPECIFICATIONS

P/N: APP601-C601-00A-00E-N

CPU	Intel Atom processor E3845 quad core
System Memory	8GB DDR3-1600 RAM
Chipset	System-on-Chip integrated; Intel HD Graphics; Shared System memory; Display interface 1 x VGA, 1 x HDMI
BIOS	American Megatrends Inc. BIOS
Supported OS	Windows 7; Windows 10; Windows Server or Linux
Power Input	86-264Vac (50Hz/60Hz) or 86-370Vdc Computer auto power on AC/DC power
Power Requirements	25W (using 3 x 2.5" hard drives) @ 125VDC
Dimensions and Weight	19" (483mm)(W) x 5.25" (133mm)(H) x 9.8" (249mm)(D); 3U 12lbs (5.4kg)
Operating Temperature	-20°C ~ 70°C (-4°F ~ 158°F)
Relative Humidity	10% ~ 95% relative humidity, non-condensing
Module Input/Output	2 x RS-232
SATA	3 x SATA-300
Ethernet	3 x 10/100/1000 Mbps ethernet ports
Display Ports	1 x VGA, 1 x HDMI
Audio	1 x Line-out; 1 x Microphone-in
USB	3 x USB 2.0; 1 x USB 3.0
LED Indicators	Front: 5 (12V + 5V power; Computer + RAID 1 power; RAID error) Rear: 6 (1 activity light + 1 error indicator light per hard drive)
RAID	RAID 1 + Hot spare (Two 1TB HDDs in RAID 1 configuration with one 1TB HDD as hot spare to automatically substitute failed HDD)
Hard Drive or SSD	3 x 1TB Standard (Western Digital Red)
Warranty	10 year warranty (with HDD's), Consult for warranty with SSD's

APP-601 Portable Multifunction Recorder™

APP00281 (Shown) See also the APP-702

Uses & Specifications

Use for Emergency Investigation of Power System Problems, Extended Monitoring and Recording of Events on Transmission or Distribution Lines, Case Studies, or Research.

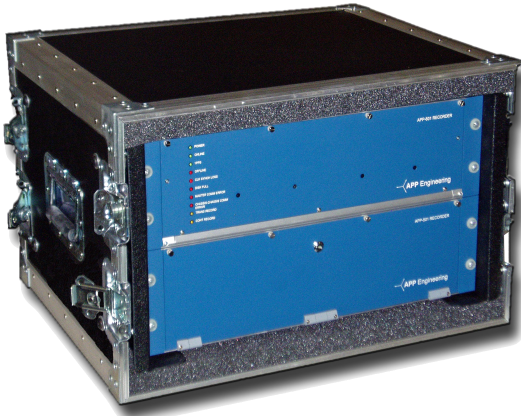

Dimensions	25.5" x22" x14"
Total Weight	49 Lbs.
Weight with-out Covers	33 Lbs.
Power	Universal 120VAC, 125VDC, 250VDC 80W @ 125VDC

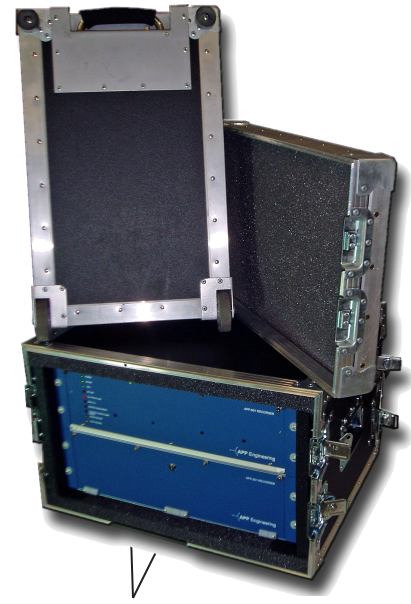

Easy Latch Protective Covers

(Optional) Carrying case with handles, wheels, removable front cover, removable rear cover, retractable pull handle, front & rear rack mounting rails, and interior foam walls. The exterior is capped off with aluminum U-Cap edging for enhanced strength and protection.

Extending Handle and Rolling Wheels Make the APP-601 Easily Portable To Take Into the Field

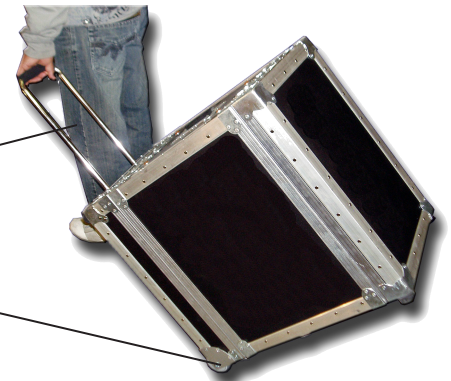

Includes

- Ten Slots for Analog and/or Digital Cards (Shown with 9 Analog Channels, 16 Digital Channels)
- On Board APP Clear View Analysis Software
- Eight Alarm Outputs (Shown)
- APP-501 Comp. Chassis w/ Pull Out Drawer
- APP-601 Data Chassis
- AC Power Cord
- Chassis to Chassis Interconnecting Cables
- Protective Carrying Case (Can also Be Purchased without Case)
- Option: Purchase Data Chassis Only and Use Your Computer See APP-601 Sales Literature for Recording Details and Other Computer Chassis Choices



Easy Access Computer with Slide Out Drawer

Expandable

3 Channels per Analog Card

8 Channels per Digital Card

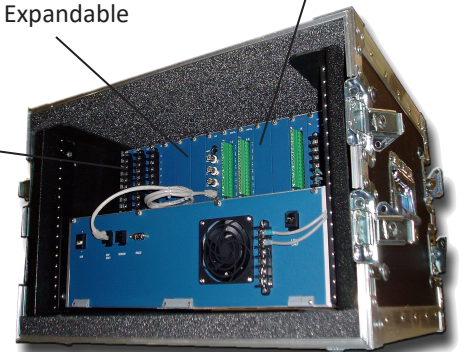

APP-702 Compact Recorder™

Multifunction DFR, SER, DDR, PMU, PQ
Use as permanent install or portable

Recording

- Transient Recording
- Extended RMS Recording
- Extended Oscillography Recording
- Continuous Oscillography Recording
- Trend Recording
- Continuous RMS, Phase, Frequency Recording

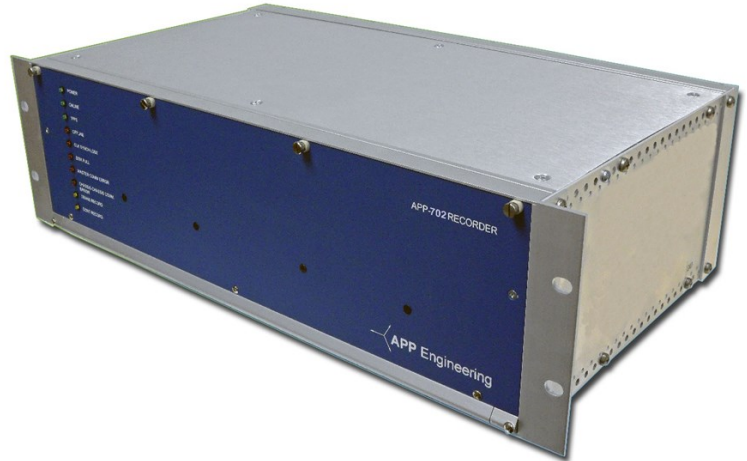

Computer

- Embedded Industrial Computer
- 1TB Solid State Drive
- No Moving Parts



Options

- 601 Monitor & Keyboard Chassis
- Fiber
- Clamp On CT's
- Channel expansion with APP-601 Data Chassis
- Use as a Portable Unit (carrying case available)

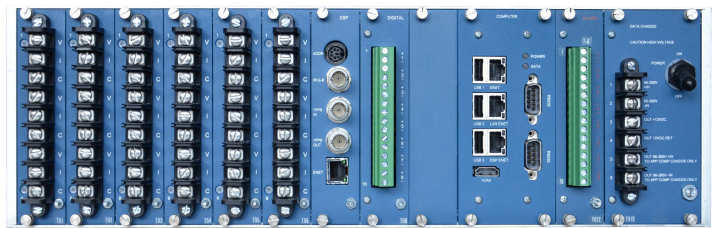

Rear

Seven Configurable Analog/Event Card Slots
(18 Analog, 8 Events Shown)

Features

Hardware

- Easy Expandability (Add 601 Data Chassis)
- IP Configurable
- Data Aligned to 1PPS within 1usec
- Modulated or Un-Modulated IRIG-B
- Configured to Voltage or Current
- Wide Voltage & Current Input Range
- AC or DC Measurements
- Eight Output Relays
- Easy Access Power Supply Modules
- Easy Access Embedded Computer Board

Software

- Includes APP Recorder & APP ClearView
- Password Protection, IP Address Permissions, & Comm Logging
- Configure Locally or from the Master Station
- COMTRADE Records Directly from Recorder
- Automatic Tasks: Comm Names, PQDIFF, Diagnostics, Calling
- Polling, Emailing, FTP, Record Backups, Updates, Alarm, Reporting, Trace Files, & Printing
- File Transfer Feature Allows Any File Transfer from Recorder
- To Master, Local/Remote Test Run, Reboot, Reinitialize

Specifications (APP-702)

Analog Channels

Voltage:

Base 18 analog channels (Can be expanded)
Up to 440VAC Max True DC Coupling
 R_{in} 100K Ω
Accuracy 0.15% of reading + 0.005% of range
(typical)

Current:

2m Ω Internal Shunt
15A RMS Continuous
140A RMS for 2 sec, 250Arms for 1/2 sec Accuracy
0.61% of reading + .005% of range (typical)

General:

16 Bit A/D
Data aligned with 1PPS rising edge, Ch to Ch
phase angle error <0.004^o, Cut-off frequency
(-3db) 5KHz, Common Mode Rejection 80dB,
Channel to channel isolation 3500VDC Channel to
ground isolation 3500VDC

Event Channels

Base 8 event channels (Can be expanded)
Standard input operating range 45-250VDC (24VDC
option available)
Channel to channel isolation 3500VDC Channel to
ground isolation 3500VDC

Power Supply

Voltage Range: 86 to 370 VDC or
88 to 264 VAC
Frequency Range: 47 to 63 Hz
Overload, Over Voltage,
Over Temperature Protection
Power @ 125VDC and 18 analog channels
and 8 event channels is approximately 25W. Input to
ground isolation 3500VDC

Timing

Modulated or Un-modulated IRIG-B Data
aligned to 1PPS within 1usec
1PPS in/out chassis to chassis
Internal 1PPS backup
PTP Option

Communications

Recorder to Master Station
TCP/IP Ethernet 10/100
DNP-3, Modbus
RS-232
Ethernet 10/100
PMU
FTP

Status Relays

8 alarm outputs, N.O. or N.C, SPST
Contact ratings: 10A Cont. & Break 0.5A @
125VDC, Break 0.35A @ 250VDC, Dielectric
5KVac

Alarms

Power, Online, Offline, Clock Sync Loss, Chassis to
Chassis Comm., Master Comm., Disk Full, Tempera-
ture, Computer, Tran Record, SOE Record, Disturbance
Record, and Continuous Record
(additional outputs available)

Enclosure

19" Rack x 5.25"H x 9.8D"
Weight: Approximately 15lbs

Compliant Standards

ANSI/IEEE C37.90.1 (Surge Withstand), IEC 60255-
22-1 Cat III (Osc.), IEC 60255-22-4 Cat IV (EFT),
IEC 60255-5 Cat IV (Isolation), ANSI/IEEE C37.111
(COMTRADE), ANSI/IEEE C37.232-2007 (Com
Names)

Environment

Temperature range -40° to 55°C

APP-904 Rack Mount Monitor & Keyboard Console™

P/N: APP00904

Standard Specifications

Console, 1RU, (1.75") 19" Rack Mount, 13" Deep if Flush Mount
Three Available Mounting Depth, Flush Mount, 2" Mount, 3.5" Mount, cont'd
2", and 3.5" allow for greater monitor tilt angle and less depth into panel.
Rear Ports: 1 USB Type A, 1 LVI-D, 1 VGA, 1 Three Pos Power Terminal Block
Universal Power Input 86-370Vdc, or 88-264Vac, 17W @ 125VDC
Power Input Frequency Range 47Hz to 63Hz
Operating Temperature Range -25C to 70C
Storage Temperature Range -30C to 80C
Humidity 0 to 85% Non-Condensing
Pull out drawer with 12.1" flip up Industrial TFT, High Brightness, cont'd
XGA Monitor, 1024 x 768 Res
Waterproof, Washable Membrane, 104 Key US Layout, cont'd
with Touchpad
Auto Power-Off via Windows OS
Convenient Front Grip Handle
Easy Glide Ball Bearing Slides
See Dimensions on next page



APP-904 Rack Mount Monitor & Keyboard, cont'd

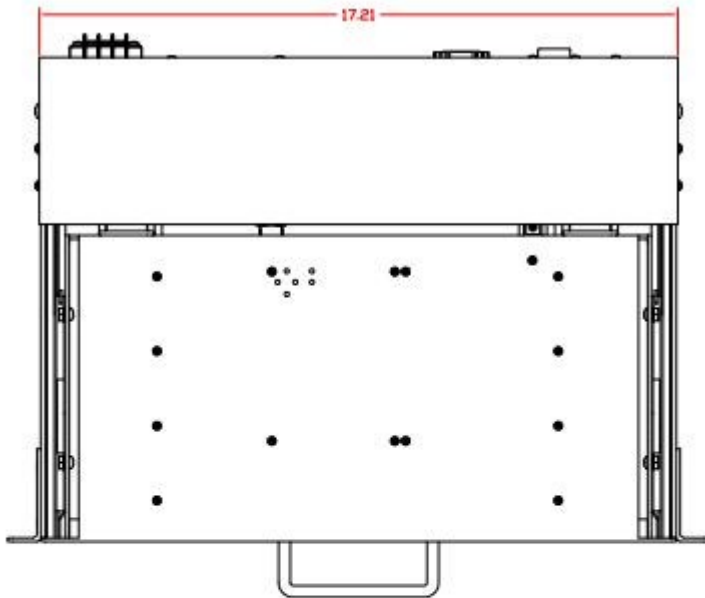
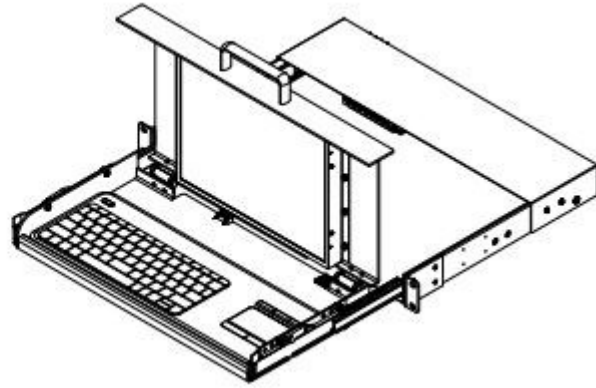
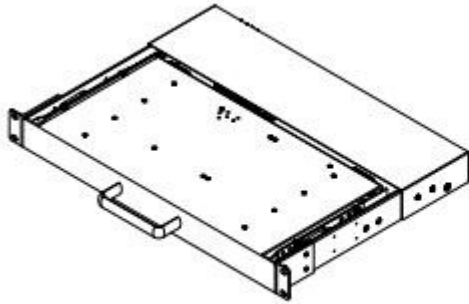

TOP VIEW



FRONT VIEW



REAR VIEW

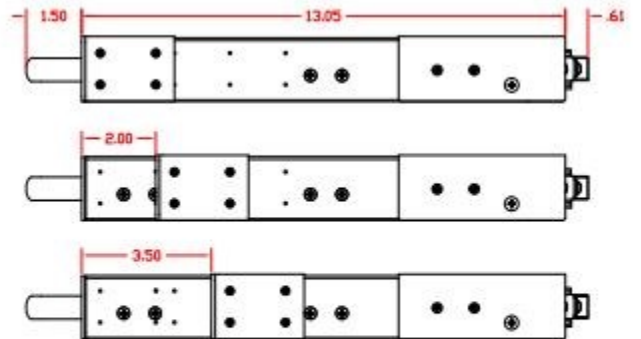

SIDE VIEW
(MULTIPLE MOUNTING DEPTHS SHOWN)

APP-110 IRIG-B ANALYZER/GENERATOR™

Decode and analyze IRIG-B timing signals with the APP-110 IRIG-B Analyzer.
Validate the integrity of your time sensitive monitoring equipment at every level by using the APP-110 IRIG-B Analyzer by generating an IRIG-B time signal and other signals.



FRONT PANEL

Oscilloscope view of input signal
Hold and run modes
50ms or 100ms window with auto ranging
Decoded IRIG-B information including:

- Time
- Date
- Time code
- Daylight saving
- Time quality

INPUTS

Micro-USB power connector
3/4 inch spaced banana plug connectors
BNC input using BNC to banana plug adapter
Autodetect modulated/unmodulated/1PPS input
IRIG-B time signal
Ability to detect if input signal is IEEE 1344 compliant
Accepts general signals <30V for oscilloscope display

ENVIRONMENTAL

Operating temperature range 0°C to 50°C
Humidity 0% to 95% non-condensing

POWER

Power supply: - 5 VDC battery pack
US plug 5VDC micro-USB adapter included

PHYSICAL

Dimensions: 6.73" (L) × 3.39" (W) × 1.24" (H)
Weight: 200 grams / 7.1 oz (without battery)

OUTPUTS

2 BNC outputs: 1 sine wave / 1 square wave
Sine wave output modes:

- Modulated IRIG-B time signal
- 1 pulse per second
- 60Hz sine wave
- 50Hz sine wave

Square wave output modes:

- Unmodulated IRIG-B time signal
- 1 pulse per second

Ability to sync input IRIG-B time signal to output IRIG-B time signal
Output custom IRIG-B time signal set by user

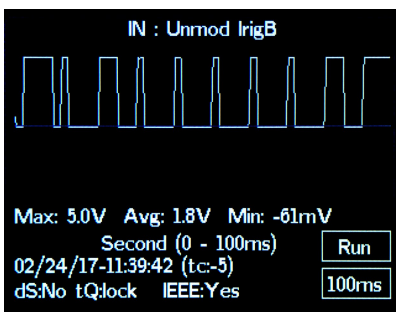

Oscilloscope view and decoded

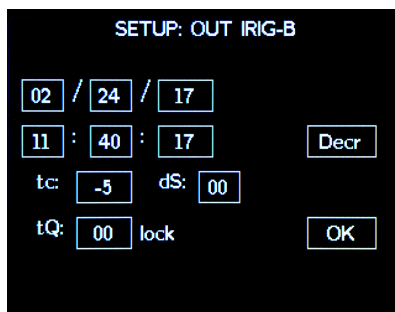

Output custom IRIG-B time

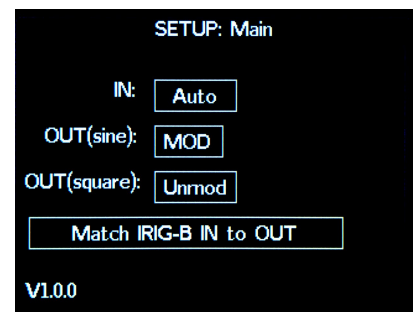

Generate IRIG-B time signals

APP Traveling Wave Fault Location

Summary

The APP traveling wave technology is a scalable and configurable solution that can locate a fault with high accuracy. With an accuracy of 200 feet or better, this will significantly reduce the down-time of correcting the fault.

Add to any existing APP-601 system. Can create any configuration of analog, digital and traveling wave boards in each data chassis (over one million different configurations)

Both double end and single end configurations are possible

This is an accurate and reliable solution has the bottom line of reducing down time and ultimately saving costs.

Highlights

- High Level of Accuracy
- Double Ended or Single Ended Configurations
- Megahertz Sampling Frequency
- Highly Configurable
- Up to 10 Cards per Chassis
- Low Learning Curve
- Easy to Maintain
- Add to any existing APP-601 Recorder
- 10-Year Warranty on All Traveling Wave Hardware

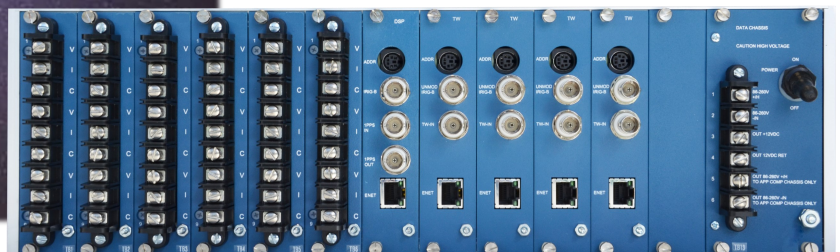
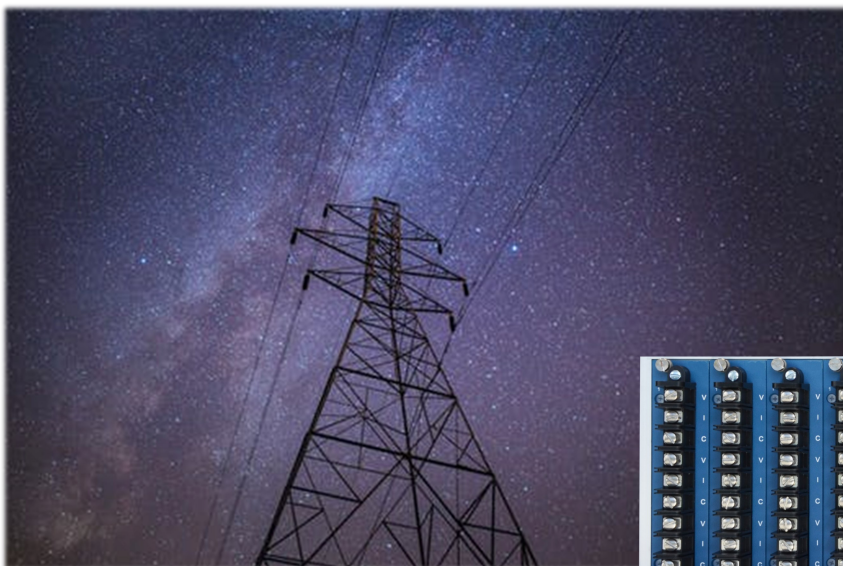

Concept

Travelling wave fault location (TWFL) is a method to determine the location of a fault on an electrical line.

By using the information about the length of the line, the time of when the fault was recorded, and the velocity at which the fault moves along the line (information which is known at the time of setup), the Recorder's TWFL feature can determine the location of the fault along the line.

The Bewley diagram shows the relationship between the fault and the respective reflections being picked up by the DFR(s).

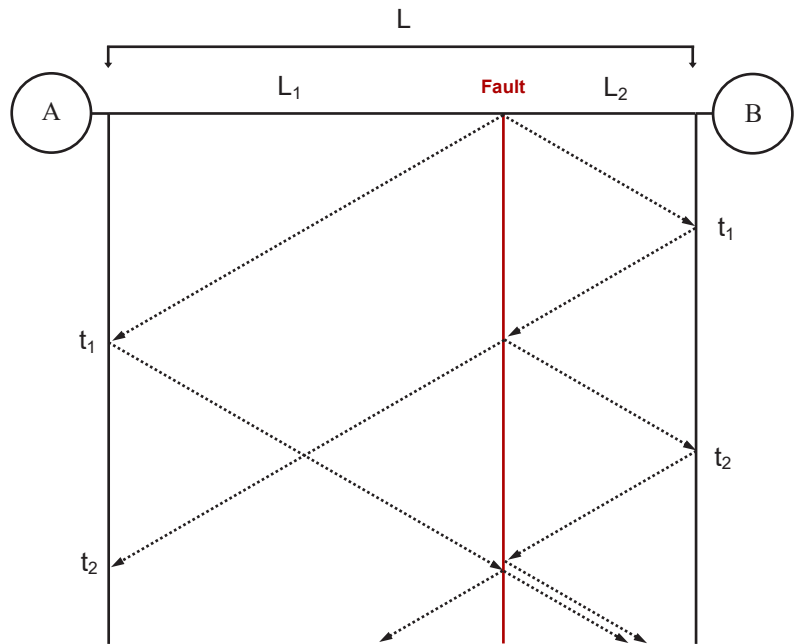

Block Diagram

- The signal is picked up by a high bandwidth, 500:1 CT that connects via BNC
- The signal runs through a high-pass filter which refines the presence of the fault
- The signal is split between a high frequency ADC and a voltage-threshold trigger
- The threshold trigger records the time-mark of the fault at the nanosecond precision and is recorded to the INF file

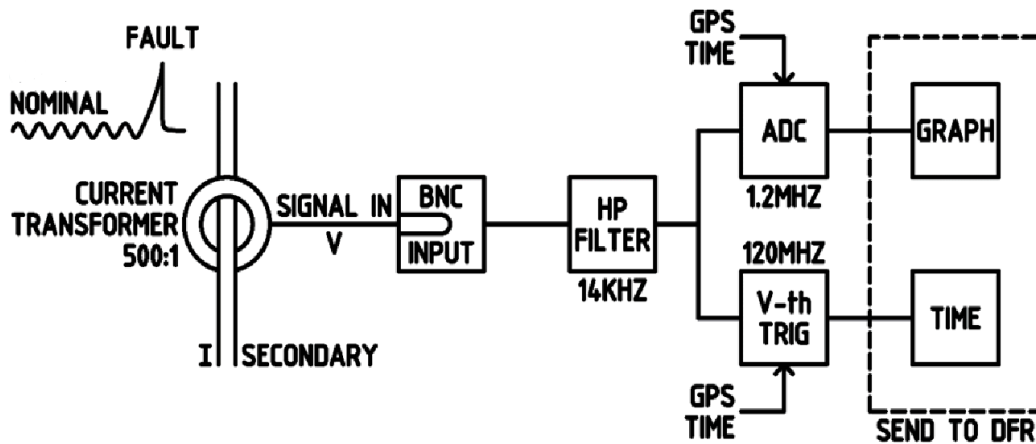

Easy Addition to Any APP Recorder

- 1) Install traveling wave board
- 2) Connect unmodulated IRIG-B signal
- 3) Connect to DFR ethernet switch
- 4) Install split core traveling wave CT
- 5) Connect traveling wave CT to traveling wave board
- 6) Add to DFR setup file

Hardware

- Traveling wave circuit board P/N: **PCBTW-1-POP-KIT**
Includes: Card, IRIG-B Jumper, BNC-T Ethernet Cable
- Traveling Wave Split Core CT P/N: **APP-00829-TW**
(with 15' twisted wire leads)



TW Circuit Board
P/N: PCBTW-1-POP

Configurations

- Add traveling wave cards & traveling wave CTs to existing APP DFR/DME data chassis that have open card slots
- Purchase an APP-601 data chassis with traveling wave cards and CTs and add to an existing APP DFR/DME
- Purchase new APP-601 DFR/DME with any combination of Analog, Event, and TW cards
- Purchase a standalone APP-601 DFR/DME in which all cards are traveling wave
- Double ended with communication or double ended no communication or single ended



TW Split Core CT
P/N: APP00829-TW

Note

One traveling wave CT per phase or we recommend one traveling wave CT clamped around phases A, B, C (1 board and 1 CT's per line).

Specifications

Accuracy	< ± 200 feet
Features	Sampling Frequency: 1.2MHz Trigger Frequency: 120MHz Programmable Trigger Threshold
Interface & Comm	Viewable Record in COMTRADE Ethernet to APP DFR Switch Each TW Card IP Programmable Fully Integrable with APP DFR (DME)
Alarms	8 Alarm Outputs
Configuration	One Channel per Board Up to 10 Boards per Data Chassis Up to 250 Boards per System
Environmental	Temperature: -25° to 70°C Humidity: 95% Non-Condensing
Warranty	10-year on all traveling wave hardware
CT	500:1 Ratio 100Hz to 1MHz Connector: via BNC

APP-00155 Split Core Trip Indicating Relay™

Applications

- ✓ Lock Out Relay Circuits
- ✓ Trip Coil Circuits
- ✓ Control System Operations

Features

- ✓ Easy Installation
- ✓ Small Size
- ✓ Isolation

Specifications

Current thru primary 25A Max.
 Output Contact 250VDC Max.
 Output Response Time Approx. 2ms
 Operating Temperature: -20°C to 50°C
 Operation: Indoor
 Case Material: ABS Thermoplastic
 Removable Leg Screws: Knurled Nylon
 Overall size: 2"H x 2.5"W x 1"D
 Weight: Approx. 8oz with 15' Leads
 Conductor Thru Hole Diameter: 0.4"
 Standard Lead Length 15'
 Twisted Leads
 Up to 100' Lead Length Available
 Black Wire Positive
 Arrow Towards Current Source

Primary current needs to rise to approx. 1.75A to switch output (see graph).



Ordering Information

Part Number = APP-00155
Mounting Brackets Available

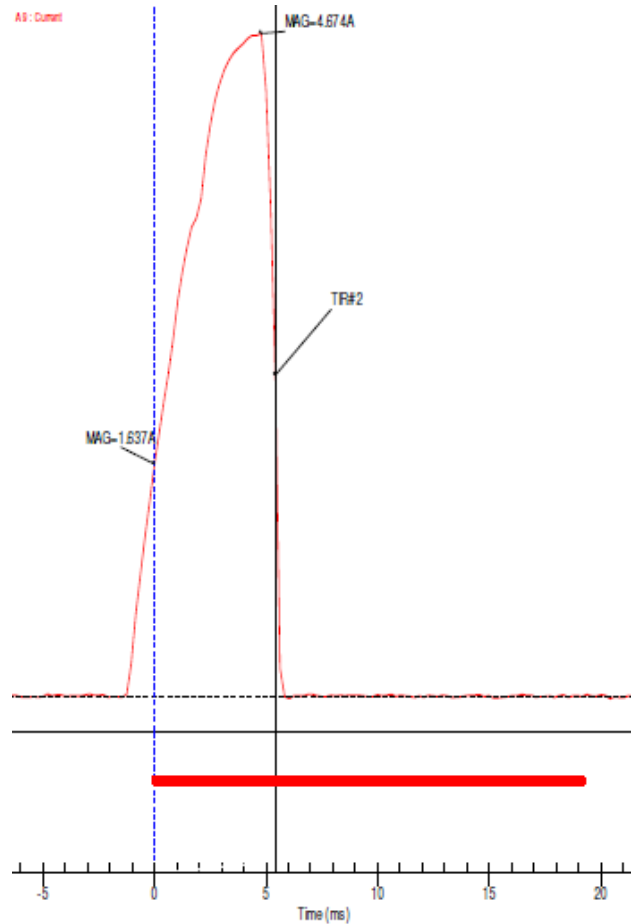

DFR Trigger Via Event Channel at t_0

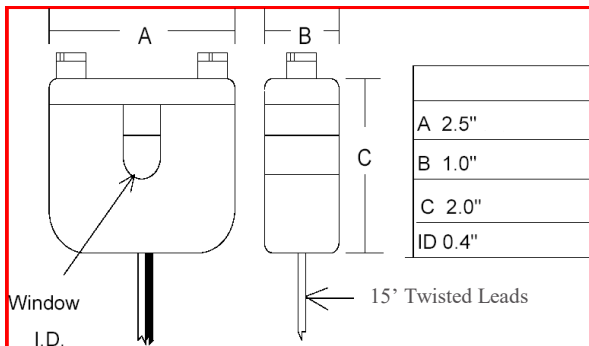

Removable leg contains a lapped spring loaded core that mates with the precision core in the main housing.

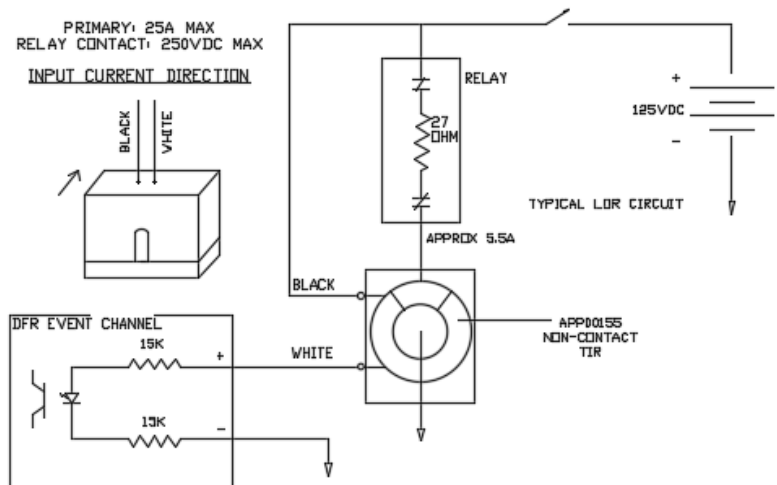

THIS PAGE INTENTIONALLY
LEFT BLANK



5234 Elmwood Ave
Indianapolis, IN 46203
Phone: 317-536-5300
Fax: 317-536-5301
Email: sales@appengineering.com
www.appengineering.com

The most advanced, affordable, and user friendly recorders on the market

A ten year warranty applies to most items. Contact the factory for specific details. Items such as satellite controlled clocks and antennas carry the OEM warranty.

Specifications subject to change without notice.

This publication does not represent or imply any contract between APP Engineering, Inc. and its customers. We make no guarantees the information in this catalog is error free.

Copyright © April 05, 2009-2022 APP Engineering, Inc. All rights reserved
APP Engineering Catalog Rev 15 08-29-2022

