



**YANMAR**

ZERO TAIL SWING MINI EXCAVATOR

# **Vi030-6B / Vi035-6B**

[Gross] 20.4kW (27.3hp)



\* The machine in the picture is equipped with optional parts.





\* Pictures shown are for illustration purpose only. \* The images shown here are for promotional purposes.  
\* The image may differ from the actual model on sale. \* The machine in the picture is equipped with optional parts.  
\* Be sure to wear the seat-belt when operating the excavator. \* Ground the bucket when leaving the operator's seat.  
\* Work in accordance with the relevant laws when operating the excavator.



# Our 3t class mini excavator is ideal for a wide range of worksites.

3t class mini excavators can be found in a wide range of worksites, and the ViO30/35 is built to deliver maximum performance wherever it goes. This excavator, with its improved features, equipment, and fuel efficiency provides a comfortable work environment for the operator while working smoothly and effectively to meet the work conditions on worksites.





# Details of Vi030-6B/Vi035-6B

## Features

Spring steel cylinder rod guards to prevent damage to the hydraulic cylinder.

►Page 9

Boom light is installed inside the structure to protect it from damage

►Page 9

Hydraulic quick coupler makes adding attachments quick and easy.

►Page 11

Easy-to-fasten retractable seatbelt to protect the operator

►Page 8





ROPS<sup>\*1</sup>/FOPS<sup>\*2</sup> four pillar canopy  
to protect the operator.

▶Page 9

Durable steel hood

▶Page 9

Isochronous control to  
maintain engine speed  
even if the work-load  
changes

▶Page 7



\*The images shown here are for promotional purposes. \* The image may differ from the actual model on sale.

\*The machine in the picture is equipped with optional parts. \* Ground the bucket when leaving the operator's seat.

\*1 ROPS: Roll-Over Protective Structure(A structure to protect the operator wearing a seat belt, in case the machine rolls over)

\*2 FOPS: Falling Object Protective Structures.



# Isochronous control to maintain engine speed even if the work-load changes

The tough and easy-to-handle compact body of our 3t class machine is equipped with a powerful and quiet diesel engine. The excavator consumes less fuel, has excellent environmental performance, and make working comfortable.

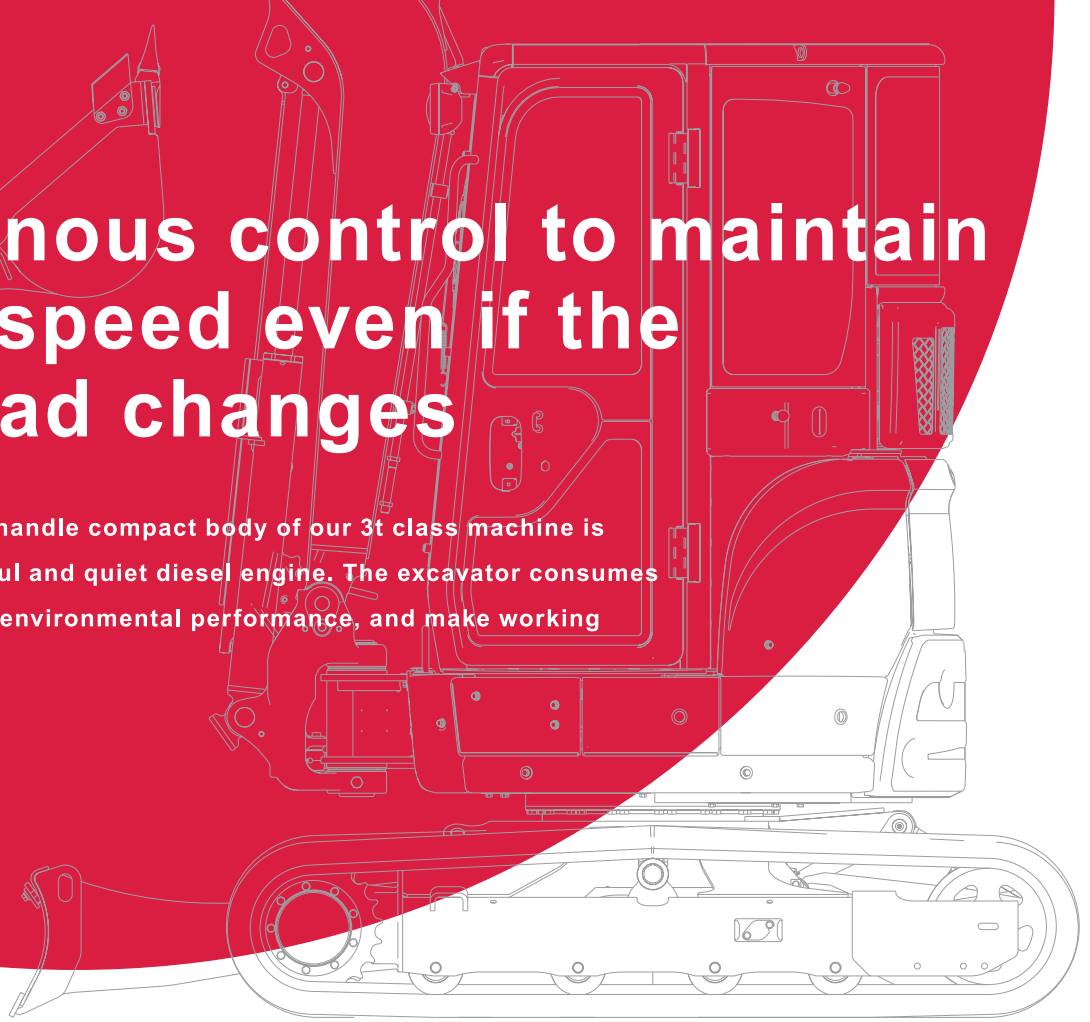

## ● Improved fuel consumption

To make this excavator more fuel-efficient than previous models, we used an electronic control to make the engine more energy-efficient, and optimize the hydraulic circuit in our new hydraulic system.

### Comparison of fuel consumption and workload for 1L of fuel in conventional excavators:

\* Based on our research and measurement methods.

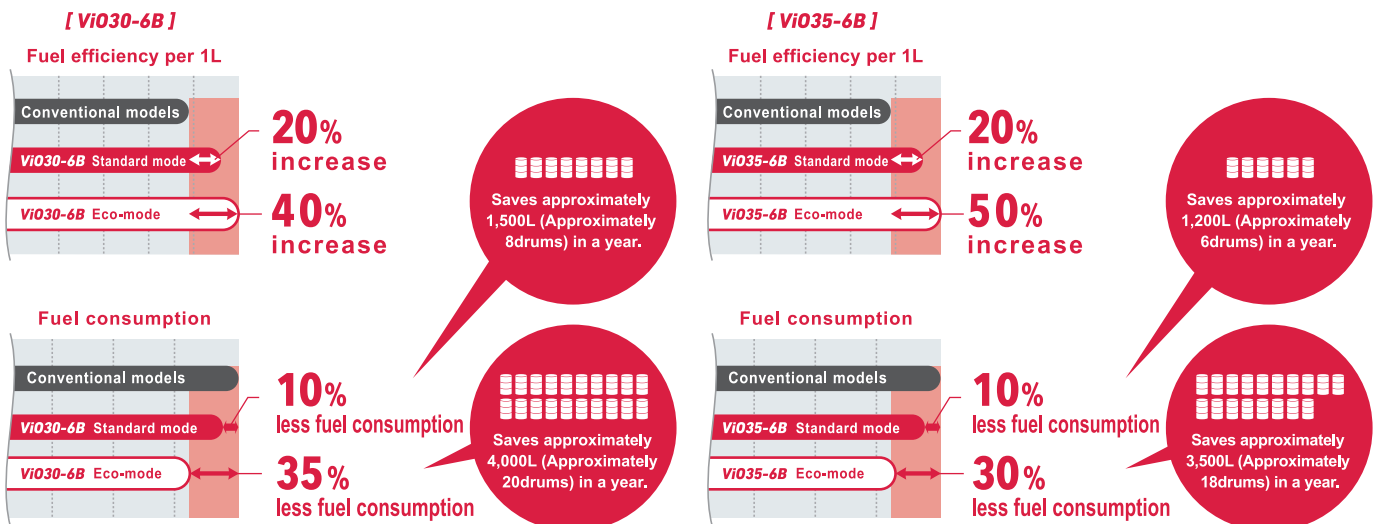





## Eco-friendly engine complies with emission regulations



### Maintain engine speed on any type of jobsite

#### ● Isochronous control

When the engine starts to slow down due to a heavy load, the computer responds immediately by increasing the amount of fuel injection. Work efficiency does not decrease even when the excavator is carrying a significant load, and the machine operates at the set speed without slowing down the engine.

Engine model

**3TNV88-ZSBV1**

Engine output(Gross)

**20.4 kW**

Picture of engine shown for illustration purpose only.

#### ● Auto deceleration

If the operation lever stays in neutral for more than 4 seconds, the engine speed will automatically change to low idle. The engine speed will automatically revert to the original speed once the operation lever is moved.



#### ● Eco-mode function

Reduces fuel consumption by reducing the maximum engine speed by approximately 15%.



\* Pictures shown are for illustration purpose only. \* The images shown here are for promotional purposes.

\* The image may differ from the actual model on sale. \* The machine in the picture is equipped with optional parts.

\* Be sure to wear the seat-belt when operating the excavator. \* Ground the bucket when leaving the operator's seat.

\* Work in accordance with the relevant laws when operating the excavator.



# Ease of operation with a well appointed operator's station

● Spacious leg room



● A roomy cab makes it ideal for long working hours

● Easy to recognize and use levers and switches placed to the right side



Wrist control lever

ECO mode switch

Dial type accelerator knob

Auto deceleration switch

Retractable seatbelt

Box

Drink holder

● Reclining seat



Comes equipped with a operator's manual case at the back of the seat.

● External power outlet (12V)

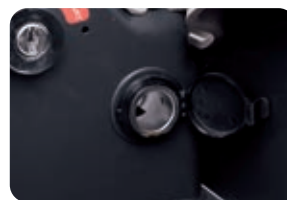

Can also be used to charge cell phones.

● Hood handle



Easy to grasp and open with either of your hand

● The large LCD display includes an LED backlight, that makes it enable for the operator to easily check information in the low light conditions.

Easy to find out essential information related to operational status and errors, by an easy to read monitor, LED indicator lamps and buzzer.

## LCD monitor sample screen



4

■ : 0.5 to 2hours  
 ■■ : 2.0 to 4hours  
 ■■■ : 4.0 to 8hours  
 ■■■■ : 8hours and over

1months operation time is displayed\*

Displays up to 3months\*



Daily operation hours separated by AM/PM\*

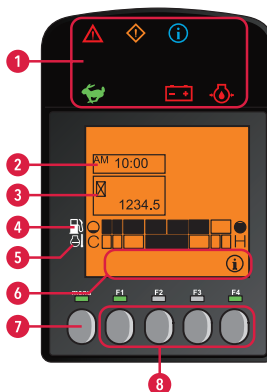

1 LED lamp blinks when displaying warning and information.

Warning lamp

Caution lamp

Information lamp

High speed travel lamp

Battery charge lamp

Engine oil pressure lamp

2 Clock

3 Hour meter

4 Fuel gauge

5 Water temperature meter

6 F1-F4 key guidance

7 Switch to select menus/main menu

8 F1-F4 perform the operation displayed in guidance

# Safe, easy and reliable operation

● Durable steel hood

● Four pillar canopy complies with ROPS<sup>\*1</sup>/FOPS<sup>\*2</sup> standards

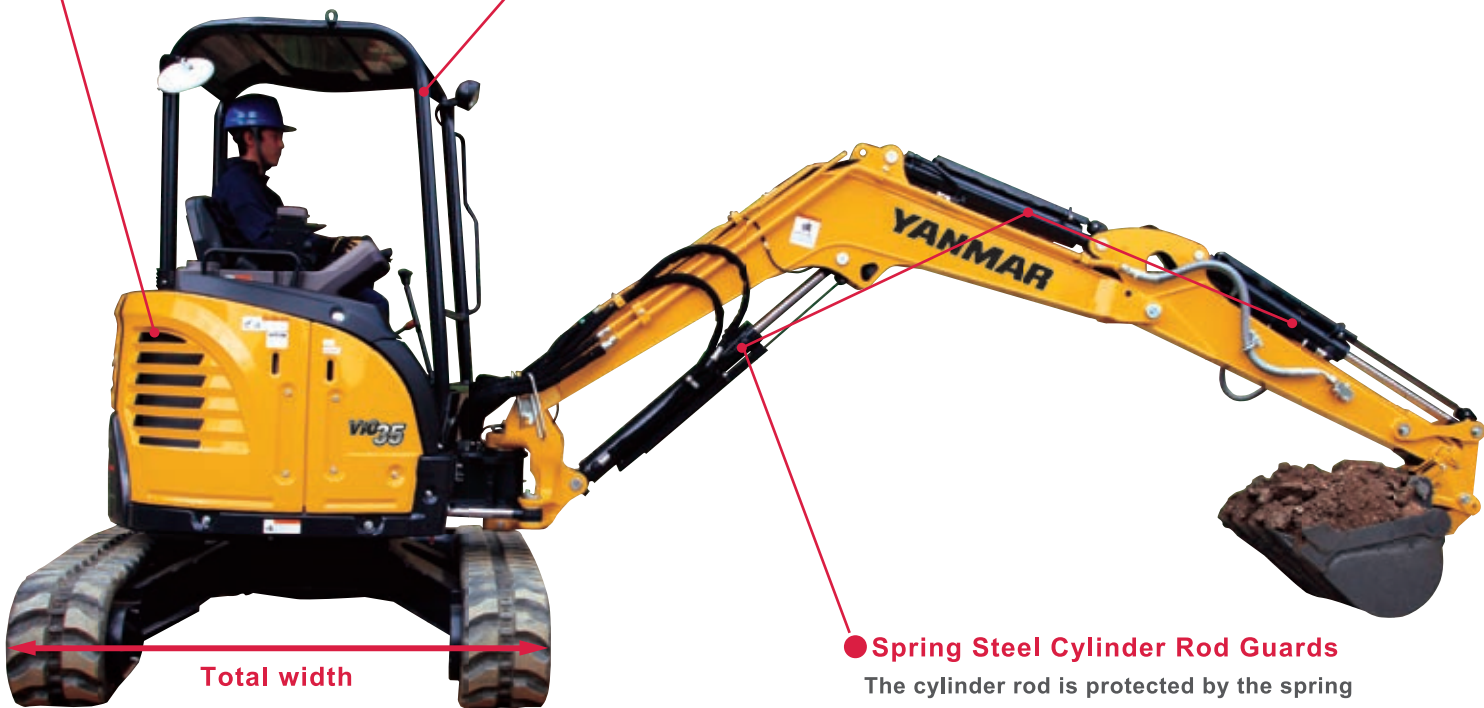

Total width

Vi030-6 **1550 mm**

Vi035-6 **1740 mm**

● Spring Steel Cylinder Rod Guards

The cylinder rod is protected by the spring steel structure. Scratches caused by debris or collision are greatly reduced thanks to the spring steel's ability to absorb impact. Additionally, they are highly durable and unlikely to bend, giving the operator a sense of safety. Metal sheeting shields the cylinder tubes providing full protection to cylinders, regardless of whether they are extended or retracted.

● True Zero Tail Swing

Works efficiently and can be operated without worrying about the tail swing - The excavator body stays within the machine width. This helps reduce the operator's efforts and work time.

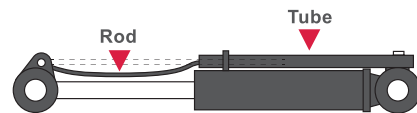
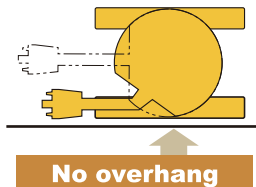

● Built-in boom light



● External engine shut-off switch



\* Pictures shown are for illustration purpose only. \* The images shown here are for promotional purposes.

\* The image may differ from the actual model on sale. \* The machine in the picture is equipped with optional parts.

\* Be sure to wear the seat-belt when operating the excavator. \* Ground the bucket when leaving the operator's seat. \* Work in accordance with the relevant laws when operating the excavator.

\*1 ROPS: Roll-Over Protective Structure(A structure to protect the operator wearing a seat belt, in case the machine rolls over)

\*2 FOPS: Falling Object Protective Structures.



# Easy maintenance.

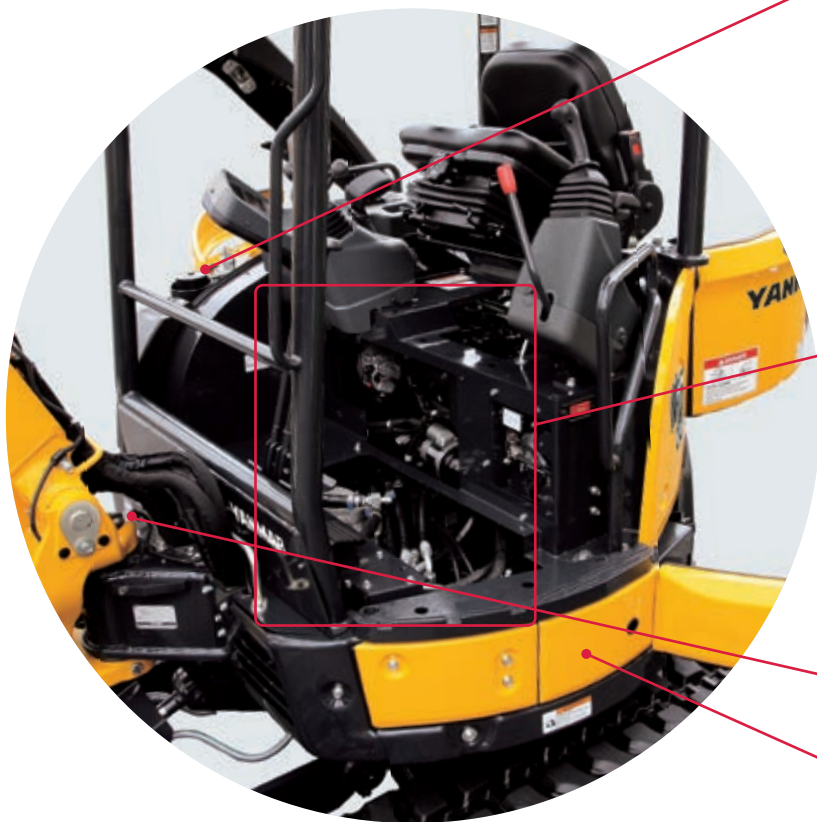

- **Open the panel on the upper right side with one touch**

Easy access to the fuel tank and hydraulic fluid tank. It also comes equipped with grease gun holder.



- **Open around the operator's seat**

The maintenance of the engine, wiring, and hydraulic parts is easy as the cover in front of the operator's seat can be fully opened.



- **Toolbox**



- **Fuel tank drain plug**



- **Air conditioner and condenser**

(Air conditioner, and washer tank are optional)

- **One-touch action to open both the rear hood and the right side hood.**

You can easily access the engine, radiator, and battery as the panels can be opened without tools. The coolant spray-type radiator adds to the long operation life of the machine.

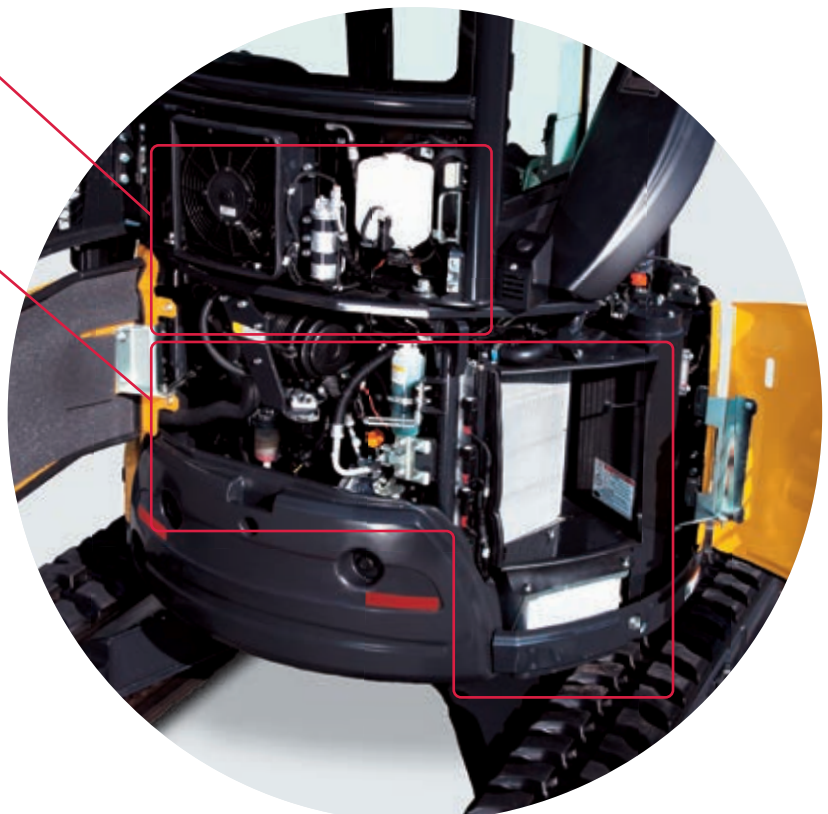

# There are many additional options that can be added to meet your requirements.

## CABIN SPEC



● Pattern change valve (2way / 4way)

● Increased weight



● Hydraulic quick coupler makes changing attachments quick and easy.

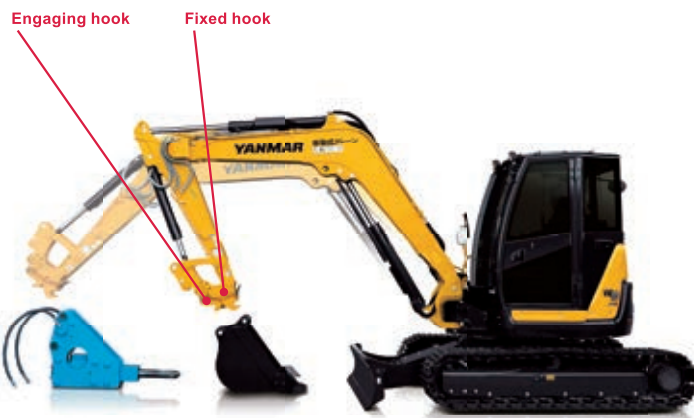
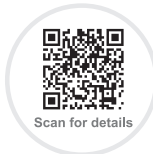

### ● Unattach bucket

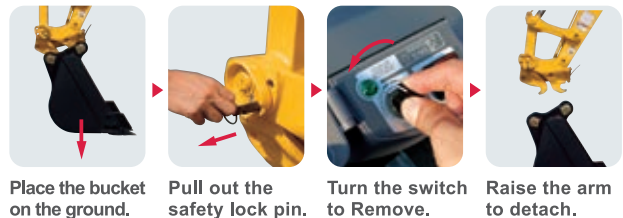

### ● Attach bucket



\* The images shown here are for promotional purposes. \* The image may differ from the actual model on sale.  
\* The machine in the picture is equipped with optional parts. \* Ground the bucket when leaving the operator's seat.





Providing services that keep you on track.

# SMARTASSIST Remote

\* Separate application required (free)

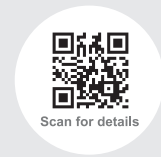



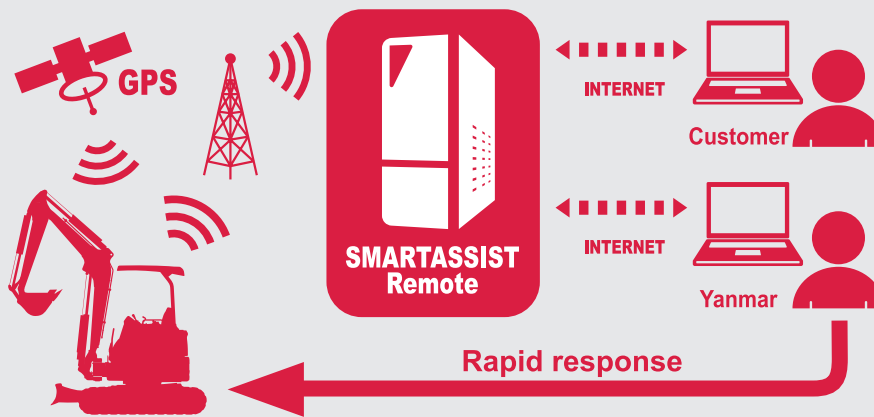

## ● Efficient use of machinery thanks to remote monitoring

Our construction equipment is equipped with GPS and communication terminals, allowing you to manage location information via the communication system. The system also lets Yanmar remotely monitor your machine, allowing us to stay on top of maintenance intervals, quickly identify machine issues and provide service and support at all times.



## ● Providing peace of mind, supporting your business

-  **Theft prevention tool**  
The theft prevention feature emails you if the machine moves out of a pre-determined area.
-  **Error notification service**  
Quickly identify location of error in the event of machine trouble.
-  **Maintenance management tool**  
Manage inspection/maintenance information.
-  **Operational status management tool**  
Visualize operational status of machine.
-  **Work schedule creation tool**  
Record work data and improve efficiency.

## The Unsung Heroes Who Build Our Towns And Cities

You build the infrastructure and the foundations in our towns and cities.

Transforming the places where we stand today, into dreams of tomorrow.

You are the unsung hero.

The YANMAR mission is to provide machines and services that allow you to reach your full potential.

Built tough and with comfort in mind,

YANMAR Construction Equipment will help you get the job done with ease, regardless of the worksite.

When we make machines, we are dedicated to enabling you to perform at your best all of the time.

One example of this is our innovative True Zero Tail Swing Excavators that set the standard for safety and reliability, enabling operators to perform at their best in tight quarters.

YANMAR also manufactured the first compact diesel engines

and today we continue to make diesel engines ranging from 4 to 4,800 kW.

Equipped with advanced engines and hydraulic systems, our construction equipment delivers better fuel economy, increased productivity and enhanced operation.



**YANMAR is the driving force behind our unsung hero.**

**BEST PERFORMANCE BY YOUR SIDE**



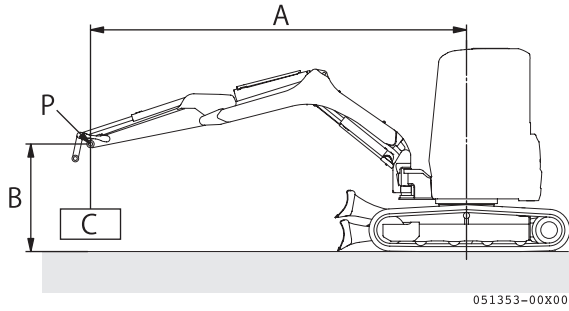







# ViO30-6B Lifting Capacity











- With:  
 Canopy Type  
 Rubber Crawler
- Without: Quick coupler and Bucket
- A : Reach from swing center line [m<in.>]  
 B : Load point height [m<in.>]  
 C : Lifting load [kg<lbs.>]  
 P : Load point
-  : Rating over front  
 : Rating over side or 180 degrees

## Blade on ground

A [m<in.>]	Max.		3.0<118.1>		2.5<98.5>		2.0<78.7>	
B [m<in.>]								
3.0<118.1>	760 (*1675)	390 <859>	600 (*1322)	600 (*1322)	-	-	-	-
2.5<98.5>	760 (*1675)	330 <727>	710 (*1565)	540 <1190>	-	-	-	-
2.0<78.7>	780 (*1719)	280 <617>	850 (*1873)	490 <1080>	900 (*1984)	700 <1543>	-	-
1.0<39.4>	830 (*1829)	270 <595>	1180 (*2601)	450 <992>	1530 (*3373)	600 <1322>	-	-
0<0>	870 (*1918)	270 <595>	1300 (*2866)	400 <881>	1680 (*3703)	550 <1212>	2170 (*4784)	780 <1719>
-1.0<-39.4>	950 (*2094)	340 <749>	1180 (*2601)	400 <881>	1560 (*3439)	570 <1256>	1870 (*4122)	760 <1675>
-1.5<-59.1>	930 (*2050)	460 <1014>	-	-	1250 (*2755)	580 <1278>	1690 (*3725)	810 <1785>

## Blade above ground

Unit : kg <lbs.>

A [m<in.>]	Max.		3.0<118.1>		2.5<98.5>		2.0<78.7>	
B [m<in.>]								
3.0<118.1>	510 <1124>	390 <859>	600 (*1322)	600 (*1322)	-	-	-	-
2.5<98.5>	430 <947>	330 <727>	710 (*1565)	540 <1190>	-	-	-	-
2.0<78.7>	390 <859>	280 <617>	660 <1455>	490 <1080>	900 (*1984)	700 <1543>	-	-
1.0<39.4>	360 <793>	250 <551>	610 <1344>	430 <947>	820 <1807>	580 <1278>	-	-
0<0>	360 <793>	270 <595>	570 <1256>	400 <881>	750 <1653>	520 <1146>	1120 <2469>	760 <1675>
-1.0<-39.4>	460 <1014>	330 <727>	550 <1212>	400 <881>	750 <1653>	540 <1190>	1060 <2336>	730 <1609>
-1.5<-59.1>	610 <1344>	450 <992>	-	-	780 <1719>	570 <1256>	1080 <2380>	780 <1719>

### Note :

The lifting load with the asterisk (<\*>) mark is limited by hydraulic lifting capacity rather than tipping. The lifting capacity shown in the above list is based on the ISO Standard No. 10567 and represents either 87 % of hydraulic lifting capacity or 75 % of tipping load, which is smaller.

# ViO35-6B Lifting Capacity

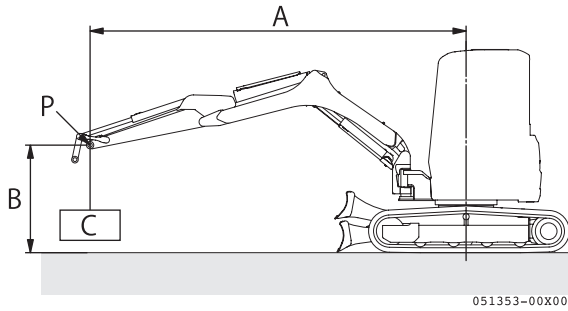

With:

Canopy Type

Rubber Crawler

Without: Quick coupler and Bucket

A : Reach from swing center line [m<in.>]

B : Load point height [m<in.>]

C : Lifting load [kg<lbs.>]







P : Load point

 : Rating over front

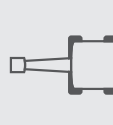
 : Rating over side or 180 degrees

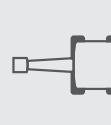

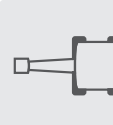

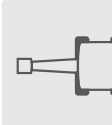

Blade on ground

Unit : kg <lbs.>

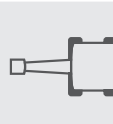
A [m<in.>]	Max.		3.5<137.8>		3.0<118.1>		2.5<98.5>	
B [m<in.>]								
3.0<118.1>	780 <(*1719)>	460 <1014>	740 <(*1631)>	580 <1278>	730 <(*1609)>	730 <(*1609)>	-	-
2.0<78.7>	800 <(*1763)>	390 <859>	870 <(*1918)>	580 <1278>	970 <(*2138)>	720 <1587>	1130 <(*2491)>	1130 <(*2491)>
1.0<39.4>	820 <(*1807)>	340 <749>	1060 <(*2336)>	510 <1124>	1310 <(*2888)>	660 <1455>	1730 <(*3813)>	970 <2138>
0<0>	850 <(*1873)>	360 <793>	1180 <(*2601)>	510 <1124>	1460 <(*3218)>	610 <1344>	1820 <(*4012)>	1100 <2425>
-1.0<-39.4>	880 <(*1940)>	420 <925>	1090 <(*2403)>	490 <1080>	1340 <(*2954)>	600 <1322>	1680 <(*3703)>	820 <1807>
-1.5<-59.1>	870 <(*1918)>	490 <1080>	930 <(*2050)>	490 <1080>	1170 <(*2579)>	610 <1344>	1420 <(*3130)>	820 <1807>
-2.0<-78.7>	840 <(*1851)>	660 <1455>	-	-	-	-	-	-

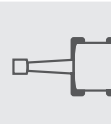
Blade above ground

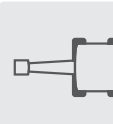
Unit : kg <lbs.>

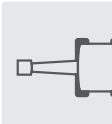
A [m<in.>]	Max.		3.5<137.8>		3.0<118.1>		2.5<98.5>	
B [m<in.>]								
3.0<118.1>	480 <1058>	450 <992>	600 <1322>	580 <1278>	710 <(*1565)>	710 <(*1565)>	-	-
2.0<78.7>	410 <903>	370 <815>	580 <1278>	570 <1256>	750 <1653>	700 <1543>	1110 <(*2447)>	1110 <(*2447)>
1.0<39.4>	360 <793>	340 <749>	540 <1190>	510 <1124>	690 <1521>	640 <1410>	900 <1984>	820 <1807>
0<0>	370 <815>	360 <793>	510 <1124>	480 <1058>	640 <1410>	600 <1322>	850 <1873>	780 <1719>
-1.0<-39.4>	420 <925>	400 <881>	490 <1080>	460 <1014>	630 <1388>	600 <1322>	840 <1851>	760 <1675>
-1.5<-59.1>	510 <1124>	480 <1058>	490 <1080>	480 <1058>	640 <1410>	610 <1344>	840 <1851>	760 <1675>
-2.0<-78.7>	670 <670>	640 <1410>	-	-	-	-	-	-

Note :

The lifting load with the asterisk (<\*>) mark is limited by hydraulic lifting capacity rather than tipping. The lifting capacity shown in the above list is based on the ISO Standard No. 10567 and represents either 87 % of hydraulic lifting capacity or 75 % of tipping load, which is smaller.



● Dimensions

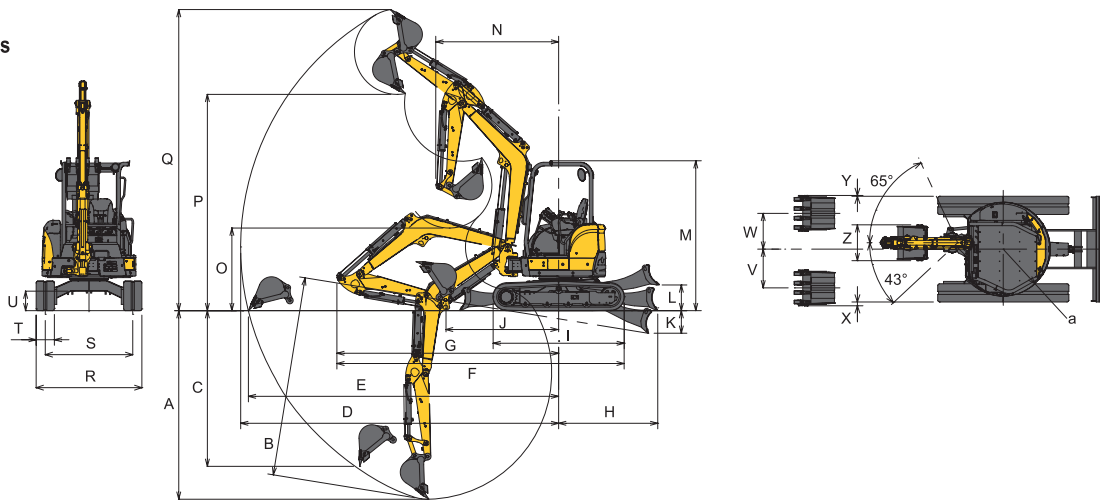

Unit : mm (ft-in)

		A	B	C	D	E	F	G	H	I	J	K	L	M	N	O	P	Q	R	S	T	U	V	W	X	Y	Z	a		
ViO30-6B	Quick Coupler	2970 (9'9")	3110 (10'2")	2160 (7'1")	5020 (16'6")	4890 (16'1")	4520 (14'10")	3390 (11'2")			1640 (5'5")				2200 (7'3") Swing 1980 (6'6")	1110 (3'8")	3010 (9'11")	4710 (15'5")												
	without Quick Coupler	2820 (9'3")	2950 (9'8")	2290 (7'6")	4870 (16'0")	4730 (15'6")	4470 (14'8")	3440 (11'3")			1480 (4'10")	1820 (5'12")	325 (1'1")	375 (1'3")	2460 (8'1")	2050 (6'9") Swing 1840 (6'0")	1230 (4'0")	3160 (10'4")	4550 (14'11")									135 (0'4")	85 (0'3")	540 (1'9")
ViO35-6B	Quick Coupler	3250 (10'8")	3440 (11'3")	2410 (7'11")	5390 (17'8")	5270 (17'3")	4770 (15'8")	3690 (12'1")			2160 (7'1")	1710 (5'7")			2170 (7'1") Swing 1950 (6'5")	1240 (4'1")	3410 (11'2")	5110 (16'9")			300 (1'0")	320 (1')	640 (2'1")	590 (1'9")						775 (2'5")
	without Quick Coupler	3100 (10'2")	3290 (10'10")	2560 (8'5")	5230 (17'2")	5110 (16'9")	4730 (15'6")	3650 (11'1")			1630 (5'4")	1880 (6'2")	370 (1'3")	425 (1'5")	2470 (8'1")	2020 (6'8") Swing 1810 (5'11")	1360 (4'6")	3560 (11'8")	4960 (16'3")			1740 (5'9")	1440 (4'7")					65 (0'2")	15 (0'05")	590 (1'11")

Specification

Model	ViO30-6B				ViO35-6B						
	Canopy		Cabin		Canopy		Cabin				
Spec	Canopy		Cabin		Canopy		Cabin				
Type	Quick Coupler	without Quick Coupler	Quick Coupler	without Quick Coupler	Quick Coupler	without Quick Coupler	Quick Coupler	without Quick Coupler			
Operating Weight	Rubber track	kg<(lbs)>	3175<(7000)>	3125<(6890)>	3315<(7308)>	3265<(7198)>	3585<(7905)>	3535<(7795)>	3725<(8214)>	3675<(8103)>	
	Steel track	kg<(lbs)>	3275<(7220)>	3225<(7110)>	3415<(7529)>	3365<(7419)>	3685<(8125)>	3635<(8015)>	3825<(8434)>	3775<(8324)>	
Engine	Type	-	Water-cooled 4-cycle diesel								
	Model	-	YANMAR 3TNV88-ZSBV 1								
	Rated Output	kW<(hp)> / rpm	20.4<(27.3)> / 2200 [Gross]								
Performance	Bucket capacity, standard	cu.m<(cu.ft)>	0.10<(3.53)>				0.11<(3.88)>				
	Max Digging Force	Bucket	kN<(lbf)>	23.5<(5283)>	29.9<(6722)>	23.5<(5283)>	29.9<(6722)>	25.1<(5643)>	32.1<(7216)>	25.1<(5643)>	32.1<(7216)>
		Arm	kN<(lbf)>	16.7<(3754)>	18.1<(4069)>	16.7<(3754)>	18.1<(4069)>	18.8<(4226)>	20.4<(4586)>	18.8<(4226)>	20.4<(4586)>
	Traveling Speed, High/Low	km / h<(MPH)>	4.5<(2.7)> / 2.7<(1.6)>								
	Swing Speed	rpm	10.5				9.5				
	Boom Swing Angle, (L / R)	degrees	43 / 65								
Ground Contact Pressure	Rubber track	kPa<(PSI)>	29.3<(4.25)>	28.9<(4.19)>	30.6<(4.44)>	30.1<(4.37)>	33.1<(4.80)>	32.7<(4.74)>	34.3<(4.97)>	33.9<(4.92)>	
	Steel track	kPa<(PSI)>	30.2<(4.38)>	29.8<(4.32)>	31.4<(4.55)>	31.0<(4.50)>	34.0<(4.93)>	33.6<(4.87)>	35.2<(5.10)>	34.8<(5.05)>	
Hydraulic System	Pump Capacity	L / min<(GPM)>	37.4<(9.9)> x 2 [Variable displacement pump] 20.9<(5.5)> x 1, 9.9<(2.6)> x 1 [Gear pump]				37.0<(9.8)> x 2 [Variable displacement pump] 26.2<(6.9)> x 1, 10.8<(2.9)> x 1 [Gear pump]				
	Main Relief Set Pressure	MPa<(PSI)>	20.6<(2988)> x 2 19.6<(2843)> x 1				22.1<(3205)> x 2 21.1<(3133)> x 1				
Blade Dimensions	Width	mm<(ft-in)>	1550<(5'1")>				1740<(5'9")>				
	Stroke, Raise / Lower from G.L.	mm<(ft-in)>	375<(1'3")> / 325<(1'1")>				425<(1'5")> / 370<(1'3")>				
Fuel tank capacity		L<(Gals)>	41<(10.8)>								

Hydraulic P.T.O.

Model	ViO30-6B				ViO35-6B			
	Output	MPa <PSI>	L / min <GPM>		MPa <PSI>	L / min <GPM>		
2200RPM			1100RPM	2200RPM		1100RPM		
Specification								
Combined Flow, Double Actions		19.6 <(2842)>	58.3<(15.4)>	29.15<(7.7)>	22.1<(3204)>	63.2<(16.7)>	31.6<(8.35)>	

YANMAR CONSTRUCTION EQUIPMENT CO., LTD.

Marketing Group  
Sales Planning Division  
1717-1, Oaza Kumano, Chikugo, Fukuoka 833-0055, Japan  
TEL. +81-942-70-8992  
FAX +81-942-53-6855  
yanmar.com

All data subject to change without notice.