



Cross – web Labelling system



Owner's Manual V-6

CWL – 100

Owner's Manual

EFFECTIVE SERIAL #: 0256 +

Revision Date:10/12/2025

Baumann Engineering Pty.Ltd.

CWL – LABELLING MACHINE OPERATING MANUAL

TABLE OF CONTENTS

| | | |
|-----------|---|-----------|
| | Operation Manual Page | 1 |
| | Table of Contents | 2 -4 |
| | Declaration of Conformity | 5 |
| | Acceptance certificate for machine transfer | 6 |
| 1 | General | 7 |
| 1.1 | Information on this Manual | 7 |
| 2 | Preface | 8 |
| 3 | Introduction | 8 |
| 4 | ID – CWL Cross Web package Labeller WM / 780 Project | 9 |
| 5 | Owner’s Responsibility | 10 |
| Chapter 1 | Owner’s duties | 10 |
| Chapter 2 | Responsibilities of the personnel | 11 |
| Chapter 3 | Personnel requirements | 12 |
| Chapter 4 | Instruction | 13 |
| Chapter 5 | Unauthorised persons | 14 |
| 6 | Safety | 15 |
| a. | Dangers to untrained personnel | 15 |
| b. | Dangers to electrical power | 15 |
| c. | Dangers to electrostatic residual potentials | 16 |
| d. | Dangers due to moving components | 16 |
| e. | Dangers due to falling material rolls and other items | 17 |
| f. | Dangers due to sharp edges | 17 |
| g. | Dangers due to pressurised media | 17 |
| h. | Hazardous voltage | 18 |
| i.. | Moving parts, Pinch point hazard | 18 |
| j. | Hot surfaces | 18 |
| k. | Cleaning agents | 18 |
| | Installed safety devices | 19 |
| 7 | Technical Data | 20 |
| | | |
| I.I | Model CWL – 100 / | 21 |
| 8 | Structure and Function | 22 |
| | Model Series CW -100 / CWL- 200 | 22 |
| 1 | Unwinder | 23 |
| 2 | Longitudinal adjustment | 24 |
| 3 | Label transport unit | 25 |
| 4 | Blow Pipe | 25 |

CWL – LABELLING MACHINE OPERATING MANUAL

| | | |
|-----------|---|-----------|
| 9 | Installation | 26 |
| 1 | Installation | 26 |
| 10 | Operating Instruction | 27 |
| I. | Pre – Run Check List | 28 |
| II. | Labelling System | 29 |
| III. | Threading Diagrams Top Labeller | 30 |
| IV. | Threading Diagrams Bottom Labeller | 31 |
| 11 | Label Reel Adjustment | 30 |
| 1.1 | Adjust Label Reel | |
| 12 | Operating Steps / Password log | 31 |
| SCREEN | Power – up Labeller | 31 |
| SCREEN | Puts the labeller in to the STOP mode | 32 |
| SCREEN | Displays the current names of all sets of operating parameters | 32 |
| SCREEN | Pop Up Recipe – Parameter settings | 33 |
| SCREEN | Displays current label dispensed and current live time run time | 33 |
| SCREEN | Machine diagnostics | 34 |
| SCREEN | Manual Mode. this page allows to test the displayed functions | 34 |
| SCREEN | Displays when next service is due | 35 |
| SCREEN | Machine settings: Default machine setting display | 35 |
| SCREEN | Set Up Menu / Edit Label distance and number of rows | 36 |
| SCREEN | Manual Screen/ Labeller can be switched to a manual operation | 36 |
| 13 | Trouble shooting quick guide | 37 |
| 2 | Sensing and dispense | 38 |
| 3 | Sensing and dispense | 39 |
| 4 | Sensing and dispense | 40 |
| 5 | Transport across web | 41 |
| 6 | Transport across web | 42 |
| 7 | Transport across Web | 43 |
| 8 | Label Tamp not reaching surface | 44 |
| 9 | Label tamp stroke varying | 45 |
| 10 | Label tamp banging on return stroke | 46 |
| | LABELLER SPEED | 47 |
| 11 | Blow – On | 48 |
| 12 | Display | 49 |
| 13 | Label Sensor | 50 |
| 14 | Motor Torque | 50 |
| 15 | Power | 51 |
| 16 | Tamp | 52 |

CWL – LABELLING MACHINE OPERATING MANUAL

| | | |
|-----------|--|--------------|
| | Maintenance – Service | 53 |
| 17 | Maintenance Log | 54-55 |
| 14 | PM Preventive Maintenance | 56 |
| 1 – 2 | PM Weekly Check | 57 |
| 3 - 4 | PM Monthly Check | 58-59 |
| | P R O G R A M - P A R A M E T E S | 60-61 |
| | | |
| | Spare Parts | 62-69 |
| | | |
| 27 | Schematics / Electrical | 70 |
| | Technical assistance / PROGRAM REMOTE CONTROL LOG | 70 |
| | Schematics | 70-77 |
| | | |
| | | |
| | | |
| | | |
| | | |
| | | |
| | | |
| | | |
| | | |

CWL – LABELLING MACHINE OPERATING MANUAL

Declaration of Conformity

| | |
|---------------------|--|
| Manufacturer | Baumann Engineering Pty. Ltd. |
| | |
| Address | 8 Powys CTT Castle Hill NSW 2154 Australia |
| | |
| Phone | + 61 (2) 4235 44 686 |
| | |
| E-mail | sales@baumann-industries.com |
| | |
| Website | www.baumann-industries.com |
| | |
| | © Baumann Engineering Australia Pty. Ltd. / All rights reserved |

Product description: CWL bottom – up Labelling station / Serial Number: No. 0256.

The manufacturer declares that the above product meets all the requirements of the machinery Directive.

The above product fulfils the following requirements:

- Cross Web Labeller in special construction
- Plastic punnet labelling machine for WM - Thermoformer

Baumann Engineering Pty.Ltd.

CWL – LABELLING MACHINE OPERATING MANUAL

Acceptance certificate for machine transfer

| | |
|--|---|
| Machine Type: | |
| Machine No.: | |
| The installation was carried out in accordance with the project specification: | |
| Functional test and test run without any deficiencies: | |
| The personnel were trained: | |
| Names of participants: | |
| <ul style="list-style-type: none"> • • • | |
| The operating manual was handed over. | Yes / No |
| There were not found any safety defects arising from the machine, the operation, the settings, or adjustment of the machine. | Yes / No |
| Safety defects were found: | Yes / No |
| Comment: | |
| <u>Customer's Address:</u> Date / Customer's Signature | <u>Address of appointed Dealer:</u> Date / Signature of service engineer |

1. General

1.1 Information on this Manual

This Manual provides important information on how to work with the device safely and efficiently. The Manual is part of the device, must always be kept in the device's direct proximity and should be available for the personnel at any time.

Compliance with all specified safety notes and instructions is a basic requirement for safety at work.

Moreover, the accident prevention guidelines and general safety regulations applicable at the site of implementation of the device must also be complied with.

For better representation of circumstances, the illustrations used are not necessarily to scale and may vary from the actual design of the device.

CWL – LABELLING MACHINE OPERATING MANUAL

2. PREFACE

First, we would like to thank you for choosing our product. We can assure you that you have chosen a product which offers the latest motion control technology and expectational reliability, which derives from computer aided design and the high-quality materials used in this construction.

The CWL – 100 Cross – Web package labelling machine has been designed to meet your specific needs both in terms of yield and versatility.

Please read this manual carefully. It will help you to maintain the machine in prime operating condition and will enable you to maximise its usage. The Baumann Engineer service department is always at your disposal to help you take full advantages of the quality and production capacity of our product.

3. INTRODUCTION

The information in this manual has been prepared by Baumann Engineering Department to familiarise operators and maintenance personnel with the CWL – 100 Cross – web package labelling machine. The machine incorporates some proprietary items for which operating, and maintenance instructions are supplied separately from this manual on a USB flash drive. These will be contained in the documentation package supplied with each machine.

The CWL – 100 Cross – web package labelling machine has been designed to operate using simple, easily understood principles and will operate safely, at high speed, under computer control for long periods.

This manual gives operators and maintenance engineers a general understanding of the machine.

A full and complete understanding of this machine can only be gained by experience, supported by a study of this manual and the associated publications and training provided by Baumann Engineers. Personnel using or repairing this machine should have received the appropriate training to ensure that they are familiar with possible dangers. All safety interlock equipment must be maintained and regularly checked for satisfactory operation.

Baumann Engineering Pty.Ltd. has a policy of continual research and development, and we reserve the right to make such modifications and design changes as are considered necessary. For this reason, illustrations, and, given in this manual may differ in detail from machines in current production.

No part of this document may be produced or copied in any way without prior written permission from Baumann.

Baumann Engineering Pty.Ltd.

CWL – LABELLING MACHINE OPERATING MANUAL

4. ID / CWL – Cross-Web package labeller / WM – 780 Project

| | |
|-----------------------|---|
| Labeller No. 1 | |
| Model No. | CWL – 100 Cross-Web package labeller |
| Serial No. | CWL 0256 |
| Ship Date: | 21 March 2022 |
| Owner: | Profile Packaging Pty.Ltd. |
| Location: | 18 Colling wood Street Osborne Park WA 6017 |

Construction: Aluminium, Stainless Steel Delrin, PET - P construction.

Note: Specifications are subject to change any time.

For Sales, Call:

e-mail: sales@baumann-industries.com

For Technical Support, Call + 61 2 423544686

Baumann Engineering Pty.Ltd.

5. OWNERS RESPONSIBILITY

Chapter 1 Owner's duties:

The device is used commercially. Thus, the owner of the device is subject to legal industrial safety and obligations.

The warning and safety instructions in this Manual, the safety, accident prevention guidelines and environment protection regulations, applicable at the site of operation must be completed with the following,

- The owner must inform himself of applicable health and safety regulations.
- The owner must determine additional potential hazards that arise due to the specific working conditions prevailing at the site where the device is implemented.
- The owner must implement the necessary rules of conduct for the operation of the device at the site of implementation by means of the instructions.
- The owner must check regularly throughout the entire implementation period the device, whether the work instructions created by him comply with the current legislation.
- If necessary, the owner must adapt the instructions to new regulations, standards and operating conditions to new regulation standards and operating conditions.
- The owner must clarify regulate and specify the responsibilities for the installation, operation, maintenance, and cleaning of the device.
- The owner must ensure that all employees dealing with the device have read and understood this Manual. In addition, the owner must train personnel in handling the device at regular intervals and inform personnel of possible danger.
- The owner must provide personnel carrying out work on the device with required and recommended protective equipment and check for continuous compliance of the compulsory wearing of protective equipment.
- The owner must provide the required clearances and enough lighting for safe operation and ensure continuous order and cleanliness at the installation site of the device and its surroundings.

In addition, the owner is responsible for ensuring that the device is always in a technically perfect condition. Therefore, the following applies.

- The owner must ensure that the maintenance intervals described in this Manual are complied with.
- The owner must have all safety devices inspected regularly for completeness and function.

OWNERS RESPONSIBILITY

Chapter 2 Responsibilities of the personnel:

The device is used commercially. Thus, the personnel are subject to legal industrial safety obligations.

In additions to the warnings and safety notes in this manual, the safety, accident prevention guidelines and environmental protection regulations, applicable at the site of implementation must be complied with.

In particular:

- The personnel must inform itself of applicable health and safety regulations.
- The personnel must comply with the rules of conduct for the operation of the device at the site of implementation specified in the operating instructions.
- The personal must properly fulfil the specified requirements in terms of operation, maintenance, and cleaning of the device.
- The personnel must have read and understood the Manual before starting any work.
- The personal must use the specified and recommended protective equipment.

In addition, any employee working on the device is responsible for ensuring in its field of responsibility that the device is always in a technically perfect condition.

Therefore, the following applies:

- The personnel must ensure that the maintenance intervals described in this Manual are complied with.
- The personnel must have all safety devices inspected regularly for completeness and function.

OWNERS RESPONSIBILITY

Chapter 3 Personnel requirements:

The different tasks described in this Manual lay down various requirements regarding the qualification of persons entrusted with these tasks.

Insufficiently qualified personal may not assess risks related to the operation of the device and put themselves and others in danger.

Any tasks at the device may only be carried out by persons able to carry out their tasks properly and reliably and who comply with the requirements specified for their task.

- Persons whose reaction capability is impaired. e.g., through drugs, alcohol or medication are not allowed to carry out at work.
- When selecting the personnel, stipulations regarding age and occupation applicable at the site of implementation must be observed.
- Insufficiently qualified personnel must be kept away from the work area.

OWNERS RESPONSIBILITY

Chapter 5 Unauthorised persons:

No access for unauthorised persons. Unauthorised persons do not know the dangers in the work area and may cause serious injury to themselves and others.

The following persons are deemed unauthorised persons:

- Any person who has not or not completely read the Manual or who has not properly understood it.
- Any person not complying with the personnel requirements (minimum qualification). See page 8.
- Any person who has not been instructed by the owner or its representative for the activity and/or who has not been commissioned.

Unauthorised persons are not allowed to access the work and danger area of the machine.

- In doubt, address the respective persons and direct them to leave the work and danger area of the machine.
- Interrupt work on the machine if unauthorised persons are present in the work and danger area.

6. SAFETY

a. Dangers due to untrained personnel:

Untrained and unqualified personnel pose a risk to itself and other persons.

- Work may only be carried out by personnel experienced in the performance of the commissioned tasks and informed about the dangers.
- Responsibilities of the personnel must be clearly specified for the respective live phases.
- Only employ sufficiently trained and authorised personnel having the qualifications specified in the personnel requirements.
- Personnel to be trained may only carry out work under permanent supervision by an experienced expert.

b. Dangers due to electrical power:

Touching conductive parts causes a danger to live, this may result in severe injuries or death. In addition, electrical components which are switched on may carry out uncontrolled movements.

- Work on electrical systems and equipment must only be carried out by a skilled electrician and in accordance with electro-technical regulations. Before starting work on the electrical system:
 - De-energise the device.
 - Secure it against being switched on again.
 - Make sure that motors/drives and moving parts are standing still.
 - Cordon off the work area and mark it with a warning sign.
 - Check for de-energisation.
 - Earth and short circuit.
 - Cover neighbouring parts.
- Only use voltage isolated tools.
- Regularly check electrical equipment for damage. Danger due to loosen cable connections and burnt cables. Remedy defects immediately and have repairs carried out.
- Do not bridge fuses or render them ineffective.
- When replacing defective fuses make sure you use the correct amperage.
- Keep moisture away from conductive parts.
- Always keep control cabinets locked. Access is only permitted to authorised personnel.

SAFETY

c. Dangers due to electrostatic residual potentials:

Friction caused by paper, film, conveyor belts and other non-conductive materials may build electrostatic potentials and result in a danger to persons. Discharge may result in an electrical shock or in secondary accidents due shock reaction as a result of discharge. In case of fear of repeated shocks, uncertainty may lead to mistakes. Furthermore, the health of persons is generally impaired in cases of permanent charging.

- Ensure potential equalisation prior to touching parts.
- Wear conductive clothing and shoes.

d. Dangers due to moving components:

Freely accessible moving device components can create hazard zones which may cause severe injuries or death. There is a danger of being caught, pulled in or entrained by moving parts.

If the hazard zone cannot be spatially separated from the work area, the following safety measures must be observed.

- Keep a safety distance to hazard zones.
- Wear tight fitting clothing.
- Do not wear rings, chains, neckless, and other jewellery.
- Wear a hair net in case of long hair.
- Do not remove protective covers.
- Do not put safety devices and/or functions out of operation and do not render them inoperative or bypass them.
- Never reach in to running equipment.
- Before starting any work in hazard zones, always wait for the standstill of lagging components and for the autonomous discharge of residual energies.
- Secure the device from being switched on again to avoid unintentional movements of components. Cordon off the work area and mark it with a warning sign.

SAFETY

e. Dangers due to falling material rolls and other items:

During operation and especially in case of replacement, material rolls may fall and causes injuries.

- Always hold material rolls tight with both hands when handling them and secure them as specified after insertion.
- Always wear personal protective equipment when setting up and carrying out maintenance or repair work.

f. Dangers due to sharp edges:

Sharp edges, sharp corners and sharp paper edges may result in abrasion, scratches, and cuts.

- Always pay attention and caution when carrying out work.
- Wear personal protective equipment.

g. Dangers due to pressurised media:

Pressurised pipes and hoses (for example compressed-air supply, media supply) may move uncontrollably and cause severe injuries in case of improper handling. Media may leak from pressurised components under high pressure in case of improper handling or a defect and cause severe injuries.

Before start working on these components:

- Establish an unpressurised condition.
- Discharge residual energies.
- Check the system for a depressurised condition.
- Make sure that the medium is not unintentionally leaking.
- Defective components which are pressurised during operation must be immediately replaced.
- In general, work on pressurised components may only be carried out by appropriately qualified experts (pneumatic experts)

SAFETY

Read and understand owner's manual before using this machine. Failure to follow operating instructions could result in personal injury or damage to equipment.

DANGER

h. Hazardous voltage.

Disconnect and lockout power before servicing machine or cleaning. Do not remove panels unless power has been disconnected and locked out at risk of electric shock hazard.

WARNING

i. Moving parts. Pinch point hazard.

Do not put hands in to machine while running. Ensure that the conveyor is not operating prior to freeing product or handling conveyor. Conveyor creates pinch point and draw in prior to freeing product or handling conveyor. Conveyor creates pinch point and draw in hazards.

CAUTION

j. Hot surfaces. Do not touch.

To avoid skin burns, disconnect and lockout power. Allow surfaces to cool before servicing or cleaning.

k. Cleaning agents.

Do not get the cleaning agents in eyes, or skin, or clothing. Always wear rubber gloves, goggles, and protective clothing when contact is likely. Consult product manufacturer for specific details.

Signal words used in classification of potential hazards are defined as follows:

1. **DANGER:** Indicates an imminently hazardous situation, which, if not avoided, may result in death or serious injury.
2. **WARNING:** Indicates a potentially hazardous situation, which, if not avoided, could result in death or serious injury.
3. **CAUTION:** Indicates a potentially hazardous situation, which, if not avoided, may result in minor or moderate injury. Caution also indicates that may cause property damage

CWL – LABELLING MACHINE OPERATING MANUAL

SAFETY

I. Installed safety devices:

Non-functioning bridged or disabled safety devices are not protecting against dangers and may cause severe injury or death.

- Before switching on the system, always make sure that all safety devices are properly installed and working.
- Never disable safety devices.
- Always keep safety devices freely accessible.



Safety bar (Finger Jam)

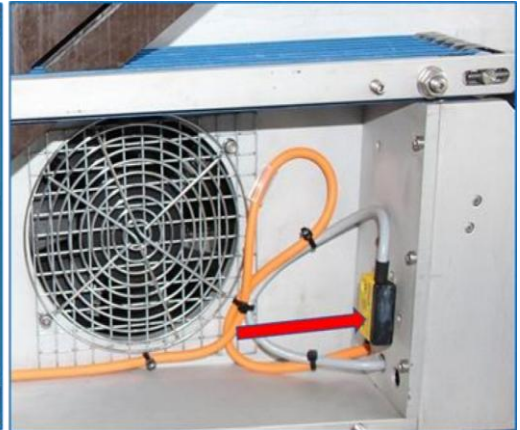

Safety Switch,/ Vacuum Box Cover

CWL – LABELLING MACHINE OPERATING MANUAL

7. TECHNICAL DATA

I. Model CWL – 100

The following data are applicable to all models of the series CWL -100

Note:

The data on dimensions of the automatic cross-web labelling machine are included in the dimension sheet in the annex to this operating manual.

| Parameter | Value |
|-----------------------------------|--------------------------------------|
| Electrical supply | |
| Voltage and number of phases | 240 – VAC, 50/60 Hertz, single phase |
| Max. power consumption | 1500 VA |
| Normal current | 4 A |
| Circuit breaker: Tripping current | 10 A. |
| Tripping current characteristic | Characteristic C |
| Pneumatic supply | |
| Pressure | 6 bar |
| Quality | Compressed air, oil free, clean |
| Air consumption CWL-100 | 3.7 NL |

Work area:

| Specification | Value |
|------------------------------------|---|
| Temperature range | 5 – 30 ° C |
| Relative humidity, non- condensing | 25 – 80 % |
| Conditions | Protect devices components and media containers from sun and heat. Avoid direct moisture, dust load and frost. |
| Noise emission | ≤ 70 Db (A) |

Operating time:

| Specification | Value |
|-------------------------------|-----------------------------------|
| Uninterrupted operation, max. | Suitable for continuous operation |
| Maintenance intervals, min. | 3 months |

Baumann Engineering Pty.Ltd.

CWL – LABELLING MACHINE OPERATING MANUAL

TECHNICAL DATA

II. Model CWL – 100

Labelling Station

| Specification | Value CWL - 100 |
|----------------------------------|-----------------|
| Passage width | 100 mm |
| Label reel (max. outer diameter) | 380 mm |
| Label reel weight | 12 Kg |
| Label reel (core diameter) | 76 (40) mm |
| Backing paper reel max | 100 mm |
| Maximum dispensing speed | 40 m/min |
| Drive | Step motor |
| Increment | 0.1 mm |

Transporting unit

| Specification | Value |
|----------------------------|------------|
| Film width | 720 mm |
| Transport width | 650 mm |
| Label size (min. diameter) | 30 mm |
| Max. speed transport unit | 40 m/ min |
| Drive | Step motor |
| Increment | 0.1 mm |

Longitudinal stroke unit (option)

| Specification | Value | Value CWL – 200 |
|------------------------|--------|-----------------|
| Maximum amount of pull | 800 mm | 800 mm |
| Travel distance max. | 400 mm | 400 mm |

CWL – LABELLING MACHINE OPERATING MANUAL

8.STRUCTURE AND FUNCTION

Model Series CWL 100

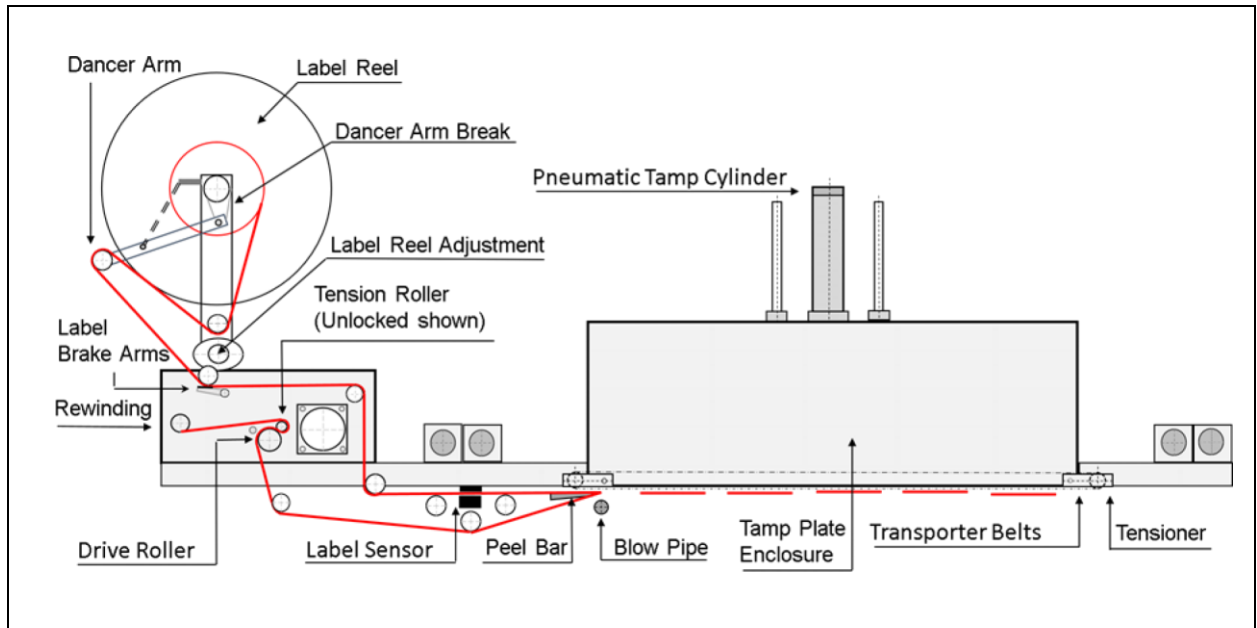

The labels are dispensing onto a transporting belt, are separated; and are transported crosswise to the direction of movement of the packaging machine conveyor over the finished packages. The labels are positioned and pressed on to the packages during the stand still of the packing machine conveyor.

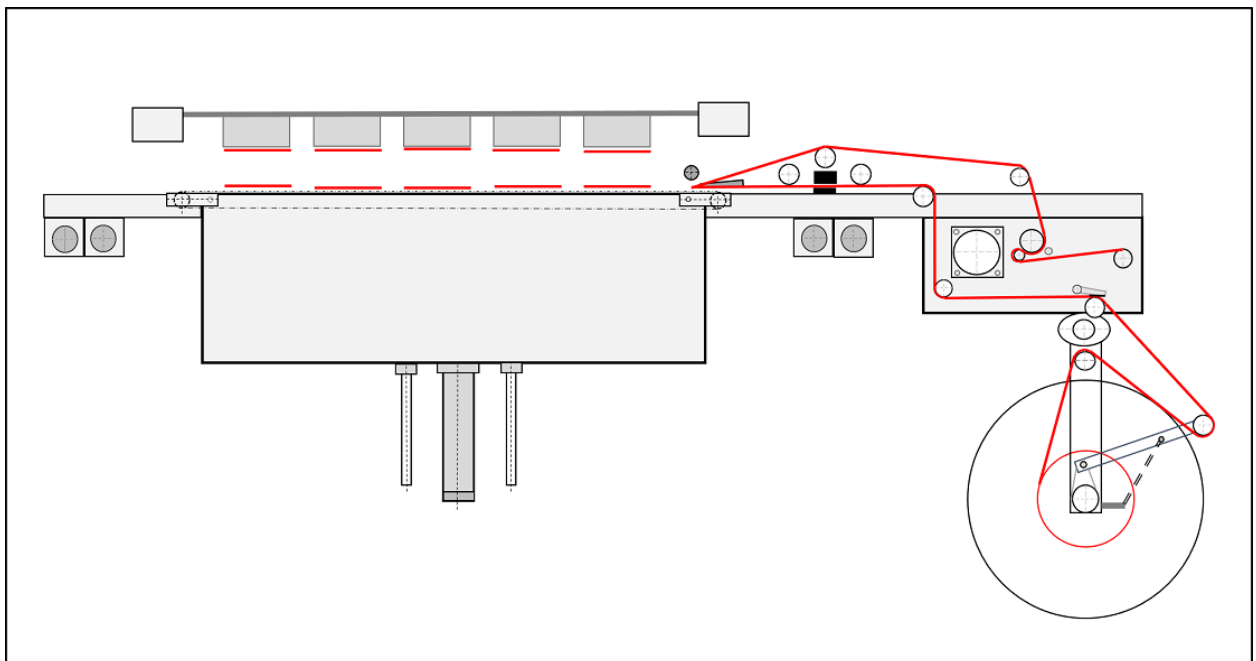

It is possible to label more than one package row during one packaging machine. Cycle by way of using the optional longitudinal stroke unit transporting the complete cross-web labeller by an adjustable distance.

Baumann Engineering Pty.Ltd.

STRUCTURE AND FUNCTION

1. Unwinder:



The unwinder receives the label tape. The flanged disks are secured with quick release buckles.

The flanged disks have two functions:

- They prevent the label reel from slipping sideways.
- They fix the label reel so that the swing arm can release or engage to the brake band

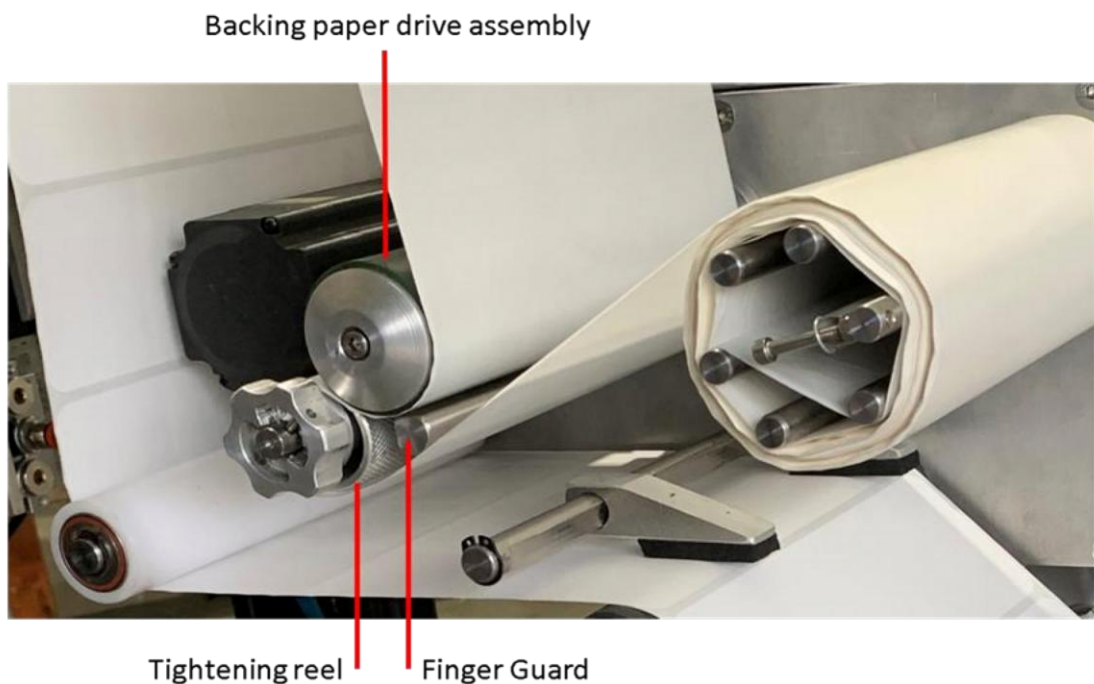

The labelling station is responsible for the transport of the backing strip. After the labels have been detached from the backing strip, the backing strip is wound on to a coiler.

STRUCTURE FUNCTION

2. Longitudinal adjustment:

The longitudinal set position of the labels to the pack can be manually adjusted.

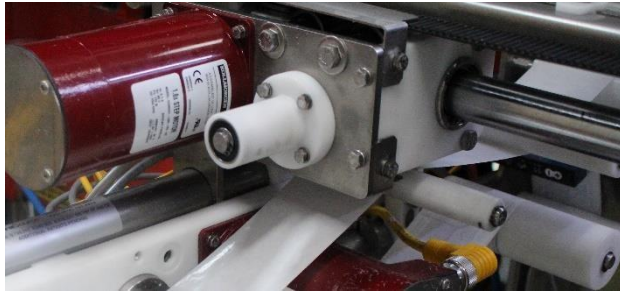

Option:

For multiple package rows during one packaging machine cycle using the longitudinal transport unit for shifting the cross-web labeller by automatic adjustable distance.

CWL – LABELLING MACHINE OPERATING MANUAL

STRUCTURE AND FUNCTION

3. Label transport unit:

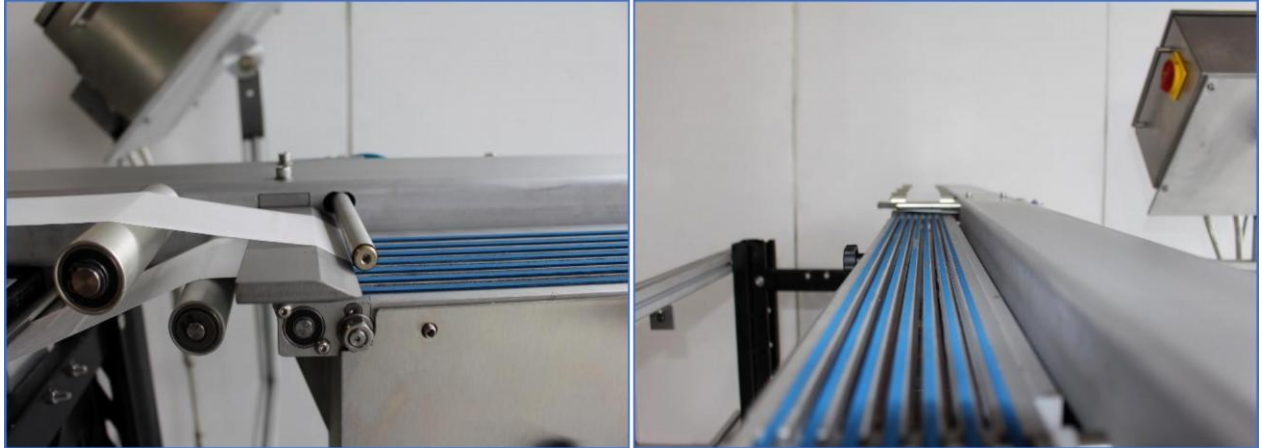

The label transporting unit will suck off the labels released from the backing strip and will transport the labels to the defined position.

An integrated pusher will transfer the labels on to the product.

4. Blow pipe:



Air blow system to keep the label down during label transfer (low pressure)

9.INSTALLATION

1. Installation:

The installation of the CWL Cross-web Package Labeller should be performed by a Baumann Service technician or qualified Packaging Machine OEM technician. If you are installing the CWL Cross-web Package Labeller, contact Baumann Services at + 61 2 423544686 for telephone assistance.

NOTE: 240 VAC POWER MUST BE MAINTAINED CONTINUOUSLY TO THE LABELLER IN HARSH ENVIRNMENTS.

Model Identification

Baumann Engineering Pty. Ltd.

8 Powys CCT.

Castle Hill NSW 2154 Australia

Phone No. + 61 (2) 4235 44686

e-mail: sales@baumann-industries.com

Model No. _____

Serial No. _____

The CWL Cross-web Labeller model number is a digit code that when broken down describes the separate components that make up your Labeller. The example below shows how.

10. Operating Instruction

I. Pre-Run Check List:

- ✓ Verify tension roller is locked down.
- ✓ Verify label brake arms are down.
- ✓ Verify sure label reel is tightened against label roll.
- ✓ Verify sure dancer operation stops label roll from unwinding.
- ✓ Verify threading, particularly in peel bar area and label sensor area.
- ✓ Check pressure regulator.

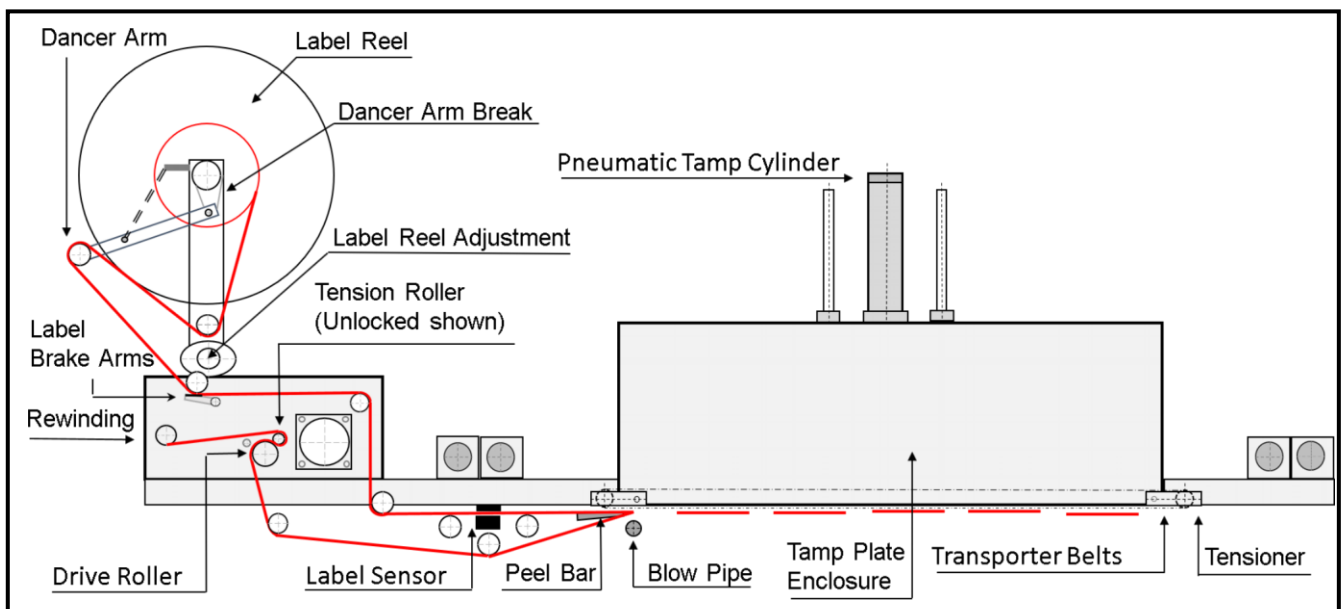

Operation Instruction

II. Labelling System:

The system controller holds up to 20 product recipes which may be changed when the labeller is stopped. When a recipe is selected for download, all four labellers are updated simultaneously.

1. Upon power up, the touch screen will show the start screen.
2. The CWL Cross-web Labeller is programmed without changing Tools.

- **Thread the label roll into the labeller. Ensure tension roller is engaged.**
- **Perform a label sensor sensitivity adjustment.**

CWL – LABELLING MACHINE OPERATING MANUAL

Operation Instruction

Operation Instruction

III. Threading Diagrams bottom labeller:

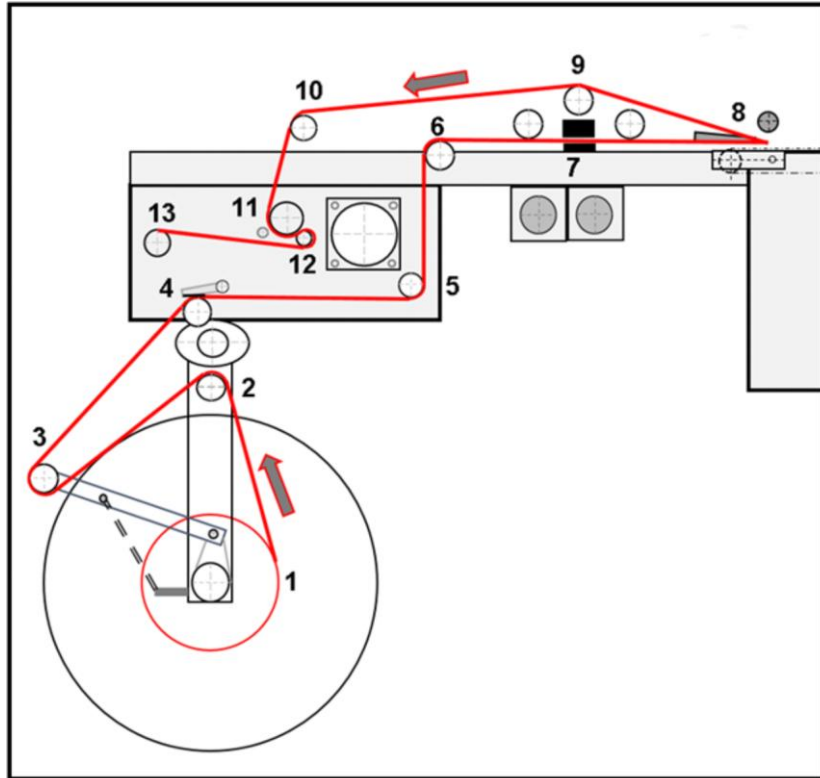

Bottom Right

CWL – LABELLING MACHINE OPERATING MANUAL

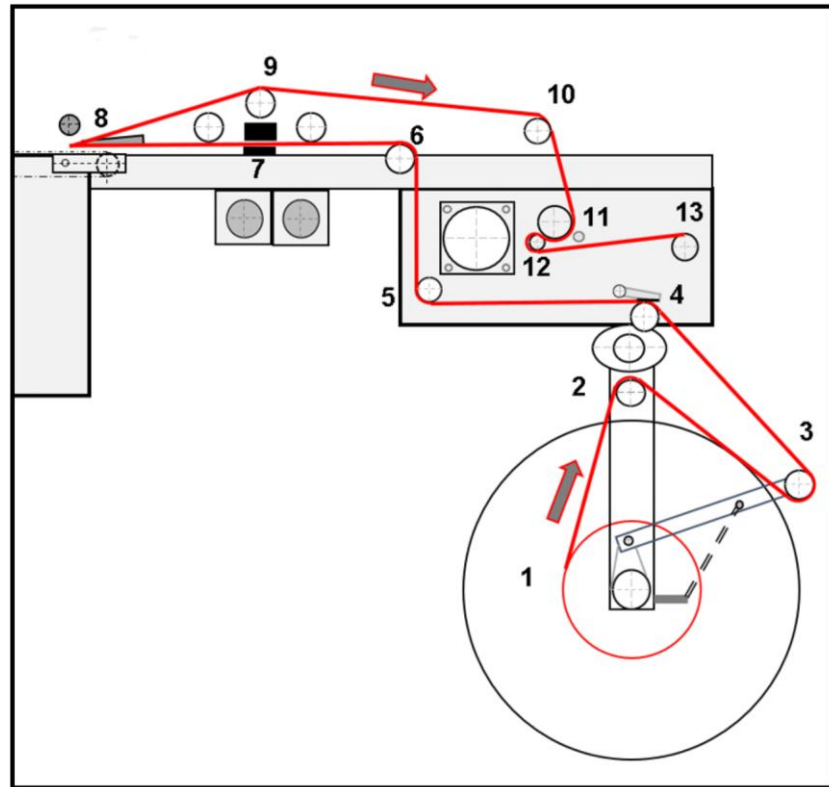

Bottom Left

Label reel can be adjusted to different positions to provide the optimal ergonomic loading position

(Depending on installation)

CWL – LABELLING MACHINE OPERATING MANUAL

12. Operating Steps

1. Power – up Labeller:

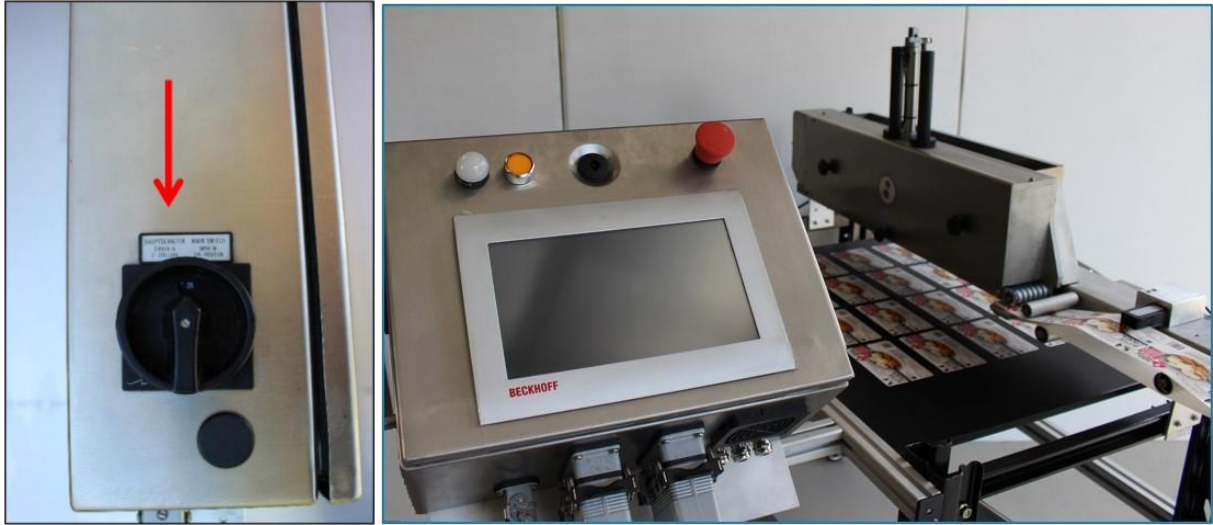

| | | | |
|------------------|------------|----------------|------------------------|
| PASSWORD: | LOG | SERVICE | MACHINE SETTING |
| | 2 | 9294 | 122 44 221 |

Operating Steps

2. Touch Screens

| | | | | | |
|---|---------------|---|-----------------------------------|---------------|---------|
| CWL – 150 Home Automatic | | | 16 – 03 – 2022 | 13:43 | |
| Motor Status: | 0 | No Error | Operator | | |
| Current Label Selection: Code: F Label Name: FOREST HILL | | | Automatic Mode Control | | |
| Labeller Status | | Label Counter: 770 Remaining: 1230 Missing Labels: 0 Speed: 400 Length: 64.7 Pos. error: 0.0 | | | |
| Disabled Low Label Warning | | | | | |
| | Label Recipes | Machine Statistics | Machine Diag. | Manual Mode | Service |
| | | | Set Up Menu | Manual Screen | |

Puts the labeller in to the RUNNING mode. Also allows you to select a new program menu.

CWL – LABELLING MACHINE OPERATING MANUAL

| | | | | | |
|---|---------------|---|-----------------------------------|---------------|---------|
| CWL – 150 Home Stopped | | | 16 – 03 – 2022 | 13:43 | |
| Motor Status: | 0 | No Error | Operator | | |
| Current Label Selection: Code: F Label Name: FOREST HILL | | | Automatic Mode Control | | |
| Labeller Status <h2>Stopped</h2> | | Label Counter: 770 Remaining: 1230 Missing Labels: 0 Speed: 400 Length: 64.7 Pos. error: 0.0 | | | |
| Disabled Low Label Warning | | | | | |
| | Label Recipes | Machine Statistics | Machine Diag. | Manual Mode | Service |
| | | | Set Up Menu | Manual Screen | |

Puts the labeller in to the STOP mode. Also allows you to select a new program menu.

| CWL – 150 Label Recipes | | | | 16 – 03 – 2022 | 13:43 | | | | | | | | | | | | | | | | | | | | | | | | | | | | | | | | | | | | | | | | | |
|---|---------------|---------------------|-----------------|----------------|---------|------------|-----------------|---|-----|---------------------|-----|---|---|-------------|------|---|--|--|--|---|--|--|--|---|--|--|--|---|--|--|--|---|--|--|--|---|--|--|--|---|--|--|--|--|--|--|
| Motor Status: | 0 | No Error | Operator | | | | | | | | | | | | | | | | | | | | | | | | | | | | | | | | | | | | | | | | | | | |
| <table border="1"> <thead> <tr> <th></th> <th>Code</th> <th>Label Name</th> <th>Total Dispensed</th> </tr> </thead> <tbody> <tr><td>1</td><td>A15</td><td>Sample Label 240 mm</td><td>400</td></tr> <tr><td>2</td><td>F</td><td>Forest Hill</td><td>6000</td></tr> <tr><td>3</td><td></td><td></td><td></td></tr> <tr><td>4</td><td></td><td></td><td></td></tr> <tr><td>5</td><td></td><td></td><td></td></tr> <tr><td>6</td><td></td><td></td><td></td></tr> <tr><td>7</td><td></td><td></td><td></td></tr> <tr><td>8</td><td></td><td></td><td></td></tr> <tr><td>9</td><td></td><td></td><td></td></tr> </tbody> </table> | | | | | Code | Label Name | Total Dispensed | 1 | A15 | Sample Label 240 mm | 400 | 2 | F | Forest Hill | 6000 | 3 | | | | 4 | | | | 5 | | | | 6 | | | | 7 | | | | 8 | | | | 9 | | | | | | |
| | Code | Label Name | Total Dispensed | | | | | | | | | | | | | | | | | | | | | | | | | | | | | | | | | | | | | | | | | | | |
| 1 | A15 | Sample Label 240 mm | 400 | | | | | | | | | | | | | | | | | | | | | | | | | | | | | | | | | | | | | | | | | | | |
| 2 | F | Forest Hill | 6000 | | | | | | | | | | | | | | | | | | | | | | | | | | | | | | | | | | | | | | | | | | | |
| 3 | | | | | | | | | | | | | | | | | | | | | | | | | | | | | | | | | | | | | | | | | | | | | | |
| 4 | | | | | | | | | | | | | | | | | | | | | | | | | | | | | | | | | | | | | | | | | | | | | | |
| 5 | | | | | | | | | | | | | | | | | | | | | | | | | | | | | | | | | | | | | | | | | | | | | | |
| 6 | | | | | | | | | | | | | | | | | | | | | | | | | | | | | | | | | | | | | | | | | | | | | | |
| 7 | | | | | | | | | | | | | | | | | | | | | | | | | | | | | | | | | | | | | | | | | | | | | | |
| 8 | | | | | | | | | | | | | | | | | | | | | | | | | | | | | | | | | | | | | | | | | | | | | | |
| 9 | | | | | | | | | | | | | | | | | | | | | | | | | | | | | | | | | | | | | | | | | | | | | | |
| Select Label ID: 1 Code: A15 Name: Sample Label 240 mm | | | | | | | | | | | | | | | | | | | | | | | | | | | | | | | | | | | | | | | | | | | | | | |
| | Label Recipes | Machine Statistics | Machine Diag. | Manual Mode | Service | | | | | | | | | | | | | | | | | | | | | | | | | | | | | | | | | | | | | | | | | |
| | | | Set Up Menu | Manual Screen | | | | | | | | | | | | | | | | | | | | | | | | | | | | | | | | | | | | | | | | | | |

This screen displays the current names of all sets of operating parameters (programs). You can add or delete a program. All new programs are automatically saved.

CWL – LABELLING MACHINE OPERATING MANUAL











| CWL – 150 Label Recipes | | | | 16 – 03 – 2022 | 13:43 | | |
|--|-----|---------------------------------|------------|--|-----------------------------|-------|--|
| Motor Status: | 0 | No Error | Operator | | | | |
| Recipe Edit - Parameters | | | | | | | |
| Code | | Current Label Selection: | | Code and Name are editable on the page | | | |
| 1 | A15 | ID: 1 | Code: A 15 | | | | |
| 2 | F | Name: Sample Label 240 mm | | | | | |
| 3 | | | | Dispensing Speed | Speed limit 450 mm /sec. | 280.0 | |
| 4 | | | | Labels per Roll | | 3200 | |
| 5 | | | | Label Position Dispensing Edge | | 2.0 | |
| 6 | | | | Label dispense delay | | 0.0 | |
| 7 | | Select Label | | | | | |
| 8 | | ID: 1 Code: A15 | | | | | |
| 9 | | Name: Sample La | | | | | |
| <div style="display: flex; justify-content: space-between;"> Label Recipes Machine Statistics Machine Diag. Manual Mode Service Set Up Menu Manual Screen </div> | | | | | | | |

Pop Up Recipe – Parameter settings. Any editing done on a parameter in a program is automatically saved.





| CWL – 150 Machine Statistics | | | | 16 – 03 – 2022 | 13:43 | |
|--|---|----------------|-------|----------------|-------|--|
| Motor Status: | 0 | No Error | Admin | | | |
| Current total label dispensed | | 73 pcs | | | | |
| Current run time | | 3 hrs 57 mins | | | | |
| Live time label dispenses | | 796 pcs | | | | |
| Live time run time | | 52 hrs 20 mins | | | | |
| <div style="display: flex; justify-content: space-between;"> Label Recipes Machine Statistics Machine Diag. Manual Mode Service Set Up Menu Manual Screen </div> | | | | | | |

Displays current label dispensed and current live time run time.

CWL – LABELLING MACHINE OPERATING MANUAL

| CWL – 150 Machine Diagnostics | | | 16 – 03 – 2022 | 13:43 |  | | | | |
|--|---------------|---|----------------|-------------|---|-------------|---------------|---|---|
| Motor Status: | 0 | No Error | Admin | | | | | | |
| Labeller Inputs  Product Sensor  Label Sensor  Rewind Full Sensor | | Stepper Motor V Supply: 4769 mv C Supply: 4769 mv 9010 : OD: 2504 ma 9010 : OB: 0 ma | | | | | | | |
| Labeller Outputs  Automatic / Ready Light  Rewind Full Light  Error Light | | | | | | | | | |
|  | Label Recipes | Machine Statistics | Machine Diag. | Manual Mode | Service | Set Up Menu | Manual Screen |  |  |

Machine diagnostics.

| CWL – 150 Manual Mode | | | 16 – 03 – 2022 | 13:43 |  | | | | |
|---|--------------------------|--------------------|----------------|-------------|---|-------------|---------------|---|---|
| Motor Status: | 0 | No Error | Admin | | | | | | |
| Enable Labeller | Jog Labeller & Vac. Belt | Jog Speed: 10.0 | | | | | | | |
| Enable Vac Belt | Label Feed | | | | | | | | |
| Vacuum Suction | Blow Pipe Valve | | | | | | | | |
| Home Labeller | Dispense Row | | | | | | | | |
| | Raise Tamp | | | | | | | | |
| | Dispense & Tamp | | | | | | | | |
|  | Label Recipes | Machine Statistics | Machine Diag. | Manual Mode | Service | Set Up Menu | Manual Screen |  |  |

Manual Mode. this page allows to test the displayed functions. Labeller must be in stop position.

CWL – LABELLING MACHINE OPERATING MANUAL

CWL – 150 Service
16 – 03 – 2022 13:43

Motor Status: 0 No Error Admin

Motor Status:

Conveyor Mode

Disabled

Low Label Warning

Machine Service

| | |
|----------------------------------|----|
| Total Days in Service | 1 |
| Remaining Days till next Service | 89 |
| Total Days till next Service | 90 |
| Warning Days till next Service | 14 |
| | |

Reset Warning for 24 Hrs.

Maintenance / Service

Service: sales@baumann-industries.com

Label Recipes
 Machine Statistics
 Machine Diag.
 Manual Mode
 Service
 Set Up Menu
 Manual Screen

Admin Service: Displays when next service is due. New service date can be edited.

CWL – 150 Machine Settings
16 – 03 – 2022 13:43

Motor Status: 0 No Error Admin

| | | |
|-----|----------------------------|---|
| 101 | Product Sensor Detect Edge | Leading Edge <input type="button" value="v"/> |
| 102 | Label Sensor Detect Edge | Leading Edge <input type="button" value="v"/> |
| 103 | Rewind Sensor Detect Edge | Leading Edge <input type="button" value="v"/> |
| 104 | Machine edge compensation | 260 |
| 105 | Machine acceleration | 1.0 |
| 106 | Machine deceleration | 1.0 |

Save

Label Recipes
 Machine Statistics
 Machine Diag.
 Manual Mode
 Service
 Machine Settings
 Set Up Menu
 Manual Screen

Machine settings: Default machine setting display.

CWL – LABELLING MACHINE OPERATING MANUAL

| CWL – 150 Set Up Menu | | | 16 – 03 – 2022 | 13:43 | |
|-----------------------|---|----------|----------------|-------|--|
| Motor Status: | 0 | No Error | Operator | | |

| | | | | | | | |
|----------------------|-------|----------------|-------|----------------------|------|---------------------------|-----|
| Film Width | 720.0 | Label Distance | 550.0 | Number of Labels | 4 | Vac Belt Speed | 400 |
| Dispense Edge Offset | 2 | | | First Label Position | 40.0 | Labeller Speed | 400 |
| | | | | | | Jog Speed | 10 |
| | | | | | | Label Start Delay (ms) | 0 |
| | | | | | | Vac Belt Start Delay (ms) | 0 |
| | | | | | | Tamp Wait Time (ms) | 2 |
| | | | | | | Tamp Up Time (ms) | 250 |
| | | | | | | Blow Air Pulse Start (ms) | 1 |
| | | | | | | Blow Air Pulse Stop (ms) | 200 |

| | | | | | | | | | |
|--|---------------|--------------------|---------------|-------------|---------|-------------|---------------|--|--|
| | Label Recipes | Machine Statistics | Machine Diag. | Manual Mode | Service | Set Up Menu | Manual Screen | | |
|--|---------------|--------------------|---------------|-------------|---------|-------------|---------------|--|--|

Set Up Menu: Label distance and number of rows can be edited for each program,

| CWL – 150 Manual Screen | | | 16 – 03 – 2022 | 13:43 | |
|-------------------------|---|----------|----------------|-------|--|
| Motor Status: | 0 | No Error | Admin | | |

M

| | | | | | | | | | |
|--|---------------|--------------------|---------------|-------------|---------|-------------|---------------|--|--|
| | Label Recipes | Machine Statistics | Machine Diag. | Manual Mode | Service | Set Up Menu | Manual Screen | | |
|--|---------------|--------------------|---------------|-------------|---------|-------------|---------------|--|--|

Manual Screen: Labeller can be switched to a manual operation. (Single trigger)

CWL – LABELLING MACHINE OPERATING MANUAL

13. TROUBLE SHOOTING

1. Trouble shooting quick guide

| | |
|---|---|
| Label feed does not switch off, labels continue to run | <ul style="list-style-type: none">• Label material was inserted in a wrong way• Wrong PEC adjustment• PEC is dirty• Labels run out of the PEC |
| Labels are misaligned on the product | <ul style="list-style-type: none">• Feed unit not closed• Paper brake not applied• Deflection rollers are pull-out with glue• Label glue on dispenser edge• Torsion spring in the feed unit is broken• Label material is inserted in a wrong way |
| Control cannot be switched on | <ul style="list-style-type: none">• No supply voltage• Circuit Breaker tripped• Power plug loosened |
| Backing paper is not wound up | <ul style="list-style-type: none">• Toothed belt is torn• Friction disks are worn |
| Control is switched on, but Stepper motor has no holding torque | <ul style="list-style-type: none">• Fuse for motor voltage is damaged• Stepper motor step is in fault condition (LED motor drive shines red)• Cable rupture |
| Stepper motor is bucking | <ul style="list-style-type: none">• Dispenser acceleration too high• Rewind reel for backing paper is full• Glue residues on the deflection rollers• Dispenser edge worn |
| No start signal | <ul style="list-style-type: none">• Automatic operation not switched on• Packing machine does not provide any start signal |
| Tamp blade not moving up | <ul style="list-style-type: none">• No air pressure for pneumatic cylinder• Label stuck between tamp blade• Read switch on air cylinder faulty |

CWL – LABELLING MACHINE OPERATING MANUAL

TROUBLE SHOOTING

2. Sensing and dispense

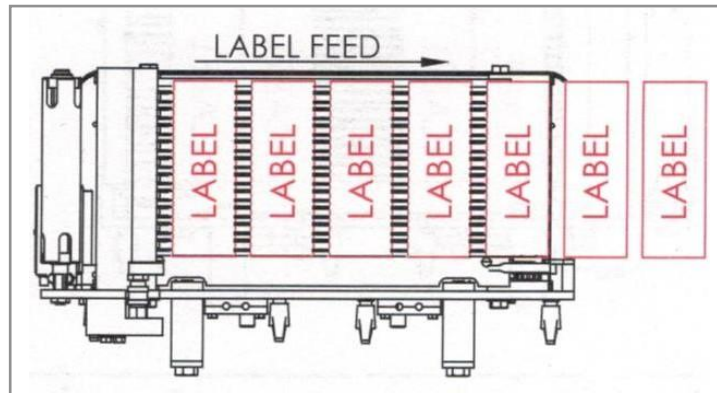

| Problem | Indications | Remedy |
|--|--|--|
| Labels run out quickly without stopping. | Labels mis thread. | Confirm labels are running in forked gap of sensor and not threaded around blow – on tube. |
| | Label sensor not set for current material. | Adjust sensor sensitivity per instructions. |
| | Label speed to high. | Lower label speed (or have maintenance increase acceleration rate in maintenance screen). |
| | Label peel over parameter is too low. | Increase peel parameter. |

CWL – LABELLING MACHINE OPERATING MANUAL

TROUBLESHOOTING

3. Sensing and dispense

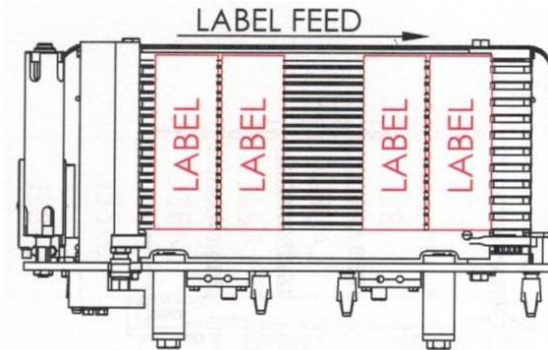

| Problem | Indications | Remedy |
|---|--|-----------------|
| Labels dispense two at the time, consistently in pairs. | Label peel over distance sensor / label position is set to high. | Adjust distance |

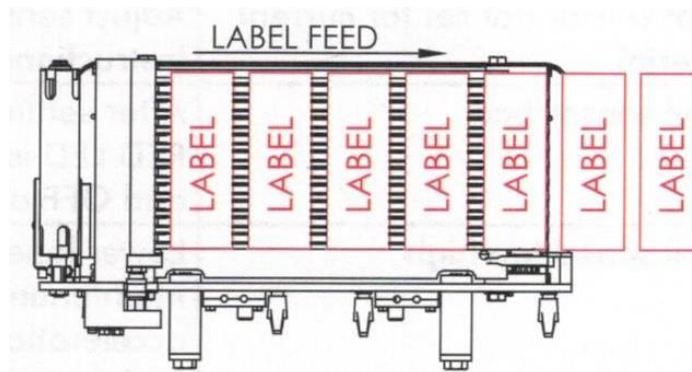

| Problem | Indications | Remedy |
|--|-----------------------------------|---|
| Labels dispense two at the time, occasionally. | Label sensor sensitivity not set. | Adjust sensor sensitivity per instructions, |

CWL – LABELLING MACHINE OPERATING MANUAL

TROUBLE SHOOTING

4. Sensing and dispense

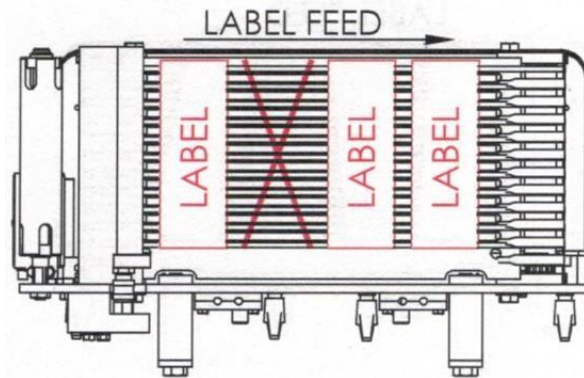

| Problem | Indications | Remedy |
|------------------------------|--|---|
| Labels missing. | Label sticking to blow tube. | <ol style="list-style-type: none"> 1. Adjust blow tube direction and / or flow control. 2. Check for missing labels on label roll. 3. Make sure knurled tension roller is locked down. 4. Make sure label reel is tightened against label roll to assure proper dancer operation. |
| Label backing paper tearing. | Check peel bar edge for nicks or cuts. | <ol style="list-style-type: none"> 1. Replace peel bar if necessary. 2. Replace label roll if cut marks are easily visible. 3. Make sure, knurled tension roller is locked down. 4. Make sure label brake arms are in position. |

CWL – LABELLING MACHINE OPERATING MANUAL

TROUBLE SHOOTING

5. Transport across the web

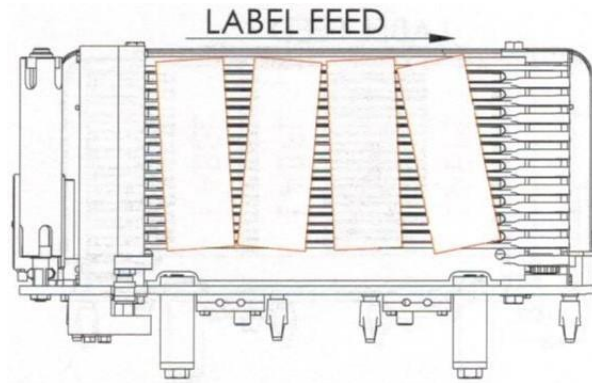

| Problem | Indications | Remedy |
|--|--|---|
| All labels misaligned after transport, before tamping. | Vacuum fans blocked or failed. | Check for clear operation of all fans. |
| | Blow-on tube directed out toward transporter and / or air pressure adjusted to high. | 1. Rotate blow on tube where hole faces directly down toward transports or slightly back toward peel bar. 2. Adjust flow on blow – on valve on the pneumatic valve. |
| | Peel over setting. | 3. Make sure at least 1 mm of label edge is visible on peel bar, and not more than 5 mm. |
| | Label material stuck to tamp blades or transport belts. | 4. Clean and remove any material. |
| | Label brake adjusted loosely. | 5. Increase tension on labeller |
| | Label material die cut in to backing paper. | 6. Check liner for cut marks. If present, talk to the label supplier about correcting. |
| | Blue transport belts loose. | 7. Tighten belts using adjustment bolts. (Do not overtighten belts) 8. If labels are round or non-rectangular, be sure labels and photo sensor are positioned consistently and reading the same position on the label. |

CWL – LABELLING MACHINE OPERATING MANUAL

TROUBLE SHOOTING

6. Transport across web

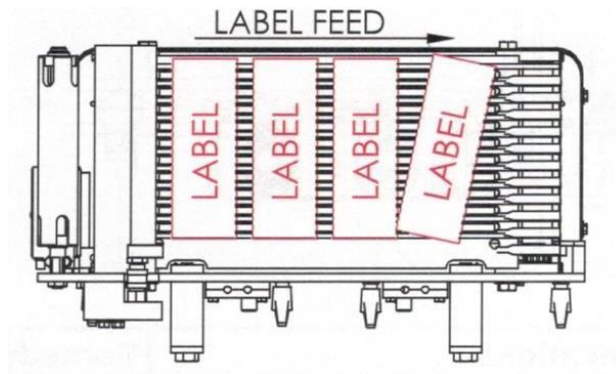

| Problem | Indications | Remedy |
|---|--|--|
| First label out misaligned after transport, before tamping. | Tamp retract time too short, resulting in first label dispensed contacting the retracting tamp blades. | <ol style="list-style-type: none"> 1. Increase tamp wait time 2. Speed up tamp cylinder retract by opening the flow control screw. |

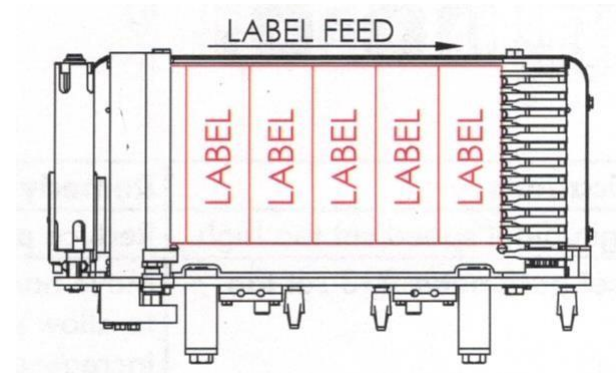

| Problem | Indications | Remedy |
|---|---|----------------------------|
| Labels aligned but coming up short in position. | Transporter stalling or belts slipping. | Tighten transporter belts. |

TROUBLE SHOOTING

7. Transport across Web

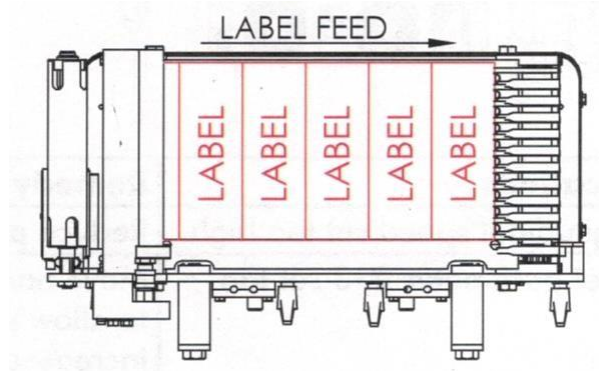

| Problem | Indications | Remedy |
|--|--|---------------------------|
| Labels aligned but coming up short in position | Transporter stalling or belts slipping | Tighten transporter belts |

TROUBLE SHOOTING

8. Label Tamp not reaching surface

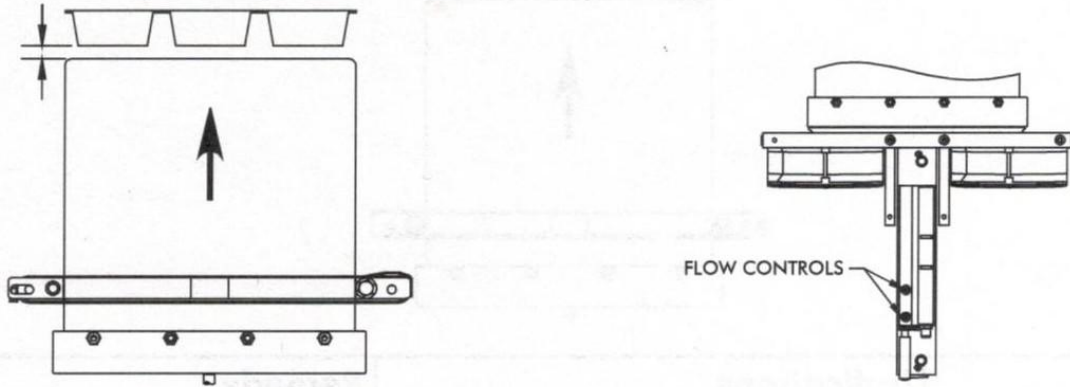

| Problem | Indications | Remedy |
|----------------------------------|---|--|
| Label Tamp not reaching surface. | Not enough air pressure. | Check regulator to confirm pressure is at 90 p. s. i. (6 bar). |
| | Tamp time is not set high enough. | Increase tamp time. |
| | Tamp cylinder flow control is not adjusted. | Open flow control adjustment as shown. |
| | Cylinder worn or shaft bent. | |
| | Linear guides not moving freely. | Grease or oil linear guide's shaft. |

Note:

For higher speed applications, the flow control adjustment should be left completely open and tamp setting should be adjusted primarily tamp time.

TROUBLE SHOOTING

9. Label tamp stroke varying

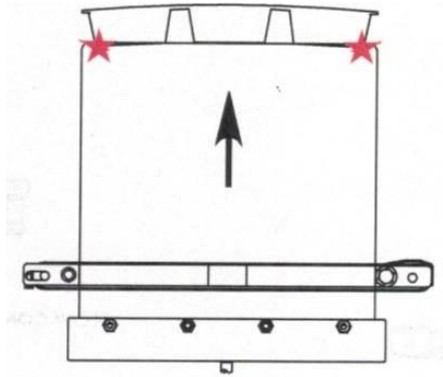

| Problem | Indications | Remedy |
|--|---|---|
| Label tamp not reaching surface. | Too much air pressure. | Check regulator to confirm pressure is at 90 p. s. i. (6 bar). |
| | Tamp time is set too high for flow control adjustment. | Degrease tamp time by 5mS increments or close off flow control adjustments one half turn until desired tamp is reached. |
| Label tamp varying throughout the day. | Supply air pressure varying and / or not high enough pressure source. | Change or improve the air source to provide a minimum of 90 p.s.i. (6 bar) To the labeller regulator. |
| | Water in the tamp valve or regulator. | Open drain on regulator and clear the water present. |
| | Tamp valve or cylinder worn. | Replace components. |

TROUBLE SHOOTING

10. Label tamp banging on return stroke

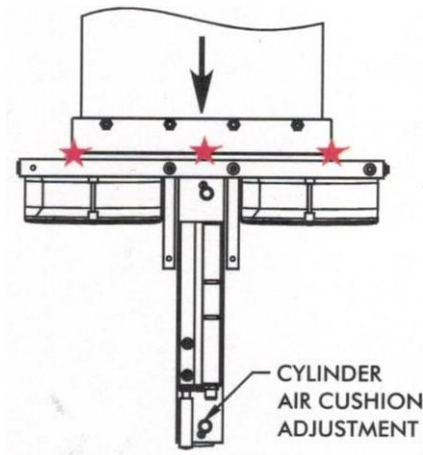

| Problem | Indications | Remedy |
|--------------------------------------|--|---|
| Label tamp banging on return stroke. | Cylinder air cushion is out of adjustment. | Tighten air cushion until desired return stroke is achieved. Do not tighten cushion too much, Or tamp blades will retract too slowly and impede the label dispense. |

14.LABELLER SPEED

Labeller speed and acceleration is a function of motors speeds, die configuration, and tamp times. The labeller speed is entered in m/min and the acceleration rate is entered in m/sec². Two motor options available: standard-torque and high torque.

The motor speeds listed below are average speeds for these motors. Some factors, such as temperature and label size, may reduce the actual speed that the labeller can achieve. In general, the labeller speeds should be set as low as possible while still maintaining packaging machine speed.

| Standard – Torque | | |
|-------------------------|--|-------------------|
| Motor | | Max. |
| Label speed | | 40 m/min |
| Transporter speed | | 40 m/min |
| Label Acceleration Rate | | 1m/s ² |

CWL – LABELLING MACHINE OPERATING MANUAL

TROUBLE SHOOTING

11.Blow – On

| Location | Problem | Indications | Remedy |
|-----------|---|---|---|
| Blow - On | Blow – on does not activate with valve and relay LED (on PWB) indicators “ON.” | <ul style="list-style-type: none"> • Loss of air pressure. • Pressure regulator not set or faulty. • Flow control out of adjustment. • Valve coil damaged | <p>Restore line pressure.</p> <p>Set or repair pressure regulator to 90 p.s.i. (6 Bar).</p> <p>Open flow controls to obtain proper operation.</p> <p>Replace Valve.</p> |
| Blow - On | Blow – On does not activate with valve LED indicator OFF and relay LED (On PWB) indicators:” ON.” | <ul style="list-style-type: none"> • Relay damaged or not seated properly. • Connection between relay output and valve faulty. • 5 Amp fuse on PWB board blown. | <p>Replace or re-install relay.</p> <p>Check connections.</p> <p>Replace fuse and check isolation.</p> |
| Blow - On | Blow – On does not activate relay LED indicators (On PWB) “OFF.” | <ul style="list-style-type: none"> • Drive I/O not reaching relay input. | <p>Check connections.</p> |

TROUBLE SHOOT

12.Display

| Location | Problem | Indications | Remedy |
|----------|---|--|--|
| Display | Labeller does not display anything on screen. | <ul style="list-style-type: none">• 240 VAC disconnected• Main control power Circuit Breaker off.• 24 VDC power supply failed.• 24 VDC power supply connection loose.• 24 VDC time delay failed.• Touchscreen failed. | <p>Check 240 VAC input</p> <p>Reset Circuit Breaker.</p> <p>Replace power supply.</p> <p>Check connections on power supply pins and PWB.</p> <p>Replace time delay relay.</p> <p>Replace touch screen.</p> |

CWL – LABELLING MACHINE OPERATING MANUAL

TROUBLE SHOOT

13.Label Sensor

| Location | Problem | Indications | Remedy |
|-----------------|--------------------------------------|--|--|
| Label stopping. | Label gaps missed or runaway labels. | Label sensor out of adjustment. <ul style="list-style-type: none"> • Label speed set to high. | Set label sensor Degrease label speed parameter or increase acceleration parameter. |

14.Motor Torque

| Location | Problem | Indication | Remedy |
|-----------------|---|---|--|
| Motor torque | There is little or no holding torque; the power LED is "ON" and the motor fault RED LED is "OFF." | <ul style="list-style-type: none"> • Current select AMPS DIP is set improperly. • Motor internally shorted. • Low AC line voltage. • Drive failure. | Confirm proper drive switch settings. (See electrical diagram) Check motor impedance and replace if necessary. Verify incoming line Voltage is minimum 208VAC and maximum 240VAC. Replace drive. |
| Motor operation | Motor does not move with Drive Power LED (green) "ON" | Motor circuit or motor has short or open circuit. | Disconnect power from the labeller and motor wiring from the drive. Check continuity across A phase and B phase (maximum of 1.0 ohms for large motor and 5.0 ohms for small motor. Check for isolation between phases and to ground. |
| Motor operation | Motor jerking | Bad motor windings | Verify A and B loop. Replace motor if necessary. |

TROUBLESHOOTING

15.Power

| Location | Problem | Indications | Remedy |
|----------|---|---|--|
| Power. | Stepper drives power GREEN LED is "OFF", and the power supply GREEN LED is "OFF." | <ul style="list-style-type: none"> • No 240 VAC power. • Power supply has had a thermal shut down. • Power supply damaged. | <p>Verify AC power, 210VAC minimum. 240VAC maximum).</p> <p>Measure temperature at heat sink (60°C maximum)</p> <p>Replace power supply.</p> |
| Power. | Stepper drives power GREEN LED is "OFF", and the power supply GREEN LED is "ON." | <ul style="list-style-type: none"> • Short or open circuit in drive cabling or motor. | <p>Check drive cabling and then cycle AC power.</p> |
| Power. | Touch screen comes on, but 24VDC output does not. | <ul style="list-style-type: none"> • 24VDC time delay relay failed. | <p>Replace time delay relay.</p> |

CWL – LABELLING MACHINE OPERATING MANUAL

TROUBLE SHOOTING

16.Tamp

| Locations | Problem | Indications | Remedy |
|-----------|---|---|--|
| Tamp. | Tamp cylinder does not activate with valve and relay LED (on PWB) indicators "ON" | <ul style="list-style-type: none"> • Loss of air pressure. • Pressure regulator not set or faulty. • Flow controls out of adjustment. • Valve coil damaged. • Valve(s) damaged. • Tamp time set to low. | <p>Restore line pressure.</p> <p>Set or repair pressure regulator to 90 p.s.i. (6 Bar)</p> <p>Open flow controls to obtain proper operation.</p> <p>Replace coil.</p> <p>Replace valve(s)</p> <p>Increase tamp time.</p> |
| Tamp. | Tamp cylinder does not activate with valve LED indicator OFF and relay LED (on PWB) indicators "ON" | <ul style="list-style-type: none"> • Relay damaged or not seated properly. • Connection between relay output and valve faulty. | <p>Replace or reinstall relay.</p> <p>Check connections.</p> |
| Tamp. | Tamp cylinder does not activate. Relay LED indicators (On PCB) "OFF" | <ul style="list-style-type: none"> • Drive I/O not reaching relay input. • Drive I/O damaged. | <p>Check connections reset / replace PWB ribbon cables.</p> <p>Replace drive.</p> |

14.MAINTENANCE

Maintenance Log

A maintenance log is a journal of all maintenance performed. Each entry includes a date, maintenance performed (details about the type of work done), and technician (who performed the maintenance). The maintenance log is also a place where a schedule is kept for further maintenance.

A maintenance log will clearly show daily inspections, tamp blade replacement, and so on.

Please create a copy of the “Maintenance Log” page and store in the back of this owner’s manual.

15.SERVICE

Service Log

A service log is a journal of all service work performed. Each entry includes a date, service provided (details about the type of service), and technician (who performed the service).

A service log will clearly show training provided, frequent wear items, and so on.

Please create a copy of the “Maintenance Log” page and store in the back of this owner’s manual.

CWL – LABELLING MACHINE OPERATING MANUAL

14.PM PREVENTIVE MAINTENANCE

1. PM Weekly Check:

| | | | |
|---|-----------|-----------------------|-----------------|
| PM – PREVENTIVE MAINTENANCE CWL – 100 CROSS WEB LABELLER | | | |
| WORK ORDER NO. | | SCHEDULE DATE: | |
| Customer Name: | | | |
| Address: | | | |
| City: | | State: | ZIP Code: |
| Status: PM – WEEKLY CHECK | | Contact: _____ | |
| | | Tel: _____ | |
| WEEKLY CHECK TIME LIMIT: MAX. 50 MINUTES | | | |
| Problem Reported: | | | |
| System Down: Yes / No (please cycle) | | Equipment Type: | |
| Make: | | Cause: | |
| Call Reported by: | | Date: | Time: |
| Location of Installation: | | | |
| SERVICE DETAILS | | | |
| | | | |
| Defects found on inspection: | | | |
| Events Time: | | Start of Service: | End of Service: |
| PLEASE RATE THIS CALL BY TICKING AN OPTION | | | |
| | | | |
| Extremely Satisfied | Satisfied | Dissatisfied | Annoyed |

CWL – LABELLING MACHINE OPERATING MANUAL

PREVENTIVE MAINTENANCE

2. PM Weekly Check:

AGENDA – WORK- PROCEDURE / CHECK THE FOLLOWING

| 1 | Labelling Head | X | Comment |
|---|--|---|---------|
| | Check condition and clean machine | | |
| | Check pneumatic system and drain water | | |
| | Check electrical connection and label sensor | | |
| | Check rewinding unit | | |
| | Check paper brake | | |
| | Check and clean all rollers | | |
| | Make measuring run | | |
| | Make manual test of labelling head | | |
| | | | |
| 2 | Vacuum Unit | | |
| | Check condition of all belts on vacuum unit | | |
| | If dirty, clean belts with alcohol-based solvent | | |
| | Check drive motor and timing belt | | |
| | Open vacuum box and check pusher plates | | |
| | If labels stuck in vacuum box, remove | | |
| | | | |
| 3 | Dispensing Edge | | |
| | Check condition of dispensing edge | | |
| | Check condition of blow pipe | | |
| | | | |
| 4 | Control Unit | | |
| | Check and clean control unit | | |
| | | | |
| 5 | Test Run | | |
| | Run the machine in manual at 4 cycles | | |
| | Confirm test run completed | | |
| | | | |

Spare Parts Request:

| | Part No. | Description | Quantity |
|---|----------|-------------|----------|
| 1 | | | |
| 2 | | | |
| 3 | | | |
| 4 | | | |
| 5 | | | |

CWL – LABELLING MACHINE OPERATING MANUAL

PREVENTIVE MAINTENANCE

3. PM Monthly Check:

| | | | |
|---|-------------------|-----------------------|-----------------|
| PM – PREVENTIVE MAINTENANCE CWL – 200 CROSS WEB LABELLER | | | |
| WORK ORDER NO. | | SCHEDULE DATE: | |
| Customer Name: | | | |
| Address: | | | |
| City: | State: | ZIP Code: | |
| Status: PM – MONTHLY CHECK | | Contact: _____ | |
| | | Tel: _____ | |
| MONTHLY CHECK TIME LIMIT: MAX 2 HRS. | | | |
| Problem Reported: | | | |
| System Down: Yes / No (please cycle) | | | Equipment Type: |
| Make: | | | |
| Call Reported by: | Date: | Time: | |
| Location of Installation: | | | |
| SERVICE DETAILS | | | |
| | | | |
| Defects found on inspection: | | | |
| | | | |
| Events Time: | Start of Service: | End of Service: | |
| | | | |
| PLEASE RATE THIS CALL BY TICKING AN OPTION | | | |
| | | | |
| Extremely Satisfied | Satisfied | Dissatisfied | Annoyed |

CWL – LABELLING MACHINE OPERATING MANUAL

PREVENTIVE MAINTENANCE

4. PM Monthly Check:

AGENDA – WORK- PROCEDURE / CHECK THE FOLLOWING

| | | | |
|----------|--|--|--|
| 1 | Labelling Head | | |
| | Check condition and clean machine | | |
| | Check pneumatic system and drain water | | |
| | Check electrical connection and label sensor | | |
| | Check rewinding unit | | |
| | Check paper brake | | |
| | Check and clean all rollers | | |
| | Open cover and check timing belt | | |
| | Check condition of clutch | | |
| | Make measuring run | | |
| | Make manual test of labelling head | | |
| | | | |
| 2 | Vacuum Unit | | |
| | Check condition of all belts on vacuum unit | | |
| | If dirty, clean belts with alcohol-based solvent | | |
| | Check drive motor and timing belt | | |
| | Open vacuum box and check pusher plates | | |
| | If labels stuck in vacuum box, remove | | |
| | Check condition of fan | | |
| | Check linear guide for pusher cylinder | | |
| | | | |
| 3 | Dispensing Edge | | |
| | Check condition of dispensing edge | | |
| | Check condition of blow pipe | | |
| | | | |
| 4 | Control Unit | | |
| | Check and clean control unit | | |
| | | | |
| 5 | Test Run | | |
| | Run the machine in manual at 4 cycles | | |
| | Confirm test run completed | | |
| | | | |

Spare Parts request:

| | Part No. | Description | Quantity |
|----------|----------|-------------|----------|
| 1 | | | |
| 2 | | | |
| 3 | | | |
| 4 | | | |
| 5 | | | |
| 6 | | | |

PROGRAM - PARAMETERS

Program Parameters

The program parameters are a journal of the program's individual setting for up to 20 individual product lines. Each program has unique parameters that can be documented in these charts.

| Program Name or No. Labeller 1 | |
|--------------------------------|--|
| 1 | |
| 2 | |
| 3 | |
| 4 | |
| 5 | |
| 6 | |
| 7 | |
| 8 | |
| 9 | |
| 10 | |
| 11 | |
| 12 | |
| 13 | |
| 14 | |
| 15 | |
| 16 | |
| 17 | |
| 18 | |
| 19 | |
| 20 | |

CWL – LABELLING MACHINE OPERATING MANUAL

PROGRAM – PARAMETERS

Program Parameters



The program parameters are a journal of the program's individual setting for up to 20 individual product lines. Each program has unique parameters that can be documented in these charts.

| Program Name or No. Labeller 1 | |
|--------------------------------|--|
| 1 | |
| 2 | |
| 3 | |
| 4 | |
| 5 | |
| 6 | |
| 7 | |
| 8 | |
| 9 | |
| 10 | |
| 11 | |
| 12 | |
| 13 | |
| 14 | |
| 15 | |
| 16 | |
| 17 | |
| 18 | |
| 19 | |
| 20 | |

CWL – LABELLING MACHINE OPERATING MANUAL

26. SPARE PARTS

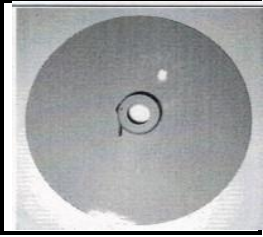
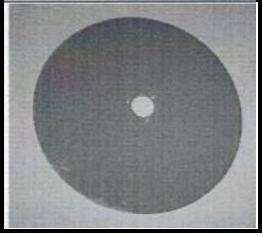
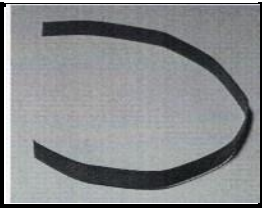
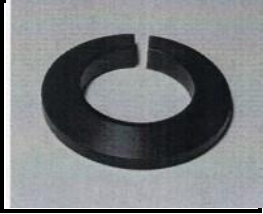
1. Spare Part List





| Image | Item No. | | |
|---|----------|--------------------------------|--|
|  | 853 | Paper brake complete | |
|  | 391 | Flanged disc complete Ø 380 mm | |
|  | 392 | Flanged disc Ø 360 mm | |
|  | 865 | Label brake band | |
|  | 197 | Guide ring Ø 32 mm | |
|  | 860 | Brake shaft | |
| | | | |

Baumann Engineering Pty.Ltd.

CWL – LABELLING MACHINE OPERATING MANUAL

SPARE PARTS

Spare Part List

| | | | |
|---|-----|--|--|
|  | 314 | Knurled deflection roller Ø 32 mm | |
|  | 315 | Deflection roller | |
|  | 90 | Press on roll complete | |
|  | 618 | Label driver roll | |
|  | 137 | FC-4100 Series Capacitive Label Sensor | |

CWL – LABELLING MACHINE OPERATING MANUAL

SPARE PARTS

Spare Part List

| | | | |
|---|-----|------------------------------------|--|
|  | 813 | Backing paper unwind clutch | |
|  | 870 | Ball bearing for roller | |
|  | 866 | Timing belt drive motor | |
|  | 269 | Timing belt unwind clutch | |
|  | 270 | Timing belt motor drive vacuum box | |

CWL – LABELLING MACHINE OPERATING MANUAL

SPARE PARTS

Spare Part List

| | | | |
|---|------------|--|--|
|  | 867 | Tension spring | |
|  | 129 | Stepper motor main drive labeller 6.6 NM / 5.8A | |
|  | 130 | Stepper motor vacuum belt drive 3NM / 4A | |
|  | 98 | Air nozzle / Blow pipe | |
|  | 66 | Dispensing edge 100 mm / 200 mm | |

CWL – LABELLING MACHINE OPERATING MANUAL

SPARE PARTS

Spare Part List

| | | | |
|---|-------------------|---|--|
|  | <p>879</p> | <p>Pneumatic cylinder / Pusher plates Vacuum box</p> <p style="text-align: center;">DSNU 25 – 100 PPV DSNU 25 – 150 PPV DSNU 25 – 200 PPV</p> | |
|  | <p>23</p> | <p>Drive roller shaft (set) for vacuum belt 200 mm</p> | |
|  | <p>231</p> | <p>Drive roller shaft (set) for vacuum belt 100 mm</p> | |
|  | <p>24</p> | <p>Flat belt 420 mm</p> | |
|  | <p>340</p> | <p>Vacuum Fan 24VDC 17W / 0.71A</p> | |

CWL – LABELLING MACHINE OPERATING MANUAL

SPARE PARTS





Spare Part List

| | | | |
|---|------------|--|--|
|  | 130 | Pneumatic Valve Metalwork 70620 2010 | |
|  | 131 | Flow Control | |
|  | 132 | REED NO sensor, T7 SQUARE, 2 wires, 1,5 m / Metal Work | |
|  | 133 | Take - up Unit assembly 100 RH Take - up Unit assembly 200 RH | |
|  | 134 | Tamp Plate 420 mm | |

CWL – LABELLING MACHINE OPERATING MANUAL

SPARE PATRS

Spare Part List

| | | | |
|---|-------------------|---|--|
|  | <p>235</p> | <p>Label Unwind Roller Shaft</p> | |
|  | <p>236</p> | <p>Brake band</p> | |
|  | <p>238</p> | <p>Power Supply PS 1000 Output 24 V / DC 10 / A Input AC / 100 – 240 V. 1- phase</p> | |
|  | <p>239</p> | <p>Power Supply PS 2000 Output 48 V / DC 10 / A Input AC / 110 – 150 V. 1- phase</p> | |

CWL – LABELLING MACHINE OPERATING MANUAL

SPARE PARTS

Spare Part List



Buy Online

www.baumann-industries.com



Baumann Engineering Pty.Ltd.

CWL – LABELLING MACHINE OPERATING MANUAL

Remote control log & Beckhoff technical assistance:

www.LESolutions.com.au

Hamish Lucas

hamish@lesolutions.com.au

+61(0)412 647 741

SCHEMATICS

PLC Controller



EK 100 Ether Cat coupler

CWL – LABELLING MACHINE OPERATING MANUAL

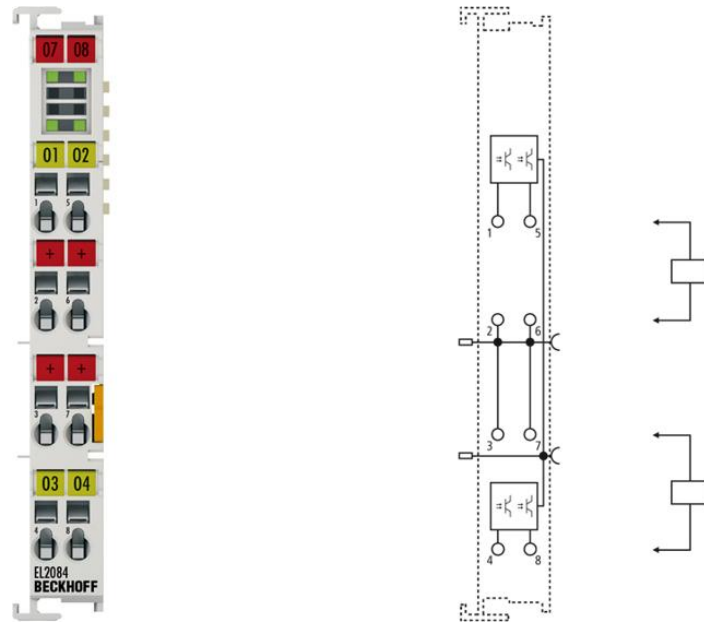

1084 Ether Cat terminal 4 channel digital output/24VDC/0,5V

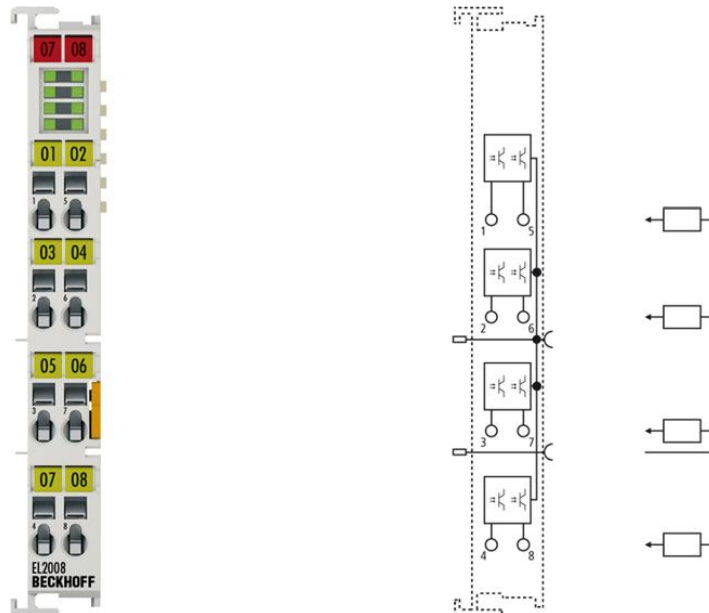

EL2084 Ethercat terminal,4 channel digital output,24VDC,0,5A ground switching

CWL – LABELLING MACHINE OPERATING MANUAL

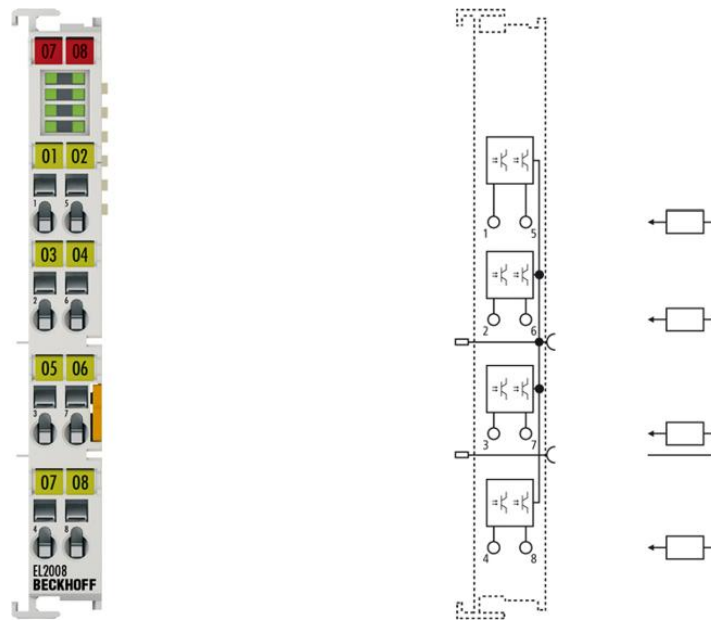

EL2084 Ethercat terminal,4 channel digital output,24VDC,0,5A ground switching

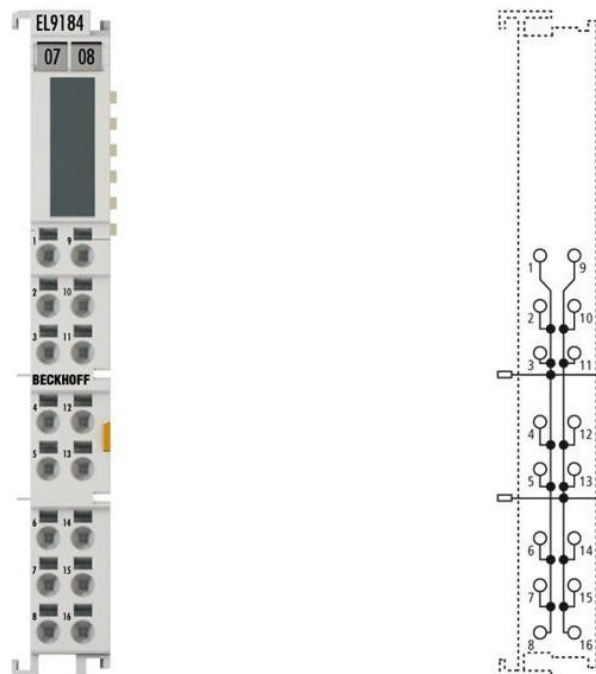

EL9184 Potential distribution terminal 8 x24V DC 8 X 0V DC

CWL – LABELLING MACHINE OPERATING MANUAL

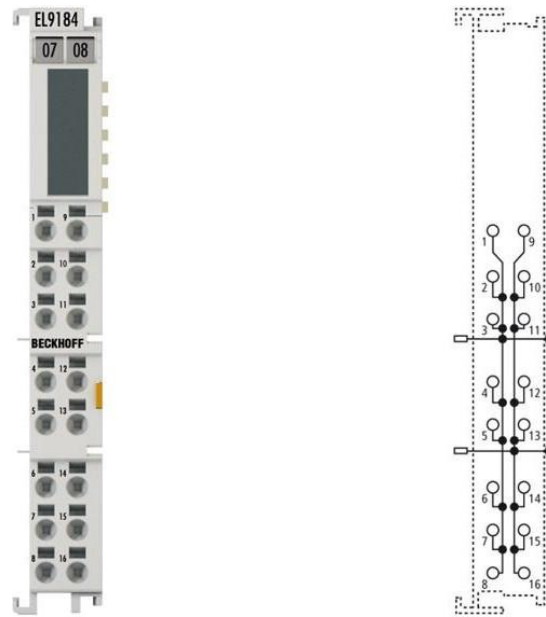

EL9184 Potential distribution terminal 8 x24V DC 8 X 0V DC



CP6900-0001-0000 | Economy built-in Control Panel with DVI/USB Extended interface.

Baumann Engineering Pty.Ltd.



The CP6900 “Economy” Control Panel expands the IPC entry-level class by a built-in Control Panel with DVI/USB extended interface. The panel is designed for installation in the front of a control cabinet and has a 10.1-inch touch screen display. Ideally combined with the compact Embedded PCs from the CX series or the C6xxx Industrial PCs, this results in an inexpensive PC/panel system. The CP6900 is supplied with a 24 V power supply. The integrated DVI/USB Extended technology enables remote panel operation at a distance of up to 50 m from the PC. The optional C9900-G07x push-button extensions supplement the Control Panel with an emergency stop key and three push-button keys with signal lamp.



The EL7062 EtherCAT Terminal is intended for the direct connection of two stepper motors in the mid power range up to 3 A and a voltage range from 8...48 V. The compact stepper motor output stage is accommodated in the EtherCAT Terminal together with two digital inputs for limit switches. Through parameterization, the EL7062 can be adjusted to the motor and the application requirements. Extremely high micro-stepping ensures particularly quiet and precise motor operation.

In combination with a corresponding stepper motor, the EL7062 represents a cost-effective and compact drive solution.

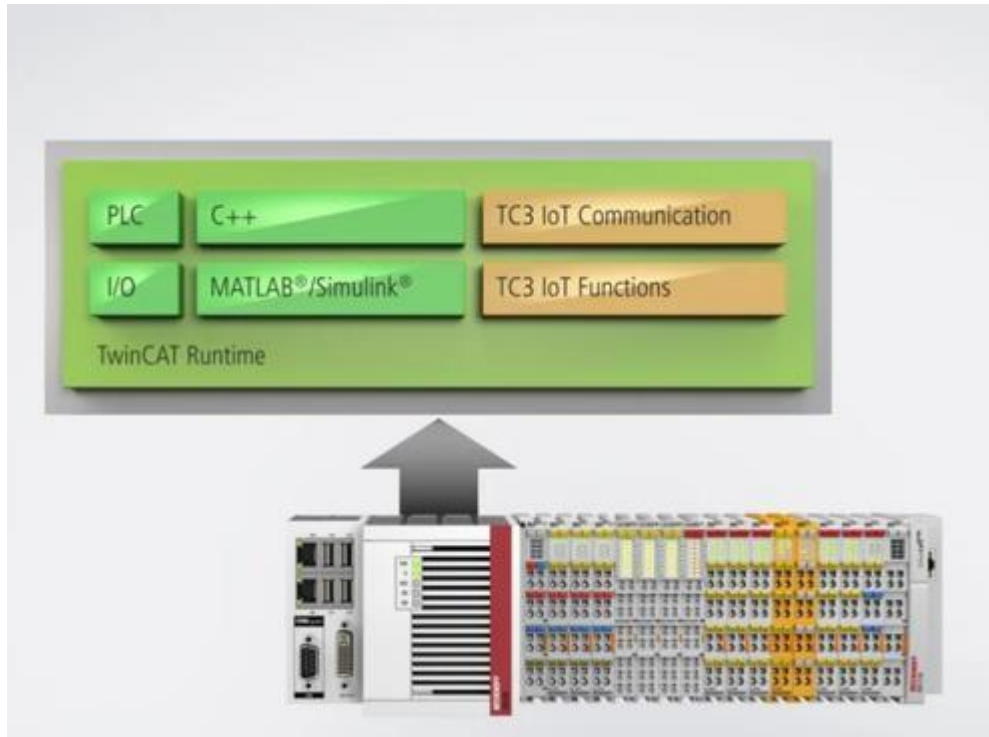

Remote Access Lan / TwinCAT IoT is quick and easy to configure and, together with an Industrial PC or Embedded PC as an IoT controller, establishes a seamless connection between the Internet of Things and the Internet of Services.

The TwinCAT EtherNet/IP Adapter is a supplement that turns any PC-based controller with an Intel® chipset and the real-time Ethernet driver developed by Beckhoff into an EtherNet/IP adapter. Through this supplement the Ethernet interface becomes an EtherNet/IP adapter. The product can be used on all PC controllers and Embedded PC controllers with an Intel® chipset.

A further feature of the supplements is that it enables up to eight adapters to be parameterized using a single physical interface. For this purpose, a virtual MAC address is created in order to be able to operate a total of up to eight EtherNet/IP adapters on one PC via a single Ethernet interface. This feature can be used, for example, to exchange larger amounts of data using one EtherNet/IP scanner or to establish a connection to several EtherNet/IP scanners in different subnets.

CWL – LABELLING MACHINE OPERATING MANUAL

Terminals:

X. Terminals

| ID | Dwg | Code | Description |
|--------------|--------|-------------|--|
| 1X | 42100 | | Main Panel |
| 1X1 | 42 161 | | AC power termination |
| 1X2 | 42 162 | | Stepper Motor Power Labeller 1 |
| Vac Box 1 | | | |
| 1X3 | 42 163 | | 24VDC Fuses and Supply |
| 1X4 | 42 164 | | 0VDC paired with 24VDC |
| 1X5 | 42 165 | 42 127A4 | Thermoformer Interfacing |
| Terminations | | | |
| 1X6 | 42 166 | 42 128 | Interface to HMIs and PBs |
| 1X7 | | | Interfacing between PLCs, shared signals |
| 1X28 | 42 127 | | Product in place Proximity Sensor |
| 1X29 | 42 127 | | Sensor Not ready for |
| Thermoformer | | | |
| 1X31 | 42 122 | | Power cable to Vac Box and Labeller 1 |
| 1X32 | 42 123 | | Power cable to Vac Box and Labeller 2 |
| 1X33 | 42 138 | | Power cable to Vac Box and Labeller 3 |
| 1X34 | 42 139 | | Power cable to Vac Box and Labeller 4 |
| 1X41 | 42 122 | 42 124, 125 | Data cable to Vac Box and Labeller 1 |
| 1X42 | 42 122 | 42 124, 125 | Data cable to Vac Box and Labeller 1 |
| 1X43 | 42 138 | 42 134, 135 | Data cable to Vac Box and Labeller 3 |
| 1X44 | 42 139 | 42 134, 136 | Data cable to Vac Box and Labeller 4 |
| 2X | 42 150 | | Junction Box for Vacuum Box (Generic) |
| 3X | 42 151 | | Junction Box for Labeller (Generic) |

Y. Electrically Operated Mechanical Devices

| ID | Dwg | Code | Description |
|-----|--------|-------------|--|
| Y1 | 42 124 | Also 42 134 | Labeller 1,3 Air Pulse |
| Y2 | 42 124 | Also 42 134 | Vacuum Box 1,3 Label Tamp Cylinder Valve |
| Y11 | 42 124 | Also 42 134 | Labeller 2,4 Air Pulse |
| Y12 | 42 124 | Also 42 134 | Vacuum Box 2,4 Label Tamp Cylinder Valve |