

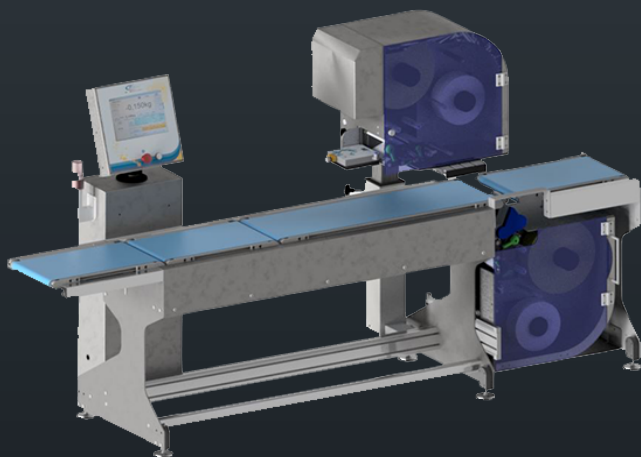

TECHNOLOGY for Your Business

SPECIALIZED IN THE DESIGN AND
PRODUCTION OF WEIGHING SYSTEMS
WEIGHING MACHINES
CHECKWEIGHERS
AUTOMATIC LABELING MACHINES
VISION CONTROL SYSTEMS
METAL DETECTOR
DIVERTERS/ALIGNERS
SOFTWARE



Phone +61 2 720 521 70
sales@baumann-industries.com
www.bbaumann-industries.com

RS-SERVER

MAIN FEATURES

- Creation and / or modification of labels and sharing of codest among the clients belonging to the same type of machine.
- Creation, modification and deletion of the database (PLU) and sharing among the clients belonging to the same type of machine.
(If by chance there are more MX Dynamic machines connected to the RS_Server software, all will have the same database (PLU) of processing updated as the database (PLU) of the server).
- Backup of all the weighs carried out on the machines connected to it, storing on a single database the information necessary to identify the machine and the measurement performed.

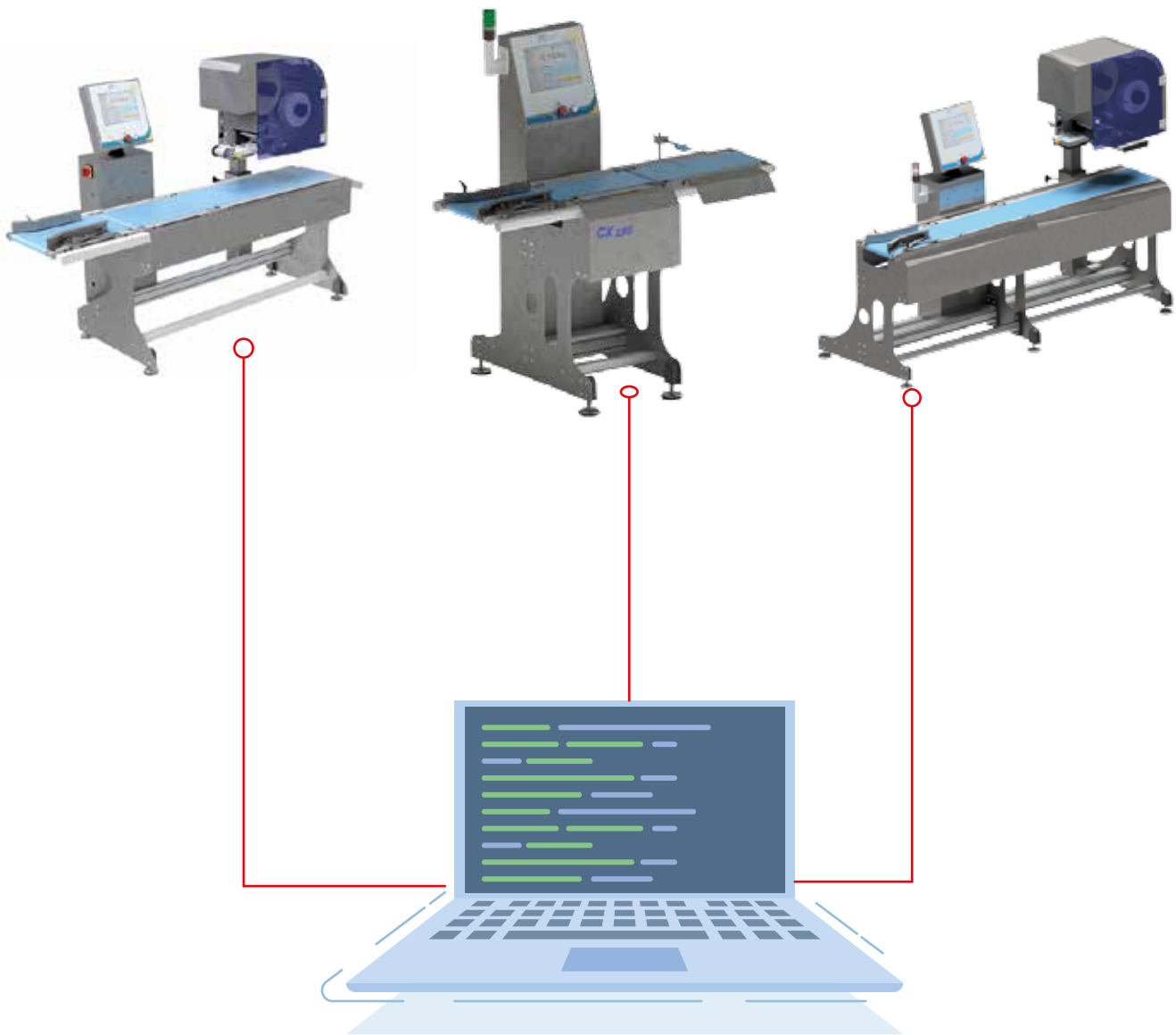

GWX Plus

WEIGH PRICE LABELER

TECHNOLOGY
QUALITY
PRECISION



GWX Plus



TECHNOLOGY for Your Business

MAIN FEATURES

- Capacity: 3/6 kg -1/2 g (optional 6000 div.).
- Working temperature: from 0 °C to + 40 °C.
- Power supply: 230 Vac (Hz 50/60).
- Resistive PC/Panel 10" display.
- Structure and carpentry in aluminum and stainless steel.
- Machine management by PLC.
- Print mode: thermal and/or direct transfer.
- Resolution: 8 dots/mm, **203 dpi** (optional: 12 dots/mm, 300 dpi).
- Print speed: 203 dpi, **457 mm/s** - 300 dpi, **300 mm/s**.
- Label sizes: from 40x40 to 110x110.
- Print width: 104 mm.
- Internal roll diameter: 76 mm.
- External roll diameter: **300 mm**.

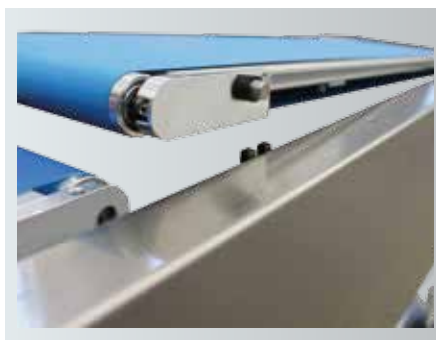

38 ppm

- Cadences up to: **38 ppm** model 38P (Stop and go operation).
- 2 motorized belts, with closed loop.
- Consumption: 0,85 kW.
- Label application with compressed air (**AIR BLAST**), 6 bar 60 l/min, firing camera multi-labels with mechanical adjustment and indicator of position.
- Mechanical movement **horizontal and vertical** printing unit.

45 ppm

- Cadences up to: **45 ppm** model 45P (Dynamic operation).
- 3 motorized belts, with closed loop.
- Consumption: 1,15 kW.
- Label application with compressed air (**AIR BLAST**), 6 bar 60 l/min, firing camera multi-labels with mechanical adjustment and indicator of position.
- Mechanical movement **horizontal and vertical** printing unit.

60 ppm

- Cadences up to: **60 ppm** model 60P (Dynamic operation).
- 3 motorized belts, with closed loop.
- Consumption: 1,15 kW.
- Label application with compressed air (**AIR BLAST**), 6 bar 60 l/min, firing camera multi-labels with mechanical adjustment and indicator of position.
- Label application with compressed air (**WITH ROTARY ARM**), 6 bar 40 l/min.
- Mechanical handling of **horizontal** printing unit, **vertical and rotational (180°)**.

GWX.AS2

Plus

WEIGH PRICE LABELER

TECHNOLOGY
QUALITY
PRECISION



GWX.AS2 Plus

MAIN FEATURES

- Capacity: 3/6 kg -1/2 g (optional 6000 div.).
- Resistive PC/Panel 10" display.
- Working temperature: from 0 °C to + 40 °C.
- Power supply: 230 Vac (Hz 50/60).
- Structure and carpentry in aluminum and stainless steel.
- Machine management by PLC.
- Print mode: thermal and/or direct transfer.
- Resolution: 8 dots/mm, **203 dpi** (optional: 12 dots/mm, 300 dpi).
- Print speed: 203 dpi, **457 mm/s** - 300 dpi, **300 mm/s**.
- Label sizes: from 40x40 to 110x130.
- Print width: 104 mm.
- Internal roll diameter: 76 mm.
- External roll diameter: **300 mm**.
- Label application from below with electronic motorized belt.
- Linear movement on bearings for printing unit position.

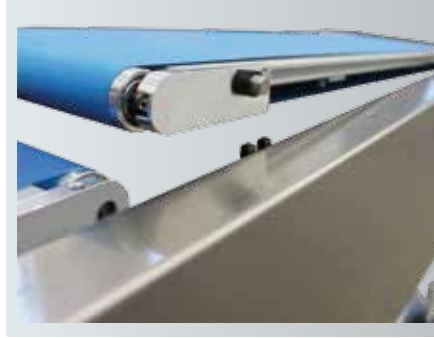

45 ppm

- Cadances up to **45 ppm** model 45P.
- 4 motorized belts, with closed loop.
- Brushless motors and drive cards, speed up to 70 m/min.
- Consumption: 1,4 kW.
- Label application with compressed air (**AIR BLAST**), 6 bar 60 l/min, firing camera multi-labels with mechanical adjustment and indicator of position.
- **Horizontal** and **vertical** printing unit mechanical movement.

60 ppm

- Cadances up to **60 ppm** model 60P.
- 4 motorized belts, with closed loop.
- Brushless motors and drive cards, speed up to 70 m/min.
- Consumption: 1,4 kW.
- Label application with compressed air (**AIR BLAST**), 6 bar 60 l/min, firing camera multi-labels with mechanical adjustment and indicator of position.
- Label application with compressed air (**WITH ROTARY ARM**), 6 bar 40 l/min.
- Mechanical handling of **horizontal** printing unit, **vertical** and **rotational (180°)**.

GWX Maxi Plus

WEIGH PRICE LABELER

TECHNOLOGY
QUALITY
PRECISION



GWX Maxi Plus

MAIN FEATURES

- Capacity: 15/30 kg - 5/10 g.
- Working temperature: from 0 °C to + 40 °C.
- Power supply: 230 Vac (Hz 50/60).
- Resistive PC/Panel 10" display.
- Structure and carpentry in aluminum and stainless steel.
- Machine management by PLC.
- Print mode: thermal and/or direct transfer.
- Resolution: 8 dots/mm, **203 dpi** (optional: 12 dots/mm, 300 dpi).
- Print speed: 203 dpi, **457 mm/s** - 300 dpi, **300 mm/s**.
- Label sizes: from 40x40 to 110x110.
- Print width: 104 mm.
- Internal roll diameter: 76 mm.
- External roll diameter: **300 mm**.
- Mechanical handling of **horizontal** printing unit, **vertical** and **rotational (180°)**.



30 ppm

- Cadences up to: **30 ppm** model 30P (Stop and go operation).
- 2 motorized belts, with closed loop.
- Brushless motors and drive cards, speed up to 50 m/min.
- Consumption: 2.05 kW.
- Label application with compressed air (**WITH ROTARY ARM**), 6 bar 40 l/min

60 ppm

- Cadences up to: **60 ppm** model 60P (Dynamic operation).
- 3 motorized belts, with closed loop.
- Brushless motors and drive cards, speed up to 50 m/min.
- Consumption: 2.9 kW.
- Label application with compressed air (**WITH ROTARY ARM**), 6 bar 40 l/min.

GWX

270V Plus

380V Plus

WEIGH PRICE LABELER

TECHNOLOGY
QUALITY
PRECISION



GWX

270V Plus

380V Plus

MAIN FEATURES

- Resistive PC/Panel 10" display.
- Working temperature: from 0 °C to + 40 °C.
- Power supply: 230 Vac (Hz 50/60).
- Structure and carpentry in aluminum and stainless steel.
- Machine management by PLC.
- Print mode: thermal and/or direct transfer.
- Resolution: 8 dots/mm, **203 dpi** (optional: 12 dots/mm, 300 dpi).
- Print speed: 203 dpi, **457 mm/s** - 300 dpi, **300 mm/s**.
- Label sizes: from 40x40 to 110x110.
- Print width: 104 mm.
- Internal roll diameter: 76 mm.
- External roll diameter: **300 mm**.
- Label application with compressed air **(WITH ROTARY ARM)**, 6 bar 40 l/min.
- Label application with compressed air **(AIR BLAST)**, 6 bar 60 l/min, firing camera multi-labels with mechanical adjustment and indicator of position.
- Mechanical handling of **horizontal** printing unit, **vertical** and **rotational (180°)**.

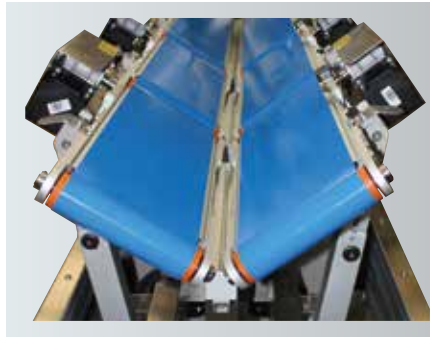

270V Plus

- Cadences up to: **70 ppm (WITH ROTARY ARM)**.
- Cadences up to: **100 ppm (AIR BLAST)**.
- Capacity: 15 kg - 5 g.
- 6 motorized belts, with closed loop.
- Brushless motors and drive cards, speed up to 50 m/min.
- Consumption: 1,15 kW.

380V Plus

- Cadences up to: **70 ppm (WITH ROTARY ARM)**.
- Cadences up to: **100 ppm (AIR BLAST)**.
- Capacity: 30 kg - 10 g.
- 6 motorized belts, with closed loop.
- Brushless motors and drive cards, speed up to 50 m/min.
- Consumption: 3,05 kW.

MX Dynamic

WEIGHING MODULE WITH
WEIGHT PRICING SOFTWARE
AND CHECKWEIGHER

TECHNOLOGY
QUALITY
PRECISION



MX Dynamic

MAIN FEATURES

- Cadences up to **110 ppm**.
- Capacity: 3/6 kg - 1/2 g (optional 6000 div.).
- From 2 to 4 motorized belts, with closed loop.
- Belt widths matched only with printer from above: 95 - 140 - 185 - 230 - 275 - 320.
- Belt widths matched with printer from above and/or from below: 230 - 275 - 320.
- Brushless motors and drive cards, speed up to 70 m/min.
- Working temperature: from 0 °C to + 40 °C.
- Power supply: 230 Vac (Hz 50/60).
- Consumption: up to 2 belts 0,85 kW - up to 4 belts 1,15 kW.
- Resistive PC/Panel 10"/12" display.
- Structure and carpentry in aluminum and stainless steel.
- Machine management by PLC.
- Print mode: thermal and/or direct transfer.
- Resolution: 8 dots/mm, **203 dpi** (optional: 12 dots/mm, 300 dpi).
- Print speed: 203 dpi, **457 mm/s** - 300 dpi, **300 mm/s**.
- Label sizes: from 40x40 to 110x110.
- Print width: 104 mm.
- Internal roll diameter: 76 mm.
- External roll diameter: **300 mm**.
- Label application with compressed air (**AIR BLAST**), 6 bar 60 l/min, firing camera multi-labels with mechanical adjustment and indicator of position.
- Label application with compressed air (**WITH ROTARY ARM**), 6 bar 40 l/min.
- Mechanical handling of **horizontal** printing unit, **vertical** and **rotational (180°)**.



SPM Plus

STATION WEIGHT
PRICING MANUAL

TECHNOLOGY
QUALITY
PRECISION



SPM Plus

MAIN FEATURES



- Working temperature: from 0 °C to + 40 °C.
- Power supply: 230 Vac (Hz 50/60).
- Consumption: 15,6 W.
- Resistive PC/Panel 10"/12" display.
- Structure and carpentry in stainless steel.



Main features labeller:

- Labeller model TDP-247 Plus direct, external power supply, 203 dpi resolution, print speed up to 127 mm/s, maximum print width 104 mm.
- Labeller model TTP-246M Pro thermal transfer and/or direct, 203 dpi resolution, print speed up to 203 mm/s, maximum print width 104 mm.
- Labeller model TTP-247 Plus thermal transfer or direct thermal with cable USB 1,5 m for PC connection, external power supply, 203 dpi resolution. Peel off.
- Labeller model TTP-2610MT thermal transfer and/or direct transfer with 1,5 m USB cable for connection to PC, internal power supply, 203 dpi resolution, 168 mm print width. Peel off kit for TTP-2610MT (incl. Internal rewinder and peel off).

Main features platform

- Weighing platforms in stainless steel, operating with single point load cell according to OIML R60 with protection against dust and moisture, dimensions: 250x350 - 400x400 - 500x500 - 600x600, capacities from 3 kg to 300 kg.

CX Dynamic

CHECKWEIGHER

TECHNOLOGY
QUALITY
PRECISION



CX Dynamic

MAIN FEATURES

- Cadences up to **165 ppm**.
- Capacity: 1,5/3/6 kg - 0,5/1/2 g (optional 6000 div.).
- From 1 to 3 motorized belts, with closed loop.
- Brushless motors and drive cards, speed up to 90 m/min.
- Working temperature: from 0 °C to + 40 °C.
- Power supply: 230 Vac (Hz 50/60).
- Consumption: 1/2 belts 0,3 kW - 3 belts 0,6 kW.
- Resistive PC/Panel 10" display.
- Structure and carpentry in aluminum and stainless steel.
- Machine management by PLC.
- Piston ejector, pneumatic arm or air blow (optional).
- LED light column out of tolerance.
- Adjustable stainless steel product guides (optional).

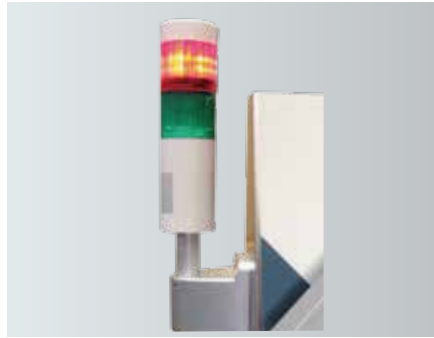

CX 95 Dynamic

- Cadence 95x400
- Weighing 95x400
- Ejector 95x570

CX 140 Dynamic

- Cadence 140x400 - 140x510
- Weighing 140x400 - 140x510
- Ejector 140x570/750

CX 185 Dynamic

- Cadence 185x400 - 185x510
- Weighing 185x400 - 185x510
- Ejector 185x570/750

CX 230 Dynamic

- Cadence 230x510
- Weighing 230x510
- Ejector 230x570/750

CX 275 Dynamic

- Cadence 275x510
- Weighing 275x510
- Ejector 275x570/750

CX 320 Dynamic

- Cadence 320x510
- Weighing 320x510
- Ejector 320x570/750

WBOX

CHECKWEIGHER

TECHNOLOGY
QUALITY
PRECISION



WBOX

MAIN FEATURES



- Cadences up to **50 ppm**.
- Capacity: 30/60 kg - 10/20 g.
- 1 motorized belt, with closed loop.
- Brushless motor and drive card, speed up to 50 m/min.
- Working temperature: from 0 °C to + 40 °C.
- Power supply: 230 Vac (Hz 50/60).
- Consumption: 1 kW.
- Resistive PC/Panel 10" display.
- Structure and carpentry in aluminum and stainless steel.
- Machine management by PLC.
- Pneumatic piston ejector (optional).
- LED light column out of tolerance.
- Adjustable stainless steel product guides (optional).

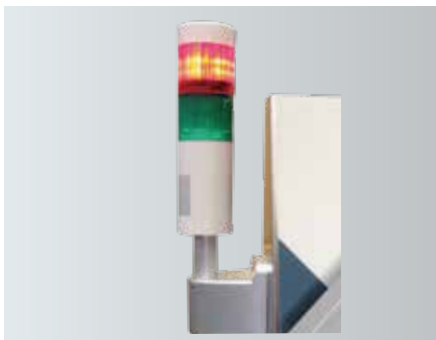

WBOX 420

- Useful belt size (mm)
Weighing 420x600/1000.

WBOX 510

- Useful belt size (mm)
Weighing 510x850/1000.

WBOX 700

- Useful belt size (mm)
Weighing 700x1400.

MINI CHECK Plus

CHECKWEIGHER

TECHNOLOGY
QUALITY
PRECISION



MINI CHECK Plus

MAIN FEATURES

- Cadences up to **35 ppm.**
- Capacity: 3/6/15 kg - 1/2/5 g (optional multi-range).
- 1 motorized belt, with closed loop from 230 to 320x570.
- Brushless motor and drive card, speed up to 50 m/min.
- Working temperature: from 0 °C to + 40 °C.
- Power supply: 230 Vac (Hz 50/60).
- Consumption: 1 kW.
- Resistive PC/Panel 7" display.
- Structure and carpentry in aluminum and stainless steel.
- Machine management by PLC.
- Output for management of expulsions.
- LED light column out of tolerance.

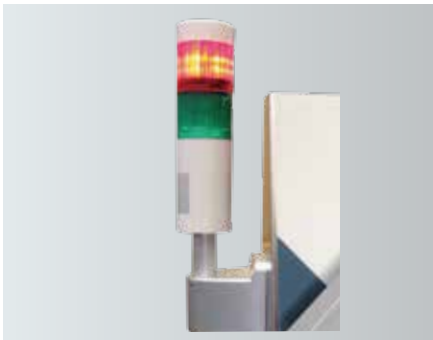

CS690

STATION FOR STATISTICAL CHECK
OF PREPACKAGED GOODS

TECHNOLOGY
QUALITY
PRECISION



CS690

**CONFIGURABLE ACCORDING
YOUR NEEDS:**

Main features display

Touch Screen Display backlit color with software of industrial statistical control. Keyboard touch screen QWERTY, AZERTY or QWERTZ, selectable.

Main features structure

Stainless steel structure. Adjustable bracket for wall or table display fixing entirely in stainless steel.

Main features platform

Weighing platforms in stainless steel, operating with single point load cell according to OIML R60 with protection against dust and moisture, dimensions: 250x350 - 400x400 - 500x500 - 600x600, capacities from 3 kg to 300 kg.

Main features labeller

Integrated printer model TPR thermal transfer, 203 dpi resolution, print speed up to 50 mm/s, maximum print width of 58 mm.



SAP.A Plus

AUTOMATIC PRINT
AND APPLY LABELING
TO AIR BLAST

TECHNOLOGY
QUALITY
PRECISION



SAP.A Plus

MAIN FEATURES



- Cadences up to **120 ppm**.
- Working temperature: from 0 °C to + 40 °C.
- Power supply: 230 Vac (Hz 50/60).
- Consumption: 0,55 kW.
- Resistive PC/Panel 10" display (12" optional).
- Structure and carpentry in aluminum and stainless steel.
- Machine management by PLC.
- Print mode: thermal and/or direct transfer.
- Resolution: 8 dots/mm, **203 dpi** (optional: 12 dots/mm, 300 dpi).
- Print speed: 203 dpi, **457 mm/s** 300 dpi, **300 mm/s**.
- Label sizes: from 40x40 to 110x110.
- Print width: 104 mm.
- Internal roll diameter: 76 mm.
- External roll diameter: **300 mm**.
- Label application with compressed air (**AIR BLAST**), complete with pressure regulator with air filter and pressure gauge, pressure regulator shot with pressure gauge.
- Chamber firing multi-labels with mechanical adjustment and position indicator.

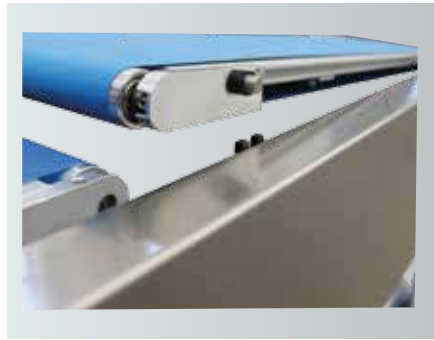

SAP.B Plus

AUTOMATIC PRINT AND APPLY
LABELLING TO PNEUMATIC ARM

TECHNOLOGY
QUALITY
PRECISION



SAP.B Plus

MAIN FEATURES



- Cadences up to **70 ppm**.
- Working temperature: from 0 °C to + 40 °C.
- Power supply: 230 Vac (Hz 50/60).
- Consumption: 0,55 kW.
- Resistive PC/Panel 10" display (12" optional).
- Structure and carpentry in aluminum and stainless steel.
- Machine management by PLC.
- Print mode: thermal and/or direct transfer.
- Resolution: 8 dots/mm, **203 dpi** (optional: 12 dots/mm, 300 dpi).
- Print speed: 203 dpi, **457 mm/s** - 300 dpi, **300 mm/s**.
- Label sizes: from 40x40 to 110x110.
- Print width: 104 mm.
- Internal roll diameter: 76 mm.
- External roll diameter: **300 mm**.
- Label application with compressed air **(WITH ROTARY ARM)**, 6 bar 40 l/min.

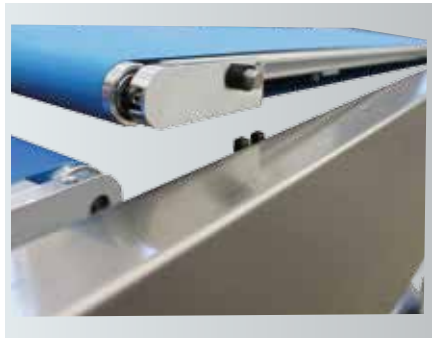

AS2 Plus

MODULAR
LABELING SYSTEM

TECHNOLOGY
QUALITY
PRECISION



AS2 Plus



TECHNOLOGY for Your Business

MAIN FEATURES

- Cadences up to **150 ppm**.
- 2 motorized belts, with closed loop.
- Brushless motors and drive cards, speed up to 70 m/min.
- Working temperature: from 0 °C to + 40 °C.
- Power supply: 230 Vac (Hz 50/60).
- Consumption: 1,1 kW.
- Resistive PC/Panel 10" display (12" optional).
- Structure and carpentry in aluminum and stainless steel.
- Machine management by PLC.
- Print mode: thermal and/or direct transfer.
- Resolution: 8 dots/mm, **203 dpi** (optional: 12 dots/mm, 300 dpi).
- Print speed: 203 dpi, **457 mm/s** - 300 dpi, **300 mm/s**.
- Label sizes: from 40x40 to 110x130.
- Print width: 104 mm.
- Internal roll diameter: 76 mm.
- External roll diameter: **300 mm**.
- Label application from below with electronic motorized belt.
- Linear movement on bearings for printing unit position.

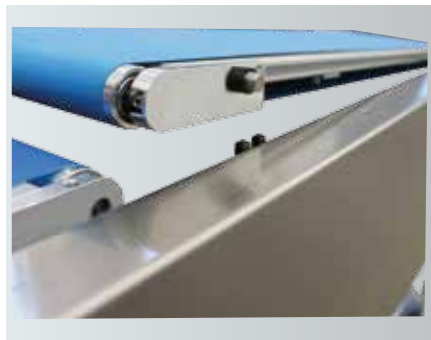

FX Special

LABELLER FOR SEAL WITH
APPLICATION FROM 180° TO 360°

TECHNOLOGY
QUALITY
PRECISION



FX Special

MAIN FEATURES



TECHNOLOGY for Your Business

- Cadences up to **70 ppm**.
- 2 motorized vertical belts with closed loop (centering), electronic touch positioning.
- Brushless motors and drive cards, speed up to 70 m/min.
- Working temperature: from 0 °C to + 40 °C.
- Power supply: 230 Vac (Hz 50/60).
- Consumption: 1,4 kW.
- Input belt for manual loading (optional).
- Synchronizer for alignment with other machines.
- Resistive PC/Panel display (optional).
- Structure and carpentry in aluminum and stainless steel.
- Machine management by PLC.
- Printer adjustment with electronic vertical axis selectable by touch.
- Mechanical horizontal adjustment (optional electronic).
- Print mode: thermal and/or direct transfer.
- Resolution: 8 dots/mm, **203 dpi** (optional: 12 dots/mm, 300 dpi).
- Print speed: 203 dpi, **457 mm/s** - 300 dpi, **300 mm/s**.
- Print width: 104 mm.
- Internal diameter of the roll: 76 mm.
- External diameter of the roll: **300 mm**.
- Label application with electronic motorized belt, dimensions up to 110x400 mm.

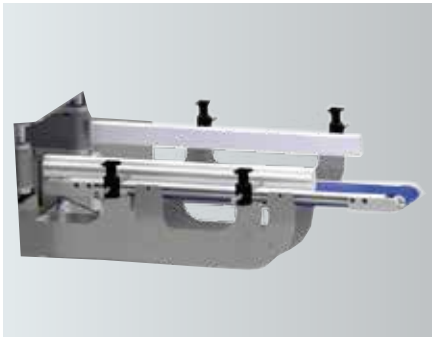

TMS/TMS.M

METAL DETECTOR
MONOFREQUENCY/MULTISPECTRUM

TECHNOLOGY
QUALITY
PRECISION



MAIN FEATURES BELT

- Structure and carpentry stainless steel.
- Brushless motor and drive card.
- Adjustable belt speed up to 50 m/min.
- Control Power available according to the Standards UL 508A and CSA-C22.2 No. 14-05.
- Light column with LED technology.

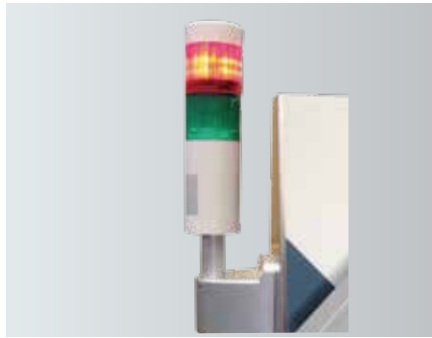

MAIN FEATURES PROBES

- Superior detection capability of magnetic and non-magnetic metal contaminants including stainless steels.
- Effective compensation of the product effect.
- Complies with FDA 21CFR regulation Part 11: Safety; Integrity; Traceability of data.
- Structure in AISI 316L stainless steel and plastic materials compatible with foods compliant with EU, FDA.
- Superior construction able to withstand high pressure washes.
- High Sensitivity to all magnetic and non-magnetic metals including stainless steels.
- Multifrequency technology for maximum sensitivity to varying the Product Effect.
- High immunity to environmental disturbances.
- Structure and components in AISI 316L stainless steel with IP65 degree of protection.
- Self-acquisition and automatic tracking effect product.
- 250 storable products, selectable from local programming or network software.
- 1.000 archived events.
- Alphanumeric display with 4x20 characters.
- Local programming: 4 keys, of which 3 with double function.

CSV

AUTOMATIC VISION SYSTEM

TECHNOLOGY
QUALITY
PRECISION



- Vision and control system consisting of 1 closed loop belt.
- Brushless motors and drive cards, speed up to 90 m/min.
- Simultaneous/individual acquisition with 2 cameras.
- Up to 4 industrial installable cameras, very high acquisition speed, according to your vision needs.
- LED lighting unit.
- Dedicated software for the management of the vision system.
- Panel PC with AISI 304 stainless steel case, equipped with TFT 10.4 inch color LCD display with LED Inverter, resolution 800x600 pixel, resistive 5-wire USB touch screen.
- Power supply: 230 Vac.



LC-2D TOP

DETECTION SYSTEM
TO BARCODE

TECHNOLOGY
QUALITY
PRECISION

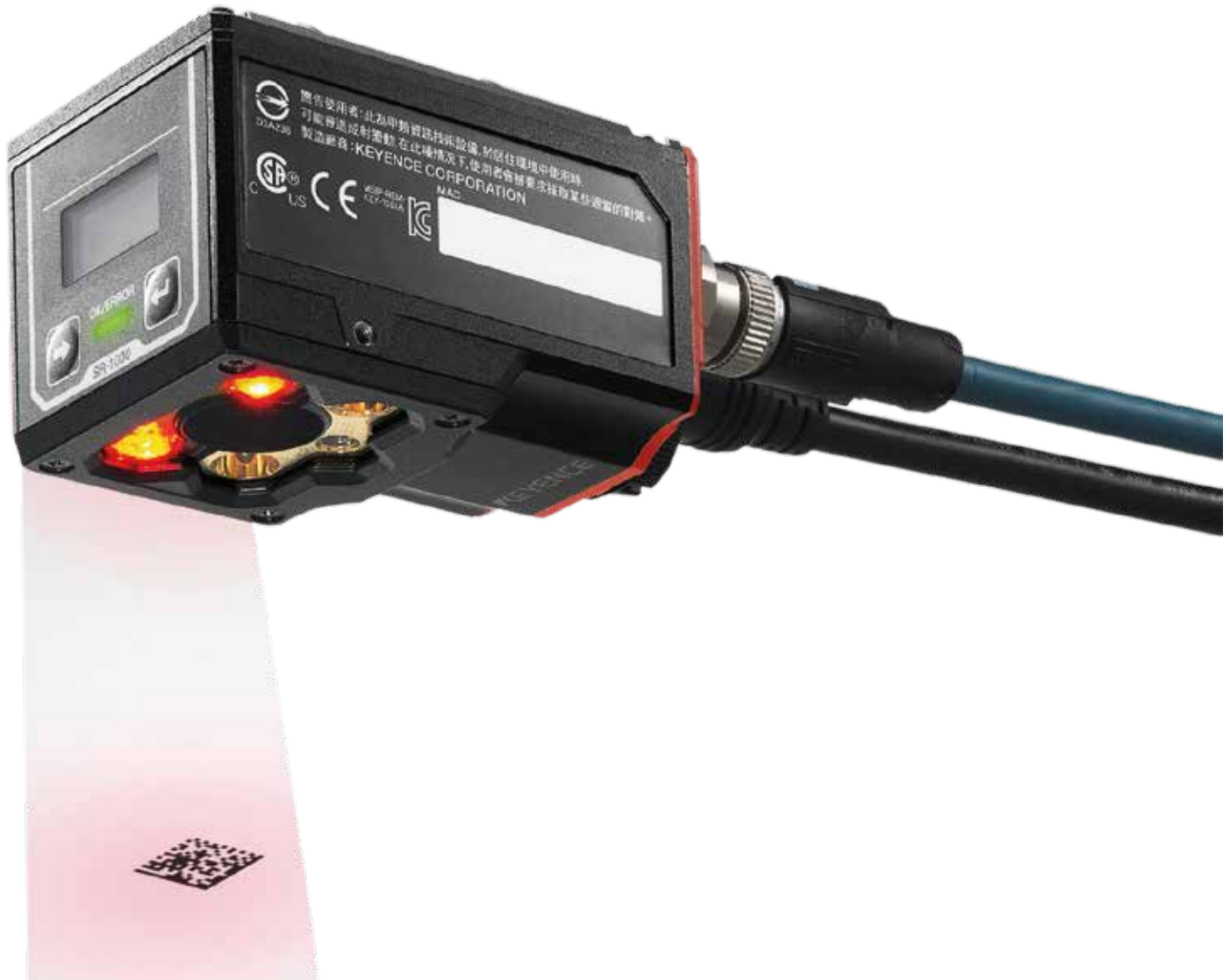

LC-2D TOP



TECHNOLOGY for Your Business

MAIN FEATURES

- Digital barcode reader IP65.
- Sensor: CMOS image.
- Number of pixel: 1280x1024.
- Light source: red LED high intensity.
Luminous pointer source: green LED high-intensity;
adjusting the focus: auto focus.
- Reading distance: from 110 to 1000 mm. Minimum
2D resolution: 0,063 mm.
- Minimum resolution barcode: 0.082 mm.
- Supported code: QR, micro QR, data matrix (ECC200),

- GS1 data matrix, PDF417, micro PDF417, GS1
composite (CC-A, CC-B, CC-C).
- Barcode: GS1 databar, CODE39, CODE39 Full ASCII,
ITF, NW-7 (codabar), CODE 128, 2of5 (industrial 2of5),
COOP 2of5 GS1-128, JAN/EAN/UPC, trioptic CODE 39,
CODE93, pharmacode.
- Ambient temperature: from 0 °C to 45 °C.
- Ambient storage temperature: from - 10 °C to + 50 °C.
- Humidity operating environment: from 35 to 95%
relative humidity, without condensation.



DEFINIZIONE DELLO STANDARD PER LA LETTURA DEI CODICI

Letture di codici 1D e 2D
con messa a fuoco automatica
Serie SR-1000



DV12/16

AL12/16

DIVIDER/CONVERGER

TECHNOLOGY
QUALITY
PRECISION



DVI2/16

ALI2/16

MAIN FEATURES

- Product sortation following signals from checkweigher, metal detectors, barcode readers, cameras.
- Balancing product count on downstream machines.
- Connecting packaging or process machines with different production capacities.
- Freezer or oven conveyors population.
- Layer preparation for palletizers or secondary packaging machines.
- Exchange group controlled by pneumatic cylinders or servomotors according to production capacities.
- Structure in painted carbon steel or stainless steel (optional).



LINES

TECHNOLOGY
QUALITY
PRECISION

CHECKWEIGHER
3-WAY DIVERTER



CHECKWEIGHER WITH PNEUMATIC
PISTON EJECTOR

WEIGH PRICE LABELER
WITH PRINT AND APPLY
FROM BELOW AND FROM ABOVE



PRICE WEIGHT APPROVED IN CLASS X/Y
WITH MOTORIZED EJECTOR BELT AND
DOUBLE PRINTING UNIT



CHECKWEIGHER WITH TIPPER
EJECTOR BELT

COMBINED METAL DETECTOR
CHECKWEIGHER



TR

ROTATING TABLES

TECHNOLOGY
QUALITY
PRECISION



TR

MAIN FEATURES

- Fixed speed.
- 2 horizontal supports.
- Stainless steel structure.
- Motor protection circuit breaker on the machine.
- Available sizes from 1000 to 2400 mm in diameter.



CS

CURVES

TECHNOLOGY
QUALITY
PRECISION

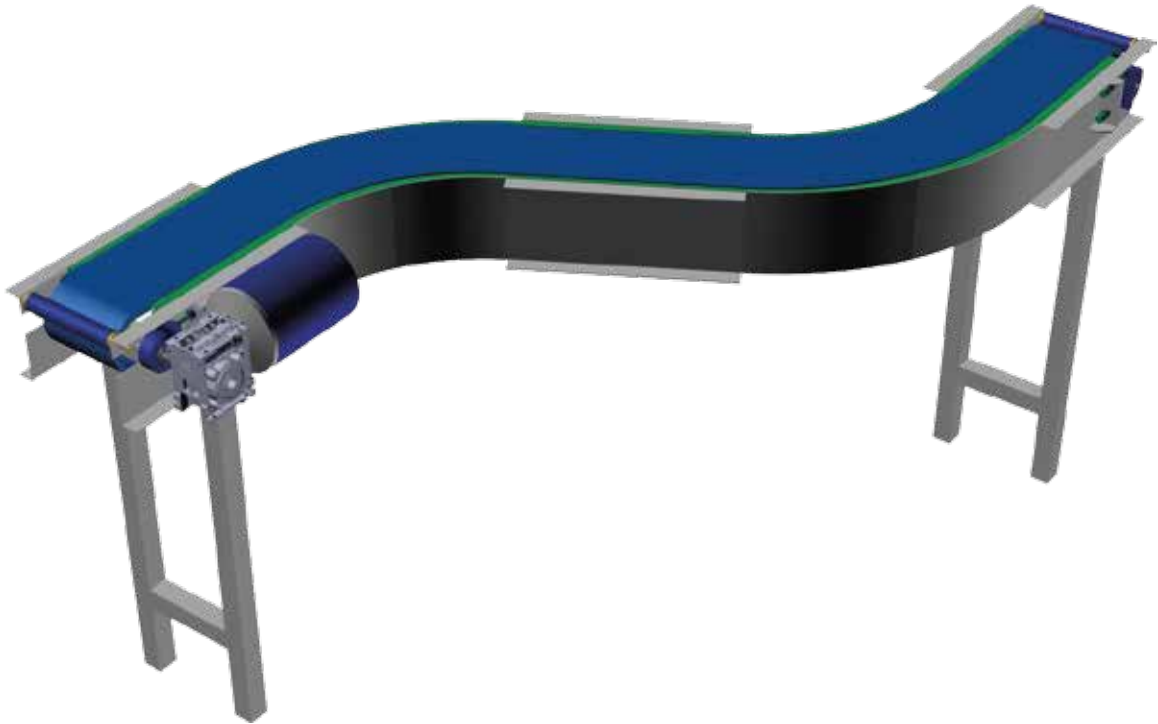

MAIN FEATURES

- Fixed or variable speed.
- Stainless steel structure.
- Conveyors made with modular belts type FLEX -SNB polypropylene with pins in acetal for products in contact with food.

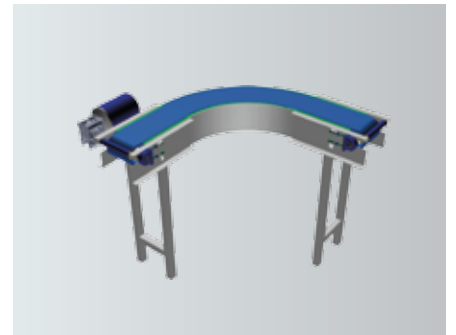
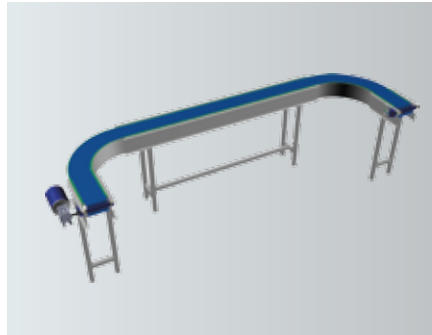
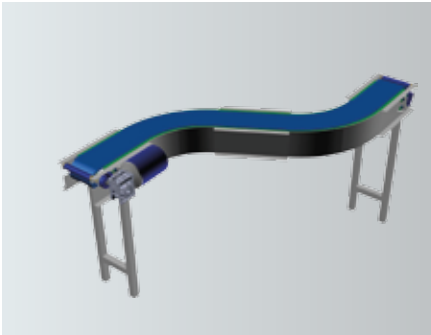

SW-INSPECTOR



TECHNOLOGY for Your Business

MAIN FEATURES

- Operator registry management, production batch, pause times.
- Production report by device/date/serial/surname/name/work minutes/ hours/total/labels/% on total/% on average/% minutes per label/total weight/pieces in threshold/pieces outside the threshold.
- Graphic histogram creation.
- Export data to Excel files (.csv).
- Customizable report.



[Rs Sw Inspector PROCESS THE DATA]

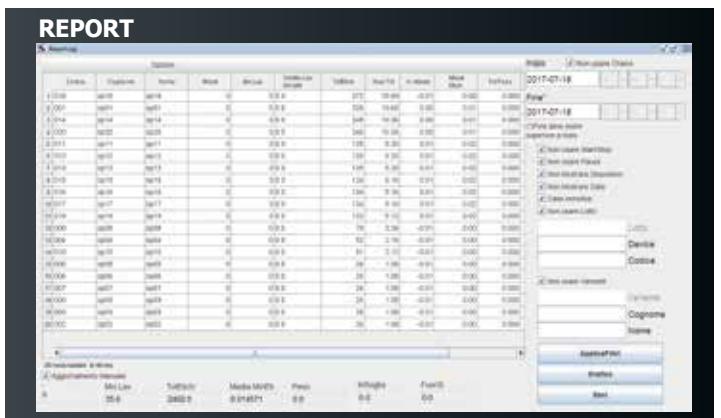
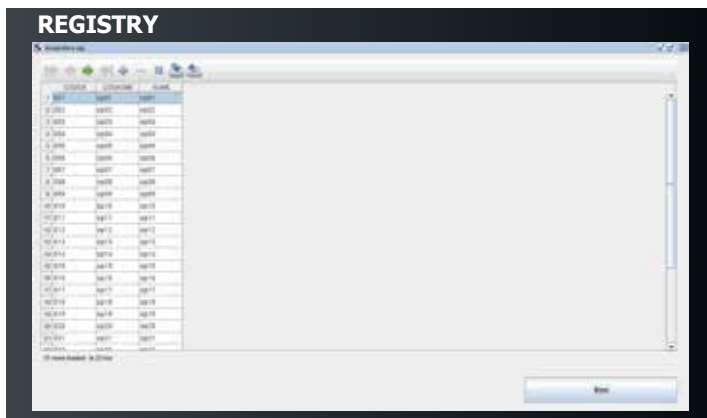
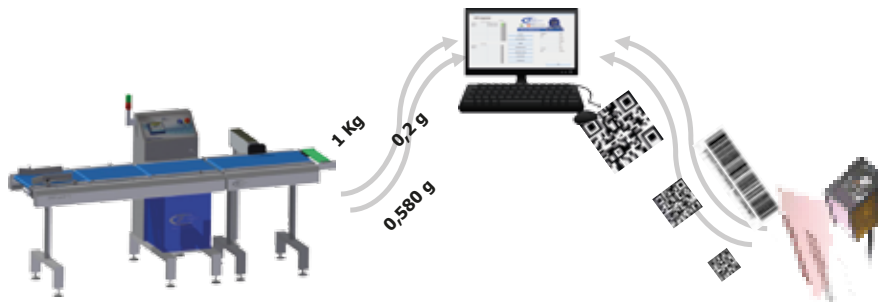

SW-CUSTOM LABEL

LABEL EDITING SOFTWARE

TECHNOLOGY
QUALITY
PRECISION

SW Custom Label

SW Custom Label



Loaded SW CustomLabel...



TECHNOLOGY for Your Business

www.rsbilance.com

SW-CUSTOM LABEL

MAIN FEATURES

- SW-Custom Label is a program for printing and editing labels. It is possible to create labels with great simplicity and without neglecting the graphic aspect.
- Thanks to SW-Custom Label, the purpose of the label will not only be to transfer the typical information, but also to promote a product.
- This is possible thanks to targeted instruments that easily create impact effects that attract attention.

Label format example

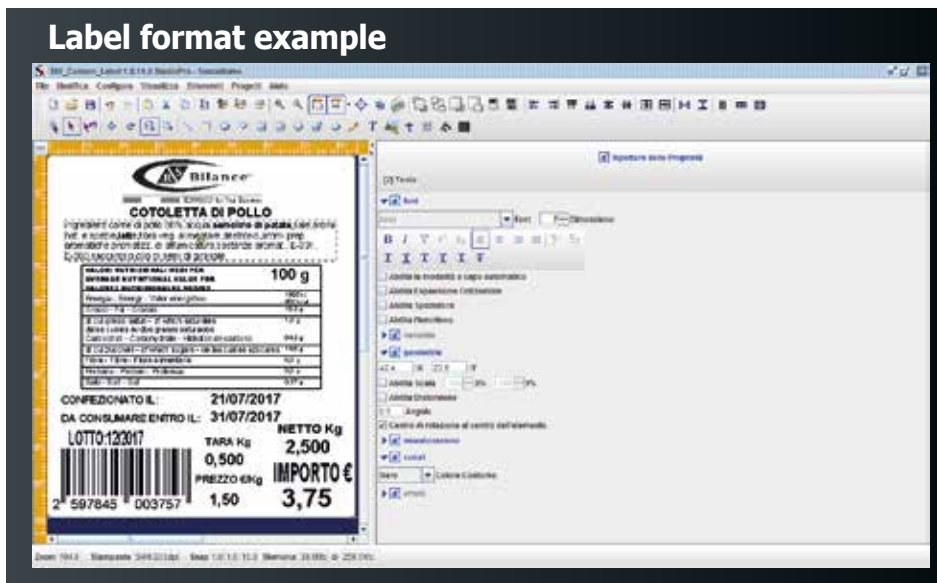

Label format example

