



SPL RULEBOOK

AS A COMPETITOR, PLEASE READ THE ENTIRETY OF THIS HANDBOOK IN ORDER TO ENSURE YOU ARE BUILT TO THE STANDARDS SET FOR YOUR CLASS.

Rev. 1.8 (7/19/2022)

Table of Contents

<u>TABLE OF CONTENTS</u>	<u>2</u>
<u>SPL RULES</u>	<u>3</u>
<u>CODE OF CONDUCT</u>	<u>4</u>
<u>NATIONAL/WORLD RECORD RULES</u>	<u>5</u>
<u>SPL GUIDELINES</u>	<u>6-10</u>
<u>HOW TO CLAMP</u>	<u>11</u>
<u>POINTS QUALIFICATION SYSTEM</u>	<u>12</u>
<u>PORT WARS DIVISION</u>	<u>13</u>
<u>HIGH & HARD/ LOW & LOUD DIVISION</u>	<u>14</u>
<u>STOCK DIVISION</u>	<u>15-16</u>
<u>TRUNK DIVISION</u>	<u>17</u>
<u>NO WALL DIVISION</u>	<u>18-19</u>
<u>MODIFIED DIVISION</u>	<u>20</u>
<u>STREET BEAT DIVISION</u>	<u>21</u>
<u>CONE AREA REFERENCE CHART</u>	<u>22</u>
<u>BASS BATTLES DIVISION</u>	<u>23</u>
<u>XTREME DIVISION</u>	<u>24-27</u>
<u>USACI DIVISION MATRIX</u>	<u>28-29</u>
<u>WHAT IS WORLD FINALS?</u>	<u>30</u>
<u>GLOSSARY OF TERMS</u>	<u>31</u>

2022 USACI SPL RULES

This section of the USACI rulebook was written by USACI Administration in order to retain the basic ideas that have always made auto sound competition fun and fair. Each year, USACI forms a committee of members to gain input from its competitors, the goal being to make the contests fair, fun and challenging. This Rulebook and any subsequent refinements are the result of those meetings. It is USACI's sincerest hope that these rules will be received as an example of the organization's continuing efforts to promote the competitor's responsibility to know and adhere to the rules contained herein.

USACI reserves the right to make written amendments to this Rulebook without prior written notification to its members. USACI will, however, make every effort to notify active members via the Internet and/or by distributing any written changes during the registration process of a sanctioned USACI contest. All competitors and enthusiasts are encouraged to visit our website at www.usaciworldwide.org for rule updates, event schedules and event results.

The rules set forth in this section of the Rulebook shall be used by the USACI official(s) and/or judging staff at all USACI Sanctioned events. It is the responsibility of event officials and staff to adhere to these rules to the best of their ability. In consideration of that, each competitor should read this manual and have a thorough understanding of its contents when designing or improving a competition mobile audio system. Ultimately, it is the competitors' responsibility to know and abide by the USACI rules.

Best regards,

USACI

(C) Copyright 1986 - 2022 United States Autosound Competition International, Inc.

All rights reserved. No part of this publication may be reproduced, transcribed, stored in a retrieval system, or translated into any language or computer language, in any form or by any means, electronic, mechanical, magnetic, optical, chemical, manual or otherwise, without the prior written permission of United States Autosound Competition International, Inc.

Exceptions to this Book:

The USACI Rulebook is published as a guideline for conducting USACI sanctioned SPL events. The head judge at any event may supersede portions of this Rulebook at any time for the following reasons:

1. To avoid violating local law or ordinance.
2. To protect the safety of spectators, judges, competitors, etc.
3. To protect judging meters and equipment.
4. To maintain the integrity of the event and judging.
5. To comply with time constraints as they may be imposed.

2022 REVISIONS COLOR

USACI CODE OF CONDUCT

By entering an event, or being a member of any USACI affiliated online group including, (but not limited to) any social media outlet, you automatically agree to these terms and conditions of the USACI Code of Conduct:

1. All USACI competitors will be required to conduct themselves in a professional manner at all times at events or any online interactions affiliated with USACI.
2. Always be respectful to USACI officials and fellow competitors.
3. Always be respectful to any Sponsors, retailers and promoters affiliated with USACI.
4. Always do your best to operate your vehicle and sound system in a safe respectful manner.
5. Always do your best to represent USACI in a positive fashion.

EVENTS:

Any issues that may arise at an event should be brought to the attention of the head judge and resolved that day. If for any reason you feel the judge's ruling is unfair you may email usaciworldwide@gmail.com for further resolution. If you have a question regarding rules, please email usacirules@gmail.com

Any person(s) found to be threatening or abusive, whether verbally or physically, toward any USACI judge or competitor will be removed from the event. In such instances, the punishment can include up to banning said person(s) for life from all USACI events. This will be determined by USACi Administration on a case-by-case basis.

ONLINE:

Any questions or concerns about issues at events should be handled through email, (any negative online posts pertaining to issues at events will not be tolerated.)

Any vulgar, threatening, abusive or derogatory online posts on any site (including social media) affiliated to USACI will not be tolerated.

The punishment for any of these actions WILL be:

1st Offense = A MINIMUM 90-day suspension from all events and all online interactions.

2nd Offense = A MINIMUM 180-day suspension from all events and all online interactions.

3rd Offense = A MINIMUM 1-year suspension from all events and all online interactions.

The event Head Judge shall be responsible for rendering suspension-based judgments either during the event where the incident occurred, or afterward at the joint discretion of the Head Judge & USACi Administration.

USACI NATIONAL RECORDS & WORLD RECORD RULES

All rules of the class being run will apply. Refer to the rules and matrix for the division and class in which you are attempting a record for those individual rules and limitations.

National Records may only be attempted at National Record events. If National Record attempts are allowed, the event schedule will denote that with the "NR" in the events category. All National Records recorded at the event must be submitted in writing along with the competitor's name, address and individual national record fees to the USACI office within 72 hours of event completion. Once National Records are verified they will be posted and the competitor mailed an award plaque with his/her name, class, new record, and date set. (USA only) Other countries are responsible for their own awards. The Price for a National Record run is \$75 in the USA, other countries will set their own pricing structure and are responsible for providing their own awards.

World Records may only be attempted at WORLD FINALS. Once World Records are verified they will be posted and the competitor mailed an award plaque with his/her name, class, new record, and date set.

All vehicles must make two runs, and both runs must exceed the prior record in order for a new record to be recognized. Of these two runs only the LOWEST reading of the two shall be recognized as the new record.

Bracing Teams will be permitted during Outlaw SPL Record Runs. Bracing teams will only be allowed in and out of the lanes as directed by the Judge.

NO Bracing Teams will be allowed in Legal SPL Record Runs.

After a record has been achieved the judges will inspect the vehicle. The engine compartment, interior compartment, trunk or hatch compartment, and undercarriage of the vehicle will be inspected to make sure all the requirements of the class in which the record is being attempted are fulfilled and that there are no modifications that disqualify the run. Only after this verification may a National/World Record be announced.

If a competitor is disqualified on a National/World Record attempt, all previous SPL runs at that event in that class will be given a zero score. Any additional classes the competitor may have run will be subject to a zero score if the infraction applies to more than one division or class. The competitor may purchase a rerun to gain a qualifying score to continue in the class at the event.

If more than one competitor sets a record in the same class, on the same day, or at the same event, only the higher record will be acknowledged.

"LEGAL" records will be recorded on the windshield 12" from the passenger "A" pillar, 4" above the dash, and 1" off the glass. A USACI microphone jig or tape measure may be used to determine this location. The microphone will adhere to the windshield using the factory suction cups provided. If the mic/sensor falls, the suction cups may be taped to the glass but the mic/sensor may not be taped in any way. Vehicle must be closed and sealed. Competitor may be in the vehicle but must sit on the opposite side of the microphone and must wear hearing protection at all times. Competitor refers to registered owner or other persons as designated by registered owner.

In all **Legal (Dash)** record attempts the vehicle may be running. The record reading will be taken with the engine on or off, (both runs must be the same way) over a 30 second period. If the first attempt is successful at breaking the record, then the vehicle will be left unchanged and without any work or modifications for up to three minutes. The second run may be attempted in less than three minutes but may not exceed three minutes. Once the second run is complete and both runs have surpassed the current holding record the vehicle will be opened for inspection by the judges. Once the vehicle has been inspected and verified for the class a record will be announced.

"OUTLAW" records may be recorded anywhere forward of the "B" pillar. The microphone must be secured in a USACI certified globe and be placed where it can be observed by the world record official during the entire run. Doors may be open or closed but may not be opened and then closed during the run. Competitor may be in the vehicle but must sit on the opposite side of the microphone and must wear hearing protection at all times. Competitor refers to the registered owner or other persons as designated by owner.

In all **Outlaw SPL** record attempts the vehicle may be started 30 seconds prior to the record run. Idle must be set no more than 2000rpm. If a record is achieved on the first run the vehicle may not be worked on or modified for a period of up to three minutes. You may elect to do the second run earlier but no later than three minutes after the conclusion of the first run. If the record attempt is successful then the vehicle engine will be turned off and the vehicle opened to the judges for final inspection prior to the record being recognized.

USACI SPL GUIDELINES

DIVISIONS:

Outlaw SPL divisions are based on the configuration of the system and vehicle. Specific guidelines for each division will be discussed in their respective sections of this book.

Commercial type vehicles such as box trucks, panel trucks, anything bigger than a full size van or truck, buses, ambulance, armored car/truck, 18-wheelers, etc. will only be allowed to compete in Extreme classes.

CLAMPED CLASSES:

You will be required to have the amplifier(s) and speaker's wires easy to access and verify that the clamp meter is connected properly and no rules are violated.

The subwoofer amplifier(s) is/are limited to one set of speaker wires (a single + positive wire and a single – negative wire) out of the amp at least 1ft in length where the clamp and probes will be connected to ensure the power will read properly. After the 1ft of length out of the amplifier(s) you can split the speaker's wires as many times as you like to the subwoofers.

The speaker wires should be a minimum of 12 gauge in size to properly probe the wires.

In the case of two amplifiers it is required to have the amplifiers strapped. More than one non-strapped amplifier will NOT be allowed in Clamped Classes.

It is the competitor's responsibility to possess the tools and skill to connect/disconnect the clamp meter. You will be required to clamp the positive speaker wire of the amplifier(s) as well as probe the positive + and negative - speaker wires. USACI and its directors are only responsible for verifying the clamp and probes are connected correctly. USACI and its directors are not responsible for any damage to the vehicle or audio equipment due to improper installation of the clamp meter; the competitor assumes all responsibility of the clamp meter installation and removal.

In order to place in a Clamped Class and get points you must establish a score within the power rating of the class.

Any competitor caught cheating or attempting to cheat the clamp meter will be banned from all USACI events for a minimum of one year.

If any amp gives a false reading after two attempts, the competitor will be moved to the unlimited class in that division, unless it is determined to be a malfunction due to the Term Lab equipment.

**** USACI reserves the right to review and/or remove any amplifier from competition for the clamped division if we feel it has an unfair advantage or the amplifier will not read properly on the clamp meter. ****

AMPLIFIERS DEFINED:

One amplifier is considered one power supply, one system board, driving 1 or 2 channels. A 3-4-channel amp would be considered two amplifiers. A 5-6-channel amp would be considered three amps and so on.

POWER SOURCE:

All audio equipment must derive its power from inside the vehicle. No external power sources (battery chargers, solar panels etc.) will be allowed in the lanes during the run, unless it is determined to be inoperable by the Head Judge.

USACI OUTLAW SPL JUDGES:

Outlaw SPL Judges shall be appointed by the Head Judge or the event sponsors and are subject to approval by USACI. A USACI Outlaw SPL Judge shall not be allowed to judge any vehicle being entered by an immediate family member, employee, employer or substantial customer. The Head Judge may appoint an alternate to judge that vehicle. It is within the Head Judge's or other USACI Outlaw SPL official's authority to decide the application of this rule to any disputes.

JUDGING ORDER:

The Head Judge will determine if there is a specific judging order. Judging will end when all vehicles have been judged. No score or refund will be given to a competitor who fails to have their vehicle in the judging line before the judging has ended.

"3 MINUTE RULE"

Any competitor who allows or causes more than a 3-minute "gap" between cars at the judging station may have their score disqualified and have to make a rerun, at the discretion of the event director.

USACI reserves the right to run an event using either an in-place or specific order judging routine. At any event, it is the responsibility of the Event Coordinator or Head Judge to inform the competitors involved of the details of that day's judging format.

MULTIPLE JUDGING LANES:

Some events may form two or more judging lanes in order to expedite the judging process. In such cases all competitors in a particular power class and division will be judged in the same line and on the same test equipment. It is the responsibility of the competitor to confirm which lane his or her power class and division is to be judged in.

DRIVING THE VEHICLE THROUGH:

Judging shall be conducted with each competitor's vehicle being driven through a judging lane in an orderly fashion. The vehicle must drive in and out of the judging lane under its own power. **Any classes that follow the Stock Rules must be able to pull forward in and out of the lanes, unless otherwise deemed acceptable by the Head Judge at the Event. All vehicles will be limited to one set of floor mats. The floor mats must remain flat on the floor in the OEM locations.**

SYSTEM OR VEHICLE MALFUNCTIONS:

An equipment or vehicle malfunction is the competitor's responsibility. Once the vehicle is in position to be judged, the competitor shall be allowed a maximum of three minutes to correct or repair any malfunction. After the allotted time has expired, the vehicle must be judged if possible or given a score of zero. No repairs will be allowed after SPL testing has started. No refunds will be given.

RERUNS:

At most events competitors will be allowed to register and rerun their vehicle to improve their score or standing. If a competitor chooses to rerun his or her vehicle, the sound system must be made up of the same size speakers, the same number of speakers, and the same number of amplifiers as was in the vehicle on its first SPL attempt. A change in brand is acceptable provided the new equipment does not change the class or division of the vehicle. There will be an additional fee for all reruns. All competitors must have an operational system in their vehicle at the time of registration. This system must be the system the competitor competes with at the event. Competitors may change equipment in case of malfunction, but entire system and enclosure may not be swapped.

Intent: The intent of this rule is to prevent competitors from sharing the same audio system in more than one vehicle. The Head Judge at the event shall interpret this rule and such decision may only be appealed to USACI Administration.

IN CASE OF A TIE:

In the event that two or more competitors in the same Clamped Class receive the same final score, the winner will be determined by lowest wattage established.

Unlimited classes will continue to do tie breaker runs until the loudest score determines a winner.

DISRUPTING AN EVENT:

The Head Judge reserves the right to deduct points or ask any competitor to leave an event if the competitor's behavior becomes disruptive during the course of the event. If a disruptive competitor is asked to leave, the competitor will not receive a refund. Any points or awards the competitor might have earned at that event will be forfeited. Competitors will be responsible for the actions of their guests at the event.

If the cause of the inappropriate behavior is believed to be alcohol or any other controlled substance, USACI has the right to ban the competitor from competing in any sanctioned USACI events for a minimum of one year.

To help assure that every USACI event is conducted in a safe environment, no weapons in the possession of a competitor or anyone accompanying a competitor will be tolerated. If the competitor does not comply with this demand, he or she will be disqualified, asked to leave the event site or be escorted from the site by the local authorities. Any threats towards anyone involving a weapon, however casual, will be cause for banning the competitor from ever again competing in any USACI sanctioned event. No refunds will be given for being disqualified.

CHEATING:

Cheating of any sort will not be tolerated, if any situations arise where cheating is brought forth as an issue the Head Judge and/or USACi Administration will make the final decision.

APPEALING A DECISION:

If a competitor questions any score or a possible error in the judging process by which that score was achieved, the competitor may discreetly seek explanation by the Head Judge of the event. The decision of the Head Judge will be considered final at that event. After the event, a competitor may petition the USACI Administration via email at usacirules@gmail.com to reconsider either a rule or a Head Judge's decision. Neither USACI nor an event sponsor assumes responsibility for any awards previously given to another competitor, even if in error.

PROTESTS:

If a competitor has made a plausible complaint, involving any unfair or illegal item which may be hidden in another competitor's vehicle, and would require disassembly of that vehicle or audio system to verify its existence, then the complaint must be accompanied by a cash security deposit. (**No checks**) Such complaints may only be made after the vehicle in question has been judged at that event and before any prizes are awarded. The security deposit required to file a protest at any events will be \$500.

The Head Judge must have the security deposit in hand before any action may be taken. The Head Judge or their representative will then oversee the disassembly of the vehicle in question. The competitor whose vehicle is in question may elect not to have their vehicle inspected by disqualifying themselves from the event with no refund. If, in the Head Judge's opinion, the vehicle in question is found to be inconsistent with this rule book, the cash security deposit will be returned to the competitor making the complaint, minus a processing fee of \$100, and the competitor in question may be disqualified from that event and all future USACI events based on a ruling of the Head Judge or a joint effort of the Head Judge and USACi Administration. The competitor can correct the offense and purchase a rerun to gain a qualifying score to continue in the class at that event. If in the Head Judge's opinion, no inconsistency is found in the vehicle in question, then the cash security deposit, less \$100 USACI processing fee, will be awarded to the competitor whose vehicle was inspected and it will be the responsibility of the competitor who was protested to reassemble the vehicle or audio system.

In the event a competitor is protested, they must be present to be verified otherwise their runs for the class in question will be disqualified. Protests may be made anytime before the lanes close.

RULE INFRACTIONS:

Any rule infractions that can be resolved **WITHOUT** disassembly may be handled by the Head Judge at the event when brought to their attention. Rule infractions must be brought to the attention of the Head Judge, in a calm and respectful manner, during the applicable test session in a way that does not actively interrupt a test itself. (I.e. before the first attempt, between attempts, or after testing while the test vehicle is still parked in the test lane.) If the suggested infraction is recognized by the Head Judge as legitimate, corrective action must be taken by the competitor before testing may continue. If the vehicle's testing is complete, both test runs made by the competitor must be disqualified, not the competitor or the vehicle. If the competitor in question refuses or is unable to make the required remedies, their runs will be disqualified.

SOUND PRESSURE LEVEL TESTING:

The occupant of the vehicle under test shall have proper hearing protection if remaining in the vehicle for testing. If the occupant does not wear hearing protection they assume all liability for damages. Only the registered owner or person of their choice may be inside the vehicle during SPL testing.

The SPL microphone/sensor may not be placed on the same side of the vehicle as the competitor. Competitor testing inside their vehicle must remain in the front of vehicle (forward of "B" pillar) during their run.

An audio system's Sound Pressure Level will be measured using an approved sound pressure level meter. This test must be measured using the current version of the USACI Outlaw SPL competition software, unless stated otherwise in a specific division. A CD, USB, IPOD etc. may be used as long as the judge can verify the software's authenticity. The Promoter of the USACI event will provide this in the case that the competitor does not have their own.

The Judge will be responsible for making sure the SPL meter is set up and functioning correctly. The competitor must have the vehicle ready to test prior to entering the judging lane. After the SPL microphone/sensor has been placed, the software loaded, hearing protection properly placed over the occupant's ears (if applicable) and the system readied, the competitor should signal the judge that he or she is ready for the test.

Once the test begins the competitor has thirty seconds for all runs, except Bass Battles Division which allows for 60 seconds, to try and achieve the highest score possible. The music, tone or sweep may be restarted and/or the tracks can be changed as often as possible within the allotted time. The competitor may choose to stop the SPL testing at any time before the end of the allotted time, but the judge must be able to verify that the correct software is being used during testing. The use of tone generators, doublers or any other device that externally (outside of the closed signal chain) generates or alters the frequencies that the system is playing during SPL testing is expressly prohibited and will result in disqualification with no refund. Any tampering with the microphone/sensor or attempt to create a measurement by any means other than SPL produced by the audio system will be considered grounds for immediate disqualification and possibly being banned from future competition in any USACI sanctioned events. The Head USACI Official present will investigate for any evidence of such tampering and the ruling of this official is final.

The vehicle's engine may be running during testing, but will be limited to 2000rpm

Vehicle bracing teams are allowed except during legal runs. The owner of the vehicle assumes all liability and takes full responsibility for anyone that is bracing, or on top of the vehicle. No outside bracing will be allowed to vehicle including straps or non-factory items on the outside of vehicle. If a competitor utilizes a podium outside the vehicle, no other person may occupy the vehicle during testing.

If a competitor's SPL run(s) are disqualified due to a rule infraction, the competitor will receive a zero score. The competitor will be allowed to fix the issue and purchase a Rerun only if the infraction is deemed unintentional by the head judge. Disqualifications are for the runs, not the competitor, unless it is deemed intentional, then the competitor will be disqualified.

If any vehicle experiences a window break during testing at any event, the competitor will be allowed to use up to 2 layers of clear packing tape to help keep the vehicle safe for any additional runs, so long as there is an 8.5" by 11" horizontal viewing window on the driver's side left un-taped.

80 HZ cap limit in all classes

MICROPHONE/SENSOR PLACEMENT:

The microphone/sensor will be placed anywhere forward of the "B" pillar in the passenger compartment with a microphone/sensor globe attached in all SPL classes. Special panels or enclosures for globe placement will not be allowed. No modifications designed to direct air pressure within 6" of the globe will be permitted. No objects will be allowed to cover the globe, including but not limited to floor mats, carpet, towels etc. No objects will be allowed in the seats or floorboards forward of the "B" pillar. The microphone or sensor may not be placed anywhere that is deemed "hazardous to the equipment" by the Head Judge. The Microphone may be removed from the globe during testing only if it is to be placed in the "LEGAL" position on the windshield. Legal Position is 12 inches from passenger "A" pillar, 4 inches above the dash, attached to the windshield. Any construction or speaker placement that may manipulate the SPL meter may be considered reason to reclassify the vehicle. This decision will be at the discretion of the Head Judge. All lanes will use the same individual globe and mic/sensor throughout the event unless there is a malfunction of the globe or mic/sensor, then the judge may replace the globe or mic/sensor and continue the event. The globe and mic/sensor will be used in the same manner by all competitors and may not be attached to the vehicle in anyway other than the jig that is optionally provided by the judge. Competitor-owned mic/sensors, globes, jigs and clamps are not allowed for use during testing.

RESPONSIBILITY OF COMPETITOR:

It is the competitor's responsibility to legibly complete the event entry form with their first and last name, and are also encouraged to check against spelling and class selection errors in order to ensure accurate standings and points accumulation.

The competitor is responsible for his or her vehicle and audio system and any physical or mechanical damage resulting from their use or misuse of the vehicle and/or the audio system therein. It is the competitor's responsibility to know and abide by the rules contained in this book. If a competitor has questionable modifications or factory options, the competitor must supply the proof that it is legal for the class in question. It is the competitor's responsibility to know and understand how the clamping process works. See attached diagram on Page 11.

DEFINING THE TERM "COMPETITOR":

The term "competitor" applies to the vehicle's owner or team, an employee of its owner, an immediate family member, or a person bearing a power of attorney for the vehicle's owner. If a competitor is unable to attend an event, he or she may designate someone to drive the vehicle through the judging line. The designated person will be considered a competitor and will assume all responsibilities of such. Only one vehicle will be allowed to compete under one unique competitor name per event. No one vehicle may be shared by multiple competitors at any given event, and must be run under the name of the owner of the vehicle.

Competitors must be present at a show to acquire points. Competitors who have entered an event, present and able to be verified, will receive a score of 1 if the event is shut down due to unforeseeable issues at the show. (Venue shuts down, Law Enforcement shut down, or Severe Weather) **Competitors who receive a score of 1 will not receive an award.** This is NOT for Competitors that ran in their division and exceeded their power rating for the class entered or competitors that entered a clamped class, you must put forth a score in a clamped class without exceeding the wattage limit to acquire points.

USACi Competitors registered or pre-registered must have their entry forms turned in at the USACi Booth to qualify for any score/points. Under no circumstances are refunds issued for on-site entries or pre-registered entries. USACi entries are non-transferable at any event

EVENT REGISTRATION:

Event registration will begin at the stated commencement time of the event.

Each vehicle can be entered and judged in only one class but in as many divisions as it may qualify to compete in. A separate registration is required for each division's judging. No matter the number of vehicles one competitor is running, they may only enter one class per division. Vehicles may reenter the same class as many times as the event schedule will allow. (Reruns)

All vehicles must be licensed and registered, and be "street legal" as per federal regulations to compete in the, Stock and Trunk divisions (Or any class/division that uses these rules). Vehicles that do not comply will be reclassified to another division.

Competitors will not be allowed to compete using another competitor's vehicle to enter classes. The only time a Competitor may run a vehicle for another is with written permission from the owner or emailed permission sent to UsaciRules@gmail.com. In the case that someone is running a vehicle for another Competitor they must run the vehicle under the vehicle owner's name. Team names may be used so long as the name of the competitor testing the vehicle lists their name on the entry form as well (I.e. Team Bass-John Smith)

A vehicle may only be run under one name per event.

It's the competitor's responsibility to maintain proof of financial responsibility.

VERIFICATION JUDGING CRITERIA:

The Verification Judge will verify the power ratings of each amplifier installed (if applicable) in the competitor's vehicle to ensure that the vehicle has been entered in the appropriate power class. The verification judge may install a voltage meter in any vehicle IN ANY DIVISION to monitor voltage during the run. While this is optional at single point events it will be MANDATORY at all multi-point events. If a competitor's audio system does not, in the judge's opinion, meet all of the following basic requirements, the competitor may be disqualified from the event or be reclassified to the Unlimited Class. The vehicle and audio system must be fundamentally safe for the judging area. The audio system must consist of components that use some form of 12 VDC negative ground power supply. The vehicle and audio system must operate under its own power while being judged. No equipment (batteries, subwoofers, amplifiers etc.) can be changed after the vehicle has been verified for a specific class until the vehicle has left the judging lane.

During verification only 1 person with the vehicle may be present.

During any run, only people associated with that vehicle will be allowed in the lanes. Everyone else will be required to be behind the barricades. The competition lane must remain free and clear of spectators and/or excessive persons, as deemed by USACi staff.

The Head Judge at the event has the final judgment regarding any required rulings at said event.

AS A COMPETITOR, PLEASE READ THE ENTIRETY OF THIS HANDBOOK IN ORDER TO ENSURE YOU ARE BUILT TO THE STANDARDS SET FOR YOUR CLASS. WE UNDERSTAND CERTAIN THINGS CAN BE OVERLOOKED AT TIMES AND ASK THAT YOU TAKE THE TIME TO ENSURE THAT YOUR BUILD(S) ARE IN COMPLIANCE PER THE RULEBOOK TO GUARANTEE YOUR SUCCESS ALL THE WAY THROUGH WORLD FINALS.

CLAMPED CLASSES: HOW TO CLAMP YOUR AMP(S)

SINGLE CHANNEL SINGLE CONDUCTORS

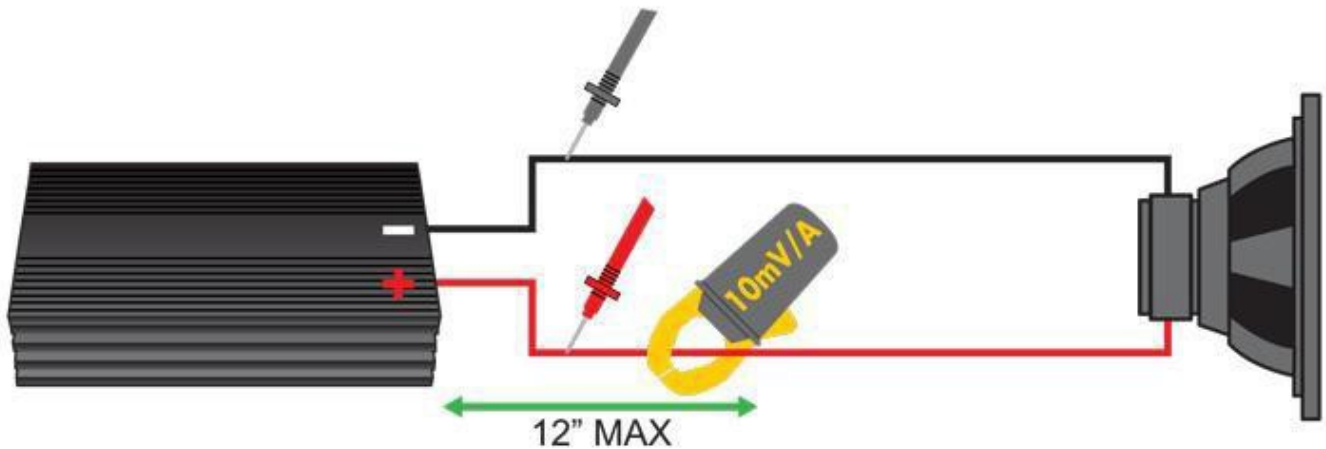

Note 1: The probes and clamp must be located within 12 inches of the speaker terminals on the amplifier.

Note 2: You can clamp **either** the positive or negative conductor.



SINGLE CHANNEL, SINGLE CONDUCTORS, STRAPPED AMPS

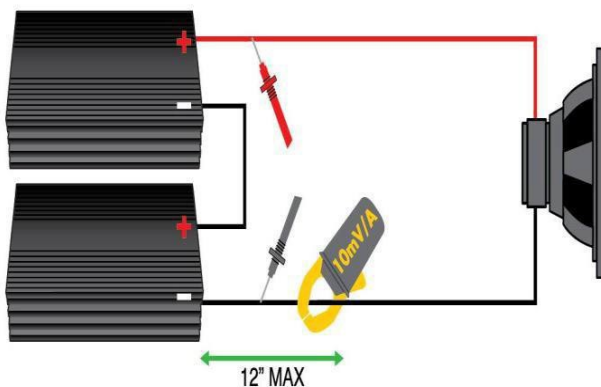

- The probes and clamp must be located within 12 inches of the speaker terminals on the amplifier.
- You can clamp **either** the positive or negative conductor.

USACI POINTS SYSTEM

Single point event:	Double point event:	Triple point event:	Regional event:
1st = 8 points	1st = 16 points	1st = 24 points	1st = 32 points
2nd = 7 points	2nd = 14 points	2nd = 21 points	2nd = 28 points
3rd = 6 points	3rd = 12 points	3rd = 18 points	3rd = 24 points
4th = 5 points	4th = 10 points	4th = 15 points	4th = 20 points
5th = 4 points	5th = 8 points	5th = 12 points	5th = 16 points
6th = 3 points	6th = 6 points	6th = 9 points	6th = 12 points
7th = 2 points	7th = 4 points	7th = 6 points	7th = 8 points
8th+ = 1 point	8th+ = 2 points	8th+ = 3 points	8th+ = 4 points

QUALIFYING FOR USACI WORLD FINALS:

Special Invites will only be given in the case of Acts of God, Major Life Events, or Military Deployment.

Bonus points acquired from any other organization may not be used as qualifying points for World Finals entries nor Points Champion.

MILEAGE CURVE:

Competitors with **NO SHOWS** within a 200-mile radius (Mileage Curve) of their permanent residence during the competition season will automatically be qualified to attend World Finals. Competitors attending World Finals under the Mileage Curve will only be allowed to compete in one class and will be subject to an additional \$100 processing fee.

Show Attendance Percentage:

Any Competitor that has a **LIMITED** amount of shows within a 200 Mile Radius of their permanent residence may qualify for the Show Attendance Percentage, and may compete in any classes for which they have accumulated 25 qualifying points or more.

If a competitor has 3 or less shows in their area and meets the show attendance % but not the qualifying points for any classes, they may be permitted to run whichever one class they have accumulated the most points in.

Show Attendance % is as follows:

50%-74% will be eligible and only pay an additional \$50 fee 75%-

90% will be eligible and only pay an additional \$25 fee

91%-100% will be eligible and able to come without the additional fee.

*Show Attendance Calculation Formula: $(X/Z=A)100$ (X = # of shows attended, Z = # of shows offered, A = Attendance Factor. Example: 5 Shows attended / 6 total shows = .83 multiplied by 100 = 83%. For questions regarding this calculation please email usaciworldwide@gmail.com

A competitor may only compete in one class per division, but may compete in multiple divisions if the competitor is qualified to do so.

Qualifying Runs will be on Saturday, if you have not been given a time slot for that day or turned in your entry form in the lanes you will not be permitted to Rerun on Sunday.

TOTAL POINTS REQUIRED FOR USACI WORLD FINALS =75

POINTS REQUIRED PER CLASS FOR USACI WORLD FINALS=24

POINTS CUTOFF WILL ALWAYS BE THE 31ST OF DECEMBER, ANY SHOWS AFTER THIS DATE WILL BE POINTS ACCUMULATED FOR THE FOLLOWING SEASON.

Points cutoff is December 31st.

PORT WARS DIVISION

The competitor may choose to run with or without the globe.

If the globe is not used the mic must go in a USACI approved mic jig.

The sensor may be placed in any location that it will fit into provided the location does not pose a threat to the safety of the microphone/sensor.

Once the microphone/sensor is placed it cannot be moved until the run is over.

The jig may be held in place by the competitor or someone of the competitor's choice, there will be no fanning, shaking or attempting to manipulate airflow. The microphone must remain completely still and not be moved until the 30 second countdown expires.

The enclosure must be located inside the vehicle and may not obstruct the driver's ability to operate the motor vehicle.

The port must exhaust into the interior or the passenger compartment of the vehicle.

The opening of the port the microphone is placed in may not be modified after the microphone has been placed, and the port must be 4" or greater in diameter measured in any given direction.

The use of tubes, pipes, or other devices to intentionally direct airflow across the microphone/sensor will not be allowed.

PORT WARS DIVISION

POWER CLASS	AMPLIFIER QUANTITY	ALLOWED INTERIOR MODIFICATIONS	BATTERY QUANTITY	ALLOWED SUPER CAPACITORS	ALTERNATOR QUANTITY	MAX VOLTS	CONE AREA LIMIT	MUSIC AVERAGE/TONE	RULES
PORT WARS	UNLIMITED	UNLIMITED	UNLIMITED	YES	UNLIMITED	18V	UNLIMITED	TONE	PORT WARS

HIGH & HARD DIVISION

*OPEN CLASS-Test tones only, any frequency 46 hertz and up (anything below will DQ)

LOW & LOUD DIVISION

*OPEN CLASS-Test tones only, any frequency 45 hertz and below (anything above will DQ)

HIGH&HARD/LOW&LOUD DIVISION

POWER CLASS	AMPLIFIER QUANTITY	ALLOWED INTERIOR MODIFICATIONS	BATTERY QUANTITY	ALLOWED SUPER CAPACITORS	ALTERNATOR QUANTITY	MAX VOLTS	CONE AREA LIMIT	MUSIC AVERAGE/TONE	RULES
H&H NO WALL	UNLIMITED	BEHIND B 12" FROM HEADLINER	UNLIMITED	YES	UNLIMITED	18V	UNLIMITED	TONE 46 & UP	NO WALL
H&H WALL	UNLIMITED	UNLIMITED	UNLIMITED	YES	UNLIMITED	18V	UNLIMITED	TONE 46 & UP	XTREME
L&L NO WALL	UNLIMITED	BEHIND B 12" FROM HEADLINER	UNLIMITED	YES	UNLIMITED	18V	UNLIMITED	TONE 45 & DOWN	NO WALL
L&L WALL	UNLIMITED	UNLIMITED	UNLIMITED	YES	UNLIMITED	18V	UNLIMITED	TONE 45 & DOWN	XTREME

STOCK DIVISION

The power source may not produce more than 15.5 volts at any time during the run with or without the vehicle running.

An unlimited amount of "automotive type" sound deadener is allowed, but cannot be used as a wrap on the outside of a vehicle or as upholstery. Tapes, resins, spray foams, sound deadeners etc. should NOT be visible in the interior passenger compartment of the vehicle and cannot be used to seal vents, windows, interior panels or hold panels together in the interior passenger compartment of the vehicle.

No modifications will be allowed to the interior of the passenger compartment or cargo area of the vehicle, in order to facilitate the audio system. The floor, ceiling, dashboard and interior panels must be OEM and in place. Other than the audio equipment and the allowed modifications for the Division, the vehicle interior should appear to be stock.

All windows, doors and trunk or hatch openings must function as OEM and may not be permanently sealed

Batteries and Alternators may be upgraded.

The OEM location battery may be relocated.

The spare tire cover and cargo area carpet may be removed.

OEM interior panels may be upholstered or painted, but may not be modified or removed.

Custom consoles will not be allowed in the Stock division

No subwoofers are allowed in front of the B-pillar.

Any equipment being used for SPL (batteries, amplifiers, subwoofers etc.) must be located only in the designated cargo areas behind the B-pillar. In passenger cars, this would be either in the trunk or hatchback area.

The enclosure, or any device(s) affixed to the enclosure may NOT block the view out of the rear glass. The enclosure or any device(s) affixed to the enclosure may NOT protrude above the bottom of the rear side window line. The rear side window line will be defined as the point where the interior panel, metal of the vehicle, or window seal ends (whichever applies) and the window glass begins on the interior of the vehicle. If the vehicle does not have rear side windows, (such as single cab trucks) the rear window of the vehicle will be used for the window line.

No portion of the enclosure or audio system with the exception of the audio controls (podium, external head unit etc.) will be permitted to be located outside of the vehicle. This includes the bed of a pickup truck. Vehicles utilizing external controls must have OE or aftermarket unit in OE location.

Rear passenger seat backs may be folded down during testing but may not be removed, nor may any part of the entire rear seat assembly be removed or altered. Rear seat backs must not have any exposed sound deadener.

Amplifiers may be attached to the seat backs and folded down during testing. In such cases the seat must be able to return and lock into the factory position after testing.

Two seat hatchback vehicles competing in the stock division will be required to have all equipment located in the cargo area of the vehicle, and all factory cargo panels must be in place. Equipment behind the front seats and in "foot wells" is not permitted.

Trucks, vans, SUV's and cargo vehicles competing in the Stock division will be qualified as such:

In full size trucks originally equipped with forward facing rear seats, the cargo area will be defined as being under or behind the rear seat only. In mini trucks or trucks with side facing rear seats, the area behind the "B" pillars will be considered the cargo area. In both or either of these cases the enclosure, or any device(s) affixed to the enclosure may NOT protrude, forward of the "B" pillars.

External cosmetic modifications are allowed to the vehicle so long as they are cosmetic in nature and are not implemented to further SPL score, (i.e. shaved door handles, removed badging, body kits, removal of factory -optional accessories, etc.) All portions of the system must remain inside the factory bodylines, please refer to the Glossary of Terms for a better understanding of what USACi defines as "factory bodylines". Equipment in or on trailers, hitch racks, luggage racks and so on will not be permitted. No portion of the enclosure or audio system will be permitted to be located outside of the vehicle, with the exception of external audio controls unless specified by the Division's Exceptions.

Automotive type spray-on bedliner is permissible for use on exterior body panels as a substitute or alternative to paint.

Exceptions:

Vehicles with sunroofs need not have them operable. They may be sealed, but may not have any exposed deadener and if covered, must be covered with OEM equivalent material.

Aftermarket automotive front seats may be installed provided they are OEM equivalent in size, shape and function of the front seats. If the seats have removable headrests they must be installed. Seats must be bolted down in the OEM location.

Door panel build outs to add midrange speakers are allowed as long as the OEM panels are used, no more than 25% of the OEM panel may be modified. Custom door panels must house at least one set of midrange speakers. A maximum of one pair of 8" or a single 10" midrange speaker(s) plus the stock location will be allowed per door. Door panel build outs can't interfere with the door closing or operation of the vehicle and may only protrude 4" from the factory metal door skin. No pocketing will be allowed.

Enclosures in the cargo area of all vehicles competing in the Stock division must be installed behind the rear most passenger seats.

In the case of a single cab pickup truck the box, speakers, and amplifiers may extend forward of the "b" post but must not extend further forward than the rear of the truck seat back. Seat back must be locked in place and the seat mounting may not be moved to facilitate system installation. The front most 24" of the bed may be utilized to facilitate the audio system with the exception of woofer enclosure and woofers. (I.e. Amplifiers, Batteries, Capacitors, Wiring, Fusing, Distribution, & etc.) No external portion of the audio system in the bed may exceed higher than the bed rails.

Bed cuts will not be allowed in Stock Division.

In vans and SUV's with OEM rear seats, the cargo area will be defined as the area behind and under the rear passenger seats. Batteries and amplifiers will be allowed to be mounted under the rear seat. Any equipment must not protrude past the bottom of the rear seat when it is in the upright position. The rear seat must be able to fold down, lock in place in the upright position and retain all OEM functions. If the vehicle came with a third row seat it may be folded down or removed.

Vans and SUV's that are originally manufactured without rear seats cannot compete in the Stock division

STOCK DIVISION

POWER CLASS	AMPLIFIER QUANTITY	ALLOWED INTERIOR MODS	BATTERY QUANTITY	ALLOWED SUPER CAPACITORS	ALTERNATOR QUANTITY	MAX VOLTS	CONE AREA LIMIT	MUSIC AVERAGE / TONE	RULES
STOCK 1K CLAMPED	2 AMPLIFIERS (STRAPPED)	NONE	UNLIMITED	YES	UNLIMITED	15.5V	UNLIMITED	TONE	STOCK
STOCK 3K CLAMPED	2 AMPLIFIERS (STRAPPED)	NONE	UNLIMITED	YES	UNLIMITED	15.5V	UNLIMITED	TONE	STOCK
STOCK 6K CLAMPED	2 AMPLIFIERS (STRAPPED)	NONE	UNLIMITED	YES	UNLIMITED	15.5V	UNLIMITED	TONE	STOCK
STOCK UNLIMITED	UNLIMITED	NONE	UNLIMITED	YES	UNLIMITED	15.5V	UNLIMITED	TONE	STOCK

TRUNK DIVISION

TRUNK DIVISION uses the General and Stock Rules with the following exceptions:

The power source may not produce more than 15.5 volts at any time during the run with or without the vehicle running.

Enclosures in the Trunk Division must be installed in the trunk. Neither the enclosure, nor any device(s) affixed to the enclosure may protrude above the factory rear deck. The rear deck may not be cut out or modified in any way (to include sheet metal, and rear deck coverings). You may however remove the factory speakers normally located in the rear deck. Amplifiers must be located in the trunk area. Amplifiers may be attached to the seat back and lean forward with the seat back during testing but must not interfere with the seat being placed back into the factory position. Vehicles without a "Trunk" will not be allowed in this division. "Hatchback" vehicles are not allowed.

Rear passenger seat backs may be folded down during testing but may not be removed, nor may any part of the entire rear seat assembly be removed or altered. Rear seat backs must not have any exposed sound deadener.

Amplifiers may be attached to the seat backs and folded down during testing. In such cases the seat must be able to return and lock into the factory position after testing.

OEM interior panels may be upholstered or painted, but may not be modified or removed in any way but with these exceptions:

Factory panels in the trunk area may be removed to facilitate the system.

***See Page 17 for more information on Stock rules.**

TRUNK DIVISION

POWER CLASS	AMPLIFIER QUANTITY	ALLOWED INTERIOR MODS	BATTERY QUANTITY	ALLOWED SUPER CAPACITORS	ALTERNATOR QUANTITY	MAX VOLTS	CONE AREA LIMIT	MUSIC AVERAGE/TONE	RULES
TRUNK 3K CLAMPED	2 AMPLIFIERS (STRAPPED)	TRUNK ONLY	UNLIMITED	YES	UNLIMITED	15.5V	UNLIMITED	TONE	TRUNK/STOCK
TRUNK UNLIMITED	UNLIMITED	TRUNK ONLY	UNLIMITED	YES	UNLIMITED	15.5V	UNLIMITED	TONE	TRUNK/STOCK

NO WALL DIVISION

NO WALL DIVISION uses the General rules with the following exceptions:

The power source may not produce more than 18.0 volts at any time during the run with or without the vehicle running.

An unlimited amount of “automotive type” sound deadener is allowed, but cannot be used as a wrap on the outside of a vehicle or as upholstery. Tapes, resins, spray foams, sound deadeners etc. should NOT be visible in the interior passenger compartment of the vehicle and cannot be used to seal vents, windows, interior panels or hold panels together in the interior passenger compartment of the vehicle.

Batteries and Alternators may be upgraded.

The OEM location battery may be relocated.

No subwoofers are allowed in front of the B-pillar.

No modifications will be allowed to the interior of the passenger compartment or cargo area of the vehicle, in order to facilitate the audio system. The floor, ceiling, dashboard and interior panels must be OEM and in place. Other than the audio equipment and the allowed modifications for the Division, the vehicle interior should appear to be stock.

All windows, doors and trunk or hatch openings must function as OEM and may not be permanently sealed

No modifications will be allowed to the exterior of the vehicle and all portions of the system must remain inside the vehicle with the exception of the audio controls (podium, external head unit etc.). . Vehicles utilizing external controls must have OE or aftermarket unit in OE location.

Inside the vehicle is defined as inside of the factory bodylines, roof, and floorboard. Equipment in or on trailers, hitch racks, luggage racks and so on will not be permitted. No portion of the enclosure or audio system will be permitted to be located outside of the vehicle.

External cosmetic modifications are allowed to the vehicle so long as they are cosmetic in nature and are not implemented to further SPL score, (i.e. shaved door handles, removed badging, body kits, removal of factory -optional accessories, etc.) All portions of the system must remain inside the factory bodylines, please refer to the Glossary of Terms for a better understanding of what USACi defines as “factory bodylines”. Equipment in or on trailers, hitch racks, luggage racks and so on will not be permitted. No portion of the enclosure or audio system will be permitted to be located outside of the vehicle, with the exception of external audio controls unless specified by the Division’s Exceptions.

Automotive type spray-on bedliner is permissible for use on exterior body panels as a substitute or alternative to paint.

Allowed Modifications:

Vehicles with sunroofs need not have them operable. They may be sealed, but may not have any exposed deadener and must be covered with OEM equivalent material.

Modifications will be allowed to the interior of the vehicle behind the B-pillar and up to 12 inches from the headliner of the vehicle at any point. Factory panels within 12” of the headliner must remain intact. Rear seat belts are only required if the corresponding seat is installed and secured in the vehicle during the run. Seat belt hardware including bolts and brackets MAY be installed in their original position in order to seal potential air leaks caused by seat belt removal.

The enclosure, or any device(s) affixed to the enclosure may NOT be within **12 inches of the headliner of the vehicle at any point** and may NOT be taller than 30 inches.

OEM interior panels may be upholstered or painted, but may not be modified or removed in any way but with these exceptions:

Custom consoles and door panels are allowed. Door panel build outs to add midrange speakers are allowed as long as the factory panels are used, no more than 50% of the OEM panel may be modified. All seats, windows, and doors must function. All window glass behind the B-Pillar must be OEM and in its original position, but may be permanently sealed as long as the method used employs urethane or silicone based compound and is not deemed overtly excessive by the judge.

Custom door panels must house at least one set of midrange speakers. Custom consoles cannot be oversized for the vehicle and must be used to accommodate the sound system. These modifications should serve a purpose in

appearance and functionality. Door panel build outs can't interfere with the door closing or operation of the vehicle and may only protrude 6" from the factory metal door skin. No pocketing will be allowed.

Automotive front seats that are commercially available may replace driver and passenger's seats. The seats must be OEM equivalent in size and shape, the sliders and brackets must be OEM equivalent and lap belts must be present forward of the B-pillar. The driver or passenger's seats may not be relocated from the factory mounting location.

No modifications will be allowed to the exterior of the vehicle and all portions of the system must remain inside the vehicle. Inside the vehicle is defined as inside of the factory bodylines, roof, and floorboard. Equipment in or on trailers, hitch racks, luggage racks and so on will not be permitted. No portion of the enclosure or audio system will be permitted to be located outside of the vehicle.

Pickup trucks with the rear of the cab and/or front of the bed cut out in order to allow speaker or box placement (blow through) in the truck bed will be allowed in this division. In these vehicles, the floor of the truck bed may not be lowered or cut. Wheel wells must be OEM.

CAMPER SHELLS, BED COVERS ETC. WILL BE ALLOWED. NO AUDIO EQUIPMENT WILL BE ALLOWED TO PROTRUDE ABOVE THE BED RAILS (A STRING TEST MAY BE PERFORMED)

NO WALL DIVISION

POWER CLASS	AMPLIFIER QUANTITY	ALLOWED INTERIOR MODS	BATTERY QUANTITY	ALLOWED SUPER CAPACITORS	ALTERNAT OR QUANTITY	MAX VOLTS	CONE AREA LIMIT	MUSIC AVERAGE / TONE	RULES
NO WALL 7K CLAMPED	2 AMPLIFIERS (STRAPPED)	BEHIND B PILLAR 12" BELOW Headliner	UNLIMITED	YES	UNLIMITED	18V	UNLIMITED	TONE	NO WALL
NO WALL 14K CLAMPED	2 AMPLIFIERS (STRAPPED)	BEHIND B PILLAR 12" BELOW Headliner	UNLIMITED	YES	UNLIMITED	18V	UNLIMITED	TONE	NO WALL
NO WALL UNLIMITED	UNLIMITED	BEHIND B PILLAR 12" BELOW Headliner	UNLIMITED	YES	UNLIMITED	18V	UNLIMITED	TONE	NO WALL

MODIFIED DIVISION

MODIFIED DIVISION uses the General rules with the following exceptions:

The power source may not produce more than 18.0 volts at any time during the run with or without the vehicle running. Modifications will be allowed to the interior of the vehicle behind the B-pillar, OEM interior panels may be upholstered or painted, but may not be modified or removed in any way but with these exceptions:

A single floor to ceiling brace (stripper pole) will be allowed, no more than 2" thick at any given point. The mounting plates can be no more than 4" wide and no more than ½" thick at any point. The front brace may extend all the way across the front windshield. If either the brace or plates affect the string test they must be removable.

Custom consoles and door panels are allowed. Door panel build outs to add midrange speakers are allowed as long as the factory panels are used, no more than **75%** of the OEM panel may be modified. All seats, windows, and doors must function. All window glass behind the B-Pillar must be OEM and in its original position, but may be permanently sealed as long as the method used employs urethane or silicone based compound and is not deemed overly excessive by the judge.

No modifications will be allowed to the exterior of the vehicle and all portions of the system must remain inside the **vehicle with the exception of the audio controls (podium, external head unit etc.)**. **Vehicles utilizing external controls must have OE or aftermarket unit in OE location.**

Inside the vehicle is defined as inside of the factory bodylines, roof, and floorboard. Equipment in or on trailers, hitch racks, luggage racks and so on will not be permitted. No portion of the enclosure or audio system will be permitted to be located outside of the vehicle.

HVAC air handling units (air box) & mounting hardware may be removed, BUT connecting devices may not (duct-work, harnesses, etc.). Any openings exposed as a result of this removal must be sealed using some sort of conventional and customary means (like-gauge metal, plastic or metal plating, etc.)

Custom door panels must house at least one set of midrange speakers. Custom consoles cannot be oversized for the vehicle and must be used to accommodate the sound system. These modifications should serve a purpose in appearance and functionality. Door panel build outs can't interfere with the door closing or operation of the vehicle and may only protrude 6" from the factory metal door skin. No pocketing will be allowed.

Automotive front seats that are commercially available may replace driver and passenger's seats. The front seats must be OEM equivalent in size and shape, the sliders and brackets must be in the factory location and OEM equivalent. Lap belts must be present forward of the B-pillar. Example: The OEM equivalent brackets and swivel racing seats will be allowed.

A maximum of two layers of OEM or equivalent DOT approved windshields will be allowed. The windshield(s) must be clear and have DOT etching. Materials such as Lexan, Plexiglas, polycarbonate, etc. will NOT be allowed. The windshield must use the factory mounting location and cannot protrude past the OEM mounting location bodyline.

"Walk-through" setups are allowed so long as a commercially available camper shell specific to the vehicle is utilized. Camper shells may not extend vertically higher than the vehicle roof by more than 7 inches. The means by which the bed and camper shell are joined to the cab of the vehicle must be customary and typical in nature, and in no manner may the method of joining and sealing together these sections exceed outward past the vehicle body lines in any direction. The Highest point of the bed-mounted audio system must not exceed vertically higher than the vehicle roof for any reason.

In Modified Division, the floor of the vehicle behind the B-Pillar may be lowered as far downward as the pinch-weld of the vehicle, but no lower.

MODIFIED DIVISION

POWER CLASS	AMPLIFIER QUANTITY	ALLOWED INTERIOR MODS	BATTERY QUANTITY	ALLOWED SUPER CAPACITORS	ALTERNATOR QUANTITY	MAX VOLTS	CONE AREA LIMIT	MUSIC AVERAGE / TONE	RULES
MOD 10K CLAMPED	2 AMPLIFIERS (STRAPPED)	BEHIND B PILLAR	UNLIMITED	YES	UNLIMITED	18V	UNLIMITED	TONE	MODIFIED
MOD 20K CLAMPED	2 AMPLIFIERS (STRAPPED)	BEHIND B PILLAR	UNLIMITED	YES	UNLIMITED	18V	UNLIMITED	TONE	MODIFIED
MOD UNLIMITED	UNLIMITED	BEHIND B PILLAR	UNLIMITED	YES	UNLIMITED	18V	UNLIMITED	TONE	MODIFIED

STREET BEAT DIVISION

You will find the Cone Area Reference Chart on Page 22, to determine the subwoofer cone area for this Division.

All Street Beat competitors will be required to use the official USACI Street Beat music for this division.

Scores will be determined by an average SPL taken over 30 SECONDS.

The Sensor placement will be any place in front of the B- pillar with globe affixed or mounted to windshield without globe at 12" to the left of passenger's side A-pillar and 4" above the dash. (Competitor's choice)

A competitor may only compete in 1 Street Beat Class per Event.

Audible highs/midrange music must be able to be heard from outside the vehicle.

***Rule Reference page numbers are listed in the matrix below.**

STREET BEAT DIVISION

POWER CLASS	AMPLIFIER QUANTITY	ALLOWED INTERIOR MODIFICATIONS	BATTERY QUANTITY	ALLOWED SUPER CAPACITORS	ALTERNATOR QUANTITY	MAX VOLTS	CONE AREA LIMIT	MUSIC AVERAGE/TONE	RULES
STREET BEAT 1	UNLIMITED	NONE	UNLIMITED	YES	UNLIMITED	15.5V	354 SQ. IN. MAX	30 SEC. MUSIC AVERAGE	STOCK (*Page 17)
STREET BEAT 2	UNLIMITED	BEHIND B PILLAR BELOW 12" FROM Headliner	UNLIMITED	YES	UNLIMITED	18V	707 SQ. IN. MAX	30 SEC. MUSIC AVERAGE	NO WALL (*Page 19)
STREET BEAT 3	UNLIMITED	BEHIND B PILLAR	UNLIMITED	YES	UNLIMITED	18V	1060 SQ. IN. MAX	30 SEC. MUSIC AVERAGE	MODIFIED (*Page 20)
STREET BEAT 4	UNLIMITED	BEHIND B PILLAR	UNLIMITED	YES	UNLIMITED	18V	UNLIMITED	30 SEC. MUSIC AVERAGE	MODIFIED (*Page 20)
STREET BEAT 5	UNLIMITED	EXTREME RULES	UNLIMITED	YES	UNLIMITED	18V	UNLIMITED	30 SEC. MUSIC AVERAGE	XTREME

Subwoofer Cone Area (Round)								
Woofer Size	6.5	8	10	12	13	15	18	21
Woofer Quantity	TOTAL SQUARE INCHES							
1	33.17	50.00	78.50	113.00	132.67	176.63	254.34	346.34
2	66.33	100.00	157.00	226.00	265.33	353.25	508.68	692.68
3	99.50	150.00	235.50	339.00	398.00	529.88	763.02	1,038.51
4	132.67	200.00	314.00	452.00	530.66	706.50	1,017.36	1,384.74
5	165.83	250.00	392.50	565.00	663.33	883.13	1,271.70	1,730.92
6	199.00	300.00	471.00	678.00	795.99	1,059.75	1,526.04	2,077.74
7	232.16	350.00	549.50	791.00	928.66	1,236.38	1,780.38	2,423.52
8	265.33	400.00	628.00	904.00	1,061.32	1,413.00	2,034.72	2,769.44
9	298.50	450.00	706.50	1,017.00	1,193.99	1,589.63	2,289.06	3,115.62
10	331.66	500.00	785.00	1,130.00	1,326.65	1,766.25	2,543.40	3,461.80
11	364.83	550.00	863.50	1,243.00	1,459.32	1,942.88	2,797.74	3,808.02
12	398.00	600.00	942.00	1,356.00	1,591.98	2,119.50	3,052.08	4,154.24
13	431.16	650.00	1,020.50	1,469.00	1,724.65	2,296.13	3,306.42	4,500.42
14	464.33	700.00	1,099.00	1,582.00	1,857.31	2,472.75	3,560.76	4,846.56
15	497.49	750.00	1,177.50	1,695.00	1,989.98	2,649.38	3,815.10	5,192.74
16	530.66	800.00	1,256.00	1,808.00	2,122.64	2,826.00	4,069.44	5,538.92
17	563.83	850.00	1,334.50	1,921.00	2,255.31	3,002.63	4,323.78	5,885.10
18	596.99	900.00	1,413.00	2,034.00	2,387.97	3,179.25	4,578.12	6,231.24

StreetBeat 1 StreetBeat 2 StreetBeat 3

Subwoofer Cone Area (Square)					
Woofer Size	8	10	12	15	18
Woofer Quantity	TOTAL SQUARE INCHES				
1	64.00	100.00	144.00	225.00	324.00
2	128.00	200.00	288.00	450.00	648.00
3	192.00	300.00	432.00	675.00	972.00
4	256.00	400.00	576.00	900.00	1,296.00
5	320.00	500.00	720.00	1,125.00	1,620.00
6	384.00	600.00	864.00	1,350.00	1,944.00
7	448.00	700.00	1,008.00	1,575.00	2,268.00
8	512.00	800.00	1,152.00	1,800.00	2,592.00
9	576.00	900.00	1,296.00	2,025.00	2,916.00
10	640.00	1,000.00	1,440.00	2,250.00	3,240.00
11	704.00	1,100.00	1,584.00	2,475.00	3,564.00
12	768.00	1,200.00	1,728.00	2,700.00	3,888.00

BASS BATTLES DIVISION

The competitor may choose their own music. There will be no solid tones & note must change. The Judge will verify compliance with this rule. If a run is deemed illegal due to a tone violation, a score of zero will be applied to the run and the competitor will be allowed their 2nd attempt, but must choose a different music track.

Audible highs/midrange music must be able to be heard from outside the vehicle.

Scoring for Bass Battles

We will take your *peak SPL score's frequency according to Term Lab, as well as your SPL score during a one minute music average run*, you will receive bonus points based on a 80hz cap limit which will add up to a Composite SPL Score. If your average SPL score is 150db @ 30 Hz you will get 50 points, 150 @ 20 HZ you would get 60 points, 150 @ 40 HZ = 40 points and so on.

The bottom frequency cap is 20Hz, if you peak at 19 Hz you will still only be allowed the max of 60 bonus points

***Exception in Bass Battles No Wall ONLY: Stripper pole may be no more than 1 ½" inches in diameter and mounting bracket may be no more than 2" and must be behind the B pillar.**

BASS BATTLES DIVISION

POWER CLASS	AMPLIFIER QUANTITY	ALLOWED INTERIOR MODIFICATIONS	BATTERY QUANTITY	ALLOWED SUPER CAPACITORS	ALTERNAT OR QUANTITY	MAX VOLTS	CONE AREA LIMIT	MUSIC AVERAGE/ TONE	RULES
BASS BATTLES NO WALL	UNLIMITED	BEHIND B PILLAR 12" RULE	UNLIMITED	YES	UNLIMITED	18V	UNLIMITED	1 MIN. MUSIC AVERAGE	NO WALL (*Page 19)
BASS BATTLES MODIFIED	UNLIMITED	BEHIND B PILLAR	UNLIMITED	YES	UNLIMITED	18V	UNLIMITED	1 MIN. MUSIC AVERAGE	MODIFIED (*Page 20)
BASS BATTLES EXTREME	UNLIMITED	UNLIMITED	UNLIMITED	YES	UNLIMITED	18V	UNLIMITED	1 MIN. MUSIC AVERAGE	XTREME (*Page 25-28)

XTREME DIVISION

EXTREME DIVISION uses the General rules with the following exceptions:

(Many of the following rules and drawings are courtesy of Wayne Harris and DBDRA. USACI would like to thank Mr. Harris for his generosity in allowing us to utilize these guidelines for the cabin measurements.)

A spotter must be present to assist the driver at any time the vehicle is moving. The

power source may not produce more than 18.0 volts with the vehicle running.

Competitors will NOT be allowed in any vehicle under test over 165db in the Extreme division.

Modifications will be allowed to the interior of the passenger compartment. The floor, ceiling and dashboard may be modified. Ceilings may be lowered and floors may be raised.

Extreme competitors may install "bolt tabs" or a "bolt strip" (for securing the doors) along the perimeter of the door openings provided the maximum width of each tab or strip is less than 2 inches (5.08 cm). If a bolt tab or bolt strip is attached to the B-Pillar, it must be easily removable if a "string test" is needed.

Modifications to the exterior of the vehicle to accommodate the sound system are allowed, however **no cosmetic remedies made to the exterior of the vehicle may be outside customary and traditional standards.** Battery boxes located underneath the vehicle are acceptable.

No seats are required.

The factory windshield and side glass may be replaced. There must be at least one 8.5" x 11" unobstructed view port directly in front of the steering wheel. There must be two view ports to allow an unobstructed view of the SPL sensor during testing. These view ports must be located on opposite sides of the vehicle and behind the A-pillar and measure a minimum of 8.5" x 11" on each side. The microphone/sensor may be placed anywhere forward of the B-pillar within the following guidelines.

The microphone/sensor may be placed in a foot well or other microphone/sensor specific location only if the location and entrance to said location is below dash level. The location may be no more than 10 inches deep and no less than 13 inches in height and width. If the microphone/sensor is to be placed above dash level, it may only be placed on the windshield, 12 inches from the passenger side A-pillar, 4 inches from the top of the dash, and one inch from the windshield. **Competitors who have replaced the passenger side windows with Plexiglas or another similar material must provide a 1-inch diameter hole through a transparent area of the material for the measurement sensor cable if routing cable through passenger door or ran sealed/legal.**

A dash will be required in every competition vehicle.

The highest point of the top of the dash may not extend above the horizontal plane determined by the base of the windshield.

The lowest point of the top of the dash may not be located any lower than 3 inches below the horizontal plane determined by the base of the windshield.

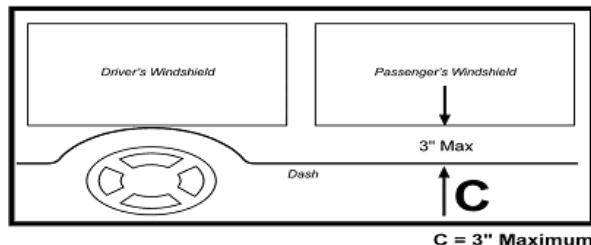

The minimum depth of the dash at the center of the vehicle is 6 inches when measured from the edge of the dash to the windshield. The maximum depth shall be 16 inches

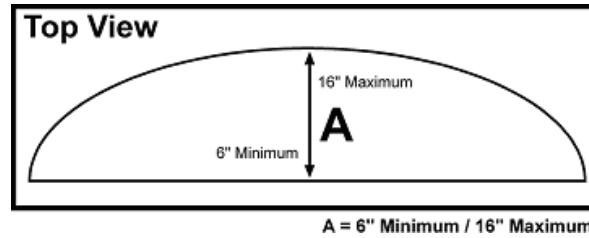

The plane of the dash bounded in the front by the firewall, in the back by the trailing edge of the dash, and for a distance of 12 inches to the left and 12 inches to the right (measured horizontally) of the sensor placement location must be completely flat with respect to the ground.

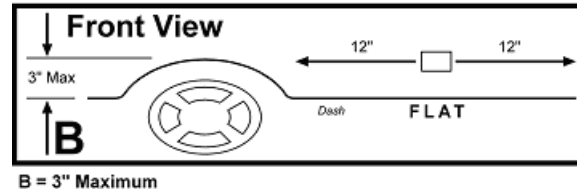

The dash may be completely solid (with no holes or perforations) and must extend front-to-back from the firewall to the trailing edge of the dash, and side-to-side from the windshield pillar on the driver's side to the windshield pillar on the passenger side.

The trailing edge of the dash (the edge of the dash that faces the passenger compartment) must be straight and perpendicular to the centerline of the vehicle when viewed from the top.

The center console may not exceed the height of the lowest part of the top of the dash.

A minimum "open space" distance of 13 inches (33.02 cm) MUST be provided at ALL points between each side of the center console and each door. (Measured horizontally and perpendicular to the centerline of the vehicle.)

The removal of the center console is no longer required when performing the "String Test" unless the head judge determines removal is necessary to verify compliance with the test.

If no center console is present, then the 13 inches (33.02 cm) closest to each door will be treated as the open space area.

Competitors MAY construct a roof build-down if desired.

Additional Guidelines: The build-down may not extend more than 3 inches (7.62 cm) below the top of the doorjamb.

For those locations in front of the door (between the door and the windshield) and behind the door (between the door and the baffle board), the roof build-down may not extend more than 3 inches (7.62 cm) below the lowest part of the top of the doorjamb. For doors with curved door openings, the reference point shall be defined as the intersection between two imaginary lines.

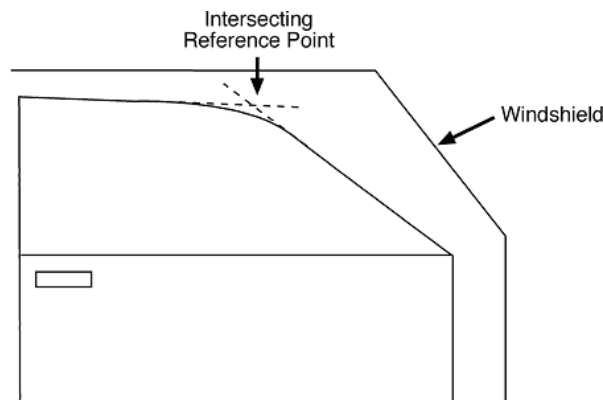

Competitors MAY construct floor build-ups.

Competitors MAY construct a removable or flip-down panel(s) to cover the OEM foot wells.

Additional Guidelines: In the interest of safety, competitors are encouraged not to modify the vehicle's OEM foot pedals (accelerator pedal, brake pedal, clutch, and parking brake).

Competitors MUST maintain a minimum 30-inch (76.2 cm) vertical separation between the headliner (roof build-down) and the floor (floor build-up) at ALL locations within the passenger compartment except over the center console and the dash.

Additional Guidelines: A 30-inch rod will be used to determine compliance. The judge will hold the rod vertically and move it around inside of the passenger compartment. If the rod's movement is impeded, then the vehicle fails compliance with this rule. Bracing located outside of the "open space" area shall not constitute an impediment to this test.

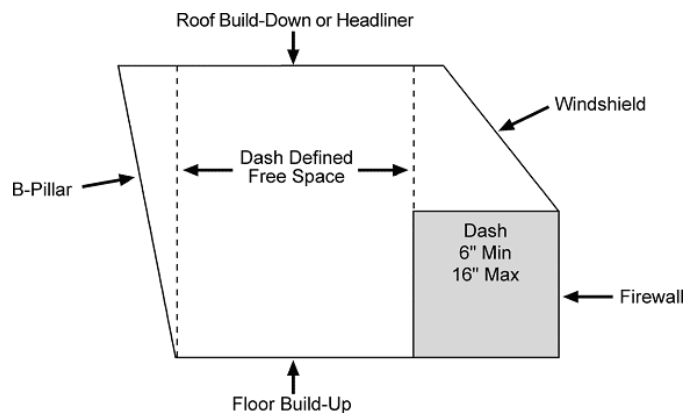

In the above example, the top trailing edge of the dash defines the vertical plane that is used to establish the front-to-back Free Space area. (Note how the dash is NOT located completely beneath the OEM windshield location.) Not to Scale.

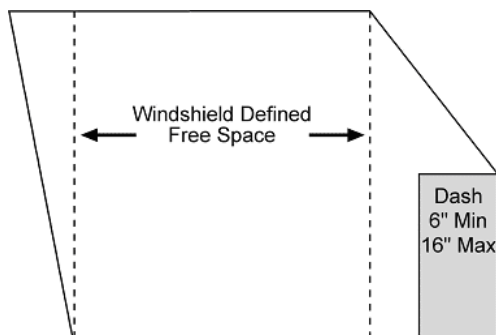

In the above example, the OEM top windshield frame defines the vertical plane that is used to establish the front-to-back Free Space area. (Note how the dash is located completely beneath the OEM windshield location.) Not to Scale.

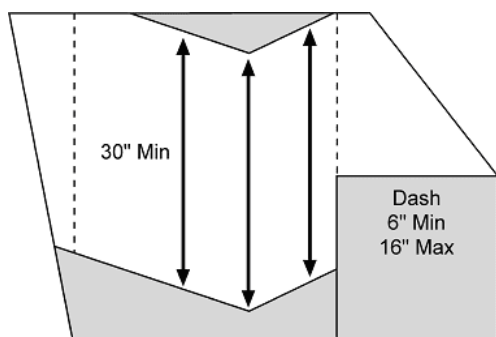

In the above example, the top trailing edge of the dash defines the vertical plane that is used to establish the front-to-back Free Space area. This example also depicts how changes to the roof build-down and floor build-up can be made provided a minimum al distance of 30 inches is maintained. Not to Scale.

Competitors MAY build-out their door panels if desired.

Additional Guidelines The maximum distance the build-out may extend into the passenger compartment is 6 inches). (Measured from the sheet metal of the door where the OEM door panel was originally attached.)

Cavities in doors are prohibited. (A cavity is a negative build-out that protrudes into the door's interior space.)

Competitors MAY install bracing if desired.

Additional Guidelines and Examples: The maximum aggregate width for all bracing in front of the B-Pillars is 6 inches. (To determine compliance with this guideline, find the widest point on each of your braces. Next, add these maximum widths together. The total value must be 6 inches or less.)

If the brace "Y's" into 2 or more arms, then the width of the brace shall be considered as either the sum of the widest point on each arm, or the maximum width of the single "leg", whichever is larger.

Example: A competitor is using a single 4" x 4" brace from the roof to the floor. The widest dimension of the brace is 4 inches, so the competitor is in compliance.

EXTREME DIVISION

POWER CLASS	AMPLIFIER QUANTITY	ALLOWED INTERIOR MODIFICATIONS	BATTERY QUANTITY	ALLOWED SUPER CAPACITORS	ALTERNATOR QUANTITY	MAX VOLTS	CONE AREA LIMIT	MUSIC AVERAGE/TONE	RULES
EXTREME	UNLIMITED	UNLIMITED	UNLIMITED	YES	UNLIMITED	18V	UNLIMITED	TONE	EXTREME

2022 USACI CLASS MATRIX

POWER CLASS	AMPLIFIER QUANTITY	ALLOWED INTERIOR MODIFICATIONS	BATTERY QUANTITY	ALLOWED SUPER CAPACITORS	ALTERNATOR QUANTITY	MAX VOLTS	CONE AREA LIMIT	MUSIC AVERAGE/TONE	RULES
STREET BEAT DIVISION									
STREET BEAT 1	UNLIMITED	NONE	UNLIMITED	YES	UNLIMITED	15.5V	354 SQ. IN. MAX	30 SEC. MUSIC AVERAGE	STOCK
STREET BEAT 2	UNLIMITED	BEHIND B PILLAR 12" RULE	UNLIMITED	YES	UNLIMITED	18V	707 SQ. IN. MAX	30 SEC. MUSIC AVERAGE	NO WALL
STREET BEAT 3	UNLIMITED	BEHIND B PILLAR	UNLIMITED	YES	UNLIMITED	18V	1060 SQ. IN. MAX	30 SEC. MUSIC AVERAGE	MODIFIED
STREET BEAT 4	UNLIMITED	BEHIND B PILLAR	UNLIMITED	YES	UNLIMITED	18V	UNLIMITED	30 SEC. MUSIC AVERAGE	MODIFIED
STREET BEAT 5	UNLIMITED	EXTREME	UNLIMITED	YES	UNLIMITED		UNLIMITED	30 SEC. MUSIC AVERAGE	EXTREME
HIGH & HARD/ LOW & LOUD DIVISION									
H&H NO WALL	UNLIMITED	BEHIND B PILLAR 12" RULE	UNLIMITED	YES	UNLIMITED	18V	UNLIMITED	TONE	NO WALL
H&H WALL	UNLIMITED	UNLIMITED	UNLIMITED	YES	UNLIMITED	18V	UNLIMITED	TONE	XTREME
L&L NO WALL	UNLIMITED	BEHIND B PILLAR 12" RULE	UNLIMITED	YES	UNLIMITED	18V	UNLIMITED	TONE	NO WALL
L&L WALL	UNLIMITED	UNLIMITED	UNLIMITED	YES	UNLIMITED	18V	UNLIMITED	TONE	XTREME
STOCK DIVISION									
STOCK 1K CLAMPED	2 AMPLIFIERS STRAPPED	NONE	UNLIMITED	YES	UNLIMITED	15.5V	UNLIMITED	TONE	STOCK
STOCK 3K CLAMPED	2 AMPLIFIERS STRAPPED	NONE	UNLIMITED	YES	UNLIMITED	15.5V	UNLIMITED	TONE	STOCK
STOCK 6K CLAMPED	2 AMPLIFIERS STRAPPED	NONE	UNLIMITED	YES	UNLIMITED	15.5V	UNLIMITED	TONE	STOCK
STOCK UNLIMITED	UNLIMITED	NONE	UNLIMITED	YES	UNLIMITED	15.5V	UNLIMITED	TONE	STOCK
NO WALL DIVISION									
NO WALL 7K CLAMPED	2 AMPLIFIERS STRAPPED	BEHIND B PILLAR 12" RULE	UNLIMITED	YES	UNLIMITED	18V	UNLIMITED	TONE	NO WALL
NO WALL 14K CLAMPED	2 AMPLIFIERS STRAPPED	BEHIND B PILLAR 12" RULE	UNLIMITED	YES	UNLIMITED	18V	UNLIMITED	TONE	NO WALL
NO WALL UNLIMITED	UNLIMITED	BEHIND B PILLAR 12" RULE	UNLIMITED	YES	UNLIMITED	18V	UNLIMITED	TONE	NO WALL

POWER CLASS	AMPLIFIER QUANTITY	ALLOWED INTERIOR MODIFICATIONS	BATTERY QUANTITY	ALLOWED SUPER CAPACITORS	ALTERNATOR QUANTITY	MAX VOLTS	CONE AREA LIMIT	MUSIC AVERAGE/ TONE	RULES
TRUNK DIVISION									
TRUNK 3K CLAMPED	2 AMPLIFIERS STRAPPED	TRUNK ONLY	UNLIMITED	YES	UNLIMITED	15.5V	UNLIMITED	TONE	TRUNK/ STOCK
TRUNK UNLIMITED	UNLIMITED	TRUNK ONLY	UNLIMITED	YES	UNLIMITED	15.5V	UNLIMITED	TONE	TRUNK/ STOCK
MODIFIED DIVISION									
MODIFIED 10K CLAMPED	2 AMPLIFIERS STRAPPED	BEHIND B PILLAR	UNLIMITED	YES	UNLIMITED	18V	UNLIMITED	TONE	MODIFIED
MODIFIED 20K CLAMPED	2 AMPLIFIERS STRAPPED	BEHIND B PILLAR	UNLIMITED	YES	UNLIMITED	18V	UNLIMITED	TONE	MODIFIED
MODIFIED UNLIMITED	UNLIMITED	BEHIND B PILLAR	UNLIMITED	YES	UNLIMITED	18V	UNLIMITED	TONE	MODIFIED
EXTREME DIVISION									
EXTREME	UNLIMITED	UNLIMITED	UNLIMITED	YES	UNLIMITED	18V	UNLIMITED	TONE	EXTREME
PORT WARS DIVISION									
PORT WARS	UNLIMITED	UNLIMITED	UNLIMITED	YES	UNLIMITED	18V	UNLIMITED	TONE	PORT WARS
BASS BATTLES DIVISION									
BASS BATTLES NO WALL	UNLIMITED	BEHIND B PILLAR 12" RULE	UNLIMITED	YES	UNLIMITED	18V	UNLIMITED	1 MIN. MUSIC AVERAGE	NO WALL
BASS BATTLES MODIFIED	UNLIMITED	BEHIND B PILLAR	UNLIMITED	YES	UNLIMITED	18V	UNLIMITED	1 MIN. MUSIC AVERAGE	MODIFIED
BASS BATTLES EXTREME	UNLIMITED	UNLIMITED	UNLIMITED	YES	UNLIMITED	18V	UNLIMITED	1 MIN. MUSIC AVERAGE	EXTREME

EXPLANATION OF HOW USACi WORLD FINALS WORKS:

You may pre-register online for World Finals at <http://www.usaciworldwide.org> once it is open to do so.

By Pre-Registering, the competitor will receive a discount, however the competitor may also register the Friday or Saturday at the World Finals Event until 4:00 PM or until time slots are full.

We will verify your points in classes you choose to register in. As long as you DO NOT get an email you are pre-registered and we will see you at Finals. If you get an email please email back as soon as possible with information we have requested so your pre-registration will be accepted.

TO CHECK YOUR POINTS GO TO TERMPRO.COM then click USACi then click Competitor Stats - Type your first and last name then search - click your name - then on left click USACi Stats then at the bottom of the page it will tell you your total points for the current Season along with points in each class you entered during the calendar year

We do offer a mileage curve and show attendance % qualification for those who do not acquire enough points due to lack of events in their area. Rules and information for that are located above in the rulebook. (Please review Page 11)

You will check in at Finals on Friday or early Saturday morning to pick your timeslots. (This is a 1st come 1st served basis)

ALL World Finals Registration will close either at 4:00 pm on Saturday or when ALL TIME SLOTS ARE FULL, whichever comes first. (People that Pre Register will have a time slot available.)

If you are UNABLE to complete your initial run on Saturday you will receive a score of zero and must pay for a re-run for Sunday, if any are available to purchase. (Please read below)

Qualifying Runs will be on Saturday, if you have not been given a time slot for that day or turned in your entry form in the lanes you will not be permitted to Rerun on Sunday.

* SPL Entries can be purchased at the event but you must do so before 4:00 pm on Saturday or Time Slots are FULL, whichever comes first.

* Re-Runs will work the same way for Sunday. (If there are no time slots left then re-run registration will close)

* 3X Event & Demo passes can be purchased at the World Finals Event.

* Sound Quality MUST Pre-Register Online to Enter; we will NOT take any new registrations at the Event.

OTHER RULES (Per Venue):

You may not run your vehicle in the building unless you are in the lanes ready to run your class.

All Demo vehicles must be in the demo arena, no demoing will be allowed in the SPL portion building.

If you do not have a wristband you will be asked to leave the venue. Wristbands are available at the registration desk.

No vulgarity or profanity will be tolerated whether it is a song being played or a person that might be upset. If you have a problem please find a staff member to help you. If you need further assistance please go to the registration desk so they can point you to the correct people to help you.

Glossary of Terms

OEM: This refers to the original equipment produced and installed by the original manufacturer of any given vehicle. Items such as door panels, carpet, external accessories, internal accessories, upholstered treatments, bolt patterns etc.

B-Pillar: The forward-most leading edge of the B-Pillar is the reference point for this standard. In classes where applicable, this point of the B-Pillar is the point where equipment may not protrude past going forward. The only caveat to this standard is in the case of a vehicle B-Pillar structure that leans backward going upward. This is very common in most passenger vehicles and light trucks / vans. If the bottom of the B-Pillar is forward of the top of the B-Pillar, so may be the audio system apparatus (enclosure, subwoofers, amplifiers, etc.)

Roof: The roof of a vehicle is defined as the lowest point of the ceiling of the subject vehicle interior, and is limited to upholstered coverings, i.e. headliner, as well as any horizontally affixed trim panels. The exception to this definition applies to any trim panels affixed to or retaining the headliner that extend straight downward more than four (4) inches.

Run: The competitor's designated opportunity to officially test their vehicle in the competition lanes. Competitors are allowed to test their vehicle, remedy for 3 minutes, and resume testing with a secondary opportunity to retest.

Re-Run: An additional competitor-paid opportunity to re-test their vehicle a SINGLE time after their ORIGINAL competitor-paid Run.

Rear Deck: In vehicles with trunks, the rear deck is defined as the vehicle structure joining the rear window lower core support to the rear seat structure, effectively providing necessary bracing for the rear of the vehicle chassis, as well as a solid separation between the trunk compartment and the vehicle cabin, commonly used to facilitate installation of OEM lighting, audio, etc. The term "rear deck" applies to not only the metal structure itself, but also the OEM rear deck upholstered coverings, and any OEM trim panels mounted directly to it, as well as other OEM fixturing such as third brake lamp assemblies.

Head Judge: The USACi Staff member assigned to facilitate the competition event, operate the Term-Lab software, open and close the competition lane(s), make final decisions, assign official competitor event placement, and award distribution.

Verification Judge: The USACi Staff member assigned to ensuring all competitor vehicles are safe to compete, adhere to USACi vehicle compliance guidelines, proper class placement, proper amplifier clamping procedures, proper mic/sensor placement, and overall safety and efficiency in the competition lane(s).

Build-Up: The practice of intentionally adhering or affixing ANY material to the interior ceiling, interior floor, interior fire-wall or interior door panels of a competition vehicle solely for the purposes of decreasing the net volume of the cabin space to provide for a potentially increased SPL score. Example: 2 Layers of automotive type sound deadener applied to the floor of a vehicle is acceptable, but 47 layers of the same material would be considered a build-up.

Window Line: This term applies to the point where any referenced outward facing window glass meets an interior OEM trim panel at the subject window's bottom horizontal edge.

Pocketing: This term refers to the intentional modification of interior cabin structure in order to partially encapsulate the area where the mic/sensor is placed for SPL testing with the sole intention of manipulating air flow to increase SPL score.

String Test: A method of verification used by a Head Judge or Verification Judge where any manner of string is used to verify any unacceptable protrusion past certain lateral point. Examples include instances where a lengthy section of string will be affixed to a beginning and end point of a set boundary and drug across said boundary to determine whether any item or items protrude past that point, which will be obvious if said items interfere with the passage of the string used.

Pinch-Weld: As measured between both tires on the same side of the vehicle, the "pinch" is defined as the OEM union of the body to the undercarriage of the vehicle; a horizontal imaginary line denoted by the front to rear linear run of the factory welded union between the body and undercarriage of the vehicle.