

2-Stud **WARM** Corners

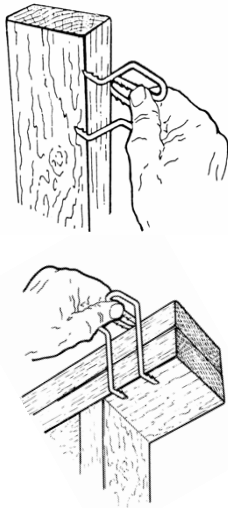

Stud Claw



Backer Springs replace the third stud that obstructs insulation and can create a cold shaft in every corner. The extra studs were never used before drywall and have been proven by (HUD-55) to add nothing to the structural value of the building.

The unnecessary framing simply adds a lot of extra cost to both builders and framing contractors.

Modern 2-Stud 'Floating' Corners will also prevent drywall cracks, mold and mildew problems.

This 'Advanced Framing' technique has been proven in the new Building America Initiative, a nation wide demo program sponsored by the Department of Energy and the new National Renewable Energy Laboratory directed by the Building Science Consortium.

This modern (2-Stud) framing method is recommended and specified by every authority and code in the building trade.



(716) 662-7877

1/2 **HALF** the installed **COST** of any other **BACKERS**

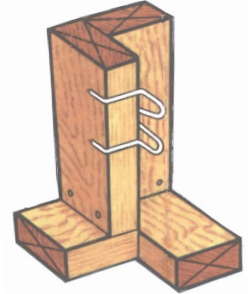

Stud Claw™

- The Framers Friend
- The Drywallers Godsend

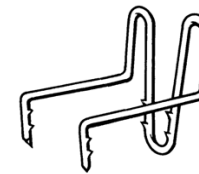

1 1/2" CORNER BACKER

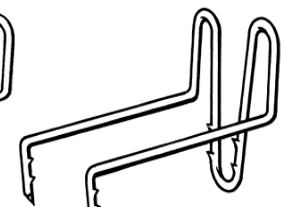

3" CEILING BACKER

Drywall Backer Springs

Sharp Talons grip the wood framing and lock on without nails, tools or skilled labor.

They eliminate many corner studs and deadwood ceiling backing and install at **half the cost** of any other backers.

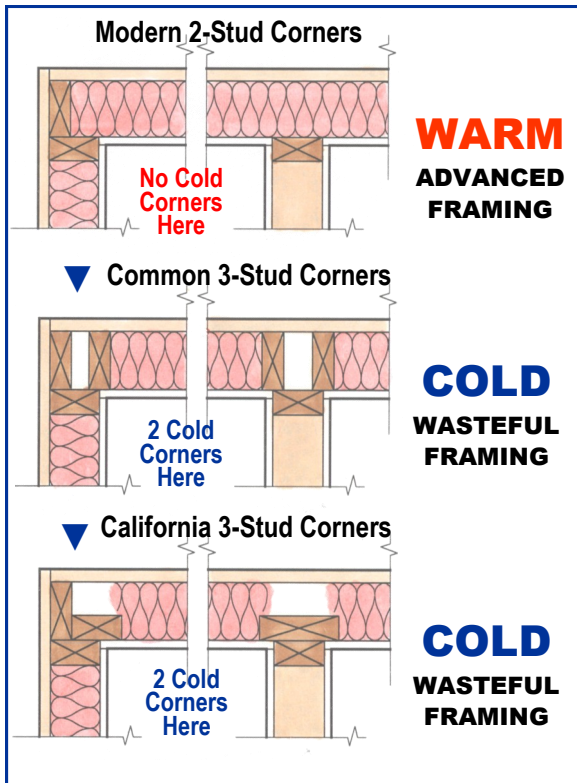



Stud Claw™

Drywall Backer Springs



Sharp talons grip the framing.

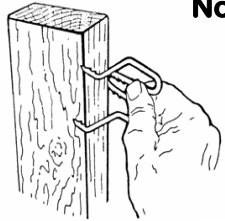

 **2 Hr. Fire Rated**
Warnock Hersey International

1/2 HALF the Installed COST of any other BACKERS!

A box of Backer Springs will save a ton of lumber and labor in every house.

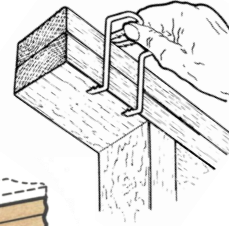

No Deadwood Backing

Save a Stud

No Cold Corner

Save 2 Studs

Save a Stud

Modern Building Codes call for 2-Stud Corners.

GOOD FOR THE HOME BUILDER

GOOD FOR THE HOME OWNER

GOOD FOR THE ENVIRONMENT

GREAT FOR THE FRAMERS AND DRYWALLERS

MADE IN USA

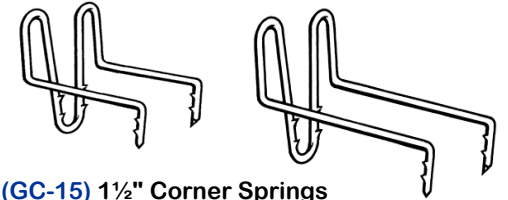

(GC-15) 1 1/2" Corner Springs
(GC-30) 3" Ceiling Springs

Stud Claw hardware requires no nails, tools or skilled labor. They are the fastest installing drywall backers, by half.

Backer Springs install (Approx. 16" O.C)

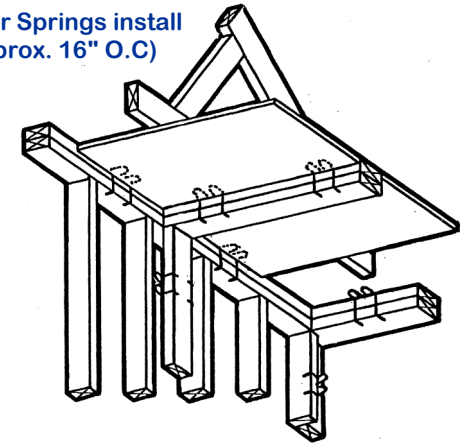

2-Stud Corners with Drywall Backer Clips are recommended and specified by every modern building code.

The Advanced Method will:

- (1) Save a lot of framing lumber.
- (2) Permit full corner insulation.
- (3) Reduce drywall corner cracks.