



DIRAC LIVE

USER MANUAL

FOR DIRAC LIVE-ENABLED MINIDSP PROCESSORS

STEREO PLATFORMS

SHD SERIES

DDRC-24

DDRC-22D

MINIDSP FLEX

MULTICHANNEL PLATFORMS

DDRC-88A, DDRC-88D

C-DSP 8x12 DL, HARMONY DSP 8x12

SUPPORTED OS

 **Windows 10** or later

 **macOS Mojave** or later



Revision history

Revision	Description	Date
0.1	Standalone Dirac Live manual for miniDSP	5 June 2020
1.0	Minor updates for official release	23 June 2020
1.0a	Minor corrections	30 June 2020
1.1	Added trouble-shooting section	13 July 2020
1.2	Minor trouble-shooting updates	17 October 2020
1.3	Add Harmony DSP 8x12, updates for Dirac Live	17 December 2020
1.4	Adobe AIR and Flash no longer needed	1 February 2021
1.5	Minor update to system requirements, added Flex	29 November 2021



IMPORTANT INFORMATION

Please read the following information before use. In case of any questions, please contact miniDSP via the support portal at support.minidsp.com.

System Requirements

To configure the miniDSP audio processor, you will require a Windows PC or Apple Mac computer with the following minimum specification:

Windows

- **Microsoft® Windows® 10 or 11**, latest version with all updates
- At least a dual core i3, i5, or i7 processor
- At least 2 GB RAM (4 GB preferred)
- Two free USB 2.0 ports
- Internet connection

macOS

- **macOS 10.14 Mojave or later**, latest version with all updates
- At least a dual core i3, i5, or i7 processor, or an ARM processor (M1/Pro/Max)
- At least 2 GB RAM (4 GB preferred)
- Two free USB 2.0 ports
- Internet connection

Disclaimer/Warning

miniDSP cannot be held responsible for any damage that may result from the improper use of this product or incorrect configuration of its settings. As with any other product, we recommend that you carefully read this manual and other technical notes to ensure that you fully understand how to operate this product. The miniDSP audio processor is a powerful tool, and misuse or misconfiguration, such as incorrectly set gains or excessive boost, can produce signals that may damage your audio system.

As a general guideline, you should perform the initial configuration of the miniDSP audio processor before enabling audio through any connected output device or amplification. Doing so will help ensure that the software is correctly configured.

Finally, note that the miniDSP audio processor is a very flexible device, and many of the questions we receive at the tech support department are already answered in this user manual and in the online [application notes](#) on the miniDSP.com website. So please take the time to carefully read this user manual and the online technical support. Thanks for your understanding!

Warranty Terms

miniDSP Ltd warrants this product to be free from defects in materials and workmanship for a period of one year from the invoice date. Our warranty does not cover failure of the product due to incorrect connection or installation, improper or undocumented use, unauthorized servicing, modification or alteration of the unit in any way, or any usage outside of that recommended in this manual. If in doubt, contact miniDSP prior to use.

FCC Class B Statement

This device complies with Part 15 of the FCC Rules. Operation is subject to the following two conditions:

- This device may not cause harmful interference.
- This device must accept any interference received, including interference that may cause undesired operation.

Warning: This equipment has been tested and found to comply with the limits for a Class B digital device, pursuant to Part 15 of the FCC Rules. These limits are designed to provide reasonable protection. This equipment generates, uses and can radiate radio frequency energy and, if not installed and used in accordance with the instructions, may cause interference to radio communications. However, there is no guarantee that interference will not occur in a particular installation. If this equipment does cause harmful interference to radio or television reception, which can be determined by turning the equipment off and on, the user is encouraged to try to correct the interference by one or more of the following measures:

- Reorient or relocate the receiving antenna.
- Increase the separation between the equipment and receiver.
- Connect the equipment into an outlet on a circuit different from that to which the receiver is connected.
- Consult the dealer or an experienced radio/TV technician for help.

Notice: Shielded interface cable must be used in order to comply with emission limits.

Notice: Changes or modification not expressly approved by the party responsible for compliance could void the user's authority to operate the equipment.

CE Mark Statement

The miniDSP processor has passed the test performed according to European Standard EN 55022 Class B.

A note on this manual

This User Manual is designed for reading in both print and on the computer. If printing the manual, please print double-sided. The embedded page size is 8 1/2" x 11". Printing on A4 paper will result in a slightly reduced size.

For reading on the computer, we have included hyperlinked cross-references throughout the manual. In addition, a table of contents is embedded in the PDF file. Use the View menu (Preview on Mac) or the bookmarks sidebar (Adobe reader on Mac and Windows) to view this table of contents.

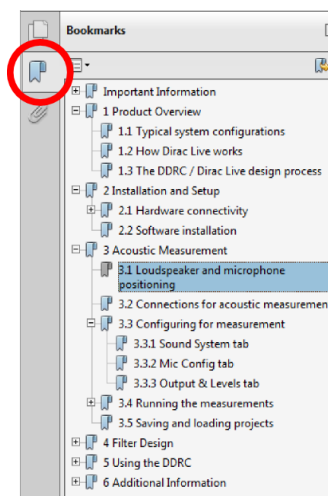

Adobe Reader on Windows

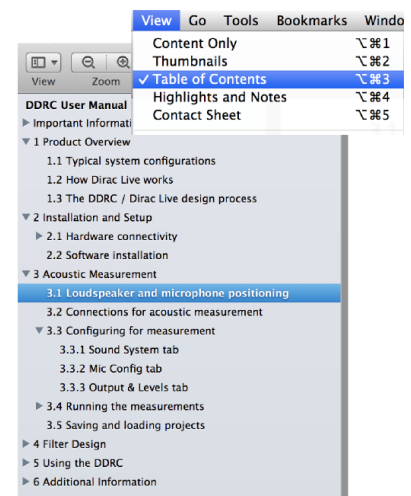

Preview on Mac

CONTENTS

IMPORTANT INFORMATION	3
Contents.....	5
1 Overview	7
2 Software Installation and Configuration	8
2.1 Download and install the DiracLive application	8
2.2 Update your installed miniDSP software	8
2.3 Update your device firmware.....	8
3 Channel Configuration (multichannel processors only).....	9
4 Dirac Live Calibration	11
4.1 Loudspeaker and microphone positioning – stereo systems.....	11
4.2 Loudspeaker and microphone positioning – multichannel/home theater systems	12
4.3 Connections for Dirac Live calibration.....	13
4.3.1 Subwoofer settings (multichannel systems)	14
4.4 Before You Proceed	15
4.4.1 Check your configuration/preset.....	15
4.4.2 Windows 10 users	15
4.4.3 macOS users	17
4.5 Starting the DiracLive application.....	19
4.6 Dirac account login or creation	20
4.7 Select device	21
4.8 Common features of the DiracLive UI	22
4.8.1 Sidebar.....	22
4.8.2 Loaded filters.....	23
4.8.3 Tab selection menu	23
4.8.4 Main display area	23
4.8.5 Main menu	23
4.8.6 Notifications	24
4.8.7 Help overlay.....	24
4.8.8 Navigation buttons	24
4.9 Select Recording Device	25
4.10 Volume Calibration.....	26
4.11 Select Arrangement.....	28
4.12 Measure.....	29
4.12.1 Tightly focused imaging.....	30
4.12.2 Focused imaging.....	31
4.12.3 Wide imaging.....	31
4.12.4 Run the first measurement	32
4.12.5 Completing the measurements.....	34
4.12.6 Viewing and redoing measurements.....	34

4.13	Filter Design.....	35
4.13.1	Frequency response display – stereo	35
4.13.2	Frequency response display – multichannel	36
4.13.3	Channel selection and groups - multichannel	37
4.13.4	Zooming in on the graph	38
4.13.5	Display controls	38
4.14	Designing the target curve	40
4.14.1	Range curtains	41
4.14.2	Snapshots	42
4.14.3	Reset to default	42
4.14.4	Saving and loading individual target curves	42
4.14.5	Guidelines for target curve design	43
4.15	The Impulse response graph	44
4.16	Saving and loading projects.....	46
4.17	Filter Export	47
5	Additional Information	49
5.1	Solving connectivity issues	49
5.1.1	No Internet connection	49
5.1.2	The miniDSP processor is not detected.....	49
5.2	Trouble-shooting audio issues.....	51
5.3	Legacy Support Manuals	52

1 OVERVIEW

This manual describes operation of the current version of Dirac Live on Dirac Live-enabled miniDSP processors. It complements the main user manual for each product. The term “miniDSP processor” will refer to any of the following miniDSP products:

Stereo processors

- [SHD Series \(User Manual\)](#)
- [DDRC-24 \(User Manual\)](#)
- [DDRC-22D \(User Manual\)](#)
- miniDSP Flex (User Manual)

Multichannel processors

- [DDRC-88A \(User Manual\)](#)
- [DDRC-88D \(User Manual\)](#)
- [C-DSP 8x12 DL \(User Manual\)](#)
- [Harmony DSP 8x12 \(User Manual\)](#)



This software runs on Windows 10 or later and macOS 10.14 Mojave or later. Other versions of Windows or macOS/OS X are not supported.

If you are unable to run the above versions of the Windows or macOS operating system, you may be able to run the original version of Dirac Live (“Dirac Live 1”) with your miniDSP processor. Not all processors have this ability, see section 5.3.

2 SOFTWARE INSTALLATION AND CONFIGURATION

miniDSP processors are configured by software running on a PC or Mac. There are two sets of software to download and install, from live.dirac.com and from [miniDSP.com](https://minidsp.com).



The software described in this section runs on Windows 10 or later and macOS 10.14 Mojave or later. Other versions of Windows or macOS/OS X are not supported.

2.1 DOWNLOAD AND INSTALL THE DIRACLIVE APPLICATION

Download the DiracLive application installer for Windows 10 or macOS from <https://live.dirac.com/download/>. On macOS, double-click on the download file to unzip it.

Double-click on the downloaded (and unzipped) installer to run it. It will have a name like **diralive-latest.exe** (Windows) or **DiracLive v3.0.14 Setup Darwin.app** (macOS). (The version number embedded in the file name may be different.) Accept the default installation settings. Do not run the DiracLive software yet.



Changing the installation path away from the default may cause issues with DiracLive being unable to find the miniDSP processor. If you did not install with the default settings, see Installation path issues on page 50.

2.2 UPDATE YOUR INSTALLED MINIDSP SOFTWARE

If you are upgrading from the older version of DiracLive or have not updated your miniDSP software recently, download the miniDSP software from the User Downloads area on minidsp.com (<http://www.minidsp.com/userdownloads>) and install it. Refer to your processor's User Manual for details.

2.3 UPDATE YOUR DEVICE FIRMWARE

If you are upgrading from the older version of DiracLive, have not updated your firmware in some time, or have purchased a used miniDSP processor, update your device firmware. Refer to your processor's User Manual for details.

3 CHANNEL CONFIGURATION (MULTICHANNEL PROCESSORS ONLY)

This section applies to multichannel processors only. You will need to do this before you run the DiracLive app for the first time.

Start your processor’s plugin and click on the **Connect** button. Click on the **Display** menu in the plugin. The menu options will vary depending on your specific product. Select the “Dirac Channels Configuration” menu entry:

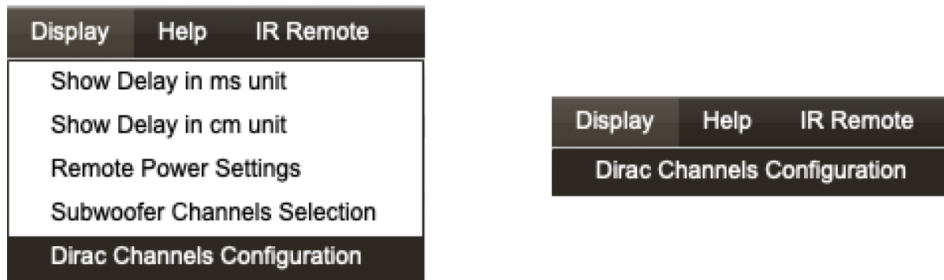

Use the screen that pops up to set up your speaker configuration. For example, below is a typical setting for a 5.1 system using small speakers:

Sequence	Zone No.	Channel	Speaker Type
1	Zone 1	Dirac 1	Small / Bass Managed
2	Zone 1	Dirac 2	Small / Bass Managed
3	Zone 1	Dirac 3	Subwoofer
4	Zone 1	Dirac 4	Small / Bass Managed
5	Zone 1	Dirac 5	Small / Bass Managed
6	Zone 1	Dirac 6	Small / Bass Managed
7	Zone 1	Unused	Unknown
8	Zone 1	Unused	Unknown

Sequence

This is the order in which channels are measured.

Zone No.

You can create up to 8 zones. Each zone is calibrated separately.

Channel

Select the Dirac Live channel. If a channel is not being used, set this to “Unused.”

Speaker Type

Set the type of each speaker.

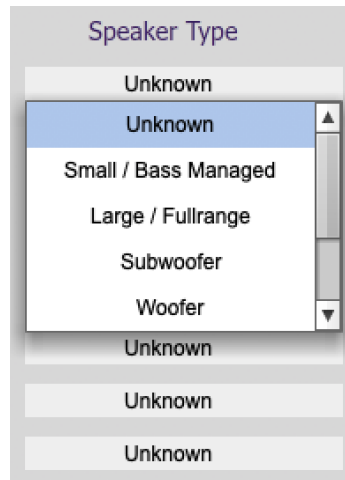

The speaker type is currently provided for user information only. It affects items such as the icons displayed for each channel in the DiracLive app. However, it's still recommended that this be set correctly for your system in order to allow for future enhancements.

4 DIRAC LIVE CALIBRATION

Dirac Live uses measurements made in your listening room to calculate correction filters for all speakers and the subwoofer. You will take these measurements using the miniDSP processor, the **DiracLive** application running on your computer, and a miniDSP UMIK-1 measurement microphone.

The DiracLive app will guide you through the measurement and filter design procedure. You will take from 9 to 17 measurements at different locations in your listening room.

4.1 LOUDSPEAKER AND MICROPHONE POSITIONING – STEREO SYSTEMS

Prior to performing acoustic measurements, optimize your loudspeaker and listening positions. Start with the recommendations of the manufacturer of your loudspeakers. Loudspeakers designed for home hifi use typically perform best away from the walls, whereas speakers designed for studio use may be designed for use closer to walls or other surfaces. With Dirac Live, you have more freedom with loudspeaker placement, but the best result will still be achieved if optimal loudspeaker placement is used together with Dirac Live.

You should also experiment with toe-in – many loudspeakers benefit from pointing directly at the listening position or even slightly in front. The listening position should be away from the rear wall, as placing the listening chair or sofa right against the wall will result in increased early reflections and changes in timbre.

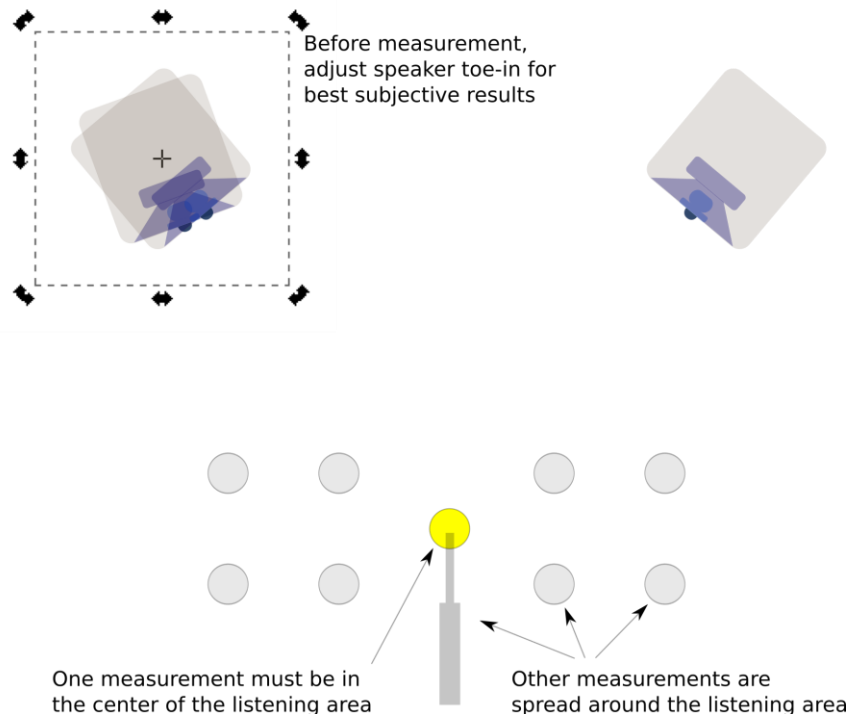

Figure 1. Typical stereo system measurement setup

For stereo systems, we generally recommend that the microphone be pointed between the two speakers. The first measurement must be taken at the **exact center** of the listening area, so that Dirac Live can set the levels and delays of each speaker. While this will usually place the microphone an equal distance from both speakers,

Dirac Live will adjust in cases where it is not. Additional measurements are taken at other positions around the listening area and at different heights from the floor. Note that all measurement positions should have acoustic “line of sight” i.e. the direct signal from the speaker to the microphone should not be obstructed by furniture or other objects.

4.2 LOUDSPEAKER AND MICROPHONE POSITIONING – MULTICHANNEL/HOME THEATER SYSTEMS

Prior to performing acoustic measurements, loudspeaker and subwoofer positioning should be optimized. In particular, the location of the subwoofer will have a large impact on bass response. With Dirac Live®, you have more freedom with loudspeaker and subwoofer placement, but the best result will still be achieved if optimal placement is used together with Dirac Live®.

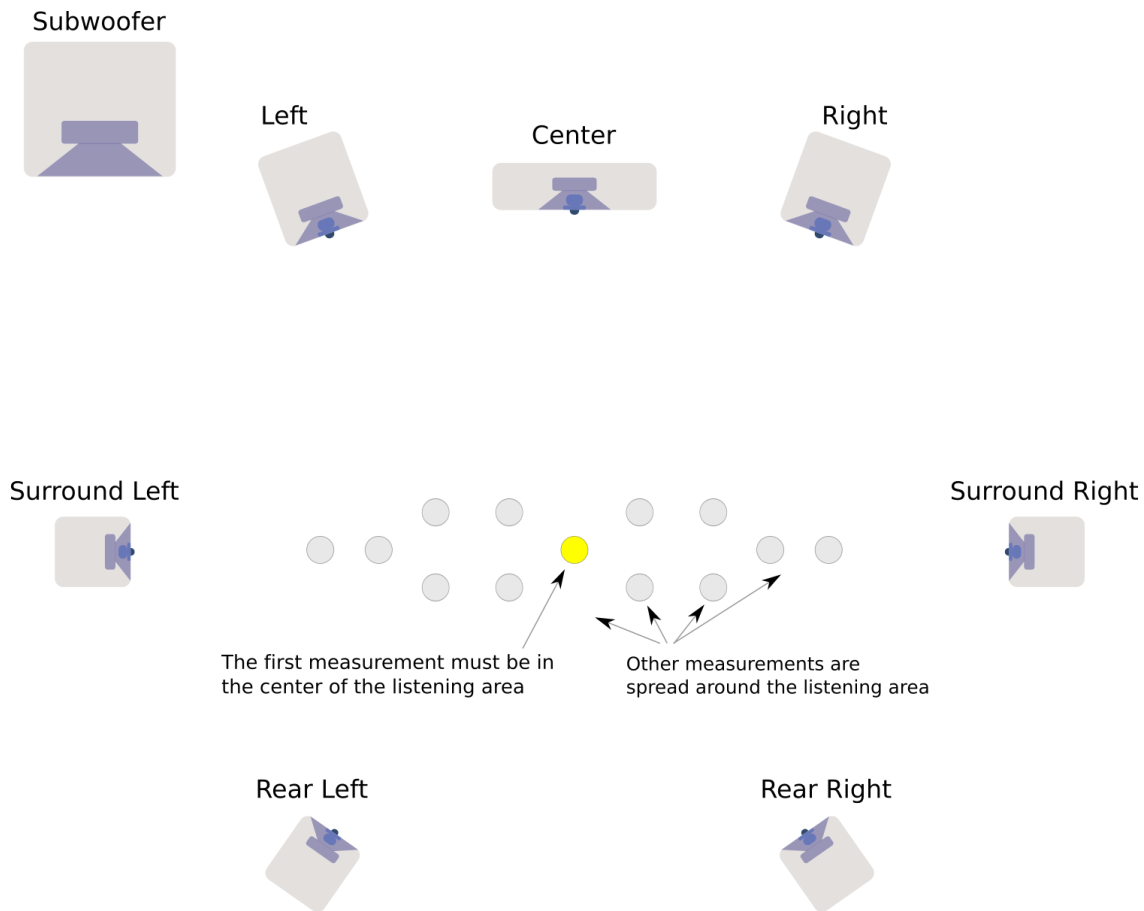

Figure 2. Typical home theater measurement setup

A total of nine, 13 or 17 measurements is recommended, with the microphone located in different positions in the room and pointed vertically (that is, at the floor or ceiling). The first measurement must be taken at the **exact center** of the listening area, so that Dirac Live can set the levels and delays of each speaker. Additional measurements are then taken at locations spread around the listening area and at different heights from the floor.

Note that all measurement positions should have acoustic “line of sight” i.e. the direct signal from the speaker to the microphone should not be obstructed by furniture or other objects.

4.3 CONNECTIONS FOR DIRAC LIVE CALIBRATION

Figure 3 and Figure 4 show typical connections for acoustic measurement with the DiracLive application. Usually, you do not need to change any of the audio connections, as the DiracLive test signals are generated inside the miniDSP processor.

1. Connect the supplied USB (type A to type B) cable from the processor to a USB port on the computer.
2. Connect the supplied USB (type A to mini type B) cable from the UMIK-1 to a USB port on the computer.

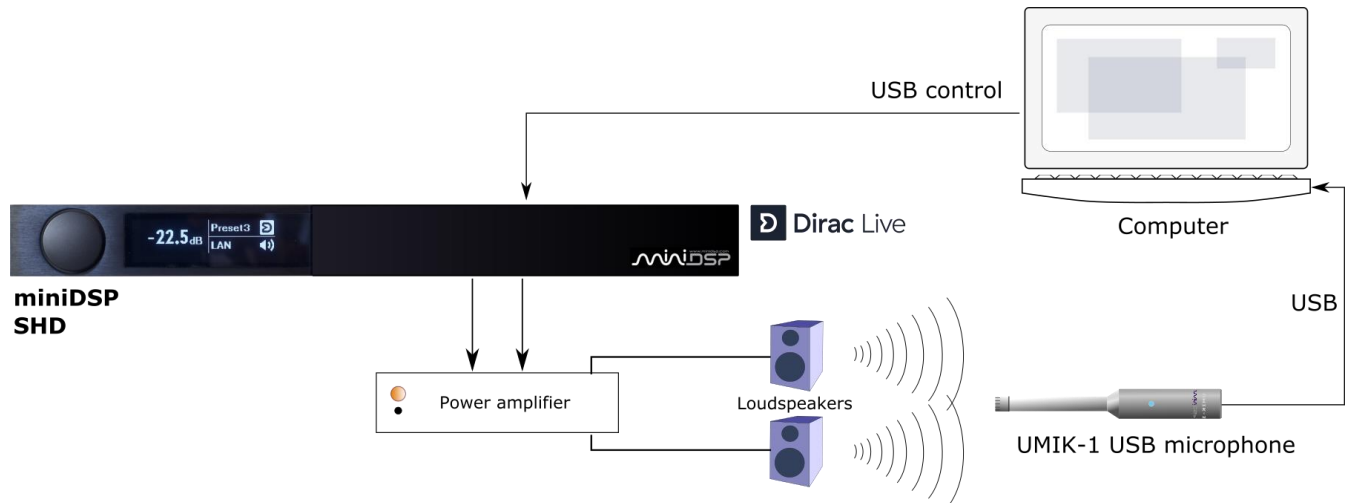

Figure 3. Typical connections for measurement of a stereo system

Place the UMIK-1 microphone into a microphone stand and position the computer and cabling so that there is enough freedom of movement to move the microphone into the needed locations. A small tripod stand is supplied with the UMIK-1, but a larger stand with boom arm can be used if desired. If necessary, a USB extension (up to a total USB cable length of 5 meters) can be used. In larger spaces, an active USB repeater may be needed.

- For stereo systems, we generally recommend that the microphone be pointed between the speakers and the “0 degree” calibration file used.
- For surround/multichannel applications, we recommend that the microphone be pointed at the ceiling and the “90 degree” calibration file used.

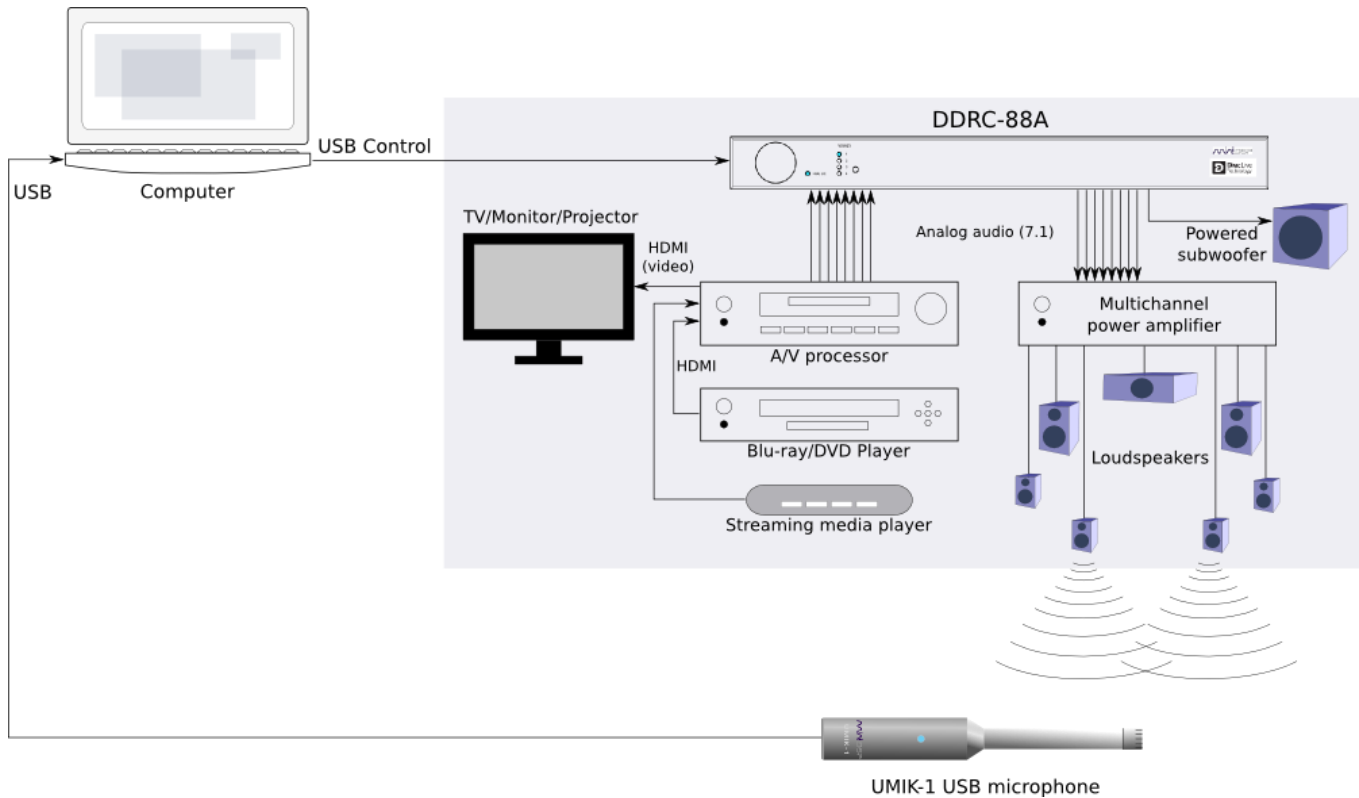

Figure 4. Typical connections for measurement of home theater system

4.3.1 Subwoofer settings (multichannel systems)

If using a subwoofer in a multichannel system, we recommend that its low pass filter be disabled if possible, or set to its highest frequency if it cannot be disabled. Any EQ on the subwoofer should be disabled or set “flat.” High pass filters used to protect the driver from over-exursion should be left in place.

If the subwoofer’s low pass filter is an important part of the overall bass management in the system, it can be re-enabled after completing Dirac Live calibration and loading correction filters into the miniDSP processor.

4.4 BEFORE YOU PROCEED

4.4.1 Check your configuration/preset

If you have used the plugin to configure back-end processing (e.g. for subwoofer integration), check that you have the correct configuration selected before starting Dirac Live. This is because the Dirac Live test signal passes through the routing matrix and the output channel processing.

For example, suppose you have set up configuration 2 with routing and output channels for a subwoofer. Before starting Dirac Live with the **Start Dirac Live Software** button, select configuration 2 from within the plugin or with the remote control.

4.4.2 Windows 10 users

Double-check the following items *before* starting the DiracLive application.

4.4.2.1 UMIK-1 plugged in

If you haven't plugged in your UMIK-1 yet, plug it in now.



Be sure to plug in the UMIK-1 **before** starting DiracLive.

4.4.2.2 Check that UMIK-1 is set as the default recording device

Open the Windows Control Panel and select the Sound pane then the Recording tab. Check that the UMIK-1 is set as the default recording device. If it is not, then click on it and then on the Set Default button.

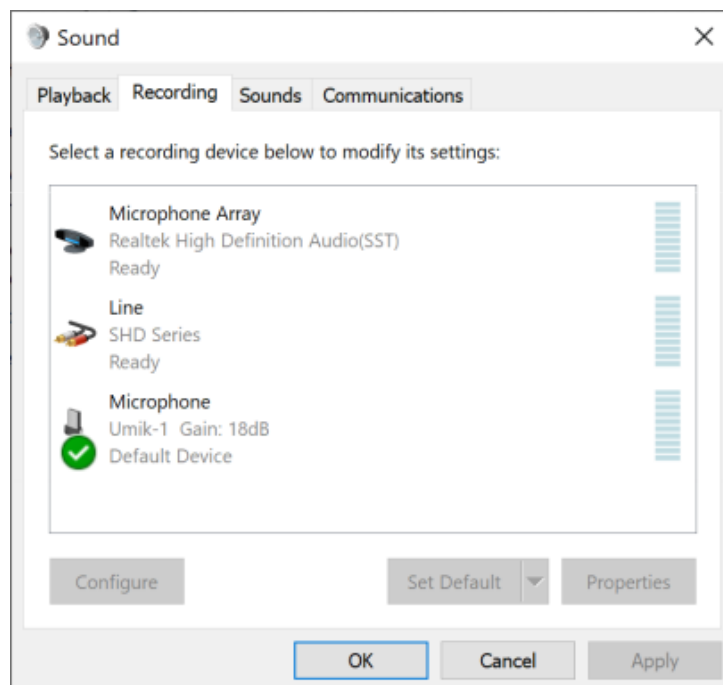

4.4.2.3 DiracLive has access to the microphone

Open the Windows 10 Settings and select Security, then Privacy then Microphone. Check that “Allow apps to access your microphone” is turned on.

Allow apps to access your microphone

If you allow access, you can choose which apps can access your microphone by using the settings on this page. Denying access blocks apps from accessing your microphone.



Scroll down and check that “Allow desktop apps to access your microphone” is also turned on, and that DiracLive.exe is listed with the applications that are allowed to access the microphone:

Allow desktop apps to access your microphone

Some apps and Windows features need to access your microphone to work as intended. Turning off this setting here might limit what desktop apps and Windows can do.



Some desktop apps might not appear in the following list or are not affected by this setting. [Find out why](#)



REW room acoustics and audio analysis software
Last accessed 24-Nov-19 2:50:43 PM



DiracLive.exe
Last accessed 24-Nov-19 2:56:32 PM

4.4.3 macOS users

4.4.3.1 Enable file sharing for device discovery

To enable device discovery, open System Preferences and then go to Sharing. Enable File Sharing as shown at right.

Notes:

- a) This step is not always necessary and may depend on your Mac's configuration or home network setup.
- b) You can turn File Sharing off again after you have completed your calibrations.

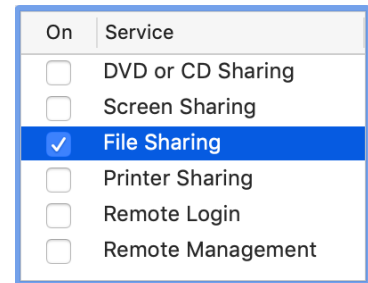

4.4.3.2 UMIK-1 plugged in

If you haven't plugged in your UMIK-1 yet, plug it in now.



Be sure to plug in the UMIK-1 **before** starting DiracLive.

4.4.3.3 Grant microphone access

The heightened security in recent versions of macOS can cause some difficulties with the DiracLive application accessing the UMIK-1. The DiracLive application should request microphone access when it first runs. A dialog like this will appear:

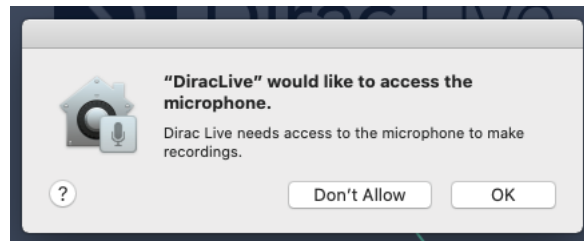

When it does, click **OK**. You can confirm that access has been granted by opening System Preferences, then going to the Security&Privacy pane, selecting the Privacy tab, then clicking on Microphone at the left:

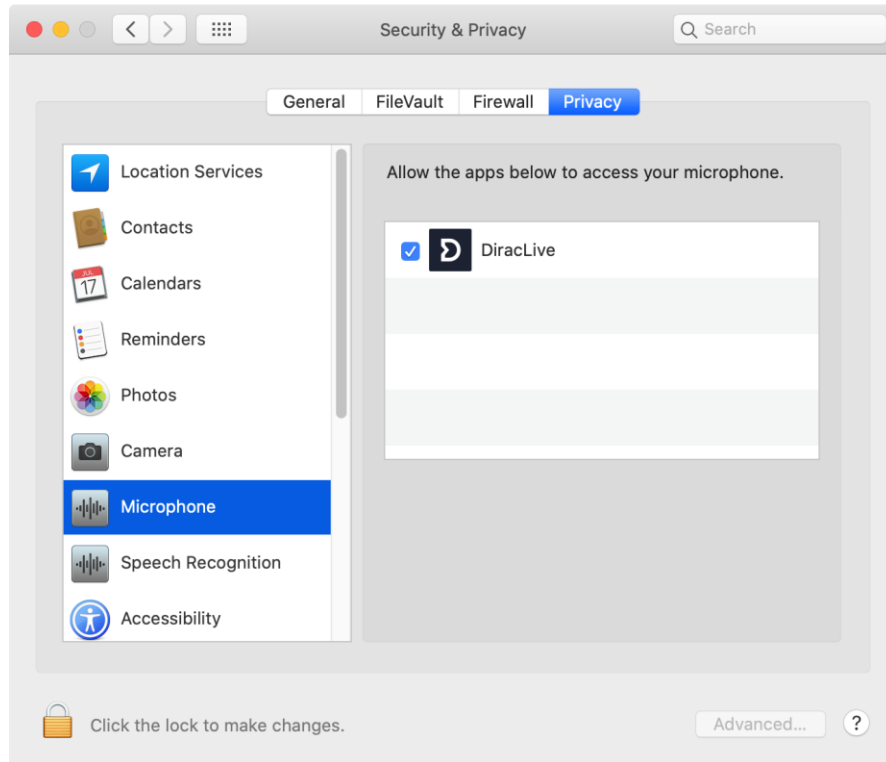

The application “DiracLive” should appear here. You will typically have additional applications to which you have given microphone access.

4.5 STARTING THE DIRACLIVE APPLICATION

To start the DiracLive application, first run the miniDSP plugin for your processor. Then click on the **Start Dirac Live Software** button. Its location may vary depending on the processor. For stereo processors:

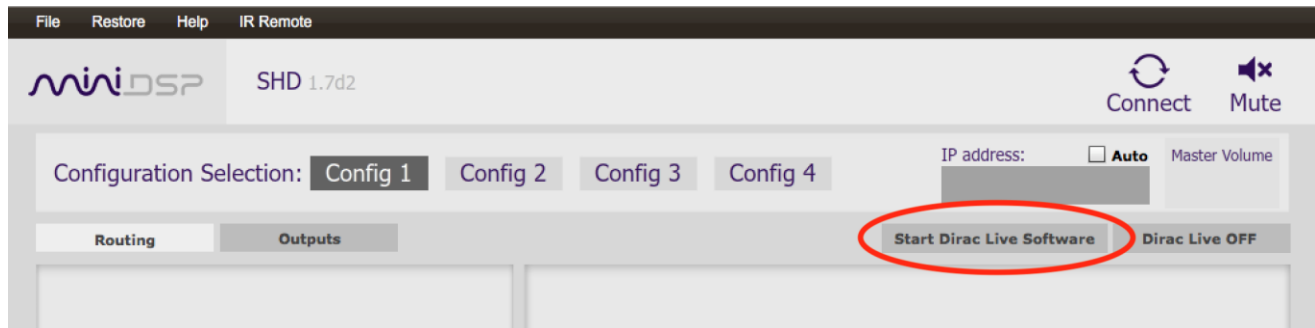

For multichannel processors:

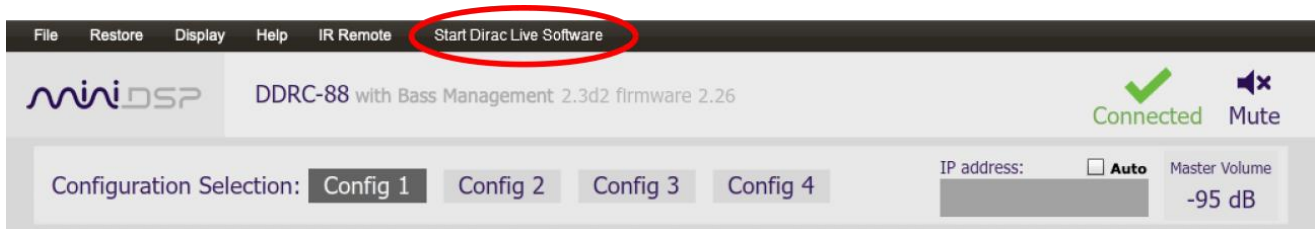

The DiracLive application will start. If you had previously clicked **Connect** in the plugin, the plugin will now disconnect from the processor. If you wish to later click **Connect** in the plugin again, you must quit DiracLive first.



You **must** start the DiracLive application from within the plugin as described above. Otherwise, DiracLive will not be able to detect the miniDSP processor.



If you are running macOS and the DiracLive application does not start or is unable to detect your processor (page 21), ensure that your plugin and processor firmware are up to date. Refer to your processor's User Manual.

4.6 DIRAC ACCOUNT LOGIN OR CREATION

The DiracLive application works better when you are logged into your Dirac account. The first time you start it, the option to log in or create an account appears.

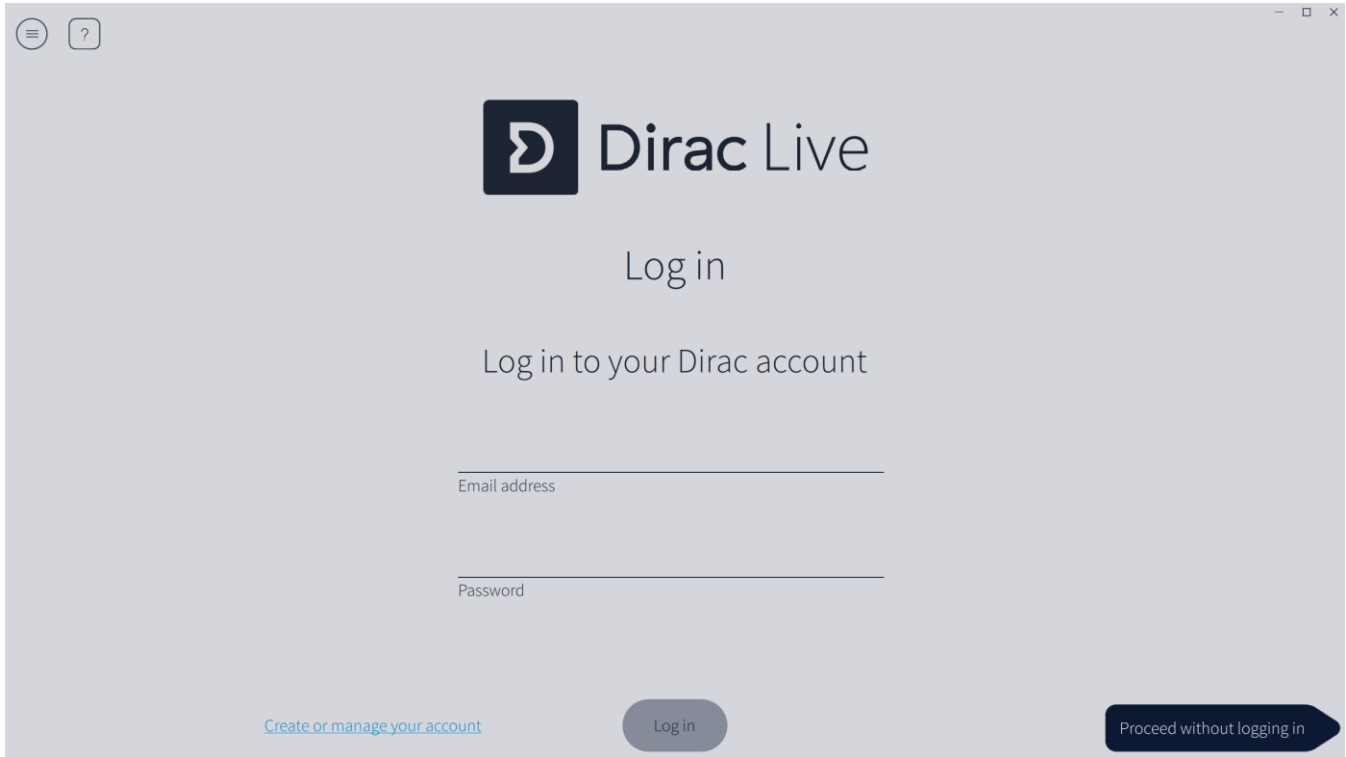

You can log in here if you have a Dirac account. If you do not have an account, you can create one by clicking on “Create or manage your account.” This will direct you to <https://live.dirac.com>.

If you wish, you can click “Proceed without logging in” to perform a calibration. You can return to this tab later and create an account by selecting Login from the hamburger menu.

The following functions are enabled only when logged into a Dirac account:

- Load a previously saved project. You can only load an existing project if you are logged into a Dirac account. If you don’t log in, you will be able to save your measurements as a project, but you will not be able to open them again.
- Other optional or paid-for features. miniDSP always provides the “full” version of Dirac Live with its products, so you do not need to log in to use the full version of Dirac Live if you have a miniDSP product.

4.7 SELECT DEVICE

The only device visible here will be the miniDSP processor. If necessary, close the help overlay that obscures the device icon. Click on the device icon to select it and proceed to the next tab.



If you are using a multichannel processor and have created more than one zone, select the zone that you want to calibrate:



If DiracLive doesn't find your device, see Solving connectivity issues starting on page 49.

4.8 COMMON FEATURES OF THE DIRACLIVE UI

Once you have selected the processor, the full DiracLive UI becomes visible. This section describes the features of the UI that are common to all subsequent tabs.

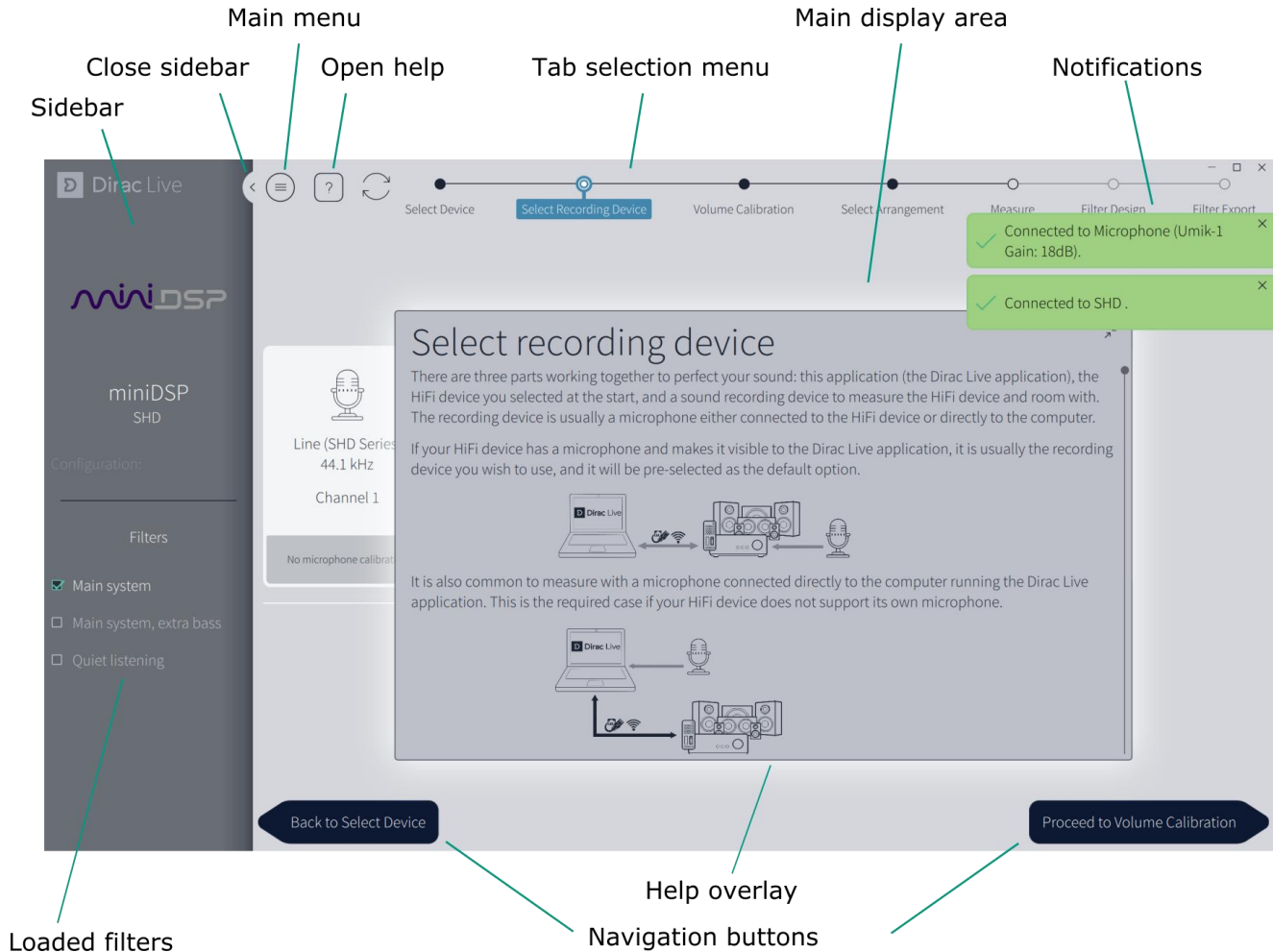

4.8.1 Sidebar

The sidebar shows the currently selected device. The lower portion lists loaded filters. The sidebar can be closed with this icon:



4.8.2 Loaded filters

After correction filters have been loaded into the miniDSP processor, the list of loaded filters appears here. Enabling a filter will turn on that filter, and also change the preset configuration to the matching slot.

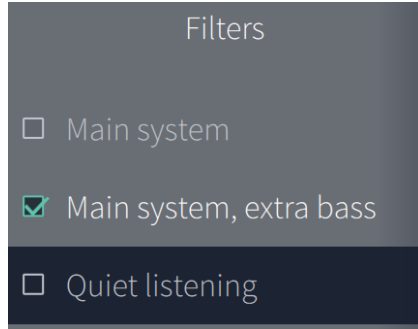

4.8.3 Tab selection menu

Once the output device has been selected, the main tab menu appears. This menu indicates which tab you are currently viewing. Each tab has buttons to navigate to the previous and next tabs. You can also navigate directly to a tab by clicking on its name in the menu.



4.8.4 Main display area

The Main display area contains the key information of each tab.

4.8.5 Main menu

The “hamburger” icon towards the top left drops down a menu with a number of useful items:

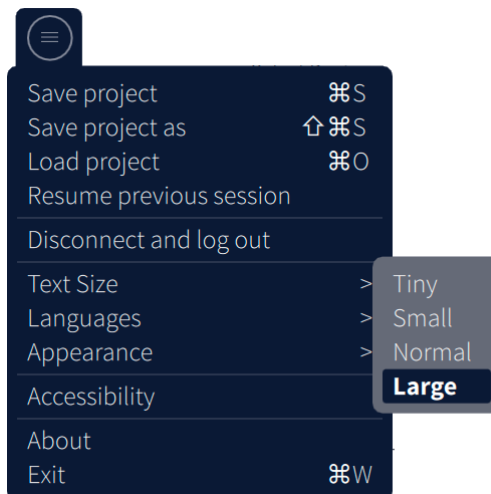

4.8.6 Notifications

When events happen, a notification appears to the top right of the window. Normal notifications are in green, with warnings and errors in black and orange:

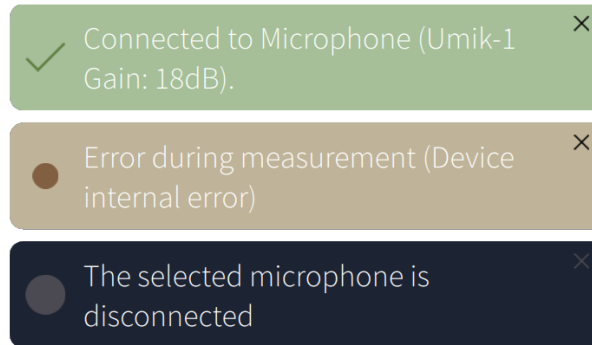

To close a notification, click on the “X” at its top right.

4.8.7 Help overlay

The help overlay appears on each tab the first time you open it. You can scroll to read all of it. Note that the recommendations in the Help overlay are generic – that is, they do not necessarily apply to the specific device that you are using. For example, it may say “If your HiFi device has a microphone...” – this does not apply to the miniDSP processors.

To close the overlay, click on the icon at its top right (partially obscured in the screenshot on page 22):



To open the help overlay again, click on the question mark icon:



4.8.8 Navigation buttons

The navigation buttons to the lower left and lower right of the main display area link to the next and previous tab, using the order in which a complete calibration is normally performed.

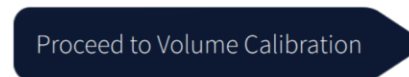
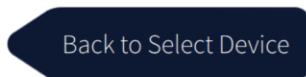

4.9 SELECT RECORDING DEVICE

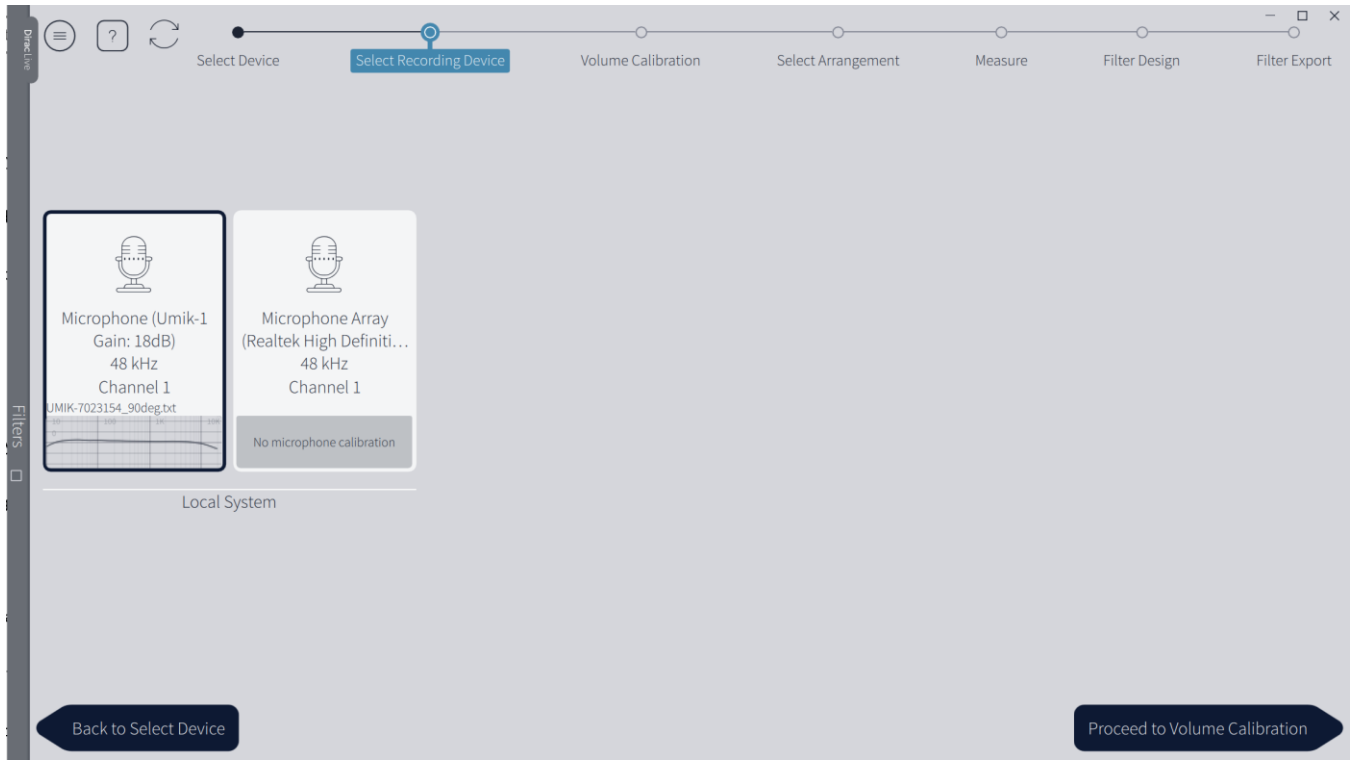

Use this tab to select the UMIK-1 and load its calibration file:

1. Click on the UMIK-1 icon, labeled “Microphone (Umik-1 Gain: 18 dB)”, to select it.
1. At the bottom of the grey rectangle, click on “No microphone calibration” and then “Load from file.”
2. Locate your UMIK-1 calibration file in the file system and select it. The calibration file name and the calibration curve will then be displayed.

Note: Each UMIK-1 measurement microphone is individually calibrated to ensure accuracy. To download the unique calibration files for your microphone, go to the [UMIK-1 page](#) and enter your microphone's serial number. It is in the form xxx-yyyy and labelled on the microphone.

Two calibration files are downloaded:

- The regular or “on axis” calibration file will be saved to the computer with a name that is the same as the serial number e.g. “7001870.txt”. This is the one that you should use when pointing the microphone towards the speakers.
- The second calibration file has “_90deg” in the name e.g. “7001870_90deg.txt.” This corrects the frequency response when the microphone is oriented at 90 degrees to the sound source, such as when pointing the microphone towards the ceiling.

Once you have verified that this tab is correct, click the **Proceed to Volume Calibration** button.

4.10 VOLUME CALIBRATION



Use this tab to set the output level and microphone recording level. The microphone should be positioned in the center of the listening area and pointed towards the ceiling. For best calibration results, ensure that the environment is reasonably quiet. Low frequency noise in particular can disrupt the calibration.

1. Check that the **Master output** slider is set low.
2. Click on the triangular button for the Dirac 1 channel and gradually increase the **Master output** slider. You should hear pink noise playing from the left front speaker. Continue to increase volume until it is at a moderate level, such that your voice would have to be raised to converse with someone sitting next to you.
3. Increase the **Mic gain** slider so that the level meter is in the middle of the blue-grey zone, as shown in the screenshot above.
4. Click on the triangular button for the Dirac 2 channel and confirm that the level is also in the blue-grey zone. If necessary, adjust **Mic gain** so that both channels are in the blue-grey zone. Repeat for all remaining channels.

As a safety feature, output volume is limited to -31.9 dB. If you try to raise it higher, a lock icon will appear. To raise it higher, click the lock. It will “unlock” and then you can raise the slider further. The lock icon will automatically lock again after a few seconds.

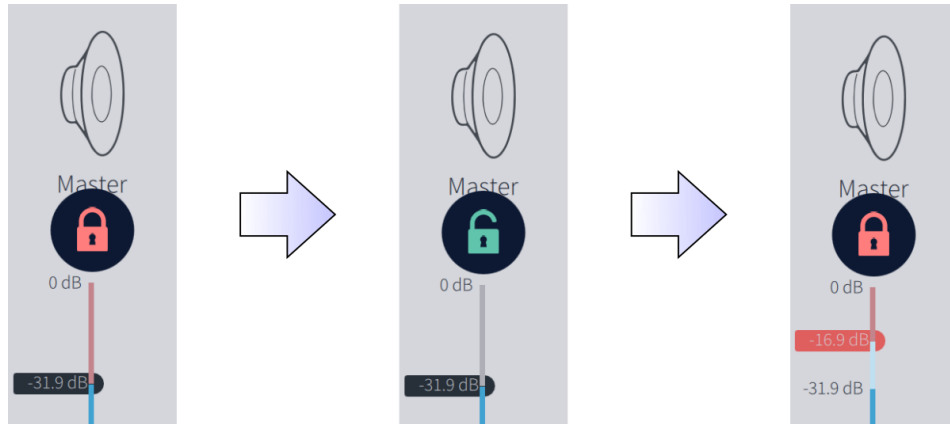

Once you have set the input and output levels, click the **Proceed to Select Arrangement** button.

4.11 SELECT ARRANGEMENT

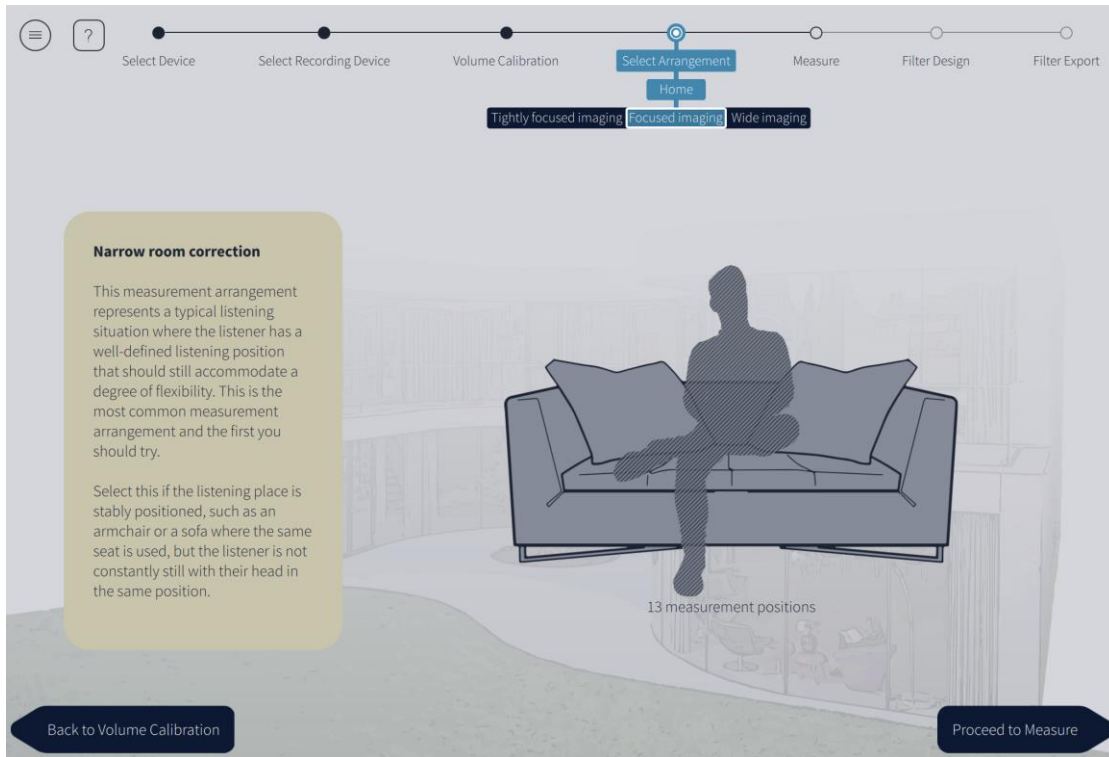

The **Select Arrangement** tab selects the type of seating arrangement to calibrate for. Each arrangement has a different set of measurement positions, in order to optimize the response around that area.

The menu bar shows the selection choices:

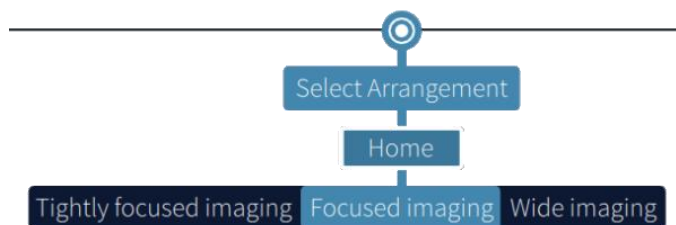

Use the menu to select the arrangement that is most appropriate for your listening area. They are described more on following pages.

There are no hard and fast rules on which arrangement to use, so feel free to experiment by calibrating for more than one arrangement and comparing the results by auditioning. Up to four different sets of correction filters can be loaded into the miniDSP processor.

After selecting the seating arrangement, click on the **Proceed to Measure** button.

4.12 MEASURE

Measurements are performed on the **Measure** tab.

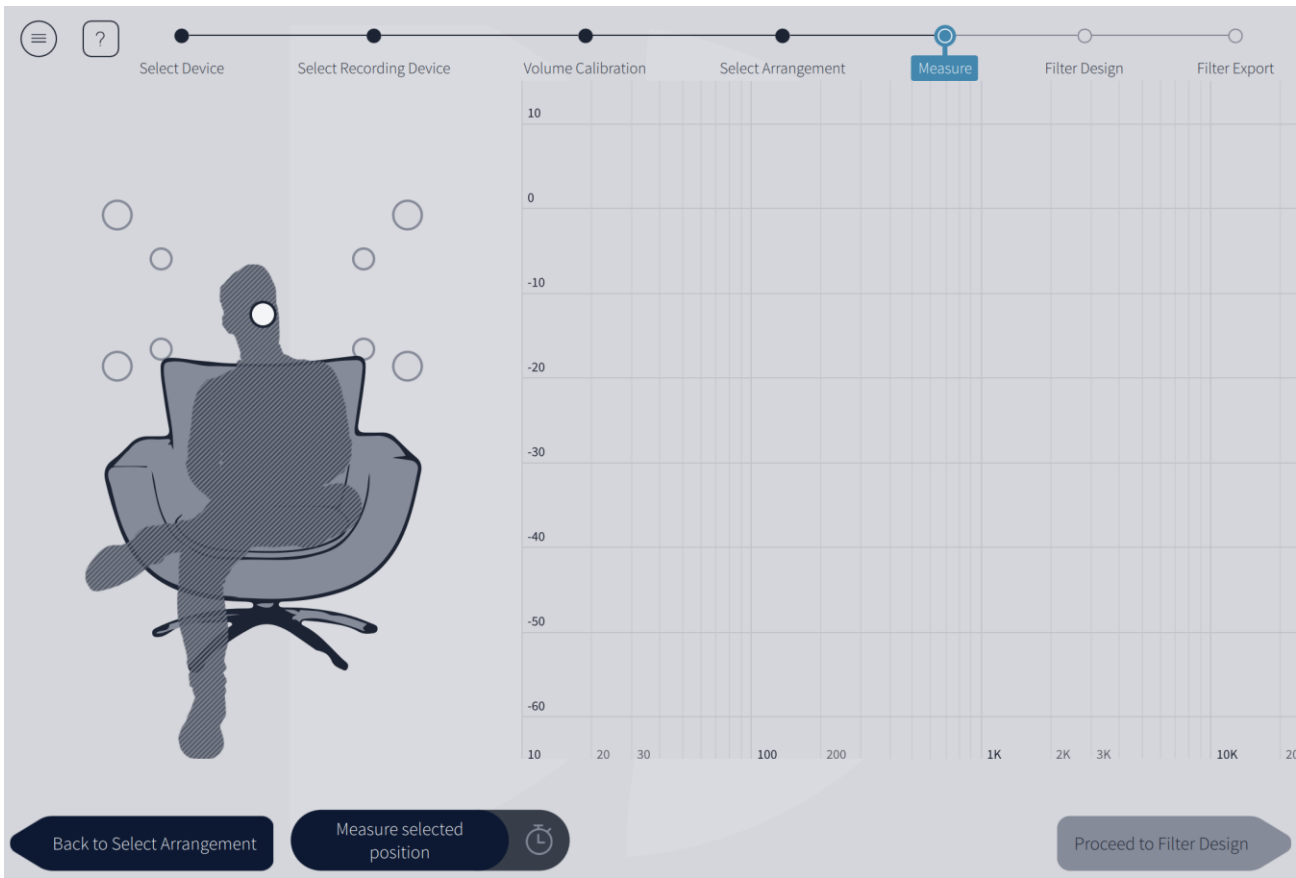

The left side of the window displays a visual guide to the measurement positions. The position that will be measured is shown in white. To display the name of a position, hover the mouse over it – the position will be highlighted in blue and its name displayed. For example:

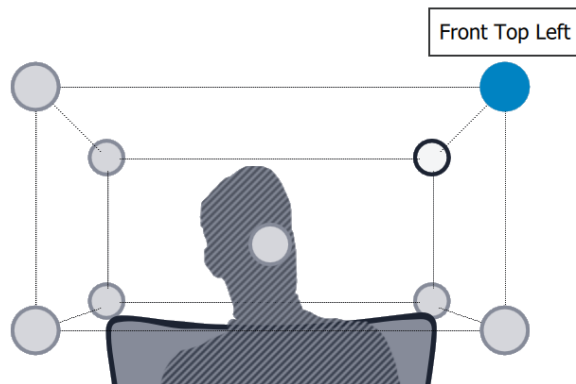

While the visual guide indicates a suitable set of microphone positions, these can be varied to suit individual circumstances. It is, however, imperative that the measurement named “Main Position” is taken in the center of the listening area, as this measurement is used to set the levels and delays of each channel.

The other measurement positions should be well spread out over the entire listening area so that DiracLive can acquire a good set of measurements that capture the acoustic behavior of the room. Typically, you should spread the microphone positions over a circle with a diameter of at least a meter (three feet) and vary the microphone height from the central position by at least 30 cm (one foot) up and down. Placing all measurement positions too close to each other may result in “over-correction” that will sound dry and dull.

A different set of measurement positions other than those indicated by the visual guide and the above guidelines can be used if necessary. For example, if the displayed measurement position doesn’t provide acoustic “line of sight” from the speaker to the microphone, then adjust the measurement position so that it does. The important thing is to ensure that the measurement positions are spread out over the whole listening area and that the microphone is moved a sufficient distance vertically as well as horizontally.

In some cases, such as when the listening area is very close to the loudspeakers or the loudspeakers have a very narrow dispersion pattern, the size and in particular the height of the measurement area can be reduced, to avoid discrepancies caused by varying output response from the speakers themselves.

4.12.1 Tightly focused imaging

This arrangement is best for a single listener. There are nine measurement positions:

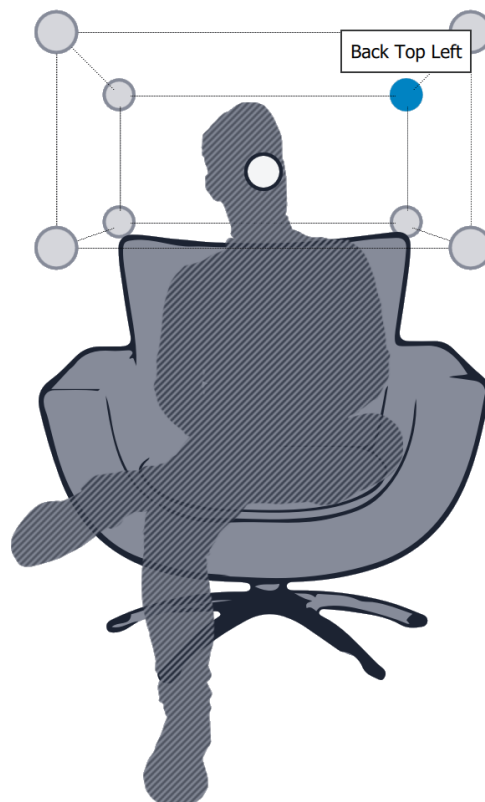

4.12.2 Focused imaging

This arrangement is optimized for a single listener but also caters for additional listeners. There are thirteen measurement positions: the same nine as the Chair arrangement, plus an additional four positions extending out to the left and right:

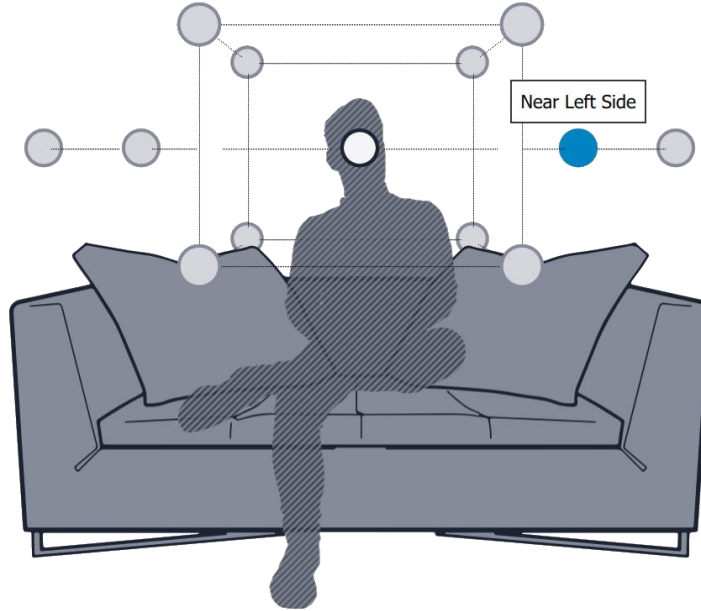

4.12.3 Wide imaging

This arrangement is optimized for multiple listeners. There are seventeen measurement positions: the same nine as the Chair arrangement, plus an additional eight positions that extend the listening area out to the left and right:

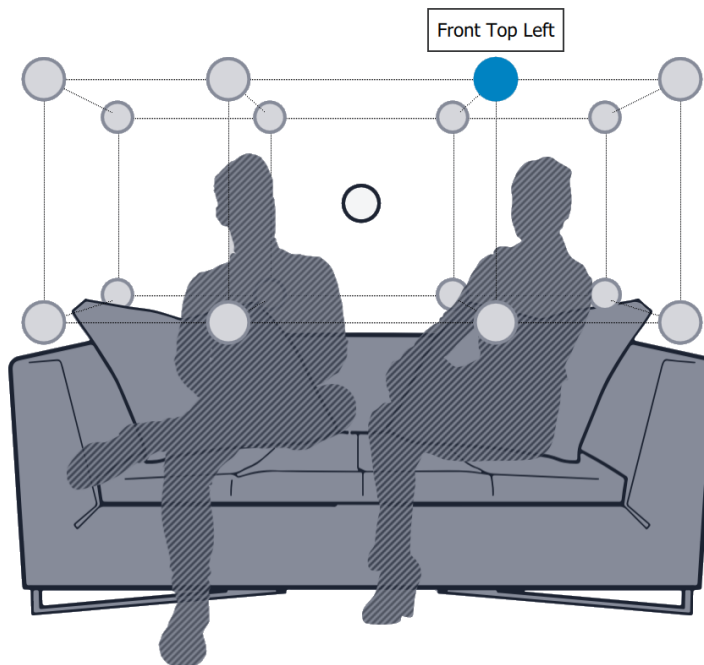

4.12.4 Run the first measurement

Prior to running the first measurement, you can optionally set a short delay before the measurement starts. To do so, click on the small clock icon on the right side of the **Measure selected position** button and choose the delay:

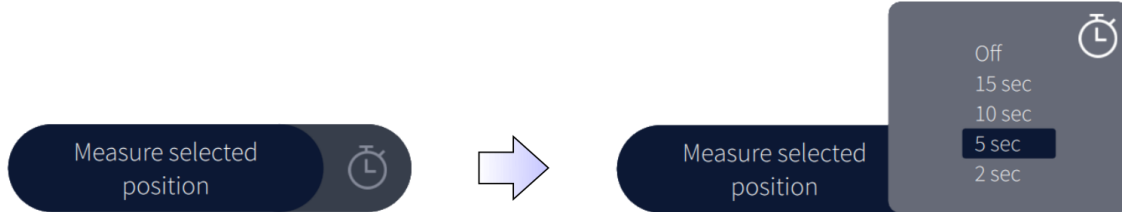

With the microphone placed in the *exact center of the listening area*, click on **Measure selected position**. The miniDSP processor will generate a test signal, audible as a frequency sweep through the left front speaker, then the right front, and so on through all channels. Finally, the sweep plays through the left front speaker again.

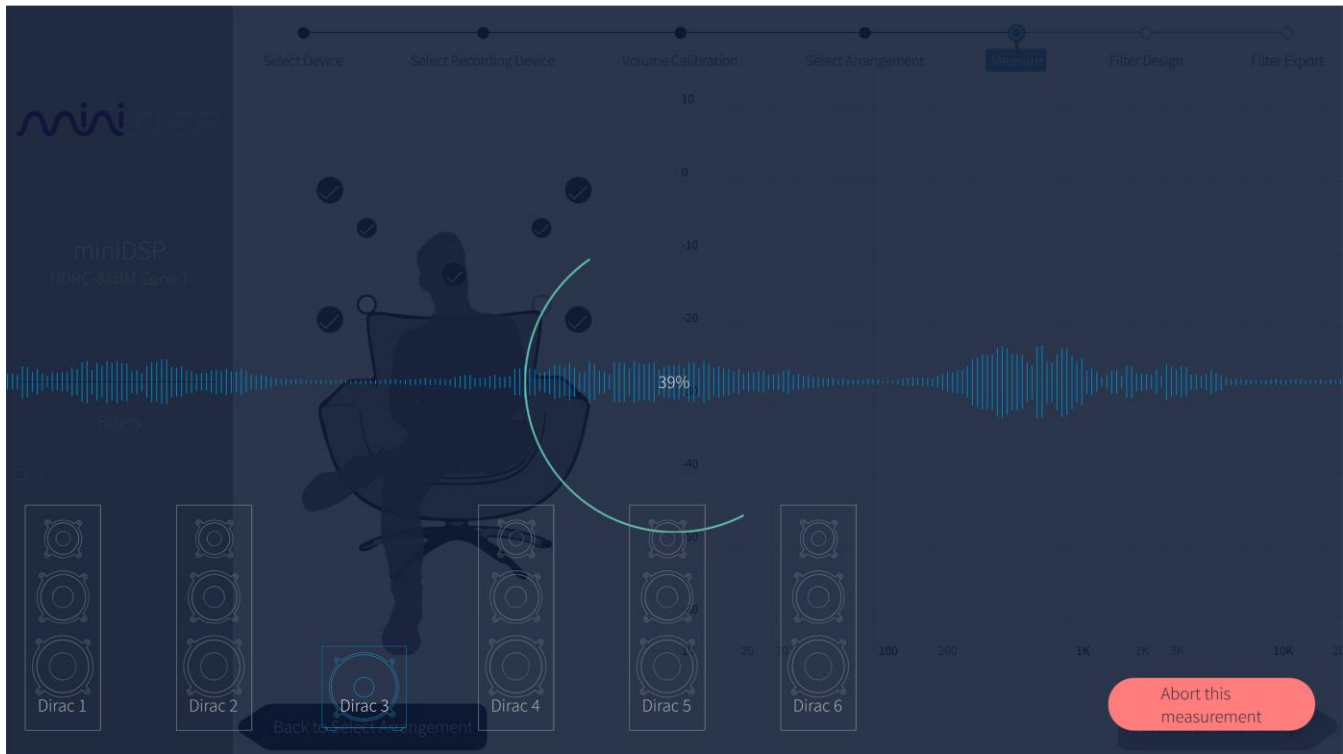

While the measurement proceeds, a time-domain graph of the captured audio signal is overlaid on the screen. This graph is related to the magnitude response but is not the same display. Its purpose is to verify that the recorded signal level is in a suitable range.

Note that measurements should be performed under good conditions. While the measurement technique used by DiracLive is quite robust, low-frequency noise (traffic, machinery, aircraft, storms) in particular can adversely affect measurement accuracy. A high level of ambient noise can degrade signal to noise ratio and prevent the algorithm from analyzing the test sweep signal properly. Minimize the effect of any external noise, ensure that measurement signal levels are adequate, and/or choose a suitable time for performing measurements.

On completion of a successful measurement, the window will update with a graph of the measured frequency response:

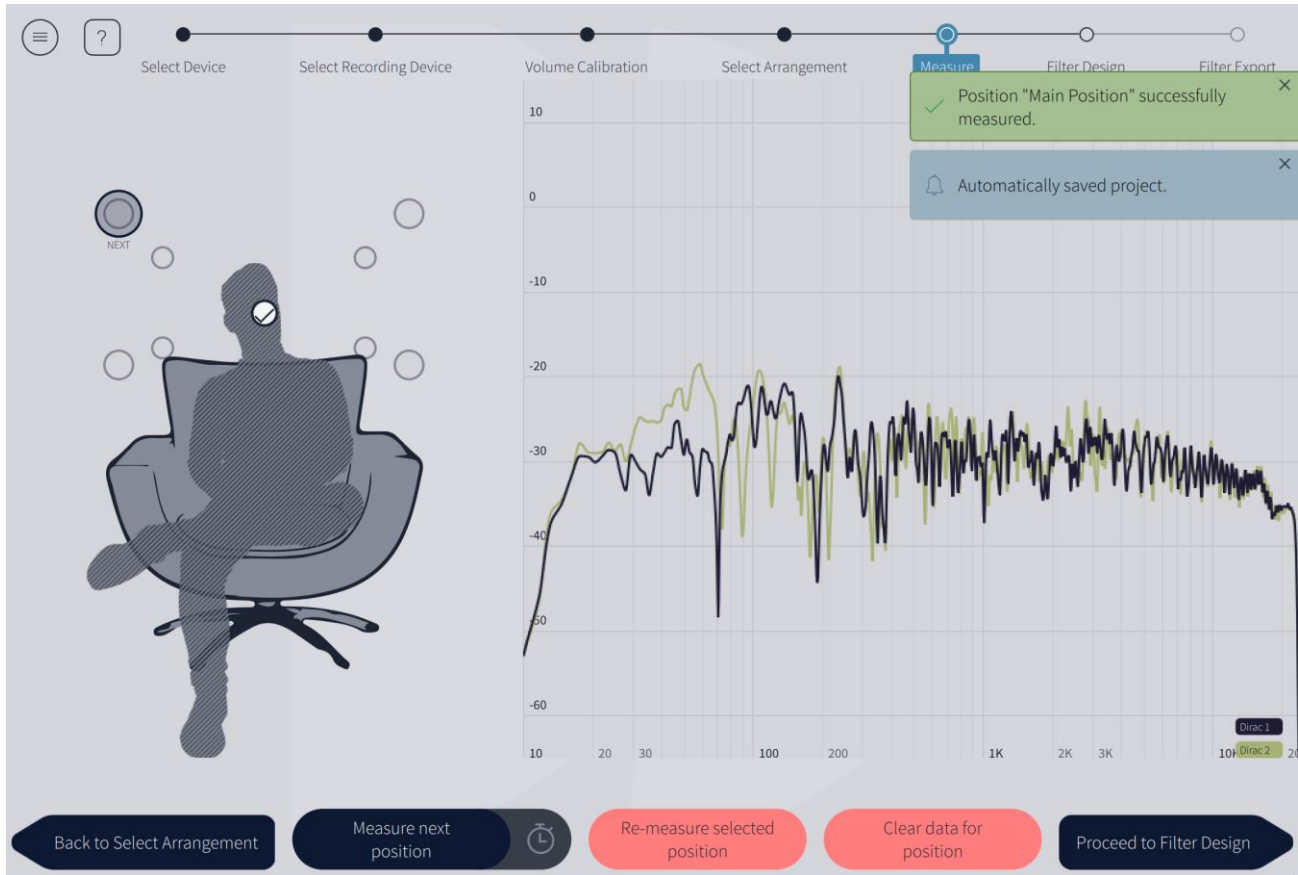

If the measurement is successful, a check mark will be shown on the visual guide and the next measurement position will be highlighted.

If the application indicates that the measurement was not successful, you will need to take corrective action. The most common errors are related to signal level:

- The measurement signal is too low to ensure a clean capture.
- The measurement signal is too high and the audio signal has exceeded the maximum level (clipping). This is shown in red on the time domain display.

In either of the above cases, go back to the **Volume Calibration** tab and adjust **Master output** or **Mic gain**. Then re-run the measurement.

4.12.5 Completing the measurements

To take the next measurement, move the microphone to the highlighted location – labeled “Next” on the seating visual – then click on **Measure next position**.

If the measurement produces an error that the signal was too low or high, go back to the **Volume Calibration** tab and adjust **Master output** or **Mic gain**. Return to the Measure tab and then click on **Remeasure selected position**. You do not need to redo measurements that you have already successfully completed.

Repeat until all positions have a successful measurement:

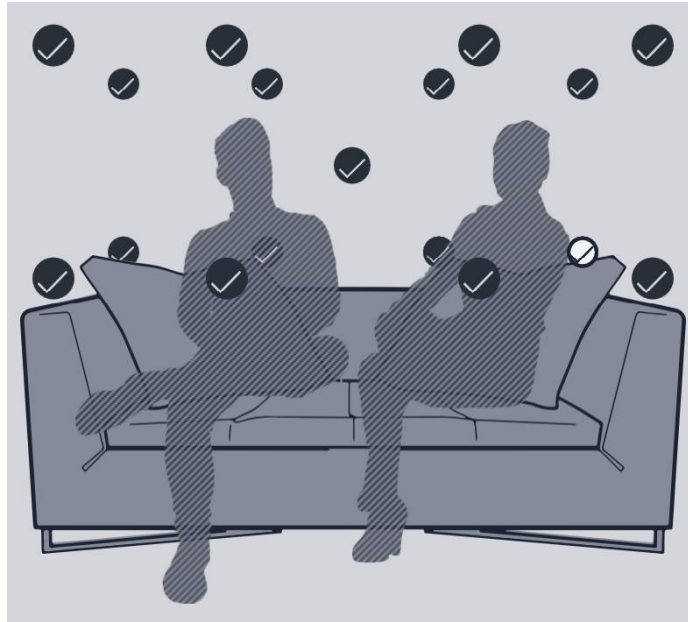

4.12.6 Viewing and redoing measurements

Click on any completed measurement position to select it and display its measured response.

After selecting a completed measurement, the two buttons at the bottom of the screen can be used to re-take the measurement or to delete it:



Once you have completed all measurements, click on the **Proceed to Filter Design** button.

4.13 FILTER DESIGN

Once the full set of measurements has successfully been taken, **DiracLive** has the acoustical information it needs about your loudspeakers and listening room to create the correction filters.

4.13.1 Frequency response display – stereo

The **Filter Design** tab shows the frequency response of one or two channels and the target curve. The following example shows the left channel in mauve and the default target in yellow/black:

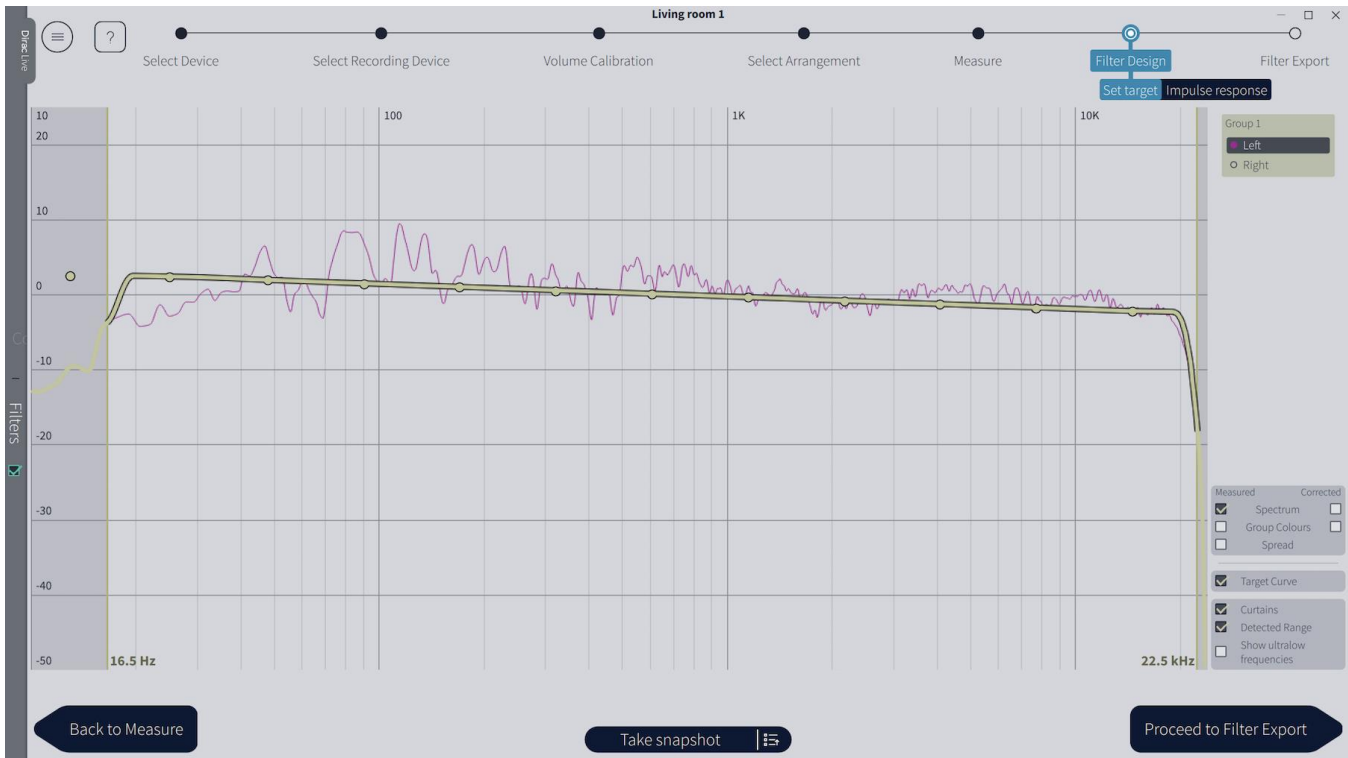

There are two channels listed towards the top right of the window, in a single group:

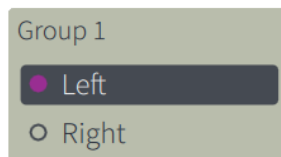

Click on “Left” or “Right” to display the response graphs of a single channel, or on “Group 1” so display both channels. To separate the channels into two groups, click on “Left” or “Right” and drag it out of the darker box. There will then be two groups, each with its own target curve:

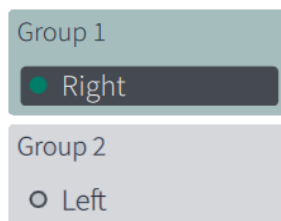

4.13.2 Frequency response display – multichannel

The **Filter Design** tab shows – by default –the average measured response of the left front speaker (mauve line) and the target curve (yellow/black line):

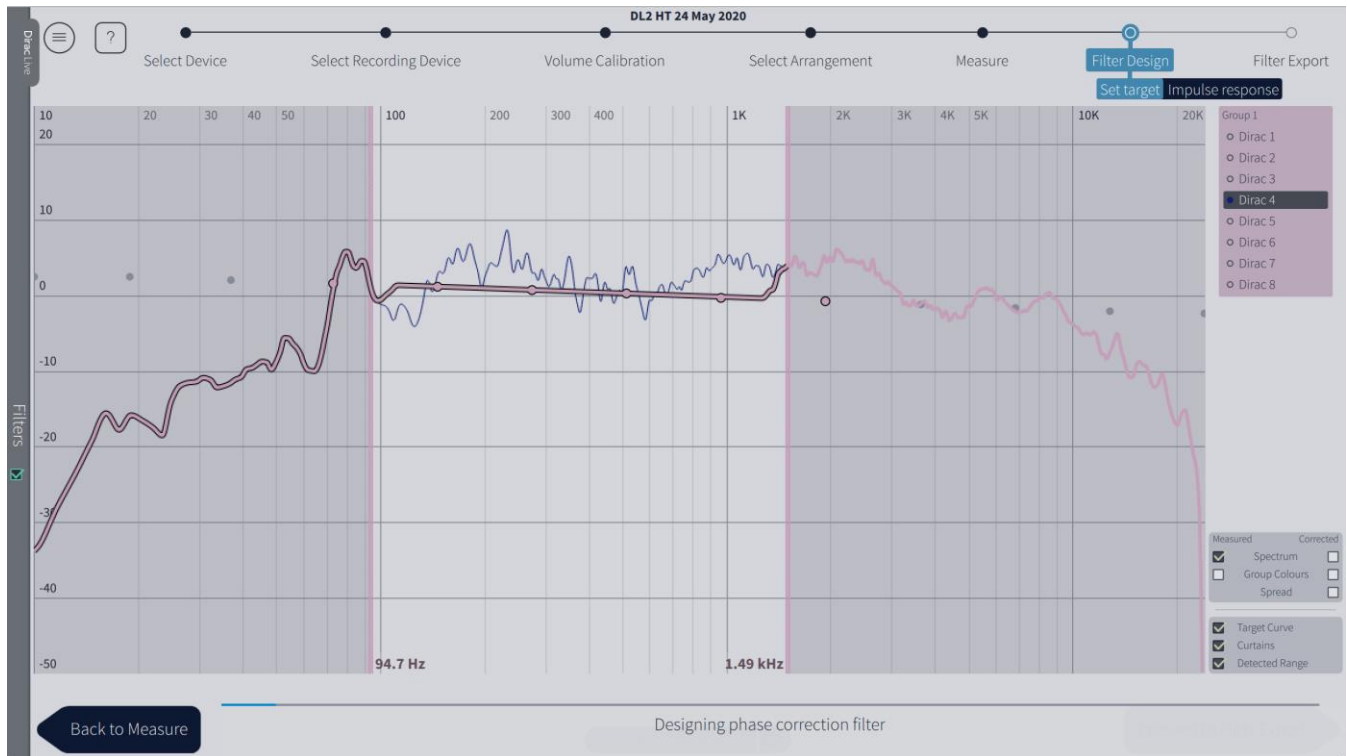

Note: the graph as shown is the default initial display. The “curtains” at about 95 Hz and 1.5 kHz are the automatically detected range of correction. These are incorrect because they include all speakers including some small speakers (so Dirac Live sets the low frequency limit too high) and the subwoofer (so Dirac Live sets the high frequency limit too low).

You will want to:

3. Create groups for each type of speaker (see next page), and
4. Change the curtains to be more appropriate for each group.

4.13.3 Channel selection and groups - multichannel

By default, there is one group for all channels. This means that one target curve and frequency correction range will apply to all channels.

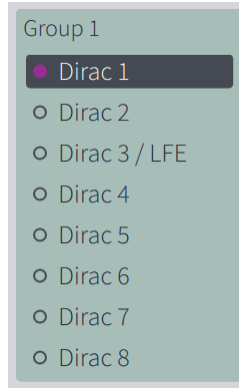

Click on the individual channels names to display the response graphs of that channel, or on the group name to display the response graphs for all channels. You can press the Control button (Windows) or Command key (macOS) while clicking to select more than one channel to display. Click on the group name to display all channels in that group.

For most multichannel applications, you will need more than one group. To separate a channel into a different group, click on the channel name and drag it out of the group box. There will then be two groups. Drag other channels into the new group, or drag channels into the blank space to create another new group.

Here is a typical example for home theater, with groups for the two front channels, the subwoofer, the center, and four surrounds:



To display the response graphs of a group, click on the group name. Or click on the individual channel name to display the graph of just that channel.

4.13.4 Zooming in on the graph

The graph can be zoomed in and out by using the mouse wheel, or with zooming gestures on a touchscreen. To move a zoomed graph, left-click and drag with the mouse, or use the grab and move gesture with a touchscreen. To zoom out to 100%, right-click and select “Reset Zoom”.



4.13.5 Display controls

There are several controls at the right of the graph:

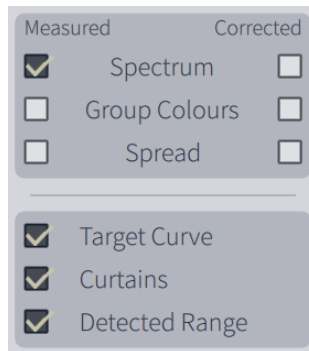

Spectrum

Display the average of all magnitude responses. If the “Measured” checkbox on the left is on, the average of the uncorrected measurements is displayed. If the “Corrected” checkbox on the right is on, the average of the response after correction is displayed.

Group colors

If checked, the graph colors are the same for all channels in a group. This can be individually selected for the measured and corrected responses.

Spread

Display the range of corrected responses as a lighter highlight on the graph. For example:

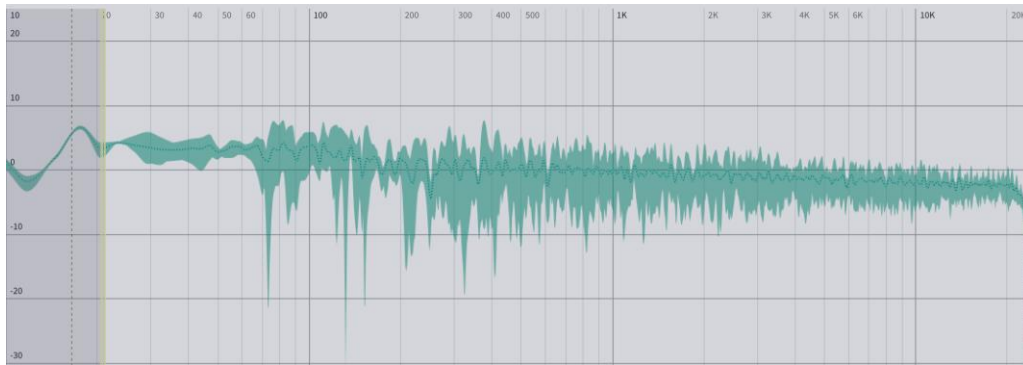

This can be individually selected for the measured and corrected responses.

Target curve

Display the target curve for the displayed group.

Curtains

Display the correction frequency range for the displayed group. This is shown as “curtains” to the left and right of the graph. Note that you will likely want to leave this on, so that you can set the range of correction separately for each group. (For example, you will need a different range for the subwoofer, for certain.)

Detected Range

Display two cursors indicating the frequency range within which Dirac Live has determined the speakers to have reasonable output. Note: at low frequencies, environmental noise can cause this estimate to be incorrect.

4.14 DESIGNING THE TARGET CURVE

The *target curve* is the desired in-room frequency response with the miniDSP processor performing digital room correction. When you first go to the **Filter Design** tab, Dirac Live sets a default target curve, but you have full control over this target curve and can alter it as you wish.

The target curve is edited using *control points*, shown as dots on the target curve:

- Click and drag a control point to move it.
- Right-click on the target curve to add a control point.
- Right-click on a control point to delete it.

The same target curve is used for all channels in a group. So, if the left front and right front channels are in the same group (the default), both channels have the same target curve. To apply a different target curve to each channel, put them in separate groups.

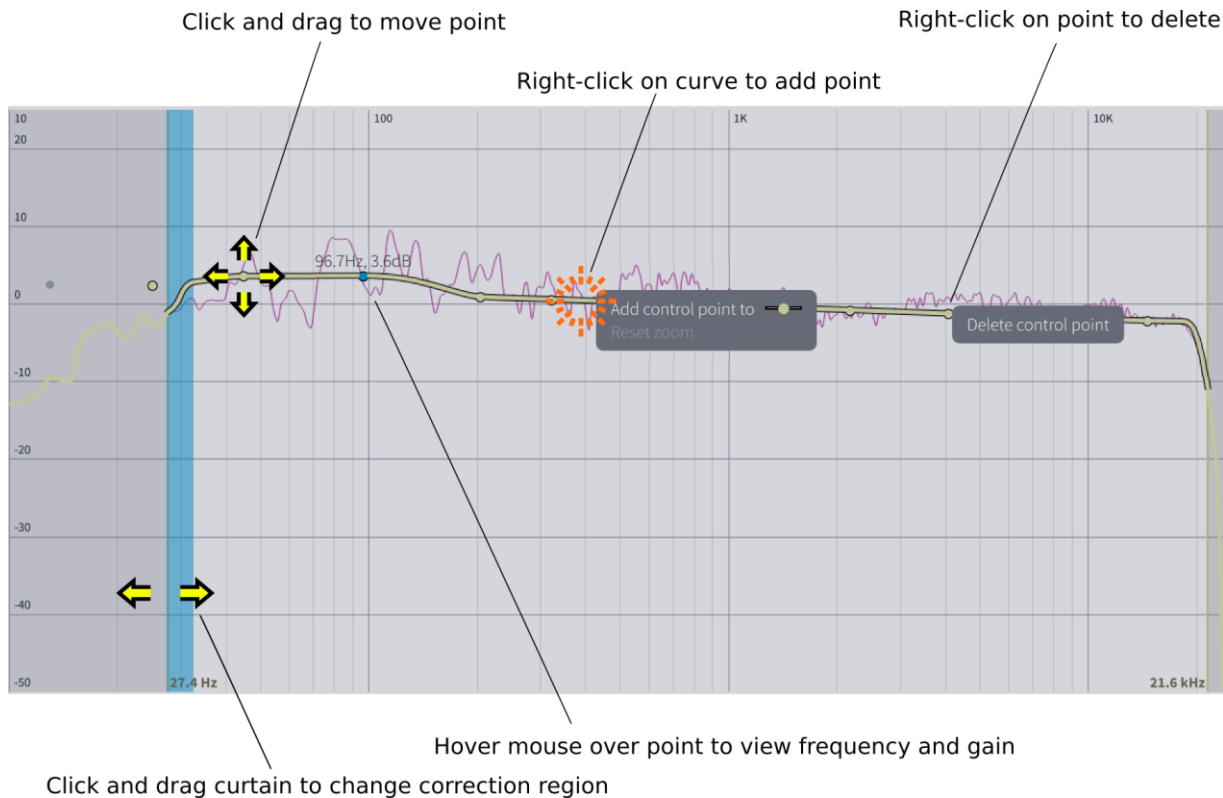

4.14.1 Range curtains

The regions to the left and right of the response graphs that are shaded in a darker grey are excluded from magnitude correction. You can adjust the range of correction for your system and environment by dragging the “curtains” to either side of the graph. For example, low-frequency noise (traffic, machinery) may be present in some environments, so it is best to adjust the frequency range to exclude these frequencies from the correction. Or, you may be happy with the in-room response at higher frequencies, so you can set the frequency region to limit correction to the modal region (up to 300 Hz, in a typical room).

Range curtains are set for each group, set an appropriate range for the frequency response correction. This is a typical example for a “small” speaker:

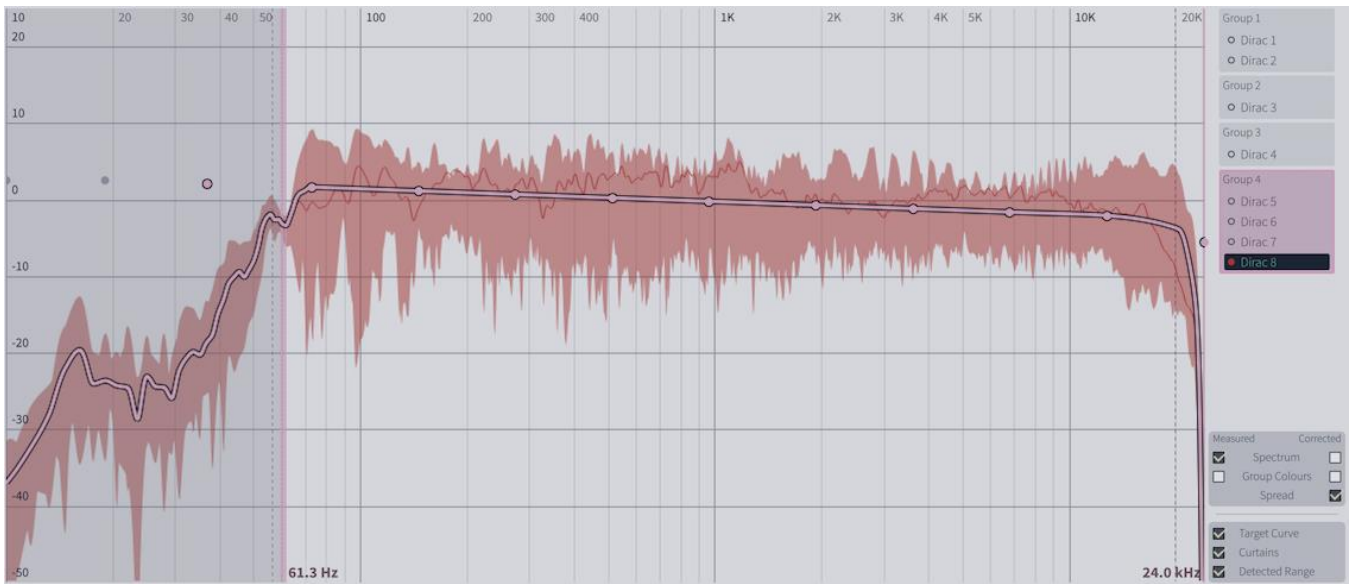

This is a typical example for a subwoofer:

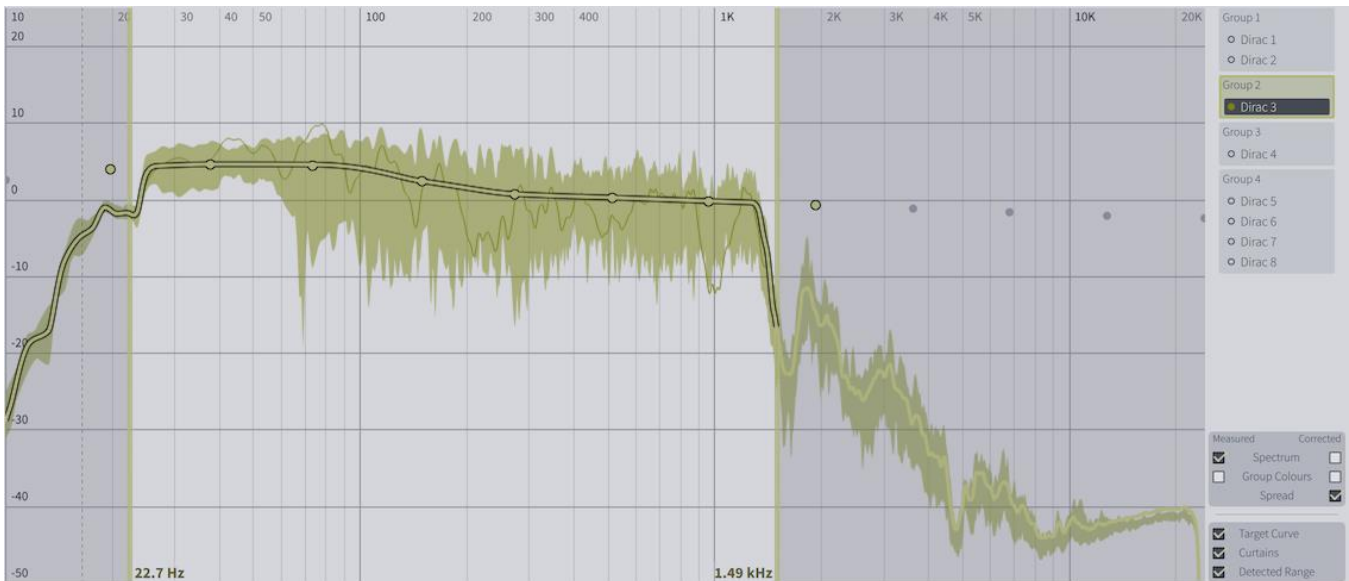

4.14.2 Snapshots

You can save the current set of groups, target curves and curtain frequencies by clicking on the **Take snapshot** button:

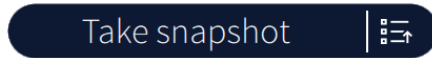

Snapshots will by default be named as the current time. They can be renamed for easier selection later on. Click on the right side of the button and then on the pencil-shaped icon. Enter the name and press the Return key:

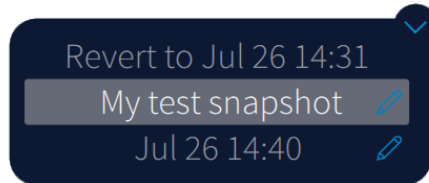

To select a saved snapshot, click on the right side of the button and then click on the desired snapshot.



It is not currently possible to delete a snapshot.

4.14.3 Reset to default

To reset a target curve and the range curtains to the default, drop down the menu from the hamburger icon and select **Set default target curve**, then select the group to reset:

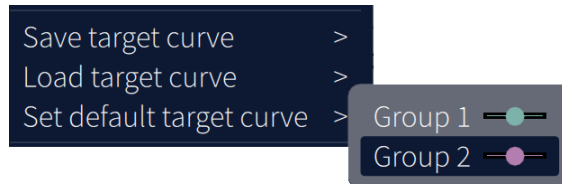

4.14.4 Saving and loading individual target curves

Target curves can be saved and loaded individually for use at a later time or in other projects. To save a target curve, drop down the menu from the hamburger icon and select **Save target curve**, then select the group:

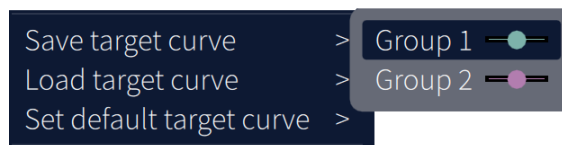

To load a target curve, drop down the menu from the hamburger icon and select **Load target curve**, then select the group:

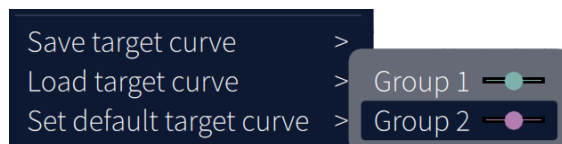

4.14.5 Guidelines for target curve design

Care should be taken to create a target curve that works well with your speakers and room, as well as suiting your personal preferences. Small changes to the target curve can have significant effects on the tonal quality of the system, so it is important that you experiment with different target curves.

If you initially don't achieve a satisfactory result, ensure that you have spread your measurements over a sufficiently large area and with sufficient variation in height. The following guidelines will help you understand how to adjust your target curve.

Low-frequency extension and boost

All loudspeakers have a natural low frequency roll off. Setting the target curve to boost the region below the speaker's natural roll off frequency *may* result in overdriving the speakers, especially with smaller home loudspeakers and depending on your listening habits. A system with capable subwoofers integrated into it, however, will support much more low-frequency output.

High-frequency "tilt"

The target curve is the desired measured response of loudspeakers *in a room*, in contrast to measurements made of a loudspeaker during its design under anechoic (measured in free space) conditions. While high-quality loudspeakers are usually designed for a flat on-axis anechoic response, these same speakers when placed into a listening room will tend to have a downward-sloping or "tilting" response at high frequencies, due to the effects of limited dispersion at high frequencies and greater acoustic absorption.

A completely flat in-room response is therefore usually not desirable and will tend to sound thin or bright. Start with a target curve that follows the natural behavior of your speakers in your room, and then experiment with greater or lesser degrees of tilt in the treble region to obtain the most natural timbral balance.

Low-frequency adjustment

A completely flat response at low frequencies, with complete elimination of peaks due to room modes, may sound light in the bass. Typically, a slight increase in the target curve below 100 Hz will give a more balanced sound.

Magnitude response dips

In some cases, it may be helpful to adjust the target curve to follow dips in the measured response. This can occur where, for example, the listening area is very close to the speakers and the measurements exhibit a dip caused by the vertical response of the speakers themselves. Experiment with a target curve that follows the dips. You may also wish to try a different set of measurement positions.

Ungrouping left and right channels

Usually, each pair of corresponding left and right channels (front left and right, surround left and right, and rear left and right) should be in the same group for target curve adjustment, to ensure that both sides produce the same response across the listening area. In certain unusual circumstances, such as where the magnitude response dip discussed above shows up on only one side, you can try ungrouping channels and making separate adjustments.

4.15 THE IMPULSE RESPONSE GRAPH

The Filter Design menu can be used to display the impulse response:

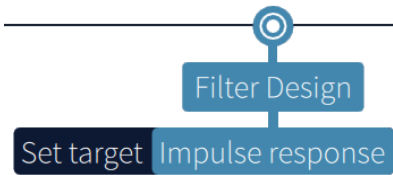

Below is an example impulse response display. This example shows the original impulse response at the top and the corrected and delayed impulse response below.



There are several controls at the right of the graph:

Measured	Corrected
<input checked="" type="checkbox"/> Impulse response	<input checked="" type="checkbox"/>
<input type="checkbox"/> Group Colours	<input type="checkbox"/>

<input checked="" type="checkbox"/> Show latency
<input type="checkbox"/> Separate curves
<input type="checkbox"/> Dense grid
<input type="checkbox"/> Cursor coordinates

Impulse response

Display the impulse response corresponding to the average of all magnitude responses. If the “Measured” checkbox on the left is on, the impulse response corresponding to the measurements is displayed. If the “Corrected” checkbox on the right is on, the impulse response corresponding to the corrected response is displayed.

Group colors

If checked, the graph colors are the same for all channels in a group. This can be individually selected for the measured and corrected impulse responses.

Show latency

Show the impulse responses including actual delay through the miniDSP processor.

Separate curves

Show the measured and corrected responses on separate graphs. See the previous page for an example.

Dense grid

Display additional grid lines on the graph.

Cursors coordinates

Display a vertical cursor line where the mouse is, together with the time delay and impulse response value at the cursor position.

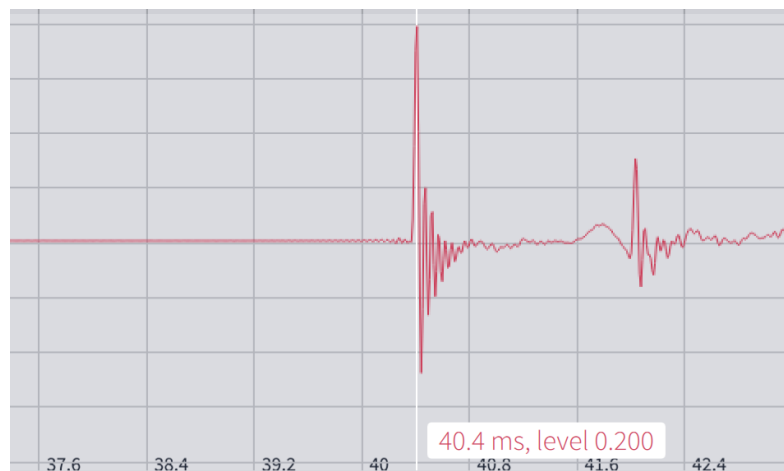

4.16 SAVING AND LOADING PROJECTS

To save the project, click on the hamburger icon and select **Save project**.

To load the project, click on the hamburger icon and select **Load project**.

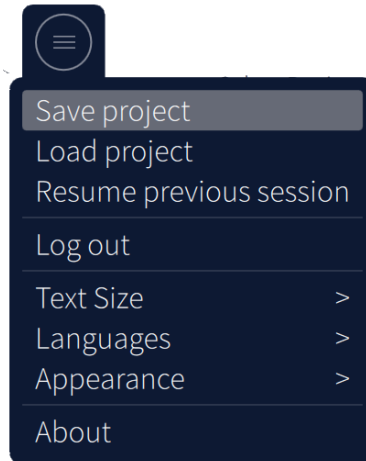

If you save the project and you are not logged into your Dirac account, you may not be able to load that project again. Be sure to log into your Dirac account before saving the project.



Multichannel processors only: If you have changed the speaker configuration (the Dirac Channel Configuration menu in the plugin), you may not be able to load the project.

4.17 FILTER EXPORT

The **Filter Export** tab initially shows four empty “slots” for filter sets (a filter set is one filter for each channel). To load a filter into a slot, click on the slot. At the right, enter the name and description and click **Export filter**:

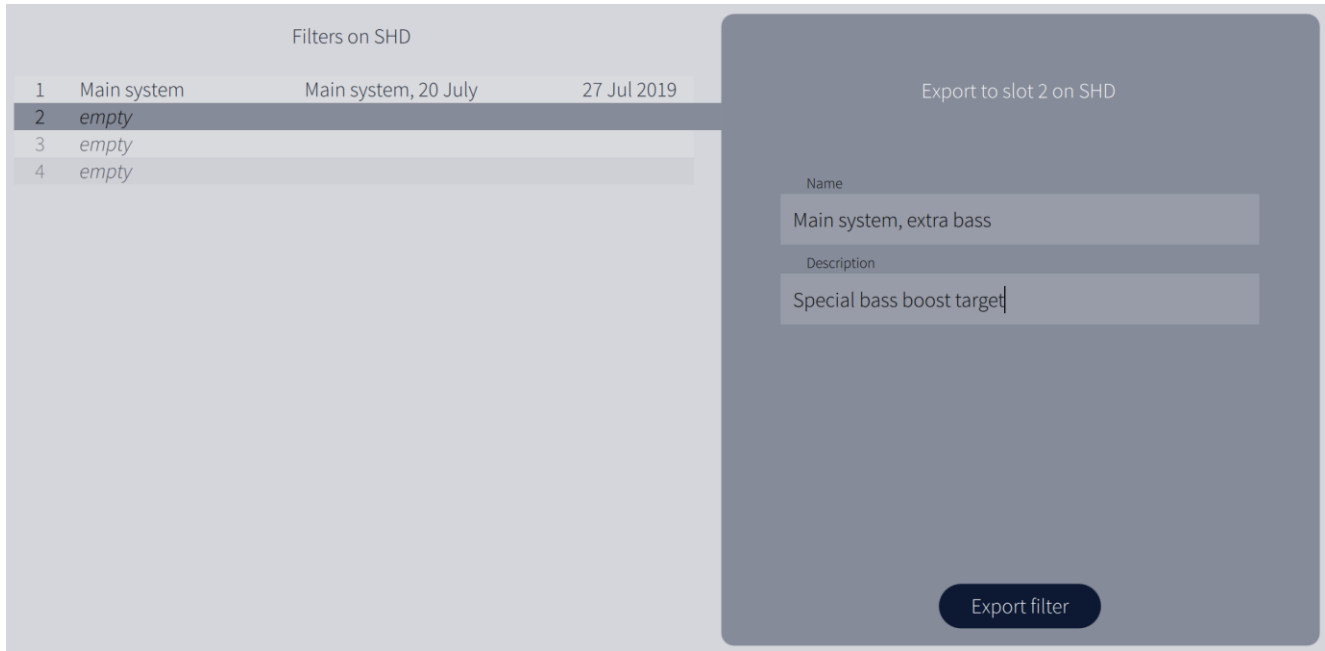

A circular progress indicator will indicate that the filter is being downloaded to the processor. When filter export is complete, the UI will return to the **Measure** tab so you can adjust the target curve to create a different set of filters. Return to the **Filter Export** tab to view the list of loaded filters:

Filters on SHD			
1	Main system	Main system, 20 July	27 Jul 2019
2	Main system, extra ...	Special bass boost target	27 Jul 2019
3	Quiet listening	Target set for quiet listening	27 Jul 2019
4	empty		

To overwrite a filter slot, select a slot with a loaded filter and click on **Replace existing filter**.

Replace existing filter



If you have set up any back-end processing (subwoofer, active speaker, etc.), be sure to load the filter into the same slot as the preset selected when running the Dirac Live calibration measurements.



It is not possible to clear a filter slot from within the DiracLive application. However, you can clear all four filter slots with the plugin. Quit DiracLive and in the plugin, click Connect. Then use the Restore All to Default menu option.

To audition different filters while still running the DiracLive application, use the filter selection checkboxes in the sidebar to choose the filter set to listen to:

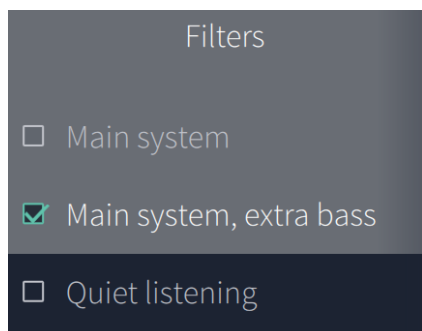

Note: selecting a filter here will also select the matching configuration preset in the back-end processing.

5 ADDITIONAL INFORMATION

5.1 SOLVING CONNECTIVITY ISSUES



If you are experiencing any connectivity issues, the **first thing** to do is double-check that your processor's plugin and firmware are up to date. Refer to your processor's User Manual.

5.1.1 No Internet connection

Various components of the software require an Internet connection. In particular:

- The DiracLive application may refuse to generate filters or reload saved projects if it cannot connect to the Dirac Research servers.

In the event that the software is not operating correctly, check that your computer is connected to the Internet and try again.

5.1.2 The miniDSP processor is not detected

5.1.2.1 Port conflict

The DiracLive application use network ports 11113, 11115, 11117, 5000, and 8080. The last two in particular are needed for the bridging app to communicate between DiracLive and the miniDSP processor.

If the miniDSP processor is not detected:

1. Double-check the USB cabling from your computer to the processor. If you are using extenders or hubs, remove them and make a short direct connection. Try different USB ports on your computer.
2. Check that your computer's firewall isn't blocking any of the ports listed above.
3. Check that other applications aren't using these ports.
 - a. On Windows 10, open a command prompt and type the following commands:

```
netstat -ano | findstr 8080
netstat -ano | findstr 5000
```
 - b. On macOS, open Terminal and type the following commands:

```
sudo lsof -n -iTCP:8080 | grep LISTEN
sudo lsof -n -iTCP:5000 | grep LISTEN
```

If there is no output, the ports are not in use. If there is output, then try to close the application that is using them. Typically, software that provides a local web server is likely to be the one blocking port 8080.

5.1.2.2 Installation path issues

Changing the installation path away from the default may cause issues with DiracLive being unable to find the miniDSP processor. If you did not install with the default settings:

1. Quit the DiracLive application.
2. Quit the miniDSP plugin.
3. Delete the **preferences.xml** file for the plugin. The location of this file is as shown below, where [PLUGIN] is the plugin name e.g. **SHD** or **2x4 HD**.
 - a. Windows: Documents\MiniDSP\[PLUGIN]\user\
b. Mac: Documents/MiniDSP/[PLUGIN]/user/
4. Start the plugin again and click on the Start Dirac Live Software button.

5.1.2.3 Unpaired devices (Windows 10)

Some customers have reported that changing the following setting enabled DiracLive to find their processor. Go to Settings -> Privacy -> Other Devices and enable "Communicate with unpaired devices."

Other devices

Communicate with unpaired devices

Let your apps automatically share and sync info with wireless devices that don't explicitly pair with your PC, tablet, or phone



5.2 TROUBLE-SHOOTING AUDIO ISSUES

No sound during volume calibration

If you get no sound while on the Volume Calibration tab of DiracLive, first make sure that you increase the volume slider in the UI (the leftmost one).

If there is still no sound, double-check that output cabling is connected to the right connectors on the rear panel and to the correct inputs on downstream equipment. Make sure that downstream equipment (e.g. amplifiers) is not muted, turned down, or turned off.

No sound during playback

If you get no sound while playing music, double-check the following items. Depending on the specific processor, you may be able to do this with the aid of the level meters in the miniDSP plugin (quit the DiracLive app before clicking on the Connect button in the plugin).

1. Check which input source you have selected.
2. Check the connection and cabling between the source(s) and the processor.
3. Check the master volume setting.
4. Check that the processor is not muted.
5. Check your Routing and make sure that you are routing inputs through to outputs.
6. If your processor has crossovers, check your crossover settings. (In particular, some processors have a default high pass filter set at 1 kHz on some channels as a safety measure for 2-way active speakers. If using these channels for subwoofers, the high pass filters must be bypassed.)
7. Check that output cabling is connected to the correct connectors on the rear panel and to the correct inputs on downstream equipment (e.g. amplifiers).
8. Check that downstream equipment (e.g. amplifiers) is not muted, turned down, or turned off.

Strange soundstage

If the soundstage width is very narrow, check that you have not summed left **and** right input channels and routed the sum to left and right speakers. This will result in a mono signal and hence a narrow soundstage.

If the soundstage is “weird”, check the routing and crossover settings and make sure that left and right are consistent. If you are implementing an active speaker, double-check all connections on the rear panel.

Distortion

If audio playback is distorted, you may have too much gain internal to the DSP. Dirac Live can apply up to 10 dB of gain, so the output level should be kept lower than -10 dB to *guarantee* that there is no distortion with a full-scale input signal.

This issue typically occurs when volume control is being done downstream of the miniDSP processor. If so, set the processor master volume at -10 dB¹, and then use the downstream equipment to control volume.

¹ For the DDRC-22D, set Attenuation in the DDRC-22 Utility to -10 dB.



5.3 LEGACY SUPPORT MANUALS

Some miniDSP processors can still work with the earlier version of Dirac Live Calibration Tool (“Dirac Live 1”). The list of Legacy Support manuals is below. These older versions will be supported only for a limited period.

Stereo platforms

- [DDRC-24 User Manual Legacy Support](#)
- [DDRC-22D User Manual Legacy Support](#)

Multichannel platforms

- [DDRC-88A User Manual Legacy Support](#)
- [DDRC-88D User Manual Legacy Support](#)
- [C-DSP 8x12 DL User Manual Legacy Support](#)

Note: the following products support only the current version of Dirac Live, there is no support for older versions:

- SHD Series
- miniDSP Flex
- Harmony DSP 8x12