



SHD Series

STEREO HIGH-DEFINITION NETWORK STREAMER AND HIGH-DEFINITION AUDIO PROCESSOR

WITH **DIRAC LIVE® ROOM CORRECTION TECHNOLOGY**

User Manual



SHD

SHD Power

SHD Studio



Revision history

Revision	Description	Date
2.0	Preliminary version of this manual that incorporates Dirac Live 2. (See the SHD Series User Manual Legacy Support version for earlier change history.)	12 December 2019
2.1	Catalina support. Corrections throughout. Still marked preliminary.	27 January 2020
2.3	Added user preferences.	15 April 2020
2.4	Corrections and updates for new firmware.	30 April 2020
2.5	Dirac Live documentation moved to separate miniDSP Dirac Live User Manual .	30 June 2020
2.6	Remove legacy support (“Dirac Live 1”)	17 December 2020
2.7	Adobe AIR and Flash no longer needed	1 February 2021
2.8	Updates to Volumio UI	8 February 2021
2.10	Revisions to signal flow and sub integration for new app notes	11 June 2021
2.12	Added Volumio factory reset	7 Sept 2021
2.13	Roon ready	30 November 2021
2.14	Volumio and Roon update	28 Feb 2022

SUPPORTED OS

 **Windows 10** or later

 **macOS Mojave** or later

CONTENTS

Contents	3
IMPORTANT INFORMATION	6
1 Product Overview	9
1.1 Dirac Live	10
1.2 Typical usage	11
2 Hardware Overview	12
2.1 SHD	12
2.2 SHD Power	13
2.3 SHD Studio	14
2.4 Front panel	15
3 Software Installation	16
3.1 Windows.....	16
3.1.1 Download and install the Dirac Live application	16
3.1.2 Download the miniDSP software.....	16
3.1.3 Install the miniDSP software	17
3.2 macOS.....	18
3.2.1 Download and install the Dirac Live application	18
3.2.2 Download the miniDSP software.....	18
3.2.3 Install the miniDSP software	19
4 Playing Audio	20
4.1 Digital sources	20
4.2 Analog sources (SHD only).....	20
4.3 Network audio.....	21
4.3.1 Ethernet connection	21
4.3.2 Wi-Fi connection.....	22
4.3.3 The Volumio web interface	24
4.3.4 Playing audio from USB stick	26
4.3.5 Roon.....	27
4.3.6 TIDAL and Qobuz	30
4.3.7 Spotify.....	31
4.3.8 Accessing multiple processors.....	32
4.4 USB Audio	33
4.4.1 macOS.....	33
4.4.2 Windows.....	35
5 Remote control	37
5.1 Using the miniDSP remote	37
5.2 Using the Volumio web interface	38
5.3 Programming a Logitech Harmony remote	40
5.4 Android/iOS control app.....	40
5.5 Alexa voice control	41
5.6 Learning third-party remote codes	41
5.7 Legacy miniDSP remote.....	42

6	The SHD Plugin	43
6.1	Plugin user interface.....	43
6.2	Connecting to the processor	44
6.3	Key features.....	45
6.3.1	Master control	45
6.3.2	Configuration/preset selection.....	46
6.3.3	Inputs.....	46
6.3.4	Input selection	46
6.3.5	Routing matrix	47
6.3.6	Outputs.....	47
6.4	Setting user preferences	48
6.4.1	Display Settings.....	48
6.4.2	Selectable Input Sources	49
6.4.3	Speaker Impedance (SHD Power only).....	49
6.5	Signal flow	50
6.6	Configuration for subwoofer integration	51
6.6.1	Connect the subwoofer	51
6.6.2	Configure the plugin	51
6.6.3	Check subwoofer integration (optional)	53
6.7	Other configurations	55
6.7.1	Dual subwoofers.....	55
6.7.2	Stereo supporting woofers.....	56
6.7.3	Two-way active speaker	57
7	Dirac Live Calibration	58
8	Plugin Reference	59
8.1	Input channel status.....	59
8.2	Routing	59
8.3	Output channels	60
8.3.1	Channel label	60
8.3.2	Level metering and gain adjustment.....	60
8.3.3	Parametric EQ.....	61
8.3.4	Crossover.....	63
8.3.5	Compressor.....	65
8.3.6	Invert and mute	65
8.3.7	Time delay	66
8.4	Custom biquad programming.....	66
8.4.1	What's a biquad?.....	66
8.4.2	Using custom biquad programming	67
8.4.3	Biquad design software	68
8.5	Working with configurations.....	69
8.5.1	Online and offline mode.....	69
8.5.2	Selecting a configuration.....	69
8.5.3	Saving and loading configurations.....	70
8.5.4	Relationship with Dirac Live	70
8.5.5	Restoring to defaults	71
8.6	Keyboard shortcuts	71

9	Additional Information	72
9.1	Specifications.....	72
9.1.1	All SHD Series processors	72
9.1.2	SHD	73
9.1.3	SHD Power	74
9.1.4	SHD Studio	75
9.2	Plugin and DSP upgrade	76
9.3	Volumio software update.....	77
9.4	Volumio settings/factory reset.....	78
9.4.1	Factory reset (settings only)	78
9.4.2	Factory reset (settings and installation)	78
9.5	Firmware upgrade	79
9.5.1	Windows.....	79
9.5.2	macOS.....	81
9.6	Finding the SHD’s IP address	83
9.7	Solving connectivity issues	85
9.7.1	No Internet connection	85
9.7.2	SHD Series processor not detected	85
9.8	Trouble-shooting audio issues.....	86
9.9	Obtaining support.....	87
9.10	Open source licenses.....	87



IMPORTANT INFORMATION

Please read the following information before use. In case of any questions, please contact miniDSP via the support portal at support.minidsp.com.

System Requirements

To configure the miniDSP audio processor, you will require a Windows PC or Apple Mac computer with the following minimum specification:

Windows

- **Microsoft® Windows® 10 or 11**, latest version with all updates
- At least a dual core i3, i5, or i7 processor
- At least 2 GB RAM (4 GB preferred)
- Two free USB 2.0 ports
- Internet connection

macOS

- **macOS 10.14 Mojave or later**, latest version with all updates
- At least a dual core i3, i5, or i7 processor, or an ARM processor (M1/Pro/Max)
- At least 2 GB RAM (4 GB preferred)
- Two free USB 2.0 ports
- Internet connection

Disclaimer/Warning

miniDSP cannot be held responsible for any damage that may result from the improper use of this product or incorrect configuration of its settings. As with any other product, we recommend that you carefully read this manual and other technical notes to ensure that you fully understand how to operate this product. The miniDSP audio processor is a powerful tool, and misuse or misconfiguration, such as incorrectly set gains or excessive boost, can produce signals that may damage your audio system.

As a general guideline, you should perform the initial configuration of the miniDSP audio processor before enabling audio through any connected output device or amplification. Doing so will help ensure that the software is correctly configured.

Finally, note that the miniDSP audio processor is a very flexible device, and many of the questions we receive at the tech support department are already answered in this user manual and in the online [application notes](#) on the miniDSP.com website. So please take the time to carefully read this user manual and the online technical support. Thanks for your understanding!

Warranty Terms

miniDSP Ltd warrants this product to be free from defects in materials and workmanship for a period of one year from the invoice date. Our warranty does not cover failure of the product due to incorrect connection or installation, improper or undocumented use, unauthorized servicing, modification or alteration of the unit in any way, or any usage outside of that recommended in this manual. If in doubt, contact miniDSP prior to use.

FCC Class B Statement

This device complies with Part 15 of the FCC Rules. Operation is subject to the following two conditions:

- This device may not cause harmful interference.
- This device must accept any interference received, including interference that may cause undesired operation.

Warning: This equipment has been tested and found to comply with the limits for a Class B digital device, pursuant to Part 15 of the FCC Rules. These limits are designed to provide reasonable protection. This equipment generates, uses and can radiate radio frequency energy and, if not installed and used in accordance with the instructions, may cause interference to radio communications. However, there is no guarantee that interference will not occur in a particular installation. If this equipment does cause harmful interference to radio or television reception, which can be determined by turning the equipment off and on, the user is encouraged to try to correct the interference by one or more of the following measures:

- Reorient or relocate the receiving antenna.
- Increase the separation between the equipment and receiver.
- Connect the equipment into an outlet on a circuit different from that to which the receiver is connected.
- Consult the dealer or an experienced radio/TV technician for help.

Notice: Shielded interface cable must be used in order to comply with emission limits.

Notice: Changes or modification not expressly approved by the party responsible for compliance could void the user’s authority to operate the equipment.

CE Mark Statement

The miniDSP SHD Series processor has passed the test performed according to European Standard EN 55022 Class B.

A note on this manual

This User Manual is designed for reading in both print and on the computer. If printing the manual, please print double-sided. The embedded page size is 8 ½” x 11”. Printing on A4 paper will result in a slightly reduced size.

For reading on the computer, we have included hyperlinked cross-references throughout the manual. In addition, a table of contents is embedded in the PDF file. Use the View menu (Preview on Mac) or the bookmarks sidebar (Adobe reader on Mac and Windows) to view this table of contents.

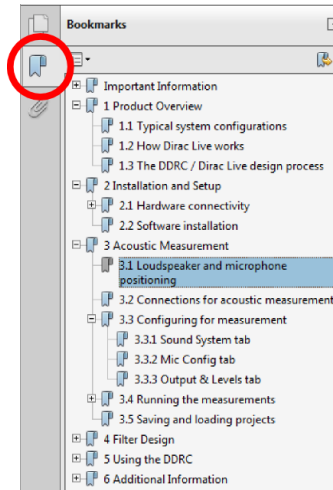

Adobe Reader on Windows

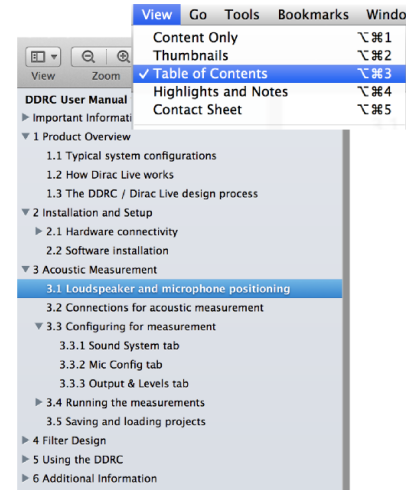

Preview on Mac



Acknowledgments

Dirac® and Dirac Live® are trademarks owned by Dirac Research AB.

ASIO® is a registered trademark of Steinberg Media Technologies GmbH.

ROON READY

Being Roon Ready means that miniDSP uses Roon streaming technology, for an incredible user interface, simple setup, rock-solid daily reliability, and the highest levels of audio performance, without compromise.

1 PRODUCT OVERVIEW

Thank you for purchasing a miniDSP SHD Series high-resolution¹ room correction processor powered by Dirac Live®, the world’s premier room correction solution. The new SHD Series offers a wealth of input-output options, network streaming services including Tidal, Qobuz, and Spotify, network players such as Roon, powerful back-end processing for subwoofer integration and active speakers and of course, Dirac Live.

The SHD Series encompasses a range of models for optimum matching to different user needs. The full-featured **SHD** is perfect for use in a separates system, acting as network streamer and digital preamplifier with room correction. The compact integrated **SHD Power** matches lifestyle systems, but with 120W of power on tap and two subwoofer outputs. Finally, the **SHD Studio** is an all-digital I/O model that is perfect for use in modern all-digital systems, studios, and professional applications.

Inputs

Analog RCA
Analog XLR

SPDIF, TOSLINK, AES-EBU
USB Audio
Network Audio

Outputs

Analog RCA (4 channels)
Analog XLR (4 channels)

SPDIF x 2 (4 channels)



SHD

Full-featured network streamer with Dirac Live digital room correction. Lots of analog and digital inputs and outputs, plus powerful backend/crossover processing.

Inputs

SPDIF, TOSLINK, AES-EBU
USB Audio
Network audio

Outputs

Speaker 120W (2 channels)
Subwoofer RCA (2 channels)
AES/EBU x 2 (4 channels)



SHD Power

Integrated amplifier and network streamer. Includes Dirac Live stereo room correction, 120W power amplifier, analog subwoofer outputs, digital out, and powerful backend/crossover processing.

Inputs

SPDIF, TOSLINK, AES-EBU
USB Audio
Network audio

Outputs

SPDIF x 2 (4 channels)
AES/EBU x 2 (4 channels)



SHD Studio

Specialized network streamer with digital I/O. Includes Dirac Live stereo room correction, 4-channel digital out, and powerful backend/crossover processing.

¹ The miniDSP SHD Series processors operate with 32-bit 96 kHz resolution.

1.1 DIRAC LIVE

Each SHD Series processor executes Dirac Live® digital room correction, from [Dirac Research](#). Dirac Live’s mixed-phase filtering technology will improve the imaging of your system, minimize the effects of room modes and resonances, and improve dynamics and clarity.

To accomplish its remarkable improvement in listening quality, **Dirac Live** steps you through the procedure for taking measurements around your listening area. Dirac Live® employs a sophisticated analysis algorithm to make the optimal correction across the *whole* listening area, not just at a single point. The user has full control over the target frequency response. Measurements are taken with a calibrated acoustic measurement microphone, the miniDSP UMIK-1.²

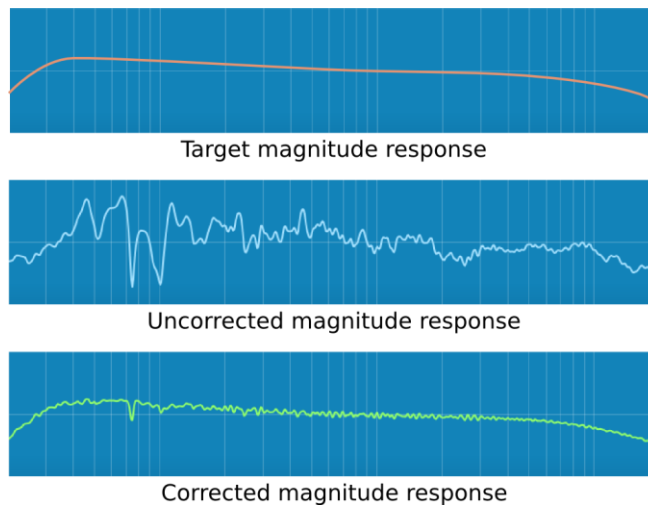

In addition to correcting magnitude response, Dirac Live® corrects the system’s *impulse response*, which reflects how the system responds to a sharp transient such as a drumbeat. Reflections, diffraction, resonances, misaligned drivers, and so on, all combine to smear out the transient. Correcting the impulse response makes the speaker in the room behave much more like an ideal loudspeaker. The impulse response is a critical factor for accurate sound-staging, clarity and bass reproduction.

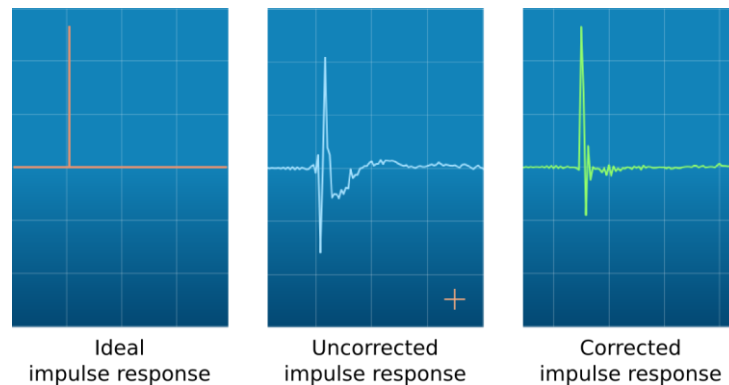

Dirac Live calibration is described in the separate [miniDSP Dirac Live User Manual](#).

² A UMIK-1 is included in the standard purchase price of each SHD Series processor.

1.2 TYPICAL USAGE

The SHD Series processors replace multiple components in a conventional audio system – preamplifier, network streamer, DAC and room correction are all bundled into a single economical unit. Each also has its own unique strengths: analog I/O (SHD), compact size (SHD Studio), and inbuilt power amplification (SHD Power). Figure 1 and Figure 2 illustrate how an SHD Series processor can simplify your audio system.

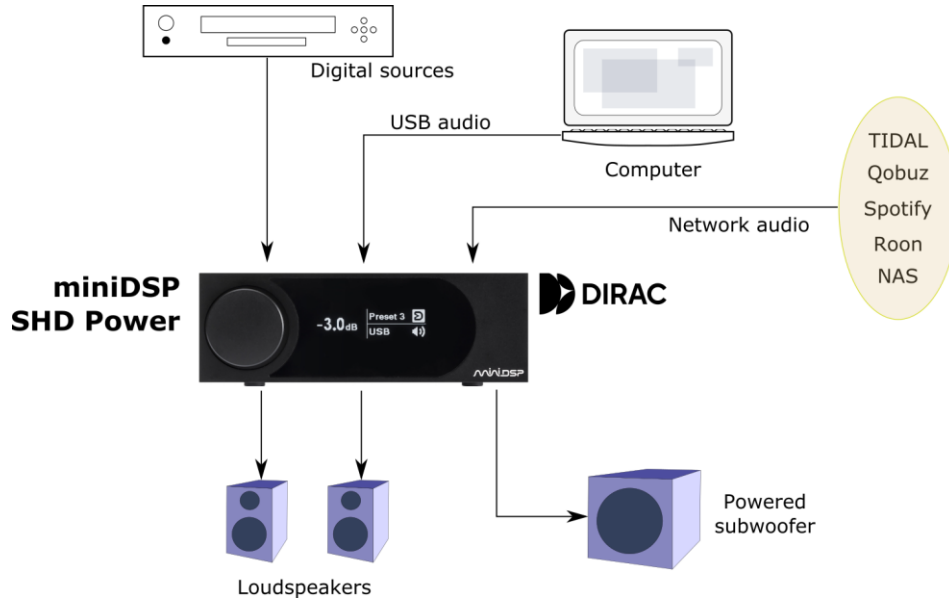

Figure 1. Typical audio system configuration using the miniDSP SHD Power

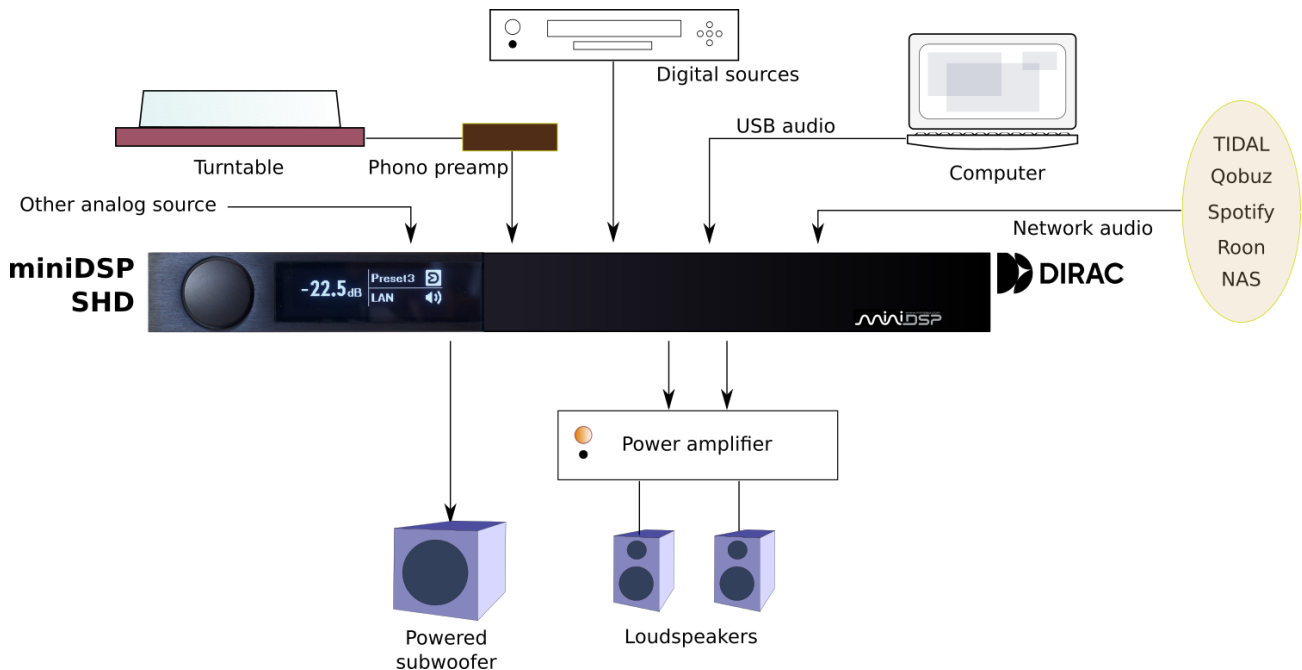
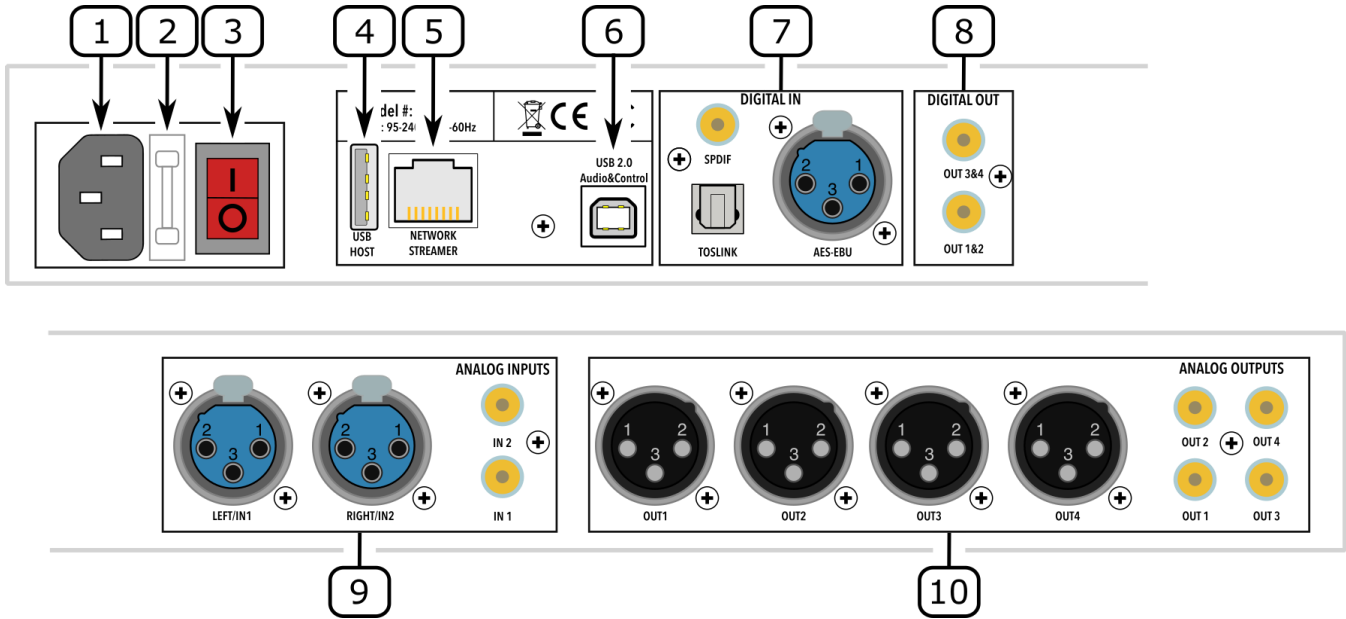

Figure 2. Typical audio system configuration using the miniDSP SHD

2 HARDWARE OVERVIEW

2.1 SHD



1. **Power inlet.** Connect a standard IEC C13 cable here. The mains supply voltage can be in the range 95 to 240 VAC, 50 to 60 Hz.
2. **Fuse holder.** If the fuse needs replacing, remove the power cable. Then use a small flat-bladed screwdriver to lever out the fuse and fuse holder. Replace the fuse with a 250V rated 4A fuse and push the fuse holder firmly back in.
3. **Power switch.** Turns power to the SHD on and off.
4. **Host port** for USB music stick or Wi-Fi adapter.
5. **Ethernet port** for network music streaming.
6. **USB port** for control and audio streaming. Connect to an available USB port on your computer.
7. **Digital inputs.** Connect digital sources here using optical (TOSLINK SPDIF), coax (RCA SPDIF), or AES/EBU (XLR). Sample rates from 32 up to 216 kHz are supported. The three digital inputs can be individually selected with the front panel encoder or the remote control.
8. **Digital outputs.** Connect external DACs or other digital equipment using RCA SPDIF. These outputs each carry a stereo signal. The data format is 24-bit 96 kHz. Connected equipment must therefore be able to accept a 24-bit 96 kHz input signal. Note: if using two different DACs, you may need to adjust the time delay on the output channels accordingly.
9. **Analog inputs.** Connect one or two analog sources here, using balanced XLR or unbalanced RCA connections. The two analog inputs can be individually selected with the front panel encoder or the remote control. See Specifications for maximum input voltages.
10. **Analog outputs.** Connect power amplifiers here using balanced XLR or unbalanced RCA connections. See Specifications for maximum output voltages.

2.2 SHD POWER

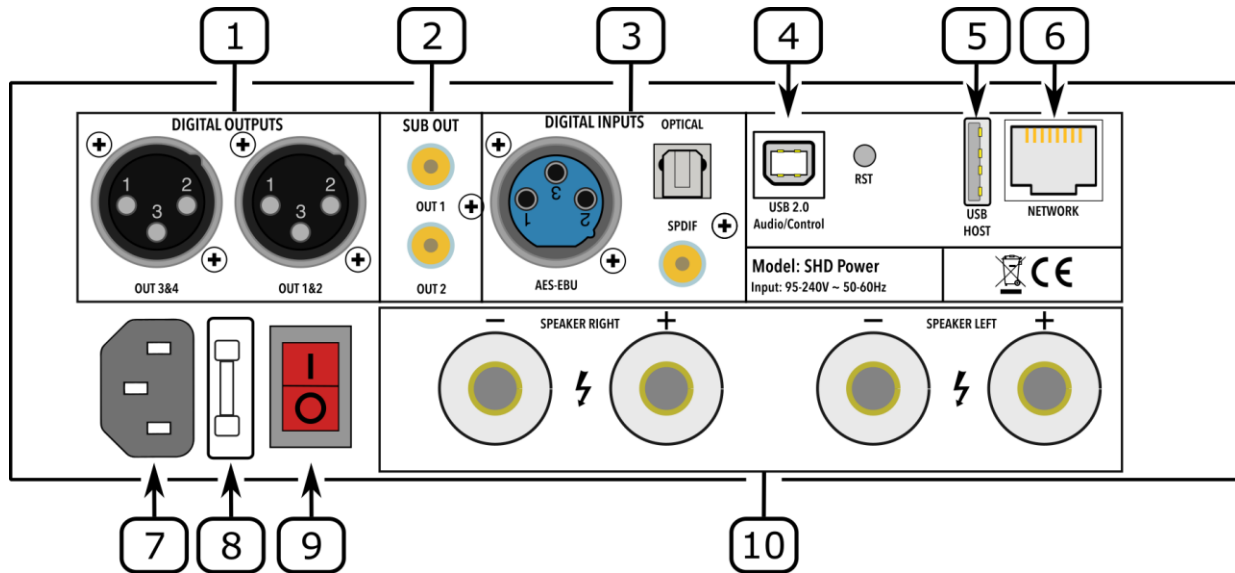

1. **Digital outputs.** Connect downstream digital equipment with AES-EBU cables. These outputs each carry a stereo signal. The data format is 24-bit 96 kHz. Connected equipment must therefore be able to accept a 24-bit 96 kHz input signal.
2. **Subwoofer outputs.** Connect one or two powered subwoofers here.
3. **Digital inputs.** Connect digital sources using optical (TOSLINK SPDIF), coax (RCA SPDIF), or AES/EBU (XLR). Sample rates from 32 up to 216 kHz are supported. The three digital inputs can be individually selected with the front panel encoder or the remote control.
4. **USB port** for control and audio streaming. Connect to an available USB port on your computer.
5. **Host port** for USB music stick or Wi-Fi adapter.
6. **Ethernet port** for network music streaming.
7. **Power inlet.** Connect a standard IEC C13 cable here. The mains supply voltage can be in the range 95 to 240 VAC, 50 to 60 Hz.
8. **Fuse holder.** If the fuse needs replacing, remove the power cable. Then use a small flat-bladed screwdriver to lever out the fuse and fuse holder. Replace the fuse with a 250V rated **8A** fuse and push the fuse holder firmly back in.
9. **Power switch.** Turns main power to the SHD Power on and off.
10. **Speaker outputs.** Connect directly to speakers using conventional speaker cables with spade or banana terminations.

2.3 SHD STUDIO

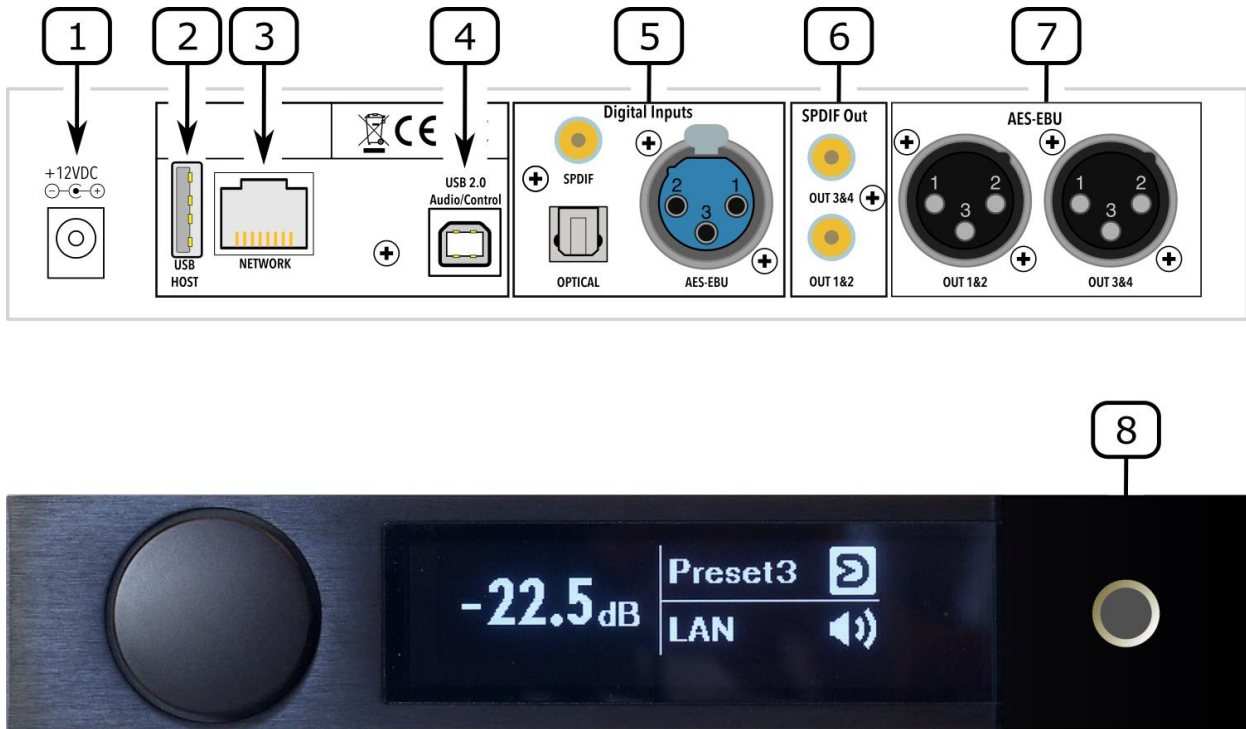

1. **DC power inlet.** Connect the supplied 12 VDC power supply here.
2. **Host port** for USB music stick or Wi-Fi adapter.
3. **Ethernet port** for network music streaming.
4. **USB port** for control and audio streaming. Connect to an available USB port on your computer.
5. **Digital inputs.** Connect digital sources using optical (TOSLINK SPDIF), coax (RCA SPDIF), or AES/EBU (XLR). Sample rates from 32 up to 216 kHz are supported. The three digital inputs can be individually selected with the front panel encoder or the remote control.
6. **SPDIF Out.** Connect downstream digital equipment, such as DACs, active speakers with a digital input, and A/V equipment with RCA cables. These outputs each carry a stereo signal. The data format is 24-bit 96 kHz. Connected equipment must therefore be able to accept a 24-bit 96 kHz input signal. Note: if using two different DACs, you may need to adjust the time delay on the output channels accordingly.
7. **AES-EBU.** Connect downstream digital equipment with XLR AES-EBU cables. These outputs each carry a stereo signal. The data format is 24-bit 96 kHz. Connected equipment must therefore be able to accept a 24-bit 96 kHz input signal.
8. **Headphone output.** The signal on this output jack follows output channels 1 and 2.

2.4 FRONT PANEL

The front panel display shows current volume, selected preset, input source, mute, and Dirac Live status.

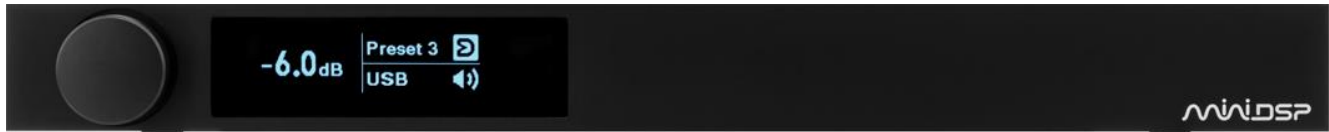

- To change the volume, rotate the encoder knob. Volume changes in 0.5 dB steps. Minimum volume is -127.5 dB and maximum volume is 0.0 dB.
- To mute output, press and hold the encoder knob. When the display changes to show “Mute?,” release the knob. To unmute, repeat this process.



Not muted

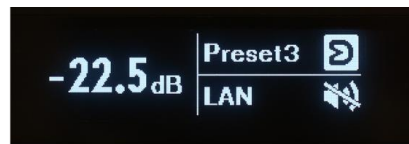

Muted

- To change the selected preset, press the encoder knob once, then rotate until the desired preset number is displayed. Either press the encoder again or wait for a second. The display will show “Pls wait...” while the new preset is being loaded. The display will return to normal with the new preset number.
- To change input source, press the encoder knob twice. The display will change to show the current input source in large letters. Rotate the encoder knob until the desired input source is displayed, then press the encoder knob or wait for a second. The display will return to normal with the new input displayed.
- To turn Dirac Live filtering on and off, press the encoder knob three times. The display will change to show either “Dirac On” or “Dirac Off” in large letters. Rotate the encoder knob until the desired selection (on or off) is displayed, then press the encoder knob or wait for a second. The display will return to normal with the Dirac Live status:

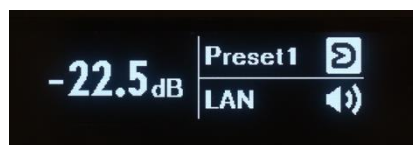

Dirac Live on



Dirac Live off

- To put the SHD Series processor into standby, press and hold the encoder knob. When the display changes to show “Standby?,” release the knob. To take it out of standby, press and hold the encoder knob briefly.

(Note: all these operations can also be performed with the remote control.)

3 SOFTWARE INSTALLATION

The SHD Series processors are configured with software running on a PC or Mac. There are two sets of software to download and install, from live.dirac.com and from [miniDSP.com](https://www.minidsp.com).

3.1 WINDOWS

This section describes software download and installation for Windows 10 and 11.



The software described in this section runs on the latest version of Windows 10 or Windows 11 **only**. Other versions of Windows are not supported by the current version of Dirac Live.

3.1.1 Download and install the Dirac Live application

Download the **Dirac Live** application for Windows from <https://live.dirac.com/download/>.

Double-click on the downloaded installer to run it. It will be named **diraclive-latest.exe**. We recommend that you accept the default installation settings. Do not run the application yet.

3.1.2 Download the miniDSP software

If you purchased your processor directly from miniDSP, your software will be available from the [User Downloads](#) section of the miniDSP website when your order ships. To access the download, you will need to be logged into the website with the account you created when purchasing.

If you purchased your processor from a miniDSP dealer, you will receive a coupon together with the product. Redeem this coupon at the link below:

- <https://www.minidsp.com/support/redeem-coupon>

The User Downloads link is visible from the dropdown menu at the top right of the website:

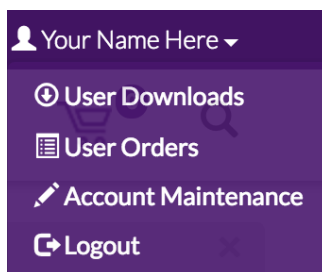

Navigate to the **SHD Series** section. Download the zip file under the heading **SHD software for Dirac 3.x**.

After downloading, unzip the file (right-click and select “Extract All...”). The unzipped download has a name like **SHD_v1_15**. (The version number embedded in the folder name may be different.)

3.1.3 Install the miniDSP software

3.1.3.1 Possible Windows installation issues

The miniDSP software requires that a number of other frameworks be installed for it to work. These packages should be installed automatically, but you can manually install them if you receive an error message that required software is missing.

- [Microsoft .NET framework](#) (version 3.5 or later)
- Microsoft Visual C++ 2010 Redistributable Package: for [x86](#) (32-bit Windows) or [x64](#) (64-bit Windows).

3.1.3.2 Install the plugin

1. Navigate to the **Plugins** folder of the software download and then to the **Windows** folder.
2. Double-click on the plugin installer to run it. It will be named **SHD.exe**. We recommend that you accept the default installation settings.

3.1.3.3 Install the UAC2 driver

1. Connect the processor to the computer using the supplied USB cable, and power it on.
2. Navigate to the **WinDrivers** folder of the software download and double-click on the driver installer:
 - **miniDSP_UAC2_v4.82.0_2020-06-09_setup.exe**

(The version number and date embedded in the filename may be different.)

We recommend accepting the default installation location. Once driver installation completes, click **Finish**.

Note: the first time you run the SHD plugin and the Dirac Live application, you may see a Windows Firewall warning such as the one below. Ensure that “Private networks...” is checked and “Public networks...” is not checked. Then click on “Allow access.” This warning dialog may appear more than once.

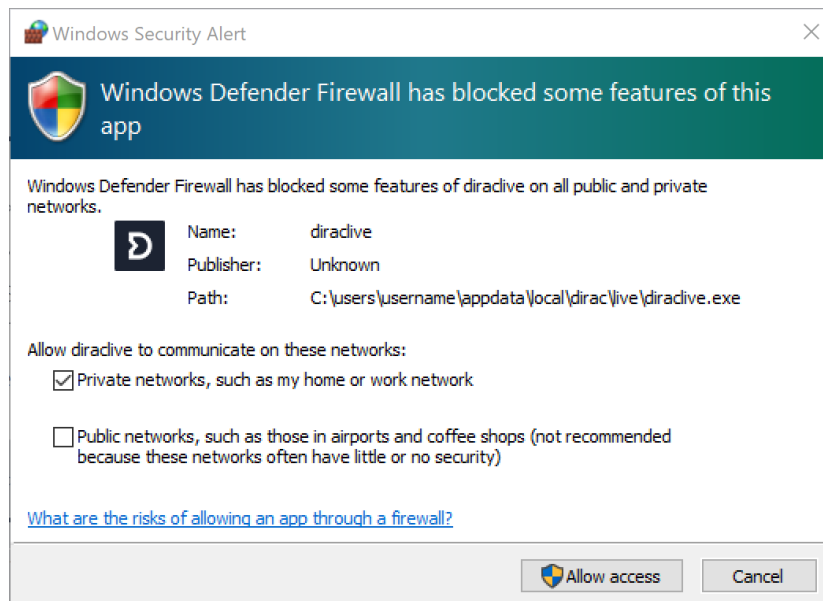

3.2 MACOS

This section describes software download and installation for macOS.



The software described in this section runs on macOS 10.14 Mojave or later **only**. Earlier versions of macOS / OS X are not supported by the current version of Dirac Live.

3.2.1 Download and install the Dirac Live application

Download the **Dirac Live** application for macOS from <https://live.dirac.com/download/>.

Double-click on the downloaded file to unzip it. Then double-click on the unzipped installer file to run it. It will have a name like **DiracLive v3.1.2 Setup Darwin.app**. We recommend that you accept the default installation settings. Do not run the application yet.

3.2.2 Download the miniDSP software

If you purchased your processor directly from miniDSP, your software will be available from the [User Downloads](#) section of the miniDSP website when your order ships. To access the download, you will need to be logged into the website with the account you created when purchasing.

If you purchased your processor from a miniDSP dealer, you will receive a coupon together with the product. Redeem this coupon at the link below:

- <https://www.minidsp.com/support/redeem-coupon>

The User Downloads link is visible from the dropdown menu at the top right of the website:

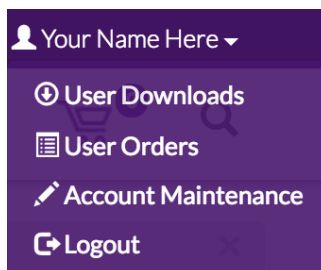

Navigate to the **SHD Series** section. Download the zip file under the heading **SHD software for Dirac 3.x**.

After downloading, unzip the file (double-click on it). The unzipped download has a name like **SHD_v1_15**. (The version number embedded in the folder name may be different.)

3.2.3 Install the miniDSP software

3.2.3.1 Possible Mac installation issues

If double-clicking on the installer brings up a message that the installer cannot run, use this alternate method:

1. Right-click on the installer (or click while holding the Control key).
2. Move the mouse over the “Open With” item and then click on “Installer (default).”

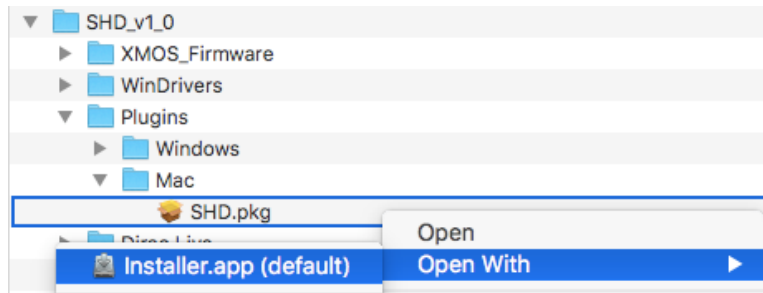

3. The following window will appear. Click on “Open.”

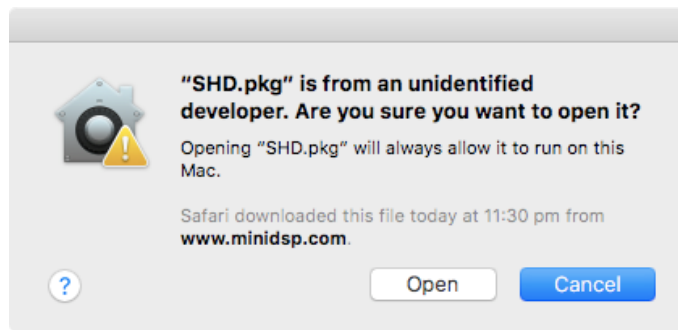

3.2.3.2 Install the plugin

1. Navigate to the **Plugins** folder of the software download and then to the **Mac** folder.
2. The installer is named **SHD.pkg**. To run it, double-click on it, or right-click and open as described above. We recommend that you accept the default installation settings.
3. To run the plugin, locate it in the Applications -> miniDSP folder and double-click on it. To make it easier to run in future, right-click on its dock icon and select Options -> Keep in Dock.

3.2.3.3 Enable file sharing for device discovery

To enable device discovery, open System Preferences, go to Sharing, then enable File Sharing as shown at right.

Notes:

- a) This step is not always necessary and may depend on your Mac’s configuration or your home network setup.
- b) If you wish, you can turn File Sharing off again after completing your Dirac Live calibration.

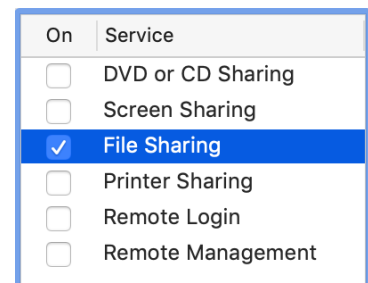

4 PLAYING AUDIO

4.1 DIGITAL SOURCES

All SHD Series processors have three digital inputs in addition to USB and network audio: AES-EBU (XLR), SPDIF (RCA), and TOSLINK optical.

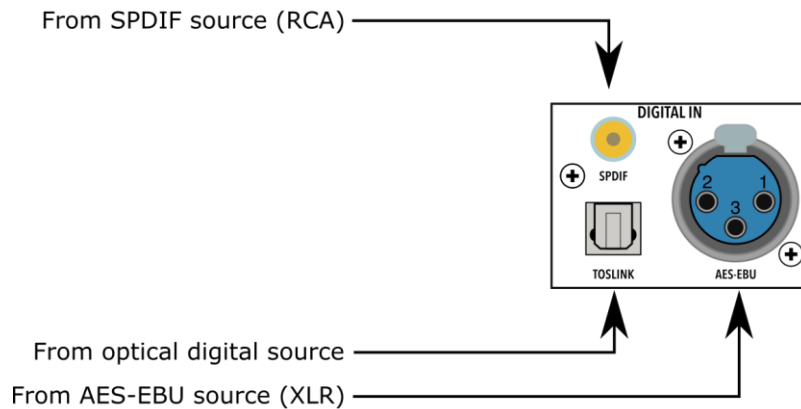

To play from any of these sources, use the front panel knob or remote control to select **AES-EBU**, **SPDIF**, or **TOSLINK**.

4.2 ANALOG SOURCES (SHD ONLY)

The SHD processor has two stereo analog inputs, one RCA and one balanced XLR.

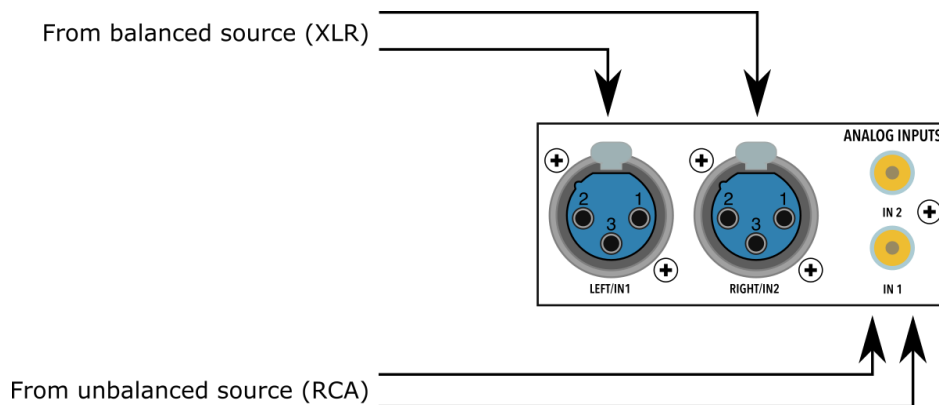

To play from either analog input, use the front panel knob or remote control to select **RCA** or **XLR**.

4.3 NETWORK AUDIO

The miniDSP SHD Series processors incorporate a custom version of the popular network audio endpoint [Volumio](#), running on its own ARM CPU inside the SHD Series processor chassis. Volumio has a wealth of functions for controlling and delivering network audio at sample rates up to 192 kHz.

This section will provide a few pointers to get you started.

Please note however that since Volumio and the other software mentioned in this chapter is third-party software, miniDSP support for this software is *limited*.



While the SHD Series processor contains an ARM processor running Linux for network streaming, miniDSP **does not support** any additional software installation or custom Linux builds on this processor.

4.3.1 Ethernet connection

Connect an Ethernet cable from your home network router to the Ethernet port on the rear panel. This is a typical example:

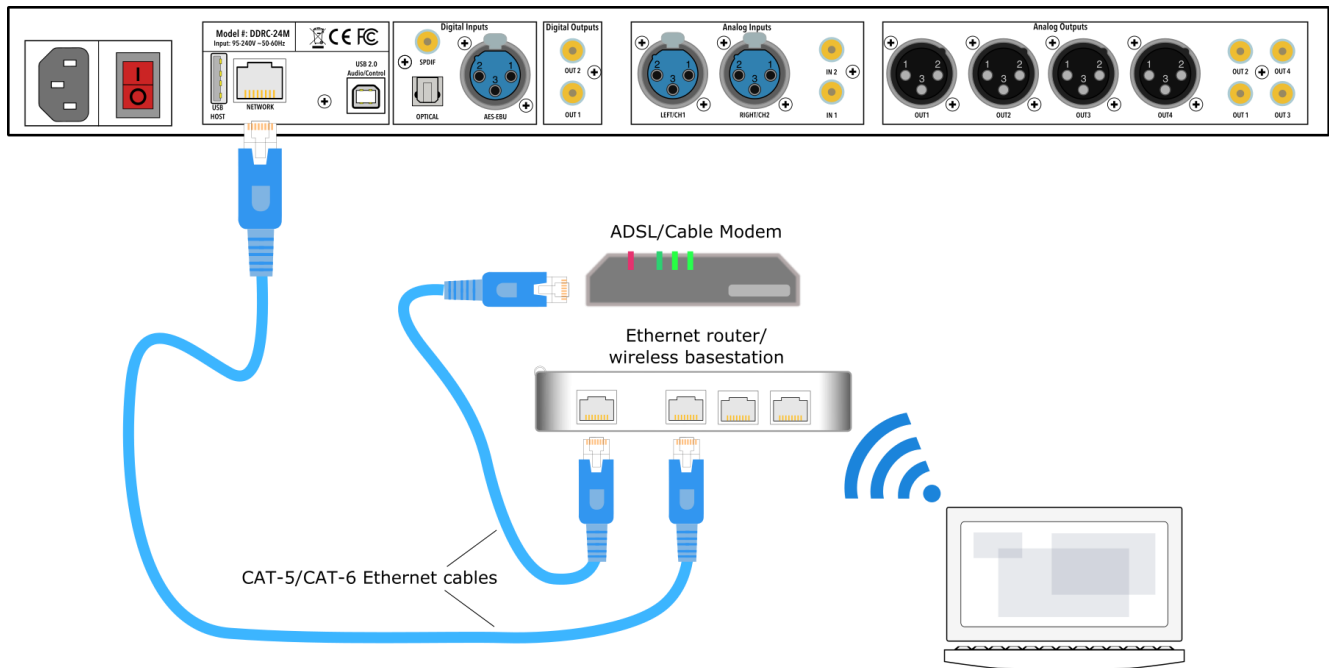

A short Ethernet cable is provided with the unit. If a longer cable is required, these are readily available from computer stores and online. The recommended maximum length of Ethernet cables is 100 meters (330 feet).

Note that your router must be set to allow dynamic IP addresses i.e. DHCP. Most routers will have this function enabled by default.



4.3.2 Wi-Fi connection

Insert the provided Wi-Fi adapter (aka “dongle”) into the USB Host port on the back of the SHD Series processor.

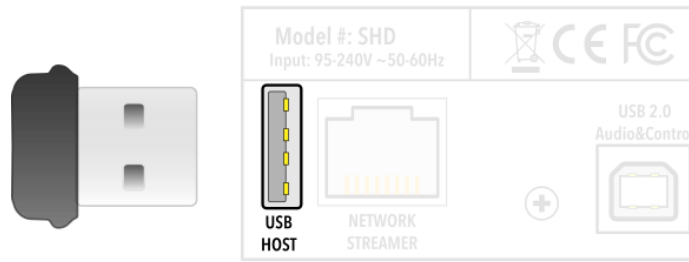

Use your computer's network manager to search for a wireless hotspot named **miniDSP SHD**. This is started automatically by Volumio when it can't connect to a network. Select this hotspot and connect to it. No password is needed.

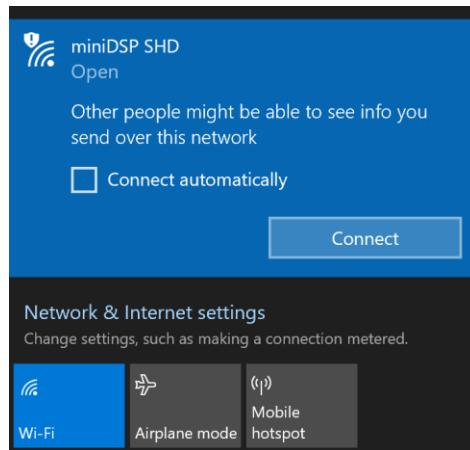

When the hotspot connects, the Volumio interface will automatically open at the setup wizard:

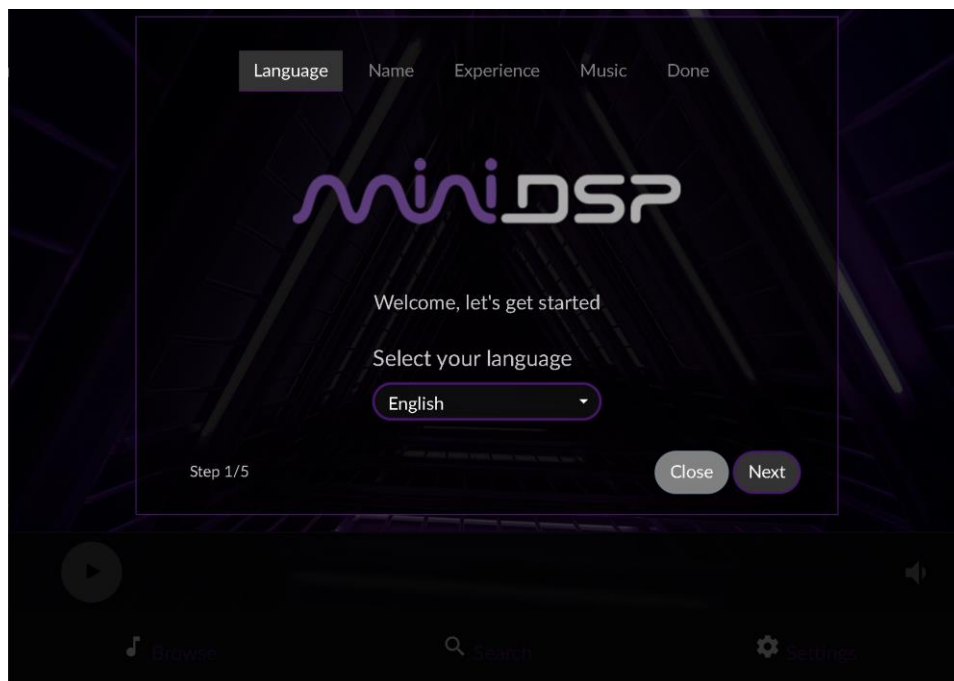

If you see a message saying that you have to log in here to access the Internet, ignore it. After completing the initial setup wizard, locate the Volumio Settings page. Depending on your device, this may be accessed from the sidebar on the left-hand side, or by clicking on the gear icon at the lower right.

Select **Network Settings** and scroll down to the Wireless Network Connection section. Locate your network in the list and click on it. Enter your Wi-Fi network's password and click **Connect**:

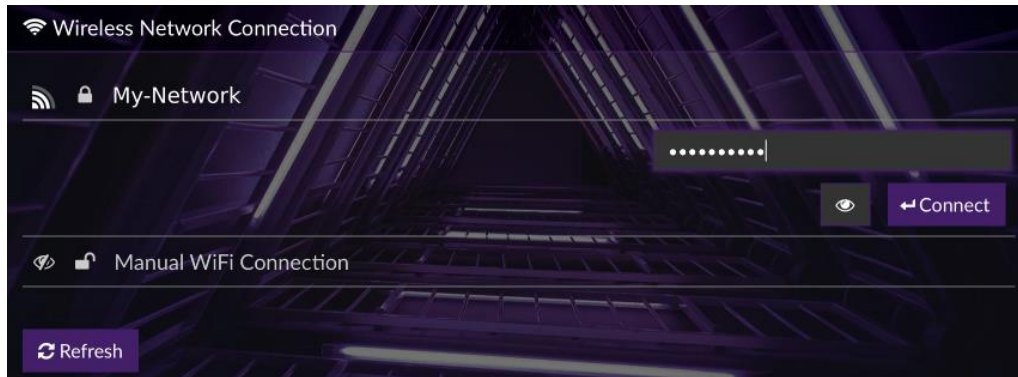

If you have a hidden network, use the Manual WiFi Connection option.

After clicking on Connect, the SHD will close the hotspot. The SHD is now joined to your wireless network. Disconnect your computer from the **miniDSP SHD** hotspot and reconnect it to your wireless network. Follow the procedure on the next page to open the Volumio web interface.



After reconnecting to the Volumio web interface, we strongly recommend going back to **Network Settings** and adding a password to the hotspot. This will ensure that your SHD does not broadcast an open hotspot if it is unable to connect to your Wi-Fi network for some reason in the future.

4.3.3 The Volumio web interface

To open the Volumio web interface, enter one of the following in your web browser window (or click on the links embedded in this document):

- <http://minidsp-shd/>
- <http://minidsp-shd.local/>

Depending on your network setup, one may work while the other will not. If neither works, you will need to connect to the web interface by IP address. In that case, see page 83.

When you connect to the interface for the first time, you will enter a simple setup wizard. Just proceed through the steps:

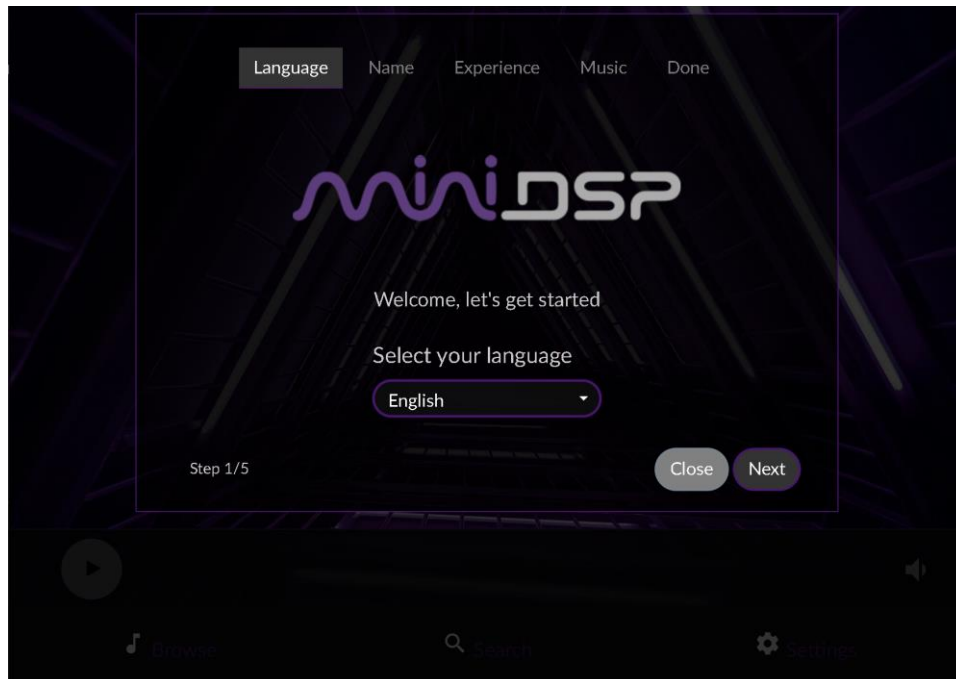

You can repeat the setup wizard at any later time by navigating to Settings then System, and clicking on “Run First Config Wizard.”

To change the background image or to set a solid color, navigate to Settings then Appearance:

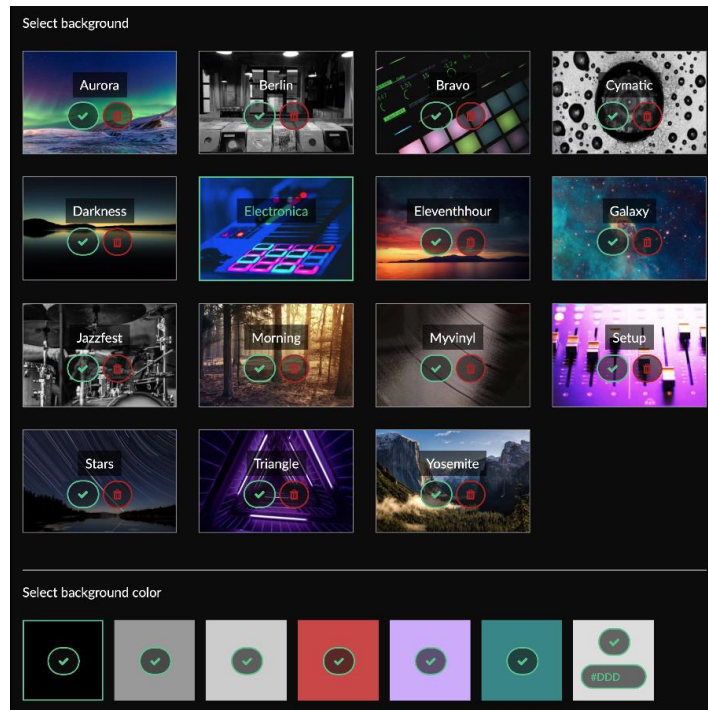

Once done, get ready for audio playback by using the front panel encoder or the remote control to select the LAN input source:

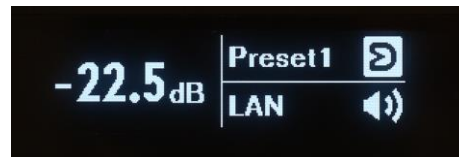

As a quick check of audio playback, go to the Web Radio section and select a radio station to play back. If all is well, you will hear audio from your speakers.

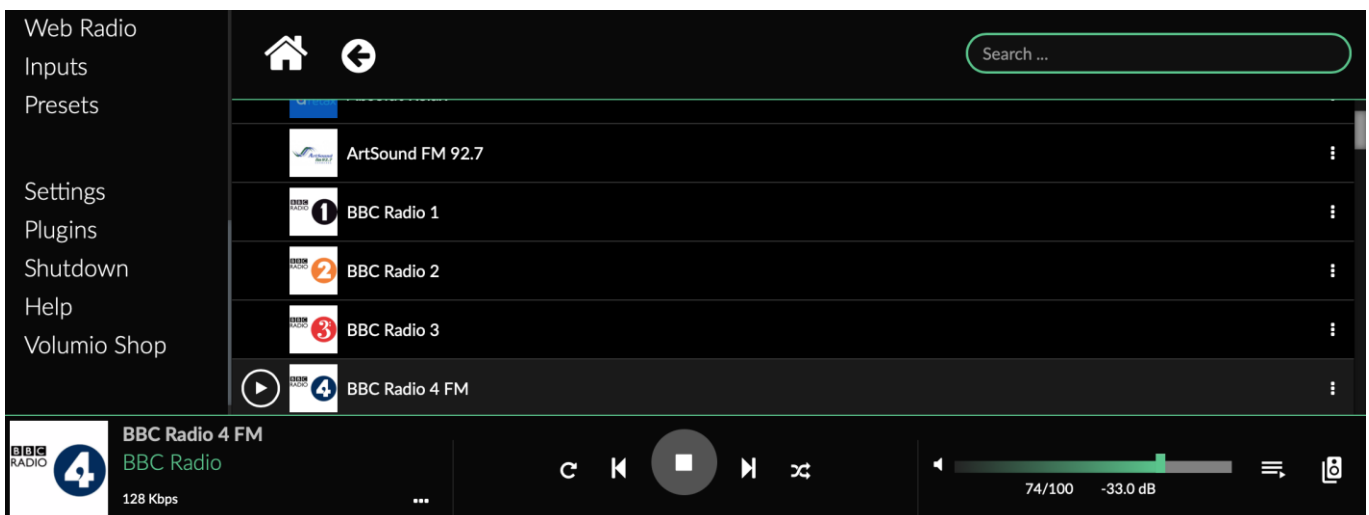

4.3.4 Playing audio from USB stick

Insert a USB stick containing music files into the USB HOST port on the rear panel, next to the Ethernet port.

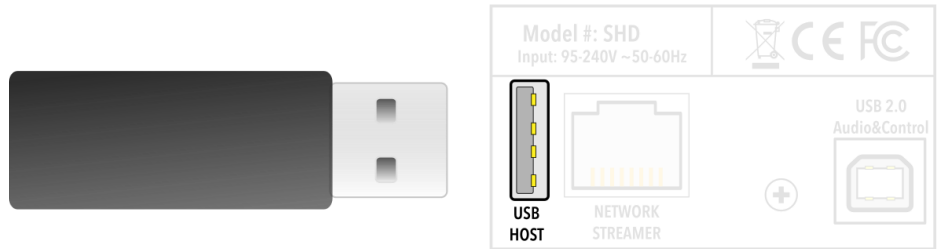

It is not possible to play audio from a USB stick if using the Wi-Fi dongle, as there is only one USB host port.

Volumio will start indexing the USB stick. Navigate to the home screen. On a wide desktop window, you can click on Music Library on the left sidebar and navigate to the USB stick, where you can select an album for playback. On a narrow desktop screen or mobile device, navigate to the home screen and click on the Music Library icon.

You can also click on Albums or Artists to directly browse the USB stick.

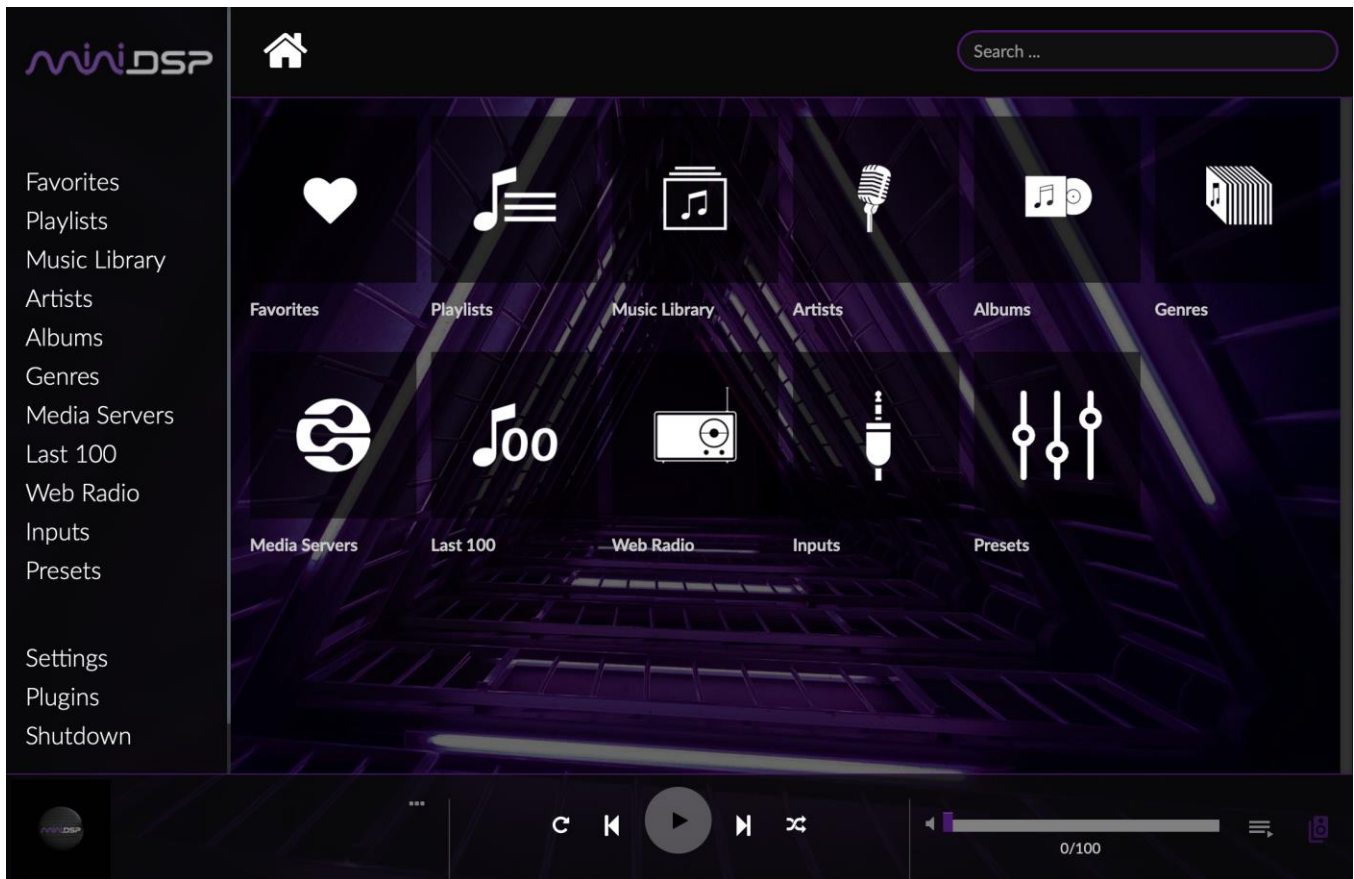

4.3.5 Roon

The miniDSP SHD Series processors are certified Roon Ready players. You will need a current Roon subscription to use Roon with your miniDSP SHD Series processor.



A two-month Roon trial coupon is included in the box with every SHD Series processor.³

4.3.5.1 About Roon

Roon is an incredibly rich and engaging way to browse and organize your music. It runs on most Mac, Windows, and Linux PCs, or on other products which include Roon Core.

Being *Roon Ready* means that miniDSP network players transparently discover and connect to Roon without any configuration, and bit-perfect audio is delivered from Roon to your network player.

Together, Roon and miniDSP deliver the power, flexibility, and performance of networked audio, with the easiest setup and highest reliability available.

Learn more about [Roon partner programs](#).

4.3.5.2 Enabling Roon on the SHD Series processor

Before starting, check that Roon Ready is enabled on your SHD. Open the Volumio web interface and navigate to Settings, then to My Music. Scroll down and confirm that Roon Ready is active:

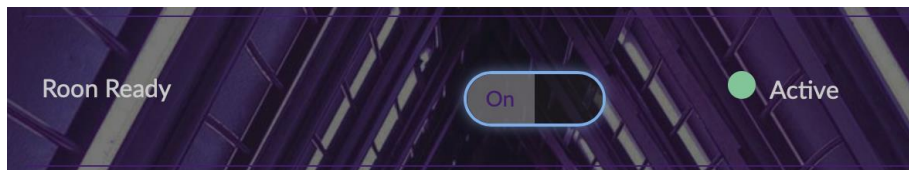

If you have previously enabled Roon by installing a plugin in Volumio, make sure that you deactivate and uninstall it now.

4.3.5.3 Setting up Roon on your PC

If you are already a Roon user, you can skip this section. Otherwise, this is a quick guide; refer to the [Roon knowledge base](#) for detailed instructions.

There are various ways of setting up Roon. The simplest method is to install it on a computer that also has your music files on an internal or attached drive. After [downloading Roon](#) for Mac or Windows, run the installer program. You will need to log in to your Roon account.

³ If you purchased your SHD Series processor prior to January 2022 and did not receive a Roon trial coupon, you can obtain one by emailing info@minidsp.com with the subject line "REQUEST ROON TRIAL." You will need to provide your SHD Series serial number in the body of the email.

On the setup screen, click on “Add Folder...”:

Add your music

Music Folder

Disable

Add Folder...

Your files won't be moved or modified in any way

Navigate to your music library folder and select it. You can change or add folders later on by using the Settings screen in the Roon UI.

4.3.5.4 Enable the miniDSP processor

Each audio device needs to be enabled in Roon. In the setup wizard, or later on the Settings → Audio page, locate the SHD Series processor in the Roon Ready category:

ROON
READY

DEVICE INFO

MiniDSP SHD

192.168.1.44

Enable

Click on its Enable button. The display will change to show the default name:

ROON
READY

DEVICE INFO

minidsp-shd

192.168.1.44

Click on the pencil icon to change the name, or on the gear icon to configure other settings.



Return to the main screen in the Roon UI. Click on “Select an audio zone” and select the miniDSP SHD:

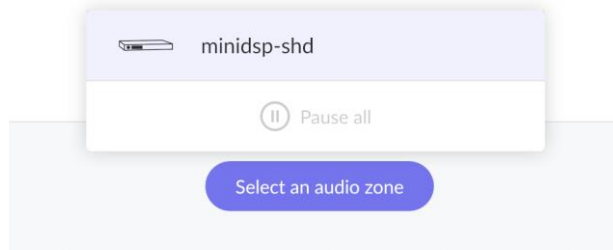

Alternatively, if another device is already selected, click on its icon at the lower right and then select your SHD Series processor. In either case, the miniDSP SHD Series icon and name will appear at the bottom right of the window, together with the current volume setting. The icon may vary depending on your SHD Series model.

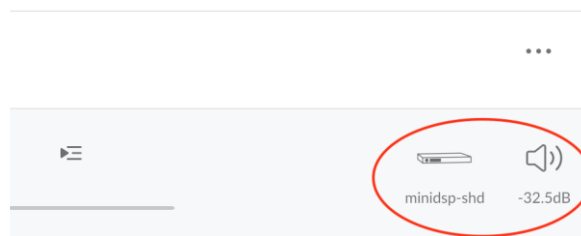

Click on the speaker icon to change the volume or other settings. The displayed volume is the same as displayed on the front panel OLED of the SHD Series processor:

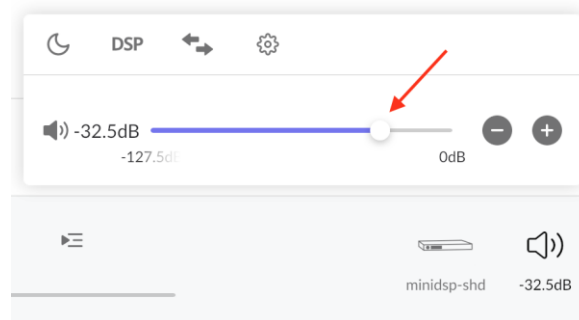

Go to the Browse section in the Roon UI, navigate to an album, and click on “Play now”:



For additional resources on how to use Roon, refer to the Roon Labs [Knowledge Base](#) and the [Roon Community Forum](#).

4.3.5.5 Remote control of Roon playback

Use the miniDSP infrared remote to pause and resume playback, and to skip forward and backward in the playlist.

For full remote control using a mobile device, install Roon Remote on [Android](#) and [iOS](#) phones and tablets.

4.3.6 TIDAL and Qobuz

TIDAL is a streaming service for lossless CD-quality audio. It is currently available in 53 countries. For up-to-date information on availability, see the Tidal article "[TIDAL – where we’re available.](#)"

Qobuz is a streaming service for lossless CD-quality and high-resolution audio up to 192 kHz. It is currently available in the USA and 11 countries in Europe. For up-to-date information on availability, see the Qobuz article "[Where is Qobuz available?](#)"

Both of these streaming services are supported by the SHD Series processors. You do not need a special Volumio subscription to access them. You will, however, need to have an account with your choice of streaming service.

To enable your chosen streaming service, go to the Volumio settings. In the **My Music** page, scroll down and locate the Tidal or Qobuz heading. Click on **Login** under your subscribed service then enter your username and password for that service.

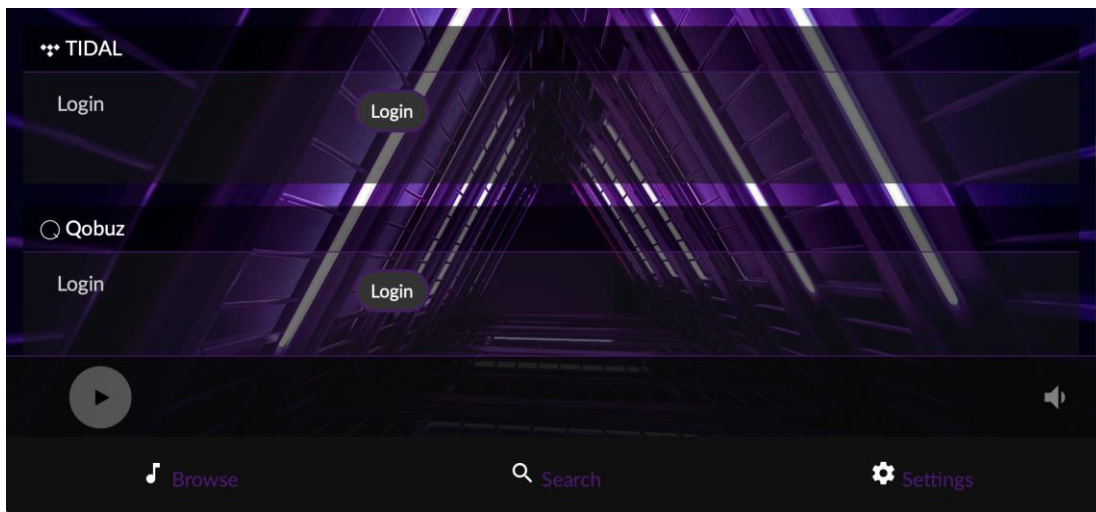

After logging in, the sidebar menu and the Home screen will show an entry for your selected service.



To obtain a free trial of Qobuz high-res streaming for use with your SHD Series processor, visit miniDSP’s Qobuz partner page in your web browser: <http://qob.uz/minidsp>

4.3.7 Spotify

The web interface can be used to stream from Spotify. This requires a Spotify premium account, which you must first obtain on the [Spotify website](https://www.spotify.com).

1. Navigate to Plugins in the Volumio settings. Locate the Spotify plugin and click **Install**.

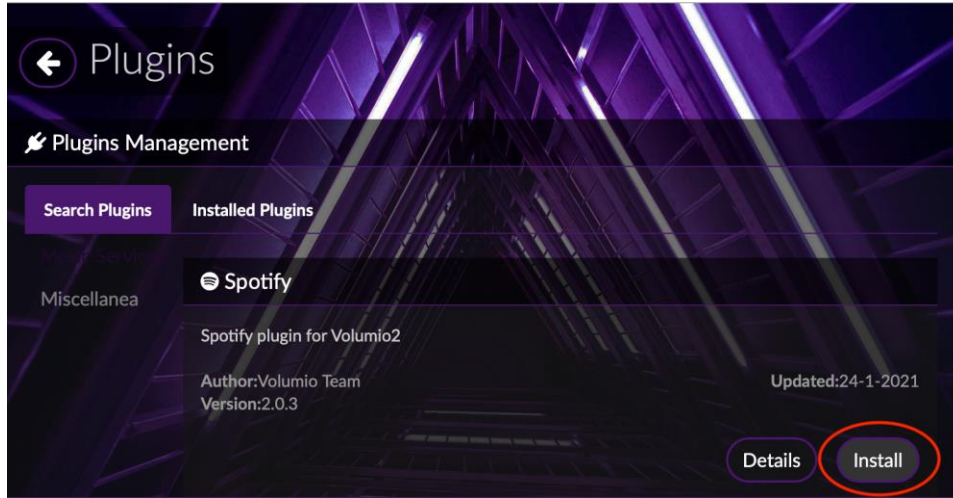

2. When installation completes, click on **Enable Plugin**.
3. Click on the **Installed Plugins** tab.

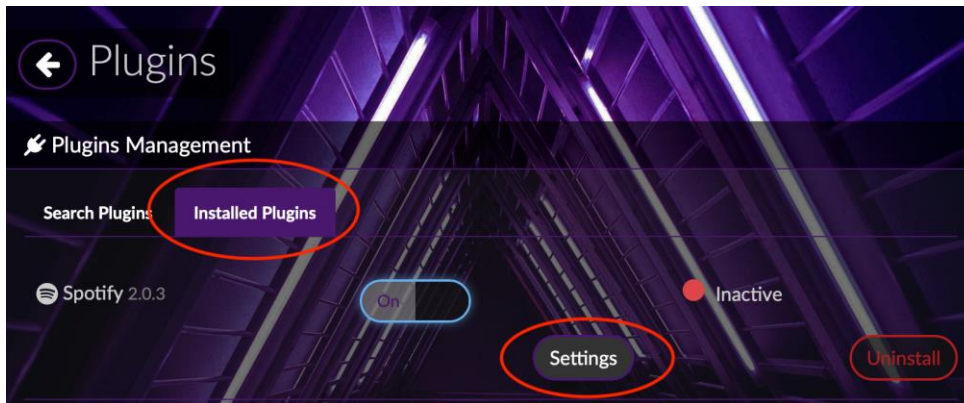

4. Click on **Settings**.
5. Enter your Spotify username and password.
6. Go to the home screen and click on the Spotify icon.

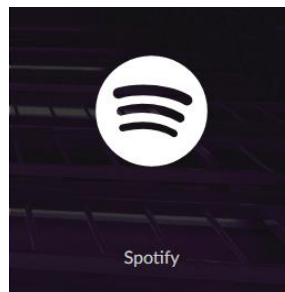

4.3.8 Accessing multiple processors

More than one SHD Series processor can be controlled from the same web interface screen. To do so, follow these steps.

1. On the first SHD Series processor, navigate to Volumio settings and select System. Set Player Name to something unique then click Save. In our example, we used “Main system”:



2. Select Shutdown and then Restart.
3. Connect and turn on the second SHD Series processor. Connect to it at <http://minidsp-shd/> or <http://minidsp-shd.local/> and change its name away from the default as above. In our example, we used “Study system” for the second SHD Series processor. Select Shutdown and then Restart.
4. Re-open the web interface using one of the **new** names. If you used spaces in the name, replace the spaces with hyphens. For example, in our case we connected to <http://main-system/>. Click on the speaker icon to display the list of active devices and click on the one that you want to control. The location of the icon will depend on your device.

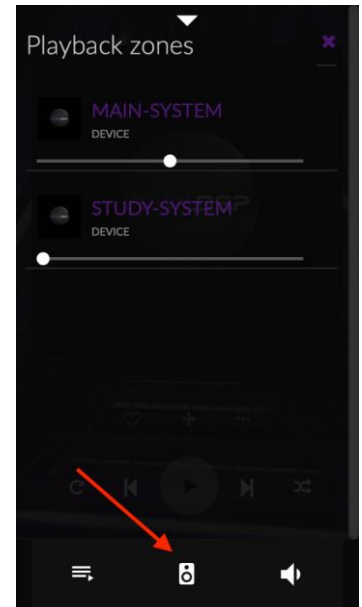
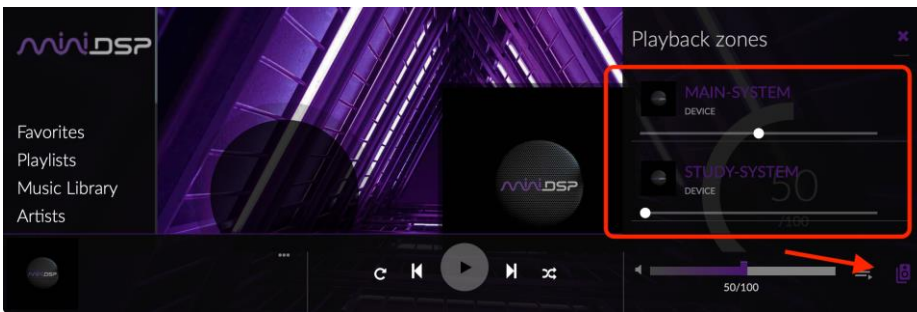

Note: clicking on the name of each processor gives you independent control of them. Synchronized playback to multiple SHD Series processors is not supported.

4.4 USB AUDIO

The SHD Series processors accept stereo PCM audio at sample rates of 44.1, 48, 88.2, 96, 176.4, and 192 kHz over USB. The same USB connector is used for streaming USB audio, configuration and Dirac Live calibration.

Use the supplied cable to connect the USB 2.0 (Type B) port of the SHD Series processor to a free USB port on your computer.

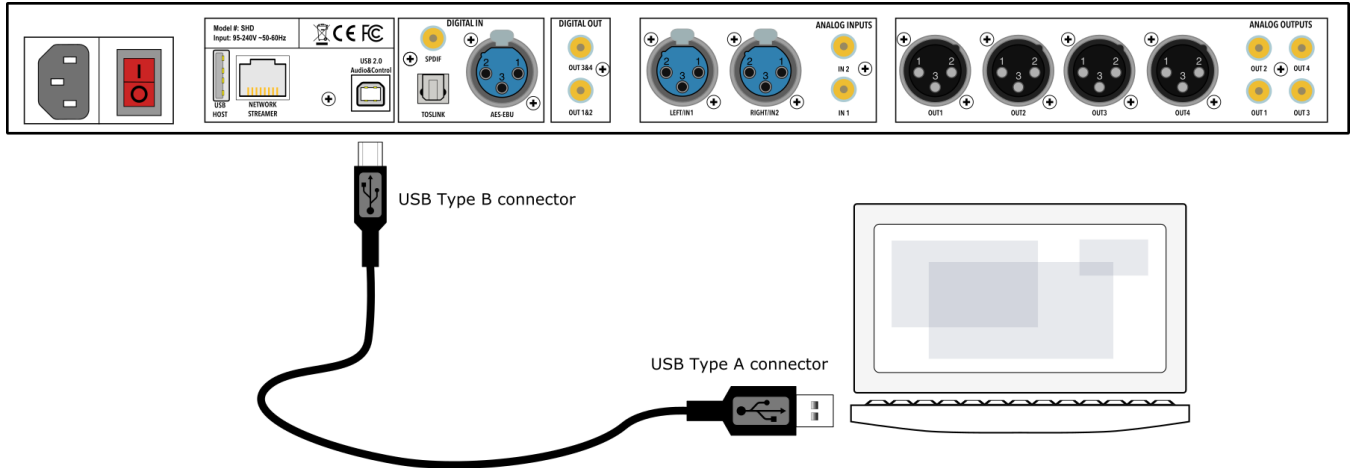

4.4.1 macOS

Open **Audio MIDI Setup** (in **Applications->Utilities**) and click on “SHD” in the list on the left-hand side. Sample rates up to 192 kHz can be selected:

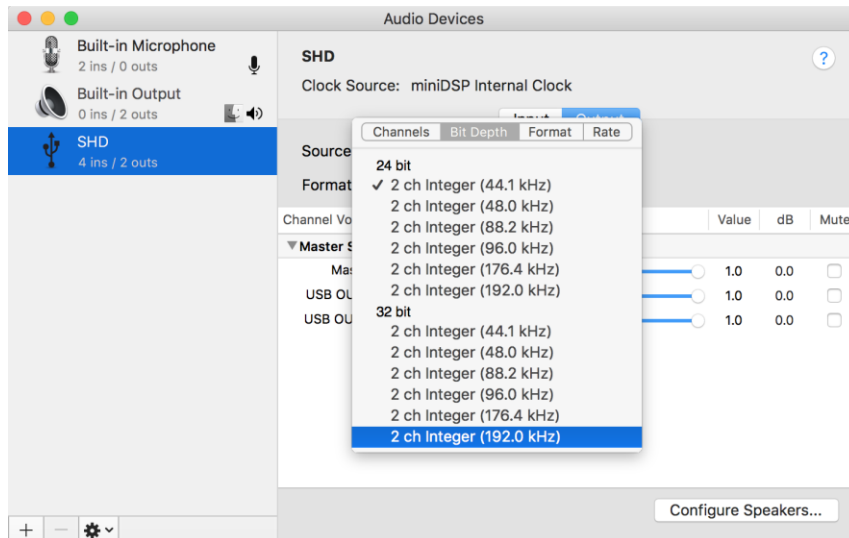



To set the SHD Series processor as the default audio output device, right-click and select “Use this device for sound output”:

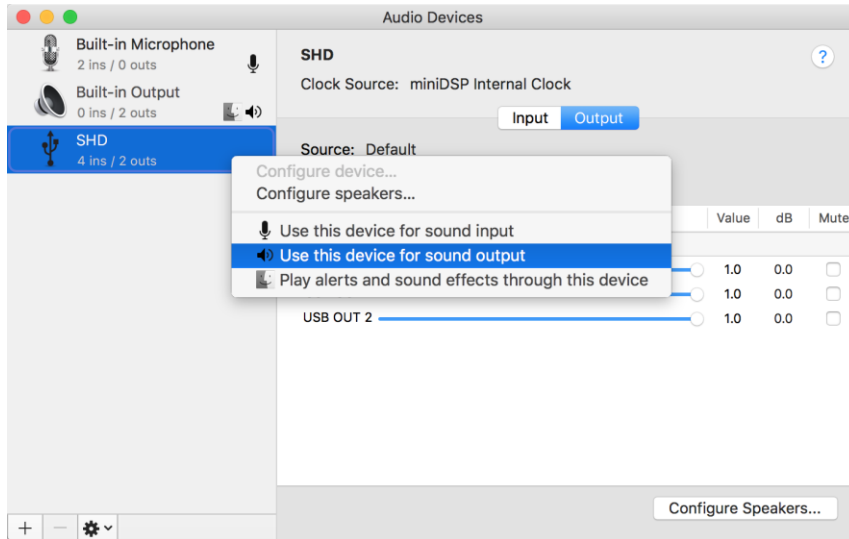

Note that individual audio playback apps may allow the SHD Series processor to be selected for audio output independently of the system default. They may also control sample rate automatically.

The SHD Series processor sends its four output channels to the computer over USB. Click on the **Input** button in Audio MIDI Setup to see them. These can be used to monitor or record the output channels of the processor.

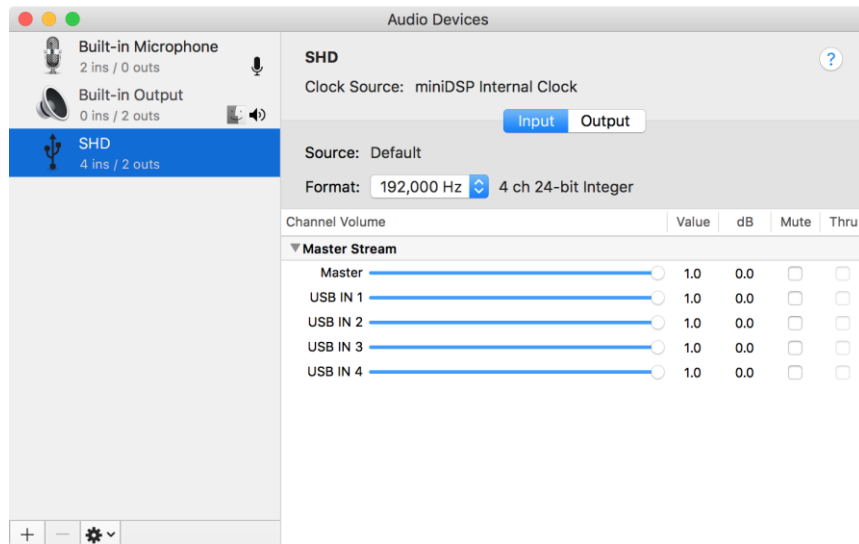

4.4.2 Windows

Note: to play USB audio from Windows, the miniDSP UAC2 driver package must be installed first.

4.4.2.1 Default audio device

To set the SHD Series processor as the default audio output device, open the Windows Control Panel and navigate to the Audio Devices section. On the Playback tab, select the device named “SHD Series” and click on the “Set Default” button.

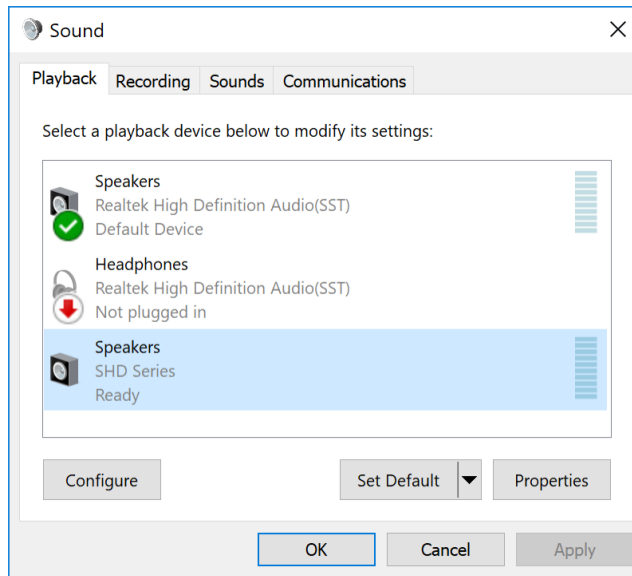

To change the bit depth and sample rate, click on the Properties button and select the Advanced tab. Drop down the selection menu, choose the desired value and click OK. Sample rates up to 192 kHz can be selected:

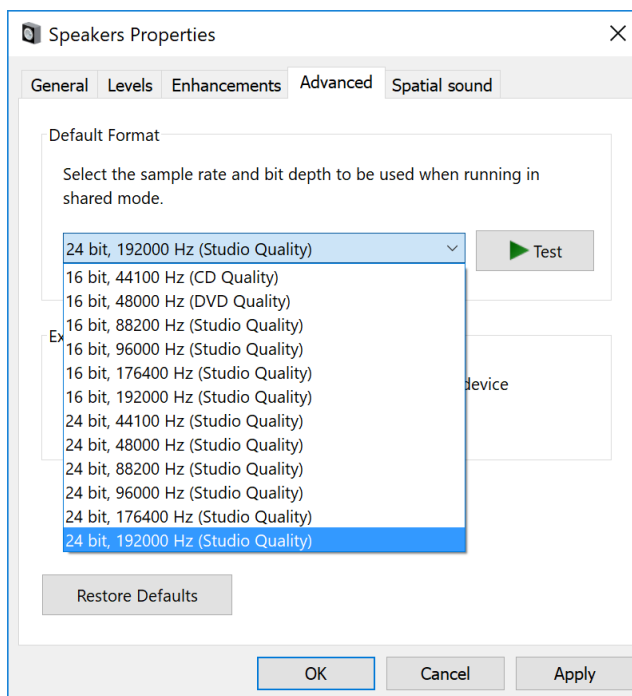

The SHD Series processor sends its four output channels to the computer over USB. These can be used to monitor or record the output channels:

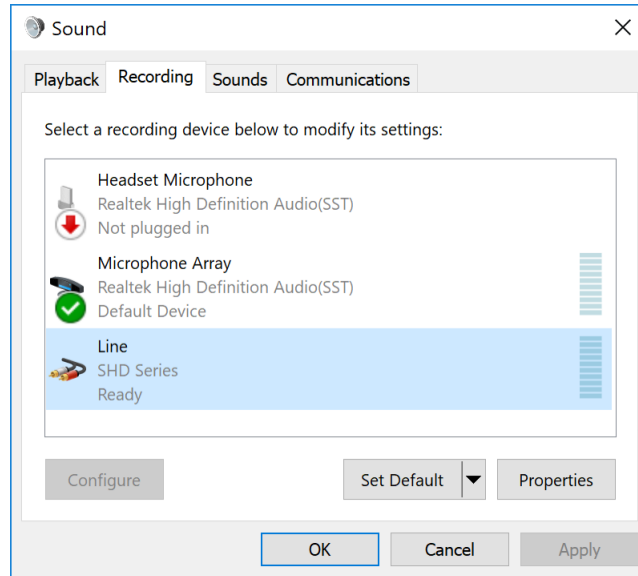

4.4.2.2 ASIO

If your audio application supports ASIO audio drivers, we recommend selecting the miniDSP ASIO Driver in its settings. This typically allows the application to automatically change sample rate. For example, in JRiver Media Center:

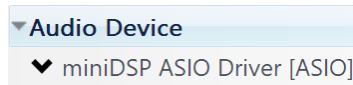

4.4.2.3 miniDSP UAC2 control panel

The current settings of the SHD Series processor can be viewed by opening the **miniDSP UAC2 Control Panel** from the Windows Start menu (under the **miniDSP Ltd** folder). This control panel allows you to view current settings. In addition, it can be used to set buffer size, although we recommend that you leave this setting at the default. If you are having an issue with inadequate output volume over USB playback, check the Volume tab.

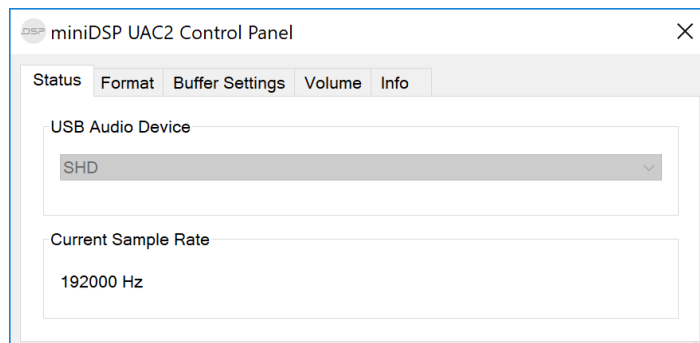

5 REMOTE CONTROL

The SHD Series processor has several options for remote control of key runtime functions.

5.1 USING THE MINIDSP REMOTE

The remote control provided with the processor controls all key runtime functions.



Standby

Put the processor into standby.



Mute

Mute and unmute audio output.



Volume



Reduce or increase the volume. Each press changes the volume in 0.5 dB. Holding down a button will accelerate volume change to 3 dB steps.



Media control

Control Volumio audio playback. From left to right, the buttons skip back a track, play or pause audio, and skip forward to the next track.



Dirac Live

Enable or disable Dirac Live filtering. Dirac Live filtering will be effective only on presets for which Dirac Live filters have been loaded.



Source selection

Cycle through the input sources in order:

SHD

RCA (unbalanced analog), XLR (balanced analog), USB, LAN (Ethernet), TOSLINK, SPDIF, AES-EBU

SHD Power and SHD Studio

USB, LAN (Ethernet), TOSLINK, SPDIF, AES-EBU

To avoid cycling through unconnected inputs, you can set valid inputs in the User Preferences menu of the SHD plugin. See page 49.



Preset (1 through 4)

Switch to the selected preset. It takes a few seconds for the preset selection to complete, while the processor loads the new filters from its flash memory into the DSP.

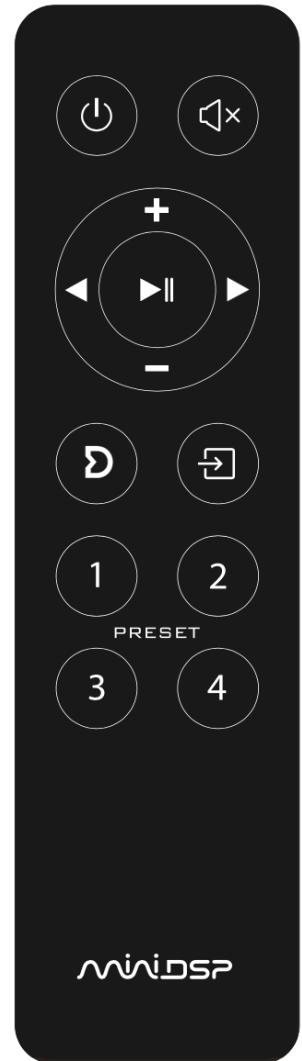

5.2 USING THE VOLUMIO WEB INTERFACE

The Volumio web interface can be used to control volume, select input source, and select configuration preset.

5.2.1 Desktop device

The input source and configuration preset selection can be accessed either from the menu on the left side of the window or from the icons on the home screen:

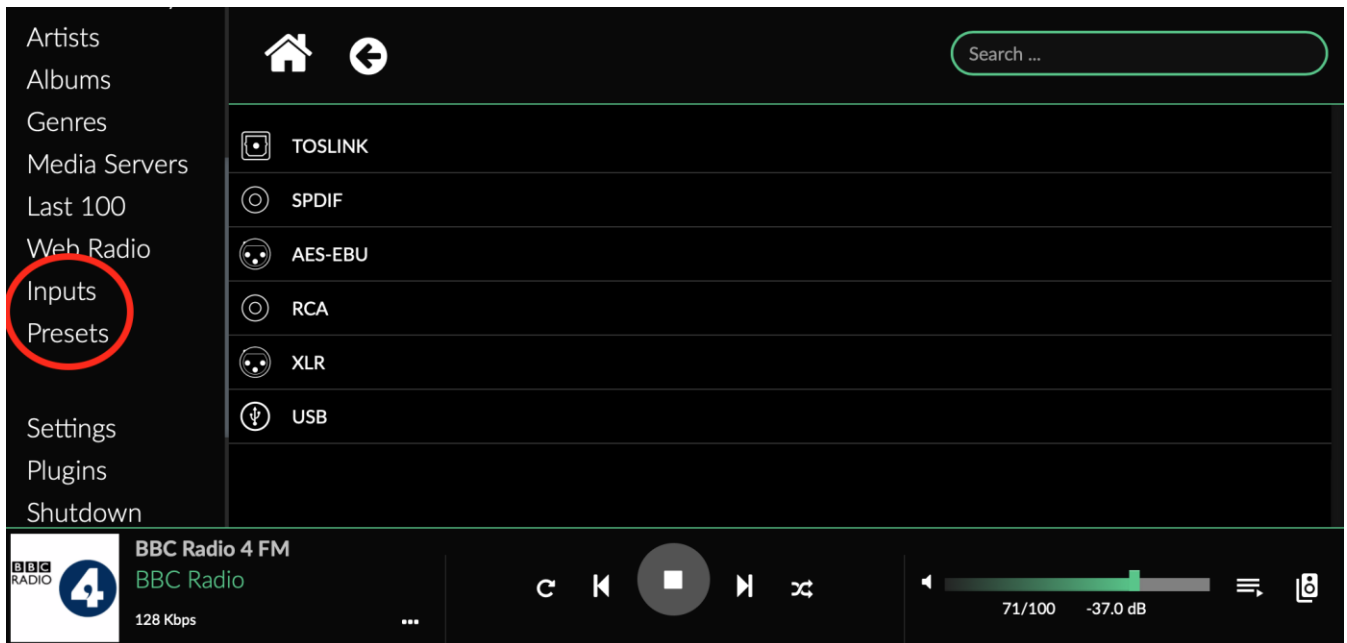

Volume control is always present at the lower right of the screen. By clicking on the currently playing item (BBC Radio 4 FM in the example), a larger control is available:

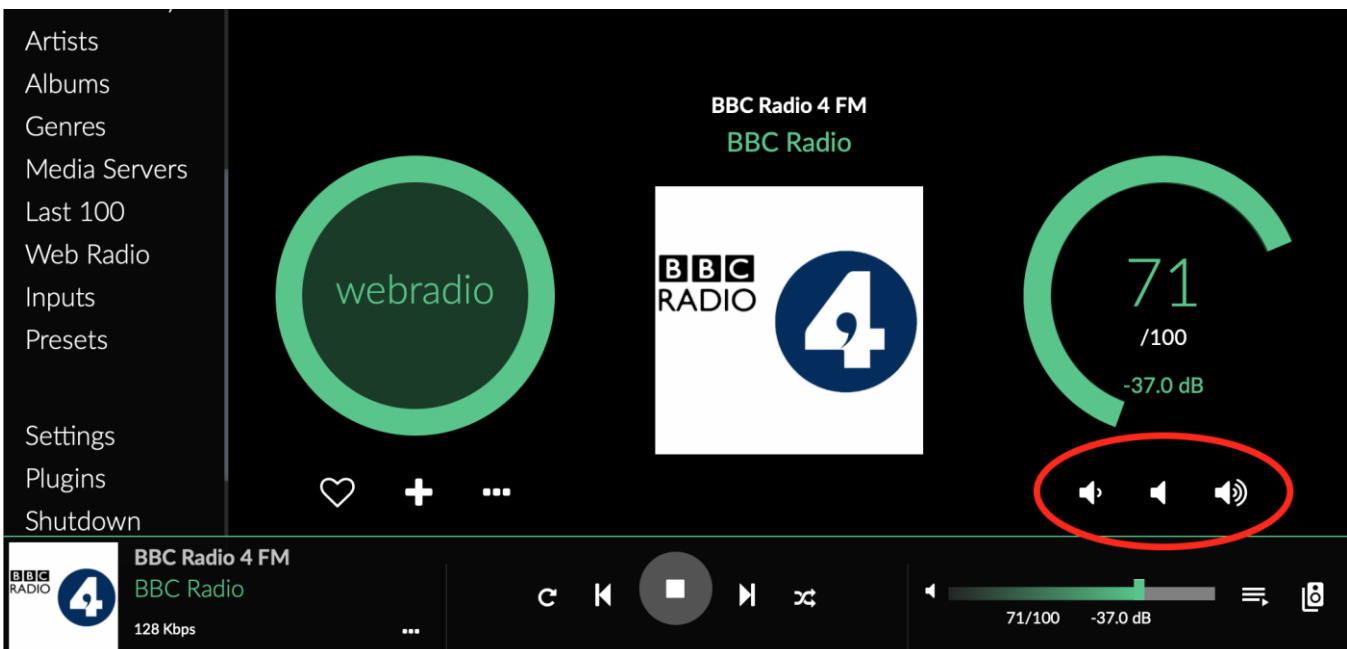

Clicking on the highlighted buttons controls the volume:

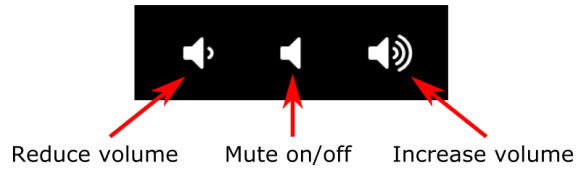

To set the size of the volume step when clicking on the buttons, go to Settings and then Playback Options. Scroll down to the Volume Options section, set Mixer Type to “Software” and click Save.

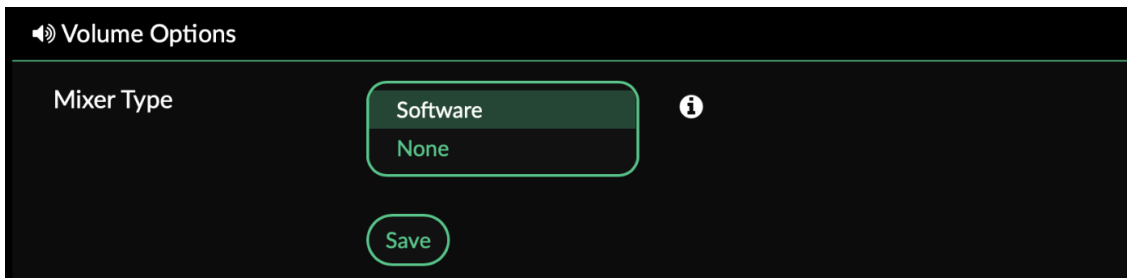

The interface will update to show additional options. Here you can set the volume step size:

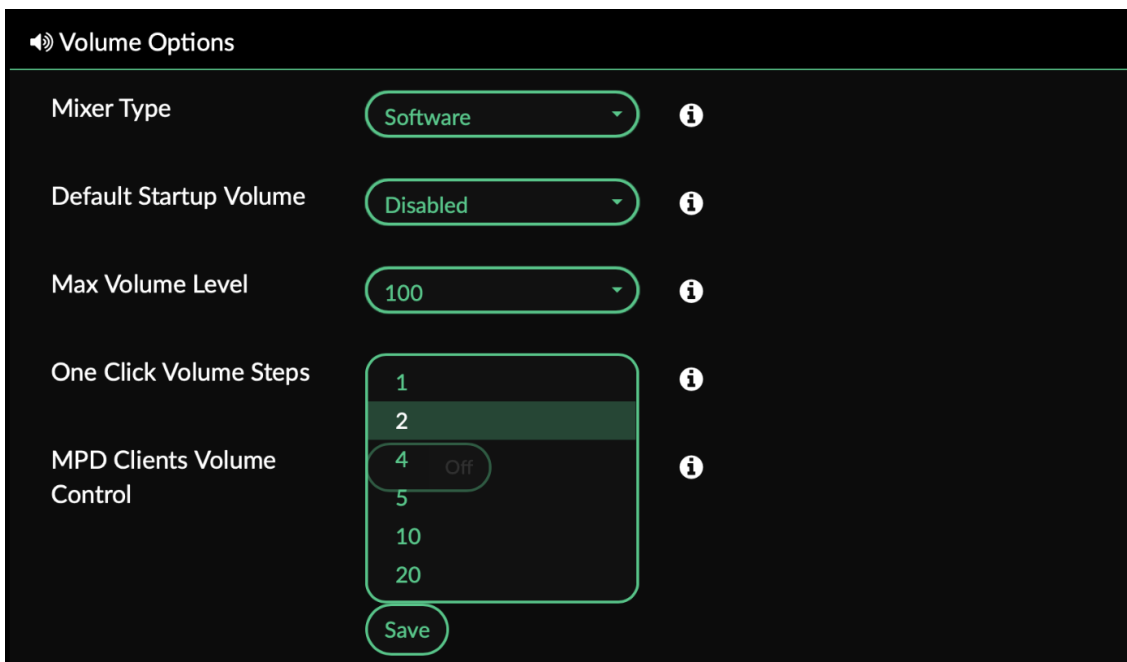

5.3 PROGRAMMING A LOGITECH HARMONY REMOTE

The SHD Series processor can be used with a Logitech® Harmony® remote⁴. The same functions as the stock remote are programmed into the Harmony database. In addition, you can set up buttons for direct input source selection (instead of cycling through input sources).

For more information, see this application note:

- [Using a Harmony Remote with the miniDSP SHD](#)



5.4 ANDROID/IOS CONTROL APP

With the addition of a [miniDSP Wi-DG](#) Wi-Fi to USB bridge, the SHD can be remote-controlled from a phone or tablet running Android or iOS (iPhone/iPad).

For more information, see this application note:

- [Using Android / iOS app to control your miniDSP](#)

If you're keen to just get started, here are the direct links to the app:

- [Android version on Google Play store](#)
- [iOS version on iTunes store](#)



If the USB port is being used for iOS/Android app control via the Wi-DG, it cannot be used for USB Audio streaming.

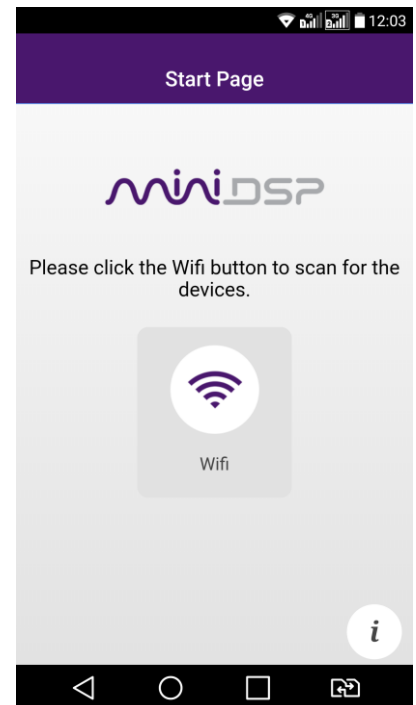

⁴ **Logitech** and **Harmony** are registered trademarks of Logitech.

5.5 ALEXA VOICE CONTROL

With the addition of a [miniDSP Wi-DG](#) Wi-Fi to USB bridge and an Amazon Echo, the SHD can be remote-controlled using voice control with Amazon Alexa.

For more information, see this application note:

- [Using Amazon Alexa with miniDSP Wi-DG](#)



If the USB port is being used for Alexa voice control via the Wi-DG, it cannot be used for USB Audio streaming.

5.6 LEARNING THIRD-PARTY REMOTE CODES

While each SHD Series processor is supplied with a basic miniDSP remote, it can also “learn” the control codes of a third-party remote if it supports one of the following remote control codes:

- NEC
- Sony
- Philips RC6
- Apple (old silver remote only)

To initiate the learning process, start the SHD plugin and click on the Connect button. Once connected, drop down the IR Remote menu and select **IR learning**. Click on the **Learn** button for an operation, and then press the desired button on the remote control. If the code is accepted, the status will change to show a tick. Repeat for all commands:



To “unlearn” a command, press the **Learn** button and wait for the plugin to time out. Note that you cannot “learn” the miniDSP remote – if you program another remote and want to revert to using the miniDSP remote, simply “unlearn” all codes. (Applies to firmware v1.18 and later.)

5.7 LEGACY MINIDSP REMOTE

This page describes the miniDSP remote that shipped with SHD Series processors prior to June 2020.

Source

Cycle through the input sources in order:

SHD

RCA (unbalanced analog), XLR (balanced analog), USB, LAN (Ethernet), TOSLINK, SPDIF, AES-EBU

SHD Power and SHD Studio

USB, LAN (Ethernet), TOSLINK, SPDIF, AES-EBU

To avoid cycling through unconnected inputs, you can set valid inputs in the User Preferences menu of the SHD plugin. See page 49.

1, 2, 3, 4

Switch to the selected preset. Note that it takes a few seconds for the preset selection to complete, while the processor loads the new filters from its flash memory into the DSP.

[Bell]

Enable or disable Dirac Live filtering. Dirac Live filtering will be effective only on presets for which Dirac Live filters have been loaded.

Vol

Reduce or increase the volume. Each press changes the volume in 0.5 dB. Holding down a button will accelerate volume change to 3 dB steps.

Mute

Mute and unmute audio output.



6 THE SHD PLUGIN

The **SHD plugin** user interface application is one of two software programs that are used to configure the SHD Series processor. It is used to configure miniDSP's powerful back-end processing and for maintenance functions on the processor.

The SHD plugin is also used to start the separate **Dirac Live** application that does acoustic measurements and generates the room correction filters.

This section provides a summary of the plugin and how to use it. For full details of the processing blocks mentioned, see Section 8.



During *initial* configuration of the processor, it is strongly recommended that any connected amplification be powered off.

6.1 PLUGIN USER INTERFACE

The main user interface of the plugin has several areas, indicated in this screenshot:

The screenshot shows the miniDSP SHD 1.13d2 software interface. The main menu (File, Restore, Preferences, IR Remote, Help) is highlighted in green. The configuration selection area (Config 1, Config 2, Config 3, Config 4) is highlighted in blue. The selection tab (Routing, Outputs) is highlighted in red. The main configuration window (Dirac 1, Dirac 2, Routing) is highlighted in orange. The master control area (Connect, Mute, IP address, Start Dirac Live Software, Dirac Live OFF) is highlighted in purple.

Labels on the left side of the screenshot:

- Main menu
- Configuration selection
- Selection tab
- Main configuration window

Label on the right side of the screenshot:

- Master control

The screenshot shows the following configuration details:

- Configuration Selection: Config 1 (selected), Config 2, Config 3, Config 4
- Routing: Routing (selected), Outputs
- Dirac 1: 12dB, 0dB, -12dB, -24dB, -36dB, -48dB, -60dB, -72dB
- Dirac 2: 12dB, 0dB, -12dB, -24dB, -36dB, -48dB, -60dB, -72dB
- Routing:

	LSub	LFront	RSub	RFront
Dirac 1	0dB	0dB	Off	Off
Dirac 2	Off	Off	0dB	0dB
- Master control: Connect, Mute, IP address: [Auto], Master Volume, Start Dirac Live Software, Dirac Live OFF

6.2 CONNECTING TO THE PROCESSOR

Connect the SHD Series processor to a USB 2.0 port on your computer. Then click on the **Connect** button:



Once connected, the button changes to a green tick. For the sake of brevity, this is referred to as “online” whereas the disconnected state with the circular arrows is referred to as “offline.” When the plugin is online, any changes made in the SHD plugin are immediately transferred to the processor and will be heard in the audio signal. This is also referred to as “synchronized.”

If the processing parameters (routing, parametric EQ, crossovers and so on) stored on the computer do not match those stored in the processor, the synchronization dialog box will appear. The first time you connect, click on **Restore Config**. Thereafter, you will typically click on **Synchronize Config**.

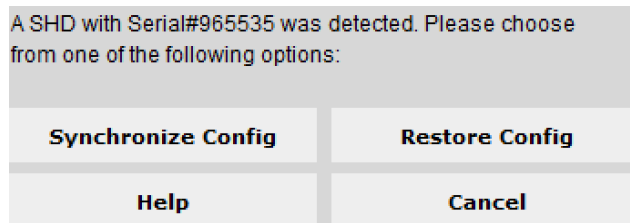

Restore Config

Restore the parameters in the currently selected preset to factory defaults. Note that Dirac Live filters are not reset. After restoring, the plugin is online.

Synchronize Config

Download all parameters from the SHD plugin to the processor. Note that Dirac Live filters are not changed. After downloading the parameters, the plugin is online.



When getting started with the plugin, to save doing this for each of the four configuration slots, drop down the Restore menu and select **Restore all to Default**.

If you have just upgraded the plugin, the following dialog box may appear. It is similar to the previous options, but also upgrades the processor’s internal data and software. The **Restore ALL to Default** option will reset all four presets to default.

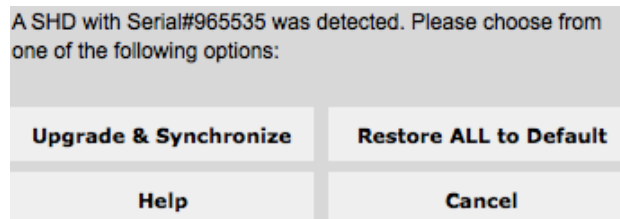

6.3 KEY FEATURES

This section summarizes the key features of the plugin.

6.3.1 Master control

When the plugin is online, the items in the Master Control area are active. The **Mute** button disables all audio output:



The **Master Volume** display shows the current volume setting. The master volume can be set by clicking here and typing a new value:

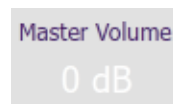

The **Start Dirac Live Software** button starts the separate **Dirac Live** application. When this button is pressed, the SHD plugin will disconnect from the SHD Series processor and then start up **Dirac Live**.

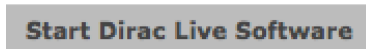

You **must** start the Dirac Live application from within the SHD plugin using the **Start Dirac Live Software** button. If you open the Dirac Live application by itself, it will not be able to detect the SHD Series processor.

The **Dirac Live** button turns Dirac Live processing on and off:

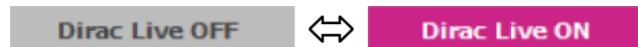

The **IP Address** and **Auto** fields are for networked control of the plugin using the miniDSP [WI-DG Wifi/Ethernet to USB bridge](#). See the [Wi-DG User Manual](#) for details.

6.3.2 Configuration/preset selection

The data that controls the back-end audio processing of the SHD Series processor is called a *configuration*. This includes crossovers, parametric EQ and routing. It does not include master volume or mute status.

Four configurations are stored onboard as presets. The currently selected configuration preset is indicated by a dark background:



To switch to a different configuration preset, just click on the desired button:



When the configuration preset is changed, the corresponding Dirac Live filters are also loaded into the processor’s memory.

6.3.3 Inputs

The **Routing** tab displays two input channel status strips. Note that these are status only – there are no user-adjustable controls. They are active only when the plugin is online.

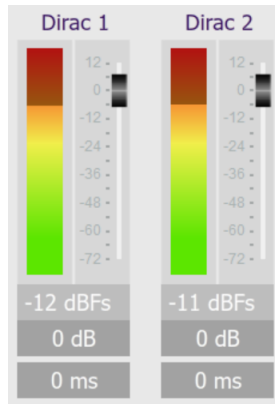

6.3.4 Input selection

When the plugin is online, the currently selected input appears next to the “Dirac Inputs” label. Click on the current input name to drop down a selector menu, from which you can select a different input.

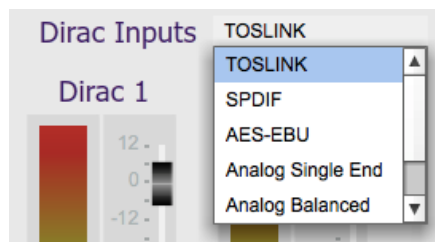

6.3.5 Routing matrix

The Routing matrix directs input channels (along the left) to output channels (along the top). Click on the button at a cross-point to enable or disable routing from the corresponding input to output. Both inputs can be mixed to an output, with the mix level set individually for each input.

	Output1	Output2	Output3	Output4
Dirac 1	0dB	Off	Off	Off
Dirac 2	Off	0dB	Off	Off

6.3.6 Outputs

The **Outputs** tab displays a row of four output channel control strips. All output channels are identical.

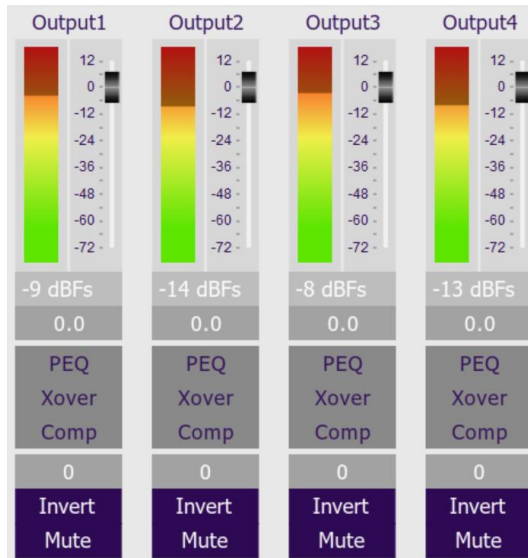

Each channel has an individual gain adjustment slider and a graphical and numerical display of the current signal level on that channel. A comprehensive set of signal processing functions is accessed with the buttons PEQ (parametric EQ), Xover (crossover) and Comp (compressor/limiter). Each channel also has individual time delay, invert, and mute.

6.4 SETTING USER PREFERENCES

To access user preferences, drop down the Preferences Menu:

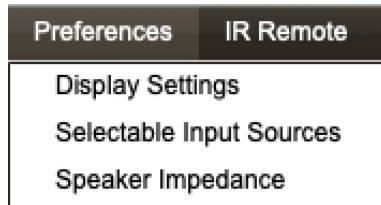

6.4.1 Display Settings

The front panel display can be automatically dimmed or turned off after a user-configurable timeout. To turn it off, select **Turn off** and set the time delay:

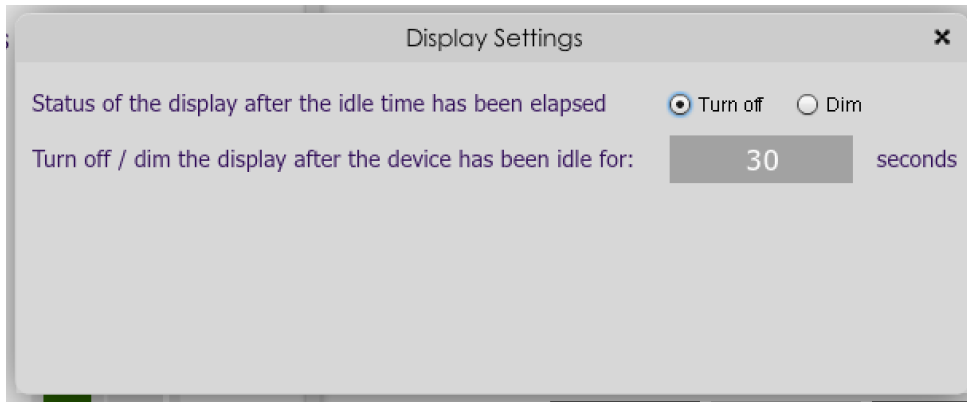

To dim the display, select **Dim** and set the time delay and brightness.

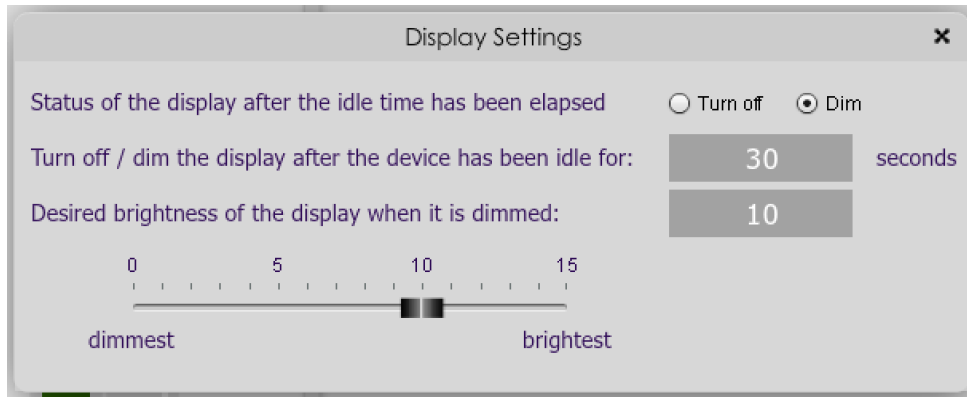

To prevent the display from dimming, set the brightness to 15.

6.4.2 Selectable Input Sources

Select the input sources that you want to cycle through with the remote control and the front panel encoder. The choice of inputs depends on the specific processor model. For example, here is the screen for the SHD:

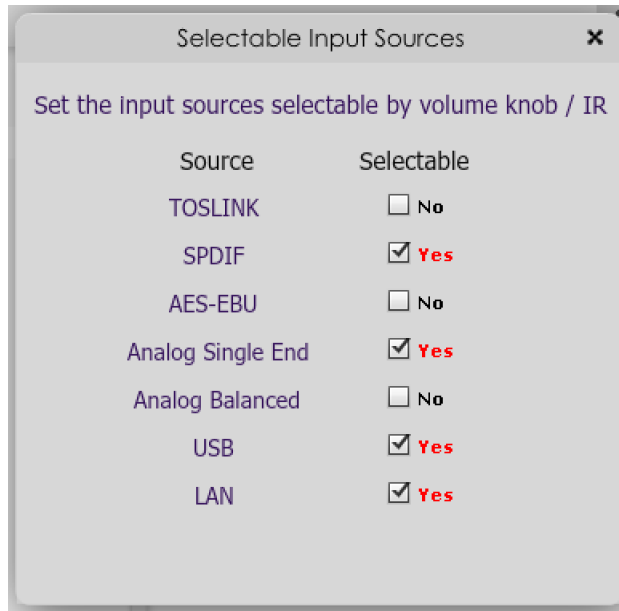

With the setting shown above, only SPDIF, RCA, USB and LAN will be cycled through when using the front panel encoder knob or remote control.

Note that this setting has no effect on the input selection dropdown menu in the plugin.

6.4.3 Speaker Impedance (SHD Power only)

The Speaker Impedance setting activates over-current protection. By default, this is set to **8 ohm**, meaning that the amplifier does not have over-current protection enabled. Change the setting to **4 ohm** to activate over-current protection.

Over-current protection limits output power to 120 Watts regardless of load impedance. Without it, low impedance loads can cause the amplifier to shut down at high levels. It is recommended that over-current protection always be enabled if testing the amplifier with low impedance loads. In some cases, such as driving low-impedance speakers at high levels, this setting can be helpful to guard against amplifier shutdown.

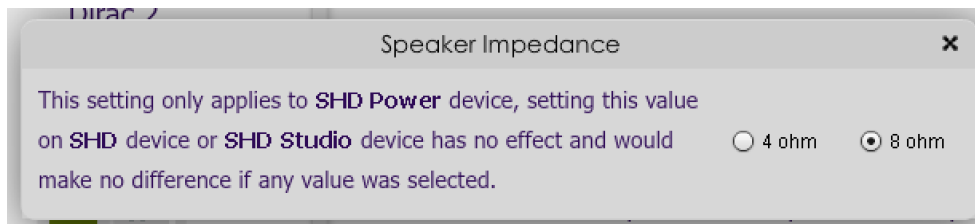

6.5 SIGNAL FLOW

If you intend to run a configuration that is more than straight stereo room correction processing, then you will need to configure the back-end processing prior to running Dirac Live calibration. Typically, this applies to applications such as subwoofer integration and two-way active speakers.



If you are using straightforward stereo room correction with a pair of speakers, you don't need to read the rest of this section. In that case, proceed to Dirac Live calibration as described in the separate [miniDSP Dirac Live User Manual](#).

To understand how the SHD Series processor combines Dirac Live with miniDSP's audio processing, refer to the signal flow diagram in Figure 3:

- One of the stereo input sources is selected by the user and passed to two channels of Dirac Live processing for digital room correction.
- The outputs from Dirac Live, labeled "Dirac 1" and "Dirac 2" in the plugin UI, are routed and mixed to the four output channels.
- Each output channel has a comprehensive set of DSP functions. These are all optional – you can configure them if you want to, according to your particular application.

As indicated in Figure 3, the processor is configured by two different software applications. The **Dirac Live** application runs room measurements and loads correction filters into one of four presets. The **SHD plugin** configures back-end processing for each of the four presets. When a preset is selected (e.g. with the front panel or remote control), the corresponding Dirac Live filters **and** the SHD plugin configuration are loaded into the working DSP memory.

While the description of the signal processing flow is from inputs to outputs (left to right in the diagram), the order in which you configure the processor is usually the reverse. That is, configure the processing in the SHD plugin first and run Dirac Live calibration second.

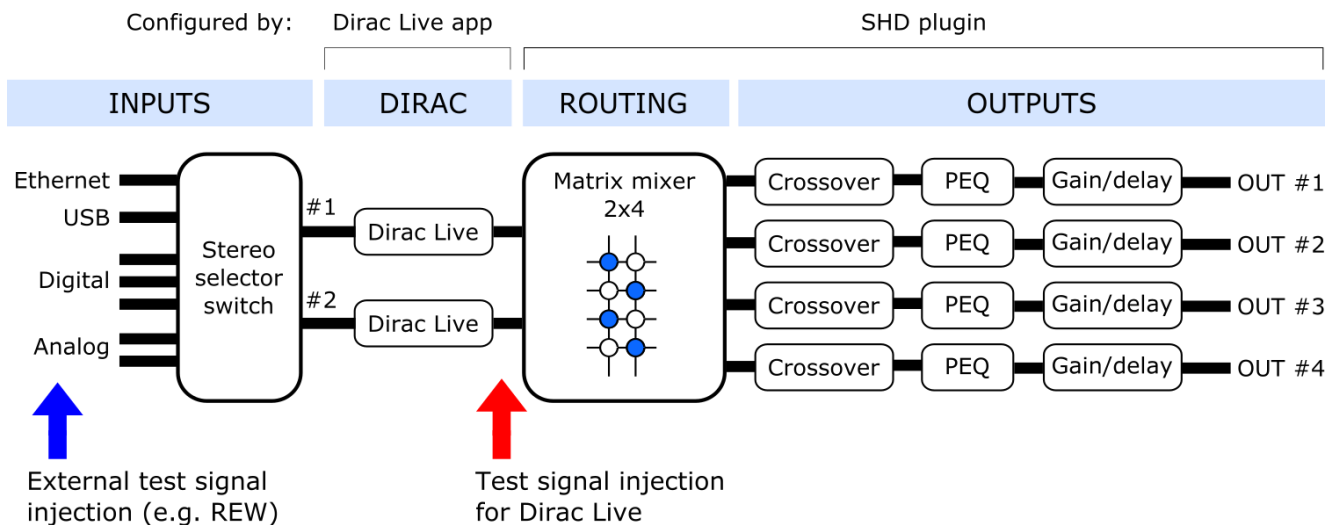

Figure 3. SHD Series signal flow diagram

6.6 CONFIGURATION FOR SUBWOOFER INTEGRATION

The SHD Series processors easily support integration of a subwoofer into your audio system. This section describes how. After configuring the processor to add the subwoofer, Dirac Live calibration will correct the combined response of the speakers and sub.

6.6.1 Connect the subwoofer

Connect the speakers to output channels 1 and 2 (via a power amplifier) and the subwoofer to output channel 3. If you have the SHD Studio, you will need a second external DAC for the subwoofer.

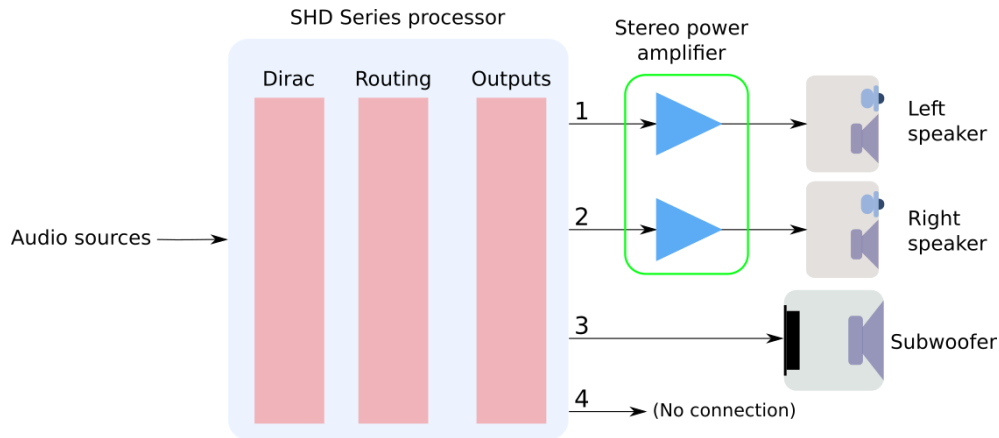

6.6.2 Configure the plugin

Configure the **Outputs** tab:

1. Click on the label at the top of each output channel strip and rename them (from left to right) to “Left Sp”, “Right Sp”, “Sub” and “Unused”. It’s not *necessary* to name the output channels, but it’s helpful when configuring to avoid mistakes.

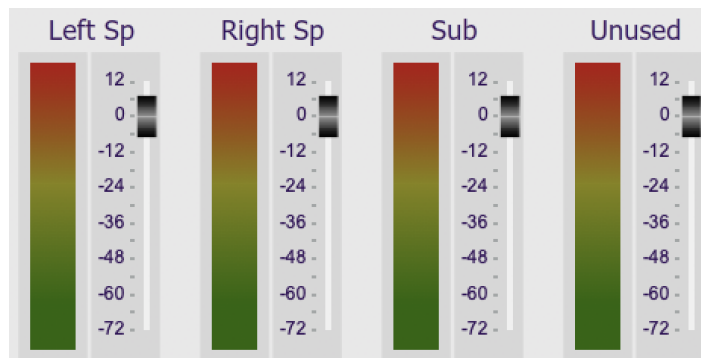

2. Mute channel 4 (“Unused”). Again, this is a useful and easily visible flag that this channel is not being used.

- Click on the Xover button for channel 1 and link it to channel 2 (“Right Sp”).

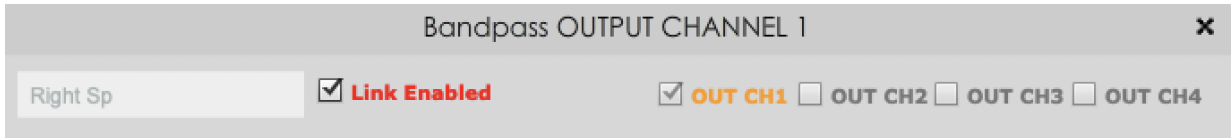

- Set up the crossover filters. On channels 1 and 2 (the speakers), enable the high pass filter. On channel 3 (the subwoofer), enable the low pass filter. A good starting point is to set these at 80 Hz, BW 24dB/oct (Butterworth 24 dB/octave). For smaller or bookshelf speakers, you can set it higher at 100 Hz, or even 120 Hz if the subwoofer is located somewhere between the speakers.

This is the high pass filter for channels 1 and 2:

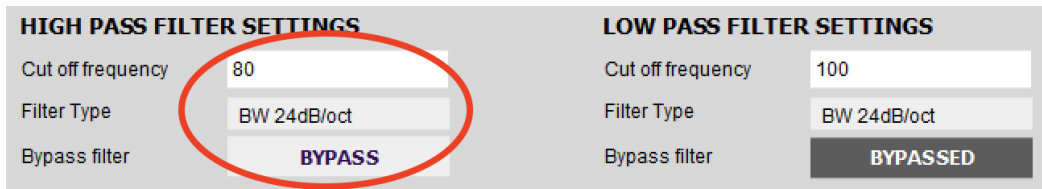

This is the low pass filter for channel 3:

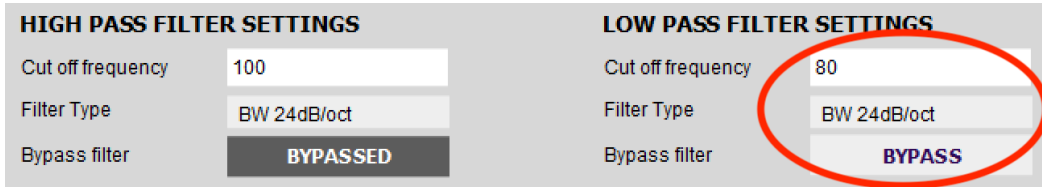

On the **Routing** tab, set the matrix like this:

	Left Sp	Right Sp	Sub	unused
Dirac 1	0dB	Off	0dB	Off
Dirac 2	Off	0dB	0dB	Off

Play some music with heavy bass content and confirm that the subwoofer is operating as expected. If your subwoofer has a volume control, adjust it so that the sub sounds a bit louder than it should. Or, adjust the level of the subwoofer output channel in the plugin.

At this point, you can proceed with Dirac Live Calibration as described in the separate [miniDSP Dirac Live User Manual](#). Once you have measured the center position with Dirac Live, you can check for major integration issues as described on the next two pages.

You can also use Room EQ Wizard (REW) as described in this application note on our website:

- [Subwoofer Integration with the miniDSP SHD and REW](#)

6.6.3 Check subwoofer integration (optional)

Once you have made a single measurement with Dirac Live, you can use this measurement to perform a confidence check on your subwoofer integration. In general, while Dirac Live will correct for many irregularities in the response, a poor integration can prevent this or cause other issues.

To check the frequency response based on the single measurement made so far:

1. Click on the **Proceed to Filter Design** button.
2. Dirac Live will warn you that you have only made one measurement. Click on “Proceed with 1 measurement.”
3. Examine the frequency response plots of the left and right channels.

If you decide to make a change in the plugin parameters:

4. Quit the Dirac Live application.
5. Click **Connect** in the SHD Plugin.
6. Make the change in the plugin.
7. Click on the **Start Dirac Live Software** button and start the calibration procedure again.

Level imbalance

While Dirac Live will correct the response if the subwoofer level is too high or too low, other issues can arise. For example, in the graph on the left of Figure 4, the response at 80 Hz is about 10 dB too high due to the subwoofer, causing the effective crossover frequency to be higher than expected (about 110 Hz in this example).

If the subwoofer level is too low as shown on the right of Figure 4, Dirac Live will need to apply additional boost to the subwoofer. This will reduce boost available for correcting for room modes. In addition, the low roll-off frequency of the system will tend to increase.

A level imbalance can be corrected by adjusting the volume control on your subwoofer if it has one, or by changing the output level of the subwoofer channel in the plugin.

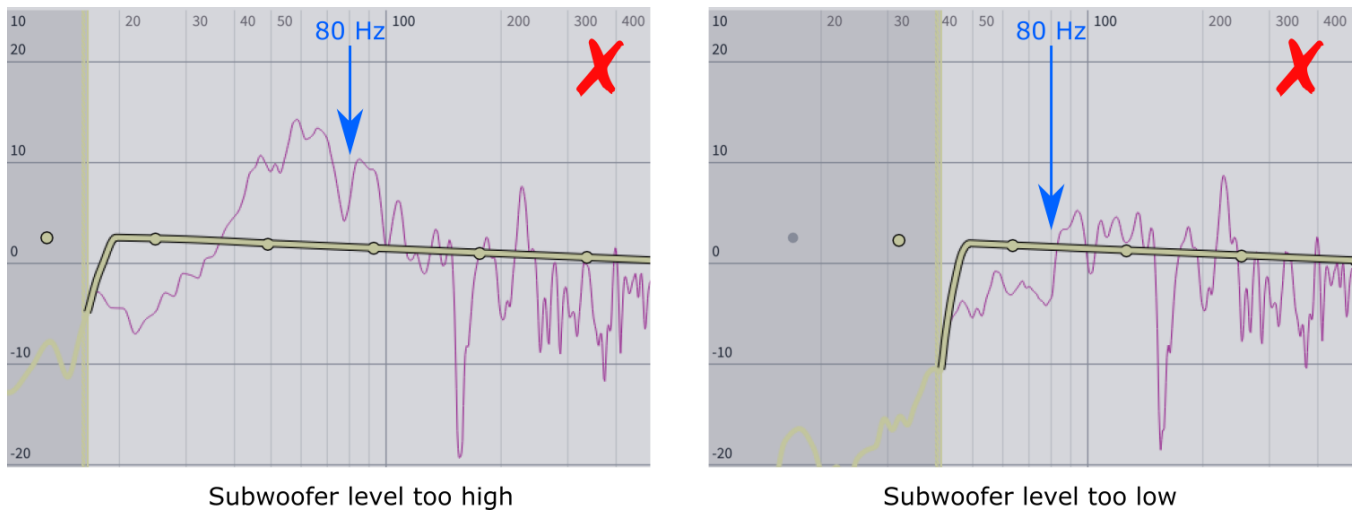

Figure 4. Examples of subwoofer level imbalance

Energy dips around crossover

There is usually no need to worry about dips in the measured response, as these move around with different measurement positions and Dirac Live will make the most sensible correction possible. If, however, you see a deep wide “hole” near the crossover frequency, this may result in the speaker or subwoofer being driven harder than really necessary after Dirac Live applies its correction. With a small speaker, this can also result in significantly increased distortion.

The response on the left of Figure 5 shows a significant “hole” around the crossover frequency. A simple technique that may correct this is to use the plugin to invert the phase of the subwoofer channel:



The result is shown on the right of Figure 5.

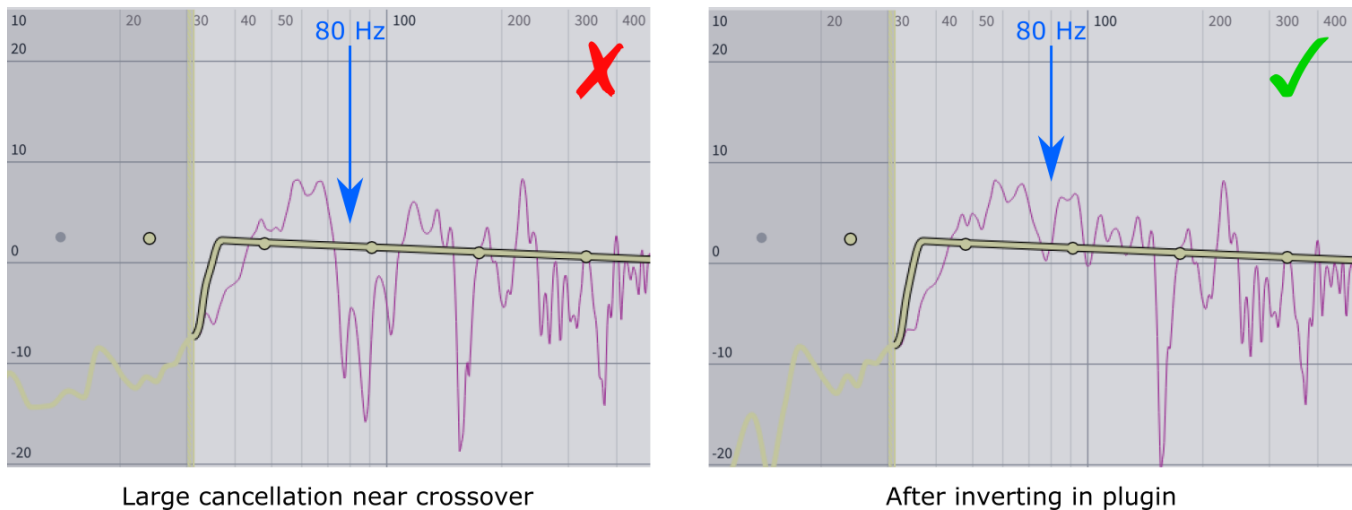

Figure 5. Example showing effect of subwoofer inversion

Subwoofer location

The measured frequency response of a subwoofer varies a lot depending on its location in the room. If you find yourself unable to achieve satisfactory integration, try moving the subwoofer to a different location. You may want to do this with the aid of Room EQ Wizard (REW) or a similar program. To get started with measurements with REW, see these application notes on our website:

- [UMIK-1/2 setup with REW](#)
- [Acoustic measurement with the UMIK-1 and REW](#)

Advanced techniques

If level adjustment and/or inverting the subwoofer don't produce a satisfactory integration, more advanced adjustment in the plugin may be required. See this application note on our website:

- [Subwoofer Integration with the miniDSP SHD and REW](#)

6.7 OTHER CONFIGURATIONS

This section provides a quick overview of other SHD configurations. In general, it is recommended that you take acoustic measurements with Room EQ Wizard or a similar program to set up and fine-tune your configuration. After you have set up the configuration, save it to a file. Then click on the **Start Dirac Live Software** button and run a Dirac Live calibration.

6.7.1 Dual subwoofers

The configuration for dual subwoofers is a simple extension of that for a single subwoofer. Connect the additional subwoofer to output 4:

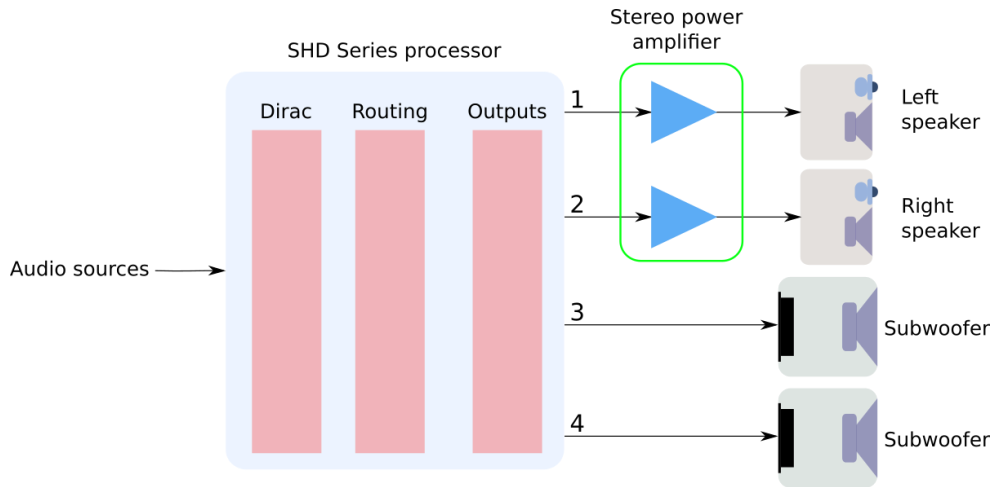

The main change is to the Routing tab, which will now look like this:

	Left Sp	Right Sp	Sub 1	Sub 2
Dirac 1	0dB	Off	0dB	0dB
Dirac 2	Off	0dB	0dB	0dB

That is, left and right channels are being summed together and sent to channels 3 **and** 4. You will also need to set the low pass filter on output channel 4.

From there, proceed as described for the single subwoofer configuration.

A more advanced approach is to use the signal processing blocks on each output channel to change the signal sent to each subwoofer. For guidance, see these application notes on our website:

- [Tuning multiple subwoofers with miniDSP](#)
- [Dual-sub integration with miniDSP and MultiSub Optimizer](#)

The first application note is focussed on home theater, but the techniques can be applied to a stereo system with dual subwoofers. The second application note is more advanced and uses a program called Multi-sub Optimizer to generate optimizations for the two subwoofers.

Note: If you intend to use “stereo subwoofers,” see Stereo supporting woofers below instead.

6.7.2 Stereo supporting woofers

An alternative approach to enhancing bass reproduction in a stereo system is to use two “supporting” woofers – one under or near each speaker. They could be subwoofers capable of producing very deep and loud bass or woofers of the type normally used in a three-way speaker.

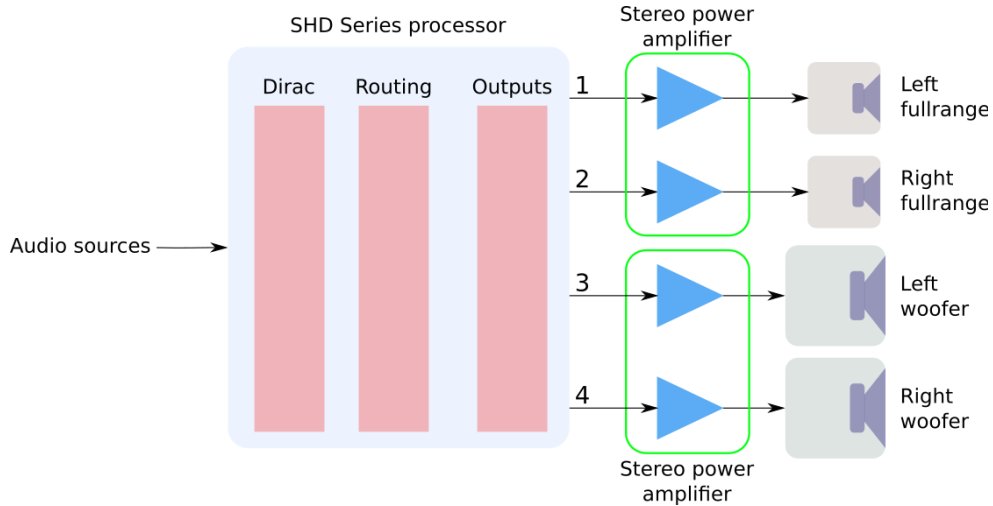

In this type of configuration, use crossover filters to split the frequency range to the woofers and main speakers. The crossover frequency may range from 80 Hz for true subwoofers up to perhaps 300 Hz for smaller woofers.

On the **Outputs** tab:

- Rename the output channels (from left to right) to “Left FR”, “Right FR”, “Left W” and “Right W”.
- Set a high pass crossover filter on channels 1 and 2 (“Left FR” and “Right FR”). For example:

HIGH PASS FILTER SETTINGS		LOW PASS FILTER SETTINGS	
Cut off frequency	200	Cut off frequency	100
Filter Type	LR 12dB/oct	Filter Type	BW 24dB/oct
Bypass filter	BYPASS	Bypass filter	BYPASSED

- Set a low pass crossover filter on channels 3 and 4 (“Left W” and “Right W”). For example:

HIGH PASS FILTER SETTINGS		LOW PASS FILTER SETTINGS	
Cut off frequency	100	Cut off frequency	200
Filter Type	BW 24dB/oct	Filter Type	LR 12dB/oct
Bypass filter	BYPASSED	Bypass filter	BYPASS

On the **Routing** tab, set the matrix like this:

	Left FR	Right FR	Left W	Right W
Dirac 1	0dB	Off	0dB	Off
Dirac 2	Off	0dB	Off	0dB

6.7.3 Two-way active speaker

An SHD Series processor can implement a two-way active speaker as well as provide room correction in the one box. This diagram illustrates a typical set of connections:

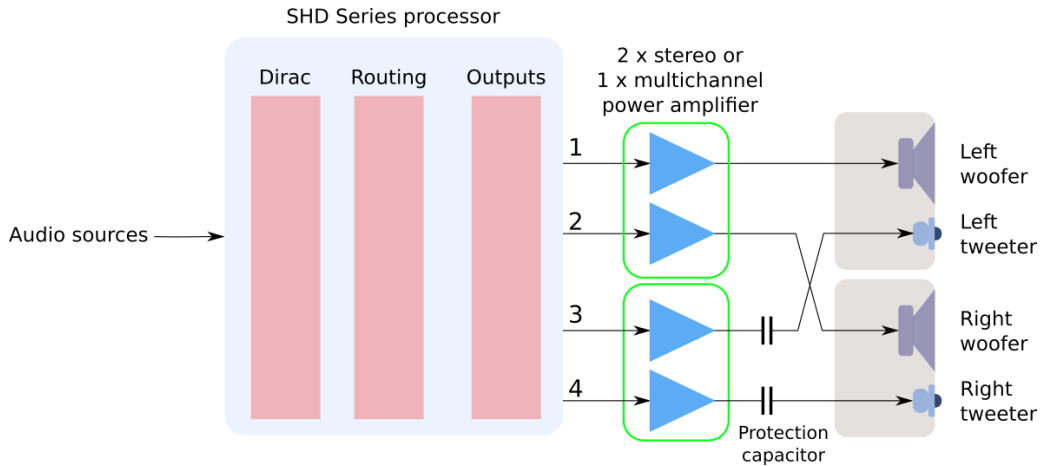

On the **Outputs** tab, rename the output channels to “Left W”, “Right W”, “Left Tw”, and “Right Tw”.

On the **Routing** tab, set the matrix like this:

	Left W	Right W	Left Tw	Right Tw
Dirac 1	0dB	Off	0dB	Off
Dirac 2	Off	0dB	Off	0dB

On the **Outputs** tab again:

- Use REW to measure each individual driver (woofer and tweeter) and equalize their response flat with the PEQ blocks. This procedure is the same as for the 2x4 HD, as described in the application note [Designing a 2-way active speaker with the miniDSP 2x4 HD](#) on our website.
- Set up your high pass and low pass crossover filters. This procedure is the same as for the 2x4 HD, as described in the application note linked above. This is a typical low pass setting for the woofers:

HIGH PASS FILTER SETTINGS		LOW PASS FILTER SETTINGS	
Cut off frequency	100	Cut off frequency	3000
Filter Type	BW 24dB/oct	Filter Type	LR 24dB/oct
Bypass filter	BYPASSED	Bypass filter	BYPASS

This is a typical high pass setting for the tweeters:

HIGH PASS FILTER SETTINGS		LOW PASS FILTER SETTINGS	
Cut off frequency	3000	Cut off frequency	100
Filter Type	LR 24dB/oct	Filter Type	BW 24dB/oct
Bypass filter	BYPASS	Bypass filter	BYPASSED

7 DIRAC LIVE CALIBRATION

Dirac Live calibration with the miniDSP SHD is described in the separate [miniDSP Dirac Live User Manual](#). It can be downloaded from the [SHD Series product page](#) on our website.



Be sure to start the Dirac Live application from within the SHD plugin using the **Start Dirac Live Software** button. If you open the Dirac Live application by itself, it will not be able to detect the SHD Series processor.



8 PLUGIN REFERENCE

This section provides full details on each of the plugin processing blocks.

8.1 INPUT CHANNEL STATUS

Each input channel strip displays useful information about the levels and Dirac settings on that channel. The plugin must be online to display this information.

Channel label

The name of the channel. These are set to “Dirac 1” and “Dirac 2” and cannot be renamed.

Level meter, Current RMS level

Displays the current signal level in real time.

Dirac Live level

Graphical and numerical display of the gain (in dB) that Dirac Live has set for this channel.

Dirac Level delay

Numerical display of the delay (in milliseconds) that Dirac Live has set for this channel.

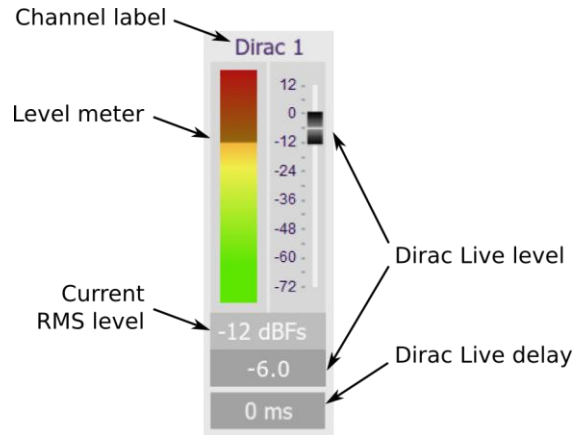

8.2 ROUTING

The **Routing** matrix mixer is used to direct input channels (along the left) to output channels (along the top). Click on the button at a cross-point to enable or disable routing from the corresponding input to output.

The gain of the signal being mixed can be adjusted to a value between -72 and +12 dB. To adjust the gain, right-click on the cross-point and a gain control will appear. Adjust the gain with the slider or by typing in the value directly, then click **close**.

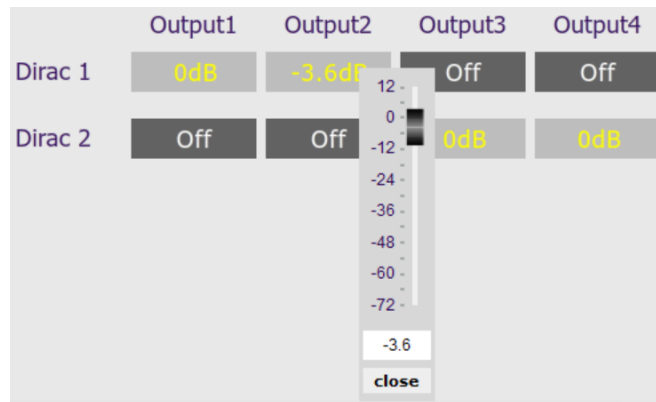

SHD Studio only. For headphone use, create a preset that routes Dirac 1 to Output1 and Dirac 2 to Output2. This preset should not have Dirac Live room correction filters loaded.

8.3 OUTPUT CHANNELS

Each output channel has its own control strip:

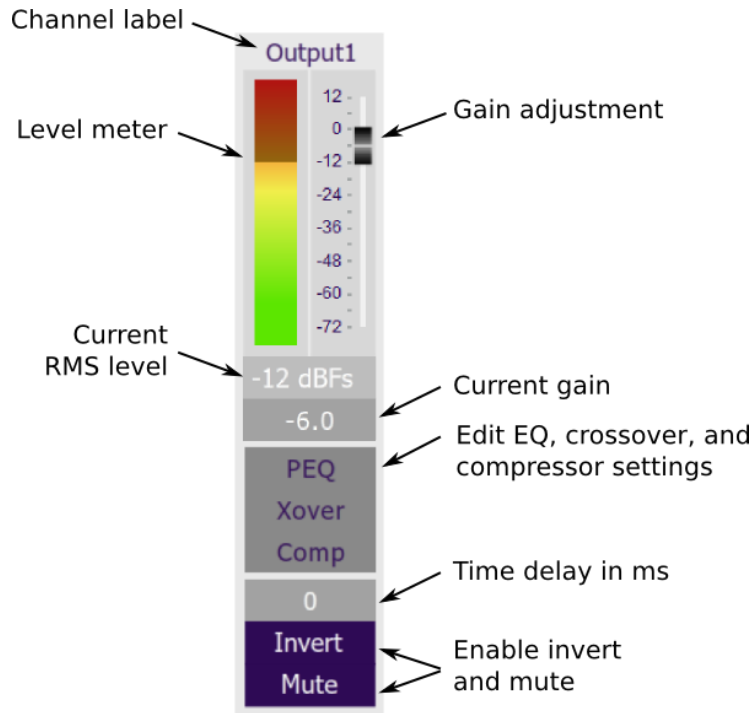

8.3.1 Channel label

Each output channel has a customizable label, which is shown at the top of the channel strip. This label also appears on the **Routing** matrix. To change the label, click on it, type a new label (up to eight characters), and press the Return key.

8.3.2 Level metering and gain adjustment

Level meter, Current RMS level

These display the current output signal level on the channel graphically and numerically in real time. The plugin must be online to display signal levels.

Gain adjustment, Current gain

Change the gain of the output channel by moving the Gain Adjustment slider, or by typing the desired gain into the Current Gain text box. The maximum gain setting is 12 dB, and the minimum gain setting is -72 dB. (0 dB, the default, is unity gain or no change in level.)

8.3.3 Parametric EQ

Parametric equalization (PEQ) is a flexible type of equalization filter. It can be used to correct for errors in loudspeaker output, to compensate for acoustic room effects, and to tailor the overall system response for best sound. Click on the PEQ button to open the parametric equalizer settings window:

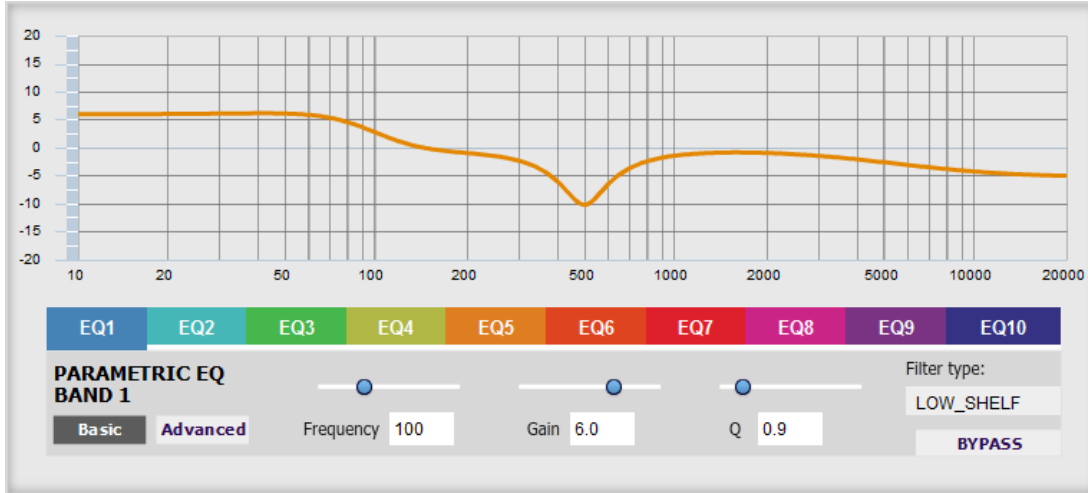

There are ten parametric EQ filters on each output channel. The window displays a frequency response graph showing the combined response of all enabled parametric filters on that channel. For example, the response curve above has a low-shelf boost at 100 Hz, a dip at 500 Hz, and a high-shelf cut at 5000 Hz.

Hovering the mouse over the curve brings up an overlay showing the frequency and the gain at that frequency.

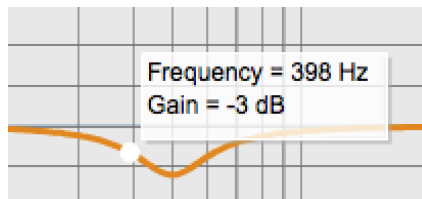

Each channel can be linked to one other channel. When a channel is linked to another, the PEQ settings of that channel are mirrored to the other. Typically, corresponding channels on the left and right are linked: for example, left and right tweeter and left and right woofer. To link a channel, select the other channel from the drop-down menu at the top left of the **PEQ** display, and click the **Link** checkbox.



EQ band selection

Click on the tabs **EQ1**, **EQ2**, etc. to display the parameters of that filter.

Basic/Advanced

By default, each filter is in basic mode, and shows the controls described below. Advanced mode enables custom biquad programming for almost infinite flexibility in filter implementation. This is described in [Custom biquad programming](#) on page 66.

Filter type

Selects the type of filter:

PEAK

Create a dip or a peak in the frequency response.

LOW_SHELF

Reduce or increase part of the frequency spectrum *below* a given frequency.

HIGH_SHELF

Reduce or increase part of the frequency spectrum *above* a given frequency.

SUB_EQ

Create a dip or a peak in the frequency response at low frequencies (10 to 50 Hz). This filter type is similar to PEAK but gives more accurate results for low frequencies. Note that activating any SUB_EQ filter reduces the number of available filters on that channel from ten to nine.

Frequency

For the PEAK and SUB_EQ filter types, this is the center frequency of the peak or dip. For the HIGH_SHELF and LOW_SHELF filter types, this is the frequency at which the gain is half of the set value.

Gain

For the PEAK and SUB_EQ filter types, this is the gain in dB at the center frequency. For the HIGH_SHELF and LOW_SHELF filter types, this is the gain in dB reached at high or low frequencies respectively. A filter has no effect if its gain is set to 0 dB. Gain can be adjusted in increments of 0.1 dB up to +/- 16 dB.

Q

Q controls the "sharpness" of the filter. For the PEAK and SUB_EQ filter types, lower Q gives a broader peak or dip, while higher Q gives a narrower peak or dip. For the HIGH_SHELF and LOW_SHELF filter types, Q controls how quickly the filter transitions from no gain to maximum gain.

Bypass

The **Bypass** button enables or disables a filter. The filter is bypassed if the button is "lit". (Note that all other filters are still operational unless individually bypassed.) A filter will also have no effect if its gain is set to 0.0.



8.3.4 Crossover

Each output channel has independent high pass and low pass crossover filters. Click on the **Xover** button to open the crossover settings window:

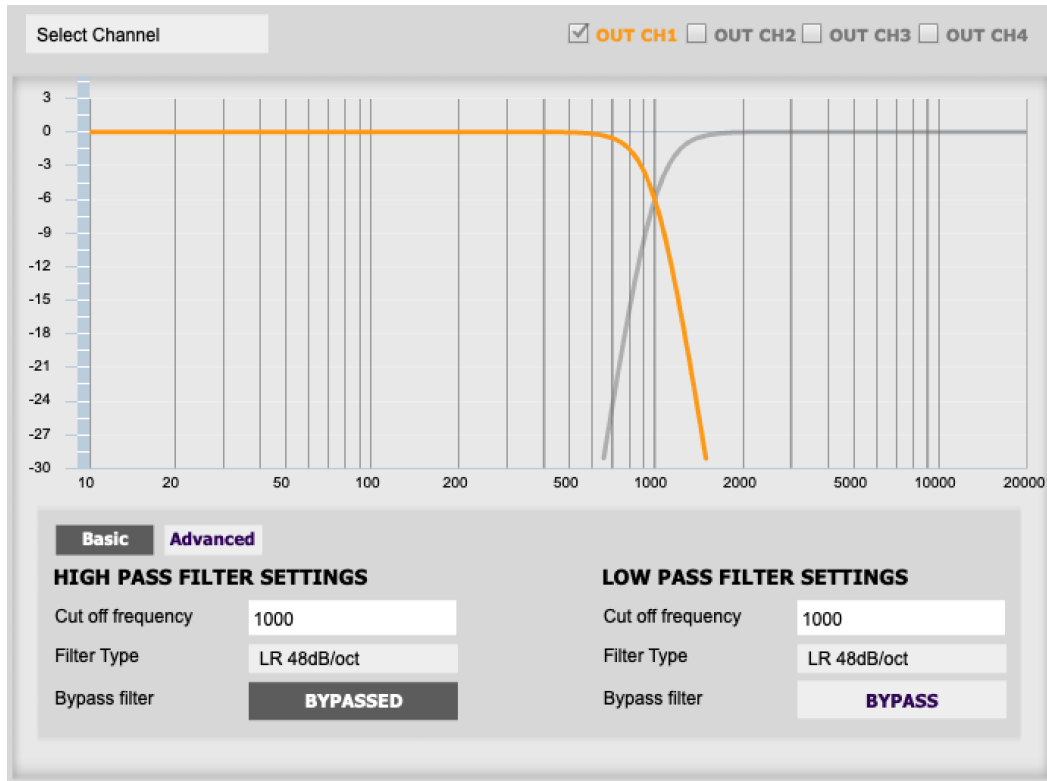

Crossovers “split” the frequency band to send to different drivers. In a two-way loudspeaker, a *low pass* filter is used to remove high frequencies from the signal sent to the woofer, and a *high pass* filter is used to remove low frequencies from the signal sent to the tweeter. When integrating a subwoofer, high pass filters are used on the speakers and a low pass filter on the subwoofer. A crossover filter can also be used to limit low frequency content delivered to a speaker or subwoofer, to help protect it from over-excursion.

Unlike conventional analog crossovers, the flexibility of DSP allows a completely arbitrary mix of different filter slopes and types. Filters can be set at any frequency or disabled completely. This allows maximum flexibility in matching your crossover to the acoustic characteristics of the loudspeaker drivers.

The current channel is displayed in orange, with the others displayed in grey. Hovering the mouse over the curve brings up an overlay showing the frequency and the attenuation at that frequency.

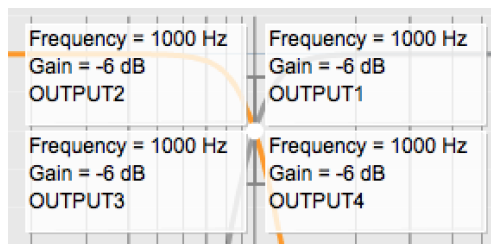

Basic/Advanced

By default, the crossover is in basic mode, and shows the controls described below. Advanced mode enables custom biquad programming for almost infinite flexibility in crossover filter implementation. This is described in [Custom biquad programming](#) on page 66.

Cutoff Frequency

Sets the nominal cutoff frequency of the crossover. In actual fact, the crossover has a more or less gradual transition from “full on” to “full off,” as determined by the filter slope.

Filter type

Selects the type and slope of the filter. The steeper the slope, the more quickly frequencies above or below the cutoff frequency are attenuated. There are three types of filter:

Butterworth (BW)

Available in 6, 12, 18, 24, 30, 36, 42, and 48 dB/octave, Butterworth crossover filters are 3 dB down at the cutoff frequency.

Linkwitz-Riley (LR)

Available in 12, 24, and 48 dB/octave, Linkwitz-Riley crossover filters are 6 dB down at the cutoff frequency.

Bessel

Available in 12 dB/octave only, a Bessel filter gives a more gradual roll-off through the crossover region.

Bypass

Clicking on the **Bypass** button disables or enables that high pass or low pass filter. The filter is bypassed when the button is "lit".



Each channel can be linked to one other channel. When a channel is linked to another, the crossover settings of that channel are mirrored to the other. Typically, the corresponding drivers on the left and right channels are linked: left and right tweeter, left and right woofer, and so on. To link a channel, select the other channel from the drop-down menu at the top left of the **Xover** display, and click the **Link** checkbox.



8.3.5 Compressor

The compressor reduces the gain of an output channel when the audio signal reaches the level specified by the **Threshold** parameter. The gain of the channel will be progressively reduced as the signal increases above the threshold, according to the **Ratio** parameter. This can be used to limit the power delivered to speakers and thus reduce the risk of damage from overdriving.

This screenshot shows an example Compressor setting:

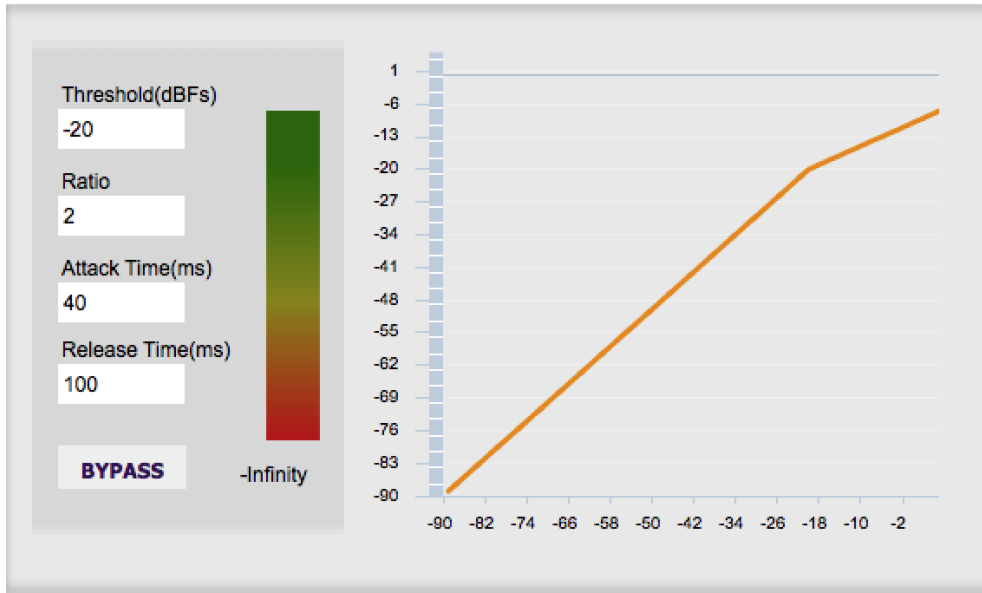

(Note that the compressor algorithm is bypassed by default, so click on the **Bypass** button to see the curve as shown here.)

In this example, the threshold is set to -20 dB, so the compressor will activate when the signal on that channel reaches -20 dB (relative to full output). The ratio is set to 2, so if the input signal level to the compressor then increases by 10 dB, the output level will increase by only 5 dB. If the input signal level to the compressor is at full scale (0 dB), then the output level will be limited to -10 dB.

Two additional parameters control the action of the compressor: the attack time and the release time. These two parameters govern how quickly the compressor activates when the signal level exceeds the threshold, and how quickly it deactivates when the signal level reduces. The optimum settings may need to be tuned by ear. For more information, see the Wikipedia article [Dynamic range compression](#).

8.3.6 Invert and mute

Each channel can be inverted in polarity and individually muted. When either of these options is selected, the visual indicator on the button is "lit":

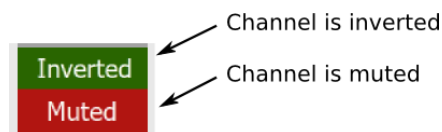

8.3.7 Time delay

A delay of up to 30 ms can be applied to each output channel. To set the delay, click in the delay entry box for a channel. The delay value can be entered numerically, and the up and down arrows can be used to change the delay in small (0.02 ms) increments.

The time delay corresponds to a distance. This distance is shown in centimeters below the entry box. The maximum time delay of 30 ms corresponds to a distance of approximately 10.3 meters (about 35 feet).

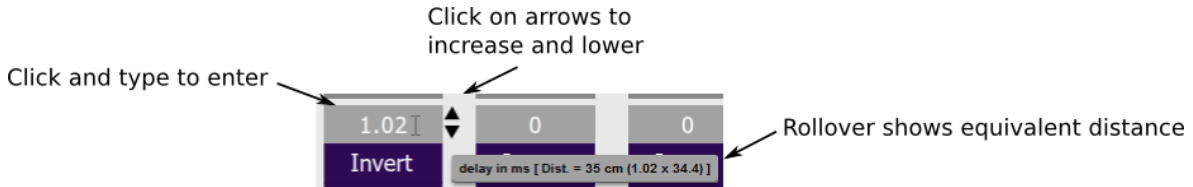

Note: The Dirac Live analysis algorithm *also* sets a time delay on the left and right channel. The time delay on the output channels should be used to time-align drivers for a two-way loudspeaker or to optimize subwoofer integration *before* doing Dirac Live calibration.

8.4 CUSTOM BIQUAD PROGRAMMING

Custom biquad programming is available in the PEQ and Crossover blocks. Its purpose is to allow you to directly provide the *biquad coefficients* that control the digital filters of the processor, thus providing an almost infinite degree of flexibility.

For example, you can create hybrid crossovers with staggered cutoff frequencies, create parametric EQ filters beyond those provided in the easy-to-use “basic” interface, implement a Linkwitz transform, or mix crossover and EQ biquads in the same block.

8.4.1 What’s a biquad?

A biquad is the basic unit of processing that is used to create digital filters. It can be described either with an equation or with a signal flow diagram, as shown here:

$$H(z) = \frac{b_0 + b_1 z^{-1} + b_2 z^{-2}}{1 + a_1 z^{-1} + a_2 z^{-2}}$$

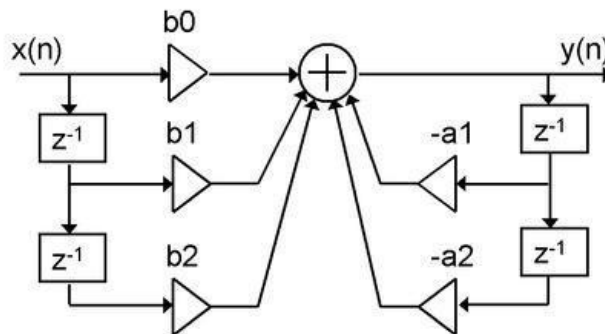

A single biquad like this can perform a great many functions, including all of the functions of a single parametric EQ filter, one 6 or 12 dB/octave high pass or low pass crossover filter, and more. Biquads are combined in series (cascaded) to create more complex filters. The function that each biquad performs is determined by just five numbers: b_0 , b_1 , b_2 , a_1 , and a_2 . These numbers are called the *coefficients*.

8.4.2 Using custom biquad programming

Each crossover block and PEQ filter has a selector that switches it to advanced mode:



In advanced mode, the biquad coefficients can be pasted directly into the user interface. These coefficients must be calculated using design software – see [Biquad design software](#) for suggestions.

Parametric EQ advanced mode

In the parametric EQ blocks, advanced mode allows each individual filter to be specified by its biquad coefficients. After pasting in the coefficients, click on the **Process** button.

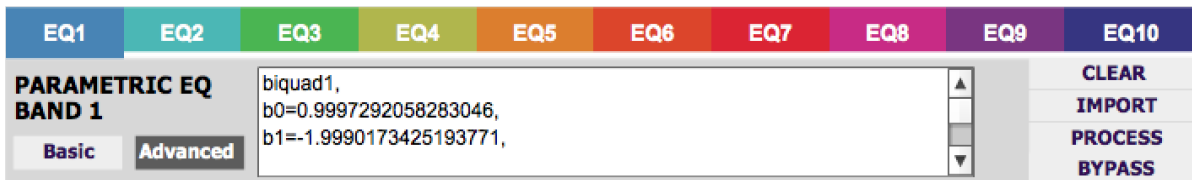

Parametric EQ file import (REW integration)

Multiple biquads in the parametric EQ block can be set at once by importing a coefficient file. This file can be generated by Room EQ Wizard (REW) or other applications. The design software must be set for a **96 kHz** sample rate. The number of filters is limited to a maximum of ten.

This example illustrates the correct file format:

```

biquad1,
b0=0.998191200483864,
b1=-1.9950521500467384,
b2=0.996920046761057,
a1=1.9950521500467384,
a2=-0.9951112472449212,
biquad2,
...
biquad3,
...
biquad4,
...
biquad10,
b0=1.0010192374642126,
b1=-1.9950555192569264,
b2=0.9940580112181501,
a1=1.995060938714333,
a2=-0.9950718292249559
    
```

Note that the last line must not have a comma at the end. If the file has less than ten biquads, then only that number of biquads will be imported. For example, if importing a file with six biquads, the first six filters will be set, and the last four will not be changed. (Note: if the last line ends with a comma, that counts as an extra biquad.)

If the file contains more than ten biquads, then an error will be reported and no filters will be changed.

Crossover advanced mode

The **Crossover** blocks have eight biquads for each output channel. In **Advanced** mode, all eight biquads need to be specified. After pasting in the coefficients, click on the **Process** button for them to take effect.



8.4.3 Biquad design software

Here are some ways to design your biquad coefficients.

Biquad calculation spreadsheet

The community-developed biquad calculation spreadsheet allows many filter types to be calculated, including notch filters, Linkwitz transforms, and filters with arbitrary Q-factor. Access this spreadsheet here (requires Microsoft Excel):

- http://www.minidsp.com/images/fbfiles/files/All_digital_coefs_v1-20101026.zip

Room EQ Wizard (REW)

Room EQ Wizard is a free acoustic measurement and analysis tool, available for Windows, Mac and Linux platforms. It includes the ability to automatically generate a bank of parametric EQ biquads based on a measurement. These coefficients can be saved to a file from REW and then loaded into a PEQ block. Room EQ Wizard can be downloaded here:

- <http://www.roomeqwizard.com/#downloads>

For guidance on using this feature, refer to the application note [Auto EQ with REW](#).

8.5 WORKING WITH CONFIGURATIONS

The data that controls the back-end audio processing is called a *configuration*. The processor stores four configuration presets in its internal memory, which can be selected from the plugin or via remote control.

8.5.1 Online and offline mode

Initially, the plugin is *offline*. When the **Connect&Synchronize** button is used, the plugin downloads configuration data into the processor and goes *online*. Changes made in the plugin user interface therefore fall into two categories:

The plugin is online

The plugin user interface is “live” – that is, any changes made to the audio processing parameters in the user interface are immediately downloaded to the processor. The effect of these changes will thus be audible as the changes are made.

The plugin is offline

Changes made to audio processing parameters in the plugin user interface will be made locally in the plugin only. The next time the plugin goes online, these parameters will be downloaded to the processor (as long as the **Synchronize Config** button is pressed).



The configuration contained in the miniDSP hardware unit cannot be uploaded back to the computer. Therefore, you **must** save your configuration to a file if you wish to be able to recover from any changes you make while offline.

8.5.2 Selecting a configuration

The active configuration is selected by one of the four Configuration Selection buttons:



To switch to a different configuration, click on a different button. There are two cases:

The plugin is online

Audio processing will switch to the parameters of the selected configuration. If parameters of the selected configuration have been changed since the last time that configuration was synchronized, then a dialog will appear asking if you want to synchronize the configuration.

The plugin is offline

The user interface will update to show the parameters of the newly selected configuration. If this configuration is changed in the user interface, it will be downloaded to the processor the next time it is synchronized.

8.5.3 Saving and loading configurations

Configurations can be saved to and loaded from files. Each configuration is stored in a separate file. It is *very* strongly recommended that each configuration programmed into the processor be saved to a file, to ensure that the configuration is not lost if the processor is inadvertently reset.

To save the currently selected configuration to a file, drop down the File menu, then select **Save** and then **Save current configuration**. Select a location and enter the name of the file, then save it.

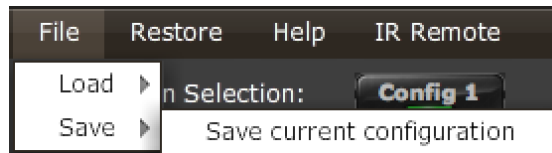

To load a configuration, first select the configuration preset that you wish to load into. Then drop down the File menu, select **Load**, and then **Load configuration to current slot**.

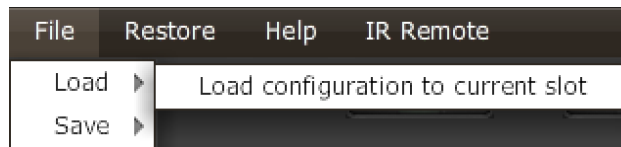

If the plugin is online, the new configuration data will be downloaded to the processor immediately. If the plugin is offline, the data will be loaded into the user interface only and will be downloaded to the processor the next time it is synchronized.



To copy a configuration from one preset to another, save the configuration to a file, then select a different configuration preset and load the file you just saved.

8.5.4 Relationship with Dirac Live

Each configuration preset in the SHD plugin corresponds to the same-numbered filter set configured in Dirac Live. For example, if the remote control or front panel is used to select preset 3, then both SHD configuration 3 and Dirac Live filter set 3 are loaded for audio processing.

The stored configuration file contains the data for the SHD plugin only. The Dirac Live filters must be loaded separately using the Dirac Live application.

8.5.5 Restoring to defaults

Configurations can be reset to the factory defaults from the Restore menu:

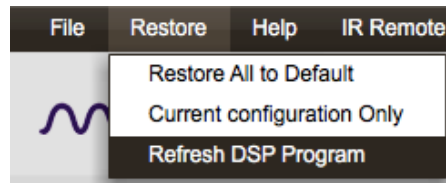

Restore All to Default

Reset all four configuration presets to the factory default settings.

- If the plugin is online, all configuration data on the processor will be reset to factory defaults immediately. In addition, the Dirac Live filters are cleared from all four slots.
- If the plugin is not online, configuration data will be cleared in the user interface only. The new configuration data will be downloaded to the processor next time it is synchronized. The Dirac Live filters will **not** be cleared.

Current Configuration Only

Reset only the currently selected configuration preset to the factory default settings.

- If the plugin is online, the currently selected configuration on the processor will be reset to factory defaults immediately. The Dirac Live filters will **not** be cleared.
- If the plugin is not online, configuration data will be cleared from the currently selected preset in the user interface only. The new configuration data will be downloaded to the processor next time it is synchronized. The Dirac Live filters will **not** be cleared.

8.6 KEYBOARD SHORTCUTS

The **SHD plugin** supports the use of the keyboard for many operations.

Tab

The Tab key moves the focus from the current user interface element to the next. A blue-grey surrounding box usually indicates the user interface element with the focus. Shift-Tab moves the focus in the opposite direction.

Up/down arrows

The up/down arrow keys (and in some cases, the left/right arrow keys) adjust the value of many parameters, if they have the focus:

- Gain adjustment
- Crossover frequency and filter type
- PEQ filter frequency, gain, and Q

Space

The Space bar toggles buttons that have two states, such as **Bypass**, **Invert**, and **Mute**, if they have the focus.

9 ADDITIONAL INFORMATION

9.1 SPECIFICATIONS

9.1.1 All SHD Series processors

Computer connectivity	Driverless USB 2.0 control interface for Windows and macOS
USB audio input	XMOS asynchronous USB audio, 44.1 to 192 kHz stereo PCM, USB Audio Class 2 compliant. ASIO driver for Windows, driverless for macOS.
Digital audio inputs	Digital audio source selectable from IR remote or front panel: <ul style="list-style-type: none">• AES-EBU on Neutrik 3-pin female XLR / Isolated with digital audio transformer• SPDIF on RCA connector / Isolated with digital audio transformer• TOSLINK on Optical connector The input signal is processed by a high quality onboard Asynchronous Sample Rate Converter for compatibility with most common sample rates (20-216kHz).
Ethernet audio input	Audio streaming with Volumio, up to 192 kHz sample rate
Audio resolution	32-bit input and output resolution, 96 kHz internal sample rate
Audio processing	32-bit floating-point processor. Flexible routing matrix, Dirac Live® room correction, user-programmable IIR filtering, individual delays and gains per channel.
Filtering capabilities	Dirac Live mixed-phase filtering. User-programmable IIR filters: high pass and low pass crossover filters up to 48 dB/octave per output channel; ten biquad filters (parametric) EQ per output channel – peaking, low-shelf, and high-shelf types.
Storage/presets	All output channel settings controllable in real time from software user interface. 4 onboard presets stored in local flash memory.
Infrared remote	Basic remote supplied. Also supports “learning remote” capabilities (NEC, Philips, Sony) for third-party remotes.

9.1.2 SHD

Specifications as per “All SHD Series processors” on page 72, plus:

Analog audio inputs, unbalanced	<p>Unbalanced stereo (2 channels) analog audio on RCA connectors</p> <ul style="list-style-type: none"> - Max input: 2V RMS - Input impedance: 47 kΩ - THD+N @ 2Vrms: 0.0005% (RCA to USB) - Dynamic range: 114 dB - Frequency response linearity / 20 Hz to 20 kHz, -1 dBFS: +/-0.5 dB
Analog audio inputs, balanced	<p>Balanced stereo (2 channels) analog audio on XLR connectors</p> <ul style="list-style-type: none"> - Max input: 4V RMS - Input impedance: 48 kΩ - THD+N @ 2Vrms: 0.0003% (RCA to USB) - Dynamic range: 120 dB - Frequency response linearity, 20 Hz to 20 kHz, -1 dBFS: +/-0.5dB
Analog audio outputs, unbalanced	<p>Unbalanced analog audio (4 channels) on RCA connectors</p> <ul style="list-style-type: none"> - Full-scale output: 2V RMS - Output impedance: 100Ω - THD+N: 0.0005% (USB to RCA) - Dynamic range: 114dB - Frequency response linearity, 20 Hz to 20 kHz, -1 dBFS: +/-0.5dB
Analog audio outputs, balanced	<p>Balanced analog audio (4 channels) on XLR connectors</p> <ul style="list-style-type: none"> - Full-scale output: 4V RMS - Output impedance: 200 Ω - THD+N: 0.0003% (USB to RCA) - Dynamic range: 120 dB - Frequency response linearity, 20 Hz to 20 kHz, -1 dBFS: +/-0.5dB
Digital audio outputs	<p>Four channels of digital audio (two stereo pairs, OUT 1&2 and OUT 3&4), available as SPDIF on RCA connector / Isolated with digital audio transformer.</p>
Power supply	<p>Universal mains supply, 90 – 240 V AC</p>
Dimensions (H x W x D)	<p>41.5 x 429 x 236 mm</p>



9.1.3 SHD Power

Specifications as per “All SHD Series processors” on page 72, plus:

Analog power amplifier

Max output power	2 X 120W RMS ($R_L=8\ \Omega$ and $R_L=4\ \Omega$)
THD+N	< 0.005% ($f=100\text{Hz}$, 1W to 100 W, $R_L=8\ \Omega$ and $R_L=4\ \Omega$) < 0.03% ($f = 20\ \text{Hz}$ to 20 kHz, 60mW to 100 W, $R_L=4\ \Omega$) < 0.07% ($f = 20\ \text{Hz}$ to 20 kHz, 60mW to 100 W, $R_L=8\ \Omega$)
Signal-to-Noise Ratio	> 110 dB (1kHz A-weighted, 120W into 8Ω)
Frequency response	20 Hz to 30 kHz +/-0.5dB
Crosstalk	< -95 dB (1 kHz)

Analog subwoofer outputs, unbalanced

Full-scale output	1.7V RMS
THD+N	< 0.0008% ($f = 20\ \text{Hz}$ to 20 kHz, digital in 0dB)
Signal-to-Noise Ratio	> 120 dB (1kHz A-weighted, digital in 0dB)
Frequency response	20 Hz to 30 kHz +/-0.2dB
Crosstalk	< -100 dB (1 kHz)

Other

Digital audio outputs	Four channels of digital audio (two stereo pairs, OUT 1&2 and OUT 3&4), available as AES-EBU on Neutrik 3-pin male XLR / Isolated with digital audio transformer.
Idle Power Consumption	20 W
Standby Power Consumption	0.7 W
Power supply	Universal mains supply, 90 – 240 V AC
Dimensions (H x W x D)	70 x 215 x 225 mm



9.1.4 SHD Studio

Specifications as per “All SHD Series processors” on page 72, plus:

Digital audio outputs	Four channels of digital audio (two stereo pairs, OUT 1&2 and OUT 3&4), available on two sets of outputs: <ul style="list-style-type: none">• AES-EBU on Neutrik 3-pin male XLR / Isolated with digital audio transformer• SPDIF on RCA connector / Isolated with digital audio transformer
Headphone output	6.35 mm stereo jack. Cirrus Logic CS43130 DAC/headphone driver, driven from the same signal as OUT 1&2.
Power supply	12V DC external supply, EU/US/AU/UK plug adaptors provided
Dimensions (H x W x D)	41.5 x 214.5 x 206 mm

9.2 PLUGIN AND DSP UPGRADE

miniDSP occasionally provides an upgrade to the plugin, to improve stability or performance or to add new features. The procedure is essentially the same as initial installation in Section 3, but with some additional points to note.

To upgrade, log into the miniDSP website and drop down the menu at the top right. Click on User Downloads.

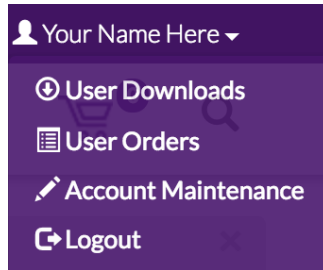

Click on the **SHD series** heading. First check the written instructions on the download webpage and note if there is more to do than just upgrade the plugin – for example, if there is a firmware update, or if the DSP program needs to be updated.

1. Click on the Download button at the right.

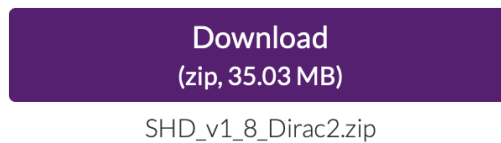

2. Unzip the downloaded file (on Windows, right-click and select “Extract All...”; on Mac, double-click).
3. Install the newly downloaded plugin as described in Section 3.
4. If the instructions on the download webpage say to update the DSP program, start the plugin, click the Connect button, drop down the Restore menu and select **Refresh DSP Program**. (This is safe to do as a matter of course after each plugin update. Your configuration data is not overwritten or reset.)

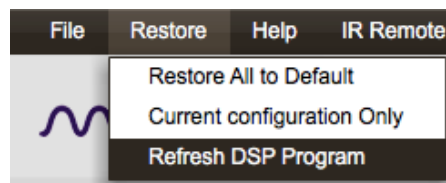

5. If the instructions on the download webpage say that there is a firmware update included, follow the instructions in section 9.4.
6. Confirm the updated software versions from the Help -> About... menu:

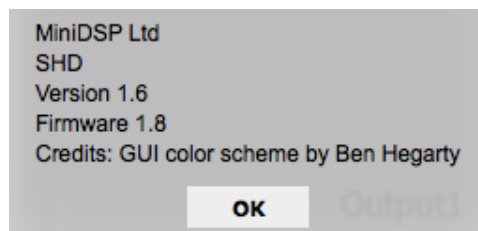

9.3 VOLUMIO SOFTWARE UPDATE

To check for an update to the Volumio software, open the web interface and drop down the gear menu at the top right. Select the **System** entry.

On the **System** page, click on the Check Updates button. If an update is available, you will see the details of the update, like this:

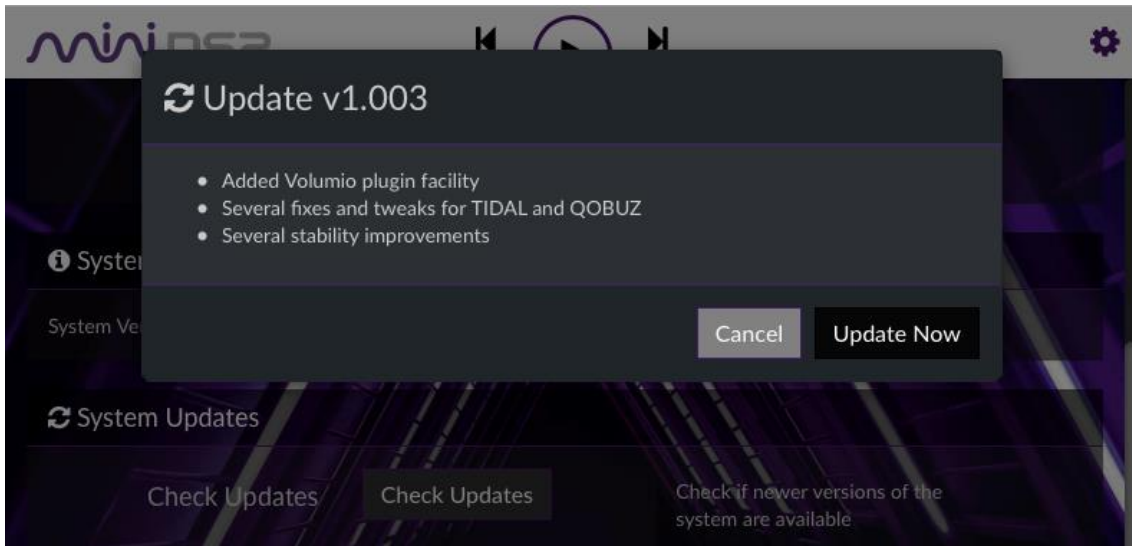

Click on Update Now. You will see a progress bar:

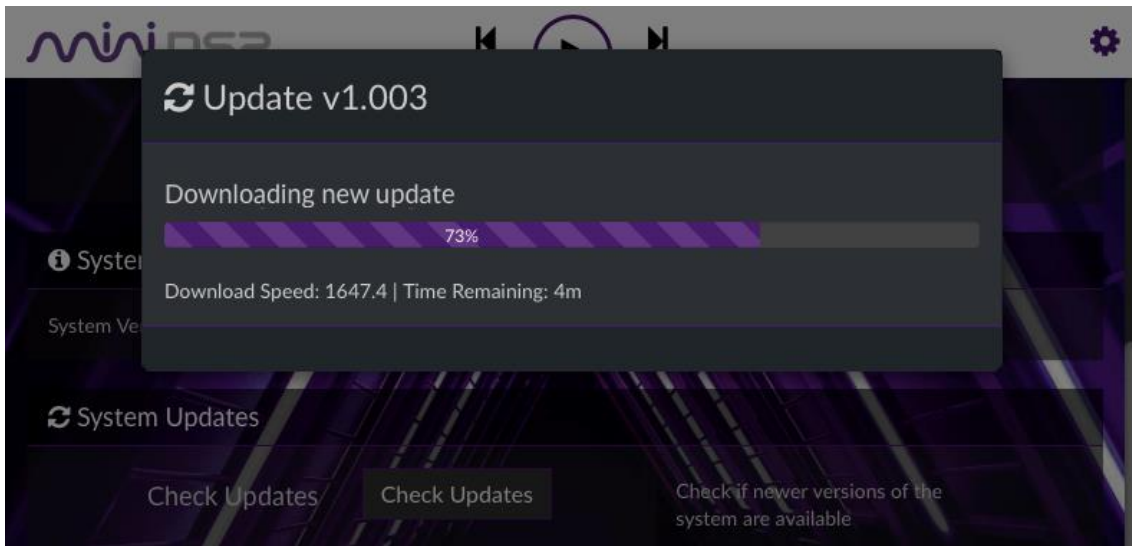

When the update completes, Volumio will automatically restart. After the webpage returns, it is important to **refresh the webpage in your browser**. This ensures that any updates to the user interface itself are updated in your browser.

9.4 VOLUMIO SETTINGS/FACTORY RESET

There are two types of reset for Volumio. One reverts to the default settings, and one restores the complete Volumio installation to the version that was delivered from the factory. Use the second version if your Volumio installation has become corrupted and you are no longer able to access the Volumio web interface. Neither version has any effect on the plugin settings or Dirac Live calibration.

9.4.1 Factory reset (settings only)

In the Volumio web interface, navigate to Settings then System. Scroll down to the System Version section and click on the Factory Reset button. The Volumio web interface will become unresponsive for a minute or so while the settings are reset. You will need to enter all your settings again.

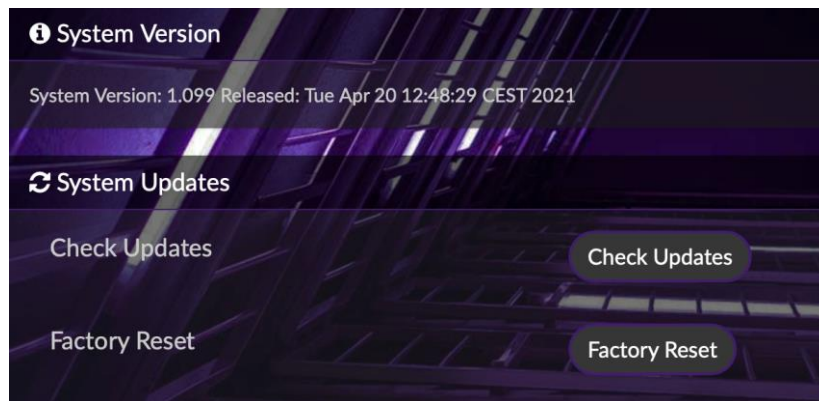

9.4.2 Factory reset (settings and installation)

Use this method if Volumio has become corrupted and you are unable to access the Volumio web interface.

1. Insert a blank USB stick into your computer. Make sure it is formatted in FAT32 format.
2. In your web browser, go to the location http://repo.volumio.org/Primo/factory_reset. Save the file to the USB stick and eject the stick from your computer. Do not rename or modify the file.
3. Power off your SHD and insert the USB stick. Power it on again.
4. Volumio will revert to the factory version. This can take up to ten minutes, during which time the Volumio web interface will be unresponsive.
5. When the Volumio web interface responds again, proceed through the setup wizard. Go to Settings then System. Scroll down to the System Version section and click on the Check Updates button. Update your Volumio to the latest version.
6. Update any remaining settings to how you had it before the reset.



If you renamed your system in the Volumio settings, you will need to access the web interface using the default name “minidsp-shd” (page 24).

The factory_reset file is removed from the USB stick during this process. If you want to do the reset again, you will need to copy the file to the USB stick again.

9.5 FIRMWARE UPGRADE

miniDSP may occasionally provide an upgrade to the processor’s MCU firmware to enable new features. To upgrade the MCU firmware, first download the latest version of the SHD software package from the **User Downloads** section of the miniDSP website, then extract it on your computer (on Windows, right-click and select “Extract All...”; on Mac, double-click).



DO NOT DISCONNECT THE USB CABLE OR POWER FROM THE PROCESSOR WHILE FIRMWARE UPGRADE IS IN PROGRESS. DOING SO MAY “BRICK” YOUR PROCESSOR.

9.5.1 Windows

1. Connect the SHD Series processor to your computer via USB (if not already connected) and power it on.
2. Navigate to the **XMOS_Firmware\Firmware_Upgrade_Tools\Windows\miniDSPUAC2Dfu** folder of the software download.
3. Double-click on **miniDSPUAC2Dfu.exe** to run it. The application will start:

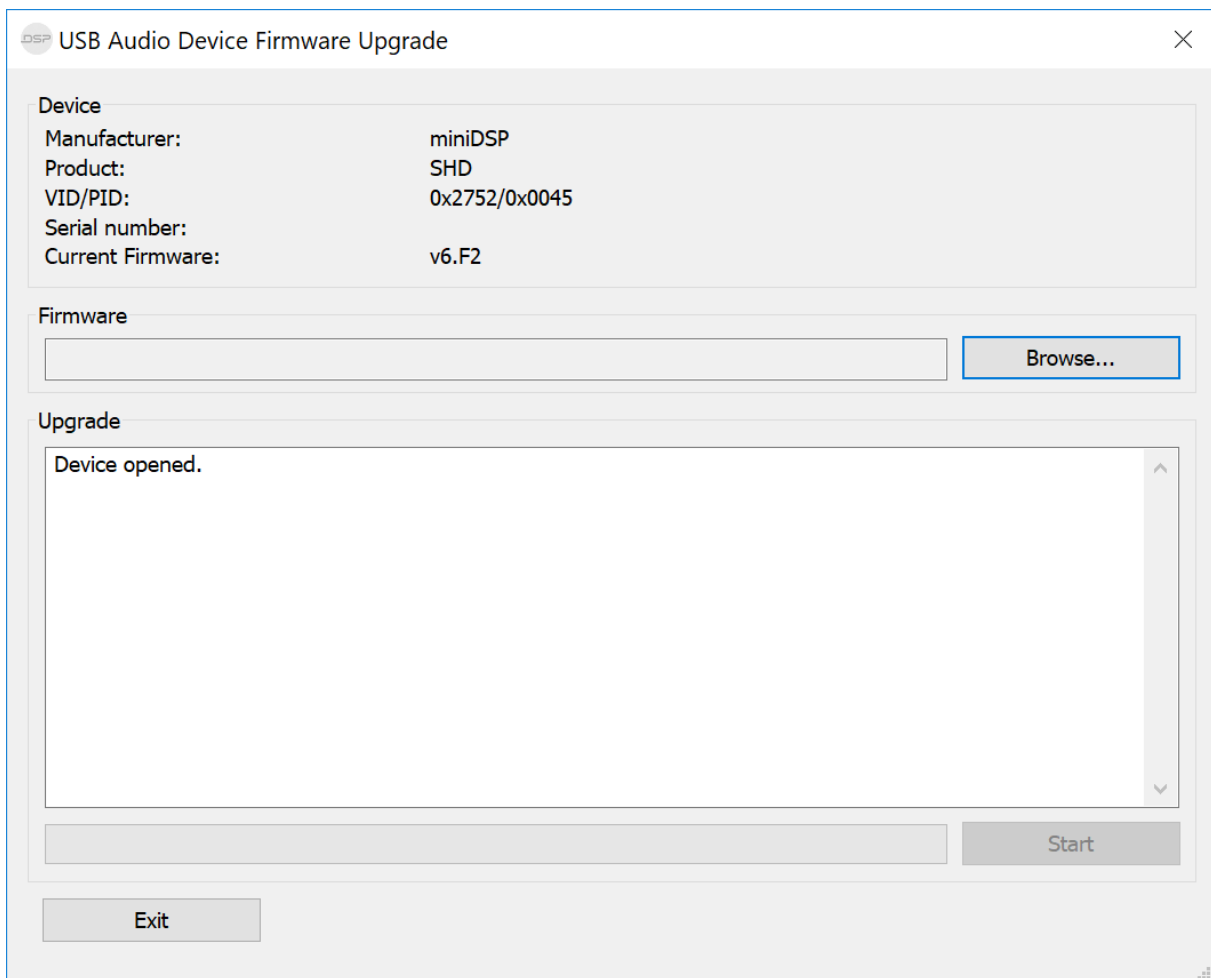

- Click on the **Browse** button and select the firmware file from the **XMOS_Firmware** folder of the software download. It will have a name like "SHD_v1.10.bin." (The version number "v1.10" may change.)
- Click on the **Start** button.
- You will get a progress bar as the upgrade proceeds:

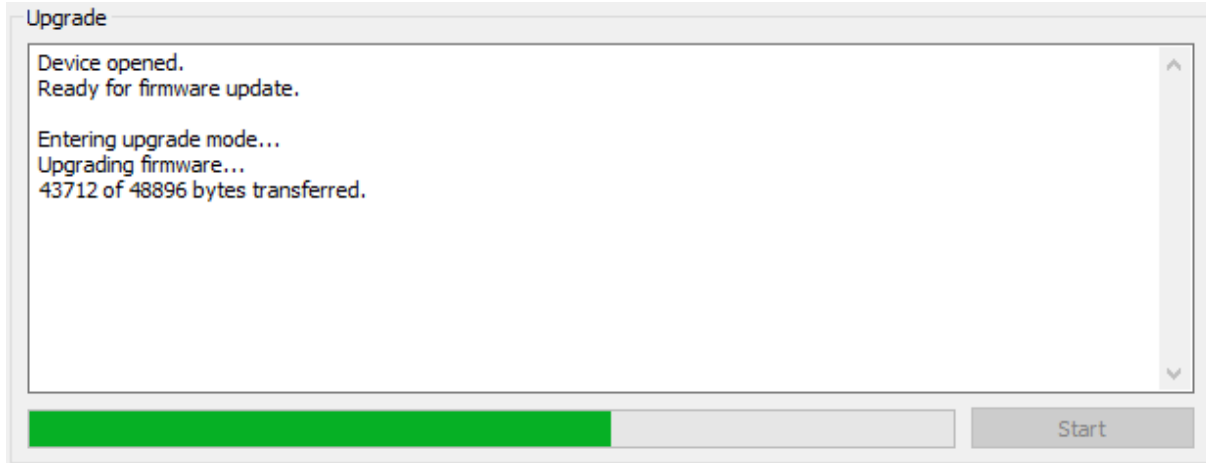

- Once the firmware upgrade completes, you will see a message that the upgrade completed successfully:

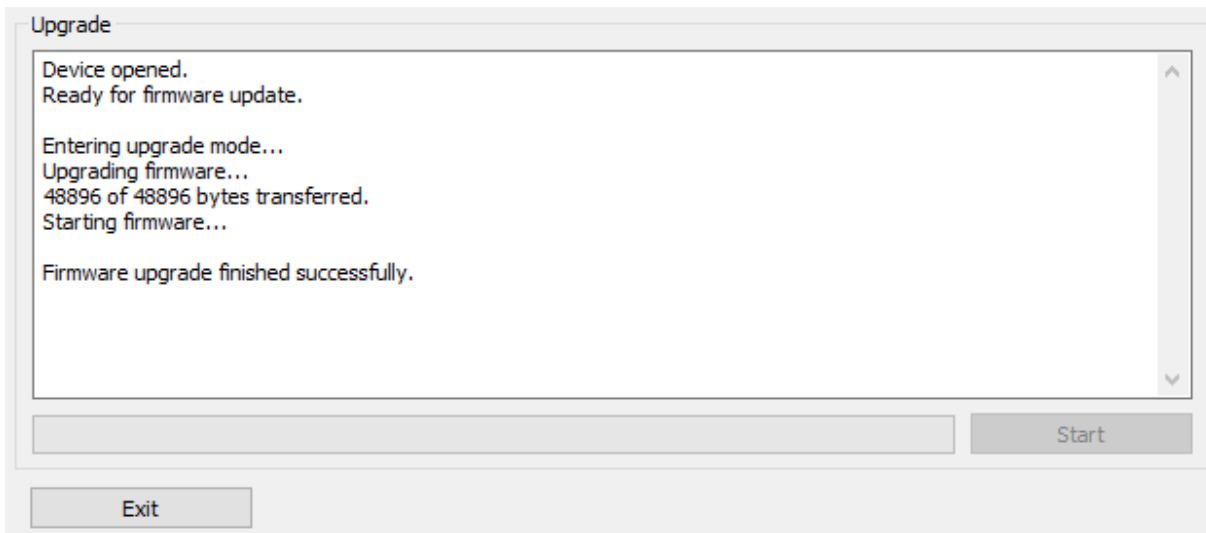

- Click on **Exit**.
- That's it! You're done. You can now use your SHD Series processor with the new functionality.

9.5.2 macOS

1. Connect the SHD Series processor to your computer via USB (if not already connected) and power it on.
2. Navigate to the **XMOS_Firmware/Firmware_Upgrade_Tools/Mac** folder of the software download.
3. Double-click on the .zip file to extract the firmware update software, then double-click on **miniDSP USB DFU.app** to run it. The app will start:

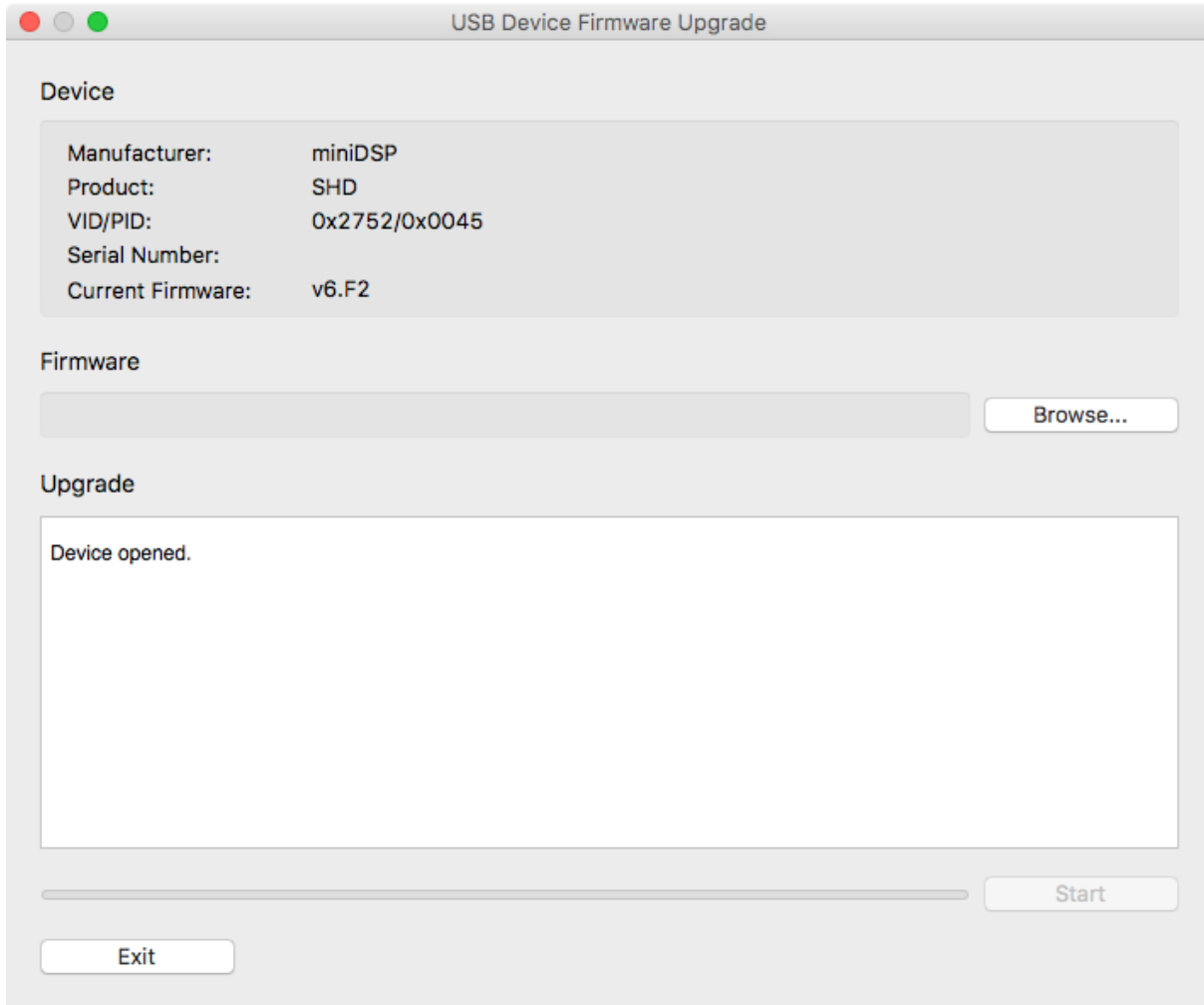

4. Click on the **Browse** button and select the firmware file from the **XMOS_Firmware** folder of the software download. It will have a name like "SHD_v1.10.bin." (The version number "v1.10" may change.)
5. Click on the **Start** button.
6. You will get a progress bar as the upgrade proceeds:

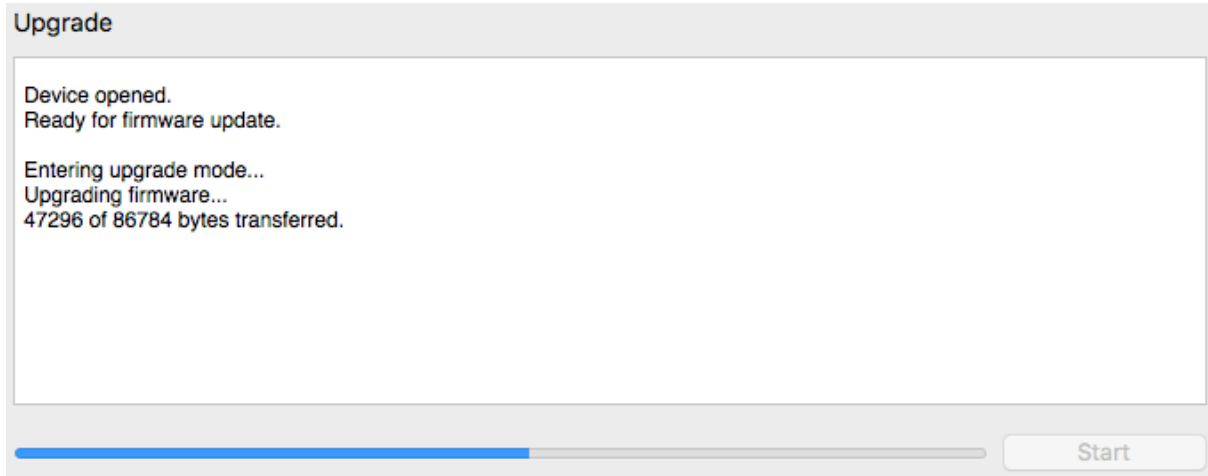

7. Once the firmware upgrade completes, you will see a message that the upgrade completed successfully:

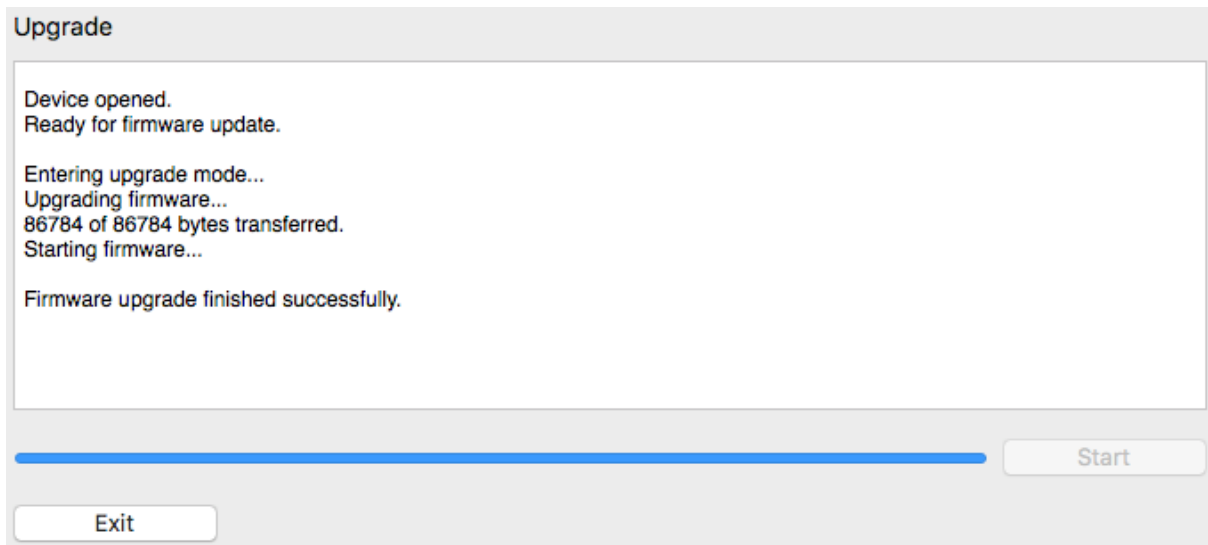

8. Click on **Exit**.
9. That's it! You're done. You can now use your SHD Series processor with the new functionality.

9.6 FINDING THE SHD'S IP ADDRESS

If the URLs given on page 22 don't connect to the SHD web interface, you can connect using its IP address.

Locating the SHD with a network scanner

You can find the IP address of the SHD with a network scanner. A popular scanner is the [Fing App](#), which is available for Android and iOS.

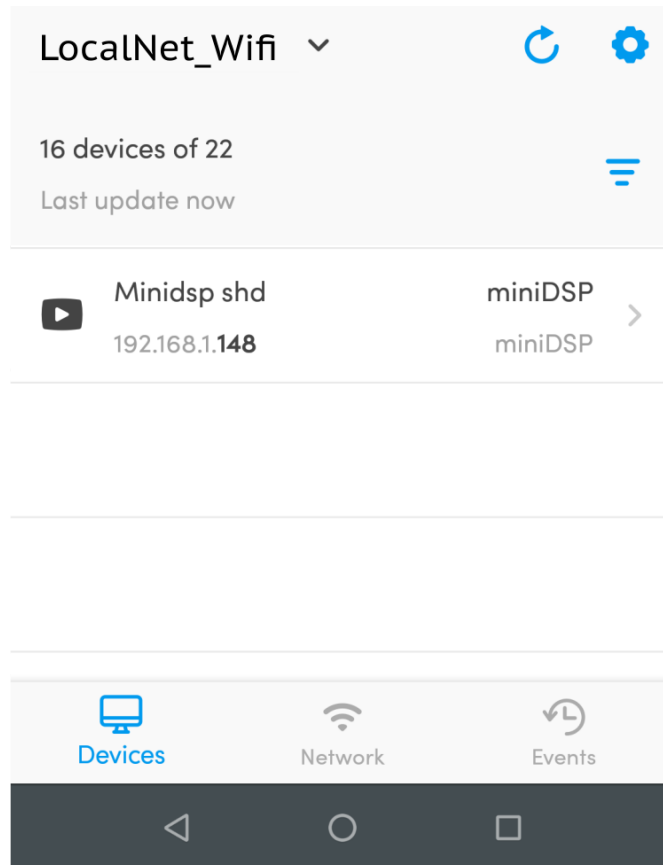

Once you have found the IP address, enter the IP address instead of the name into the web browser address bar. For example: <http://192.168.1.148>.

Locating the SHD in Windows 10

In Windows 10, click on the search button and type “devices”. Click on “View network computers and devices”:

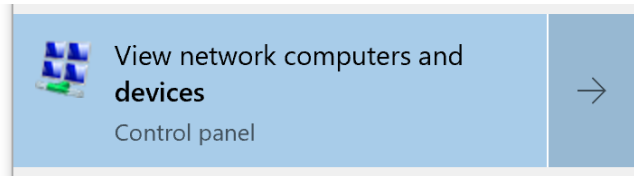

The SHD will be visible in the Media Devices section:



Click on it to observe the Properties window. Locate the IP address near the bottom of the window:

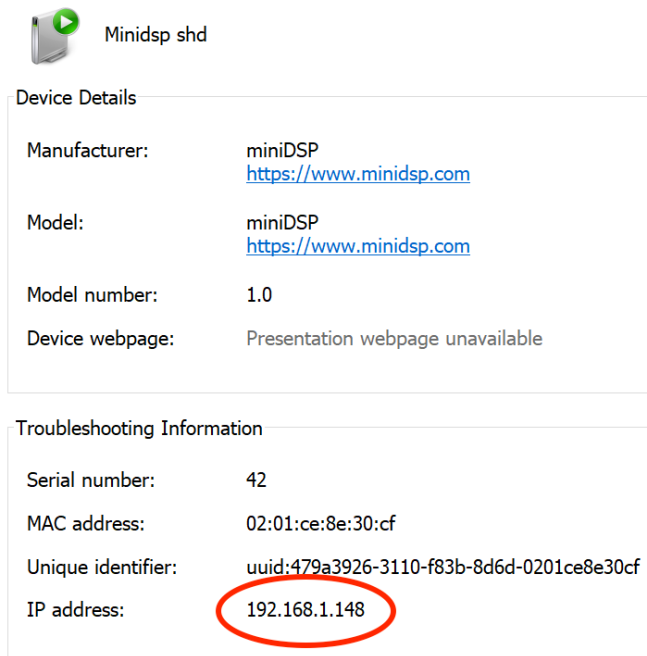

In the web browser address bar, enter the IP address instead of the name. For example: <http://192.168.1.148>.

9.7 SOLVING CONNECTIVITY ISSUES



If you are experiencing any connectivity issues, the **first thing** to do is double-check that your processor's plugin and firmware are up to date.

9.7.1 No Internet connection

Various components of the software require an Internet connection. In particular:

- The Dirac Live application may refuse to generate filters or reload saved projects if it cannot connect to the Dirac Research servers.

In the event that the software is not operating correctly, check that your computer is connected to the Internet and try again.

9.7.2 SHD Series processor not detected

The Dirac Live application use network ports 11113, 11115, 11117, 5000, and 8080. The last two in particular are needed for the bridging app to communicate between Dirac Live and the miniDSP processor.

If the miniDSP processor is not detected:

1. Double-check the USB cabling from your computer to the processor. If you are using extenders or hubs, remove them and make a short direct connection. Try different USB ports on your computer.
2. Check that your computer's firewall isn't blocking any of the ports listed above.
3. Check that other applications aren't using these ports.
 - a. On Windows 10, open a command prompt and type the following commands:

```
netstat -ano | findstr 8080  
netstat -ano | findstr 5000
```
 - b. On macOS, open Terminal and type the following commands:

```
sudo lsof -n -iTCP:8080 | grep LISTEN  
sudo lsof -n -iTCP:5000 | grep LISTEN
```

If there is no output, the ports are not in use. If there is output, then try to close the application that is using them. Typically, software that provides a local web server is likely to be the one blocking port 8080.

9.8 TROUBLE-SHOOTING AUDIO ISSUES

No sound during volume calibration

If you get no sound while on the Volume Calibration tab of Dirac Live, first make sure that you increase the volume slider in the UI (the leftmost one).

If there is still no sound, double-check that output cabling is connected to the right connectors on the rear panel and to the correct inputs on downstream equipment. Make sure that downstream equipment (e.g. amplifiers) is not muted, turned down, or turned off.

No sound during playback

If you get no sound while playing music, first quit Dirac Live if it is open, and start the SHD plugin.

If there is no signal on the input meters

1. Check which input source you have selected. If that doesn't provide the solution, double-check the connection and cabling between the source(s) and the SHD.

If there is signal on the input meters, but no signal on the output meters

1. Check the master volume setting.
2. Check that the SHD is not muted (Mute button at top right of the interface).
3. Check your Routing and make sure that you are routing inputs through to outputs.
4. Check your crossover settings.

If there is signal on the output meters, but still no sound

1. Check that output cabling is connected to the right connectors on the rear panel and to the correct inputs on downstream equipment (e.g. amplifiers).
2. Check that downstream equipment (e.g. amplifiers) is not muted, turned down, or turned off.

Strange soundstage

If the soundstage width is very narrow, check that you have not summed left **and** right input channels and routed the sum to the left and right speaker. This will result in a mono signal and hence a narrow soundstage.

If the soundstage is "weird", check the routing and crossover settings, and make sure that left and right are consistent. If you are implementing an active speaker, also double check the connections on the rear panel.

Distortion

If audio playback is distorted, you may have too much gain internal to the DSP. Dirac Live can apply up to 10 dB of gain, so the output level should be kept lower than -10 dB to *guarantee* that there is no distortion with a full-scale input signal.

This issue typically occurs when volume control is being done downstream of the SHD Series processor. If so, set the SHD Series processor at -10 dB, and then use the downstream equipment to control volume.



9.9 OBTAINING SUPPORT

1. Check the forums on minidsp.com to see if this issue has already been raised and a solution provided.
2. Contact miniDSP via the support portal at support.minidsp.com with:
 - a. The product information obtained from the SHD plugin's About button and the **Dirac Live** application.
 - b. A clear explanation of the symptoms you are seeing.
 - c. A description of troubleshooting performed and your results.

9.10 OPEN SOURCE LICENSES

The Volumio portion of the SHD Series processors runs on a separate ARM CPU and is subject to various open-source licenses. To view the complete list of open source licenses and credits, connect to the web interface using your web browser and select System from the menu, then "Credits and Open Source Licenses."

If you would like a copy of the GPL v2.0 source code contained in this product shipped on a DVD, you may obtain the complete corresponding source code from us for a period of three years after our last shipment of this product for a charge of 20\$ no more than the cost of preparing and mailing a DVD to you. Please contact info@minidsp.com. This offer is valid to anyone in receipt of this information.