

# Tipppers **Debon**



[sales@debontrailers.co.uk](mailto:sales@debontrailers.co.uk)  
[www.debontrailers.co.uk](http://www.debontrailers.co.uk)







**Tippers**  
**Debon**

ONE-WAY TIPPER  
**PW0**

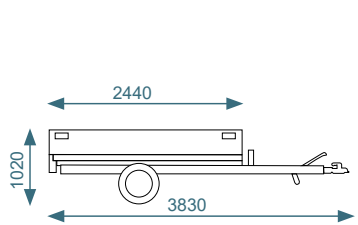

- Hot dip galvanized chassis
- Strong axle
- Plywood floor
- Removable aluminium drop sides 300 mm
- Heavy duty automatic jockey wheel
- Protected front and rear lights

**PW0 «ECO»**  
 ■ Double acting hand pump

**PW0 «LUX»**  
 ■ Electro-hydraulic with battery  
 ■ Plywood floor with galvanised protection steel plate  
 ■ H-frame and 6 tie-rings

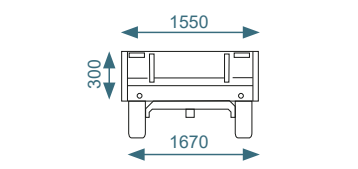

Unladen weight = 430 kg  
 Max. Gross Weight = 750 kg  
 to 1500 kg







**Tippers**  
**Debon**

ONE-WAY TIPPER  
**PW1.2**

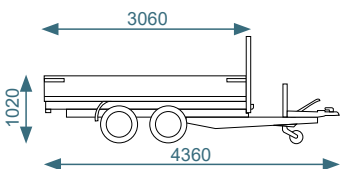

- Hot dip galvanized chassis
- 2 strong axles
- Plywood floor
- Removable aluminium drop sides 300 mm
- Heavy duty automatic jockey wheel
- Protected front and rear lights

**PW1.2 «ECO»**

- Double acting hand pump

**PW1.2 «LUX»**

- Electro-hydraulic with battery
- Plywood floor with galvanised protection steel plate
- H-frame and 6 tie-rings

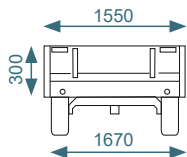

Unladen weight = 600 kg  
Max. Gross Weight = 1100 kg  
to 2000 kg

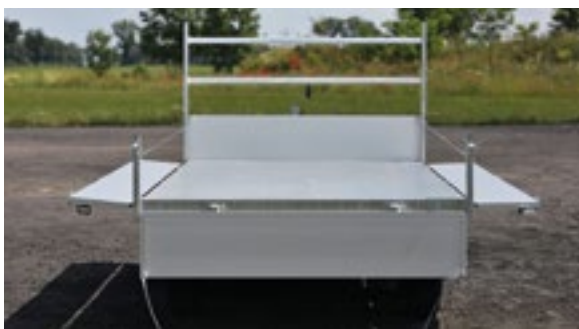



**NEW!**



**Tippers**  
**Debon**  
THREE-WAY TIPPER  
**PW2.4**

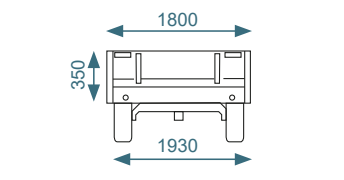
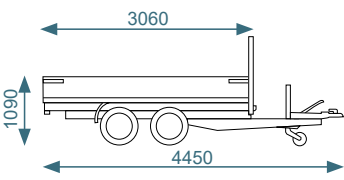

- Hot dip galvanized chassis
- 2 strong axles
- Plywood floor with galvanised protection steel plate
- Heavy duty automatic jockey wheel
- Protected front and rear lights
- Electro-hydraulic pump with battery
- Integrated ramps rack with strips for noise reduction
- Rectangular posts (no residue in the corners)
- 6 tie rings

**PW2.4 «ECO»**

- 4 removable aluminium drop sides 300 mm

**PW2.4 «LUX»**

- 4 removable aluminium drop sides 350 mm
- Battery cover
- Prop rod
- Removable front H-Frame galvanised steel

Unladen weight = 710 kg  
Max. Gross Weight = from 1600 kg to 2600 kg







**Tippers**  
**Debon**

THREE-WAY TIPPER  
**PW3**

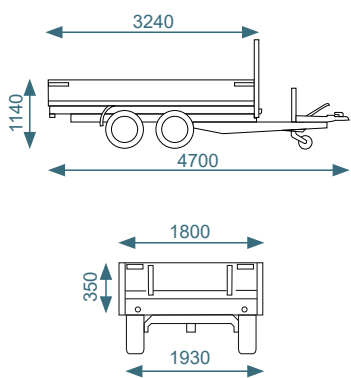

- Hot dip galvanized chassis
- 2 strong axles
- Plywood floor with galvanised protection steel plate
- Removable aluminium drop sides 350 mm
- Heavy duty automatic jockey wheel
- Protected front and rear lights
- Electro-hydraulic pump with battery + battery cover
- Integrated ramps rack with strips for noise reduction
- Prop rod
- Rectangular posts (no residue in the corners)
- Removable front H-Frame galvanised steel
- 8 tie rings



Unladen weight = 833 kg  
Max. Gross Weight = 2700 kg  
to 3500 kg





■ Mesh sides



■ Extra side walls



■ Flat cover



■ Aluminium loading ramps  
 - Supp. cap 2000kg / pair (2500x300x80mm)  
 - Supp. cap 3000kg / pair (2500x300x100mm)



■ Telescopic prop stands



■ Tie-rings



■ Emergency hand pump



■ Shock absorbers



■ Spare wheel

January 2021 - Non-binding documents



[sales@debontrailers.co.uk](mailto:sales@debontrailers.co.uk)

[www.debontrailers.co.uk](http://www.debontrailers.co.uk)



Your dealer