



4	AN5516-06 (19inch) DC 10G	1.Control Board: HSWA*2 2.Uplink Board: HU1A*2 3.Power Board: PWR*2	
5	AN5516-04 (19inch)DC 1G	1.Control&Uplink Board:HSUC*2 2.Power Board: PWRD*1	
6	AN5516-04 (19inch)DC 10G	1.Control&Uplink Board:HSUB*2 2.Power Board: PWRD*1	
7	AN5516-04 (19inch)AC 1G	1.Control&Uplink Board:HSUC*2 2.Power Board: PWRA*1	
8	AN5516-04 (19inch)AC 10G	1.Control&Uplink Board:HSUB*2 2.Power Board: PWRA*1	
9	GPON GC8B C+	8ports contains 8pcs SFPs modules C+, works for AN5516 series OLT	
10	GPON GC8B C++	8ports contains 8pcs SFPs modules C++, works for AN5516 series OLT	
11	GPON GCOB C+	16ports contains 16pcs SFPs modules C+, works for AN5516 series OLT	
12	GPON GCOB C++	16ports contains 16pcs SFPs modules C++, works for AN5516 series OLT	
13	EPON EC8B PX20+	8ports contains 8pcs SFPs modules PX20+, works for AN5516 series OLT	
14	EPON ECOB PX20+	16ports contains 16pcs SFPs modules PX20+, works for AN5516 series OLT	
15	MA5680T IEC (19inch) DC 1G	1.Control Board: SCUN*2 2.Uplink Board: GICF*2 3.Power Board: PRTE*2	This series stopped replaced by MA5800 serious
16	MA5680T IEC (19inch) DC 10G	1.Control Board: SCUN*2 2.Uplink Board: X2CS*2 3.Power Board: PRTE*2	
17	MA5683T (19inch) DC 1G	1.Control Board: SCUN*2 2.Uplink Board: GICF*2 3.Power Board: PRTE*2	
18	MA5683T (19inch) DC 10G	1.Control Board: SCUN*2 2.Uplink Board: X2CS*2 3.Power Board: PRTE*2	
19	MA5608T (19inch)DC 1G	1.Control&Uplink Board:MCUD*2 2.Power Board: MPWC*1	
20	MA5608T (19inch)DC 10G	1.Control&Uplink Board:MCUD01*2 2.Power Board: MPWC*1	
21	MA5608T (19inch)AC&DC 1G	1.Control&Uplink Board:MCUD*2 2. Power Board: MPWD*1	
22	MA5608T (19inch)AC&DC 10G	1.Control&Uplink Board:MCUD01*2 2.Power Board: MPWD*1	
23	GPON GPBD C+	8ports contains 8pcs SFPs modules C+, works for MA5600 series OLT	
24	GPON GPBD C++	8ports contains 8pcs SFPs modules C++, works for MA5600 series OLT	
25	GPON GPFD C+	16ports contains 16pcs SFPs modules C+, works for MA5600 series OLT	
26	GPON GPFD C++	16ports contains 16pcs SFPs modules C++, works for MA5600 series OLT	
27	EPON EPBD PX20+	8ports contains 8pcs SFPs modules PX20+, works for MA5600 series OLT	
28	EPON EPFD PX20+	16ports contains 16pcs SFPs modules PX20+, works for MA5600 series OLT	
29	MA5800-X2 2slots AC & DC	1. Main control board: MPSA*2(10GE*2+1GE*2) board:PISB*1 2..Power 3. FAN:FMSM	Recommend this series
30	MA5800-X2 2slots AC & DC	1. Main control board: MPSC*2(10GE*4) board:PISB*1 2.Power 3. FAN:FMSM	
31	MA5800-X2 DC	1. Main control board: MPSA*2 (10GE*2+1GE*2) board:PISA*1 2.Power 3. FAN:FMSM	
32	MA5800-X2 DC	1. Main control board: MPSC*2 (10GE*4) board:PISA*1 2.Power 3. FAN:FMSM	
33	MA5800-X7 DC	1. Main control board: MPLA*2 2.Power board:PILA*2 3. FAN:FMLA/FMMA	



34	MA5800-X15 DC	1. Main control board: MPLA*2	2. Power board:PILA*2	3. FAN:FMLA/FMMA
35	MA5800-X17 DC	1. Main control board: MPLA*2	2. Power board:PILA*2	3. FAN:FMLA/FMMA
36	GPON GPHF C+	16ports contains 16pcs SFPs modules C+ (apply to OLT MA5800X2,X7,X15,X17)		
37	GPON GPHF C++	16ports contains 16pcs SFPs modules C++ (apply to OLT MA5800X2,X7,X15,X17)		
38	XGPON XGHD N1	8ports contains 8pcs SFPs modules XGPON N1 (apply to OLT MA5800X2,X7,X15,X17)		
39	XGPON XGHD N2a	8ports contains 8pcs SFPs modules XGPON N2a (apply to OLT MA5800X2,X7,X15,X17)		
40	XGPON CGHF N2a	16ports contains 16pcs SFPs modules XGPON N2a (apply to OLT MA5800X2,X7,X15,X17)		
41	C300 (19inch) DC 1G	Control Board: SCXN*2	Uplink Board: GUFQ*2	Power Board: PRWH*2
42	C300 (19inch) DC 10G	Control Board: SCXN*2	Uplink Board: HUVQ*2	Power Board: PRWH*2
43	C320 (19inch) DC 1G	Single Control &Uplink&Power Board: SMXA/1*2		
44	C320 (19inch) DC 10G	Control&Uplink &Power Board:SMXA/3*2		
45	C320 (19inch) AC&DC 1G	SingleControl&Uplink&Power Board:SMXA/1 *1 Single power board: PRAM*1		
46	C320 (19inch) AC&DC 10G	SingleControl&Uplink&Power Board:SMXA/3 *1 Single power board: PRAM*1		
47	GPON GTGO C+	8ports contains 8pcs SFPs modules C+,work for C300, C320 OLT		
48	GPON GTGO C++	8ports contains 8pcs SFPs modules C++,work for C300, C320 OLT		
49	GPON GTGH C+	16ports contains 16pcs SFPs modules C+,work for C300, C320 OLT		
50	GPON GTGH C++	16ports contains16pcs SFPs modules C++,work for C300, C320 OLT		
51	EPON ETGOD PX20+	8ports contains 8pcs SFPs modules PX20+,work for C300, C320 OLT		
52	EPON ETGHD PX20+	16ports contains 16pcs SFPs modules PX20+,work for C300, C320 OLT		

		
MA5608T (DC, 1G/10G)	MA5608T (AC, 1G/10G)	MA5680T (DC, 1G/10G)
		
MA5683T (DC, 1G/10G)	MA5800-X2 (DC, 10G)	MA5800-X2 (AC, 10G)
		
MA5800-X7 (AC, 1G/10G)	MA5800-X15 (AC, 1G/10G)	MA5800-X17 (AC, 1G/10G)
		
C320 (DC/AC, 1G/10G)	C300 (DC, 1G/10G)	C600 (DC, 1G/10G)

		
GC8B Gpon 8 Ports C+D++ for AN5516 Series	GCOB Gpon 16 Ports C+D++ for AN5516 Series	GPBD Gpon 8 Ports C+D++ for MA5600 Series
		
GPFD Gpon 16 Ports C+D++ for MA5800 Series	GPHF Gpon 16 Ports C+D++ for MA5800 Series	GPLF Gpon 16 Ports C+D++ for MA5800 Series
		
GPUF Gpon 16 Ports C+D++ for MA5800 Series	GTGH Gpon 16 Ports C+D++ for C300/C320	GTGO Gpon 8 Ports C+D++ for C300/C320



2.1 Category Products-OLT (Neutral)











Item No.	Model	Configuration	Power Supply	Picture
OLT.V-SOL001	V1600GS	1*GPON, 2*RJ45+1*SFP/SFP+, built-in 1pcs C+++SFP	single AC power	
OLT.V-SOL002	V1600G0-B	4*GPON, 2*RJ45+2*(SFP+), without Optical Module	single AC power	
OLT.V-SOL003	V1600G1-B	8*GPON, 4*RJ45+2*SFP+2*(SFP+), without Optical Module	single AC power	
OLT.V-SOL004	V1600G2-B	16*GPON, 4*RJ45+4*(SFP+), without Optical Module	single AC power	
OLT.V-SOL005	V1600D-Mini	4*EPON, 4*RJ45	single AC power	
OLT.V-SOL006	V1600D4-L	4*EPON, 2*RJ45+2*SFP, without Optical Module	single AC power	
OLT.V-SOL007	V1600D4-DP	4*EPON, 4*RJ45+4*(SFP+), without Optical Module	single AC power	
OLT.V-SOL008	V1600D8	8*EPON, 8*RJ45+4*SFP+4*(SFP+), without Optical Module	single AC power	
OLT.V-SOL009	V1600D16	16*EPON, 4*RJ45+4*SFP+4*(SFP+), without Optical Module	single AC power	
MK.056	EPON OLT SFP PX20+++	EPON OLT PX20+++ 8dBm 1.25G-1490/1310nm-20KM-SC	for optional	
MK.074	GPON OLT CLASS C++ 7dBm	GPON OLT CLASS C++ 7dBm 2.5G/1.25G-1490/1310nm-20KM-SC	for optional	
MK.057	GPON OLT SFP C+++ 8dBm	GPON OLT CLASS C+++ 8dBm 2.5G/1.25G-1490/1310nm-20KM-SC	for optional	
MK.075	GPON OLT CLASS C+++ 9dBm	GPON OLT CLASS C+++ 9dBm 2.5G/1.25G-1490/1310nm-20KM-SC	for optional	
MK.058	GPON OLT SFP C++++ 10dBm	GPON OLT CLASS C++++ 10dBm 2.5G/1.25G-1490/1310nm-20KM-SC	for optional	









2.2 Category Products-power supply(Rectifier)





No.	model	configuration	Picture
1	power supply (Rectifier)	PSU-AC 30A 2-way AC input 100V-240V to 48V- 53V (apply to all brands OLT)	
2	power supply (Rectifier)	ETP48100-B1 50A R4850G*1 100V-240V to 48V- 53V (apply to all brands OLT)	
3	power supply (Rectifier)	ETP48100-B1 100A R4850G*2 100V-240V to 48V- 53V (apply to all brands OLT)	
4	GYE power supply (Same as Emerson)	GYE EPS30-4815AF 30A 100V-240V to 48V- 53V (apply to all brands OLT)	
5	power supply (Rectifier)	ETP4830-A1 30A with monitor module #SMU01C 100V-240V to 48V- 53V (apply to all brands OLT)	
6	power supply (Rectifier)	ETP4890-A2 30A 100V-240V to 48V- 53V (apply to all brands OLT)	

2.3 Category Products-ONU/ONT (Optional Customized)

No	Model	configuration	remarks	package /carton	remarks
1	Gpon AN5506-01Amini	1GE(Bridge)	Brasil verion EU, US, AR, AU,EK...plug for optional	20pcs, 5.2kgs 48*32*19cm	
2	Gpon AN5506-02B	1GE+1FE+1tel (PPPoE)	Brasil verion EU, US, AR, AU,EK...plug for optional	20pcs, 8kgs 50*31*24cm	
3	Gpon AN5506-02FG	1GE+1FE+1tel +WIFI	Brasil verion EU, US, AR, AU,EK...plug for optional	10pcs, 5.6kgs 47*37*29cm	
4	Gpon G-140W-MF	4GE+1tel +1USB+WIFI dual band ac wifi 2.4G+5G	SC/UPC, EU, US, AR, AU,EK...plug for optional	15pcs, 8.7kgs 57*32*28cm	
5	Gpon G-140W-C	4GE+1tel +1USB+WIFI dual band ac wifi 2.4G+5G	SC/UPC, EU, US, AR, AU,EK...plug for optional	10pcs, 9kgs 49*41*32cm	
6	Gpon G-140W-MD	1GE+3FE+1tel +USB+WIFI	SC/UPC, EU, US, AR, AU,EK...plug for optional	20pcs, 7.2kgs 50*27*26cm	
7	Gpon G-140W-MH	1GE+3FE+1tel +USB+WIFI	SC/UPC, EU, US, AR, AU,EK...plug for optional	20pcs, 7.2kgs 50*27*26cm	
8	ONU.OEM006	1GE+1FE+WIFI+CATV	GPON/EPON dual mode,SC/APC EU, US, AR, AU,EK...plug for optional	50pcs,18.5kgs 55*48*30cm	
9	Gpon F601v6.0	1GE(Bridge)	SC/UPC EU, US, AR, AU,EK...plug for optional	40pcs, 13.5kgs 60*31*35cm	









10	Gpon F612V6.0	1GE +1FE+1POT	SC/UPC, EU, US, AR, AU,EK...plug for optional	20pcs, 7.5kgs 38*30*37cm	
11	Gpon F660V6.0	1GE+3FE+1tel +USB+WIFI	SC/UPC, EU, US, AR, AU,EK...plug for optional	20pcs, 11.5kgs 50*30*42cm	
12	Gpon F660V5.0	4FE+2tel +USB+WIFI	SC/UPC, EU, US, AR, AU,EK...plug for optional	20pcs, 10.8kgs 50*30*42cm	
13	Gpon F663N V3a	1GE+3FE+1tel +USB+ WIFI	SC/UPC, China Mobile logo EU, US, AR, AU,EK...plug for optional	40pcs, 15kgs 40*40*37cm	
14	Gpon F660V8.0 5dBi	1GE+3FE+1tel +USB+ WIFI	SC/UPC, external antenna EU, US, AR, AU,EK...plug for optional	20pcs, 9.5kgs 48*30*37cm	
15	Gpon F609V5.2 5dBi	4GE+1tel +USB+ WIFI	SC/UPC, external antenna EU, US, AR, AU,EK...plug for optional	20pcs, 13.5kgs 57*40*37cm	
16	GPON ONU F670Lv1.0 12 lights	4GE+1tel +1USB+WIFI dual band ac wifi 2.4G+5G	SC/UPC, external antenna EU, US, AR, AU,EK...plug for optional	20pcs, 13.5kgs 44*26*47cm	
17	GPON ONU F670Lv7.1 5 lights without on/off button	4GE+1tel +1USB+WIFI dual band ac wifi 2.4G+5G	SC/UPC, external antenna EU, US, AR, AU,EK...plug for optional	20pcs, 13.5kgs 44*26*47cm	
18	GPON ONU F673A v9.0	4GE+1tel +1USB+WIFI dual band ac wifi 2.4G &5G	SC/UPC, external antenna EU, US, AR, AU,EK...plug for optional	20pcs, 13kgs 59*39*41cm	
19	Gpon F680v1.1	4GE+1tel +1USB+WIFI dual band ac wifi 2.4G+5G	SC/UPC, external antenna EU, US, AR, AU,EK...plug for optional	20pcs, 10.8kgs 43*30*44cm	





No	Model	configuration	remarks	package /carton	remarks
1	OEM ONU.2100CM	1GE+CATV(Brigde&Route)	GPON/EPON ,SC/APC EU, US, AR, AU,EK...plug for optional	50pcs,12.5kgs 50*34.5*28.5cm	
2	ONU.2100M--SC/UPC (Mimi ONU)	1GE(Brigde&Route)	XPON(GPON&EPON)SC/UPC With Typec-USB wire , adapter for optional	12pcs/small box, 720pcs/carton,27kgs 55*52*25cm	
3	OEM ONU.2101M	1GE+2.4GWIFI	GPON/EPON ,SC/UPC EU, US, AR, AU,EK...plug for optional	60pcs,12.5kgs 52*49.5*23cm	
4	OEM ONU.2201CM	1GE+1FE+2.4GWIFI+CATV	GPON/EPON ,SC/APC EU, US, AR, AU,EK...plug for optional	40pcs,14.8kgs 55*48*30cm	
5	OEM ONU.2401CM	1GE+3FE+2.4GWIFI+CATV	GPON/EPON ,SC/APC EU, US, AR, AU,EK...plug for optional	40pcs,14.8kgs 55*48*30cm	
6	OEM ONU.2202CM	2GE+2.4G&5GWIFI+CATV dual band ac wifi + Catv	GPON/EPON ,SC/APC EU, US, AR, AU,EK...plug for optional	40pcs,15.8kgs 53.6*48*48cm	
7	Gpon F601v6.0	1GE(Bridge&Route)	SC/UPC EU, US, AR, AU,EK...plug for optional	40pcs, 13.5kgs 60*31*35cm	
8	Gpon F643v6.0	1GE(Brigde&Route)	SC/UPC EU, US, AR, AU,EK...plug for optional	40pcs, 13.5kgs 60*31*35cm	
9	Gpon F612V6.0	1GE +1FE+1POT (Brigde&Route)	SC/UPC, EU, US, AR, AU,EK...plug for optional	20pcs, 7.5kgs 38*30*37cm	

10	Gpon F660V6.0 5dBi External antenna	1GE+3FE+1tel +USB+2.4GWIFI	SC/UPC, EU, US, AR, AU,EK...plug for optional	30pcs,18.2kgs 67*52*31cm	
11	Gpon F660V5.0	4FE+2tel +USB+2.4GWIFI	SC/UPC, EU, US, AR, AU,EK...plug for optional	20pcs, 10.8kgs 50*30*42cm	
12	Gpon F660V8.0 5dBi	1GE+3FE+1tel +USB+ 2.4GWIFI	SC/UPC, external antenna EU, US, AR, AU,EK...plug for optional	20pcs, 9.5kgs 48*30*37cm	
13	Gpon F663N V3a	1GE+3FE+1tel +USB+ 2.4GWIFI	SC/UPC, EU, US, AR, AU,EK...plug for optional	40pcs, 15kgs 40*40*37cm	
14	Gpon F690L V9.0	4GE+1POTS+2.4G&5G WIFI+2USB dual band ac wifi	SC/UPC, EU, US, AR, AU,EK...plug for optional		





2.4 Category Products-Router / Repeater /AP



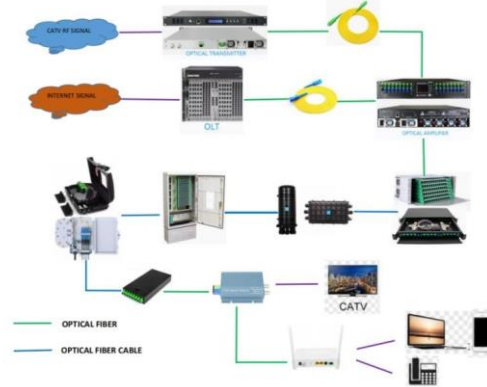
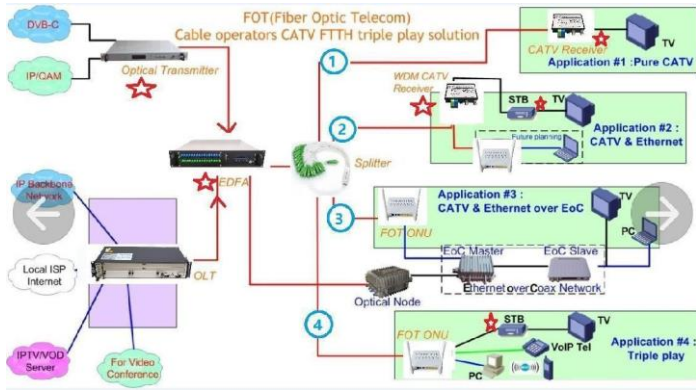

No.	model	configuration	pictures
1	BL-WR450H IPV4	300Mbps High Gain Smart wireless NAP/Router, 2.4Ghz, up to 300Mbps 1x10/100M self-adaptive WAN 2x10/100M self-adaptive LAN	
2	BL-W1210M	11AC 1200Mbps Wireless Dual band router 4*5dBi high-gain Omni Directional Antennas 2.4GHz,5GHz, Up to 1200Mbps 1x10/100Mbps WAN port 4x10/100Mbps LAN port	
3	BL-WR1300H IPV6	11AC 1200Mbps Wireless Dual Band Gigabit port Router11AC (2.4G+5G) 2.4GHz: IEEE802.11 n/ g/ b; 5.0GHz: IEEE 802.11a c/n /a /u/ab 4*6dBi antennas High Range/IPTV/VLAN/VPN/MU-MIMO 2.4GHz,5GHz, Up to 1200Mbps 1x10/100/1000Mbps WAN port 4x10/100/1000Mbps LAN port	
4	BL-AX1800 WiFi6 Router IPV6	Processor:1.5GHz Quad-Core CPU 3x RJ45 1000/100/10M Lan LED Ports 1 x RJ45 1000/100/10M WAN LED Ports 4*5dBi Fixed Qmni-DirectionAntennasIEEE802.11ax/ac/a 5GHz IEEE802.11ax/ac/a 2.4GHz US power 12V 1A	
5	BL-WR450D	300M Wireless NAP/Router (1+2 LAN)/ Multi-Mode 6 in1/4*5dBi antennas /superadmin management fuction 4+32RAM tr069 similar DLINK SOFTWARE	
6	Tenda F3	300Mbps 3x5dBi external undetachable antennas 300Mbps over 2.4GHz band 10/100Mbps WAN port*1 10/100Mbps LAN ports*3 Standard& Protocol: IEEE802.11/b/g/n 9V 0.6A	
7	Tenda AC5s AC1200	Standard& Protocol:IEEE802.3, IEEE802.3u Interface: 10/100Mbps WAN port*1 10/100Mbps LAN ports*3 4*5dBi external dual band antennas IEEE 802.11ac/a/n @5GHz IEEE 802.11b/g/n @2.4GHz Input: AC 100-240V—50/60Hz Output: DC 9V 1A	
8	Tenda router MESH MW3	AC1200 Whole-home Mesh WiFi System IEEE 802.11ac/a/n 5GHz IEEE 802.11b/g/n 2.4GHz 5GHz: Up to 867Mbps 2.4GHz: Up to 300Mbps 3pcs/pack, 12V 1A	



9	netis NC21	Wi-Fi 5 black AC1200 Wireless Dual Band Router IEEE 802.11ac/n 5 GHz IEEE 802.11n/b/g 2.4 GHz Protocols:IPv4, IPv6 1x Fast WAN Port (10/100) 3x Fast LAN Ports(10/100) support TR069	
10	netis N6T	Wi-Fi 6 AX1800 WiFi6 Dual Band Router IEEE 802.11ax/ac/n/a 5 GHz IEEE 802.11ax/n/b/g 2.4 GHz Protocols:IPv4, IPv6 1x Gigabit WAN Port 3x Gigabit LAN Ports Support TR069 TR181 TR143	
11	grandstream Router HT812	Powerful 2-port ATA with Gigabit NAT Router 2 FXS ports and an integrated Gigabit NAT router	
12	grandstream Router HT814	Powerful 4 port FXS Gateway with Gigabit NAT Router 4 FXS ports and an integrated Gigabit NAT router	
13	grandstream Router HT818	Powerful 8 port FXS Gateway with Gigabit NAT Router 8 FXS ports and an integrated Gigabit NAT router	

2.5 Category Products-EDFA, WDM,CATV transmitter





code no.	model no.	description	remarks	picture
Directly modulated optical transmitter				
GQSFQ.001	OT8510B	1550NM-10DB ,Transmission distance 25KM	AC power , EU/US/UK power cord for optional	
GQSFQ.002	OT8510C	1550NM-10DB ,Transmission distance 35KM		
GQSFQ.003	OT8510D	1550NM-10DB ,Transmission distance 42KM		
Externally modulated optical transmitter / optical CATV transmitter 1550nm External modulation				
GQSFQ.004	WT1550-2*7	1550nm,2*7dB Adjustable output power	AC power , EU/US/UK power cord for optional	
GQSFQ.005	WT1550-2*8	1550nm,2*8dB Adjustable output power		
GQSFQ.006	WT1550-2*9	1550nm,2*9dB Adjustable output power		
GQSFQ.007	WT1550-2*10	1550nm,2*10dB Adjustable output power		
EDFA optical fiber amplifier				
GQSFQ.008	EDFA 4*16 DB	4 Port 16dBm CATV 1550nm EDFA	dual power supply 220V	





GQSFQ.009	EDFA 4*16 DB with WDM	4 Port 16dBm CATV 1550nm EDFA with WDM				
GQSFQ.010	EDFA 8*18 DB	8 Port 18dBm CATV 1550nm EDFA	482*360*44mm, 11kgs			
GQSFQ.011	EDFA 8*18 DB with WDM	8 Port 18dBm CATV 1550nm EDFA with WDM				
GQSFQ.012	EDFA 8*19 DB	8 Port 19dBm CATV 1550nm EDFA				
GQSFQ.013	EDFA 8*19 DB with WDM	8 Port 19dBm CATV 1550nm EDFA with WDM				
GQSFQ.014	EDFA 8*20 DB	8 Port 20dBm CATV 1550nm EDFA				
GQSFQ.015	EDFA 8*20 DB with WDM	8 Port 20dBm CATV 1550nm EDFA with WDM				
GQSFQ.016	EDFA 8*21 DB	8 Port 21dBm CATV 1550nm EDFA				
GQSFQ.017	EDFA 8*21 DB with WDM	8 Port 21dBm CATV 1550nm EDFA with WDM				
GQSFQ.018	EDFA 8*22 DB	8 Port 22dBm CATV 1550nm EDFA				
GQSFQ.019	EDFA 8*22 DB with WDM	8 Port 22dBm CATV 1550nm EDFA with WDM				
GQSFQ.020	EDFA 8*23 DB	8 Port 23dBm CATV 1550nm EDFA				
GQSFQ.021	EDFA 8*23 DB with WDM	8 Port 23dBm CATV 1550nm EDFA with WDM				
GQSFQ.022	EDFA 16*18 DB	16 Port 18dBm CATV 1550nm EDFA			482*450*89mm, 11kgs	
GQSFQ.023	EDFA 16*18 DB with WDM	16 Port 18dBm CATV 1550nm EDFA with WDM				
GQSFQ.024	EDFA 16*19 DB	16 Port 19dBm CATV 1550nm EDFA				
GQSFQ.025	EDFA 16*19 DB with WDM	16 Port 19dBm CATV 1550nm EDFA with WDM				
GQSFQ.026	EDFA 16*20 DB	16 Port 20dBm CATV 1550nm EDFA				
GQSFQ.027	EDFA 16*20 DB with WDM	16 Port 20dBm CATV 1550nm EDFA with WDM				
GQSFQ.028	EDFA 16*21 DB	16 Port 21dBm CATV 1550nm EDFA				
GQSFQ.029	EDFA 16*21DB with WDM	16 Port 21dBm CATV 1550nm EDFA with WDM				
GQSFQ.030	EDFA 16*22 DB	16 Port 22dBm CATV 1550nm EDFA				
GQSFQ.031	EDFA 16*22 DB with WDM	16 Port 22dBm CATV 1550nm EDFA with WDM				
GQSFQ.032	EDFA 16*23 DB	16 Port 23dBm CATV 1550nm EDFA				
GQSFQ.033	EDFA 16*23 DB with WDM	16 Port 23dBm CATV 1550nm EDFA with WDM				
GQSFQ.034	EDFA 32*18 DB	32 Port 18dBm CATV 1550nm EDFA	482*450*89mm, 11kgs			
GQSFQ.035	EDFA 32*18 DB with WDM	32 Port 18dBm CATV 1550nm EDFA with WDM				
GQSFQ.036	EDFA 32*19 DB	32 Port 19dBm CATV 1550nm EDFA				
GQSFQ.037	EDFA 32*19 DB with WDM	32 Port 19dBm CATV 1550nm EDFA with WDM				
GQSFQ.038	EDFA 32*20 DB	32 Port 20dBm CATV 1550nm EDFA				
GQSFQ.039	EDFA 32*20 DB with WDM	32 Port 20dBm CATV 1550nm EDFA with WDM				
GQSFQ.040	EDFA 32*21 DB	32 Port 21dBm CATV 1550nm EDFA				
GQSFQ.041	EDFA 32*21 DB with WDM	32 Port 21dBm CATV 1550nm EDFA with WDM				
GQSFQ.042	EDFA 32*22 DB	32 Port 22dBm CATV 1550nm EDFA				
GQSFQ.043	EDFA 32*22 DB with WDM	32 Port 22dBm CATV 1550nm EDFA with WDM				
GQSFQ.044	EDFA 32*23 DB	32 Port 23dBm CATV 1550nm EDFA				
GQSFQ.045	EDFA 32*23 DB with WDM	32 Port 23dBm CATV 1550nm EDFA with WDM				

GQSFQ.046	EDFA 32*23 DB dual input	1550NM Multiport EYDFA(32*23dBm,Dual power supply 90-260V+48V,dual inputs,fiber inputs SC/APC,OLT inputsSC/APC)	482*450*89mm, 11kgs	
GQSFQ.047	EDFA 32*23 DB dual input with WDM	1550NM Multiport EYDFA(32*23dBm,with built in WDM,Dual power supply 90-260V+48V,dual inputs,fiber inputs SC/APC,OLT inputsSC/APC)		
GQSFQ.048	EDFA, 16port, 22DB, with WDM+1550nm Directly modulated optical transmitter	SC/APC 22DB 1550nm 16ports output CATV EDFA combiner with WDM 1550nm optic transceiver +EDFA GPON for CATV	482*450*89mm, 11kgs	

Optical receiver

GQSFQ.049	HS-OR1 (80*27*24mm)	Single port output, when 0dBm optical input, the output level is 65dBm receiving range 1100-1600nm, without WDM		
GQSFQ.050	OR101WA	Single port output, when 0dBm optical input, the output level is 65dBm receiving range 1310+1490+1550, with WDM		
GQSFQ.051	OR101WA	dual port output, when 0dBm optical input, the output level is 65dBm receiving range 1310+1490+1550, with WDM		
GQSFQ.052	HS-OR22A	Two-stage GaAs low noise amplifier circuit Light control AGC control range +2~-15dBm, output level 80dBm OR22: receiving range -18dBm; 5V Without WDM 1100~1600 nm OR 1550nm		
GQSFQ.053	HS-OR23	High-quality housing RF channel two-stage GaAs low-noise amplifier circuit. AGC control range 0-15dBm/80; dual port output. Supply voltage: 5V Without WDM		
GQSFQ.054	HS-OR23B	High-quality housing RF channel two-stage GaAs low-noise amplifier circuit. AGC control range: 0-15dBm/100; dual port output. Supply voltage: 5V Without WDM		
GQSFQ.055	HS-OR23W	High-quality housing RF channel two-stage GaAs low-noise amplifier circuit. With optical fiber sub-wave interface, optical fiber connector is optional. AGC control range 0-15dBm/80; dual port output. Supply voltage: 5V With WDM		
GQSFQ.056	HS-OR23BW	High-quality housing RF channel two-stage GaAs low-noise amplifier circuit. AGC control range 0-15dBm/100 dBuv; dual-port output. Supply voltage: 5V With WDM		

2.6 Category OTDR/VFL/Test Tools

GQSFQ.057	HS-OR31	<p>High-quality housing RF channel two-stage GaAs low-noise amplifier circuit.</p> <p>AGC control range: 0~-15dBm/80dBuv; dual-port output.</p> <p>Supply voltage: 5V</p> <p>Without WDM</p>	
GQSFQ.058	HS-OR31WD	<p>High-quality housing RF channel two-stage GaAs low-noise amplifier circuit. With WDM subwave, subwave fiber port is optional,</p> <p>AGC control range: 0~-15dBm/80dBuv; dual-port output.</p> <p>Supply voltage: 5V</p> <p>With WDM</p>	
GQSFQ.059	HS-FTTB-OR31	<p>High-quality housing RF channel two-stage GaAs low-noise amplifier circuit.</p> <p>AGC control range: 0~-15dBm/100dBuv; dual-port output.</p> <p>Supply voltage: 5V</p> <p>Without WDM</p>	
GQSFQ.060	HS-FTTB-OR31B	<p>High-quality housing RF channel two-stage GaAs low-noise amplifier circuit. With WDM subwave, subwave fiber port is optional,</p> <p>AGC control range: 0~-15dBm/100dBuv; dual-port output, Supply voltage: 5V</p> <p>With WDM</p>	
GQSFQ.061	HS--OR21W	<p>Received optical power range +2db~-18dbm, optical control AGC range: +2~-10dbm, output level is greater than 88dbuv, power input +5VDC~+14VDC, power consumption is less than 2W, optical fiber connector optional,</p> <p>With WDM</p>	

Optical Time Domain Reflectometer

NK2230 Mini Optical Time Domain Reflectometer	4
NK3200 Mini PRO Optical Time Domain Reflectometer	6
NEW NK4000 Mini PRO Optical Time Domain Reflectometer	8
NK5600 Multi-function Optical Time Domain Reflectometer	10
NK6000 Multi-function Optical Time Domain Reflectometer	12
NK6000 PON Optical Time Domain Reflectometer	14
NEW NK6200 High-performance Optical Time Domain Reflectometer ...	16
NEW NK6200 PON Optical Time Domain Reflectometer	18
NK6800 High performance Optical Time Domain Reflectometer ...	20
NK6800 PON Optical Time Domain Reflectometer	22
NK7000 Optical Cable Identifier	24

Basic test instruments

NEW NK120 Optical fiber Visual Fault Location pen	28
NK200 Mini Optical Power Meter	30
NEW NK260 Mini Optical Power Meter	32
NK300 Optical Power Meter/OPM+VFL Integrated Machine	34
NK301 Stable Laser Source	36
NK302 Optical Multimeter	38
NK303A Optical Power Meter+Visual Fault Location	40
NK303B Light Source+ Optical Power Meter+Visual Fault Location ..	40
NK303C Insertion&Return Loss Tester	42
NK305 Variable Optical Attenuator	44

NK306 Optical Fiber Ranger	46
NEW NK307 PON Optical Power Meter	48
NEW NK308 10G Wavelength Division Optical Power Meter	50
NEW NK411 Optical Fiber Identifier	52
NEW NK412 Optical Fiber Identifier	54
NK501 PON Optical Power Meter	56
NK502 PON Network State Tester	58
NEW NK503 10G EPON / XGPON Optical Power Meter	60
NEW NK530 CWDM Optical Power Meter	62

Modular test equipment series

NK1000 Optical Time Domain Reflectometer module	66
NK1001 Optical Time Domain Reflectometer module	68
NK1002 Cloud Module Optical Network Tester	70

Fiber optic health monitoring system

NK1003 Cloud Optical Cable Intelligent Monitoring Module and System ...	74
---	----

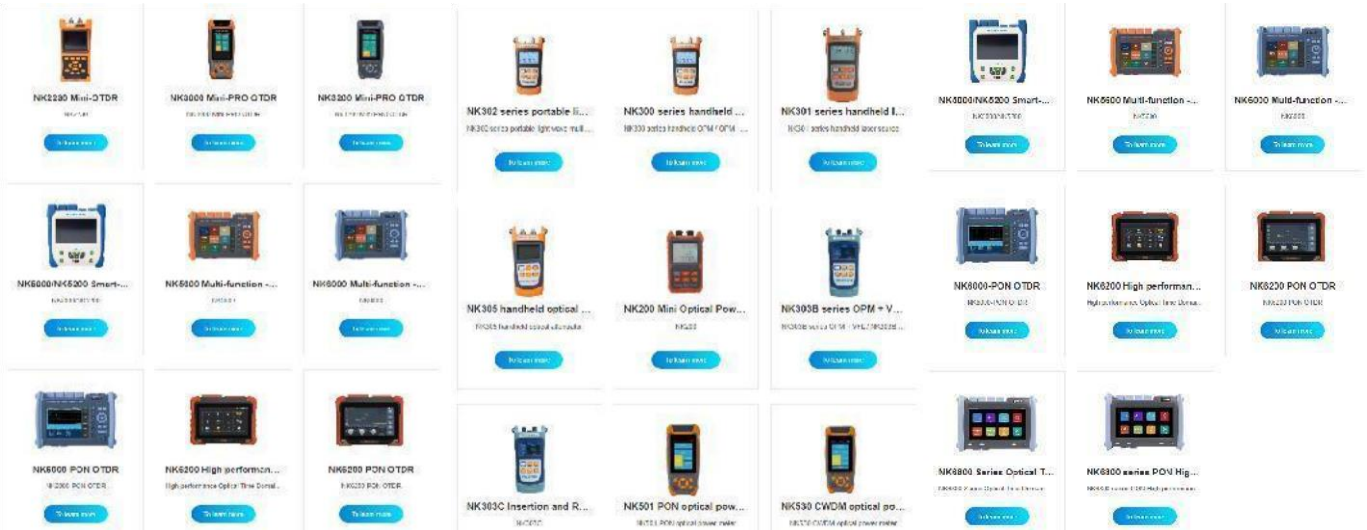

NK120 Optical fiber Visual Fault Location pen



Product overview

The NK120 series optical fiber visual fault location pen is a portable and easy-to-use instrument for detecting fiber optic faults. It features a high-resolution camera and a built-in laser source, allowing for precise fault location and identification. The device is designed for field use and is compatible with various fiber optic cables.

NK3200 series Mini PRO Optical Time Domain Reflectometer



Product overview

The NK3200 series Mini PRO Optical Time Domain Reflectometer is a compact and powerful instrument for measuring fiber optic cable characteristics. It provides accurate measurements of distance to faults, loss, and reflectance. The device is suitable for both indoor and outdoor use and is easy to operate.

NK4000 Mini PRO OTDR



Product overview

The NK4000 Mini PRO OTDR is a high-performance instrument for measuring fiber optic cable characteristics. It offers advanced features such as multi-wavelength testing and automatic loss calculations. The device is designed for professional use in network maintenance and troubleshooting.

NK6000 Multi-Functional Optical Time Domain Reflectometer









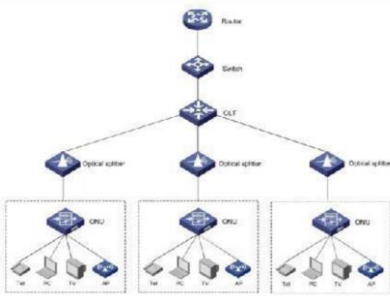







Product overview







The NK6000 Multi-Functional Optical Time Domain Reflectometer is a versatile instrument for measuring fiber optic cable characteristics. It supports multiple wavelengths and provides comprehensive testing capabilities. The device is ideal for use in a variety of network environments.

2.6 Category Products-Switch/Router



NO	Model No	Description	QTY	UNIT	Reference Pic
1	Huawei Enterprise Router NE40E-X8	NE40E-X8 basic config (include NE40E-X8chassis/2 + 1 backup 200g routing switching board and switching network board / four AC power/ power cord, Including software cost and data)	1	pcs	 NE40E-X8
2	Huawei Enterprise Router NE40E-X8A	NE40E-X8A basic config(include NE40E-X8A chassis/ dual main control / 2x480G switch board / six AC power / two fan chassis, Including software cost and data)	1	pcs	 NE40E-X8A
3	Huawei router NE40E-X3A	NE40E-X3A basic config: (include NE40E-X3A chassis/ dual main control /dual DC power, and software and data fee)	1	pcs	 NE40E-X3A
4	cards for Huawei router NE40E-X8	CR5DL4XEBG7L 4*10GBase LAN/WAN-SFP+ and 12*100/1000Base-X-SFP Integrated circuit processing board L (LPUI-51-L)	1	pcs	
5	CloudEngine S12700E-4	CloudEngine S12700E-4 basic configuration: 1. ET1BS12704E0 assembly chassis*1 (with mounting brackets) 2. MPU(Main Processing Unit: EC*2pcs 3. SFU(Switch Fabric Unite): E(X1)*2pcs 4. AC Power 3000W *2pcs 5. LPU(Line Processing Unit)slots: 4slots (not include LPU cards) 441.7*442*517.4, 10U /24.5kg	1	pcs	
6	CloudEngine S12700E-8	CloudEngine S12700E-8 basic configuration: 1. ET1BS12704E0 assembly chassis*1 (with mounting brackets) 2. MPU(Main Processing Unit: EC*2pcs 3. SFU(Switch Fabric Unite): E(X1)*4pcs 4. AC Power 3000W *4pcs 5. LPU(Line Processing Unit)slots: 8slots (not include LPU cards) 663.95*442*517.4, 15U /42.5kg	1	pcs	

7	CloudEngine S12700E-12	CloudEngine S12700E-12 basic configuration: 1. ET1BS12704E0 assembly chassis*1 (with mounting brackets) 2. MPU(Main Processing Unit: EC*2pcs 3. SFU(Switch Fabric Unite): E(X1)*4pcs 4. AC Power 3000W *4pcs 5. LPU(Line Processing Unit)slots:12slots (not include LPU cards) 41.75*442*517.4, 19U /71.8kg	1	pcs	
8	AC Power 3000W	suitable for S12700E-4 work for CloudEngine S12700E	1	pcs	
9	100GE Ethernet Optical interface card	100GE interface card LST7C06HX6S0 6-port 100GE QSFP28 interface card (X6S, QSFP28) work for CloudEngine S12700E	1	pcs	
10	40GE/100GE Ethernet Optical interface card	40GE/100GE interface card LST7C02BX6E0 2-port 100GE QSFP28 interface and 4-port 40GE QSFP28 interface card (X6E, QSFP28) work for CloudEngine S12700E	1	pcs	
11	40GE Ethernet Optical interface card	40GE interface card LST7L12QX6E0 12 Port 40GE Ethernet Optical Interface Board work for CloudEngine S12700E	1	pcs	
12	Huawei Switch S6730-H48X6C	S6730-H48X6C (48x 10GE SFP+, 6x 40GE QSFP28) not include power module not include liscense	1	pcs	 CloudEngine S6730-H48X6C
13	Huawei Switch S6730-H24X6C	S6730-H24X6C (24*10 Gigabit SFP+ 6 *40GE QSFP28 not include power module not include liscense	1	pcs	 CloudEngine S6730-H24X6C
14	DC power module	use for S6730	1	pcs	
15	AC power module	use for S6730	1	pcs	
16	100G liscense	use for S6730	1	pcs	
17	Huawei switch S6730-S24X6Q	24 x 10 Gig SFP+, 6 x 40 Gig QSFP+ not include power	1	pcs	 CloudEngine S6730-S24X6Q
18	DC power module	use for S6730-S24X6Q	1	pcs	
19	AC power module	use for S6730-S24X6Q	1	pcs	
20	100G liscense	use for S6730	1	pcs	
24	Huawei CloudEngine S5731-S32ST4X-A	24 x GE SFP ports, 8 x 10/100/1000Base-T Ethernet ports, 4 x 10GE SFP+ ports, not include power	1	pcs	 CloudEngine S5731-S32ST4X-A
25	DC power module	use for S5731	1	pcs	
26	AC power module	use for S5731	1	pcs	

27	Huawei switch S5720-36C-EI-28S	28 Gig SFP ports (4 of which are dual-purpose 10/100/1000 ports), 4 10GE SFP+ ports not include power	1	pcs	
28	DC power module	use for S5720-36C-EI	1	pcs	
29	AC power module	use for S5720-36C-EI	1	pcs	
34	Huawei switch S6720-54C-EI-48S	48 x 10 Gig SFP+, 2 x 40 Gig QSFP+ not include power (HW another series, without huawei Logo)	1	pcs	
35	DC power module	use for S6720-54C-EI-48S	1	pcs	
36	AC power module	use for S6720-54C-EI-48S	1	pcs	
37	NetEngine 8000 M1A	NetEngine 8000 M1A basic configuration include M1A chassis, ports 6*10GE+26*GE 1*AC power supply, include software and data support BGP protocol	1	pcs	
38	S5735-L32ST4X-D1	S5735-L32ST4X-D1 Basic configuration (24*GE SFP ports, 8*10/100/1000BASE-T ports, 4*10GE SFP+ ports, DC Power*1, front access) No need license	1	SET	
39	S5735-L32ST4X-A1	S5735-L32ST4X-A1 Basic configuration (24*GE SFP ports, 8*10/100/1000BASE-T ports, 4*10GE SFP+ ports, AC Power*1, front access) No need license	1	SET	
40	Huawei Switch CE6881-48S6CQ-B	CE6881-48S6CQ-B Switch Basic Configuration (48*10G SFP+, 6*100G QSFP28, 2*AC Power Modules, 4*Fan modules, Port-side intake) No need license	1	SET	



No.	Brand	Model	Picture
1	H-W Switch	S5731-S24P4X 24x10/100/1000BASE-T Ethernet ports, 4x10GE SFP+ ports,POE+, not include power supply	
2	H-W Switch	S5735-L24T4S-A1 24x10/100/1000BASE-T Ethernet ports, 4xGE SFP+ ports,include 1*AC power supply	
3	H-W Switch	S5735-L24T4X-A1 24x10/100/1000BASE-T Ethernet ports, 4x10GE SFP+ ports,include 1*AC power supply	
4	H-W Switch	S5735-L32ST4X-A1 24*GE SFP ports, 8x10/100/1000BASE-T Ethernet ports, 4x10GE SFP+ ports, include 1*AC power supply	

Hot Sale HUAWEI Switch Series01







 S6730-H24x6C S6730-H24x6C 24*10 Gigabit SFP+ 6 *40GE QSFP28, license optional for upgrade to 6 *100GE QSFP28, not include power supply	 S6730-H48x6C S6730-H48x6C 48*10 Gigabit SFP+ 6 *40GE QSFP28, license optional for upgrade to 6 *100GE QSFP28, not include power supply	 S6720S-26Q-EI-24S-AC S6720S-26Q-EI-24S-AC 24*10 Gigabit SFP+, 2 *40GE QSFP+, include 1x170W AC power supply
 S5735-L24T4S-A1 S5735-L24T4S-A1 24x10/100/1000BASE-T Ethernet ports, 4x10GE SFP+ ports, include 1*AC power supply	 S5735-L24T4X-A1 S5735-L24T4X-A1 24x10/100/1000BASE-T Ethernet ports, 4x10GE SFP+ ports, include 1*AC power supply	 S5735-L32ST4X-A1 S5735-L32ST4X-A1 8x10/100/1000BASE-T Ethernet ports, 4x10GE SFP+ ports, include 1*AC power supply
 S5735-L48T4X-A1 S5735-L48T4X-A1 48x10/100/1000BASE-T Ethernet ports, 4x10GE SFP+ ports, include 1*AC power supply	 S5735-L24P4S-A1 S5735-L24P4S-A1 24x10/100/1000BASE-T Ethernet ports, 4x10GE SFP+ ports, include 1*AC power supply	 S5731-S24P4X S5731-S24P4X 24x10/100/1000BASE-T Ethernet ports, 4x10GE SFP+ ports,POE+, not include power supply

Hot Sale HW Switch Series02 (Without HW Logo)

 S5735-L24T4S-A1 24x10/100/1000BASE-T Ethernet ports, 4xGE SFP+ ports, include 1*AC power supply	 S5735-L24P4S-A1 24x10/100/1000BASE-T Ethernet ports, 4xGE SFP+ ports,POE+ include 1*AC power supply	 S5735-L24T4X-A1 24x10/100/1000BASE-T Ethernet ports, 4x10GE SFP+ ports, include 1*AC power supply
 S5735-L32ST4X-A1 24 *GE SFP ports, 8x10/100/1000BASE-T Ethernet ports, include 1*AC power supply	 S5735-L48T4X-A1 48x10/100/1000BASE-T Ethernet ports, 4x10GE SFP+ ports, include 1*AC power supply	 S6720S-26Q-EI-24S-AC 24 x 10 Gig SFP+, 2x40 Gig QSFP+, include 1x170W AC power supply
 S6720-30C-EI-24S-AC 24 x 10 Gig SFP+, 2 x 40 Gig QSFP+, Single sub-card slot, including 1x 600W AC power supply	 S6720-54C-EI-48S-AC 48 x 10 Gig SFP+, 2 x 40 Gig QSFP+, Single sub-card slot, including 1x 600W AC power supply	 S5736-S48S4XC 48 *GE SFP ports, 4 x 10 Gig SFP+, Single sub-card slot, including 1x 600W AC power supply

5	H-W Switch	S5735-L48T4X-A1 48x10/100/1000BASE-T Ethernet ports, 4x10GE SFP+ ports,include 1*AC power supply	 
6	H-W Switch	S5735-L24P4S-A1 24x10/100/1000BASE-T Ethernet ports, 4xGE SFP+ ports,POE+,include 1*AC power supply	 
7	H-W Switch	S5735-L24T4S-A1 24*10 Gigabit SFP+ 6 *40GE QSFP28, license optional for upgrade to 6 *100GE QSFP28, not include power supply	 
8	H-W Switch	S6730-H48x6C 48*10 Gigabit SFP+ 6 *40GE QSFP28, license optional for upgrade to 6 *100GE QSFP28, not include power supply	 
9	H-W Switch	S6720S-26Q-EI-24S-AC 24*10 Gigabit SFP+, 2 *40GE QSFP+, include 1x170W AC power supply	 

2.8 Category Products-SFP module

No.	module	description	
1	OLT uplink board SFP modules	HUAWEI 1.25G-1310nm-10km-SM-ESFP	
		HUAWEI 10G-1310nm-10km-SM-SFP+	
		ZTE SM-10km-1310-1.25G-C	
		ZTE SM-10km-1310-10G-C	
2	Service card SFP modules	HUAWEI service board GPBD / GPF D / GPHF / GPBH SFP : GPON-OLT-CLASS C+	
		H-W service board GPBD / GPF D / GPHF / GPBH SFP : GPON-OLT-CLASS C++	

		ZTE service board GTGO / GTGH SFP, GPON-OLT-CLASS C+	
		ZTE service board GTGO / GTGH SFP, GPON-OLT-CLASS C++	
3	Switch Modules	SPF+-BIDI-10KM 10G-TX1270/RX1330nm-10KM-DDM 10G-TX1330/RX1270nm-10KM-DDM	
		SPF+-BIDI-20KM 10G-TX1270/RX1330nm-20KM-DDM 10G-TX1330/RX1270nm-20KM-DDM	
		H-W QSFP28 100G-1310nm-40Km-SM	
		H-W QSFP28 100G-1310nm-10km-SM	

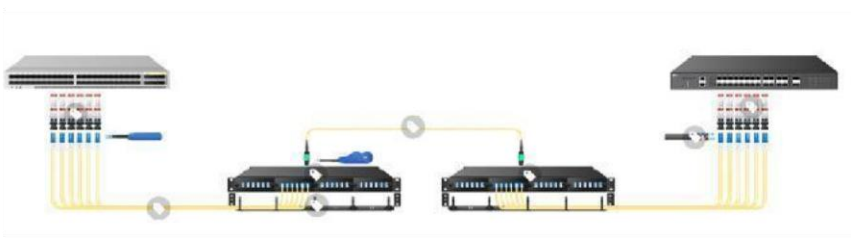

Welcome OEM & ODM

Different kind of connectors:



also being crush and rodent resistant.

Note:

1. connector: SC/FC/ST/LC-APC/UPC...for optional
 2. wire diameter: 0.9/2.0/3.0mm for optional
 3. Fiber: G652D, G657A1, G657A2 for optional
 4. Length : 0.5M, 1M, 1.5M, 2M...customized
 5. Jacket :PVC or LSZH for optional
 6. Mode: SM, MM (OM1,OM2,OM3,OM4...)
- example :

SC/APC-SC/APC-G652D-3.0mm-PVC-3M-SM

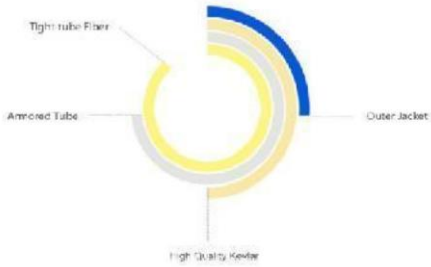

Armored Patch Cables Datasheet

PERFECT SOLUTION FOR INSTALLS THAT REQUIRE EXTRA PROTECTION



The armored patch cables will allow you to protect your critical and essential fiber optic network with a crush-resistant and rodent-resistant jacket. The cable is a perfect solution for installing that require extra protection. The jacket contains steel armor and an aramid yarn strength member which allows the cable to remain extremely flexible while

单模单芯光纤跳线

Single Mode Simplex Patch Cord

重复性好 稳定性高 Good Repeatability, High Stability

全新材质，耐高温环境长期使用不变形，不断裂，不脱落，专业全自动标准化生产，尽量减少人工干预，质量稳定

New material, high-temperature resistance, environmentally durable, non-deforming, non-breaking. Specially fully automatic standard production, minimize manual intervention, quality stability

插损低 稳定性好 Low Insertion Loss, Good Stability

采用高品质纤芯，其可靠性高，稳定性好，有更好的同心度和尺寸精度保证产品质量

High Quality Ferrule, High Reliability, Good Concentricity And Precise Size Of Connector, Make The Quality Stability

高性能单芯纤芯 High Performance Single Mode Fiber Core

采用进口高品质纤芯，每款经过严格测试出厂，收到广大工程人员的广泛赞赏，是您光纤入户数据连接的正确选择

① Imported High Quality Fiber Core
② 100% Test Strictly Before Delivery
③ Received High Reputation From Lots Of Clients
④ It's Your Best Choice Of The Data Connection



单模双芯光纤跳线

Single Mode Duplex Fiber Jumper

重复性好 稳定性高 Good Repeatability, High Stability

全新材质，耐高温环境长期使用不变形，不断裂，不脱落，专业全自动标准化生产，尽量减少人工干预，质量稳定

New material, high-temperature resistance, environmentally durable, non-deforming, non-breaking. Specially fully automatic standard production, minimize manual intervention, quality stability

插损低 稳定性好 Low Insertion Loss, Good Stability

采用高品质纤芯，其可靠性高，稳定性好，有更好的同心度和尺寸精度保证产品质量

High Quality Ferrule, High Reliability, Good Concentricity And Precise Size Of Connector, Make The Quality Stability

高性能单芯纤芯 High Performance Single Mode Fiber Core

采用进口高品质纤芯，每款经过严格测试出厂，收到广大工程人员的广泛赞赏，是您光纤入户数据连接的正确选择

① Imported High Quality Fiber Core
② 100% Test Strictly Before Delivery
③ Received High Reputation From Lots Of Clients
④ It's Your Best Choice Of The Data Connection



多模光纤跳线

Multimode Fiber Optic Patch Cord

重复性好 稳定性高 Good Repeatability, High Stability

全新材质，耐高温环境长期使用不变形，不断裂，不脱落，专业全自动标准化生产，尽量减少人工干预，质量稳定

New material, high-temperature resistance, environmentally durable, non-deforming, non-breaking. Specially fully automatic standard production, minimize manual intervention, quality stability

插损低 稳定性好 Low Insertion Loss, Good Stability

采用高品质纤芯，其可靠性高，稳定性好，有更好的同心度和尺寸精度保证产品质量

High Quality Ferrule, High Reliability, Good Concentricity And Precise Size Of Connector, Make The Quality Stability

高性能多模纤芯 High Performance Multimode Fiber Core

采用进口高品质纤芯，每款经过严格测试出厂，收到广大工程人员的广泛赞赏，是您光纤入户数据连接的正确选择

① Imported High Quality Fiber Core
② 100% Test Strictly Before Delivery
③ Received High Reputation From Lots Of Clients
④ It's Your Best Choice Of The Data Connection



2.9 Category Products-Splitter

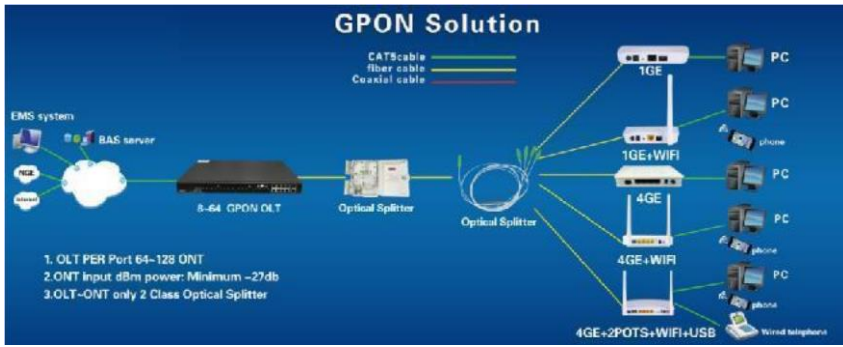

Micro PLC splitter	
ABS box splitter	
Cassette splitter	

Product Features



Application



Mini PLC Splitter without Connector

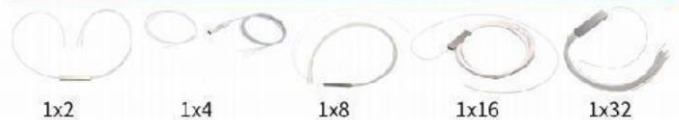

Mini PLC Splitter+SC/APC

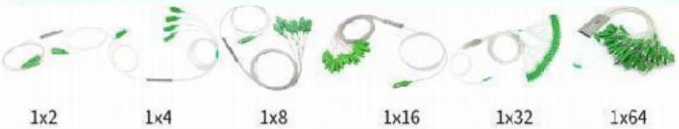

Mini PLC Splitter-SC/UPC



FBT Splitter without Connector



Customized PLC Splitter





Rack Mount PLC Splitter+SC/APC



1x4

1x8

1x16

1x32

Rack Mount PLC Splitter+SC/APC



1x4

1x8

1x16

1x32



Cassette Splitter PLC



Rack Mount Splitter PLC

ABS Box Cassette PLC Splitter+SC/APC



1x4

1x8

1x16

1x32

ABS Box Cassette PLC Splitter+SC/APC



1x4

1x8

1x16

1x32

Fiber Optic Junction Box

MBH.001



2 Cores Fiber optic termination

- Box Size: 86*58*23mm
- Material: ABS or PP



MBH.002



1 Cores Fiber optic termination

- Box Size: 85*80*22mm
- Material: ABS



MBH.003



4 Cores Fiber optic termination

- Box Size: 110*95*23mm
- Material: ABS



Fiber Optic Junction Box

MBH.004



2 Cores Fiber optic termination

- Box Size: 105*65*25mm
- Material: ABS

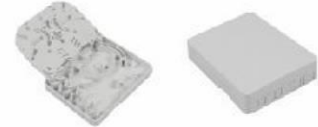

MBH.005



1 Cores Fiber optic termination

- Box Size: 134*65*23mm
- Material: ABS



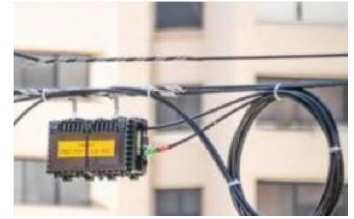

Note:

1. type: 1x2, 1x4, 1x6, 1x8, 1x12, 1x16, 1x24, 1x32

2. can be with SC/APC or SC/UPC adapter





3. can be installed with splitters

2.10 Category Products-Terminal box/FDB/NAP/CAJA/CTO

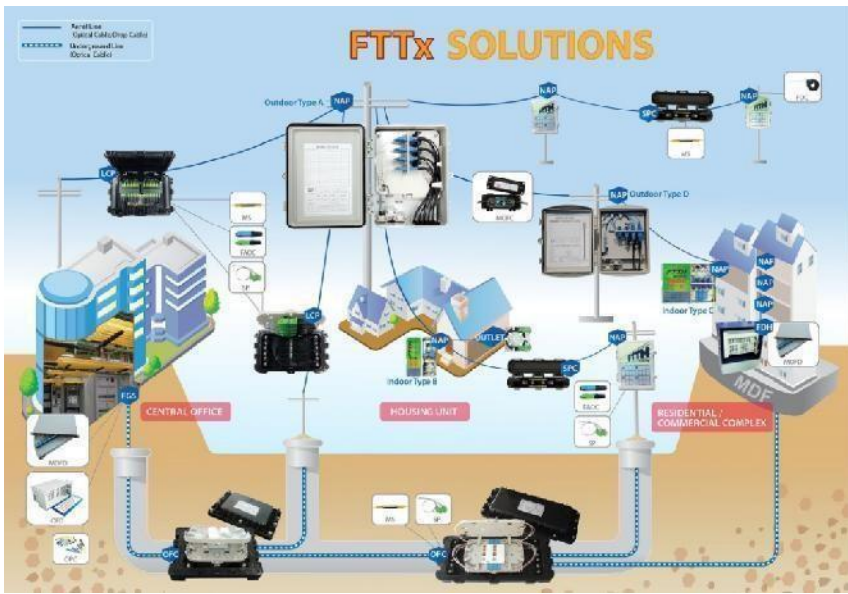
Panel picture					
model	MBH.001	MBH.002	MBH.003	MBH.004	MBH.005
NAP picture					
model	FQX.007 /8ports	FQX.007 /8ports	FQX.008 /8ports	FQX.008 /8ports	FQX.0010/32ports
NAP picture					
model	FQX.0013/16ports	FQX.0015/16ports	FQX.0014/16ports	FQX.0016/16ports	FQX.0012/16ports
NAP picture					
model	FQX.0018 /QT-96	FQX.0026 /DH-A2-16	FQX.0028 /DH-A1-16	FQX.0022 /8ports	AFAT-002 /16ports

2.11 Category Products-Splice closure

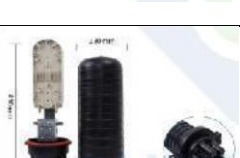

No.	Model	description	remarks	picture
1	Vertical dome type splicer closure XRT-001	Size:300mm*110mm, ABS structure: Heat Shrinkable sealing In/out Cable holes :1in 3out Max capacity (core):48cores	can use for 12C~48C	
2	Vertical dome type splicer closure XRT-002	Size:410mm*130mm, PP structure: Mechanical sealing In/out Cable holes :2in 2out Max capacity (core):96cores	can use for 12C~96C	
3	Vertical dome type splicer closure XRT-003	Size:410mm*130mm, PP structure: Mechanical sealing In/out Cable holes :3in 3out Max capacity (core):96cores	can use for 12C~96C	
4	Vertical dome type splicer closure XRT-005	Size:420mm*120mm, PP+ABS structure: heat shrinkable sealing In/out Cable holes :1in 3out Max capacity (core):96cores	can use for 12C~96C	
5	Vertical dome type splicer closure XRT-006	Size:430mm*130mm, PP+ABS structure: heat shrinkable sealing In/out Cable holes :1in 4out Max capacity (core):144cores	can use for 12C~144C	

6	<p>Vertical dome type splicer closure XRT-012</p>	<p>Size:480mm*140mm, ABS structure: heat shrinkable sealing In/out Cable holes :1in 6out Max capacity (core):168cores</p>	<p>can use for 12C~168C</p>	
7	<p>Horizontal in-line type splicer closure XRT-001</p>	<p>Size:320mm*120mm*65mm, PP structure: mechanical sealing In/out Cable holes :2in 2out Max capacity (core):24cores</p>	<p>can use for 12C~24C</p>	
8	<p>Horizontal in-line type splicer closure XRT-002</p>	<p>Size:450mm*170mm*100mm, ABS structure: mechanical sealing In/out Cable holes :2in 2out Max capacity (core):144cores</p>	<p>can use for 12C~144C</p>	
9	<p>Horizontal in-line type splicer closure XRT-006</p>	<p>Size:460mm*200mm*130mm, PC alloy structure: mechanical sealing In/out Cable holes :2in 2out Max capacity (core):144cores</p>	<p>can use for 12C~144C</p>	
10	<p>Horizontal in-line type splicer closure XRT-011</p>	<p>Size:250mm*200mm*50mm, PP structure: mechanical sealing In/out Cable holes :2in 2out Max capacity (core):144cores</p>	<p>can use for 12C~144C</p>	
11	<p>Horizontal in-line type splicer closure XRT-013</p>	<p>Size:404mm*190mm*100mm, PC alloy structure: mechanical sealing In/out Cable holes :3in 3out Max capacity (core):144cores</p>	<p>can use for 12C~144C</p>	
12	<p>Horizontal in-line type splicer closure XRT-014</p>	<p>Size:404mm*190mm*100mm, PC alloy structure: mechanical sealing In/out Cable holes :4in 4out Max capacity (core):144cores</p>	<p>can use for 12C~144C</p>	

2.12 Category Products-ODF/Cabinet/RACK





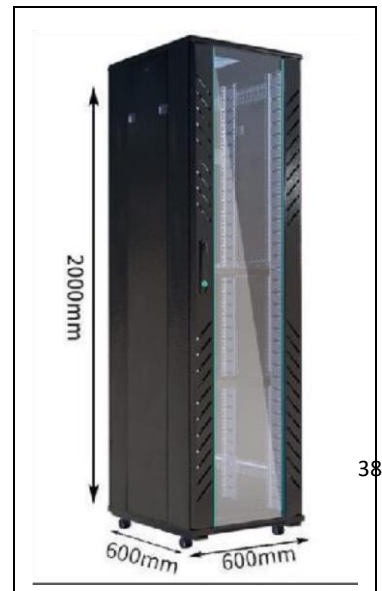
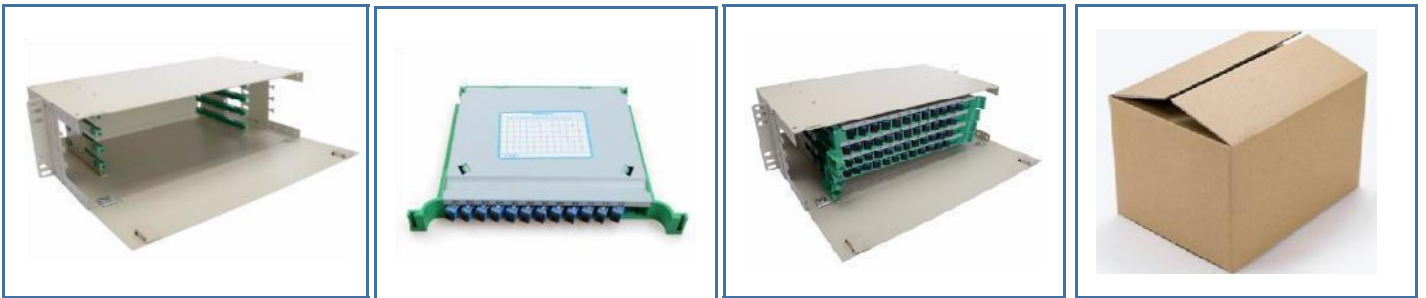

Name	Model	capacity	Size H*W*L (mm)	weight	Remarks2	Remarks2
Optical Distribution Frame (ODF)	QT-ODF-12	12cores	483*255*45 1U	5.5kgs	19", 1pcs splice tray with 12pcs pigtail	Adapter options: LC、FC、SC、ST options)
	QT-ODF-24	24cores	483*255*89 2U	6.3kgs	19", 2pcs splice trays with 24pcs pigtail	
	QT-ODF-48	48cores	483*255*133 3U	7.5kgs	19", 4pcs splice trays with 48pcs pigtail	
	QT-ODF-72	72cores	483*255*203 4U	10.5kgs	19", 6pcs splice trays with 72pcs pigtail	
	QT-ODF-96	96cores	483*255*260 5U	12.5kgs	19", 8pcs splice trays with 96pcs pigtail	
	QT-ODF-144	144cores	483*255*335 7U	15kgs	19", 12pcs splice trays with 144pcs pigtail	

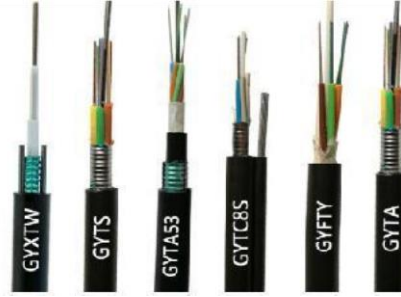
2.13 Category Products-Optic Fiber Cable





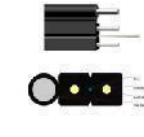
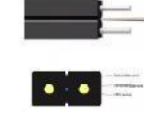







No.	Model	Description	remarks	pictures
1	ADSS	ADSS-PE-12cores, span100 , outdoor ,G652D, 2km/reel, single jacket,	<ol style="list-style-type: none"> span can be 50M,100M,150M,200M,250M cores can be 6C,8C,12C,24C,36C,48C...288C can pack as 1km,2km,3km,4km,5km per reel can print client logo on the cable 	
2	GYTC8S	12xG652D SM outdoor PE jacket messenger: 7x1mm steel wire Fibers: 1mini tube x 12fibers remarks: mini tubes with steel tape armored	<ol style="list-style-type: none"> cores can be 6C,8C,12C,24C,36C,48C...288C can pack as 1km,2km,3km,4km,5km per reel can print client logo on the cable 	
3	GYXTW	12xG652D SM outdoor PE jacket Embedded steel wire Fibers: 12 fibers remarks:Uni-Tube and Armored	<ol style="list-style-type: none"> cores can be 2C,4C,6C,8C,12C can pack as 1km,2km,3km,4km,5km per reel can print client logo on the cable 	
4	GYTS	12xG652D SM outdoor PE jacket Fibers: 1mini tube x 12fibers remarks: mini tubes with steel tape armored	<ol style="list-style-type: none"> cores can be 6C,8C,12C,24C,36C,48C...288C can pack as 1km,2km,3km,4km,5km per reel can print client logo on the cable 	
5	GYTA53	<ol style="list-style-type: none"> 12CxG652D, double PE jacket, SM 1st Armor : Aluminum tape 2nd Armor: Corrugated steel tape (1mini tubes*12fibers) Applications :Direct buried, Duct or Underground conduits.Backbone. can print client company name on it 	<ol style="list-style-type: none"> cores can be 6C,8C,12C,24C,36C,48C...288C can pack as 1km,2km,3km,4km,5km per reel can print client logo on the cable 	
6	GJYXCH	<p>outdoor, 1cores,G657A2,LSZH, wire steel, 2km/reel</p> <ol style="list-style-type: none"> can pack as 1km,2km,4km, per reel can print client logo on the cable 	<ol style="list-style-type: none"> cores can be 1C, 2C,4C jacket can be PVC, LSZH messenger can be steel wire, FRP fiber : G652D, G657A1,G657A2 for optional 	
7	GJXH	<p>indoor, 1cores,G657A2,LSZH, wire steel, 2km/reel</p> <ol style="list-style-type: none"> can pack as 1km,2km,4km, per reel can print client logo on the cable 	<ol style="list-style-type: none"> cores can be 1C, 2C,4C jacket can be PVC, LSZH messenger can be steel wire, FRP fiber : G652D, G657A1,G657A2 for optional 	

2.14 Category Products-Cable Metal disassembled Parts

FTTH drop cable/ADSS cable install hardware parts

							
DJ-1 607-B		DJ -1608		D J-1609		D J-1610	
							
DJ-1611		DJ -1612		D J-1613		D J-1614	
							
DJ-1 600D		Pole Hardware Galvanized Steel Band Hook for ADSS		SOPO RTE-DROP.		CLAMP-DROP CL	
							
FTTH-DROP CLAMP3		WEDGE-DROP CLAMP1		S Type Optical Cable on Tension Clamp		Aluminium Suspension For ADSS	
							
HC-10-15 Suspension clamp		UPB Universal Pole Bracket		Down-Lead Clamp for overhead		Down-Lead Clamp	
							
ADSS single spiral vibration dampers		ADSS slack Cable Storage Bracket		ADSS slack Cable Storage Bracket		Optical cable pull	

							
FLEJE-1/2",3/4",1/4",1/1"	Hebilla-1/2",3/4",1/4",1/1"			Preformed full tension guy grip		Stainless Steel lock	

■ Fiber to the home FTTH installation accessories expert



■ Fiber to the home FTTH installation accessories expert



RETRACTOR CLASS



ANCHOR CLAMP CLASS













2.15 Category Products-Fusion splicer

No.	model	description	Picture
1	AI-6C (6 motors)	<ol style="list-style-type: none"> 1. 8 seconds fast splicing 2. 18 seconds fast heating comes with 5200mAh capacity battery 3. mainly for security monitoring, FTTH into the home, as well as about 10KM line construction 	
1	AI-7C (6 motors)	<ol style="list-style-type: none"> 1. 8 seconds fast splicing .18 seconds fast heating comes with 7800mAh large capacity battery continuous splicing and heating time about 200times competent for security monitoring, FTTH to the home, and trunking needs of around 20 kilometers 2. 3. 4.c 5.c 	
2	AI-8C (6 motors)	<ol style="list-style-type: none"> 1. 6 seconds fast splicing 2. .15 seconds fast heating 3. comes with 7800mAh large capacity battery 4. continuous splicing and heating time about 200times 5.use for around 50 kilometers of trunk line 	
3	AI-7V (6 motors)	<ol style="list-style-type: none"> 1. 6 seconds fast splicing 2. .15 seconds fast heating 3. comes with 7800mAh large capacity battery 4.continuous splicing and heating time about 240times 	
4	AI-9 (6 motors)	<ol style="list-style-type: none"> 1. 5 seconds fast splicing 2.15 seconds fast heating 3. comes with 7800mAh large capacity battery 4. continuous splicing and heating time about 200times 5.Use for nearly 100KM of trunk lines, with optical power meter and VFL function 	
5	AI-10A (6 motors)	<ol style="list-style-type: none"> 1.6 seconds fast splicing 2.15 seconds fast heating 3. comes with 7800mAh large capacity battery 4. continuous splicing and heating time about 200times 5.built-in OPM/VFL/ELECTRIC 8 IN 1 PRECISION CLEAVER 	
6	EX39 (4 motors)	<ol style="list-style-type: none"> 1.8 seconds fast splicing 2.18 seconds fast heating 3.Mainly applicable to the splicing attenuation index community and road monitoring and other occasions requirements are not high fiber to the home, 	
7	FX39 (6 motors)	<ol style="list-style-type: none"> 1.6s fast splicing 2.16s fast heating 3.comes with 7800mAh large capacity battery requirements of high long-distance backbone 	





4. Mainly applicable to the fusion welding attenuation ind cable, submarine cable construction and other occasions

2.16 Category Products-OTDR



Model	desription	Pic.	Model	desription	Picture
OTDR AOR500-S	Dynamic Range:(24dB/22dB) Wavelength:1310nm/1550nm Max distance :60KM English Version		NK3200D series (3.5 inch)	OTDR, mini 3.5-inch dual-wavelength full-function 1310/1550, dynamic range 24/22dB	
OTDR AOR500-A	Dynamic Range:(28dB/26dB) Wavelength:1310nm/1550nm Max distance :80KM English Version		NK4000 series (4.3 inch)	Standard configuration:Auto OTDR,Expert OTDR,Event Map; OPM,LS, VFL, RJ45 Cable Tracking(Including CablRJ45 Cable Sequence,RJ45 Cable Length, End Face Detection (Optional), Flashlight,OpticalLoss Test	
OTDR AOR500-B	Dynamic Range:(32dB/30dB) Wavelength:1310nm/1550nm Max distance :100KM English Version		NK5600 series (5.6 inch)	OTDR+VFL+OPM+LS+event map+optical loss test+end face detection 5.6 inch small dynamic 32dB, wavelength 1310/1550nm, dynamic range 32/30dB	
OTDR AOR500-C	Dynamic Range:(36dB/34dB) Wavelength:1310nm/1550nm Max distance :120KM English Version		NK6000 series (5.6 inch)	OTDR+VFL+OPM+LS+event map+optical loss test+end face detection; Multilingual	
OTDR AOR500-PB	Dynamic Range:(34dB/36dB/34dB) Wavelength:1550nm /1310nm/1625nm Max distance :120KM English Version		NK6800 series (7 inch)	OTDR+VFL+OPM+LS+event map+optical loss test+end face detection	















<p>OPM-BOU350T</p>	<p>Portable design, measurement range of -70dBm ~ +6 dBm (-50dBm ~ +26dBm) two ranges to choose from, 850nm, 1300nm, 1310nm, 1490nm, 1550nm, 1625nm six wavelengths testing, FC adapter, optional SC, ST, LC fiber optic adapter</p>		<p>OPM NK200</p>	<p>The measurement range of optical power meter module has -70dBm~+6 dBm two ranges to choose from, 850nm, 980nm, 1300nm, 1310nm, 1490nm, 1550nm, 1625nm, 1650nm eight wavelengths test</p>	
<p>Optical Talk Set Optical Talk Set</p>	<p>High-quality, low-noise full-duplex communication mode, large dynamic range: > 45dB, large dynamic range: > 120km, wavelength range A: 1310nm, B: 1550nm</p>		<p>OPM NK300</p>	<p>The measurement range of optical power meter module has -70dBm~+6 dBm two ranges to choose from, 850nm, 980nm, 1300nm, 1310nm, 1490nm, 1550nm, 1625nm, 1650nm eight wavelengths test</p>	

model	picture	model	picture	model	picture
<p>FTTH tool kit#1 fiber optic FTTH tool kit standard package</p>		<p>Miller stripper</p>		<p>Wire stripping pliers</p>	
<p>FTTH tool kit#2 fiber optic FTTH tool kit standard package</p>		<p>Optical Cable Construction Toolbox #2</p>		<p>Optical Cable Construction Toolbox #1</p>	
<p>Fiber optical power meter OPM-9 wavelength:850-1625nm, Test accuracy: +/-0.2dB, Test Range : -70~+10dB</p>		<p>SI-01 Longitudinal fiber optical coaxial Cable jacket Stripper 208*88*36 mm Cables diameter of 10~25mm can be stripped</p>		<p>optic fiber cleaver cutter FC-6S</p>	
<p>Fiber Tool Heavy Duty Tube Cutter STANLEY 93-021 (range 3-31mm)</p>		<p>Transverse Longitudinal cable stripper cutter It can do one-off strip for the fiber cable Ø8-Ø30mm.</p>		<p>HW-315 Rotary cable stripper slits and strips round cable from 0.18" up to 1.0" in diameter</p>	
<p>Optical Connector Cassette Cleaning Tool KCC-550 * for all type connectors includes FC,SC,ST,LC and MU *</p>		<p>Pentype Fiber Connector Cleaner KOC-250 One-Click Cleaner for SC, ST, FC 2.5mm ferrules</p>		<p>Pentype Fiber Connector Cleaner KOC-125 One-Click Cleaner for LC, MU 1.25mm ferrules</p>	
<p>Steel tie fasten tools use for steel ties width under 8mm, thickness under 0.3mm</p>		<p>Live Fiber Identifier (three options) 1.AFI 400 , without VFL 2. AFI420S, with Visual Fault Locator 1mW 3. AFI420L, with Visual Fault Locator 10mW</p>		<p>KIM. AIRLAID-PAPER KIMWIPES 11X21CM 280-PANOS ANTIESTATICOS P/FIBRA OPTICA LINTGUARD LIMP</p>	

<p>KCS. kevlar scissor</p> <p>RUBICON Tijera Corta Kevlar Acero</p> <p>Inoxidable 140mm</p>		<p>CT-274. PEEL</p> <p>CORTADOR DE TUBO 3-28MM</p> <p>1/8 - 1 1/8 COBRE ACERO</p> <p>ALUMINIO</p>		<p>VFL 10mW 650nm Detector Visual</p> <p>Fallas Fibra 8-10km req-pilas/2-AA</p> <p>(optional :1mW/10mW/20mW/30mW)</p>	
<p>three layer folding tool box 17"</p> <p>Bottom Size:395*170mm, middle part:420*200mm, height : 175mm</p>		<p>three layer folding tool box 21"</p> <p>Bottom Size:450*225mm, middle part:485*255mm, height : 215mm</p>		<p>OTDR launch cable Length customized:150M 300M 500M 1000M</p> <p>2000M extended line connector options:MU. E2000SC /FC/LC/ST</p>	
<p>Miller MSAT-5 Fiber Optic Drop</p> <p>Cable Slitter</p>		<p>Fiberglass Duct Rodder</p> <p>DR70100 7mm 100m</p> <p>DR90150 9mm 150m</p> <p>DR110200 11mm 200m/300m</p>		<p>LAUCHA-50E STRINGING-GUN-50</p> <p>50MT ELECTRICA CINTA DE ACERO PASACABLES LAUCHA</p> <p>ELECTRICA ALAMBRE</p>	

2.18 Category Products-STB box/TV box







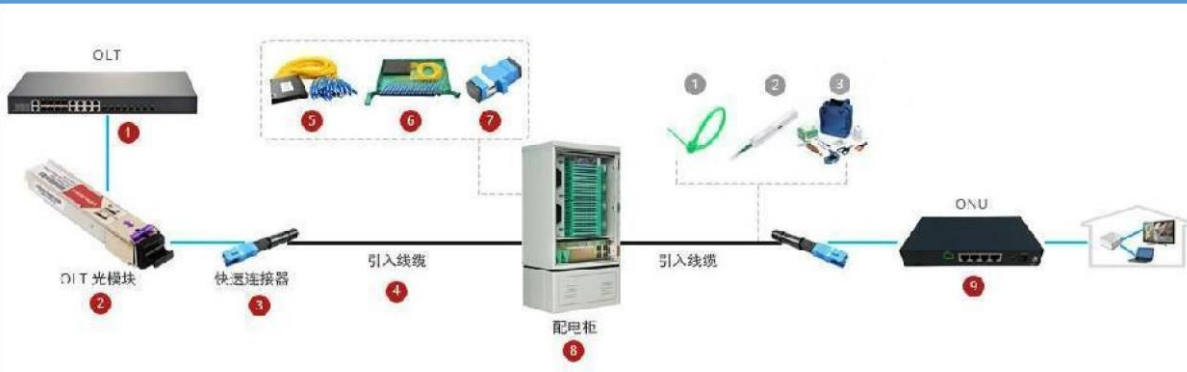









Model	OS Version	CPU	WIFI	RAM	ROM	picture
X96mini 5G	Android 9.0	Amlogic S905W4 Quad Core ARM Cortex A53	Amlogic W1: 2.4G& 5G IEEE 802.11 b / g / n / ac 100M LAN	1GB	8GB	
				2GB	16GB	
X96Q Pro	Android 10.0	Allwinner H313 Quad Core ARM Cortex A53	SSV6256P: 2.4G& 5G IEEE 802.11 a/b/g/n 100M LAN	1GB	8GB	
				2GB	16GB	
X96Mini+	Android 9.0	Amlogic S905W4 Quad Core ARM Cortex A53	Amlogic W1: 2.4G & 5G 802.11 ac 100M LAN	1GB	8GB	
				2GB	16GB	
X96S400	Android 10.0	Allwinner H313 Quad Core ARM Cortex A53	wifi 802.11 b/g/n 2.4G.	1GB	8GB	
				2GB	16GB	
X96Mate	Android 10.0	Allwinner H616 Quad Core ARM Cortex A53	wifi 2.4G 5.8G BT4.2 802.11.AC100M LAN	4GB	32GB	
				4GB	64GB	
X96QMAX	Android 10.0	Allwinner H616 Quad Core ARM Cortex A53	wifi 2.4G 5.8G BT4.2 802.11.AC 1000M LAN	4GB	32GB	
				4GB	64GB	
X96Q	Android 10.0	Allwinner H313 Quad Core ARM Cortex A53	wifi IEEE 802.11 b/g/n 2.4G 100M LAN	1GB	8GB	
				2GB	16GB	
X96 Air	Android 9.0	Amlogic S905X3 64-bit quad core ARM® Cortex™ A55	wifi IEEE 802.11 b/g/n 2.4G 100M LAN wifi 2.4G 5.8G BT4.2 802.11.AC 2T2R MIMO 1000M LAN	2GB	16GB	
				4GB	32GB	
X96MAX+	Android 9.0	Amlogic S905X3 64-bit quad core ARM® Cortex™ A55	wifi IEEE 802.11 b/g/n 2.4G 100M LAN wifi 2.4G 5.8G BT4.2 802.11.AC 2T2R MIMO 1000M LAN	2GB	16GB	
				4GB	32GB	
X96S	Android 9.0	Amlogic S905Y2 Quad Core ARM Cortex A53	wifi 2.4G WiFi LPDDR 4 wifi 2.4G 5.8G BT4.0 AP6255 LPDDR	2GB	16GB	
				4GB	32GB	

X96mini	Android 7.1.2/9.0	Amlogic S905W Quad Core ARM Cortex A53	wifi IEEE 802.11 b/g/n 2.4G 100M LAN	1GB	8GB	
				2GB	16GB	
hako mini Y2	Android 9.0	Amlogic S905Y2 Quad Core ARM A53 @1.5GHz	IEEE 802.11 b/g/n/ac, 2.4G/5G dual wifi 10/100/1000Mbps Google certified	2GB	8GB	
hako mini Y4	Android™ 11	Amlogic S905Y4 ARM Quad 64-bit Cortex-A35	2 x 2 MIMO Wi-Fi 2.4GHz/5GHz 802.11a/b/g/n/ac RJ45 Interface 10M/100M adaptive Google certified	2GB	8GB	
				2GB	16GB	
				4GB	32GB	

2.19 Category Products-Optical accessories



FTTH optic accessories

Fast connector SC/APC	Fast connector SC/UPC	Fast connector SC/APC high quality	Fast connector SC/UPC high quality
			
Optic adapter SC/APC	Optic adapter SC/APC	Optic adapter SC MM	Optic adapter LC/APC
			
Optic adapter LC OM3	Optic adapter LC SM	Optic adapter FC SM	Optic adapter FC SM
			
Fast connector SC/UPC	Fast connector SC/APC	Fusion Splice-On Fiber Fast Connector SC/UPC	Fusion Splice-On Fiber Fast Connector SC/APC
			



			
optical splice protection tube	Self-locking nylon tie	RJ 45 connector	optical fiber fusion box
			
Online Variable Optical Attenuator LC/UPC-SM-SX-online Attenuator 0-60dB	Online Variable Optical Attenuator SC/UPC-SM-SX-online Attenuator 0-60dB	Online Variable Optical Attenuator FC/UPC-SM-SX-online Attenuator 0-60dB	Online Variable Optical Attenuator FC/UPC-SM-SX-online Attenuator 0-60dB
			

2.20 Category Products-Digital Headend Product(Encoder Modulator)

No.	desc	
1	 <p>4 HDMI to 4 ATSC Encoder Modulator</p> <ul style="list-style-type: none"> MPEG HD/MPEG4 H.264 video encoding Up to 1920x1080@50/60P supported (MPEG4 H.264) Up to 1920x1080@50/60P supported (MPEG2 H.264) 4x HD audio, 19.2KHz Simultaneously encoding each channel more than 10Mbps 4x ATSC 1.0 over 1x coaxial combined outputs Support 10/100/1000Mbps Excellent modulation quality 64QAM/256QAM RF Frequency range 30.4MHz-93.7MHz LC/SC/FC easy control and hardware Web NMS management, updates via web Lowest cost per channel — breakthrough price 	 <p>Multi-Channel Encoder</p> <ul style="list-style-type: none"> Video Encoding: H.264, H.264, H.264, H.264, H.264 Audio Encoding: MPEG-Layer 2, LC AAC, HE AAC V2, AC3 Passthrough Ultra Low Bit Rate: Save 75% Bandwidth Enhance Picture Quality: Advanced Compressing Algorithm Advanced Pre-treatment: Deinterlacing, Noise Reduction, Sharpening QoS (L2/L3/QoS) Protection: Coaxial as per order
2	 <p>32 in 1 IP to Analog Modulator</p> <ul style="list-style-type: none"> 1U chassis, high density to save shipping cost Support QoS, Logs and Caption Insertion for each channel, easy operate Support LC/SC/FC/ATSC Support H.264 for encoding Support program info modify, multiple audio select 2 GE ports (max 4x IP input over NPTV/SP/TS, Max 540Mbps for each GE input) Support H.264/H.265, H.264/H.265, H.264/H.265, H.264/H.265 Processing of up to 32 IP multichannel groups of a 16 port Ethernet NPTV/SP/TS info up to 32 standard 30s or NTSC or SECAM TV programs 32 channels with 16 channels camera output within 400Mbps Support Web-based Network management 	 <p>IP Multiplexer</p> <ul style="list-style-type: none"> Any input max 4x 4K input (up to 10.8K resolution 4K mode) Any direction can be output as input or output manually IP input: SD/HD IP over UDP/TCP (20/40/80/160/320/640/1280/2560/5120/10240/20480/40960/81920/163840/327680/655360/1310720/2621440/5242880/10485760/20971520/41943040/83886080/167772160/335544320/671088640/1342177280/2684354560/5368709120/10737418240/21474836480/42949672960/85899345920/171798691840/343597383680/687194767360/1374389534720/2748779069440/5497558138880/10995116277760/21990232555520/43980465111040/87960930222080/175921860444160/351843720888320/703687441776640/1407374883553280/2814749767106560/5629499534213120/11258999068426240/22517998136852480/45035996273704960/90071992547409920/180143985094819840/360287970189639680/720575940379279360/1441151880758558720/2882303761517117440/5764607523034234880/11529215046068469760/23058430092136939520/46116860184273879040/92233720368547758080/184467440737195516160/368934881474391032320/737869762948782064640/1475739525897564129280/2951479051795128258560/5902958103590256517120/11805916207180512354240/23611832414361024708480/47223664828722049416960/94447329657444098833920/188894659314888197667840/377789318629776395335680/755578637259552790671360/1511157274519105581342720/3022314549038211162685440/6044629098076422325370880/12089258196152844550751360/24178516392305689101502720/48357032784611378203004480/96714065569222756406008960/193428131138445512812017920/386856262276891025644035840/773712524553782051288071680/154742504910756402257743360/309485009821512804515486720/61897001964302560903093440/123794003928605121806186880/24758800785721024361233760/49517601571442048722467520/99035203142884097444935040/198070406285768194889870080/39614081257153638977940160/79228162514307277955888320/158456325028614555917776640/316912650057229111835553280/633825300114458223671106560/1267650600228916447342213120/253530120045783289468426240/507060240091566578937652480/101412048018313315791524960/2028240960366266315830449920/4056481920732532631660899840/8112963840146505263321799680/1622592768033010526664399360/3245185536066021053328798720/6490371072013042106665597440/129807421440260841333311953280/259614842880521682666631066560/519229685760104336333322133120/1038459371520208672666644266240/2076918743040417345333288532480/4153837486080834690666770664960/8307674972160166933335413319680/16615349944320333866668826639360/33230699888640667733337653266678720/66461399777280133546667506533356480/132922799554560267093335013066671111040/26584559910912053418666700263332222080/531691198218240106833334005266644444160/1063382396436480213666670010533368888320/212676479287296042733334002106668888640/425352958574592085466670004213337777280/85070591714918401709333400084266688885760/170141183429836803418666700016853337777153280/34028236685967360683733340003370666888830720/680564733719347201367466670006741333777761440/13611294674386944027349333400134826668888122880/27222589348733888054698667000269653337777245760/5444517869746777610939733400539306668888491520/1088903573953355520218794667001078613337777983040/217780714790671104437993340021572266688881966080/435561429581342208875986670004344533377773932160/871122859162684417751993340008689066688887864320/174224571825368883513986670017378133377775728640/34844914365073776702799334003475626668888155169280/6968982873014755340559866700069513337777310337280/13937965746029506881111199334001390266688883007040/278759314920590137622223986670002780533377776014080/557518629841180275244447986670005561066688886028160/11150372596823605504888998667001112213337777202560/22300745193647211009777998667000224446668888405120/44601490387294422019555998667000448893337777810240/892029807745888440391119986670008977866688881620480/1784059615491776880782239986670017955733377773240960/3568119230983553761564479986670035911066688886481920/71362384619671075231289986670071822133377776483840/142724769293342150462579986670143644666888812967680/28544953858668430092515998667028729333777725935360/570899077173368601850319986670574586668888518711040/11417981543467372037007998667114913337777103422080/22835963086934744074015998667229826668888206844160/4567192617386948814803199866745965333777741368960/9134385234773897629607998667919306668888827271680/1826877046954779551921599866783861333777782727040/365375409390955910332399866767722666888855544320/730750818781911806646799866735445333777711088640/146150163756382361333399866770890666888822177280/29230032751276472266679986674178133377772235520/5846006550255294453339986678356266688884471040/11692013100510588866679986676712533377774428160/233840262010211773333998667342506668888889440/4676805240204235466679986676850133377778858880/93536104804084709333998667370026668888817717760/18707220960816941866679986677400533377773535520/3741444192163388373339986674801066688887071040/74828883843267767466679986679602133377777071040/14965776768535534933399866792042666888814142080/299315535370710688666799866784085333777728285440/5986310707414217733399866768170666888828571040/11972621414828434666799866736340666888857142080/239452428296568693339986677268133377771142080/4789048565931373866679986674536266688882285440/957809713186274773339986679072533377772285440/1915619426372549466679986678145066688884571040/383123885274509893339986676290133377779142080/7662477705490197866679986672580266688888285440/15324954410980395333998667516053337777571040/3064990882196079066679986671032133377771142080/612998176439215813339986672064266688882285440/12259963528783116266679986674128533377772285440/245199270575662325333998667825666688884571040/4903985411513246533399866765133377779142080/980797082302649306667998667302666688888285440/19615941646052986133399866760533377774571040/3923188329210597226667998667121066688888571040/784637665842119445333998667242133377771142080/15692753316843889333998667484266688882285440/313855066336877786667998667968533377772285440/6277101326737557333998667937066688884571040/125542026346751146667998667874133377779142080/25108405269350229333998667748266688888285440/502168105387004586667998667496533377774571040/10043362107740091333998667993066688888571040/200867242154801826667998667986133377779142080/40173448430960365333998667972266688888285440/803468968619207306667998667944533377774571040/16069379372384141333998667919066688888571040/321387587447682826667998667838133377779142080/64277517489536565333998667676266688888285440/1285550349790731306667998667352533377774571040/257110069958146261333998667705066688888571040/514220139916292526667998667410133377779142080/102844027832578505333998667820266688888285440/2056880556651570106667998667640533377774571040/411376111330314021333998667281066688888571040/8227522226606280426667998667162133377779142080/164550444521225605333998667324266688888285440/3291008890424512106667998667648533377774571040/658201778084902421333998667297066688888571040/1316403556169804826667998667494133377779142080/263280711233960965333998667988266688888285440/5265614224679219306667998667976533377774571040/105312284493584381333998667953066688888571040/2106245689871687626667998667906133377779142080/421249137974337525333998667812266688888285440/8424982759486750506667998667624533377774571040/1684996511897350101333998667249066688888571040/33699930237947002026667998667498133377779142080/6739986047589400405333998667996266688888285440/13479972095178008106667998667992533377774571040/2695994419035601621333998667985066688888571040/53919888380712032426667998667970133377779142080/1078397767614406485333998667940266688888285440/2156795535228812906667998667880533377774571040/431359107045762581333998667761066688888571040/8627182140915251626667998667522133377779142080/172543642818305125333998667044266688888285440/3450872856366102506667998667088533377774571040/690174571273220501333998667177066688888571040/13803491425464410026667998667354133377779142080/2760698285092882005333998667708266688888285440/55213965701857640106667998667416533377774571040/11042793140371528021333998667833066688888571040/220855862807430560426667998667666133377779142080/44171172561486112085333998667332266688888285440/88342345122972224106667998667664533377774571040/1766846902459444821333998667329066688888571040/35336938049188896426667998667648133377779142080/7067387609837779285333998667296266688888285440/14134775219675558566667998667592533377774571040/2826955043935111713339986671185066688888571040/5653910087870223426667998667237066688888285440/113078201757404485333998667474133377779142080/226156403514808966667998667948266688888285440/4523128070296179306667998667896533377774571040/904625614059235861333998667793066688888571040/18092512281184717226667998667586133377779142080/3618502456236943453339986671172266688888285440/7237004912473886906667998667234533377774571040/1447400982494777381333998667469066688888571040/28948019649895547626667998667938133377779142080/57896039299791095333998667876266688888285440/1157920785995821906667998667752533377774571040/231584157199164381333998667505066688888571040/4631683143983287626667998667010133377779142080/926336628796657525333998667020266688888285440/185267325759331506667998667040533377774571040/37053465151866301333998667080266688888571040/741069303037326026667998667160533377779142080/14821386060746525333998667321066688888285440/296427721214930506667998667642133377774571040/592855442429861013339986671284266688888571040/11857108848597220266679986672568533377779142080/2371421769719444053339986675137066688888285440/47428435394388881066679986670274133377774571040/9485687078877776213339986670548266688888571040/18971374157755552426667998667109966688888285440/37942748315511105333998667219933377774571040/758854966310222106667998667439866688888571040/15177099326044442133399866787966688888285440/303541986520888842666799866775933377774571040/60708397304177768533399866751866688888571040/121416794608355536666799866703733377779142080/2428335892167110733399866707466688888285440/48566717843342214666799866714933377774571040/9713343568668442933399866729866688888571040/19426687337336885666799866759733377779142080/38853374674673771333998667119466688888285440/777067493493475426667998667238933377774571040/155413498698695085333998667477866688888571040/310826997397390170666799866795566688888285440/62165399479478034133399866791133377774571040/1243307989589560682666799866782266688888571040/24866159791791213666799866764533377779142080/4973231958358242733399866729066688888285440/99464639167164854666799866758133377774571040/198929278334329709333998667116266688888571040/3978585566686594186667998667232533377779142080/795717113337318836667998667465066688888285440/159143422667737

2.22 Category Products-Mini UPS Power

Model	Picture		Model	Picture
UPS502B 5V/2A Capacity:12000mah(6*2000mah) 29.6WH ~ 57.72WH Unit Size: 111*60*43mm 400g			UPS1203A 12V/3A Capacity:12000mah 6*2000mah)44.4WH 44.4WH ~ 57.7WH Unit Size: 162*73*29mm 355g	
UPS502A 5V/2A Capacity:4000mAh(2*2000mah) Unit Size: 111*60*26mm 187g			UPS1203A 12V/3A Capacity:15600mAh(6*2600mah) 57.72WH 44.4WH ~ 57.7WH Unit Size: 162*73*29mm 415g	
UPS901A 9V/1A Capacity:4000mAh(2*2000mah) Unit Size: 111*60*26mm 188g			P18/8000 100~240V/1A  Capacity:8000mAh(4*2000mah)29.6WH 8000MAH-15600MAH Unit Size: 155*120*35.5mm	

FTTH Solution (CATV+Internet+Voice+Broadcast)

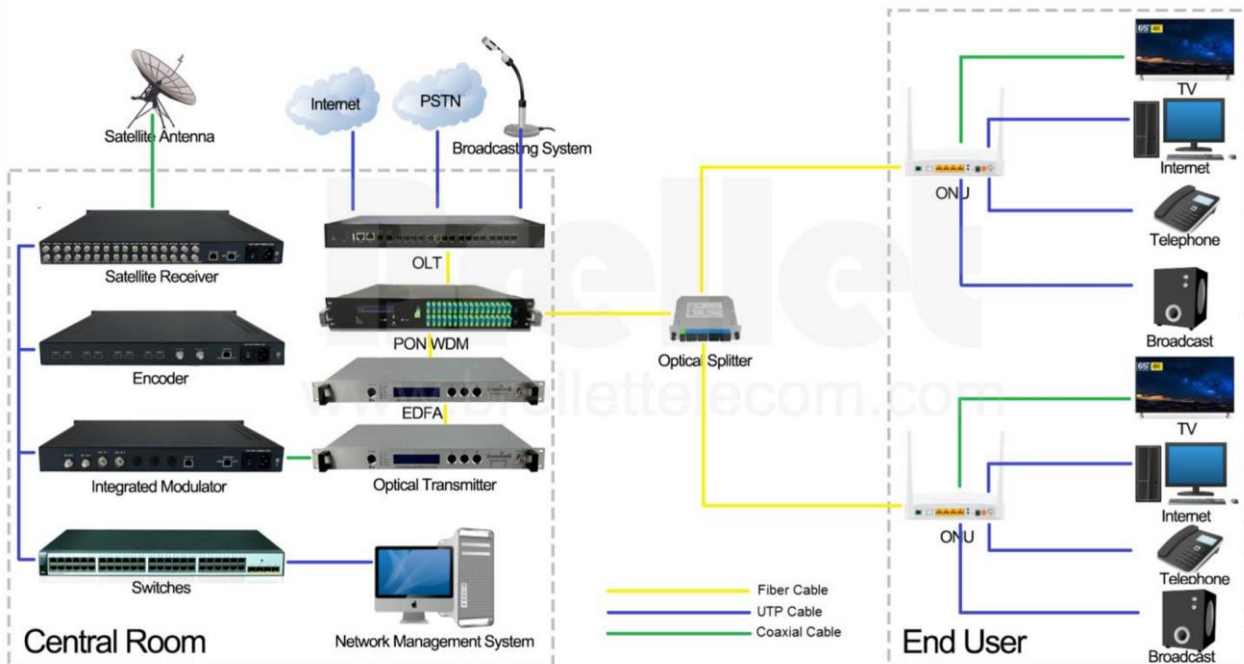

<p>UPS1201A </p> <p>12V/1A</p> <p>Capacity:4000mAh(2*2000mah)</p> <p>14.8WH ~ 22.2WH</p> <p>Unit Size: 111*60*26mm 188g</p>		<p>P18/8800</p> <p>100~240V/1A</p> <p>Capacity:8800mAh(4*2200mah)32.56WH</p> <p>8000MAH-15600MAH</p> <p>Unit Size: 155*120*35.5mm</p>	
<p>UPS1202A</p> <p>12V/2A</p> <p>Capacity:6000mAh(3*2000mah)</p> <p>14.8WH ~ 22.2WH</p> <p>111*60*26mm 235g</p>		<p>P18/12000 </p> <p>100~240V/1A</p> <p>Capacity:12000mah</p> <p>(6*2000mah) 44.4WH</p> <p>8000MAH-15600MAH</p> <p>Unit Size: 155*120*35.5mm</p>	
<p>UPS1202B</p> <p>12V/2A</p> <p>Capacity12000mah (6*2000mah)</p> <p>29.6WH ~57.72WH</p> <p>111*60*43mm 400g</p>		<p>P18/15600</p> <p>100~240V/1A</p> <p>Capacity:15600mah (6*2600mah)57.72WH</p> <p>8000MAH-15600MAH</p> <p>Unit Size: 155*120*35.5mm</p>	

More other models can be offered by: Alice +86 18588767425 alice@qftth.com