



Commercial  
Refrigeration

**FED-X SERIES PROFESSIONAL**



Hassan Rahman  
**Business Consultant/Advisor**

**M:** 0430 939393

**W:** [www.alphaexcahnge.com.au](http://www.alphaexcahnge.com.au)

**E:** [admin@alphaexcahnge.com.au](mailto:admin@alphaexcahnge.com.au)

## SPLIT DOOR UPRIGHT CABINETS

### Features

- ★ Stainless steel interior and exterior with rounded corners for easy cleaning
- ★ Auto defrost
- ★ Three levels of shelving plus base
- ★ Self-closing lockable doors with heavy duty magnetic door seals
- ★ HFCs and CFCs free foam body insulation
- ★ Tropicalised for Australian conditions
- ★ User friendly Digital controls and internal lighting
- ★ Split door design for rapid recovery and energy saving
- ★ Integrated door handle for easy cleaning
- ★ Shelf and shelf support are designed to accommodate 2 x 1/1 GN pan
- ★ Heavy duty evaporator and condenser fans
- ★ Heavy duty castors with front wheel brakes
- ★ **1/2 Split door system can lower yearly running cost by up to 30%**



XURF600S1V



XURF1200S2V

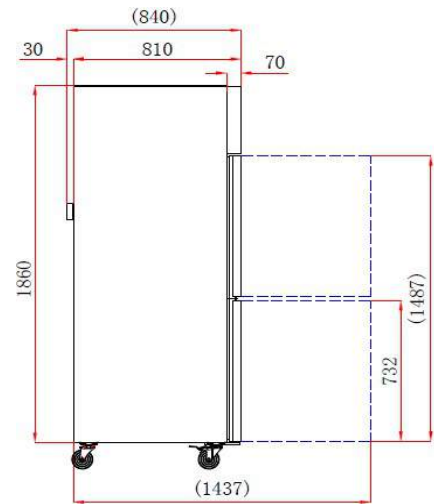
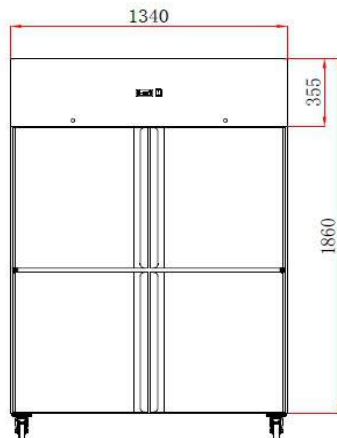
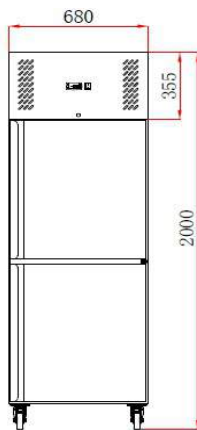

Model	XURC600S1V	XURC1200S2V	XURF600S1V	XURF1200S2V
Dimension(W*D*H /mm)	680*810*2000	1340*810*2000	680*810*2000	1340*810*2000
Net Capacity(L)	600	1200	600	1200
Cooling System	Fan forced cooling	Fan forced cooling	Fan forced cooling	Fan forced cooling
Type	Fridge	Fridge	Freezer	Freezer
Temperature(°C)	-2~+8	-2~+8	-18~-22	-18~-22
Compressor	Cubigel	Cubigel	Cubigel	Cubigel
Controller	Dixell	Dixell	Dixell	Dixell
Refrigerant	R290	R290	R290	R290
Ambient Temp(°C)/ RH %	43/40	43/40	43/40	43/40
Voltage(V)/Frequency(Hz)/Amps(A)	240 / 50 / 10	240 / 50 / 10	240 / 50 / 10	240 / 50 / 10
Power(W)	210	430	465	730
Weight(Kg)	110	167	117	177
Price ex gst	\$2,790.00	\$3,590.00	\$2,990.00	\$3,990.00

## SPLIT DOOR UPRIGHT CABINETS

### Features

- ★ Stainless steel interior and exterior with rounded corners for easy cleaning
- ★ Auto defrost
- ★ Three levels of 2/1 gastronorm compatible shelves
- ★ Self-closing lockable doors with heavy duty magnetic door seals
- ★ 60mm HFCs and CFCs free foam body insulation
- ★ Tropicalised for Australian conditions
- ★ User friendly Digital controls and internal lighting
- ★ Split door design for rapid recovery and energy saving
- ★ Integrated door handle for easy cleaning
- ★ Shelf and shelf support are designed to accommodate 2 x 1/1 GN pan
- ★ Ebm-papst evaporator and condenser fans
- ★ Heavy duty castors with front wheel brakes
- ★ **1/2 Split door system can lower yearly running cost by up to 30%**



XURF650S1V



XURF1410S2V

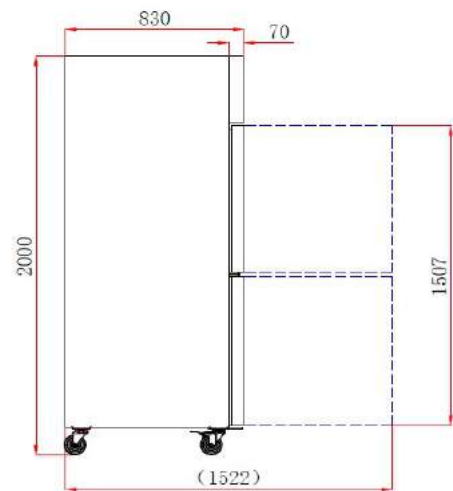
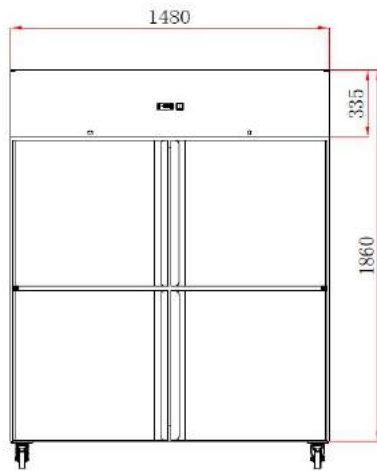
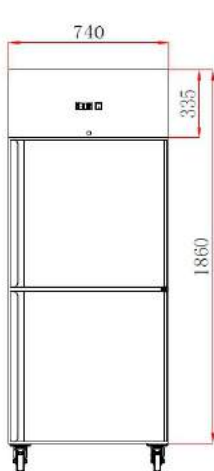

Model	XURC650S1V	XURC1410S2V	XURF650S1V	XURF1410S2V
Dimension(W*D*H /mm)	740*830*2000	1480*830*2000	740*830*2000	1480*830*2000
Net Capacity(L)	650	1410	650	1410
Cooling System	Fan forced cooling	Fan forced cooling	Fan forced cooling	Fan forced cooling
Type	Fridge	Fridge	Freezer	Freezer
Temperature(°C)	-2~+8	-2~+8	-18~-22	-18~-22
Compressor	Embraco/Secop	Embraco/Secop	Embraco/Secop	Embraco/Secop
Controller	Dixell	Dixell	Dixell	Dixell
Ambient Temp(°C)/ RH %	43/40	43/40	43/40	43/40
Voltage(V)/Frequency(Hz)/Amps(A)	240 / 50 / 10	240 / 50 / 10	240 / 50 / 10	240 / 50 / 10
Power(W)	310	500	640	830
Weight(Kg)	121	188	126	201
Price ex gst	\$2,990.00	\$3,990.00	\$3,290.00	\$4,590.00

## SINGLE FULL DOOR UPRIGHT CABINETS

### Features

- ★ Stainless steel interior and exterior with rounded corners for easy cleaning
- ★ Auto defrost
- ★ Three levels of shelving plus base
- ★ Self-closing lockable doors with heavy duty magnetic door seals
- ★ HFCs and CFCs free foam body insulation
- ★ Tropicalised for Australian conditions
- ★ User friendly Digital controls and internal lighting
- ★ Integrated door handle for easy cleaning
- ★ Heavy duty evaporator and condenser fans
- ★ Heavy duty castors with front wheel brakes



XURC400SFV



XURC600SFV

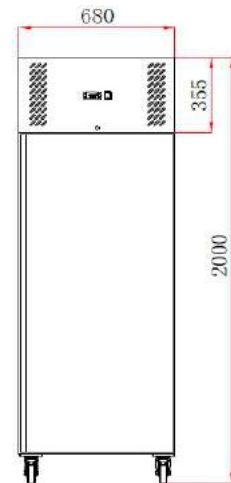
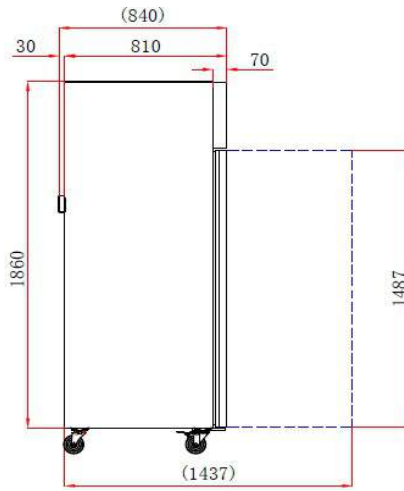
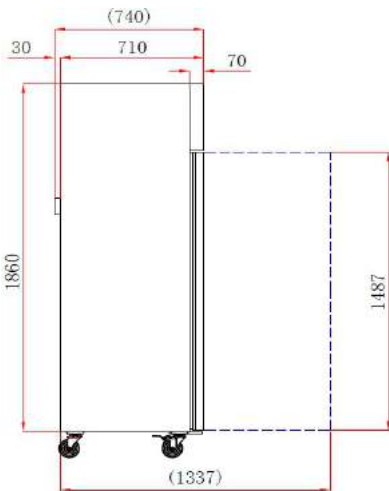

Model	XURC400SFV	XURF400SFV	XURC600SFV	XURF600SFV
Dimension(W*D*H /mm)	680*710*2000	680*710*2000	680*810*2000	680*810*2000
Net Capacity(L)	429	429	600	600
Cooling System	Fan forced cooling	Fan forced cooling	Fan forced cooling	Fan forced cooling
Type	Fridge	Freezer	Fridge	Freezer
Temperature(°C)	-2~+8	-18~-22	-2~+8	-18~-22
Compressor	Cubigel	Cubigel	Cubigel	Cubigel
Controller	Dixell	Dixell	Dixell	Dixell
Refrigerant	R290	R290	R290	R290
Ambient Temp(°C)/ RH %	43/40	43/40	43/40	43/40
Voltage(V)/Frequency(Hz)/Amps(A)	240 / 50 / 10	240 / 50 / 10	240 / 50 / 10	240 / 50 / 10
Power(W)	195	450	210	465
Weight(Kg)	102	111	110	117
Price ex gst	\$2,290.00	\$2,690.00	\$2,790.00	\$2,990.00

## FULL DOOR UPRIGHT CABINETS

### Features

- ★ Stainless steel interior and exterior with rounded corners for easy cleaning
- ★ Auto defrost
- ★ Three levels of shelving plus base
- ★ Self-closing lockable doors with heavy duty magnetic door seals
- ★ HFCs and CFCs free foam body insulation
- ★ Tropicalised for Australian conditions
- ★ User friendly Digital controls and internal lighting
- ★ Integrated door handle for easy cleaning
- ★ Heavy duty evaporator and condenser fans
- ★ Heavy duty castors with front wheel brakes



XURC650SFV

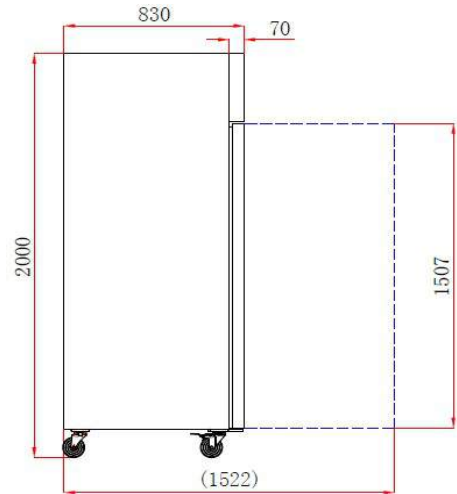
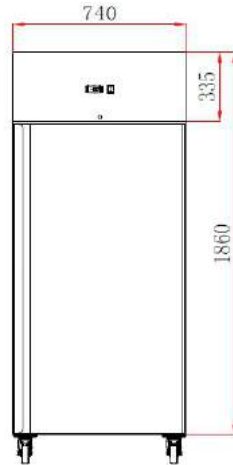

XURC1200SFV

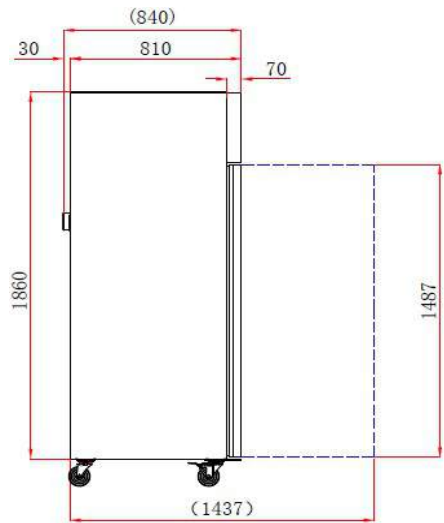
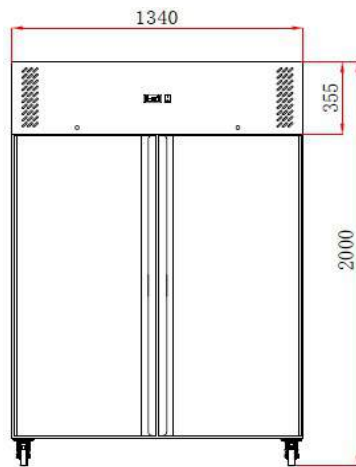

Model	XURC650SFV	XURF650SFV	XURC1200SFV	XURF1200SFV
Dimension(W*D*H /mm)	740*830*2000	740*830*2000	1340*810*2000	1340*810*2000
Net Capacity(L)	650	650	1200	1200
Cooling System	Fan forced cooling	Fan forced cooling	Fan forced cooling	Fan forced cooling
Type	Fridge	Freezer	Fridge	Freezer
Temperature(°C)	-2~+8	-18~-22	-2~+8	-18~-22
Compressor	Embraco/Secop	Embraco/Secop	Cubigel	Cubigel
Controller	Dixell	Dixell	Dixell	Dixell
Refrigerant	R290	R290	R290	R290
Ambient Temp(°C)/ RH %	43/40	43/40	43/40	43/40
Voltage(V)/Frequency(Hz)/Amps(A)	240 / 50 / 10	240 / 50 / 10	240 / 50 / 10	240 / 50 / 10
Power(W)	310	640	430	730
Weight(Kg)	121	126	167	177
Price ex gst	\$2,990.00	\$3,290.00	\$3,590.00	\$3,990.00

## FULL GLASS DOOR UPRIGHT CABINETS

### Features

- ★ Stainless steel interior and exterior with rounded corners for easy cleaning
- ★ Auto defrost
- ★ Three levels of shelving plus base
- ★ Self-closing lockable doors with heavy duty magnetic door seals
- ★ Internal LED lighting
- ★ HFCs and CFCs free foam body insulation
- ★ User friendly Digital controls and internal lighting
- ★ Shelf and shelf support are designed to accommodate 2 x 1/1 GN pan
- ★ Heated door frame for freezer unit
- ★ Heavy duty evaporator and condenser fans
- ★ Heavy duty castors with front wheel brakes

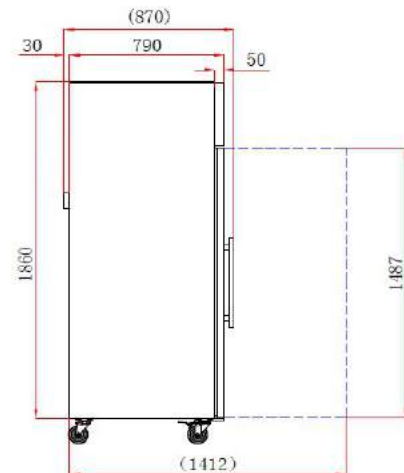
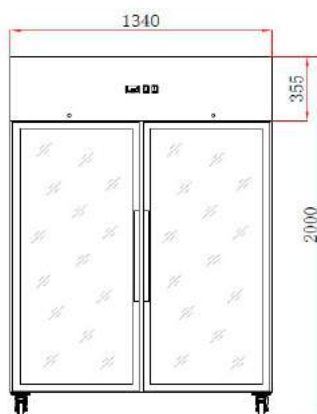
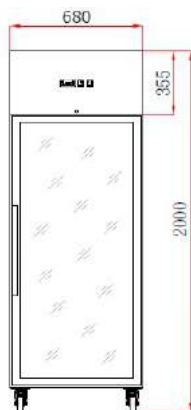

Model	XURC600G1V	XURC1200G2V	XURF600G1V	XURF1200G2V
Dimension(W*D*H /mm)	680*810*2000	1340*810*2000	680*810*2000	1340*810*2000
Net Capacity(L)	600	1200	600	1200
Cooling System	Fan forced cooling	Fan forced cooling	Fan forced cooling	Fan forced cooling
Type	Fridge	Fridge	Freezer	Freezer
Temperature(°C)	+2~+8	+2~+8	-15~-18	-15~-18
Compressor	Cubigel	Cubigel	Cubigel	Cubigel
Controller	Dixell	Dixell	Dixell	Dixell
Refrigerant	R290	R290	R290	R290
Ambient Temp(°C)/ RH %	38/40	38/40	38/40	38/40
Voltage(V)/Frequency(Hz)/Amps(A)	240 / 50 / 10	240 / 50 / 10	240 / 50 / 10	240 / 50 / 10
Power(W)	195	400	450	700
Weight(Kg)	132	167	132	167
Price ex gst	\$2,620.00	\$3,990.00	\$3,220.00	\$4,980.00

**Features**

- ★ Stainless steel interior and exterior with rounded corners for easy cleaning
- ★ Auto defrost
- ★ Three levels of shelving plus base
- ★ Self-closing lockable doors with heavy duty magnetic door seals
- ★ Internal LED lighting
- ★ HFCs and CFCs free foam body insulation
- ★ User friendly Digital controls and internal lighting
- ★ Shelf and shelf support are designed to accomodate 2 x 1/1 GN pan
- ★ Heated door frame for freezer unit
- ★ Heavy duty evaporator and condensor fans
- ★ Heavy duty castors with front wheel brakes

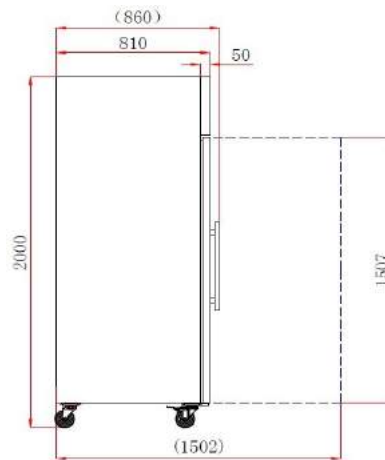

Model	XURC1410G2V	XURF1410G2V
Dimension(W*D*H /mm)	1480*810*2000	1480*810*2000
Net Capacity(L)	1410	1410
Cooling System	Fan forced cooling	Fan forced cooling
Type	Fridge	Freezer
Temperature(°C)	+2~+8	-15~-18
Compressor	Cubigel	Cubigel
Controller	Dixell	Dixell
Refrigerant	R290	R290
Ambient Temp(°C)/ RH %	38/40	38/40
Voltage(V)/Frequency(Hz)/Amps(A)	240 / 50 / 10	240 / 50 / 10
Power(W)	415	865
Weight(Kg)	208	208
Price ex gst	\$4,300.00	\$5,600.00

## UNDER COUNTER SOLID DOOR REFRIGERATION

### Features

- ★ Stainless steel interior and exterior with rounded corners for easy cleaning
- ★ Auto defrost
- ★ 1 shelf per door, additional shelf sets available
- ★ Self-closing doors with heavy duty magnetic door seals
- ★ 60mm HFCs and CFCs free foam body insulation
- ★ Tropicalised for Australian conditions
- ★ User friendly Digital controls
- ★ Rapid recovery rate
- ★ Heavy duty evaporator and condensor fans
- ★ Heavy duty castors with front wheel brakes
- ★ Unit can be placed against wall



XUB6C13S2V

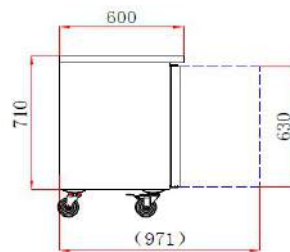
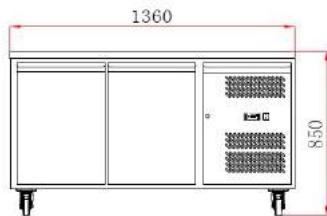

XUB6C18S3V



XUB6C22S4V

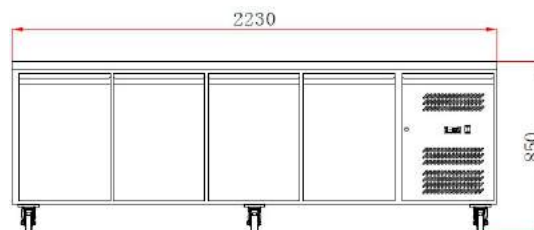
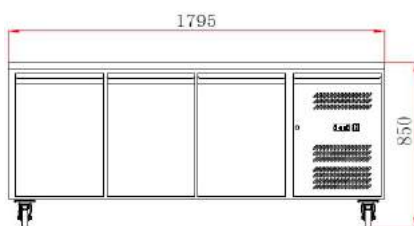

Model	XUB6C13S2V	XUB6C18S3V	XUB6C22S4V	XUB6F13S2V	XUB6F18S3V
Dimension(W*D*H /mm)	1360*600*850	1795*600*850	2230*600*850	1360*600*850	1795*600*850
Net Capacity(L)	228	339	449	228	339
Cooling System	Fan forced cooling	Fan forced cooling	Fan forced cooling	Fan forced cooling	Fan forced cooling
Type	Fridge	Fridge	Fridge	Freezer	Freezer
Temperature(°C)	-2~+8	-2~+8	-2~+8	-18~-22	-18~-22
Compressor	Cubigel	Cubigel	Cubigel	Cubigel	Cubigel
Controller	Dixell	Dixell	Dixell	Dixell	Dixell
Refrigerant	R290	R290	R290	R290	R290
Ambient Temp(°C)/ RH %	43/40	43/40	43/40	38/40	38/40
Volt(V)/Freq(Hz)/Amps(A)	240 / 50 / 10	240 / 50 / 10	240 / 50 / 10	240 / 50 / 10	240 / 50 / 10
Power(W)	215	230	345	520	560
Weight(Kg)	83	105	121	107	134
Price ex gst	\$2,290.00	\$2,590.00	\$2,990.00	\$2,800.00	\$3,150.00



## UNDER COUNTER SOLID DOOR REFRIGERATION

### Features

- ★ Stainless steel interior and exterior with rounded corners for easy cleaning
- ★ 1 shelf per door, GN1/1 pan compatible
- ★ Self-closing doors with heavy duty magnetic door seals
- ★ 60mm HFCs and CFCs free foam body insulation
- ★ Tropicalised for Australian conditions
- ★ User friendly Digital controls
- ★ Rapid recovery rate
- ★ Optional 2 and 3 drawer units available in lieu of doors
- ★ Ebm-papst evaporator and condenser fans
- ★ Heavy duty castors with front wheel brakes
- ★ Unit can be placed against wall



XUB7C13S2V

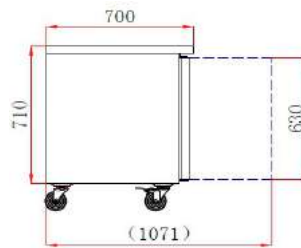
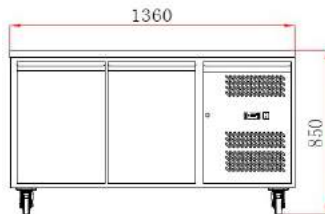

XUB7C18S3V



XUB7C22S4V

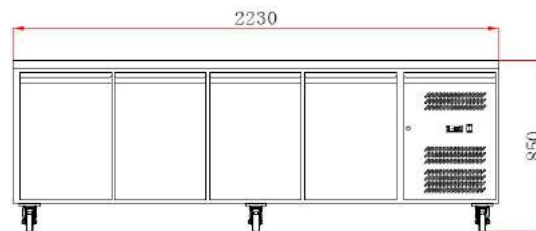
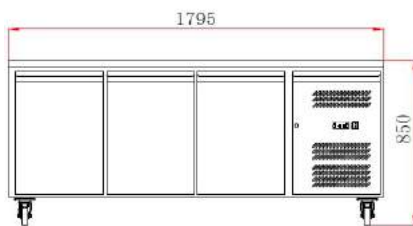

Model	XUB7C13S2V	XUB7C18S3V	XUB7C22S4V	XUB7F13S2V	XUB7F18S3V
Dimension(W*D*H /mm)	1360*700*850	1795*700*850	2230*700*850	1360*700*850	1795*700*850
Net Capacity(L)	282	417	553	282	417
Cooling System	Fan forced cooling	Fan forced cooling	Fan forced cooling	Fan forced cooling	Fan forced cooling
Type	Fridge	Fridge	Fridge	Freezer	Freezer
Temperature(°C)	-2~+8	-2~+8	-2~+8	-18~-22	-18~-22
Compressor	Embraco/Secop	Embraco/Secop	Embraco/Secop	Embraco/Secop	Embraco/Secop
Controller	Dixell	Dixell	Dixell	Dixell	Dixell
Ambient Temp(°C)/ RH %	43/40	43/40	43/40	43/40	43/40
Volt(V)/Freq(Hz)/Amps(A)	240 / 50 / 10	240 / 50 / 10	240 / 50 / 10	240 / 50 / 10	240 / 50 / 10
Power(W)	230	235	335	600	650
Weight(Kg)	102	121	150	107	146
Price ex gst	\$2,390.00	\$2,690.00	\$3,290.00	\$2,800.00	\$3,150.00

## UNDER COUNTER GLASS DOOR REFRIGERATION

### Features

- ★ Stainless steel interior and exterior with rounded corners for easy cleaning
- ★ 1 shelf per door
- ★ GN1/1 pan compatible with XUB7 range
- ★ Self-closing doors with heavy duty magnetic door seals
- ★ 60mm HFCs and CFCs free foam body insulation
- ★ User friendly Digital controls
- ★ Rapid recovery rate
- ★ Ebm-papst evaporator and condenser fans
- ★ Heavy duty castors with front wheel brakes
- ★ Unit can be placed against wall



XUB7C13G2V

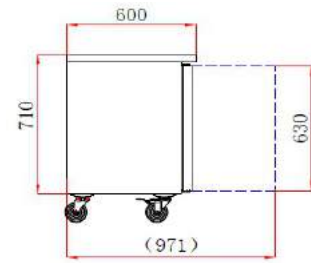
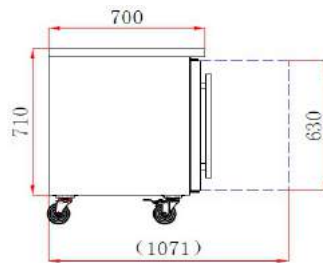
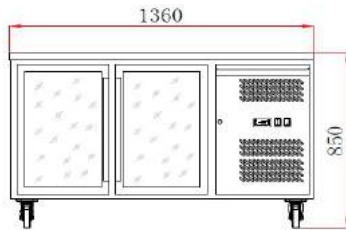

XUB7C18G3V



XUB7C22G4V

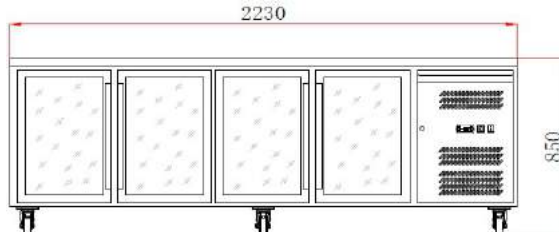
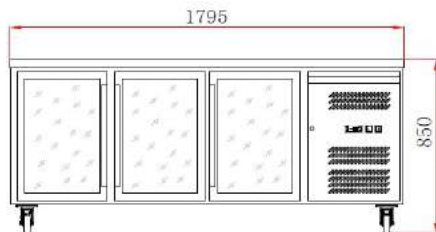

Model	XUB6C13G2V	XUB6C18G3V	XUB7C13G2V	XUB7C18G3V	XUB7C22G4V
Dimension(W*D*H /mm)	1360*600*850	1795*600*850	1360*700*850	1795*700*850	2230*700*850
Net Capacity(L)	228	339	282	417	553
Cooling System	Fan forced cooling	Fan forced cooling	Fan forced cooling	Fan forced cooling	Fan forced cooling
Type	Fridge	Fridge	Fridge	Fridge	Fridge
Temperature(°C)	-2~+8	-2~+8	-2~+8	-2~+8	-2~+8
Compressor	Embraco/Secop	Embraco/Secop	Embraco/Secop	Embraco/Secop	Embraco/Secop
Controller	Dixell	Dixell	Dixell	Dixell	Dixell
Ambient Temp(°C)/ RH %	35/60	35/60	35/60	35/60	35/60
Volt(V)/Freq(Hz)/Amps(A)	240 / 50 / 10	240 / 50 / 10	240 / 50 / 10	240 / 50 / 10	240 / 50 / 10
Power(W)	215	230	230	235	335
Weight(Kg)	83	105	108	134	158
Price ex gst	\$2,550.00	\$2,890.00	\$2,650.00	\$2,990.00	\$3,790.00

## COMPACT WORKBENCH REFRIGERATION

### Features

- ★ Stainless steel interior and exterior with rounded corners for easy cleaning
- ★ Replaceable magnetic door seals
- ★ Drawers have Industry leading Fulterer Heavy duty componentry
- ★ User friendly Digital controls
- ★ Heavy duty castors
- ★ Drawers give easy access to product from front to back
- ★ Drawers allows you quick and easy control of products
- ★ Drawers offer you easy and fast removal of pans and products
- ★ Drawers are easy to clean
- ★ Drawer operation is easy on your back... no need to go on your knees
- ★ GN1/1 shelf or GN1/1 drawer (each drawer takes 1/1 , 2 x 1/2 or 3 x 1/3 in up to 100mm deep pan capacity)
- ★ GN pans can be selected on Page 20 and 21



XGNS900B

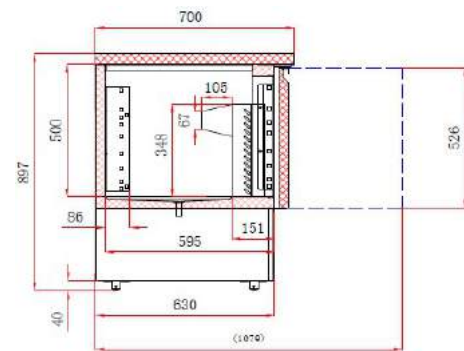
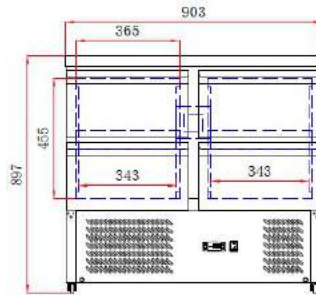

XGNS900-4D

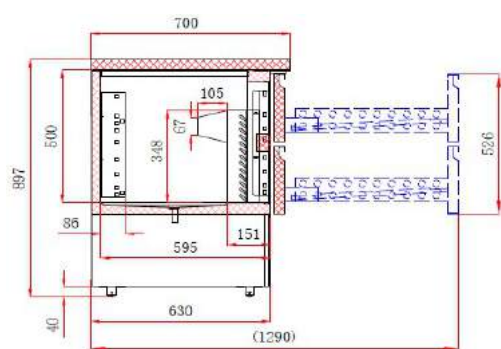
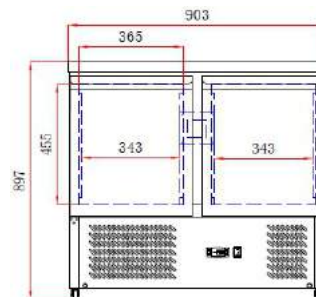

Model	XGNS900B	XGNS900-4D
Dimension(W*D*H /mm)	903*700*897	903*700*897
Net Capacity(L)	240	220
Cooling System	Fan assist cooling	Fan assist cooling
Temperature(°C)	+2~+8	+2~+8
Compressor	Embraco/Secop	Embraco/Secop
Controller	Dixell	Dixell
Ambient Temp(°C)/ RH %	32/60	32/60
Voltage(V)/Frequency(Hz)/Amps(A)	240 / 50 / 10	240 / 50 / 10
Power(W)	180	180
Weight(Kg)	81	81
Price ex gst	\$1,490.00	\$2,499.00

## COMPACT WORKBENCH REFRIGERATION

### Features

- ★ Stainless steel interior and exterior with rounded corners for easy cleaning
- ★ Replaceable magnetic door seals
- ★ User friendly Digital controls
- ★ Industry leading Filterer Heavy duty drawer runners
- ★ Heavy duty castors
- ★ Drawers allows you quick and easy control of products
- ★ Drawers offer you easy and fast removal of pans and products
- ★ Drawers are easy to clean
- ★ Drawer operation is easy on your back... no need to go on your knees
- ★ GN1/1 shelf or GN1/1 drawer (each drawer takes 1/1 , 2 x 1/2 or 3 x 1/3 in up to 100mm deep pan capacity)
- ★ GN pans can be selected on Page 20 and 21



XGNS1300B

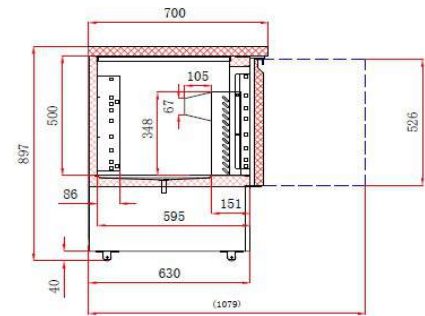
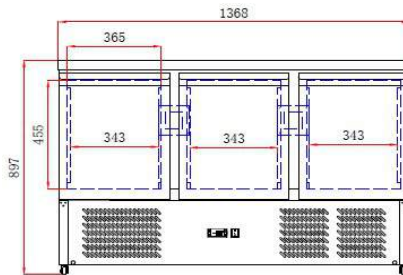

XGNS1300-6D

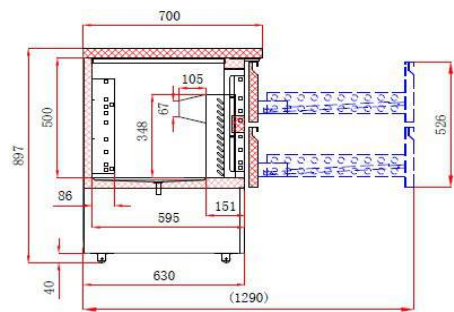
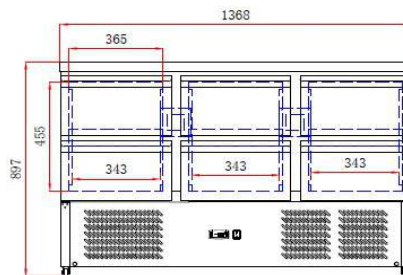

Model	XGNS1300B	XGNS1300-6D
Dimension(W*D*H /mm)	1368*700*897	1368*700*897
Net Capacity(L)	368	368
Cooling System	Fan assist cooling	Fan assist cooling
Temperature(°C)	+2~+8	+2~+8
Compressor	Embraco/Secop	Embraco/Secop
Controller	Dixell	Dixell
Ambient Temp(°C)/ RH %	32/60	32/60
Voltage(V)/Frequency(Hz)/Amps(A)	240 / 50 / 10	240 / 50 / 10
Power(W)	255	255
Weight(Kg)	104	104
Price ex gst	\$2,090.00	\$3,390.00

## SANDWICH, PIZZA AND SALAD PREPARATION BENCH

### Features

- ★ Stainless steel interior and exterior with rounded corners for easy cleaning
- ★ Stainless steel intergrated lid
- ★ 1 x GN1/1 shelf per door
- ★ Replaceable magnetic door seals
- ★ User friendly Digital controls
- ★ Intergrated cutting board (S Series only)
- ★ Heavy duty castors
- ★ Pan and pan cover must be used to ensure correct operating temperature
- ★ GN1/6 Pan slots (D Series) Multiple pan configuration (S Series)
- ★ Pans and lids are not included, see large range of compatible pans on page 20 & 21



XGNS900D

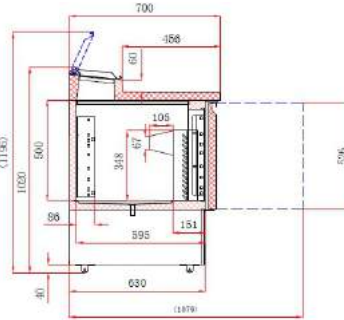
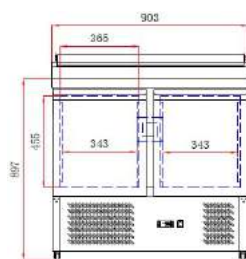

XGNS1300D

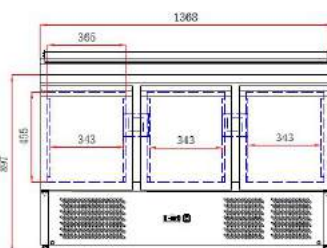

XGNS1300S

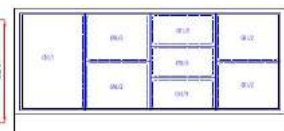
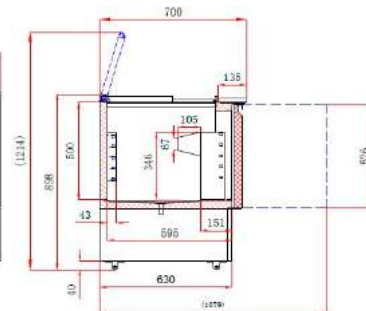
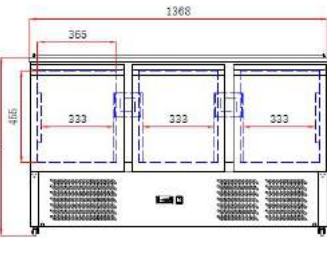

Model	XGNS900D	XGNS1300D	XGNS1300S
Dimension(W*D*H /mm)	903*700*1020	1368*700*1020	1368*700*898
Net Capacity(L)	240	392	368
Cooling System	Fan assist cooling	Fan assist cooling	Fan assist cooling
Temperature(°C)	+2~+8	+2~+8	+2~+8
Compressor	Embraco/Secop	Embraco/Secop	Cubigel
Controller	Dixell	Dixell	Dixell
Refrigerant	R290	R290	R290
Ambient Temp(°C)/ RH %	32/60	32/60	32/60
Voltage(V)/Frequency(Hz)/Amps(A)	240 / 50 / 10	240 / 50 / 10	240 / 50 / 10
Power(W)	170	255	240
Weight(Kg)	81	104	115
Price ex gst	\$1,699.00	\$2,390.00	\$2,390.00

## SANDWICH and PIZZA PREPARATION BENCH

### Features

- ★ Stainless steel interior and exterior with rounded corners for easy cleaning
- ★ Open cooling top compatible for GN1/6 pans (Pans and lids are not included)
- ★ 1 \* GN1/1 shelf per door
- ★ Replaceable magnetic door seals
- ★ User friendly Digital controls
- ★ Granite stone work top
- ★ Heavy duty castors
- ★ Pan and pan cover must be used to ensure correct operating temperature
- ★ Pans are not included, see large range of compatible pans selection in page 20 & 21



XGNS900E

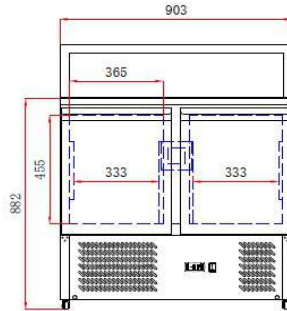

XGNS1300E

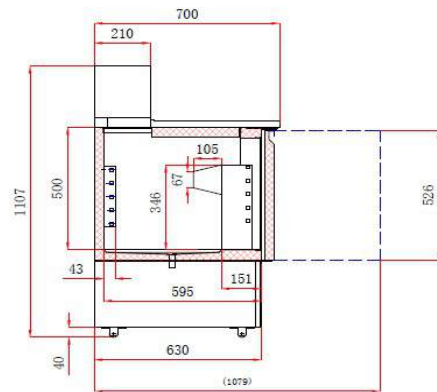
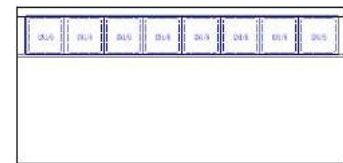
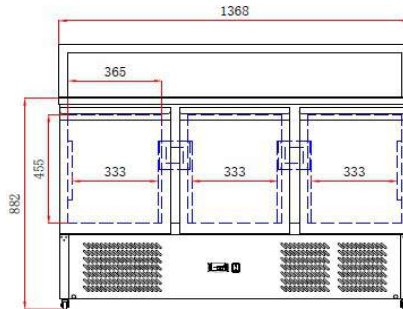

\* Suitable GN Pans: GN16065, GN16100, GN16150.

Model	XGNS900E	XGNS1300E	GN16065	GN16100	GN16150
Dimension(W*D*H /mm)	903*700*1107	1368*700*1107	162*176*65	162*176*100	162*176*150
Net Capacity(L)	240	402			
Cooling System	Fan assist cooling	Fan assist cooling			
Temperature(°C)	+2~+8	+2~+8			
Compressor	Embraco/Secop	Embraco/Secop			
Controller	Dixell	Dixell			
Ambient Temp(°C)/ RH %	32/60	32/60			
Voltage(V)/Frequency(Hz)/Amps(A)	240 / 50 / 10	240 / 50 / 10			
Power(W)	180	255			
Weight(Kg)	106	166			
Price ex gst	\$1,890.00	\$2,490.00	\$5.36	\$10.02	\$16.90



\* GN pans not included. Pan covers must be used to ensure correct operating temperature.

**Features**

- ★ Stainless steel interior and exterior with rounded corners for easy cleaning
- ★ Glass canopy with ambient middle shelf
- ★ Open top suitable for multiple pan configurations (Pans and lids are not included)
- ★ Replaceable magnetic door seals
- ★ User friendly Digital controls
- ★ Integrated cutting board
- ★ Heavy duty castors
- ★ Pan and pan cover must be used to ensure correct operating temperature
- ★ Pans are not included, see large range of compatible pans selection in page 20 & 21

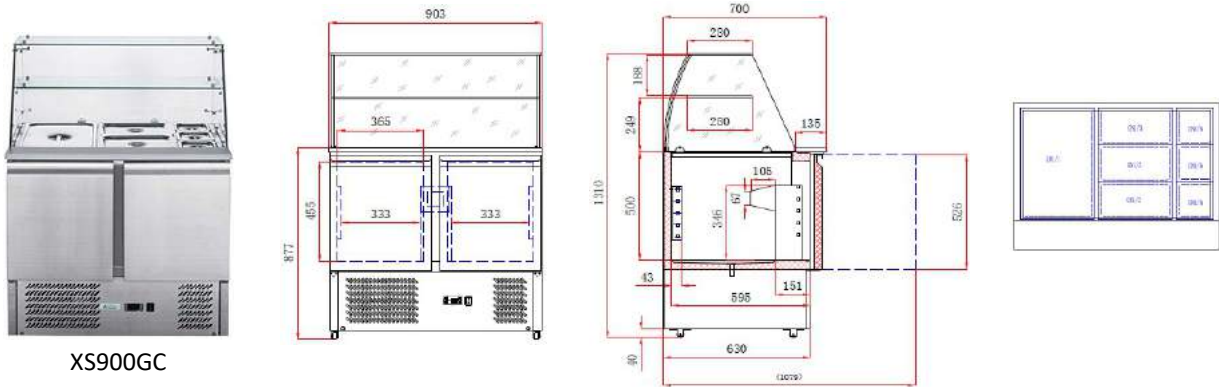

XS900GC

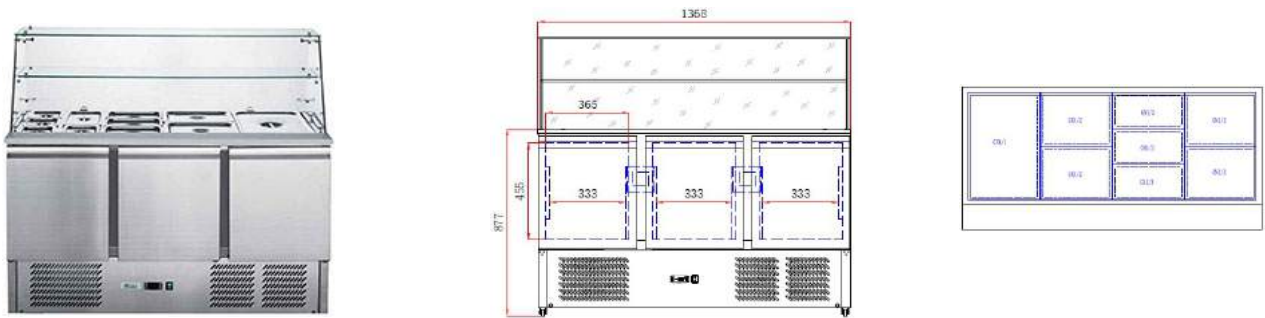

XS903GC



Model	XS900GC	XS903GC
Dimension(W*D*H /mm)	903*700*1310	1368*700*1310
Net Capacity(L)	240	368
Cooling System	Fan assist cooling	Fan assist cooling
Temperature(°C)	+2~+8	+2~+8
Compressor	Embraco/Secop	Embraco/Secop
Controller	Dixell	Dixell
Ambient Temp(°C)/ RH %	32/60	32/60
Voltage(V)/Frequency(Hz)/Amps(A)	240 / 50 / 10	240 / 50 / 10
Power(W)	180	255
Weight(Kg)	81	104
Price ex gst	\$2,190.00	\$2,690.00

## SALAD and PIZZA PREPARATION COUNTER

### Features

- ★ Stainless steel interior and exterior with rounded corners for easy cleaning
- ★ Compatible for 1/3 GN Pan up to 150mm deep
- ★ 1 shelf per door, GN1/1 pan compatible
- ★ Self-closing doors with heavy duty magnetic door seals
- ★ 60mm HFCs and CFCs free foam body insulation
- ★ Tropicalised for Australian conditions
- ★ User friendly Digital controls
- ★ Rapid recovery rate
- ★ Optional 2 and 3 drawer units available in lieu of doors for 700mm deep units
- ★ Ebm-papst evaporator and condensor fans
- ★ Heavy duty castors with front wheel brakes
- ★ Pans are not included, see large range of compatible pans selection in page 20 & 21

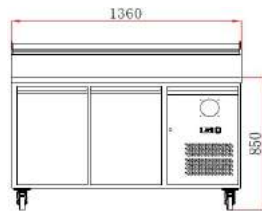
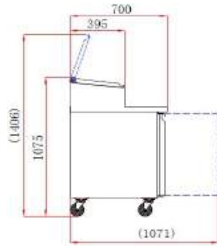

XSS7C13S2V

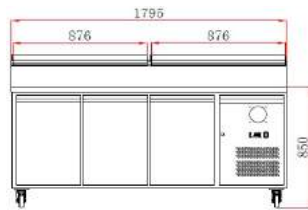
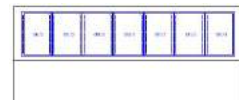

XSS7C18S3V

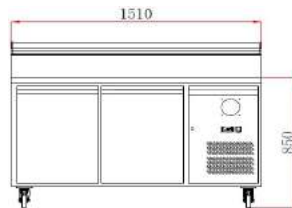
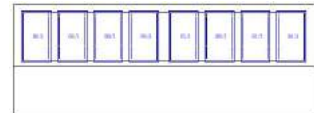

XSS8C15S2V

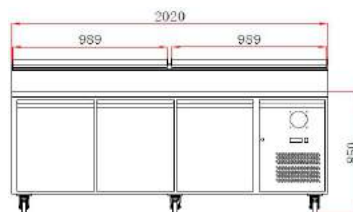
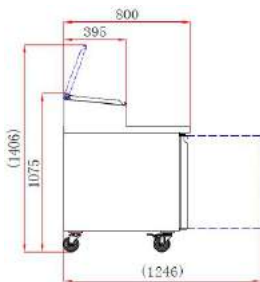
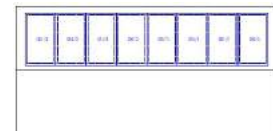

XSS8C20S3V

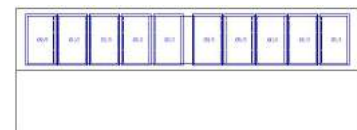

Model	XSS7C13S2V	XSS7C18S3V	XSS8C15S2V	XSS8C20S3V
Dimension(W*D*H /mm)	1360*700*1406	1795*700*1406	1510*800*1406	2020*800*1406
Net Capacity(L)	282	417	390	580
Cooling System	Fan forced cooling	Fan forced cooling	Fan forced cooling	Fan forced cooling
Temperature(°C)	+2~+8	+2~+8	+2~+8	+2~+8
Compressor	Cubigel	Cubigel	Cubigel	Cubigel
Controller	Dixell	Dixell	Dixell	Dixell
Ambient Temp(°C)/ RH %	43/40	43/40	43/40	43/40
Voltage(V)/Frequency(Hz)/Amps(A)	240 / 50 / 10	240 / 50 / 10	240 / 50 / 10	240 / 50 / 10
Power(W)	320	320	320	320
Weight(Kg)	110	140	120	160
Price ex gst	\$2,990.00	\$3,690.00	\$3,190.00	\$3,990.00



**Features**

- ★ Stainless steel interior and exterior with rounded corners for easy cleaning
- ★ Self-closing doors with heavy duty magnetic door seals
- ★ User friendly Digital controls
- ★ Tropicalised for Australian conditions
- ★ Ebm-papst evaporator and condenser fans
- ★ Rapid recovery rate
- ★ Heavy duty castors with front wheel brakes



XPZ2600TN

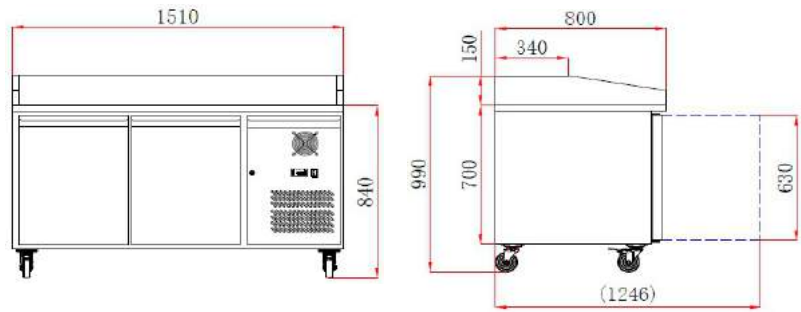

XPZ3600TN

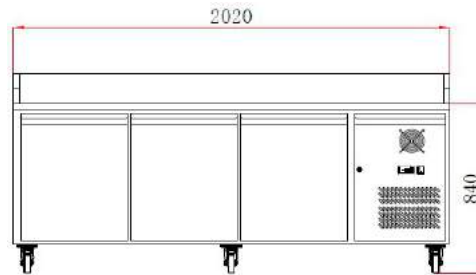

Model	XPZ2600TN	XPZ3600TN
Dimension(W*D*H /mm)	1510*800*990	2020*800*1000
Net Capacity(L)	390	580
Cooling System	Fan forced cooling	Fan forced cooling
Temperature(°C)	-2~+8	-2~+8
Compressor	Cubigel	Cubigel
Controller	Dixell	Dixell
Ambient Temp(°C)/ RH %	43/40	43/40
Voltage(V)/Frequency(Hz)/Amps(A)	240 / 50 / 10	240 / 50 / 10
Power(W)	215	320
Weight(Kg)	252	316
Price ex gst	\$2,990.00	\$3,690.00

**Features**

- ★ Stainless steel interior and exterior with rounded corners for easy cleaning
- ★ Open top suitable for multiple pan configurations
- ★ Replaceable magnetic door seals
- ★ User friendly Digital controls
- ★ Integrated cutting board made from high-density polyethylene
- ★ Heavy duty castors with front wheel brakes
- ★ Pan and pan cover must be used to ensure correct operating temperature
- ★ Pans are not included, see large range of compatible pans selection in page 20 & 21



XTHP2100SALGC

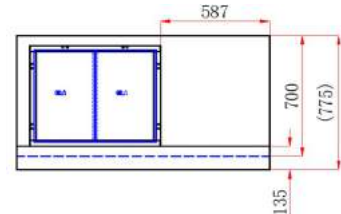
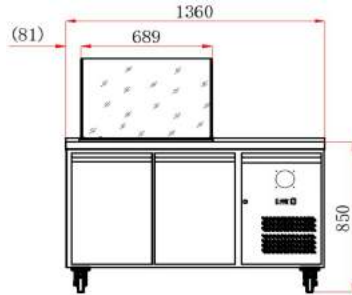

XTHP3100SALGC

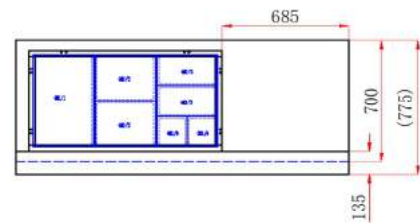
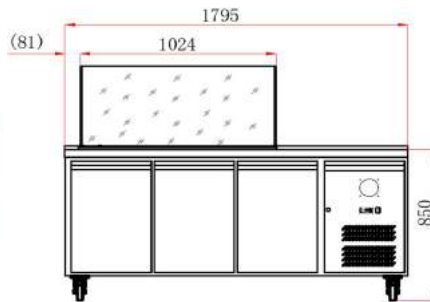

Model	XTHP2100SALGC	XTHP3100SALGC
Dimension(W*D*H /mm)	1360*700*1320	1795*700*1320
Net Capacity(L)	314	465
Cooling System	Fan forced cooling	Fan forced cooling
Temperature(°C)	+2~+8	+2~+8
Compressor	Cubigel	Cubigel
Controller	Dixell	Dixell
Refrigerant	R290	R290
Ambient Temp(°C)/ RH %	43/40	43/40
Voltage(V)/Frequency(Hz)/Amps(A)	240 / 50 / 10	240 / 50 / 10
Power(W)	215	230
Weight(Kg)	105	118
Price ex gst	\$2,599.00	\$3,299.00

**Features**

- ★ Stainless steel interior and exterior
- ★ Heavy duty condensor fans
- ★ Dixell digital temp controller
- ★ Angled pan positions maximum pan depth: 150mm
- ★ Toughened glass canopy
- ★ Pan and pan cover must be used to ensure correct operating temperature
- ★ Pans are not included, see large range of compatible pans selection in page 20 & 21



XVRX1200/380

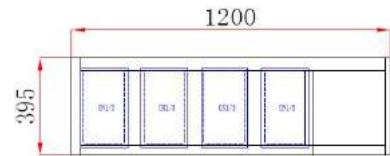
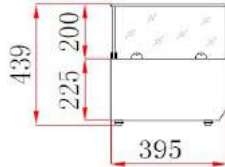

XVRX1500/380

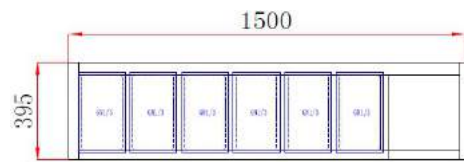

XVRX1800/380

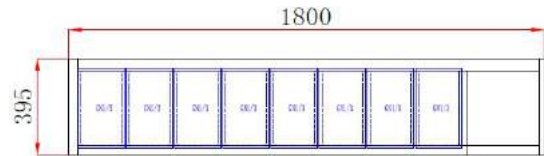

XVRX2000/380

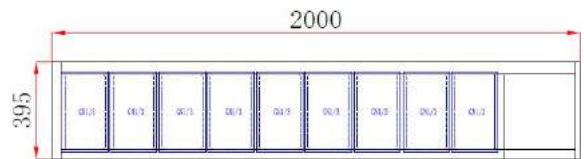

Model	XVRX1200/380	XVRX1500/380	XVRX1800/380	XVRX2000/380
Dimension(W*D*H /mm)	1200*395*439	1500*395*439	1800*395*439	2000*395*439
Net Capacity(L)	4*1/3GN	6*1/3GN	8*1/3GN	9*1/3GN
Cooling System	Static Cooling	Static Cooling	Static Cooling	Static Cooling
Temperature(°C)	+2~+8	+2~+8	+2~+8	+2~+8
Compressor	Donper	Donper	Donper	Donper
Controller	Dixell	Dixell	Dixell	Dixell
Refrigerant	R600a	R600a	R600a	R600a
Ambient Temp(°C)/ RH %	32/60	32/60	32/60	32/60
Voltage(V)/Frequency(Hz)/Amps(A)	240 / 50 / 10	240 / 50 / 10	240 / 50 / 10	240 / 50 / 10
Power(W)	110	110	110	110
Weight(Kg)	40.5	48	50.5	60
Price ex gst	\$889.00	\$999.00	\$1,099.00	\$1,399.00

## ACCESSORIES

### Optional Splashback Top - 10mm Height

**Price ex gst**



XUB62-WBB	Splashback top for 2 door 600mm deep under counter unit, suits XUB6C13S2V and XUB6F13S2V		\$220.00
XUB63-WBB	Splashback top for 3 door 600mm deep under counter unit, suits XUB6C18S3V and XUB6F18S3V		\$280.00
XUB64-WBB	Splashback top for 4 door 600mm deep under counter unit, suits XUB6C22S4V		\$320.00
XUB72-WBB	Splashback top for 2 door 700mm deep under counter unit, suits XUB7C13S2V, XUB7C13G2V and XUB7F13S2V		\$230.00
XUB73-WBB	Splashback top for 3 door 700mm deep under counter unit, suits XUB7C18S3V, XUB7C18G3V and XUB7F18S3V		\$300.00
XUB74-WBB	Splashback top for 4 door 700mm deep under counter unit, suits XUB7C22S4V and XUB7C22G4V		\$340.00

### Optional Drawers for Solid Door Units

XUB-2DRAWER	1/2 Drawer x 2 with Fulterer heavy duty runner		\$500.00
XUB-3DRAWER	1/3 Drawer x 3 with Fulterer heavy duty runner		\$760.00

Optional 2 Drawer                      Optional 3 Drawer



### Additional Shelf Set for Upright Units

12502013416	Infill shelf for XURC1200G2V, XURC1200S2V, XURF1200G2V and XURF1200S2V		\$20.00
12502012803	Infill shelf for XURC1410G2V, XURC1410S2V, XURF1410G2V and XURF1410S2V		\$20.00
XUR-SHELFSET	Additional shelf set for upright fridge and freezer units, including one shelving and one pair of runner, suits XURC1200G2V, XURC1200S2V, XURC600G1V, XURC600S1V, XURF1200G2V, XURF1200S2V, XURF600G1V, XURF600S1V, XURC1410G2V, XURC1410S2V, XURC650G1V, XURC650S1V, XURF1410G2V, XURF1410S2V and XURF650S1V		\$80.00

### Additional Shelf Set for Under Counter Units

XUB6-SHELFSET	Additional shelf set for 600mm deep under counter units, including one shelving and one pair of runner, suits XUB6C13S2V, XUB6C18S3V, XUB6C22S4V, XUB6F13S2V and XUB6F18S3V		\$60.00
XUB7-SHELFSET	Additional shelf set for 700mm deep under counter units, including one shelving and one pair of runner, suits XUB7C13S2V, XUB7C13G2V, XUB7F13S2V, XUB7C18S3V, XUB7C18G3V, XUB7F18S3V, XUB7C22S4V, XUB7C22G4V, XGNS900B, XGNS1300B, XGNS1300D, XSS7C13S2V and XSS7C18S3V		\$60.00
XUB8-SHELFSET	Additional shelf set for 800mm deep under counter units, including one shelving and one pair of runner, suits XSS8C15S2V and XSS8C20S3V		\$65.00
XGNS-SHELFSET	Additional shelf set for saladettesr units, including one shelving and one pair of runner, suits XGNS900E, XGNS1300E, XS900GC, XS903GC and XGNS1300S		\$60.00

### Optional Stainless Steel Runners & Legs

GXE-2-1516	Runner Set for Upright Refrigeration, XURC1200G2V, XURC1200S2V, XURC600G1V, XURC600S1V, XURF1200G2V, XURF1200S2V, XURF600G1V, XURF600S1V, XURC1410G2V, XURC1410S2V, XURC650G1V, XURC650S1V, XURF1410G2		\$44.00
GXE-2-7778	Runner Set for Saladettes, suits XGNS900E, XGNS1300E, XS900GC, XS903GC and XGNS1300S		\$44.00
GXE-2-211210	Runner Set for 600mm deep under counter units, suits XUB6C13S2V, XUB6C18S3V, XUB6C22S4V, XUB6F13S2V and XUB6F18S3V		\$44.00
GXE-2-3637	Runner Set for 700mm Deep Under Counter Unit, suits XUB7C13S2V, XUB7C13G2V, XUB7F13S2V, XUB7C18S3V, XUB7C18G3V, XUB7F18S3V, XUB7C22S4V, XUB7C22G4V, XGNS900B, XGNS1300B, XGNS1300D, XSS7C13S2V and XSS7C18S3V		\$44.00
GXE-2-215216	Runner Set for 800mm deep under counter units, suits XSS8C15S2V and XSS8C20S3V	\$44.00	
12533110010	Heavy duty Stainless Steel Leg Adjustable Range 140-200mm (per pc)		\$38.00

## S/S GASTRONORM PANS

- SPECIAL PRICE FOR 3-CARTON BUY • HEAVY DUTY • ALL STAINLESS STEEL • 0.6mm • ANTI JAM
- Patented stackable and nestable design • Fine, smooth finish • Double rim for strength & rigidity



GN	Depth (mm)	Dimensions (WxH mm)	Code	Price ex gst
1/9	65	108x176	GN19065	\$5.78
1/9	100	108x176	GN19100	\$8.11



GN	Depth (mm)	Dimensions (WxH mm)	Code	Price ex gst
1/6	65	162x176	GN16065	\$5.36
1/6	100	162x176	GN16100	\$10.02
1/6	150	162x176	GN16150	\$16.90



GN	Depth (mm)	Dimensions (WxH mm)	Code	Price ex gst
1/4	65	162x265	GN14065	\$6.86
1/4	100	162x265	GN14100	\$11.53
1/4	150	162x265	GN14150	\$21.56



GN	Depth (mm)	Dimensions (WxH mm)	Code	Price ex gst
1/3	65	325x176	GN13065	\$8.68
1/3	100	325x176	GN13100	\$13.08
1/3	150	325x176	GN13150	\$19.57



GN	Depth (mm)	Dimensions (WxH mm)	Code	Price ex gst
1/2	20	325x265	GN12020	\$7.98
1/2	40	325x265	GN12040	\$9.24
1/2	65	325x265	GN12065	\$10.78
1/2	100	325x265	GN12100	\$16.90
1/2	150	325x265	GN12150	\$24.60



GN	Depth (mm)	Dimensions (WxH mm)	Code	Price ex gst
2/3	65	325x353	GN23065	\$18.41
2/3	100	325x353	GN23100	\$26.10
2/3	150	325x353	GN23150	\$32.29



GN	Depth (mm)	Dimensions (WxH mm)	Code	Price ex gst
1/1	20	530x325	GN11020	\$12.82
1/1	65	530x325	GN11065	\$16.90
1/1	100	530x325	GN11100	\$26.93
1/1	150	530x325	GN11150	\$35.43



GN	Dimensions (WxH mm)	Code	Price ex gst
1/9	108x176	GN19000	\$3.84
1/6	162x176	GN16000	\$4.65
1/4	325x265	GN14000	\$5.36
1/3	325x176	GN13000	\$6.17
1/2	325x265	GN12000	\$8.50
2/3	325x353	GN23000	\$14.56
1/1	530x325	GN11000	\$13.86



• Perforated Pans

GN	Depth (mm)	Dimensions (WxH mm)	Code	Price ex gst
1/2	65	325x265	P12065	\$13.24
1/2	100	325x265	P12100	\$20.24
1/2	150	325x265	P12150	\$29.80

GN	Depth (mm)	Dimensions (WxH mm)	Code	Price ex gst
1/1	65	530x325	P11065	\$18.86
1/1	100	530x325	P11100	\$27.97
1/1	150	530x325	P11150	\$35.71

Prices and specifications are subject to change without notice. Pictures are for illustrative purpose and final product may differ

## POLY GASTRONORM PANS

- HEAVY DUTY polypropylene • Low blemish finish • Non-stick smooth interior • Capacity Marks



GN	Depth (mm)	Dimensions (WxH mm)	Black	Clear	Price ex gst
1/9	65	108x176	JW-P192B	JW-P192	\$4.65
1/9	100	108x176	JW-P194B	JW-P194	\$5.36



GN	Depth (mm)	Dimensions (WxH mm)	Black	Clear	Price ex gst
1/6	65	162x176	JW-P162B	JW-P162	\$6.17
1/6	100	162x176	JW-P164B	JW-P164	\$7.69



GN	Depth (mm)	Dimensions (WxH mm)	Black	Clear	Price ex gst
1/3	65	325x176	JW-P132B	JW-P132	\$12.35
1/3	100	325x176	JW-P134B	JW-P134	\$13.86



GN	Depth (mm)	Dimensions (WxH mm)	Black	Clear	Price ex gst
1/2	65	325x265	JW-P122B	JW-P122	\$13.86



GN	Depth (mm)	Dimensions (WxH mm)	Black	Clear	Price ex gst
1/1	65	530x325	JW-P112B	JW-P112	\$23.89



GN	Dimensions (WxH mm)	Code	Price ex gst
Clear Lid			
1/9	108x179	JW-P19HC	\$3.84
Clear Lid with Notch			
1/6	162x176	JW-P16DHH	\$4.65
1/3	325x176	JW-P13DHH	\$9.20
1/2	325x265	JW-P12DHH	\$12.35
1/1	530x325	JW-P11DHH	\$20.75



Hassan Rahman  
Business Consultant/Advisor

M: 0430 939393  
W: [www.alphaexchange.com.au](http://www.alphaexchange.com.au)  
E: [admin@alphaexchange.com.au](mailto:admin@alphaexchange.com.au)

Prices and specifications are subject to change without notice. Pictures are for illustrative purpose and final product may differ