



allanblock.in

Introducing Allan Block a World Leader in Concrete Block Products

*Represented in India by PraYoSa
Offering World Class Products to Beautify Indian Landscapes*



Retaining Walls



Fence / Compound Walls



Patio Walls



PraYoSa Buildmat Pvt. Ltd.
2, Sachinam Opp. Sai. Point Honda,
Almeda Road, Panchpakhadi
Thane (W) 400602
Tel: +91 22 25401275/1065
+91 9619183462
Email: sales@prayosa.co.in

AB Fence® System

AB Fence can be used to build free standing compound walls from 4-30 feet (1.2 to 9 m) in height and can even sustain earth fills up to six feet (1.8 m)!! The perfect solution based on Tested Design and Performance, Hand Crafted Aesthetics, and Phenomenal Speed of Construction.



Compound Walls with Strength and Beauty.

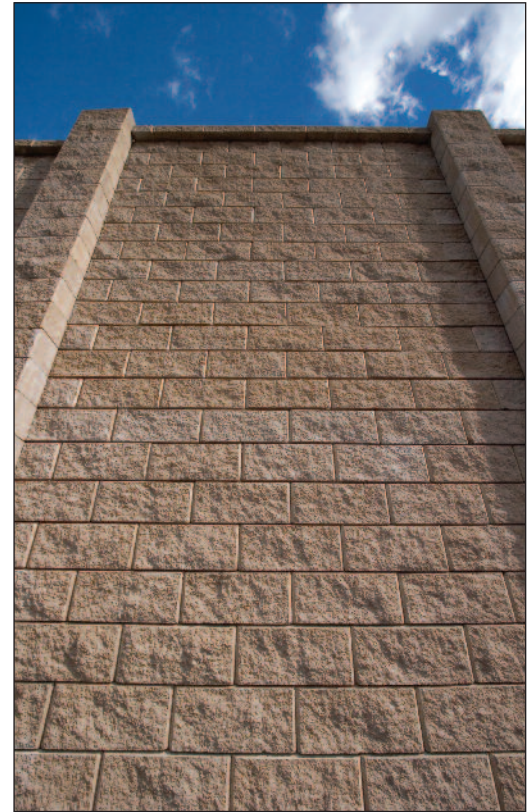

One block shape and texture.

AB Fence Post Block *AB Fence Panel Block* *AB Fence Lite Panel Block*



AB Fence Half Panel Block *AB Fence Cap Block*



AB Fence is a two-sided fencing system that is the perfect product for any project. Its versatile and structurally sound with a choice of two different colors and textures - rock like split face or a striated face. This offers many different combinations so every wall will look unique. Use the blocks together to create a work of art or use just the AB Fence Panel block to create a clean architectural look.

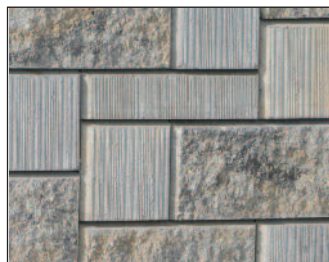

Multiple block shapes and textures.



Main Components

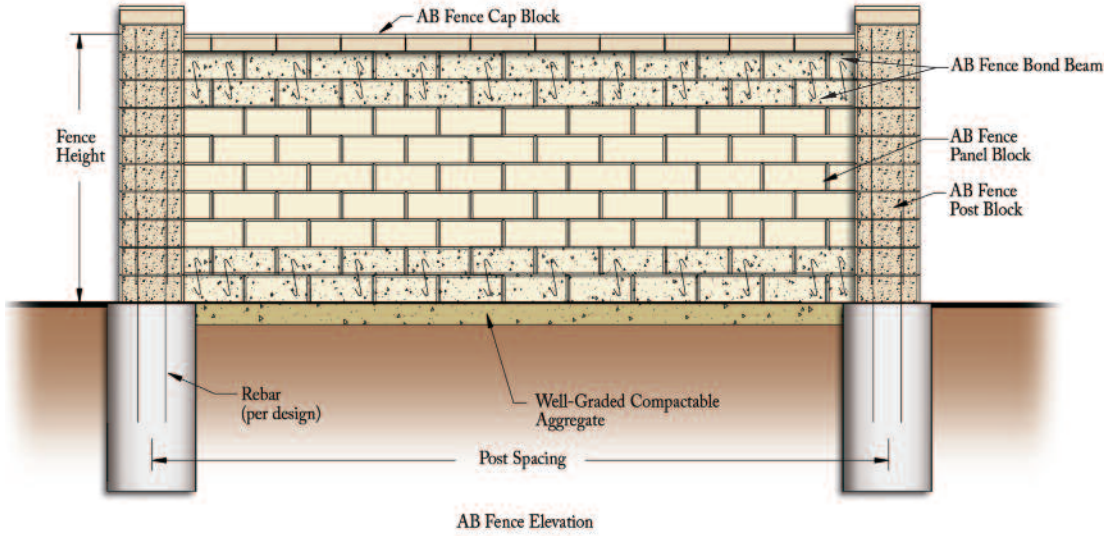

The AB Fence System uses posts and panels like many typical fence systems, but this system is different in its structural behavior than other panel walls systems. The unique ball & socket configuration creates a semi rigid structure due to the interlock of the dry stack AB Fence Panel Blocks, with the bond beam and the dry stack together resist the wind load. The dry stacked panels dissipates some force itself in this unique system such that the force on the Post is reduced.

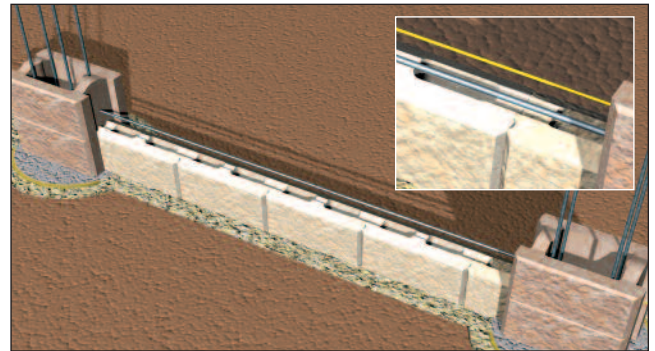

Typical AB Fence Section

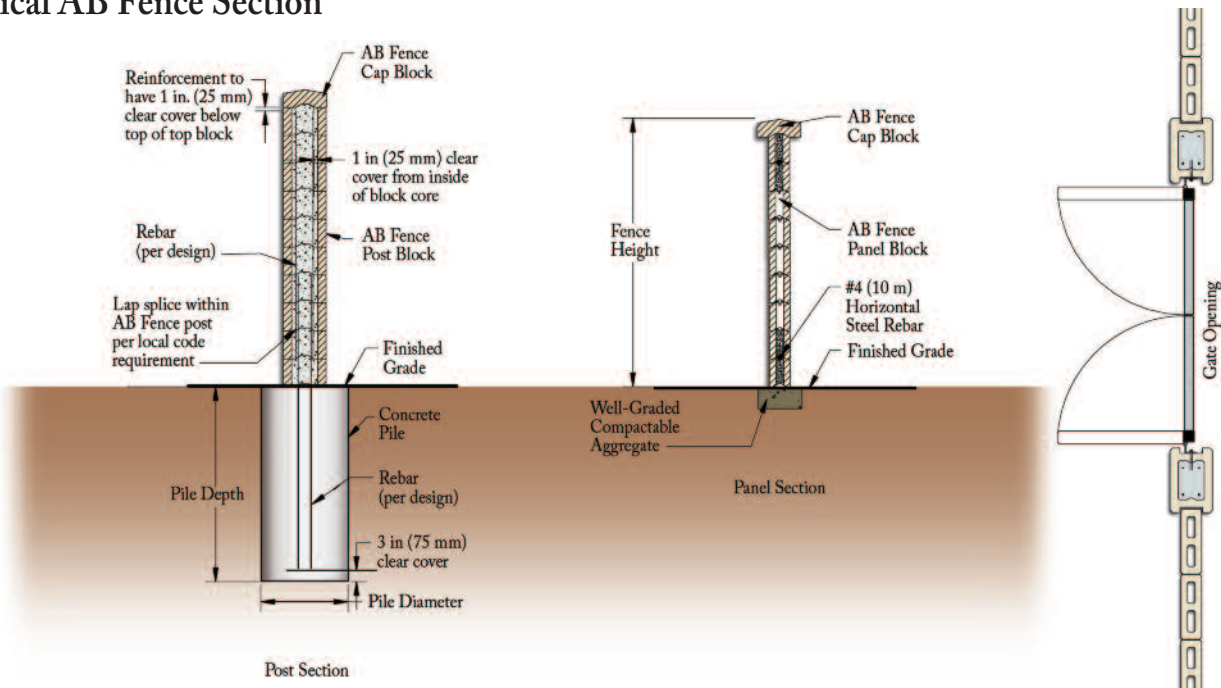

AB Fieldstone® Collection

The Unique AB Fieldstone is a wall system which has a natural stone appearance coupled with Anchoring units to give you gravity retaining walls up to 8 feet (2.4 m) of fills, without reinforcing steel or Geogrids!! Engineering Wonder, Easy to Build, and Elegance Par Excellence.



812 facing units with SAU & LAU



824 facing unit with SAU & LAU



Retaining Walls

AB Fieldstone's two-piece system is quick and easy to install. On a prepared base, install and level the facing units the length of the wall, then install all the anchoring units by sliding them together. On additional courses the rear lip on the back of the anchoring unit locks the blocks together. Block cores and behind the blocks are then filled with wall rock per the full installation instruction. See the AB Installation manuals at allanblock.com.

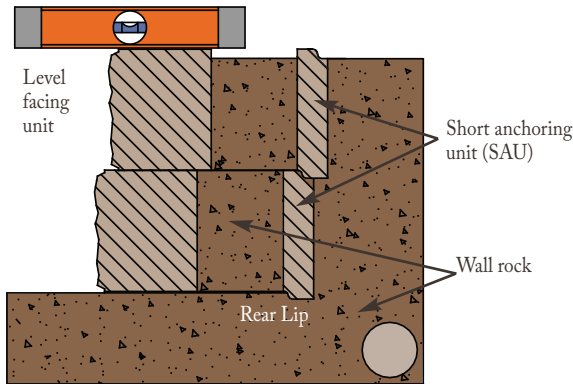
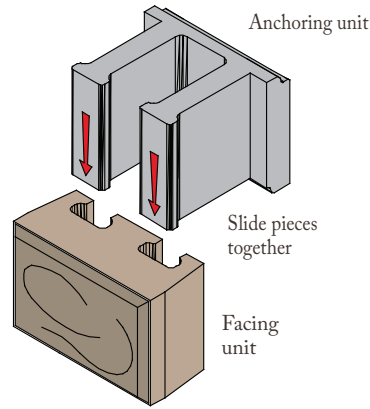

The anchoring units should never be installed higher than the facing unit and should be reasonably level.

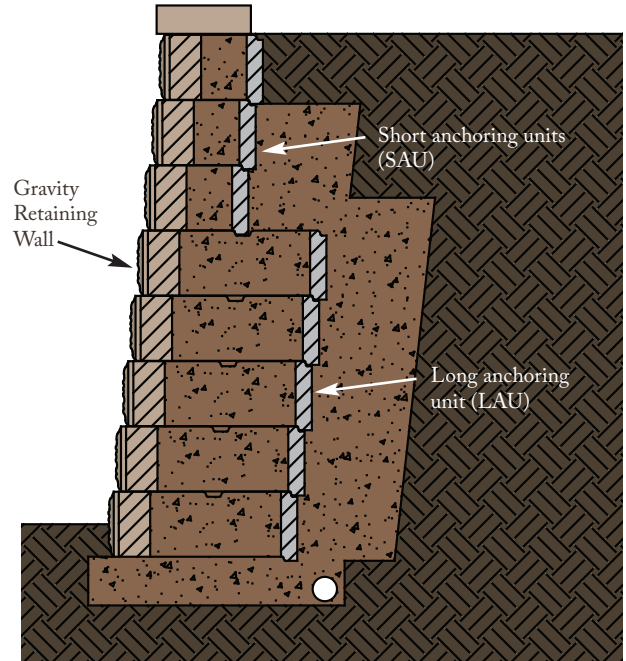

Parapets

The AB Fieldstone Collection can build beautiful retaining wall structures and is versatile enough with its two-piece design to build free-standing parapets. Using the same product for the retaining wall as well as to finish with a seamless transition into a parapet has never been easier. Parapets can also be built on an existing surface as well.

Parapets are constructed using the 812 and 824 facing units along with the AB Dogbone units. AB Dogbone units are half the height of the facing units with two units needed per facing unit for installation. We recommend installing one at the bottom and one at the top of the facing unit with wall rock in between in a staggered fashion.

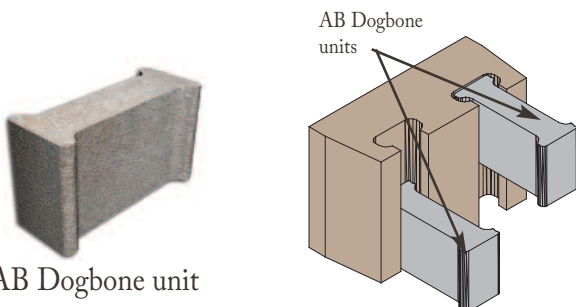
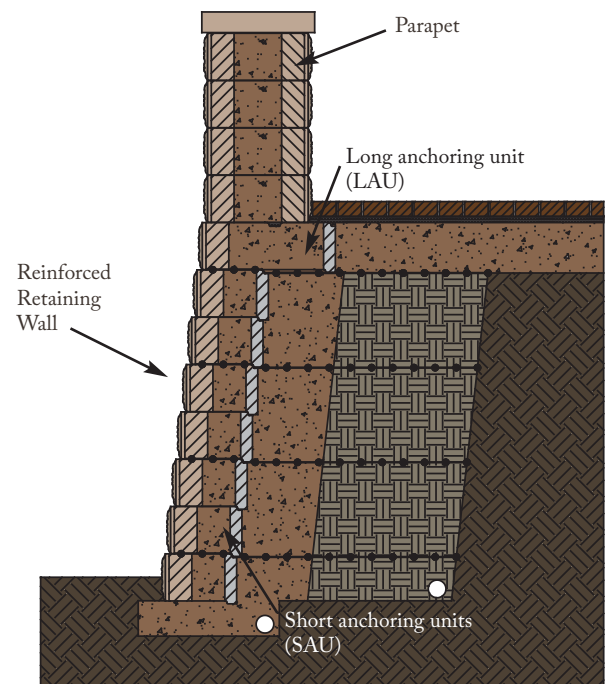

AB Courtyard Collection®



The AB Courtyard Collection is a durable, versatile and a cost-effective way to bring value into your landscaping. This two-sided free standing wall system's unique design can be used in many different applications. Create outdoor spaces that are comfortable yet elegant for entertaining. Incorporate custom gates, counter tops, natural stone or pavers as beautiful accents for even more style.



The AB Courtyard Collection is a two-sided free standing patio wall system that has three main components plus caps - AB Dublin, AB York and a Corner Block. Cutting of some of the blocks at designed places on the block is easy and could be done when necessary.

AB Dublin Block

AB York Block

Corner Block

Wall Cap

Post Cap



The AB Dublin Block is an angled block available with left or right sloping angles. There are two raised rings on the top of the block, these interlock the blocks together so adhesive is not needed. Used for straight walls.

The AB York Block is a tapered block, with a long and a short side. There is one raised ring on the top of the block. Used for curved and straight walls.

The Corner Block is an angled block. The block has no designated top or bottom; flipping it over creates the opposite angle. Used for corners and posts.

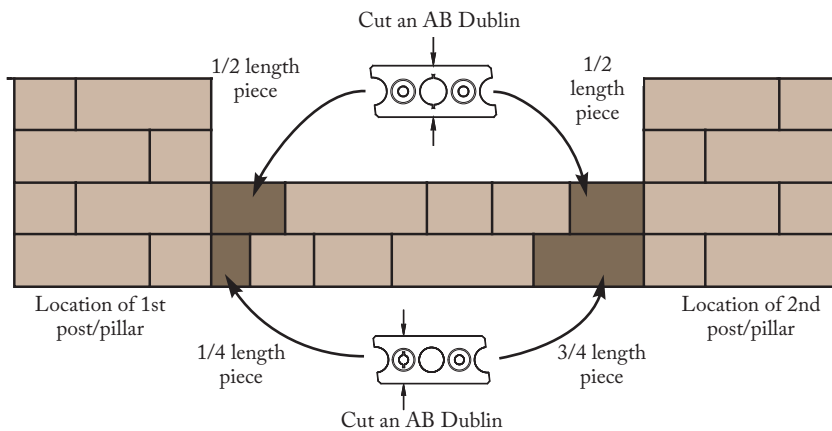

Patio Walls



AB Courtyard Collection of blocks stack together to easily create straight walls and curves. By cutting a few blocks you can create a straight side to the block. This straight side is needed when meeting up with a flat surface or when building curves within a wall panel. Some of the blocks are produced with pre-marked cutting notches for ease of locating the cut line, but any of the blocks can be modified.

Straight Walls

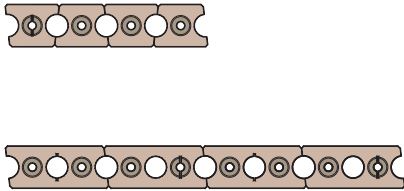

Posts and Panels

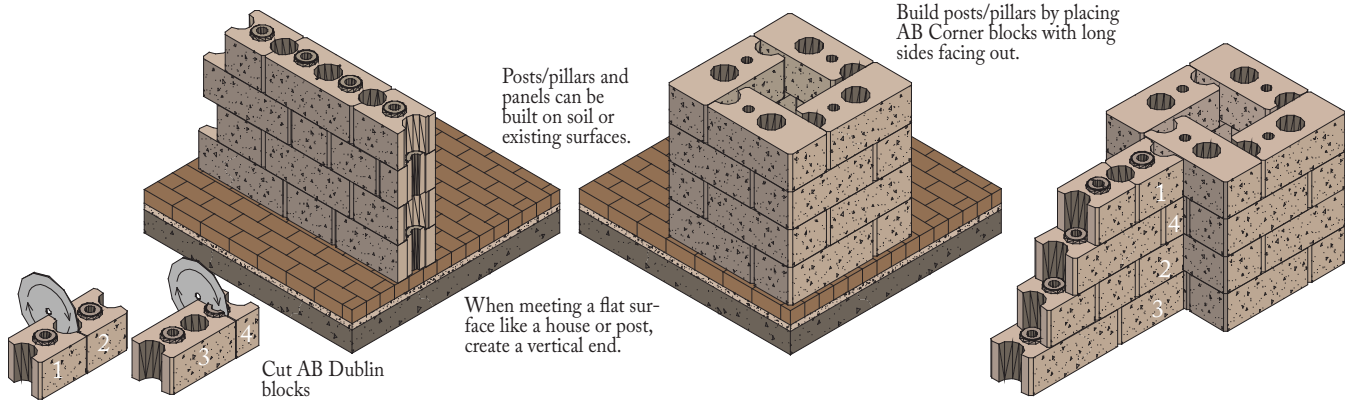

Corners

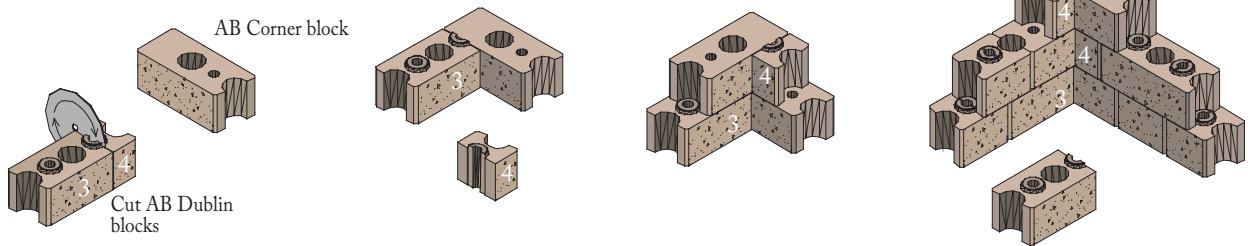

Curved Walls

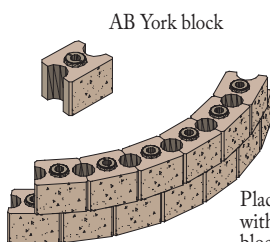

Place all AB York blocks with the short side of the block together to create simple curves.

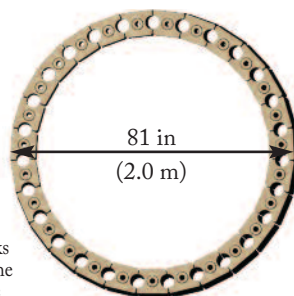

Larger radiuses can also be created using different block patterns.

AB® Collection



The Allan Block Collection gives you a choice of styles to meet your site and design requirements. Use the basic gravity wall system for smaller wall projects. For taller wall projects use geogrid to reinforce the wall, or consider optional techniques using masonry, no-fines, rock bolts, soil nails, or earth anchors.



AB Classic

AB Junior

AB Lite Stone



Patterned Walls

The design possibilities are endless. Use the blocks from the AB Collection individually or blend them together to create AB Ashlar Blend patterned wall. The modular, interlocking blocks easily fit together without any materials or tools.

Built-In Interlock

Every Allan Block is firmly locked in place by the patented lip and notch configuration. No pins, no mortar, no fancy connectors.

Built-In Setback

The raised lip automatically establishes the proper 6° setback.

Built-In Drainage

The hollow-core design combines with mortarless construction to allow water to drain freely from behind the wall. This built-in drainage helps to eliminate water pressure. Please note that this area is not to be used as a primary water management element.

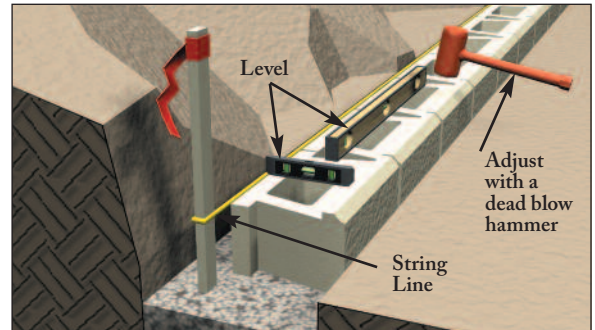

Level blocks, adjust where needed.

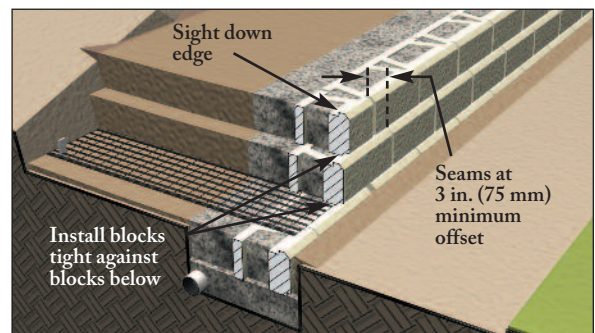

Install additional courses.

AB Geogrid Wall Typical Section

