

TIMBER ALTERNATIVE
sash windows



We're delighted to offer a suite of three stunning timber-alternative sash windows, designed and manufactured in the UK. They blend the charm of classic timber with the benefits of modern manufacturing techniques and materials, redefining tradition.

The result is a collection of timelessly stylish sash windows that keep your home secure, warm and quiet, all in a virtually maintenance-free package that never needs repainting.

First manufactured in 1985, each window in our collection has decades of experience and expertise built-in as standard. No matter which range or model you choose, every window precisely engineered using cutting-edge manufacturing technology, then expertly crafted and impeccably hand-finished.

Traditional style and elegance. Modern performance. No compromises.

Tradition Redefined.



Contents

Ultimate sash window	5
Heritage sash window	13
Charisma sash window	21
Comparison of models	28
Designed for you	32

QUITE SIMPLY, THE
UK'S MOST AUTHENTIC
TIMBER-ALTERNATIVE
SASH WINDOW



Ultimate sash window



Our Ultimate sash window



This is the epitome of our design philosophy – outstanding aesthetics and exceptional performance. Our Ultimate sash window is, quite simply, the UK’s most authentic timber-alternative sash window. It redefines tradition.

We’ve re-engineered the timber-alternative sash window from the ground up, looking at every seam and detail that differed from a timber original and designing it out. The ultra-slim 35mm meeting rail, the seamless run-through sash horns and even the internal sash interlock – everything has been redesigned to achieve what no other timber-alternative sash window can; a smooth, seamless finish. The result is that even from close up only an expert can tell that it’s not timber.

Based around an innovative true mechanical jointing system, Ultimate is built in exactly the same way as timber. There are no mitred welds or fake mechanical joints here, just simple, strong, joinery-style butt joints – horizontal on the frame and vertical on the sashes – just like a timber original.

The attention to detail matters.

But while it may look identical to traditional timber sash windows, the one place it’s designed to be different is in performance. ‘A’-rated energy efficiency, high security and independently tested sound insulation mean that not only will your home look great, it will be warm, quiet and secure.

Add all this together and you get a modern sash window that looks and performs better than anything else on the market.

That’s why we call it the Ultimate sash window.

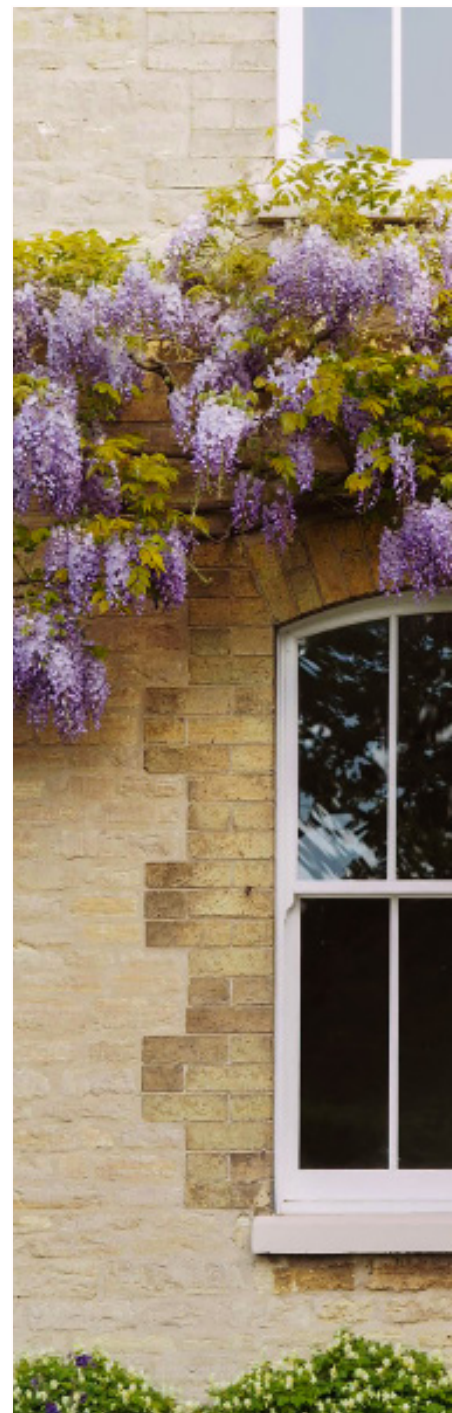
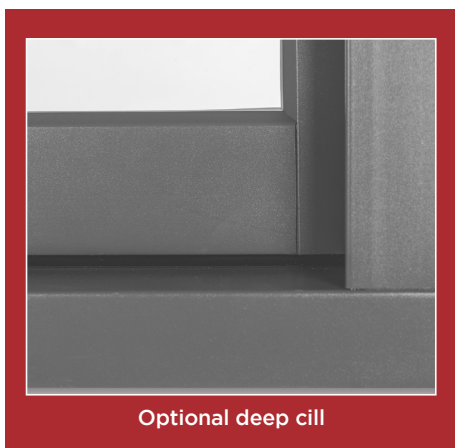
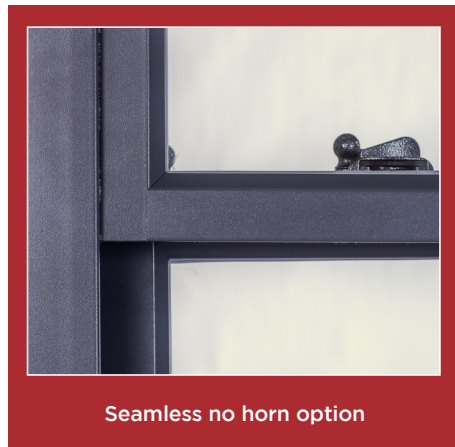
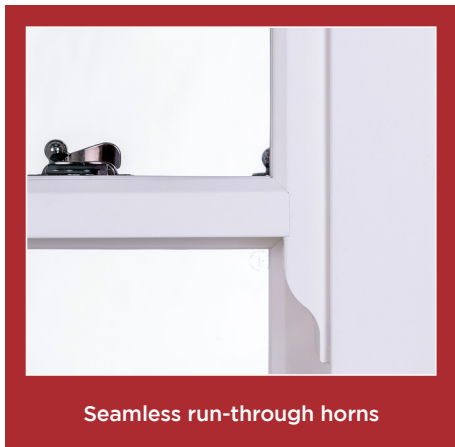



Ultimate sash window



- Closed-end true mechanical joints
- Ultra-slim 35mm seamless midrail
- Seamless run-through sash horns
- Slim putty-line external profiles
- Deep bottom rail
- Optional removable staff bead
- Aluminium-mounted authentic astragal bars
- Optional period deep cill
- Range of finishes and woodgrains
- Traditional globe furniture
(note: acorn furniture required for Part Q/PAS 24)
- Tilting sashes for simple cleaning
- Maintenance-free – no more painting
- Widely specified in conservation areas

Features



Out



In

Options

Colour Options

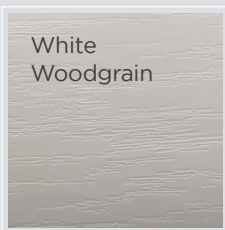

White Woodgrain



Crystal White

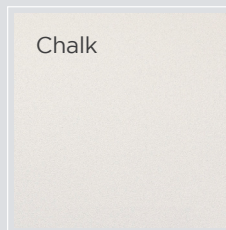

Chalk

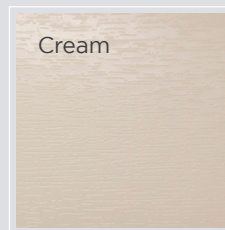

Cream

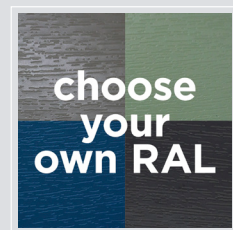

choose your own RAL

Hardware Options

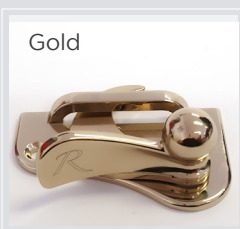

Gold

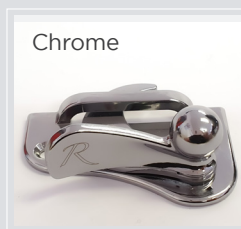

Chrome

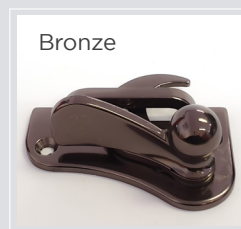

Bronze

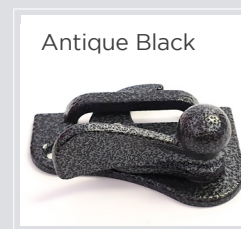

Antique Black



Satin

Ultimate sash window

Technical Details

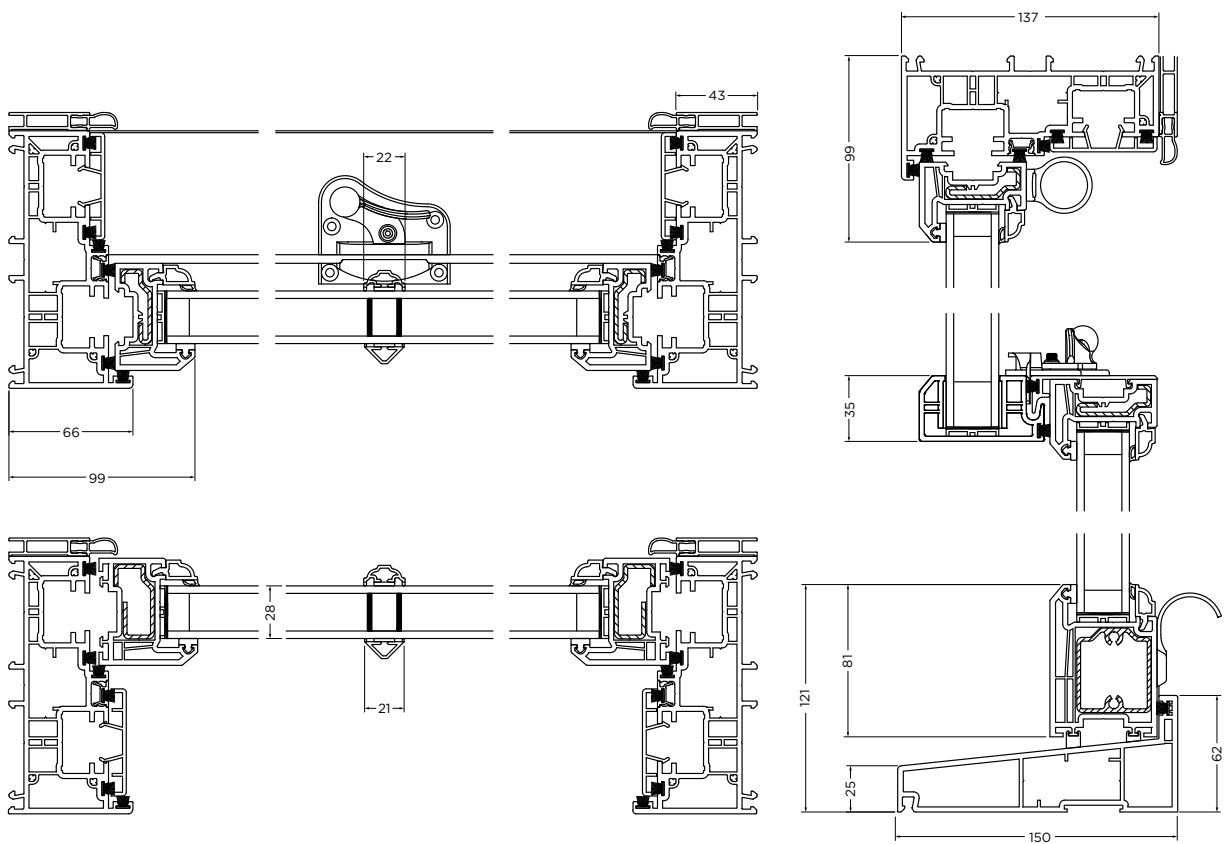

A Rated



Accoustics



PartQ/PAS24/SBD



Mechanical Joints



Seamless Horns

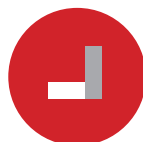

No Horn

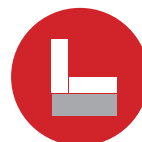

Deep Cill



Slim Mullion

Icons with borders are standard features. Ones without borders are options.

THE QUINTESSENTIAL
PERIOD SASH WINDOW,
UPDATED FOR THE
21ST CENTURY



Heritage sash window



Heritage sash window



Second only to our Ultimate model in terms of timber authenticity, the Heritage sash window is a classically styled sash window that delivers the convenience and all-round excellence of modern uPVC.

It uses the same slim, putty-line profiles as our Ultimate window, but includes a wider 44mm midrail and welded joints. It also features optional flat run-through horns, a deep bottom rail as standard and traditional chamfered astragal bars.

And while the Ultimate window is indistinguishable from timber even from close up, the period detailing and profiles on our Heritage model mean that from the pavement no-one will know that it isn't an original timber window.

As a result, our Heritage window has been used in conservation areas across the UK, including the Royal Borough of Kensington and Chelsea, Cambridge, Lincoln, Snowdonia and the Lake District.

Like every window in our collection it offers truly modern performance, keeping your home warm, quiet and secure.

Tradition is the watchword of the Heritage sash window.

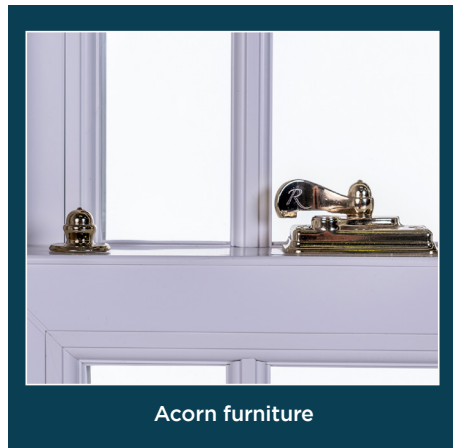
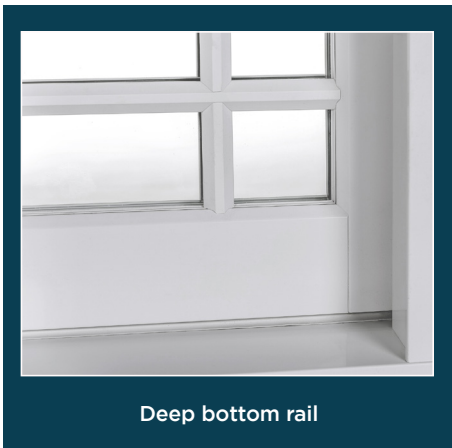



Heritage sash window



- Welded joints
- Slim 44mm midrail
- Optional flat faced run-through sash horns
- Slim putty-line external profiles
- Deep bottom rail
- Aluminium-mounted heritage astragal bars in a range of period designs
- Flush or protruding cills
- Range of finishes and woodgrains
- Classic acorn furniture
- Tilting sashes for simple cleaning
- Maintenance-free - no more painting

Features



Out



In

Options

Colour Options

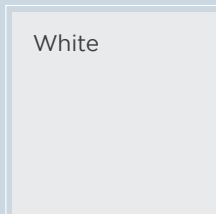

White

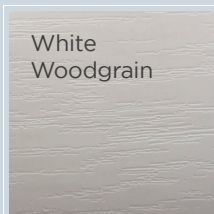

White Woodgrain



Crystal White

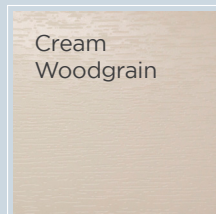

Cream Woodgrain

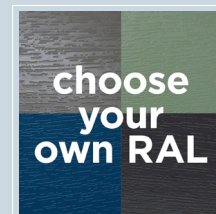

choose your own RAL

Hardware Options

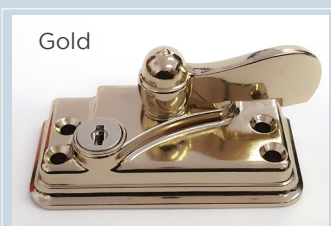

Gold

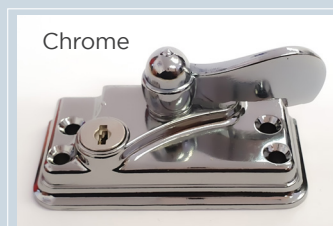

Chrome

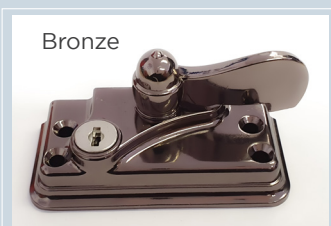

Bronze

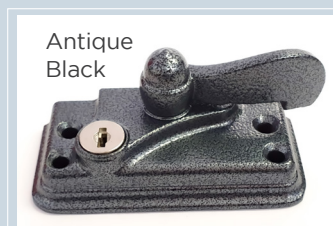

Antique Black



Satin

Heritage sash window

Technical Details

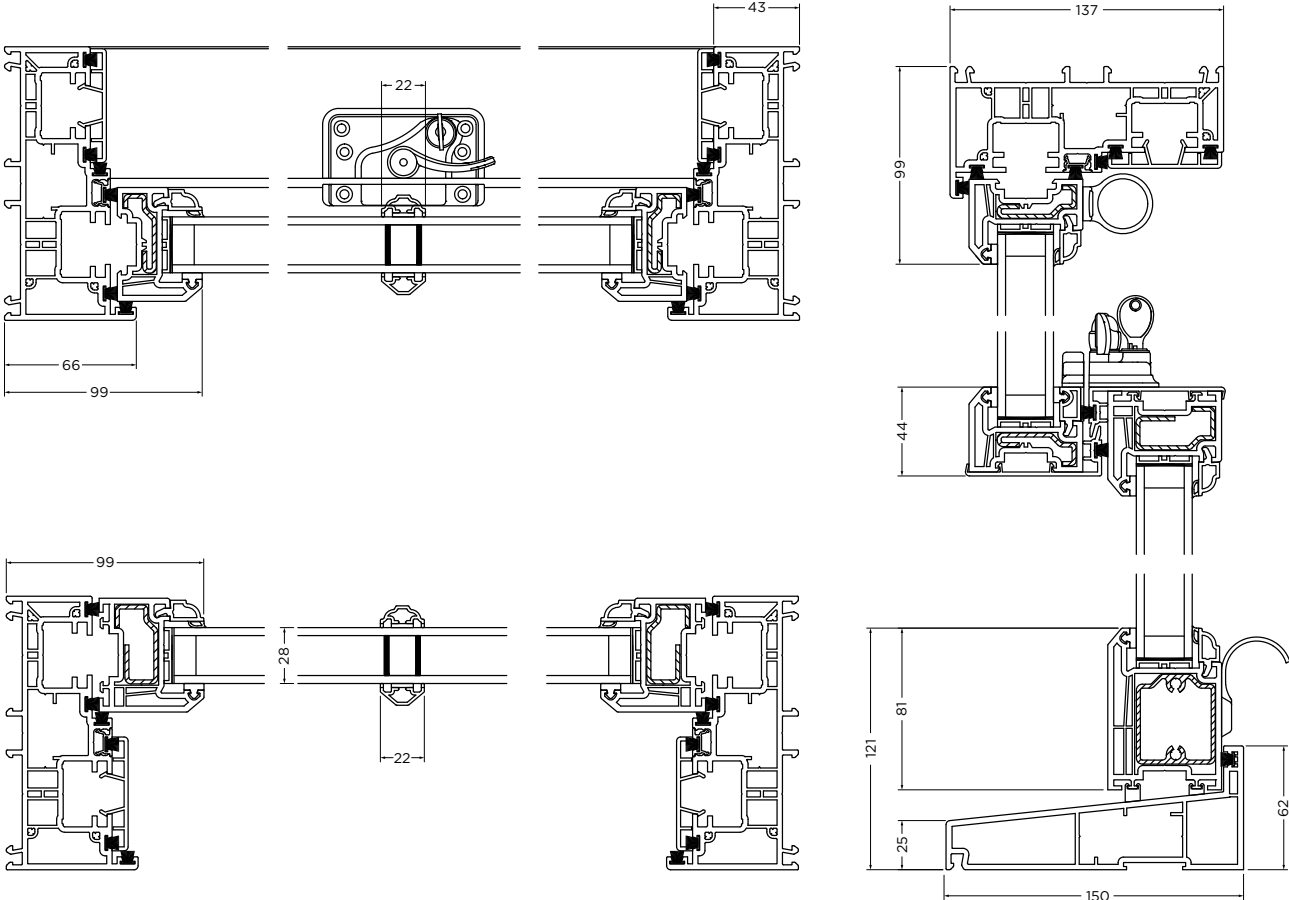

A Rated



Acoustics



Welded Joints



Polished Joints



Clip-on Horns



Flat Horns



No Horn



Slim Mullion

Icons with borders are standard features. Ones without borders are options.

COMPETITIVELY
PRICED PERIOD LOOKS
WITH A HOST OF
MODERN FEATURES



Charisma sash windows



The Charisma sash window



Take one of the most respected, competitively-priced uPVC systems on the market and turn it into a stylish timber-effect sash window – the result is our Charisma sash window.

With a bolder, more contemporary appearance than its siblings, Charisma is a versatile sash window ideally suited to everything from upgrading existing windows on older properties to adding retro-chic to newly built homes. And while it may be more budget-friendly than our other sash windows, it's still built with the care, attention, and high spec components that are a hallmark of everything we do.

Like all windows in our collection, the Charisma sash window is low-maintenance, easy to operate and comes with a wide range of options and finishes. Competitively priced, it's a great all-rounder that offers classic style with vintage details and modern performance.

Contemporary, classic and uniquely versatile.

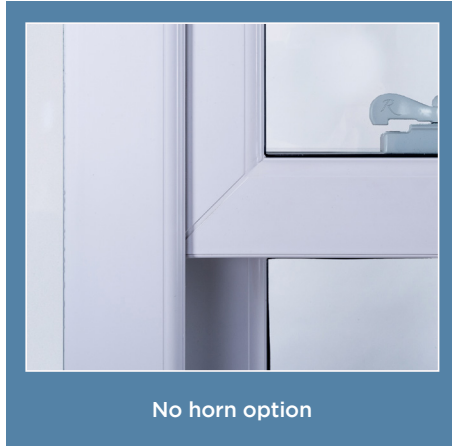
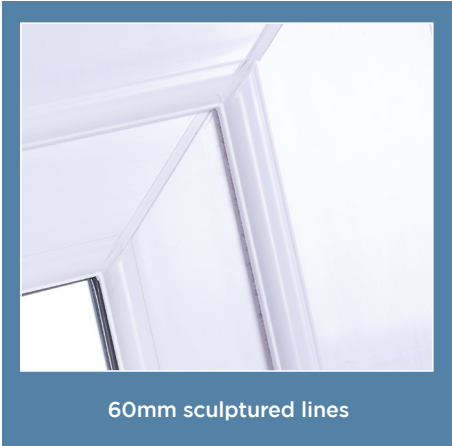



Charisma sash window



- Welded joints
- 60mm midrail
- Optional flat faced run-through sash horns
- Sculptured profiles
- Optional deep bottom rail
- Aluminium-mounted Geo astragal bars in a range of period designs
- Range of finishes and woodgrains
- Classic acorn furniture
- Tilting sashes for simple cleaning
- Maintenance-free – no more painting



Features



Out

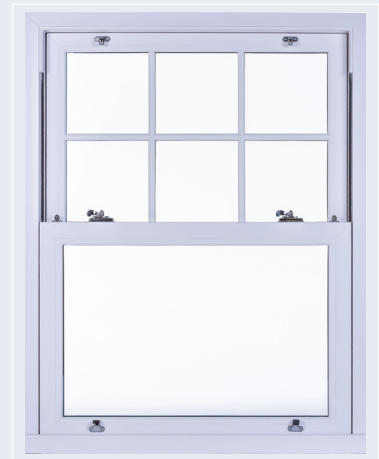

In

Options

Colour Options

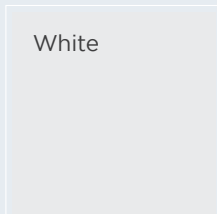

White

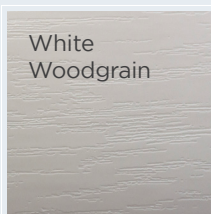

White Woodgrain

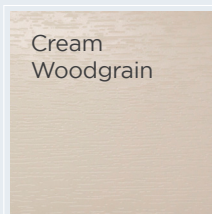

Cream Woodgrain

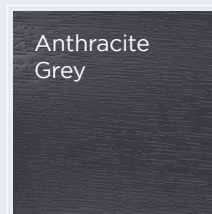

Anthracite Grey

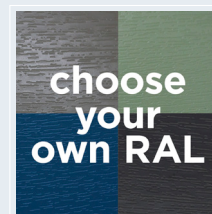

choose your own RAL

Hardware Options

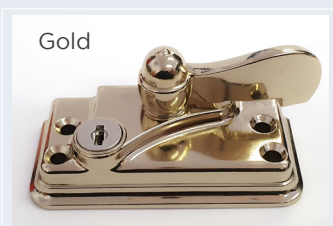

Gold

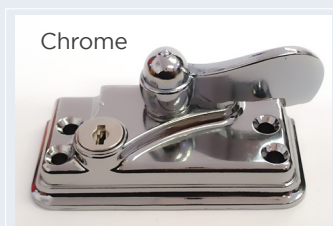

Chrome

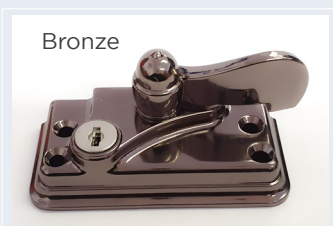

Bronze

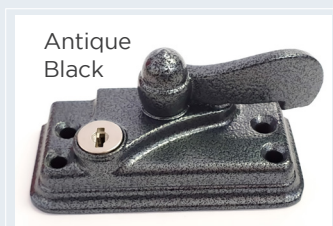

Antique Black



Satin

Charisma sash window

Technical Details

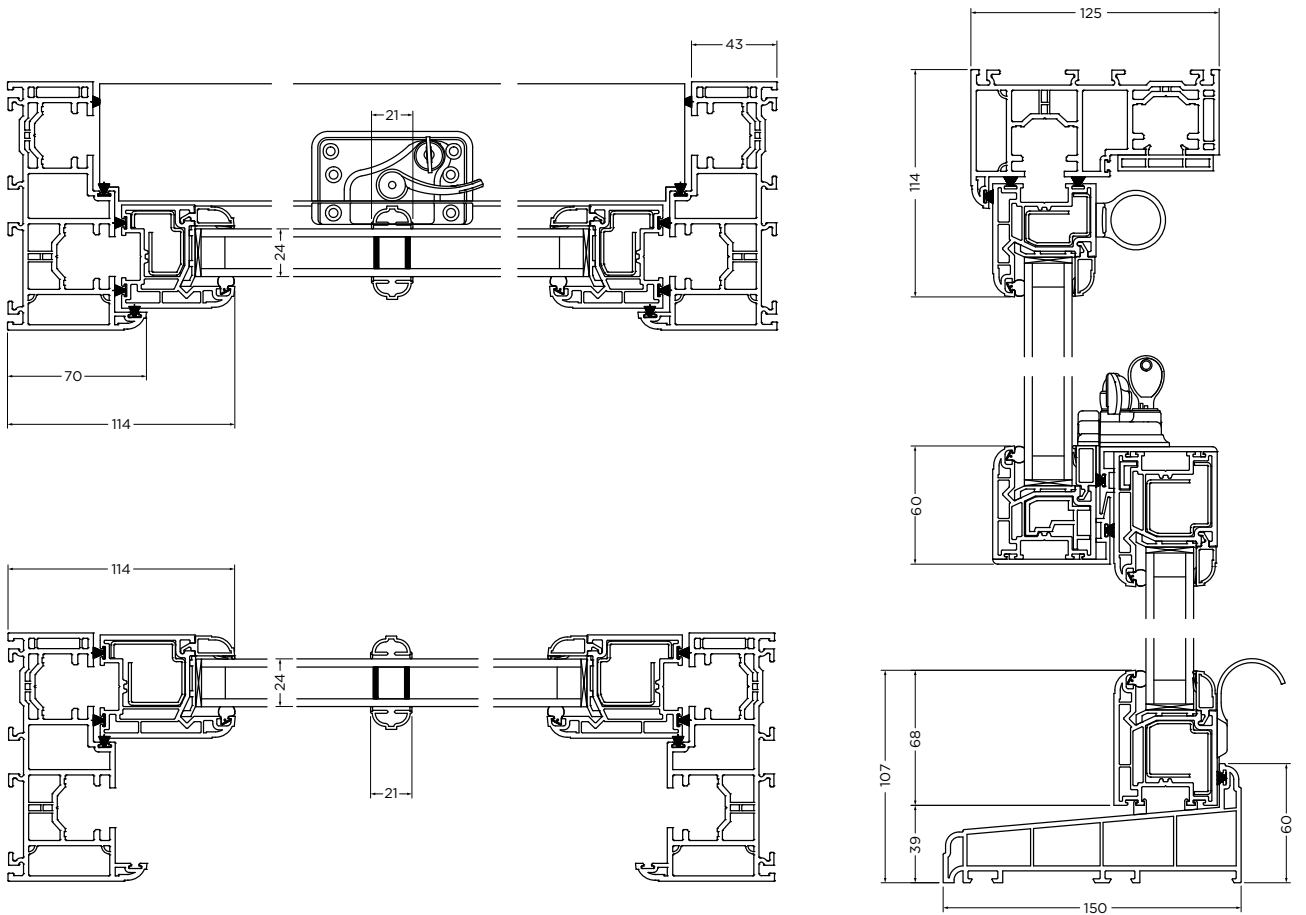

A Rated



PartQ/PAS24/SBD



Acoustics



Welded Joints



Clip-on Horns



Flat Horns

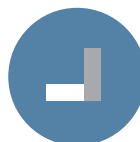

No Horn

Icons with borders are standard features. Ones without borders are options.

Comparison of Models

All our sash windows deliver unbeatable authenticity and exceptional performance. But as a range they're also hugely versatile, offering options that suit a diverse array of properties, budgets and applications.

The Collection consists of three core sash windows – Ultimate, Heritage and Charisma. While each model has elements that make it unique, all three have some things in common:

- Available with or without sash horns
- 'A'-rated energy efficiency
- Upgradable acoustic protection
- Optional Secured by Design/ PAS24/Part Q security upgrade
- Available with arched or shaped heads
- Can be colour-bonded with any RAL colour
- Available in multi-part combinations and bays

Ultimate



- Profile detail:** putty line
- Meeting rail:** 35mm seamless
- Run-through horn:** seamless
- No Horn:** seamless (option)
- Corner detail:** true mechanical
- Deep bottom rail:** standard
- Deep cill:** option
- Astragal bars:** authentic
- Furniture:** globe
- Removable staff bead:** option
- Energy rating:** A-rated
- Part Q/PAS24/SBD:** option

Heritage



- Profile detail:** putty line
- Meeting rail:** 44mm
- Run-through horn:** flat (option)
- No horn:** option
- Corner detail:** welded
- Deep bottom rail:** standard
- Deep cill:** not available
- Astragal bars:** heritage
- Furniture:** acorn
- Removable staff bead:** not available
- Energy rating:** A-rated
- Part Q/PAS24/SBD:** option

Charisma



- Profile detail:** sculptured
- Meeting rail:** 60mm
- Run-through horn:** flat (option)
- No horn:** option
- Corner detail:** welded
- Deep bottom rail:** option
- Deep cill:** not available
- Astragal bars:** geo
- Furniture:** acorn
- Removable staff bead:** not available
- Energy rating:** A-rated
- Part Q/PAS24/SBD:** option



**THE
CALIFORNIA**

MORE THAN 30 YEARS
OF KNOWLEDGE,
EXPERIENCE & DESIGN
GOES INTO EVERY
SASH WINDOW
WE MAKE



Designed for you



Combine more than 30 years of sash window experience with industry-leading design, engineering and attention to detail, and you start to see why Rose Collection windows stand out from the crowd. The same amount of effort goes into every window we make, no matter which model you choose.

But more than that, we pride ourselves in doing everything we can to tailor our windows to your needs. No matter how complex or individual your specific requirements, if it's possible, we'll work out how to do it.

From curved and Gothic arches to bespoke astragal bar and glass designs, there isn't much we haven't seen before. The features shown on this page are just some of the ways in which we can help make your vision a reality.

Astragal bar designs



Many other designs are available - please ask for more details.

Arches & shapes

Although most sash windows are rectangular, arched and shaped heads are more popular than you may think. From gentle curves and fully semi-circular true arches, to pointed gothic arches and straight angled heads, we can manufacture your sash windows to virtually any shape you require.



Bay windows

Stone, brick or bay poles. Square or flared. Two, three, four or more parts. With our help you can achieve any bay configuration you require with a combination of sash windows.



Slim mullion combinations

On Ultimate and Heritage Rose, as well as coupling windows together we can offer slim mullion combinations, narrowing the vertical coupling to give a more traditional appearance.





© 2021. The content of this document, photographic reproduction and technical details remain the sole property of Roseview Windows, all rights reserved. It cannot be reproduced, in whole or in part, without explicit permission. Terms and conditions of sale apply, a copy of which is available on request.



