

PRINTBRAIN
knows
Displays

2019
Display Catalogue



Printbrain
knows
Displays.

DISPLAY PRODUCTS

MILAN

Milan FlatWall	5
Milan Curve Wall	5
Milan Arc Wall	6
Milan Shapes	6
Milan Table Top	6

FABRIC MURAL & POP UP

Fabric Mural	7
TradeWind	8

BANNER STANDS

Mistral	9
Scirocco	10
Zephyr	11
QuickStand	12
Spirit	13

D4 DISPLAYS

D4 Standard	14
D4 Wave	14
D4 Linked	15

COUNTERS

Demo Counter	16
Milan Podium	17
Blizzard Counter	18

FLAG

Breeze	19
--------	----

ACCESSORIES

LITERATURE RACKS

Vision Displays	20
-----------------	----

CASES & BAGS

Slimline Case	21
D4 Rotomoulded Wheeled Case	22
Half Oval Case	22
Full Oval Case	22
Case Wrap	22
Milan Travel Bag	23
D4 Travel Bag	23
D4 "D" Bag	23
Graphic Case	23

LIGHTS

LED Milan Light	24
Snap Light	24
D4 Light Kit (Single)	24
D4 Light Kit (Twin)	24

A PRESTIGIOUS BACKWALL SYSTEM

The **Milan** is a lightweight modular aluminum frame system that integrates with large format photo-realistic printed fabric graphics. Displays can be straight, horizontally or vertically curved to create impressive seamless graphic walls. The perfect solution for marketing and communications at your next retail store window, tradeshow, exhibition or event.

Features

- ▶ Portable and assembles in under 8 minutes
- ▶ Modular design allows for a wide range of size options & is convertible to other sizes
- ▶ Single and double-sided graphics available
- ▶ Precision engineered lightweight components
- ▶ Simple push button connectors for fast assembly
- ▶ Custom solutions available
- ▶ Made from recycled materials

Accessories

- ▶ Your choice of counters
- ▶ Powerful LED lights equivalent to 150 W halogen output
- ▶ Travel bags
- ▶ Rotomoulded Slimline Case
- ▶ Case-to-counter conversion kit available



Custom sizes available

FLATWALL

8ft. FlatWall
Dimensions: 88" x 88"
Weight: 27 lbs

10ft. FlatWall
Dimensions: 115" x 88"
Weight: 29 lbs

20ft. FlatWall
Dimensions: 229" x 88"
Weight: 39 lbs

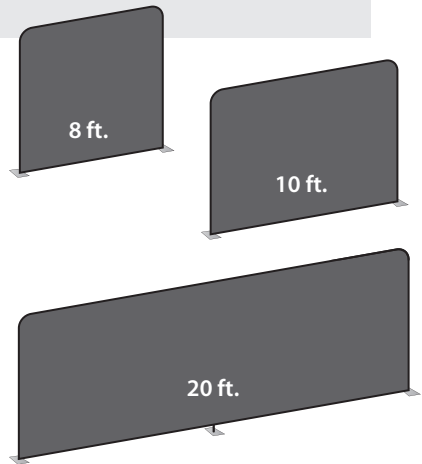

CURVE

8ft. Curve
Dimensions: 94" x 88"
Weight: 27 lbs

10ft. Curve
Dimensions: 114" x 88"
Weight: 29 lbs

20ft. Serpentine
Dimensions: 228" x 88"
Weight: 48 lbs

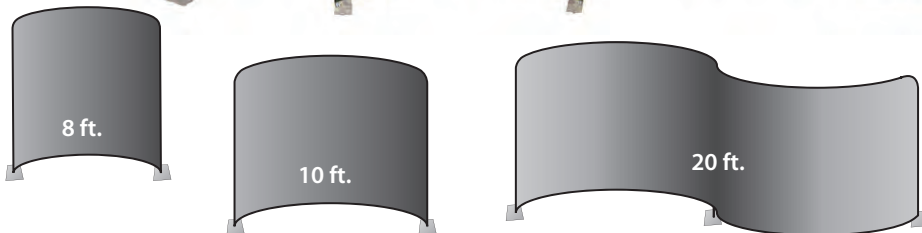



ARC

8 ft. Arc

Dimensions: 88"x 97.5"

Weight: 27 lbs

10 ft. Arc

Dimensions: 115"x 97.5"

Weight: 29 lbs

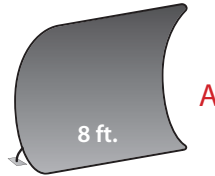

A

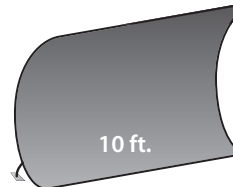

10 ft.

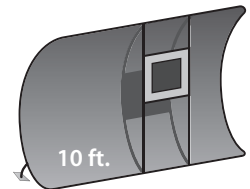

10 ft.

B

5 Style Options

- A. 8 ft. / 10 ft. Arc
- B. 10 ft. Arc + Lightscreen
- C. 10 ft. Arc + Walkthrough
- D. 10 ft. Arc + Kiosk
- E. 10 ft. Arc + Elipse

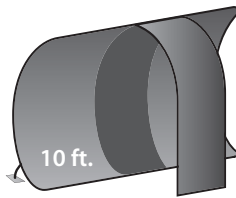

10 ft.

C

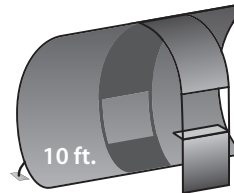

10 ft.

D

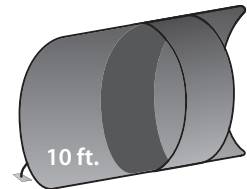

10 ft.

E

SHAPES

8 ft. Shape

A. & B. . Dimensions: 94"x 88"

C. & D. Dimensions: 88"x 88"

10 ft. Shape

A. & B. Dimensions: 114"x 88"

C. & D. Dimensions: 115"x 88"

Custom sizes available

4 Style Options

- A. Curve w. Curve Top
- B. Curve w. Sloping Top
- C. FlatWall w. Wave Top
- D. Star

Custom styles available

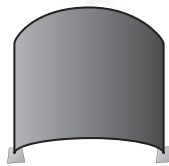

A

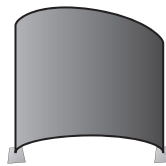

B

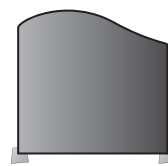

C

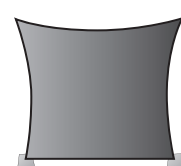

D

TABLE TOP

FlatWall Table Top

Dimensions:

5 ft. 60"x 36" (12 Lbs) / 60" x 48" (14Lbs)

6 ft. 72"x 36" / 74" x 48"

Curve Table Top

Dimensions:

5 ft. 62"x 36" / 62" x 48"

6 ft. 74"x 36" / 74" x 48"



A

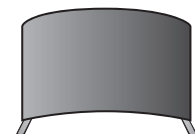

B

2 Style Options

- A. FlatWall Table Top
- B. Curve Table Top



BIG IMPRESSION IN A SNAP

The **Fabric Mural** Stretch Fabric Graphic comes with loop Velcro sewn around the perimeter that attaches to the hook Velcro on the frame. When the frame is unfolded the graphic stretches smooth. This billboard-in-a-bag folds away into a soft carry bag. Perfect for trade shows, new product launches, event marketing or virtually anywhere you need to make a big statement.

- ▶ Lightweight for easy transport
- ▶ Graphic stays on even when folded down
- ▶ Simple and fast assembly
- ▶ Cost effective
- ▶ Big exposure



4x3

3x3 w Side Panels



Curved 3x3 w Side Panels

FABRIC MURAL

Graphic Sizes (Straight):

- 3 x 3: 88.5" x 88.5"
- 4 x 3: 117" x 88.5"

Graphic Sizes (Curved):

- 3 x 3: 80" x 88"
- 4 x 3: 106" x 88"

Side Panel: 12.5" wide

EASY TRAVEL OPTIONS

Half Oval Case



Full Oval Case

Nylon Bag

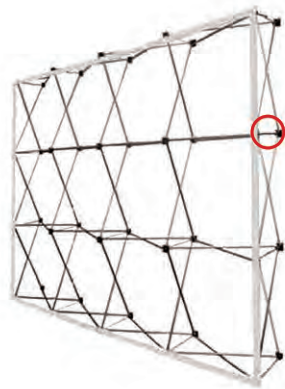

Interlock the hooks to ensure the stability of the structure.

EASY TO CHANGE GRAPHICS

With Velcro-fastened graphics, changing your message could not be easier.

1



2

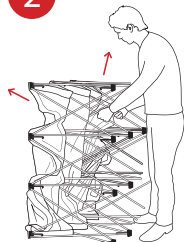

3

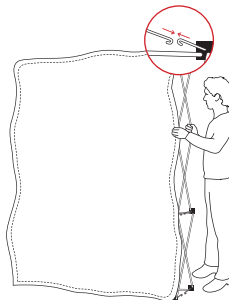

4

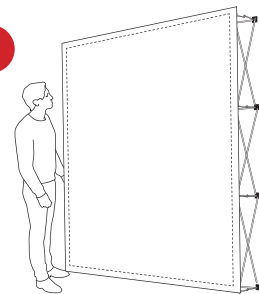

FLEXIBLE IMAGING SYSTEMS

The **TradeWind** system leads the way in portable displays. This multi-panel tension fabric display offers exhibitors virtually limitless possibilities. **TradeWind** allows you to create a **3-D environment** with front to back graphics for a stunning visual impact.

TradeWind is a lightweight system, which maximizes versatility and visual impact. Its sleek, compact design and quick set-up make **TradeWind** a revolutionary advancement in the display industry.

Place a shelf on one of the sections and **TradeWind** not only highlights your message but also shows off your lighter-weight products.



3x3



MAGNETIC SOLUTION

Magnetic connector extrusions on middle hubs will engage opposing hubs to lock frame in expanded position.



4x3

TRADE WIND

Dimensions:

2 x 2:	59.5" x 59.5"	6 lbs
2 x 3:	59.5" x 88.5"	8 lbs
3 x 3:	88.5" x 88.5"	12 lbs
4 x 3:	117.5" x 88.5"	18 lbs*

* Weight is shown as frame weight

Graphic Sizes:

1 x 1:	29.25" x 29.25"
1 x 2:	29.25" x 58.5"
1 x 3:	29.25" x 87.75"

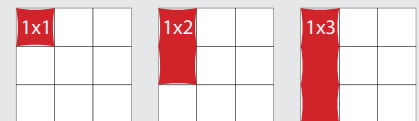

2 x 2:	58.5" x 58.5"
2 x 3:	58.5" x 87.75"

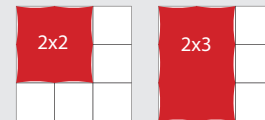

Small Diamond:	41.375" x 41.375"
Large Diamond:	58.5" x 58.5"

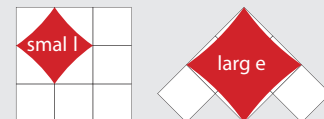

EASY TRAVEL OPTIONS

Half Oval Case



Full Oval Case

Nylon Bag



EASY COME. EASY GO

The **Mistral** roll-up banner stand is cleverly compact and convenient. Its ease of set-up, portability and economical design make the **Mistral** an industry standard for exhibit, retail and professional environments.

- ▶ Sets up in seconds
- ▶ Lightweight
- ▶ Stable base

MISTRAL

Width:
33.5"

Heights:
79" or 86"

Packed Weights:
7 lbs or 9 lbs

* Packed weight incl. graphics & bag



EASY TRAVEL

Comes with a compact and durable bag equipped with a shoulder strap.

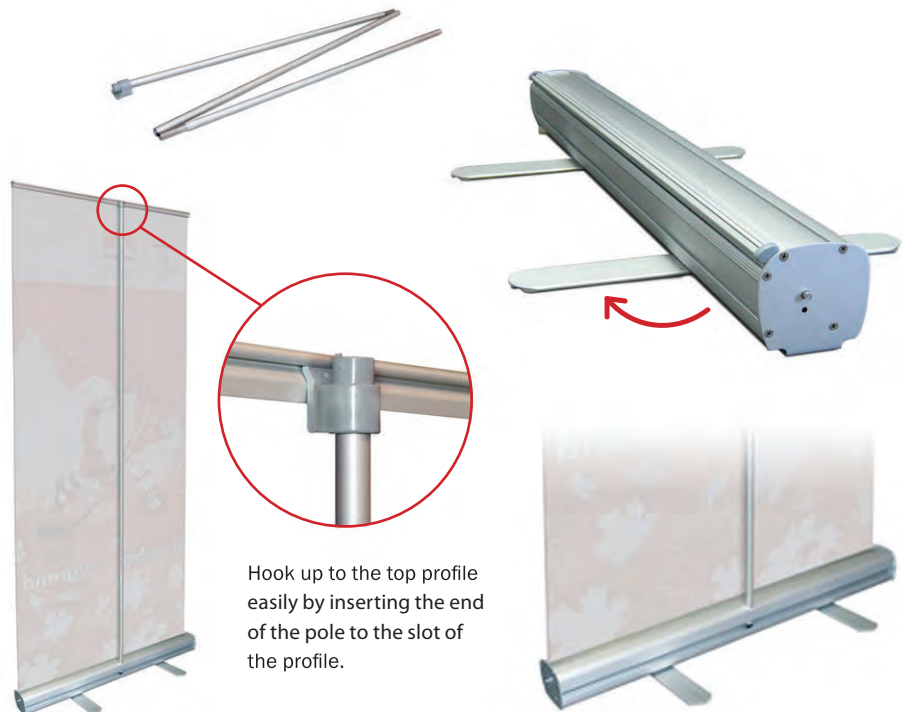

SIMPLY STYLISH

The **Scirocco** roll-up banner stand has a distinctive shape and is easily set up. It is often referred to as a retractable that is simply stylish. A great way to differentiate the look of your tradeshow booth, store or any space you wish.

SCIROCCO

Width:
33.5"

Heights:
79" or 86"

Packed Weights:
11.3 lbs or 13 lbs

* Packed weight incl. graphics,
bag & box

- ▶ Modern appearance
- ▶ Sets up in seconds
- ▶ Stable base



EASY TRAVEL

Comes with a compact and durable bag equipped with a shoulder strap.

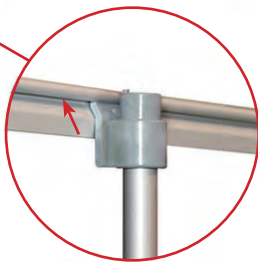

Hook up to the top profile easily by inserting the end of the pole to the slot of the profile.

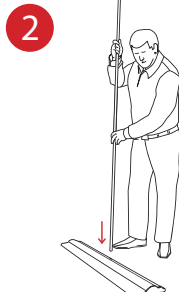

ROLL UP WITH STYLE AND GRACE

One of the most graceful and convenient retractable banner stands on the market. **Zephyr** has a conservative design, with a compact cassette to protect the graphic and a discreet foot; it lets the message stand out.



- ▶ The most graceful roll-up system on the market - a **RedDot Design Award** winner
- ▶ More branding - minimal hardware visibility
- ▶ Adjustable height
- ▶ Easy snap profile for attaching graphics



ZEPHYR

Widths:

33.5", 39.4", 49.25" or 59"

Adjustable Heights:

62.5" - 88"

Packed Weights:

9.9 lbs - 16.1 lbs

* Packed weight incl. graphics, bag & box



EASY TRAVEL

Comes with an attractive and durable bag equipped with a shoulder strap.



The materials have been carefully chosen to make the unit light, smart and easy to use.

1

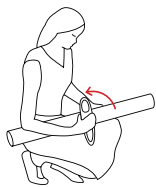

2

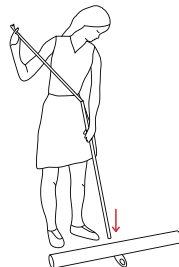

3

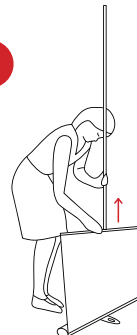

4

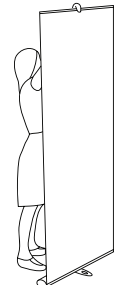

TRAVEL IN STYLE

The **QuickStand** is a **Non-Retractable** banner stand designed with simplicity and portability in mind. It travels well, making it perfect for all levels of marketing. Graphics are easily changed making this a great lightweight banner with heavy impact.

- ▶ Velcro graphics make it easy to exchange on the fly
- ▶ Simple to install
- ▶ Lightweight
- ▶ Telescopic pole to accommodate various heights



TOP BAR



BASE



QUICKSTAND

Width:

35"

Height:

48" - 88"

EASY TRAVEL

Comes with an attractive and durable bag equipped with a shoulder strap.



1

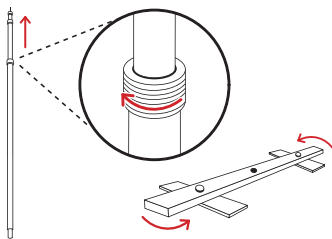

2

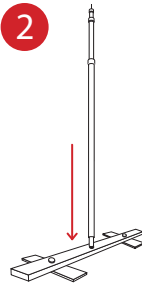

3

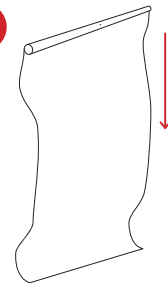

4

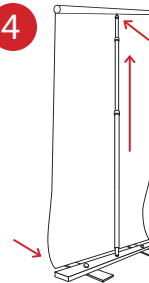

5

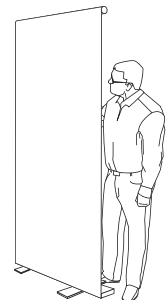

GO CLEAN. GO GREEN

The **Spirit** banner stand is one of the most environmentally friendly display solutions on the market. Made from managed-growth Bamboo, this free-standing banner display is extremely lightweight and versatile. Simple and quick graphic changes also make it ideal for use in exhibit and retail environments.

SPIRIT

Widths:
23.375"

Heights:
69.375"

Packed Weights:
3.25 lbs

* Packed weight incl. graphics,
bag & box

- ▶ Environmentally friendly
- ▶ Lightweight
- ▶ Easy set-up



EASY TRAVEL

Comes with an eco-friendly bag
with a Velcro closure.



FAST AND EASY SET UP

Simply place banner grommets on
each corner hook of the stand.

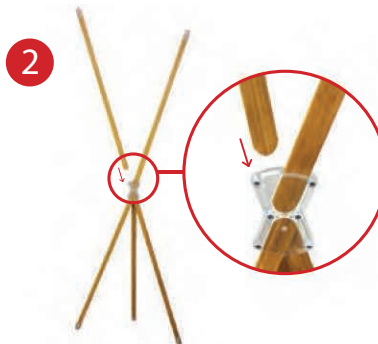

VERSATILE DISPLAY SYSTEMS

The **D4** is a free-standing portable banner system available in a wide range of graphic sizes. With a choice of either straight or curved banners, Displays can be used individually, in groups, or linked together to create graphic walls. The ideal choice for marketing and communications at exhibitions, conferences and events.

Features

- ▶ Portable and assembles in under 3 minutes
- ▶ Simple, elegant design in various size options
- ▶ Single and double-sided graphics available
- ▶ Displays are stable and can be left worry-free
- ▶ Combines high-strength material with precision engineering
- ▶ Integrated light system

D4 STANDARD

Standard displays come in two widths. **D4.6** is 24" wide, **D4.8** is 32" wide. The **D4.6** and **D4.8** come in three height options.

2 Standard Widths:

- | | |
|---|---|
| D4.6 T: 24"x 42" Weight: 10.2 lbs. | D4.8 S: 32"x 72" Weight: 16.8 lbs. |
| D4.6: 24"x 72" Weight: 11.0 lbs. | D4.8: 32"x 79" Weight: 17.0 lbs. |
| D4.6 E: 24"x 79" Weight: 12.0 lbs. | * Weight is shown by packed weight |

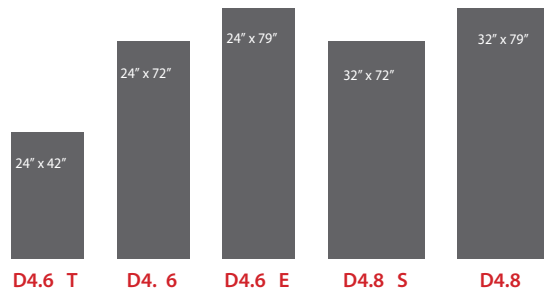

Banner Options

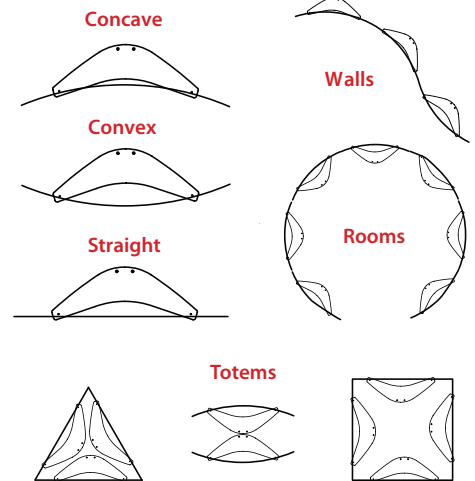

D4 WAVE

A simple pair of curved aluminum bars can create both concave and convex displays. Use multiple units to create graphic walls and a variety of shapes.

2 Standard Widths:

- | | |
|---|------------------|
| D4.6: 39"x 72" Weight: 10.5 lbs. | 39" x 72" |
| D4.6 E: 39"x 79" Weight: 12.4 lbs. | 39" x 79" |
| D4.8 S: 48"x 72" Weight: 17.2 lbs. | 48" x 72" |
| D4.8: 48"x 79" Weight: 20.1 lbs. | 48" x 79" |

* Weight is shown by packed weight

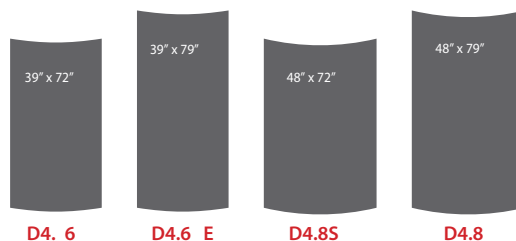

FLEXIBLE. PRACTICAL. STYLISH.

Several different models can be linked to create a stylish grouping. Connect standard **D4** displays together using 24", 32" or 48" banners. All linking banners are 1" longer at the top and bottom to accommodate the linking cross ties attached above and below the side banners.

D4 LINKED

4 Standard Widths:

D4.6-T6: 70"x 44" Weight: 18.0 lbs.

D4.6-T8: 81"x 44" Weight: 18.2 lbs.

D4.8-L8: 94"x 79" Weight: 41.5 lbs.

D4.8-L8: 114"x 79" Weight: 42.0 lbs.

* Weight is shown by packed weight

Accessories

- ▶ 50 W LV Single or Twin **D4** Light Kit
 - 60 degree beam with UV filter
- ▶ Travel bags
- ▶ Rotomoulded cases



D4.8 Travel Bag
37" w x 14" h x 6" d
Weight: 4.0 lbs.

Rotomoulded Wheeled Case
16" w x 52" h x 15" d
Weight: 13.0 lbs.



D4.6 Travel Bag
32" w x 10" h x 6" d
Weight: 2.0 lbs.

Graphic Case
51" w x 4" h x 4" d
Weight: 2.0 lbs.

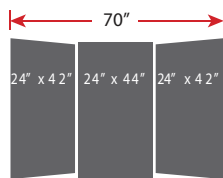

D4.6-T6
6 ft. Table Top Display

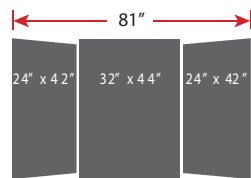

D4.6-T8
7 ft. Table Top Display

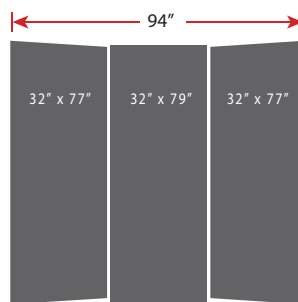

D4.8-L8
8 ft. Booth Display

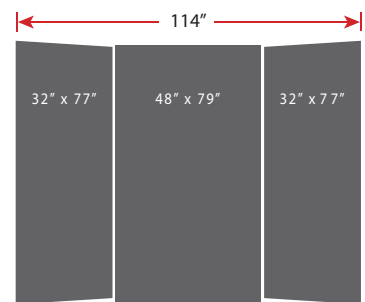

D4.8-L10
10 ft. Booth Display

SHOW OFF YOUR PRODUCTS

The **Demo Counter** is an attractive curved portable reception, demo and in-store sampling counter designed for easy set up and low transport cost. The **Demo Counter** comes complete with body panel, rigid counter top, base shelf, poles, header panel and light weight carry bag. All of the above packs into a single shipping carton and weighs less than 24 lbs.

Made from high quality materials the **Demo Counter** is available in black or white as standard. The **Demo Counter** can also be produced in custom colours when required in larger quantities.



DEMO COUNTER

With Poles & Header:

31" w x 87" h x 24" d
Weight: 23 lbs. (includes bag)

Counter Only:

31.25" w x 35.5" h x 24" d
Weight: 17 lbs. (includes bag)

Load Bearing Capacity: 75 lbs.

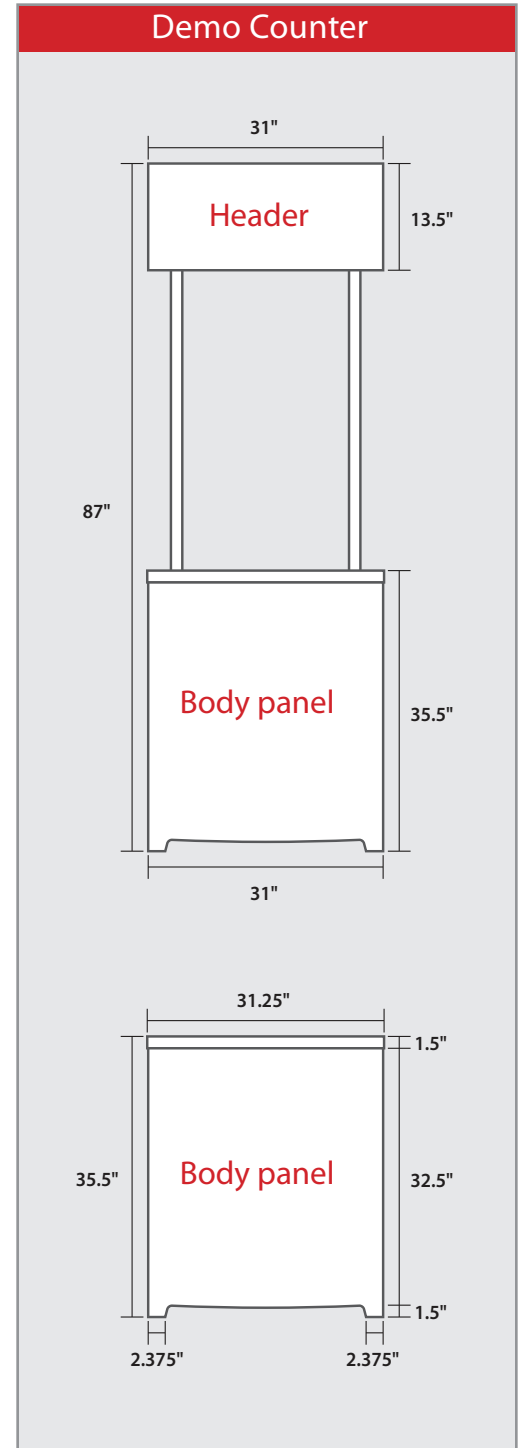

EASY TRAVEL OPTION

A nylon bag equipped with a shoulder strap is included with the counter.



ADD STYLE TO YOUR DISPLAY

The **Milan Podium** is wrapped with a seamless full-colour printed fabric graphic and comes in a variety of shapes. Made from lightweight aluminum with push-button connections, it is extremely strong with a load capability of up to 200 lbs.

Units have zippered access at back for storage of briefcases, purses or show materials.

Cable management for iPads and monitors is an option upon request.

MILAN PODIUM



D-Shaped

Dimensions: 30" w x 39" h x 15" d
Weight: 15 lbs
Load Bearing Capacity: up to 200 lbs



Rectangular

Dimensions: 22" w x 38" h x 14" d
Weight: 11.2 lbs
Load Bearing Capacity: up to 125 lbs



Tapered

Dimensions: 22" w x 38" h x 14" d
Weight: 11.2 lbs
Load Bearing Capacity: up to 125 lbs



The fabric wrap simply connects with rear zippers.

Features

- ▶ Lightweight
- ▶ Wrinkle-free Poly Flex fabric
- ▶ Quick set-up
- ▶ Bottom internal shelf
- ▶ Optional cable management

CONVENIENT AND POWERFUL

The **Blizzard Counter** is the practical starting point for all marketing activities. The printed fabric wraps around the front and sides of the frame. At the back there is access to one shelf which is ideal for storing brochures and personal items. Combine with your choice of any of our displays for a full showcase solution.



- ▶ Fabric graphic matches fabric backwall displays
- ▶ Lightweight and easy set-up
- ▶ Solid grey counter top
- ▶ Internal shelf provides storage
- ▶ Optional wheeled transport bag



BLIZZARD COUNTER

Dimensions:
41.75" w x 40" h x 15.75" d
(includes side panels)

Packed Weight:
35 lbs

* Packed weight incl. graphics & bag



EASY TRAVEL

Optional wheeled travel bag equipped with a pop-up handle and shoulder strap.

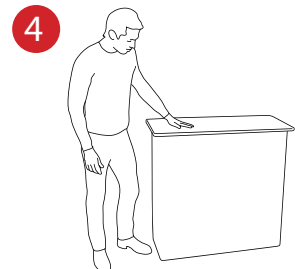
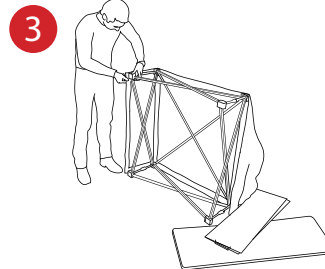
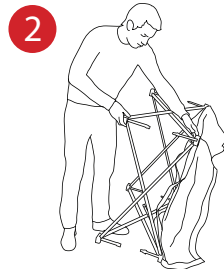
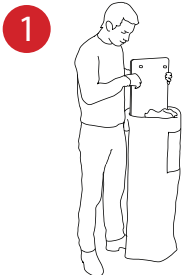

GO WITH THE WIND

Promote your business indoors & outdoors with **Breeze** displays. Built to last and withstand outdoor weather while advertising your brand message and attracting crowds. We offer two sizes of our **Breeze** display with base options to suit your needs.

The perfect solution for promotional events, shopping malls, retail store environments, exhibitions and more.



BREEZE

Small:

Flag Size: 1.8' w x 4.3' h

Height Above Ground: 5.2'

Large:

Flag Size: 3.6' w x 8.7' h

Height Above Ground: 11'



EASY TRAVEL

With the display comes a durable bag equipped with a shoulder strap.

CROSS BASE (incl. bearing)

- ▶ Size: 23.3" x 23.3"
- ▶ Weight: 3.1 lbs
- ▶ Collapsible steel cross base
- ▶ Indoor / Outdoor

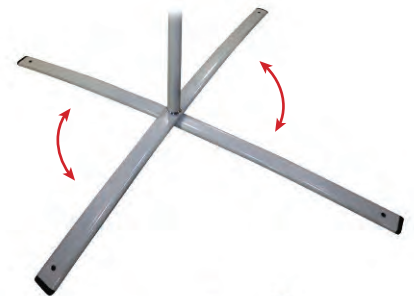

WEIGHT BAG (Accessory)

- ▶ Diameter: 19.5"
- ▶ Weight: 0.41 lbs; 20 lbs (water)
- ▶ Plastic, fill with water or sand
- ▶ Used for extra weight for base



GROUND STAKE (incl. bearing)

- ▶ Size: 2.4" x 23.6"
- ▶ Weight: 2.2 lbs
- ▶ For outdoor use

SMART BROCHURE HOLDER

The **Vision Display** is a free-standing system that can combine together with brochure holders or poster display components to meet your specific needs. A Stylish way of presenting your marketing messages.

Vision Display Poster Holders can also be wall-mounted or suspended using stand-offs or cable tension kits. Standard sizes available are 16" x 21" and 21" x 27".

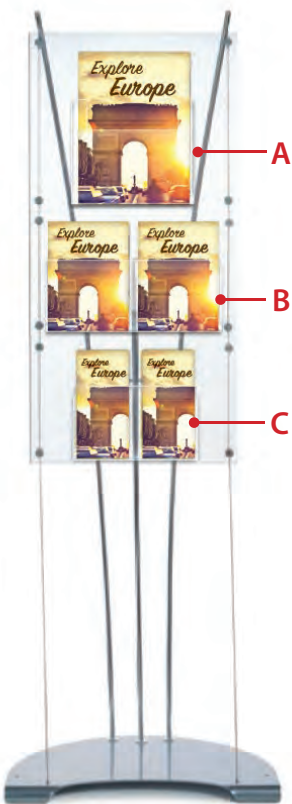

APPLICATIONS

NARROW CABLE POSITION

Thread the two tension cables through the inner holes in the base plate.

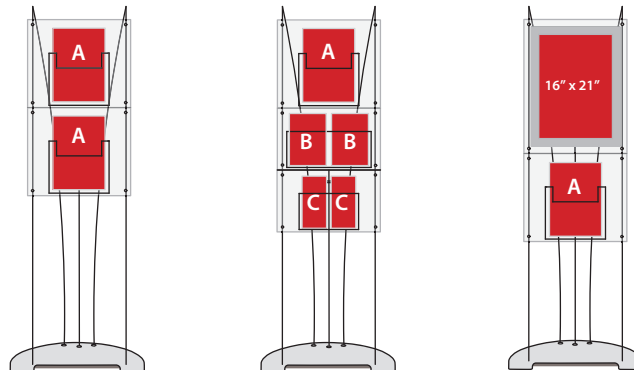

Our dispensers will accommodate marketing materials of various sizes:

A. Brochure Holder

Pocket Size: 9" w x 8" h
Max. Content Height: 12"

B. CD/Postcard Holder

Pocket Size: 6" w x 5.5" h
Max. Content Height: 9"

C. Tri-fold Flyer Holder

Pocket Size: 4.5" w x 5.5" h
Max. Content Height: 9"

WIDE CABLE POSITION

Thread the two tension cables through the outer holes in the base plate.

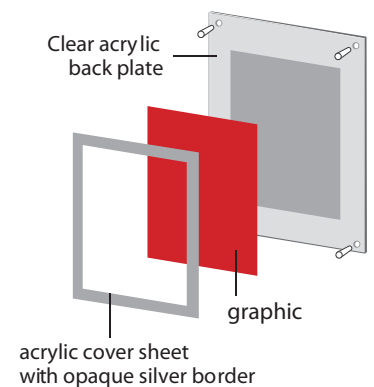
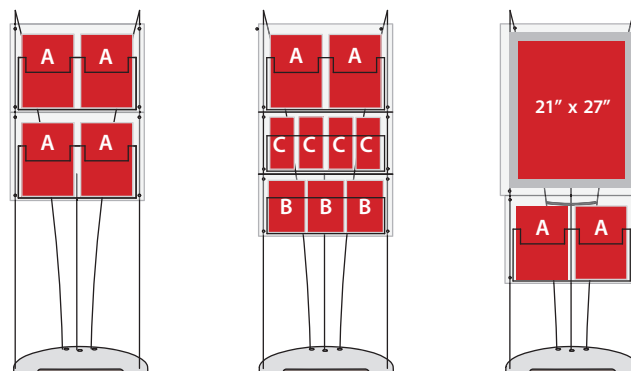

TRANSPORT YOUR DISPLAY EASILY

We offer a wide range of case options designed to suit each of our display systems. From reusable **shipping cartons** made of 100% recycled materials, to reinforced **travel bags** and heavy duty **rotomoulded cases** with wheels; all of our cases are durable and lightweight to help reduce the carbon imprint of transporting your displays from event to event.

Custom bags are available upon request.

CASES & BAGS



SLIMLINE CASE

Dimensions: 24" w x 31" h x 5" d
Weight: 13.7 lbs



Max. Quantity per Case

Milan Models:

- 1 Milan Flatwall 8 ft.
- 1 Milan Flatwall 10 ft.
- 1 Milan Flatwall 20 ft.
- 1 Milan Curve 8 ft.
- 1 Milan Curve 10 ft.
- 1 Milan Curve 20 ft. Serpentine
- 1 Milan Arc 8 ft.
- 1 Milan Arc 10 ft. + Lightscreen or Media Player
- 1 Milan Arc 10 ft. + Walkthrough
- 1 Milan Arc 10 ft. + Kiosk
- 1 Milan Arc 10 ft. + Elipse

D4 Displays:

- 4 D4.6T
- 4 D4.6
- 4 D4.6E
- 3 D4.8S
- 3 D4.8
- 2 D4.6-T6
- 2 D4.6-T8
- 1 D4.8-L8
- 3 D4.6 Wave
- 3 D4.6E Wave

- ▶ Wheels for easy transportation
- ▶ Adjustable straps for securing contents
- ▶ For Milan models, D4 Displays, and Digital & LED Displays

D4 ROTOMOULDED WHEELED CASE

Dimensions: 16"w x 52"h x 15"d
Weight: 13 lbs



- ▶ Wheels for easy transportation
- ▶ Strong handle for easy holding
- ▶ Secure latch locks



HALF OVAL CASE

Dimensions:
OD: 16.5"w x 34.5"h x 14.5"d
ID: 14.75"w x 34"h x 12"d
Weight: 10 lbs

- ▶ Wheels for easy transportation
- ▶ Secure latch locks
- ▶ For Fabric Mural and Pop Up Displays, such as Blizzard, TradeWind and Typhoon models

- ▶ Wheels for easy transportation
- ▶ Secure latch locks
- ▶ Accessories fit in the compartments of inside cover
- ▶ Can be wrapped with a graphic panel
- ▶ For Fabric Mural and Pop Up Displays, such as Blizzard, TradeWind and Milan models



FULL OVAL CASE

Dimensions:
OD: 23.875"w x 38"h x 15.5"d
ID: 22"w x 37.5"h x 14.5"d
Weight: 18 lbs

CASE WRAP

Wrap your case with graphics for an effective conveying of your message while transporting.



Max. Quantity per Case

D4 Displays:

4	D4.6T	2	D4.6-T6
4	D4.6	2	D4.6-T8
4	D4.6E	1	D4.8-L8
3	D4.8S	3	D4.6 Wave
3	D4.8	3	D4.6E Wave

MILAN TRAVEL BAG

Milan Travel Bag – Small

Dimensions: 31" w x 12" h x 12" d

Weight: 4.7 lbs

Milan Travel Bag – Large

Dimensions: 33" w x 18" h x 12" d

Weight: 5.6 lbs



- ▶ Black reinforced nylon bags with shoulder straps
- ▶ For Milan models, Fabric Mural and Pop Up Displays
- ▶ Custom sizes available

Max. Quantity per Case

Milan models (Small Travel Bag)

- 1 Milan Flatwall 8 ft.
- 1 Milan Flatwall 10 ft.
- 1 Milan Curve 8 ft.
- 1 Milan Curve 10 ft.
- 1 Milan Arc 8 ft.
- 1 Milan Arc 10 ft.

Milan models (Large Travel Bag)

- 1 Milan Flatwall 20 ft.
- 1 Milan Curve 20 ft. Serpentine
- 1 Milan Arc 10 ft. + Lightscreen or Media Player
- 1 Milan Arc 10 ft. + Walkthrough
- 1 Milan Arc 10 ft. + Kiosk
- 1 Milan Arc 10 ft. + Elipse

Max. Quantity per Case

D4.6 models:

- 2 D4.6T
- 2 D4.6
- 2 D4.6E
- 1 D4.6-T6
- 1 D4.6-T8

D4.8 models:

- 1 D4.8S
- 1 D4.8
- 1 D4.8S Wave
- 1 D4.8 Wave

D4 TRAVEL BAG

D4.6 Travel Bag

Dimensions:

32" w x 10" h x 6" d

Weight: 2 lbs

D4.8 Travel Bag

Dimensions:

37" w x 14" h x 6" d

Weight: 4 lbs



D4 TRAVEL BAG

Dimensions: 46" w x 23" h x 4" d

Weight: 2.75 lbs

- ▶ Reinforced nylon bag
- ▶ For Vision Lightscreen models and Vision Displays



D4 "D" BAG

Dimensions: 30" w x 14" h x 2" d

Weight: 2.75 lbs



Max. Quantity per Case

D4.6 models:

- 1 D4.6T
- 1 D4.6

GRAPHIC CASE

Dimensions: 51" w x 4" h x 4" d

Weight: 2 lbs



- ▶ Reinforced nylon bag
- ▶ For shipping graphic panels

BRIGHTEN YOUR MESSAGE

Printbrain has integral lighting kits for each of our display systems to ensure that your graphic messages and images are seen in the best possible light.

LED MILAN LIGHT

- ▶ 150W equivalent
- ▶ Cool to the touch
- ▶ Compliant with Vegas show rules
- ▶ On/Off switch
- ▶ Fits wide variety of systems
- ▶ Available in black or silver



D4 LIGHT KIT (Single)

- ▶ 50W LV – 55 degree beam with UV filter
- ▶ Suitable for D4 Displays

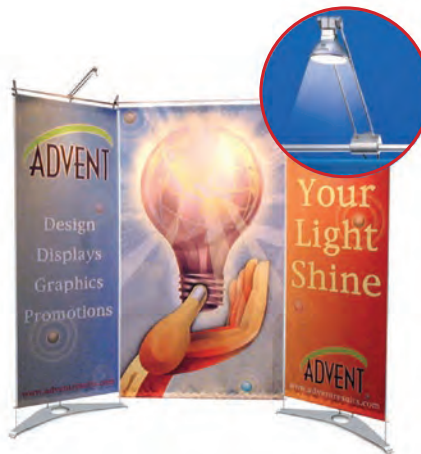

D4 LIGHT KIT (Twin)

- ▶ 50W LV – 55 degree beam with UV filter
- ▶ Suitable for D4 Displays





Printbrain
knows
Displays.

PRINTBRAIN

Call 416-304-1600
printbrain.ca info@printbrain.ca