

F. Shkrudnev

N. Levashov's
«SvetL Broom»
in A. Khatybov's
«Bath School»

Book 1. Unmasking the Hidden

Life goes on...



Feodor Shkrudnev

Life goes on...

**N. Levashov's «SvetL Broom» in
A. Khatybov's «Bath School» and
A Labour Spade**

**The continuation of the third volume of the
monograph «The Mirror of My Soul» not
completed by Nicolai Levashov**

**BOOK 1. Unmasking the Hidden
(intervention: how it happened)**

Translated from Russian by Alla Khabenskaya

Saint-Petersburg 2017

Foreword

The modern system of man's views once firmly settled and for quite a number of hundred years being polished is clearly reflected in the scientific way of looking at things. They are well-grounded, fundamental, and steadfast in the truth of their position – In a word – "**SCIENCE**". It's like **something that is unattainable for anyone and everyone**. It is not like some intricate craft, which, although being difficult at times, can be mastered by anyone to some extent, and therefore, it is quite real to get the title of master. Science is the lot of quite a few. It is necessary not only to have weighty intellectual resources, moreover, extended in some area to unconceivable dimensions, making it possible for you to judge things more confidently than anyone else. You also have to be scientifically minded so that you are able to save your face in a worthy manner in the circle of your kind. Well, and if you make some effort – it will give you the opportunity from the considerable height of your highly scientific intellectual statements to judge about the possibilities and achievements of both less experienced and eminent 'bison' scientists, fatherly suggesting a way to a new essential scientific research so far being noticed by no one. Scientific activities that are so much desirable and hardly ever easily attainable and only to a few worthy ones turn out to be very close, but for the majority it proves to be a true revelation at the beginning – what an ample scope to creative work!

How much of under-explored and under-investigated has the modern scientific school offered! How much good could one do to it with one's work! Experienced scientists in a majority take young scientists in their ranks with such tangible kindness and care suggesting and directing them in so hard, but fascinating scientific search. Although somewhat has been modified in the political and economic battles, the scientific school has still preserved for the true scientists the opportunities for their development in the form of grants, which are distributed according to the most promising trends for the development of science in general and its application in the national economy. It is true, there are some discrepancies, temporary or local difficulties, but they are only bumps on the way of formation and development of Science presenting itself as a kind of a monster, created with only one aim – to lead the humanity away from even the possibility of

perception the real picture of the world, having created and imposed upon everyone a false world outlook based on invented myths, and having provided these inventors with a halo of indisputability and inaccessibility in their scientific greatness – that is for the layman; and inside this hard-to-reach scientific community – to organize exactly the same parasitic conditions, as outside it.

Every ordinary scientific worker of a higher educational institution, research institute or any other organization that is a part of the Scientific System can not fail to see all of its unstable, but for some reason still being supported structure. Each of its participants comes across it and tries to exist somehow, or even to prosper, but in everyday hustle and bustle not all realize what each of them is part of. The problems of survival are not complicated and make you to be in a whirl – publications, scientific studies, dissertations, author’s abstracts, Higher Certification Committee, citation indexes, scientific projects, reports, check ups, titles and degrees – all these attributes of the scientific life got together are a simple and effective tool to manipulate a person, even if he is really intellectually developed and has an extraordinary mind. It is trivial, isn’t it – but for something more than “drawing up”, there is simply not enough time, energy, or desire. Alas, but Science, on the one hand, is a well- thought out and well-made trap for capable, purposeful and intelligent people, besides, aiming at not giving a chance for real development to anyone. And on the other hand, it is a cushy job in which, providing you have certain qualities of thinking, you can live your life without exerting yourself too much with comfort and pleasure relying on lower-ranking scientists and on legal grounds to use the results of their work (the concept ‘a wedding general ’ is a common expression with them). In the community of research workers everything turns out to be meaningless in the most basic sense of the word. If you are interested in doing research in many fields simultaneously, you will easily be convinced that this is futile and you will be turned into a narrow specialist who knows in detail the number of mandibles in some arthropods, but you will never think of the fact why your favorite, fostered and personally described subspecies bearing your name, and including 19 differing in the number of denticles and having the shape of the bristle morphs, generally exists on the Earth, and why it exists in these 19 morphs. If you examined the work of the supervisor and fundamentally disagree with his point of view **you will have to say goodbye to the defense of the thesis**; an eternal title of an assistant and, in most cases, quite a trial in search of a new scientific leader – that is your destiny for many years. Suppose you go your own way and

thanks to your intelligence, talent and diligence are able to maintain your opinion and even to defend your thesis. That is perfect. But this is the end. Be happy with your degree, so much wished for, your salary and general admiration. You are a part of the system and there is no way out.

I apologize to a reader for such a lengthy introduction, but I thought it is necessary to some extent **to throw light upon the present day science from my point of view.**

We certainly enthusiastically study and investigate with sincere interest behavior of gophers, imitones in nightingales' singing, nutrition of musk deer, finding some pleasure and satisfaction in it, and creating some imitation of some usefulness to the society. But all this is a complete nonsense and utter rubbish. Believe me, most of the work is done under certain requirements to get some "bonus" in the form of money, titles (meaning money), some articles (meaning, titles and then money), grants (again meaning money), and for a change – for some ambition. Everything, as in any other field, rests on getting some material goods. It is quite different in case of already received benefits or available initially. Or – if the Person is engaged in something far from what is called science. **For example, if he is "Dilettante in science..."**

Any view on the surrounding reality without any bias is a challenge, it is a blow to the Brain, and it is an attempt to get it out of the state of sustainability. On the one hand when there is a person who is offered all kinds of opportunities: he is told how this or that works, he is given facts, he is persuaded and praised when he accepts the proposal. For the person who once adopted a certain point of view it is very difficult to change it. For this there must be some itch to it, some patience, firmness of purpose, and some stimulus, which will help to leave the comfortable perch and look around. Then a person might see some fragment of reality and realize that his Science teachers are wrong. He will never come back, and might choose some others. But on the other hand – when the Science teacher must be taken out of the stability, that is that source of "true" world outlook, **who knows** what is right and what is wrong, **the one** who imposes one's prejudice on everyone, and who, in fact, has been created and nurtured by the system. It amounts to a refusal to ride in a comfortable car, moving on a flat road to a bright future, heading a column of vehicles and pedestrians, or to go on foot to the mountains, where rapid river streams knock you down, and where falling pieces of rock from the slopes fall down on your head, and the danger of loosing your footing deprives you of your mind; and the strangeness of the

surroundings makes it impossible to take a breath. No one will accept it on one's own free will – the road is hard, there is no pleasure to move on it, and the most important is that situation that there is no reason to start on a journey. The choice of any reasonable person in this situation is obvious, and it leads to nowhere – after all, - that abandoned comfortable modern car moving on a flat, well-paved road, which after two turns comes abruptly to an end and then – just nothing.

But by some strange coincidence, which is probably going to be realized some day and translated into the plane of human perception – **suddenly there appears someone's hand**, opens the doors of the comfortable cars, ruthlessly pulls the passengers out and kicks them out of the habitual reality onto the mountain path. That is all, nowhere to go – you can sit on the rock and indulge in dreams about the old times, remember changing your Zhiguli for Toyota, with much less damages, but that very moment you open your eyes and everything around you looks uncomfortable, unfamiliar, strange, original and majestic in size.

Again I apologize to the readers for such a "non-scientific" comparison, but there are reasons for that. The phenomenon that a man comes across for the first time **after realizing the falseness of the world outlook presented by science and near-science** is impossible to denote by the usual figures of speech, but sooner or later, this emotional component passes, giving place to the observations, reflections and conclusions.

To have a look at the world in a new way, to see things previously unnoticed, to perceive the magnitude of the delusions, and to proceed working your will but not imposed by someone – **all this becomes possible with the Information**. Of course, it is easier to believe someone or something and, once having been defined, take your own position, defending its implacable justice, and loyalty. It gives you some sense of confidence and self-sufficiency up to the time, when new facts and the information having got from the outside will negate all earlier applied efforts. **Therefore, the most valuable and urgent, that facilitates the development, is Information, besides being reliable, but not planted on or fabricated**. It is all around us, but we must learn to see it and make the right conclusions. And it is not taught in any academic publications. However true and methodically correctly the textbook might be – whether it is written for philosophers or biologists, even with the most careful study, it will not teach you, because it has been created, like any other

recognized scientific or popular publication, in the framework of the System, and thus, strictly keeping to its mission to maintain a person's world view within the given framework, developing (or rather changing) in the permitted directions and create the illusion of some scientific progress.

Today's abundance of books of the works of different authors with the help of the World Wide Web, and not only, has been turned into the ocean of debris in which to find the needed is extremely difficult. After all, when looking for something everyone is guided by something prepared that will give one everything at once, besides, it should be comfortable and pleasant – in short, that "something" should duplicate that smooth way in a comfortable car, but it might be to the other side and with some other views along the way. **For this reason, all the books that really give a MAN an opportunity to develop oneself, and open the locked door a little bring about some rebuff, rejection, but at the same time attract people, make them criticize, indignant with the content, pull out some facts, that make a riot in the heads or, on the contrary, create euphoria.** All this is not very important in general; it is just a quest process, which, especially in the tense moments may cause outrageous emotions of various colors, and a sharp change in one's general state and twists and turns of fate. It is important that this break-up leads to the perception of the reality, although it affects everyone's imagination – both – in what way and why the Humanity has been formed and what awaits it in the future.

Of course, the authors of these books leave the reader with absolutely unbearable interest. It is an exorbitant phenomenon by the standards of any human being, and the more successful the reader is in the area of his application (for example, a successful scientist or a prominent politician), the greater his reaction might be, regardless of its color. This is a natural manifestation of reading books by such authors, who, without proving some higher Truth, just provide Information in the broadest sense of the word, and demonstrate the possibility to come to a reasonable and fair conclusion on the basis of its profound analysis. Such books are never published under the imprint of the Academy of Sciences, they do not get an overnight universal recognition and understanding, and their authors never strive for something of this kind. But their readers get something that **every true human being is eager to get – perception of the reality through the comprehension of the information** that everyone can learn to obtain in an authentic form, without distortion or imposed false views, convenient to

anyone. **N. V. Levashov, A. M. Khatybov, N.A. Morozov, B.V. Makov** are the authors of the books that can give everyone all this.

Feodor Dmitrievich Shkrudnev is the Man who will make you do it without giving you the chance to return and plunge into the swamp of the usual stereotypes, and again get back in your comfortable car speeding along a straight road to the cliff.

The Book created by Feodor Shkrudnev I have had a chance to become familiar with and which is now in your hands is, in the first instance, **A Challenge**, –a challenge both to everyone and to the System. While reading it your Brain is being in the state of non-stop intensive work. Everything in it causes some mental rebellion, makes you set out in some quest and pull you out of the quagmire of the habitual judgments. Everything **in It is “quite different’ from the expected.** Whatever you touch upon is going to be “wrong», not the way it is accepted, different from what you might expect from THE BOOK.

F. Shkrudnev’s work with quite a strange name – N. Levashov’s "SvetL Broom" in A. Khatybov’s "Bath School", which is marked by the author as the sequel of the third volume of "The Mirror of My Soul" by N. Levashov is more than a continuation of his autobiography. Certainly, to a number of points concerning the biography of N. Levashov is given some attention. But neither more nor less. They are not even digressions into the biography of N. Levashov to satisfy the curiosity of the reader. It is a description of certain factors that enable you to make a more complete judgment on things and objects that are more important than the personal life of the Outstanding Russian Scientist. It is more important to get to know some things about physics of the process of generation, about which little is said in A. Khatybov’s works and which some people have already got acquainted with firsthand while using "SvetL" Technology, than about the details of Nicholai Levashov’s family life and his attitude towards these or those people. It cannot be any other reasonable judgment on the question of what should be the whole book about; Everything that was necessary to put on paper about his life, N. Levashov did himself to forestall all possible strife in this matter: "I thought that if someone is interested in my life and my path no one but myself would be able to tell you what and when had happened in my life, what I had thought in certain situations and what I had felt and experienced... And as long as this is my life no one but me will do it better..."

Being aware of this, as well as having clear perception of what is indispensable to a human being for knowledge, and where just some banal

curiosity begins, determined the contents of the books by Feodor Shkrudnev. It could not be otherwise. But his chosen path and the style of presentation are limited from different sides – the publicity of the information presented is restrained with absolutely non-public details and fundamental discoveries. As far as generation is concerned the author has said a lot without saying anything that could give the appearance of knowledge. For biologists it will be important to read and learn about the real structure of a living cell, known to them from traditional scientific publications, but they will have to make sure, that scientific journals and their authors do not have the slightest idea either about the structure of a living cell, or about its capabilities. What you really get from reading the Book but what cannot touch is the information and an impressive push (as they say – "kick") to thinking it over.

The style of the text probably seems to be structured in a somewhat unusual logic. You may not find either some common logic or simplicity of exposition in this Book in that form which is accepted for the reputable and claiming to be fundamental publications. Everything is quite different here, and is likely to be similar to the DNA helix in that form in which it first appeared in the thoughts of its first observers. The most complicated design, with numerous interconnected and interdependent, **strictly verified and conceived by someone**, but at first glance, looking like a very incredible and intricate tangle of «don't know what". When you begin to look into, following the windings of the stated events and facts, you see strict helical structure, which invariably brings you back to the previously mentioned facts, making you see their connection with the others, and appreciate their place in the overall design much deeper. On the following turn the same, already "familiar" facts seem to be mentioned not quite casually, **but having their specific place** that is defined not by coincidence, but by previously unnoticed and misunderstood regularities. This kind of perception makes you reorganize the whole construction created in your head after reading – it is getting more complicated, acquiring some rigorous simplicity and significance.

I think any person related to some scientific activities in the modern sense of the word, cannot ignore the issue of involvement to the proceedings (both yours and others') literary sources. Indeed, with this we are all very strict – plagiarism is punishable and to rely on the works of predecessors is imperative. Failure to follow these scientific morals is fraught with very unpleasant consequences. There is no problem to find the sources of all mentioned, to keep to strict adherence to the authorship, to nurture your

own works, and to observe accuracy in the references to the works of colleagues and teachers. It is necessary to clearly track of what is whose, to avoid confusion, when all "this" is going to be transferred into tangible assets. The chain is not intricate – who came up with the idea, developed it, got under it (you need to substitute – the Department, a grant, place, job, an entire institution, rank, degree, position, honor, monograph, recognition, etc.) – that one is the owner, and no one should forget it – the ability to convert it into profits, as well as amuse your self-esteem and support absolutely essential in the scientific community ambitions must be maintained in the operable condition. The converse is also true – should you have published something obscene – that is something that brings about such a sober and fresh look at the existing ideas making the whole pyramid topple over – then references to this ugly creature mark an outcast, a renegade in his frenzy being carried too far – someone might say with a sigh, " Well, he did give some hope!.."

However, those works that are created with another purpose, those ideas that are born not in the frame of the old System, something that breaks down the Foundation, clearing up the place for the substantial construction of the mind in the direction of finding the truth, **do not even include such a notion as plagiarism.** Therefore, those for whom the very essence of this phenomenon is something Sacred may not move further as all most sacred shall be ruthlessly destroyed as not wanted. That is "the BROOM" for – to slash vigorously up to scratches on the "body", and the anguished cries of plagiarism just will not be understood or heard – the "**Bath School**" is too far from modern science and its postulates. Well, as far as the text of the Book is concerned – just try to ask such a question: How can you make the reader conceive what the Book say about otherwise? It is a rhetorical question – no matter the way you try but for the author to get the intended the only possible way is to involve what was said by one Man and what was written in this respect on another level of understanding by another Man, and what the third Man added to all this without decorating with so favorite references – and to present it to the reader as a single continuous whole in all its infinite capacity and the development of thought. And if the reader sees the point the desire to break the book with some acknowledgment does not appear – it will do such work in your head, that your own suffering Brain will begin to generate for itself quite unexpected things.

But to calm the requirements of morality of every reader, none of these People – the Authors of the texts, partly given in the Book, are hidden, on the contrary, their names become more significant than any record-largest

citation index after reading the Book. **But it is more than participation as an integral unit or a plurality of such units in the bibliographic list of the used literature.**

Whatever side is used to appreciate the result of Feodor Shkrudnev's Work it does not fit any accepted scientific or near-scientific standards that are being used when writing scientific or popular science books. All these, as well as any other formalized versions of various standardized approaches cannot be applied to such Work. Everything having created by the author, is beyond the existing so far and inevitably collapsing now the System realities, it teaches us to think independently, provides Information that is above any price, and makes you discard all that was imposed upon the Man with the upbringing, education and experience distorted with the false life values. Do not You think now that this Work with such a strange name for a narrow-minded person called N. Levashov's "SvetL Broom" in A. Khatybov's "Bath School" and a Labor Spade is the public beginning of the true New Science?

*Doctor of biological Sciences,
Professor V. O. Salovarov*

*To
Nicolay Levashov
Svetlana Levashova and
Tamara Shkrudneva –
Dedicated.*

Knowledge is the most important, the most beautiful and needful in human life. It has always been and will ever be the highest manifestation of the world perception. Only on the basis of his knowledge and his perception of the world around is Man able to transform Nature and himself.

Acknowledgments

Firstly (and finally, or to be more precise, at all times), I would like to thank all the Sources that are in this book; Sources of all that my Knowledge and experience are made of, on the basis of which it is being realized what is gradually becoming **PUBLIC** and is working for **THE GOOD**. I have told in detail about these sources in the book. But the main source are my meetings with Nikolai Levashov, our heart to heart talks, his works and what I **HAVE PERCEIVED** thanks to him.

Secondly, it is obvious to me that each of us can make a list of people who have influenced our lives and our **KNOWLEDGE** so meaningfully and deeply that it is **IMPOSSIBLE** either to explain or describe it; who shared their wisdom with us, told us about their truth, helped us survive all our mistakes and failures with endless patience and found only the best in us. In their acceptance, as well as **REFUSAL** to accept in us something that we would like to get rid of ourselves; these people encouraged us to grow, encouraged us to become something **GREAT**.

I would also like to include some of my Friends in this list, whose names I do not mention for confidentiality, although I aware of and appreciate their part in my life and what they have done and are doing

concerning the already **CREATED** and **BEING CREATED Technologies** and **Programs** with a common name "**SvetL**", approved by N. Levashov, about which you will get to know a lot after reading this book. I especially want to **thank B. Makov, I. Kondrakov, V. Ikhtisanov, A. Goncharov, A. Yuriev, V. Chudinov, and V. Efimov** – the people who are directly related to science, who have helped me in this work ever willingly.

Thirdly, I thank the active participants of **the Russian Scientific and Technical Society ("RSTS")** and members of the newly set up **Clubs of New Knowledge named after N. Levashov**, who, sparing no efforts in disseminating the information and "**SvetL**" **Technologies**, made it possible to begin the implementation of my promise given in public – **TO FINISH WRITING** the book that had **NOT BEEN COMPLETED** by **N. Levashov**. And to finish it with their participation, since they are **NOT INDIFFERENT** to what is left for all of us **by N. Levashov, A. Khatybov** and other outstanding Russian Scientists. That is how this book **OCCURRED** through me. In the literal sense of the word. This book has not been written by me – it **occurred through me**. And while you reading the book, I am more than sure that it will **occur through you** in the same way as it has happened to many people while their making an acquaintance with N. Levashov's works, and then with the others, because all of us **WERE LED** to the truth that we had already been ready for "**SvetL**" **Technologies**, perception of them and their application only accelerated this process. And although my heart is **OVERFLOWING** with **GRATITUDE** for everything these wonderful people (Human BEINGS) have done for me, I cannot help mentioning my **MAIN helper, my wife and life companion Tamara Viktorovna Shkrudneva**, a woman with an extraordinary wisdom, an ability for love and compassion not only for me, in all my endeavors, but also for people turning to her for help.

And finally, **fourthly**, I would like to mention the people whom I **HAVE NEVER MET**. However, their very lives and what they had done for the good of the people have had such a strong influence on me that I cannot help **EXTENDING** my thanks to them.

My life would have probably been much easier if I had not mentioned all of this. But my articles, the Knowledge that I have got, and this book, and everything **HAPPENED** to me **NOT FOR** this. And whatever difficulties this would bring in (for instance, I have already been called a blasphemer, a deceiver, and a hypocrite because I had **NOT FOLLOWED** these truths

earlier – or, even worse, – a saint), now I **CAN NO** longer **stop** this process. And I do not want to. I have had plenty of opportunities to avoid all this, and I have not taken advantage of any. I have made up my mind to behave as **my** conscience and intuition dictate and not the way **MOST** people want me to behave.

My knowledge and intuition tell me that this book, all that it is expounded in it, is not nonsense, not the fruit of a tired imagination. All this is **REALITY** of the present day. And if we consider Technologies and specifically "**SvetL**" **Programs**, which are described in this book – what they are "capable of" or "not capable of" (no matter what some people think of it), the **TRUTH** lies in the fact that **the Programs TALK** to anyone who has decided to apply them – to a good one and a bad one, to a saint and a bastard. And, of course, with each of us who has already applied these Programs.

Prologue

Life goes on...

As a basis of the book, or rather, four books as it turned out later after long deliberation, I have decided to take a remarkable work of the Man who called me his associate, "gave" me so much knowledge that my acquaintance with him has become an integral part of my life, and what I have gained from him – **MY KNOWLEDGE**. The work in question is the "**The Mirror of My Soul**" by **Nicolai Levashov**. The events that have happened to me for the last few years seem to "reoccur" the events that happened to Nikolai. Just because of it and for the readers' better understanding of my story, I will "take" those episodes from Nikolai Levashov's book that I consider necessary, and project them onto the present day, the events that happened to me after his "passing away" (I do not want to say – death). This will make it possible to return once again to the information given by N. Levashov in his books, and to comprehend it, realizing that what he wrote about is happening today with many of us and everywhere.

I am also doing this because I have promised to "finish" the **INCOMPLETED third volume of "The Mirror of My Soul"**, which was begun by Levashov just before his death and which is called "**Life goes on...**" **Much** has been **contained in this title** (if you consider it carefully), including the answer to the question: why this volume must have been completed after **HIS PASSING AWAY**, **in what way and who should complete it and for what purpose it should be completed**. This is neither a continuation of N. Levashov's life story, nor some moments of his life that are known to me and that were not mentioned in his writings; although, I will certainly touch on some aspects. I am sure that **SOME** people will **CRITISIZE** me, because they are expecting this book to cover some hidden facts from Levashov's life and the continuation of a certain story about him. But these are neither memoirs nor a biography. These are broodings over the past and the left behind. This is **MY KNOWLEDGE**, that I have got at school, the naval school, the naval academy, and other educational institutions with famous names. This is the knowledge gained at naval and government service. But the most important is the knowledge gained from the outstanding Russian Scientists, who I was fortunate enough to know personally, and from those who unfortunately I have not had the

chance to meet, but whose works I have been lucky to get acquainted with. Having obtained **KNOWLEDGE** (that has become **MINE**) on the basis of those works I **HAS SUCCEEDED** in applying them in practice.

Why did it occur only to me to «finish" this book? **Why DID NONE** either of Levashov's circle contacts or the readers of his books **INITIATE** the implementation of any of his technologies, including the so-called "**Dark Matter**" **Generator, about which N. Levashov wrote and those he was able to create?** Why do some people today disseminate not information from Levasov's works but lies and gossip based on rumors? The answers to many "whys" you will find out from this book.

For me, there is no such a notion as "plagiarism", since everything connected with it is aimed at limiting the dissemination of a true information and strengthening the importance of those who "**produced and is producing heaps**" and laid them on a blank sheet not being aware of one thing: **NOT DOES HE** (the author) write, but **HE** (the author) **IS WRITTEN BY**. How this happens and what is behind it will be told in this book.

It so happened that I had to speak in public and tell about my relation with N. Levashov, about our meetings, plans. and some events, and about what I did and was going to do. I spoke about **the works by A. Khatybov, N. Morozov and other** living Russian scientists, I tried to make it clear to the people that **N. Levashov and A. Khatybov** had known each other, met and exchanged information. I told the people that what they had written in their works, was **INTERRELATED** and complemented one another. I emphasized that All That allowed them to create what they had created.

I also mentioned the **Friends that N. Levashov had and still has** and about them he wrote openly, but many readers did not understand **THE MISSION** of these Friends.

I have written in detail about the Generator (the generator of "dark matter" in his terminology) made by N. Levashov, **how "SvetL" Programs had been created and who had created them.** But very often the information I tried to convey got back to me in the form of a kind of "folklore", being surrounded with such stories that distorted almost everything including the image of Nikolai Levashov. The inventors and distributors of this "folklore", exaggerating and distorting the facts, except for the negative attitude to Nicholai and his activities, did not cause anything else. Were those engaged in it aware of what they were doing? I can say with all responsibility: **YES**, they **WERE** However, a lot of people wrote to me

and just called me or Skyped – those who have already read my articles, - asked me to write about the events that had occurred since my "acquaintance" with Nikolai Levashov. People asked me to tell them about the development of his heritage left to all of us.

And I decided **TO WRITE BY MYSELF** and publish the information that was available to me, tell about the knowledge that was gained and tested, and to go on giving information about those Technologies that have already been working for the good, to relate not only about **OUR COMMON** plans and thoughts, but also about that knowledge (gained from the works by **A. Khatybov and other scientists**), which made it possible to comprehend, create and expand "**SvetL**" **Programs**.

When I began to work in this direction, everything went on its own accord as a sequel of the third volume of his **incomplete work "The Mirror of My Soul"** and my comprehension of what was going on.

I hope I will be able to keep to a certain objectivity. Of course, everything described is going to be subjective reflecting the world around me seen with my own eyes. But for all that I will try to reflect everything as objectively as possible. And since this is a description of what has happened and is happening to me (what and when it happened in my life, what and how I thought in certain life situations, what I felt and experienced that time), better and more accurately no one will do it. But if something goes wrong, it will be a distortion of my own vision, and it will still be better than the distortions made by someone else.

I would like to note that I have never thought of myself as one of the selected. It makes me laugh even to think about something like that attributed to me, based on the fact that I was familiar with **N. Levashov**, and the fact that **HE "OPENED"** my Brain and gave me some kind of supernatural resources that allow me to do what I am doing now. Belief in destiny completely denies Man's free will; it turns Man into a slave of circumstances and makes a submissive plaything of external forces.

N. Levashov "taught" me a lot, and I learned a lot talking to him, studying his works and the works of others, about whom I have already mentioned. **All THAT** has become **MY KNOWLEDGE** that I am able to apply now. I just live **MY OWN** life; do what **MY CONSCIENCE** and my sense of justice dictates me to do. Some like it. Some hate me because of this and still cannot "endure" the fact, that N. Levashov **DELEGATED** a lot exactly **TO ME**. Some fear **BEING AWARE** of my capabilities.

I know my mission is to live and act as my conscience dictates, regardless of getting or not getting any **ADVANTAGE, BEING** or not being praised. And when I encounter some "curious facts", one way or another related to my life, they seem curious and strange to me, and neither more or less. I do not suffer either from any complex of inferiority or megalomania! Everyone is responsible for one's own live, makes one's own choice and takes responsibility for the results of that choice.

After getting acquainted with **N. Levashov**, I was set in motion by the only thing: yearning for the **PERCEPTION** of Nature phenomenon, longing for the comprehension of **PHYSICS** of a living **CELL, PHYSICS OF ENERGY** and **PHYSICS OF THE BRAIN** as well as striving for solving for this or that enigma and accomplishing the tasks set by myself.

N. Levashov taught me to look for an opportunity to comprehend the happening events, to consider any phenomenon in the aspects that no one had ever considered before. Sometimes it was necessary to see the phenomenon not from one new side, but from a multitude: and, what is the most surprising in all that is the fact that I have succeeded in getting the bottom of the matter lately. To be able to do it I had to radically change not only my way of looking at things but myself as well, under the "supervision" of **Levashov** and on my own one after **HIS PASSING AWAY**), and also "under the supervision" of his Friends (when it was particularly difficult). And, as **N. Levashov** said, that was exactly what made me move forward...

Wise is the one who recognizes the limitations of one's knowledge and skills. But the one, who declares that he knows **EVERYTHING**, is able only **TO HARM**. So, as **N. Levashov** and **A. Khatybov** used to say, everything is good in its season!

Lots of what I have been doing, what I had been taught by **N. Levashov** and his Friends, and what I have conceived by myself, cannot be put into the Procrustean bed of the ideas of lots of people, but... Quite a number of them not having the slightest idea of how, for example, their computer, video camera, telephone and a lot of other things work, especially of the processes occurring in the microcosm and macrocosm but nevertheless, they **DO NOT REJECT** them, since these things have been accompanying people since their childhood, and also because people had been inculcated in the thought of their nothingness, that **"man is a miserable creature unable to do anything by himself!"** And besides, only **the Lord God IS ABLE TO CREATE!!!** What is the most curious about all of this: **there is no evidence that the Almighty has created everything, only a blind**

faith! And that is not all! The way God created the universe, including our Planet was changed several times in the holy books, more precisely, the interpretation of the very process of creation. All the explanations of the nature of the divine creation used to appear only after the accumulation of the facts that the Church **WAS NOT ABLE to REFUTE** even with the greatest desire. And in the Middle Ages the Inquisition burned scientists on the bonfires for just being affirmed in the fact that the Earth rotates around its axis and around the Sun, like **Giordano Bruno** who was burnt. Nowadays, the church officially recognizes the existence of aliens and intelligent life **ON** other Planets. This is more and more talked about by the Vatican, which is an irrefutable proof of the manipulation of the people's consciousness and of the one who really stands behind the so-called "Almighty"!

Does the Church and its "ministers" play any significant role in what is happening today? I will not comment but just give you some figures. **Since 1991**, there have been built and **OPENED 20,000** churches and **CLOSED 23,000** schools. And No one but **N. Levashov and A. Khatybov** described the essence of all this in an intelligible and irrefutable way **in their writings**.

Do not be lazy, read and make conclusions of your own – who makes profit inculcating in people their being wretched and sinful from the moment of their birth" and are not capable of anything" but an obedient submission to the elect of "Almighty" (That **DOES NOT EXIST(!)**). Who benefits by **HIDING** from the people the possibility **of development to the Creator's level**, only not in the way as it is described by social parasites in the texts fabricated by them?

People – Human Beings! Start thinking with your own Brains; stop listening to other people's explanations, besides being absurd ones! A lot of things will become very clear if you develop yourself correctly. And what was attributed to Gods will become possible to Man! Yes, for the Man who has reached the level of creation, I emphasize, – perceived Creation! It is but necessary to go through all the stages of the development; as they say, **"it's not the Gods that burn the pots!"** I do not think I have managed to go through all the stages that **N. Levashov** had mentioned. But I know that I am going the right way. And the results **PRESENTED TO THE PUBLIC** confirm it.

Anyone can have one's own original ideas, plans leading to **COGNITION**, and the itch to properly develop very self. The main thing is

that once you take that **PATH**, do not quit the next day, month, year. Work at a pace that you are able to keep constantly. Observe the sense of proportion. You should **BE AFRAID OF** only one thing – **TO BORE** people with the unwanted actions. Avoid fruitless disputes. Spend your time on getting **KNOWLEDGE** but not on empty **DISPUTES**. And you certainly should be aware of the fact that deliberate denial of the truth is a betrayal of yourself. This is the way you should go if you want to move from the category of people to the category of Human Beings.

I have pondered for a long time about the sequence of information presentation that I possess, thinking of that knowledge that I would like to share with the readers. After **N. Levashov's "passing away"** a short time elapsed if measuring the phenomena taking place nowadays. But this time is full of many events within the framework of everyday understanding. Of course, I would like to tell a lot and share my knowledge with the readers in the same way as **N. Levashov** did. But where should I start? I have made up my mind to start with a common name of what I want to set out – with the name that would contain everything that this book is to consist of, with what that **N. Levashov DID NOT HAVE TIME** to write; with the explanation of what **A. Khatybov stated**; to show **HOW MUCH COMPLEMENTARY** are the works of these scientists who discovered the information for us that is "to be transformed" into our knowledge. But there are many people whose Brain is not able to perceive it, – and not because people are stupid, but because very few of them understand **WHAT EXACTLY** the **BRAIN** is.

Over the years, there have been written a lot of articles in which I wanted to explain to the people what heritage **N. Levashov left** for us in addition to his works. It was written and told in the framework of today's possibilities about how the Generator of "dark matter" had been created and applied; what **"SvetL" Programs** mean; how they had come into being and the way they had been modernized, tested and applied that day; how the name of **"SvetL"** was put in an appearance. All this was decided to be summarized in the collection **"Knowledge from the Origin,"** which was released in **2015**. But it was necessary to find a common name combining the works both **of N. Levashov and A. Khatybov** with some new works that would make it possible to develop this **HERITAGE** and apply it in life, as well as to provide "help" in **EVOLUTION** of the Brain, which is by no means unimportant today. However, whatsoever and whoever may talk about it, it turns out, that there is just **no way anywhere without the Brain.**

It is important to realize whether the Brain affects the life of a person. It turns out that we do not have a true notion of what the Brain is. We cannot see the Brain under a microscope or cut it with a scalpel. We actually **HAVE** a **VAGUE** idea of the Brain. And in order to perceive it, as **A. Khatybov** used it say, "**you have to have a Bath**". That's the way the name was born, uniting everything that is going to be written here: **N. Levashov's "SvetL Broom" in A. Khatybov's Bath School and a Labour Spade "**

You are going to get to know: what **N. Levashov's "SvetL Broom"** is and what it is for; what the "**Bath School**" is and why you should go there; What a "**Labor Spade**" is and how to use it.

Often it is easier for an intelligent person to open a new truth to the world than to realize why others do not accept it. I have long been convinced that no matter how hard I try to be understandable; people still are not able to part with the usual clichés overnight, especially if their **CONSCIOUSNESS** has lost its elasticity and is stiffened, which is typical of the older age. It does not want to part with the **MYTHS** put into their heads. I will try to break these clichés, return to the standard consciousness of people their Human properties and that world outlook that has been deliberately hidden for millennia.

Today Man has two ways to go. **ONE** is to abandon all reasoning about the foundation and nature of the society, merge with the crowd, hunting for bread and shows and surrender to the will of the elements. **THE OTHER** is to go further into the matter, the causes of our troubles and build up a modern system of knowledge; to create the system based on the knowledge of **those** who ran counter to the so-called modern science and who stood and still standing at the source of **NEW KNOWLEDGE**, that are destined to bring the Humanity out of that abyss and darkness into which people were deliberately immersed.

There is reading caused by emotions, and there are emotions caused by reading, which is more important. But there is also a **HUMAN MIND** that emotions interfere with. There are many who have already realized that we need information (out of reading) and the Mind for accepting (or not accepting) this information. Lots of people when reading **N. Levashov's** works paid attention to the fact that with the first reading they got at one meaning of the text, and then, re-reading, they conceived the text in a different way, that was much deeper and more meaningful. Practically all the information from **A. Khatybov** and **N. Morozov**, on the sites of the

Research Institute of "the Centre of Preventive Strategies" and "RSTS", is also given in the "framework" of the resources of your Brain.

What you are reading right now is the **SECOND FULL VERSION** of both books, completed in **March 2017**. But you make an assessment of what has been done after getting the results. After getting down to the writing of the book and publishing it chapter by chapter on my website, I began getting letters from the readers. They sent their comments and expressed their wishes: which information was not sufficiently covered, and which one was missing. All these numerous questions, requests and clarifications are taken into account in this edition of the text. It turned out to be voluminous and, to my opinion, not very convenient in cognition. Therefore, I made up my mind **to make 4 books** out of all the written material, which, on the one hand, are independent in their comprehending, and on the other hand, they **ARE SEQUELS** of each other, and what is important, they are sequels of the third volume of **N. Levashov's "THE Mirror of My Soul"**, as it was promised. I'm sure that the readers will appreciate it.

Time is running fast. Some Information is becoming out of date, and in this edition I will try to cover all the trends you wrote to me about, and in addition, to make supplements for better comprehension.

One of the deepest secrets for Man is the perception of the very fact of the physical process, under which both the harmony of the internal states of the functioning Brain and external states of its control are being formed, representing stage-by-stage growing perfection of the states of Consciousness and Mind. The Human Brain creates its own version of reality. The world that you see and hear around you only seems to be so. In most cases what you see and hear is not quite real. You perceive only a tiny fraction of what is actually happening. You get an **IMPRESSION** of a wide panorama before your eyes, but **REALLY** you see no more than the size of your own fingers at arm's length. The rest of the space is filled with imaginary reality since your Brain creates stable conditions for you. Although you may think that you are the Man and the captain of your ship, however, many processes are controlled by those who surround you, and your environment. You cannot trust your own Brain. But if you care nothing for your Brain, you have to go to the **"BATH"**, and beforehand to read this work in order to have an idea what **"BATH"** means, how to use it and why you should "go" there. And for this you **NEED N. Levashov's "SvetL Broom" in "A. Khatybov's "Bath School" and a Labor Spade.**

Introduction

Getting down to this work, I proceeded from the fact that a good book puts in good order the available knowledge. It takes our thoughts out of the consciousness, pulls them out of the corners of the subconsciousness, extracts from our heart and sticks them together to make **NEW** knowledge. As a result, a new "4" is given rise from already existing "2+2". New, sprang up of the existing, is **NOT** supposed to **BREAK** the harmony of the former. Thus, in my opinion, the worldview becomes more complete and clear.

For those who has read **N. Levashov** and proceeded to **A. Khatybov** (although understanding little from the above), who persistently advances in his knowledge, it would be worth taking the bull by its horns, and get at the meaning of **the Bath**. But to be objective – are there many such ones now? The undoubted majority is hardly capable of adequately perceiving any Genotype of the Brain, an incomprehensible albedo and frequency ... And ebro-spiders, the Earth capture and their Control System (SEC), are not "our" Sun and Moon? And about **a LIVING** cell, and who and where "got in there and what for" it is not of this world. Where is the sequence of events (in the form we "were taught") backed up with «advanced studies", artifacts and "world known" names of "explorers"?

When **REFLECTIVELY** reading **Nikolai Levashov**, everything is logically «being revealed «to the reader, and well grounded that can hardly be refuted, and all the material is outlined in succession. You **CANNOT** find all this in A. Khatybov's (as a result of the ban on most of his works). I do want to give information that is to be turn into a **NEW** knowledge of the one who reads it. It's like an emergency aid, suddenly stopped before the very nose of a lost person with no hope to survive. But this new knowledge is not collected together, it is like a heap of garbage, which is lying around. Should it be assembled – and there comes out a miracle of technology. Those who master this technique will no longer turn to someone else's help. This is what I would like to convey to the reader.

I got at a noticeable conclusion: people are mostly **READY** for a **NEW** knowledge, **BUT** the logic of **GRASPING** this knowledge is ineffective. This explains the fact why disputing such topics, even among those "**WHO PERSEIVED**", do not lead to anything. The debaters being preconceived believe that **THE MOST** important material is presented in a non-logical

way, but they are not even able to determine what is the most important. It only means that the ideas should be set out logically, so that the reader could clearly understand whether to accept the information or not to. To explain the complicated in a simple language, it is not enough to feel the truth yourself; it still needs to be understood. To talk to people thinking in the habitual categories on a large scale subject, is the same as to talk to children. Most people, no matter how smart they are, will **NOT TAKE** it seriously. Having been convinced of this, I returned to this subject in our talks with N. **Levashov**. The fact that someone is well informed in nuclear physics or mosquito leg testifies to the presence of intellect or intellectual resources, but **NOT THE SCALE** of thought. An intellect without large-scale thinking does **NOT SOLVE ANYTHING**. Thought is a product of knowledge processing! Man gives birth to a thought. ***A thought makes a MAN, because in the beginning there was a thought, and not a word. The word was after.*** It is not possible to do something that you did not grasp on a large scale, because you will not believe in the reality of your doing. And if you do not believe it, you will consider it nonsense and an empty fantasy. This is what happens with many who is trying to "comprehend" the "technology of creating **SvetL**" **Programs**. It is a perfect example of moving forward in the understanding of cause and effect, on the basis of which we will move to cognition, not before we are summoned to the **Bath**.

And we will be summoned to **the Bath** without fail, I'm absolutely sure about that. Because each person is absolutely **SELF – SUFFICIENT**. **He knows everything**. This was emphasized by N. **Levashov** and A. **Khatybov**, and I have been convinced of this. But a Man **HAS NO TIME** to put in good order his knowledge and thoughts and to get at the meaning of the new. There is no move **FORWARD** since there are too few "promptings" and clarifications. Start acting! That's what you are supposed to do. Act right here and right now. **DO NOT BE SLOW AND DO NOT ARGUE** about the causes and consequences of your actions in solving so large-scale tasks facing you. Start with a little – then there is an idea: it needs to be changed; start something new or finish the old one. You might need to catch up with someone, find or leave, help or just hug ... You feel like saying something to someone who is close by or not close by, or wants to be close by...

If there is something that requires your participation in order to move on, act then: speak, look for, fight, struggle, but **DO NOT BE**

INDIFFERENT. Take an action! Because the world needs your diligence.
Take my book as a **PROMTING AND CLARIFICATION.**

Chapter 1. The planetary level of secrecy, or "the operation of disclosure"

People take for the truth not that is true but what is understandable. The truth set out unclearly is taken as a lie. Intelligible interpretation is of principal importance.

Taking for the truth the conformity of certain provisions to certain criteria of verifiability (as in philosophy, for example), people limit themselves with these criteria, **HAVING NO** opportunities to expand the boundaries of their reasoning in view of the fact that they quickly go over those boundaries and indulge in what that the majority defines as **MEANINGLESS FANTASY**, but to put it simply, nonsense. On the other hand, criteria of verifiability must be at least greater approximation to the truth than their being checked provisions, and the latter also have to be checked with something. In conditions, when the thought rushes forward and deep into the distance, covering those areas, the essence of the content of which there is nothing to check with, there might happen a crisis of thinking that is able to turn into something new by expanding the scope of consciousness, or, in case of strict observance of the rules and laws prescribed by tradition and way of life, the circle closes and there will not be any search or movement to the truth. In the end, the old, currently existing criteria of verifiability, intended to serve as the instrument of knowledge, limit it easily, transforming the primordial Human aspiration for the truth in the plowing of the most affordable top layer of the observable reality.

* * *

On the sides of the spacecraft "Kennedy" there were placed two engines 5 feet wide each. The designers of the ship wanted to make these engines even further, but were not able to. Why? The fact is that these engines were transported by rail, which passes through a **NARROW** tunnel. The distance between the rails is standard: **4 feet 8.5 inches**, so the designers could make engines only 5 feet wide. The question arises: why is the distance between the rails is **4 feet 8.5 inches**? It turns out that the railroad in the United States was built similar to that in England, and England made railway carriages on the same principle as trams, and the first tram produced in

England in the image of the team of horses. And the length of the axis was **just 4 feet 8.5 inches!** But why? Because the team of horses was made so that their axes fell into the ruts in the English roads for the wheels to wear less, and the distance between the ruts in England is just **4 feet 8.5 inches!** Why so? Just because the roads in Britain had been built by the Romans, bringing them under the size of their chariots, and the length of the axis of a standard Roman chariot was equal to... that's right, **4 feet 8.5 inches!**

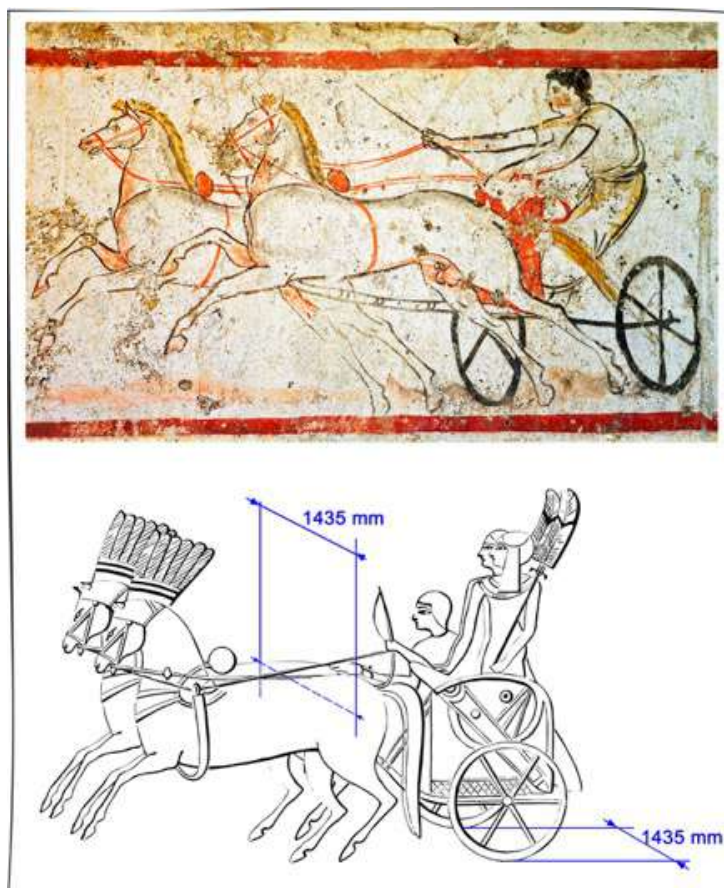

Now, we have got to the bottom of where this width comes from, but still why the Romans decided to make their chariots with axes of this length? And here's why: in such a chariot normally there were **TWO** horses harnessed. **And 4 feet 8.5 inches** is the **SIZE** of two horses' asses! To make the long axis of the chariot was inconvenient, as this would violate the balance of the chariot.

Therefore, here is the answer to the first question. Even now, when Man went into Space, his highest technical achievements directly depend **on the size of a horse's ass, as it was two thousand years ago.**

Let's take this "method" of comprehension and apply it to the information presented here. Let's go back to the events happened many thousands of years ago, that is quite possible if you understand that time does **NOT EXIST**. To move forward, you have to look into the past. So that you could "look" into the past, you have to be prepared; otherwise you would rather not however much you wanted. Time was "invented" only for our convenience, with our so short life. **Time does not exist, but there is physical-biological process in which it is possible to "enter" and move "back" and "forward"**, but before that you have to **TAKE the Bath**. Those who "has not received an invitation to **the Bath**", it is **NOT RECOMMENDED** to do it! You may come in if you are a Nobel laureate, in physics for example, but to come out – you will fail for sure. It has been proven.

1.1. The Beginning

"Where is the information from?" – you can ask. From **Alexander Khatybov's** encoded messages, confirmed in the writings of **Nicolai Levashov**, and by those real events, not to make notice of which is just **IMPOSSIBLE**. As **B. Makov**¹ has told, and **A. Khatybov** himself wrote about this, **during 1992-1998**, it was "accepted" and encoded **1652 texts** and at the same time, transmitted **772 texts**. However absurd it sounds at the beginning of the book. The deciphering of the texts "was made" with the help of the well-known method of **"Kaleidoscope"**, and therefore there is such a **CLEAR** and **UNDERSTANDABLE** "picture" of the past, independently confirming everything that was written by **N. Levashov** based on his own experience and that of others.

Most civilizations in the Space are at a **QUALITATIVELY DIFFERENT** level of evolution, when information is transmitted and received not via radio signals, but mentally and holographically, and to be more precise, visual-graphically nowadays. Thousands of signals from the Space are transmitted from other civilizations in the form of volumetric holograms directly and via the Control Complexes. There is no need in making contact. It exists in a specific realization, especially after a full stop and termination of all previous Control Systems and replacement in **2012** of the interventionist Programs for the original Programs of "the revival and

¹ B.V. Makov – the Director of Scientific Research Institute – The Centre of preventive Strategies.

reconstruction" of everything that had been on the Earth twenty thousand years ago. But most people do **NOT UNDERSTAND**, do not know and are unable to obtain this information. Those who can translate this information into other languages so that to make it **INTELLIGIBLE** to other people (the works by **N. Levashov, A. Khatybov** and others). But, unfortunately, even in an accessible form, this information **is REJECTED**... The same happened with **the third Appeal to the people of the Earth by the Coalition Team of Observers C. G. O.** (Association of civilizations of our Galaxy) passed for the people of the Earth **in 1929, to E. I. Roerich and N. K. Roerich** by Shambhala intermediaries. This appeal was **just ignored**... Who is still interested can get acquainted with **this Appeal** in **Levashov's book "Last Appeal to the Mankind"**. And as for the others I would ask you not to worry. Because it is too late to worry and there is no reason.

Let us emphasize two ways. **The first one** is to abandon all reasoning about the foundation and nature of society, about new knowledge and perception, mix up with the crowd, being eager for bread and shows, and surrender to the will of the elements. **The second one** is to grasp the essence of what is happening, in the causes of our present day misfortunes and to create for ourselves a modern system based on **NEW KNOWLEDGE**, which is supposed to include what is being narrated here.

I would like to draw the readers' attention to the fact that this information had been concealed from people for over the past 18 thousand years. 4 years ago, it was **UNTHINKABLE** to obtain this information (it was a planetary level of **SECRECY**).

* * *

The earth is **ARTIFICIALLY** created (**for 10 billion years**) formation to ensure the existence and evolution of life. **The Cell** (life) is also an artificially created formation, the existence of which is determined by the beats of the Earth. **The Earth** has its own "computers" and Complexes that make up **the Earth Control System (ECS)**. In turn, **the ECS** cooperates with the higher Hierarchy of the Universe.

ECS is a self-developing System, Controlling the Earth evolution and life support created specifically for our Planetary System (later it will become clear why our System is not called Solar System). One of the principal of the **ECS** tasks in ensuring the existence of life on the Earth is the maintenance and generation of the beats (a kind of quartz Generators) for the life of the

cell, organ, organism, community of living beings, of Man and of Human community.

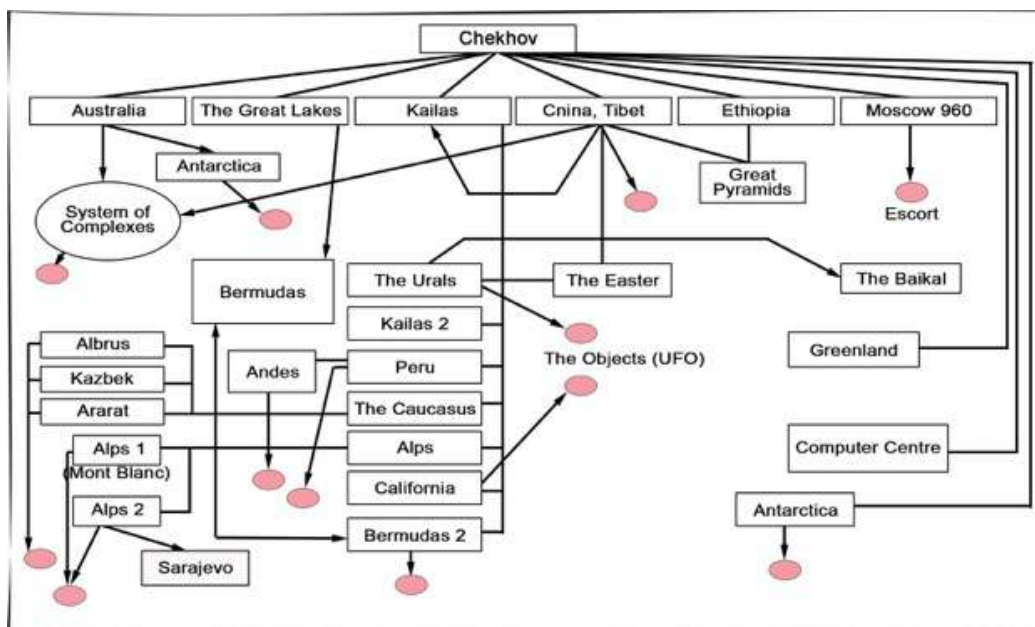

Some beats provide life cycles of the cell existence; other beats ensure co-existence of cells and so on. The beat frequencies of the Control System far exceed in frequency all conceivable physical variations (and go as far above as "the astral-mental frequency" to cone phrase).

It looks like science fiction! But in the search for additional evidence of the possibility of such creations, let's turn to **N. Levashov's** writings: "...**an artificial planet of an enormous size was created, but that's not all. The Created *White Star* was able, curving the space around itself, instantly find itself in that Universe – petal or in that matrix space, where there is some need in help...** This is the only one in its kind, a **CREATION** of the **MIND**, which moves through space not by itself, but, as you can say, moves the space itself. This creation corresponds to a well-known saying that "**if Mohammed won't come up to the mountain, then the mountain comes up to Mohammed**". And if a proverb has a figurative meaning, the White Star actually does it. A specific spatial **GENERATOR** changes the space around the White Star so that the space-universes one after another "are superimposed" on the White Star, and we can only set a task which space – universe it is to stop, and... the White Star finds itself in the right space of the universe."

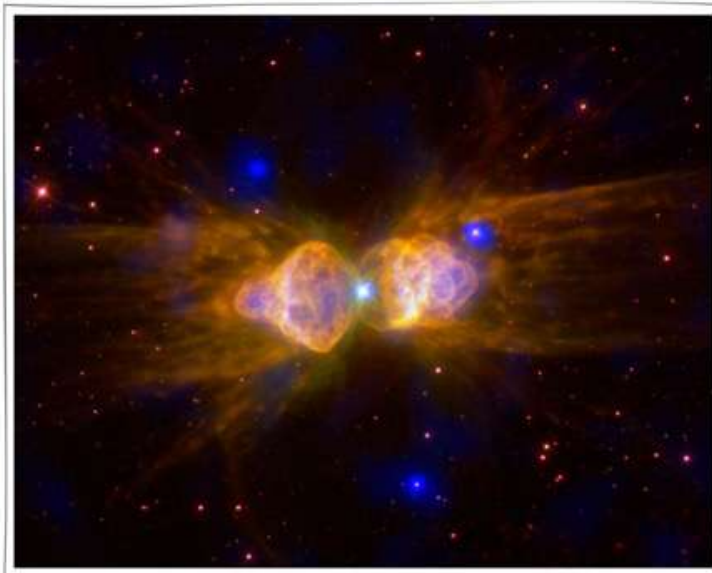

It also seems to be fantastic. Then refer to another Chronicles document– **the Slavic-Aryan Vedas:**

"The tribes were helped by the Power of God,
Blessing their lives for the common good ...
The Race was supported by the cherished Source
That remained in the tracts of the ancient...
The Gods foresaw the Darkness on Midgard
And Race decided to help the descendants
These events took place in the ancient times
When three moons over Midgard shone.
The Source has been placed in the bowels of the earth
But in peculiar tract the access was hidden.
In the depths of the earth, it accumulated the Power,
In different places It came into being.
But the Source of eternal divine Power
Not every space of the sacred Race flowed,
But only in places where, in line with traditions,
Midgard Gods Life Force inserted...
They bestowed upon the World the Divine Sense
For great achievements their kin directing..."

Here it is also mentioned a certain "Source of Life", which was placed in the heart of the Planet, and **a certain «Generator», set by the Gods.**

And if this information is not sufficient to satisfy the skeptics, you can take the "**Book of Books of all times and peoples – the old Testament or Tanakh**" in a somewhat abbreviated form. According to the Bible, **for seven days God has created** the heavens and the earth,

separated the waters from the land, worked on the creation of different plants and animals, created Man out of dust (the matter composed of atoms and molecules, like everything on earth) in his own image, and on the seventh day went to rest, satisfied with his good deeds. It also indicates the act of **CREATION**. *Although everyone gets it in one's own way.*



It is not by chance (according to the Bible) to create the Earth and Life on it... it has taken God **SEVEN DAYS** (day – light time of the day, rich in the spectrum of the primary matter (photons), but in the sequence of their qualitative and quantitative composition). As it is known, white light in its decomposition splits **into seven colors**, seven primary matters form a dense substance of our Universe, and the planet, respectively! And that's what was the result of their successive superposition:

But why do the work, which is easily done by Nature, under the corresponding conditions for the origin of life? Probably "something had happened" to the Universe and after that it was possible to start a "new experiment" taking into account the Knowledge "of the nature of the processes of matter formation", which more advanced civilizations **WERE ABLE** to carry out. More **SOPHISTICATED** systems for the evolution and preservation of Life on the Planet have been artificially created. In the ordinary course of the star-planetary System, the planet was subject to various threats from the matter conversion of the Cosmos – the explosion of

supernovae, flying "shards" of the Planets in the form of asteroids and other Space "riots", as well as from the objectively existing parasitic civilizations.

The planetary Cluster System² besides the Earth consisted of: ***Mercury, Venus, Mars, Phaeton, Jupiter, Saturn, Pluto, Neptune, and Uranus***. Each of the Planets had a particular function provided to it. For example, the System of planets did **NOT NEED** the Sun (there wasn't one) as a multifunctional generating system that provided the formation of control-energy radiation frequencies. On the Earth there were **364000 objects** to ensure **EVERYTHING** required for the complex control and harmonious **EXISTENCE** of energies, performing a process of civilizational development, and providing habitat conditions. The light had the 80 octave (the current lighting with the participation of the Sun is the 48 octave), gravity was of 5.82 m/s² (this fundamentally changed the whole arrangement of life for the Human, metabolic processes of the body and many other things in the state of reality).

That Planetary System was created for the development of PERFECT MIND, to reach by Man being on the Earth, **the TRUTH** about **Consciousness, Mind and Matter**. It was decided to realize this goal on the basis of the **Living Cell** in the **PROPER** evolution of the Human Brain under specially prepared conditions of life-attending **System of the Earth Control (ECS)**. This had been realized **LONG BEFORE** the forcible entry of parasitic civilization – the invaders from Darkling worlds.

1.2. Before the "Capture"...

Each planet from the Overall Hierarchy of Civilizations with the endowed living conditions, has to **HAVE** in its model design a certain required "set" of controlling, providing and attending Objects and Complexes, which being formed in the functional cluster³ Systems **have to be able to:**

² Planets clusters additionally invested power in developing civilization of intelligent orientation; their Control System consists of: Control Complexes, objects, Systems of energy-information transmission and communication which in total provide and retain in stability the control energies – the Mind.

³ Cluster is unification of several homogeneous units, which can be considered as an independent unit, possessing certain qualities, being common for each associated element. For example: celestial, galaxy, civilizational, planetary, cluster of public development. Control of every sphere of being, as separate

- provide autonomously the entire incremental process of controlling the development of **THEIR** Civilization on previously acquired from the outside program;
- to retain the **LIFE EXISTENCE** energies in a harmonious state with respect to each other;
- form the energy **SUPPLY** and "recharge" their existing energy concepts, etc.

Such a planet as the Earth is a kind of complex strictly identified planetary monocluster⁴ (with its own control of the existing energy and the development of civilization of Intellect orientation), which in line with the **PROVIDED** programs should be fully in harmony and interact with the help of the control system and provided functions, with cluster systems of **HIGHER** development in the course of its long evolution (8 stages).

The Earth is a set of models represented by the energies that are in the inertial (material) and no inertial (immaterial) states of aggregation of matter ranging from **12 to 512 octaves of the energies** for the **GIVEN** stage of civilizational development as the first stage of a nested program for its **DEVELOPMENT** in general. Our Mother Earth is not that simple as it seems to the present-day geophysics and, especially, policy-globalists, who has turned it into the field of getting profit for their earthly blessings (not with their own brain) as a result of their destructive irrational orientation!



lower elements in general Construction of people's being; it is also expressed with quite specific functional people's being.

⁴ Planetary cluster is a thoroughly adjusted model Construction of a separate planet, presented as a complex of energy gratings of the whole range of energies in their material and non-material relative stability.

The whole Earth System⁵ previously exercised its **Sirius**-oriented movement at a distance of about 240 billion km (for the Earth). The orbital model of arranging the whole Cluster System of the Earth was completely different, and the direction of the overall movement was not oriented to the Polar Star in the constellation of the Great Bear.

The main parameters of the Earth before the attack were:

- the inclination to the Ecliptic plane is 25°;
- day and night = 48.64 hours;
- a year =864 days (with respect to quantum fluctuations of the charge =1,007 sec.);
- the height of the gratings of the original Design of the atmosphere amounted to 12.000 km;
- the number of layers of the formed gratings of the Atmosphere was 18.

The level of the surface layer of the Earth had been almost 11 km below. The shape of the planet was more close to the shape of the ball; the present array of rock formations and other new built "garbage" had not existed. Unlike the intervention's design of the Atmosphere (now existing), the construction of the original one had been significantly different both by functions and in the structural plan. The construction of the gratings had started from the hardest of the plates, i.e., the Atmosphere had begun and built up over the plates (the hard coat). In the gratings of the Atmosphere there had been so-called "The atmosphere Brain."⁶

Before the intervention, the Earth had deservedly been defined as the **GREEN PLANET** and the «tourist Paradise», because there had not been any all-destroying enterprises in this similarity, especially smoking chimneys, since all the technology of the reproduction sphere had been based only *on the use of the energy received from the environment. Most manufactures of any product of any scale had been based on the technology of the model synthesis in the high octaves of the energies* with converting the created models to the physical plane in the end (through lower octaves of energy in the material plane, i.e. metallurgists

⁵ The System at the Cosmic body is created for the formation of that kind of biological Structure that, entirely is able to be under the System's control and to carry out the System's program.. The goals of the System: to ensure the performance of the Programs; to carry out Regular control of the Programs fulfillment.

⁶ The atmosphere Brain – Informations blocks formed in numerous chains so that to ensure and create various informational bases and structures united into a single System, and placed in the heights range from «-2400 m» to «12400 m».

had not been required, and metal working lessons at schools had not been practiced).

There had not been any oil, gas, peat and other stuff, not any sulfuric mud, and, especially, the technologies of combustion on the basis of sulfur.

There had **NOT BEEN** any diseases on the Earth, since the structure of **DNA** had been in the state of full activity, i.e., the operation of the cell of the flesh had been carried out in the full model state of all **FOUR** codons of DNA. ***This provided biological existence in the physically plan of the proto-Human up to 1300 years*** in the active mode of his useful cooperation in his being (however, it should be taken into account another length of day and year). A more developed Person, who for some reasons "was endowed" to develop others, had been able to exist in his physical form **for 10, 15 and 20 thousand years.**



A year ago, Israeli scientists published a public report in which the results of studies demonstrating that Human cells in **OPTIMALLY** favorable conditions **EXIST** up to **35 thousand years!** Note, the intervention System has **NOT** been **ABLE** to reach the secrets of the fourth codon of DNA, so, despite the populist achievements of geneticists and gerontologists, to extend the biological existence of the flesh cells was a failure. Moreover, at such low octaves of the Brain of the present people (maximum at the 63 octave) biological life extension longer than 125 years is not possible⁷. The solution of this question I "did seek" by upgrading and improving the **Program "SvetL"**. Only an increase in the level of at least up to 82 octave will make it possible to **extend biological life to 250 years.** But today a significant "step forward" has been made. There has been

⁷ Every biological object on the Earth gets its own life support system with birth, when loosing its ties with the organs (e.g. pericardial system) the brain stops the heart. The executive mechanism of the Brain is laid in the skull and in the stem of the spinal brain. The Centre regularly provides information TO ALL, and if the Brain is able to "pick off" and process this information, the biological structure is of rather high informational level. Only 4,28 % of the Brain are operational. The spiritual development of the Brain is contributed to its evolution (not religion).

found and **BUILT the Bath**. But as for being taken there or not being taken – it is another story!

As I previously mentioned in order "to make you happy" – exactly the geneticists and gerontologists of Russia through trial and error will be able to solve this problem; the first positive steps towards this have already been made.

1.3. Parasitic civilization – Ebrs

Six million years ago from ANOTHER space in that area of our Universe that now we consider as the Great Bear, there came into being a system of star groups of EBRs civilization.



Ebrs is the **EVOLUTION** of the protein **MIND**. In the material embodiment they are spiders of **2.5 to 4 meters** high, depending on their existing hierarchy of membership (for comparison, the height of proto-Human did not exceed 1.88 m).

For 5.5 million years Ebrs civilization had studied our Universe in order to find the opportunities to enter into the Community of Intelligent Civilizations of our Universe. But it was impossible to achieve that. So the decision was made to start active (violent) actions with the same purpose – to enter into the Community of Intelligent Civilizations of our Universe, but by pseudo-evolutionary **TRICKS**.

Before "attack", Ebrs had studied the structure of Space, got to know the Golden ratio and principles of redesigning the biostructures.

There began the approaching of ebrs system Starfleet from the Planet Sur (the area of the star **Megrez δ**) from the constellation of the Big Dipper (lat. URSA major) with interplanetary System of the Earth.

The Big Dipper (lat. Ursa Major) constellation is in the Northern hemisphere of the sky. Seven stars of **the Big Dipper** compose the figure that resembles a dipper with a handle. Two of the brightest stars, Alioth and Dubhe, have the luster of 1.8 of apparent star magnitude. By the two extreme stars of this figure (α and β), you can find the **North Star**. The best visibility conditions are in March-April. IT is seen on the whole territory of the Ukraine and Russia.

The Big Dipper is the third largest constellation, the seven brightest stars of which form the famous **Big Dipper**.

All the stars of the **Big Dipper** have their own Arabic names: **Dubhe** (α of URSA major) means "bear"; **Merak** (β) – "loins"; **Phecda** (γ) – "thigh" **Megrez** (δ) is the "beginning of a tail"; **Alioth** (ϵ) – the meaning is not clear; **Mizar** (ζ) – "the sash" or "loincloth". The last star in the handle of the **Dipper** called the **Benethash or Alkaid** (η); in Arabic, "al-Kaid Banat our" means "leader of mourners".

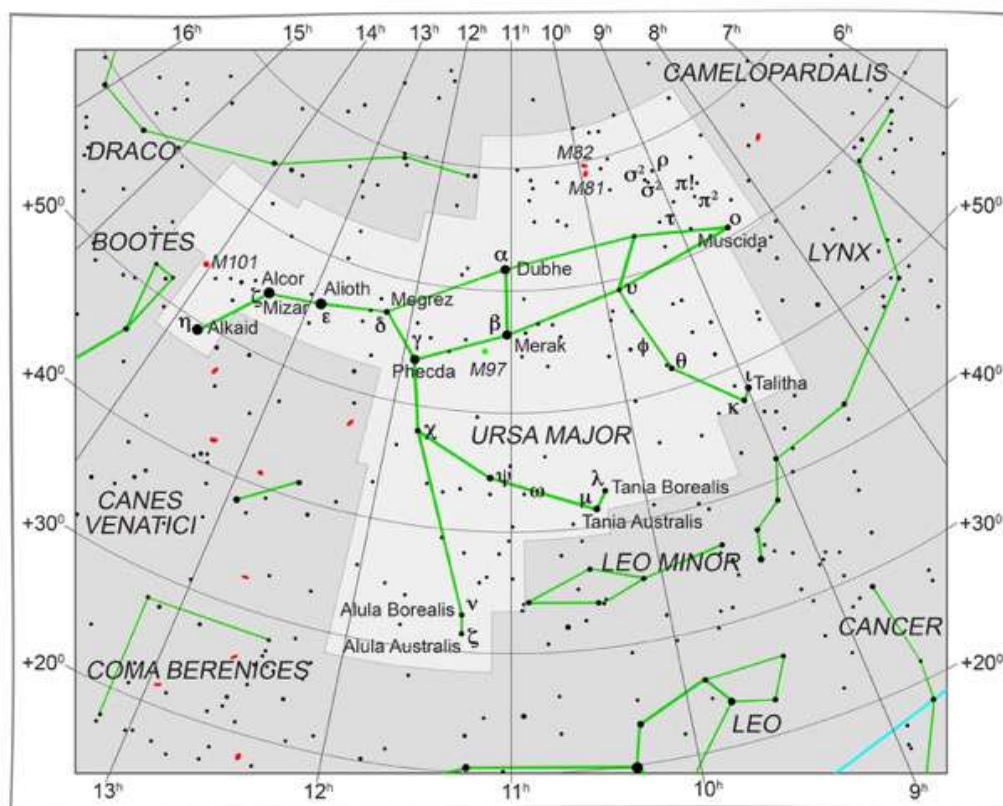

The approaching of Ebr system Starfleet in the constellation URSA major of the planet Sur with the Cluster Interplanetary System of the Earth began **26844 BC**. The Starfleet included: 1 planet the Sun, 3 the moons (Brain), 12 main objects of type 960, 54 satellites, 3862 objects of attack type 440 with the technical means of destruction.

The approaching continued for 8.5 thousand years.

1.4. The Attack

THE ATTACK at the Cluster interplanetary Earth System occurred **in 18344 BC**. At the Earth itself – some time later, i.e. at the **FINAL** time of **the TOTAL INTERVENTION**. The process of intervention should not be understood as a transient form of some of the fighting (Lots of fire by Hollywood scenarios, supersonic aircraft and clan contradictions of some of the lords, Hierarchs, etc.). *The capture process was carried out for 1040 years.*⁸

Ebrs interventional System did not have well concentrated operational and universal "build up" on any of its planets, taken for the accomplishment of the intervention. All minimally restricted, necessary and indispensable set of operational Complexes, and Objects to create such a control cluster, they had scattered simultaneously on several of their imported "satellite objects" and on the planets the Moon (**there were 3 moons** – Month, LELA and Fata), the Sun and other planetary objects. In addition, a large part of interventional planetary objects at the time of capture of the Earth **had been DESTROYED** by Phaeton (as the former element of the original mega cluster of the planets of the Earth modeling complex).

To gather all the necessary energy technological integrated cluster state of operation on one of the planets was **IMPOSSIBLE** for their level of technical perfection. But the Earth practically possessed such necessary perfect set independently. In addition, on the home planets, previously representing together with the Earth, an interplanetary cluster complex, to which now astronomers have given the conventional definition of "parade of planets", there was assisting and complementing set of the control

⁸ (The growing tragedy of the situation or evolution of the "forcible entry" into Nature?) Moscow. 2013.04.07.

complexes and objects being a single Model cluster complex of the Earth for its development for all forthcoming eight stages of civilization evolution.

It is for this reason they (the invaders) needed such a planet as the Earth. Associatively affecting the Earth with all of its imported technology and energy opportunities they **Would BE ABLE** to **CREATE** for themselves acceptable conditions of their own program simulated existence, parasitizing on the captured structural and energy opportunities of the Earth and its entire model complex (**only 12 planets without PHAETON**). So interventional blow to seize was applied to the whole Model complex. But after that capture the process of their own settlement began, and not only on the Earth, i.e. conversion and adaptation of all and everything.

The Control system was carried in the closed "thermos" like the Moon. The caravan consisted of hundreds of such Moons. The caravan was accompanied by "protection" that could eliminate the resistance of that part of the habitable Space, where the convoy would decide to settle. If the Parking lot looked attractive, it was included in the convoy and driven back home. That way acted those who arrived to the Earth System Planets. ***The system consisted of 12 planets.***

The purpose of the parasitic capture:

- the seizure of the Earth and getting it as an "energy pill";
- access to more energy-intensive sources due to perception of the mystery of the living cell;
- penetration into the secrets of the Human Brain.

A LOT of these the invaders have **MANAGED** to **IMPLEMENT**.

The sun is a planet, imported into our System (with the Moon), the diameter of the Sun is approximately equal to the diameter of the Earth. Our SVETILO-LIGHT (Jarilo)) was gone out and replaced by the Sun, which had an atmosphere with a thickness of about 2000 km, consisting of a mixture of oxygen and chlorine. The sun is hollow inside; there is life only inside (like in a shell). There is everything necessary to sustain the life that the aliens wanted to do all around our System. **The Sun had 231 objects, 127 of them are objects of type 440.**

Taking account of the objects it was roughly calculated the number of spiders (up to 4 meters high). **They turned out to be 1.200.000.** They all waited for a landing on the Earth. There were formed linking tubes of all the planets with reference to the Sun. Actually another space was being created that led to changes in the Earth's orbit (the orbital period of the Earth around

the Sun became 365,5 days instead of 630 around Yarilo). It was formed a protection ring around the contour of the Earth's rotation. Inside the contour there were formed the tetrahedral link tubes. The rest of the planets were locked to the Earth and had tubes of dodecahedra tetrahedral structure. All the outer planets were surrounded by the remaining escort.

After the formation of the cone the motion to the 4th star of the Great Bear began. This system of 7 stars is an outsider and arrived from another Space about 6 million years ago. In the system of the 4th star there are a few planets (12), the main is **SUR**.

But the Earth had different conditions, including the atmosphere. In addition, on the Earth there was some population differing in biology. At first it was decided to silence and then to completely subjugate the Brain of the Earth (Complexes) to the Control System of the intruders and to transplant the Brain of spiders in people (in biological structure). ***Here the problems sprang up.***

The principal task of the interventional Control System (CS) was not only to bring the finished system of planets home (Sur is from the Great Bear), but also to **ADAPT** themselves **to the PEOPLE** of the Earth (while keeping their own Brain).

The earth is the border of direct control that is why Venus and Mercury have no satellites. Their complexes are completely switched off, and from the point of view of the control they are of no danger. The Earth is the center of the Control System (and before the capture it was the Center of the Universe); all the other planets have their own Control Systems, part of which is switched on. It was impossible to destroy them since their structure was unknown to EBRs Control System, that is why they were surrounded with satellites, some of which had control functions. 15 satellites (yellow color) had tubes with reference to the Earth, the rest of the satellites were tied up with reference to one of the 15 satellites.

Each satellite is either the archive or storage of tritium, spare parts and so on. 15 main and 18 intermediate (painted over) had their own UFOs, which could only move in the limits of the satellite. The satellite orbits were chosen in such a way as to have maximum control of the corresponding planet.

Of particular interest is the Moon. This is a Software Generator (up to 88 octave). Inside the Moon there are powerful complexes. The glow

of the Moon is an imposing radiation of their own systems with 128 of the octave, set by the Sun.

The Software Generator used:

- the colliders of the Earth, beat interval combined with 128 of the octave;
- created gratings on the Earth;
- Meton calendar and metric system units of "Hulk";
- data archives of the satellites obtained by the complex 555 (Earth);
- control data to correct the Program.

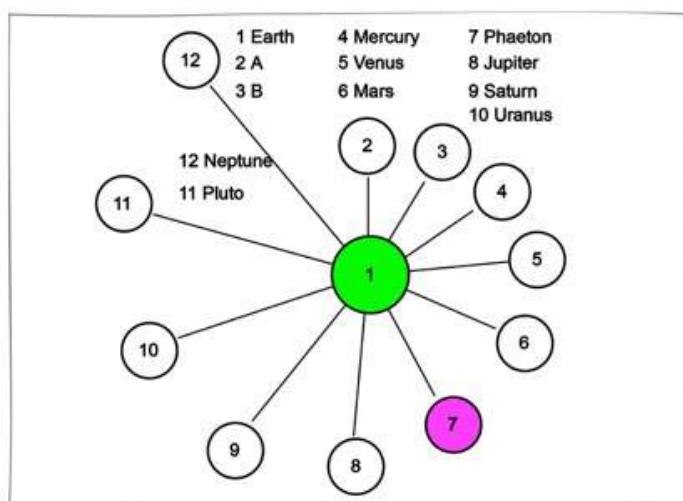

Time control and synchronization were performed by Stonehenge complex according to the data obtained from the Moon.

The moon has a special status that is why not a single meteorite from the meteorite belt does not fall on the Moon – the Moon objects (UFO's) control everything, in case of danger the Moon changes the density of gravitational potentials in the tube with reference to the Earth. Of particular interest is the **HALO** of the Moon (from Greek. ἅλως – circle, disc, aura, halo) the luminous ring around a source of light – maximum switching on of all Moon complexes and discharge to the Earth next portion of the programs. So all this talk that "**someone has been on the Moon**" – is not justified. The Man **HAS NOT BEEN on the Moon**, and he **CANNOT BE** in his physical form.

Each Program was calculated by Meton cycles – the 500 – year-program for 28 cycles and a 100-year program (from 1888 to 2000) – 6 cycles, 20-year program (1992 to 2011) – 1 cycle (final).

In connection with the correction of the Programs, there was a need for urgent replacement of the Power Supply Systems and Information SUPPLY systems on the Earth (objects 560).

The old objects were immediately removed; new ones were ready to start. Their location is known. **The start of new gratings in the atmosphere from h>-1240 and up to h=12400 m was to be produced in 2012 – it did NOT WORK.** (I'm a little ahead of time).

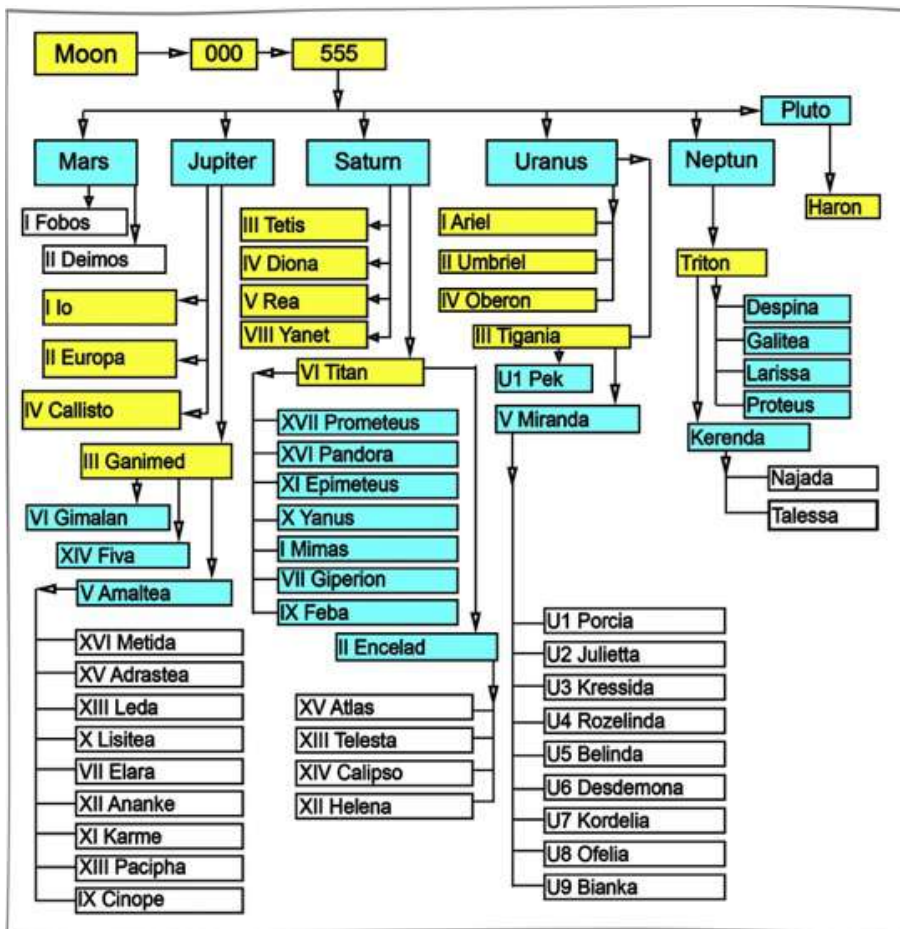

On the Earth there are other Complexes, for example, in the South East Asia. They were **NOT DESTROYED**; they have been used for their designated purpose.

The first Complex, which started to work, was **Ararat**.

After the formation of the grating with the carrier frequency the grating of "hearing" ("**in the Beginning was the word...**") was created; then in step-by-step manner the rest of the gratings were created. Specific frequency is created by a pyramid; it cannot be created with any modern equipment on

the Earth. As new Complexes were put into operation the **entire 12 groups** were created, each group having in its structure hundreds of thousands of frequencies.

Characteristics of frequency ranges

N	Frequency, HHz Range		
1	0,124	0,666	Carrier frequency k-structures ,used for everything.
2	0,666	2,16	Used by all animals, insects and majority of the population
3	2,16	4,28	Outer hearing 42x, 441 (33%)
4	4,28	7,24	Outer hearing 441 (66%), 442. For 442 information exchange with humanoids 442
5	7,24	12,4	Connection 442 with Alps 2
6	12,4	16,2	Used only by objects 440
7	16,2	22,4	Used only by complexes 560, 520, 500
8	22,4	28,8	Used only by object 960
9	28,8	33,2	Used only by object 960
10	33,2	66,2	Used by all complexes for interchange
11	66,2	88,4	Used for connection with the Moon
12	88,4	124,8	Connection with satellites

1.5. Phaeton Catastrophe

The Control System belonging to EBRs, constantly formed the sequence of events leading to the absolute seizure of the entire System of planets. However, there is one "but" –when attacking the System of planets, **2/3 of the guests** were eliminated, the planet (let's call it Phaeton) blew itself up together with the invaders.

At the initial stage of the interventional capture **18344 BC** only Phaeton was able to go into action with the aliens, as the planet, with its endowed protective functions for the entire Cluster System. The attackers forces in general terms were: **54 satellites, 3 Moons, the planet Sun** (it was a planet then), **12 leading objects (type 960) and 3862 attacking objects** (which had technical means of destruction, most of which are objects of type 440⁹). In addition, 1/3 of the satellites had their planetary objects of the active technical affect in the modeling scope of their satellites with limited autonomy (for simplified and traditional understanding – as if UFOs). The Phaeton Defenders took the whole active process of the

⁹ UFO is the facilities for the control of the outer environment (sonde type). All the UFOs on the Earth are at -3300> h> -4400 meters. The bigger part of UFOs is exactly under populated areas. ALL UFOs are near the water expansions where at the depth of 4400 meters there are sufficient reserves of tritium. Tritium is needed only for UFOs movement within the limits of the Earth.

destructive effects of the aliens on themselves and blew themselves up as a planet-fortress to prevent its "captivity", and, especially, to exclude the penetration into its technical ability of the protective and destructive nature. Phaeton destroyed 2 Moons, 11 principal objects and about 1200 offline attacks. Fragments of that destruction sometimes disturb the Earth's Atmosphere to this day.

Now this planet's orbit is a meteor belt. The Guests were unable to destroy the Brain of the Earth (The Earth Control System), as it was above their resources, even though it had no technical means. The rest of EBRS **SEIZED the EARTH** and other planets. The rest of the space fleet of the aliens became the satellites of these planets.

1.6. Restructuring (for themselves)

19304 years ago, the invaders started and realized the following:

- captured all the planets, made a clean sweep of all the flesh and their souls (non-inertial energy substances) captured;
- gripped the celestial system of the planet Earth utterly
- the planets of the Earth system were surrounded with satellites, as "an escort";
- began movement in the direction of the constellation of the Big Dipper (URSA major).

The first aggressive invasions for 1040 years resulted in the full capture of all the planets (the end of the grip in **17 914 BC**). **The capture, by itself, was symbolic**, because all the principal complexes on the planets of the interplanetary Cluster Complex of the Earth had been **TURNED OFF** before the seizure, and without knowledge of the structures of their construction, and assuming a lower level of their cognition, the attackers just tied all the planets with the gravitational tubes (hereinafter communication tubes¹⁰). They included the embedded base generating frequency of radiation protection of the Sun, surrounded the planets with "satellites" (as security convoy) and began moving in the direction of the Big Dipper, in order to

¹⁰ Connection tubes are sleeves like Shukhov's Tower where there is a necessary set of frequencies: gravitational and informational. Magnetic impulses that sometimes come from the Sun move to the Earth only in the sleeve. If there are no supporting frequencies in the sleeve magnetic impulses are dispersed in the Space (do not reach the Earth).

make it clear the area of its active reach. But on the way of the movement it was decided not to waste time and carry out some possible change in their favor...

A. Khatybov proved that the World around us **IS NOT SOMETHING** material separate and ideal separate – **is a united and indivisible whole**. Just this world is expressed in different sets of frequencies. This is the only difference. But through the perception Man was imposed the *illusion of the would being only material* and **SEPARATED** this **WORLD** from its mental and spiritual activity. Earlier, before the invasion, there had been no such perception of the world (via duality) in our Ancestors. *We can't call our Ancestors people or Human beings because modern Man in comparison with our Intelligent Ancestor is a Monkey compared to Man*, as paradoxical as it may sound. And "lowering" our Intelligent Ancestor to the level of a "modern" Man **WAS** made by external Forces. That explains the weird development of the entire Earth's history, with its countless wars and immeasurable violence, and strange evolution of science, which actually *enslaved the Mankind*. In what way and who all this was and is being carried out– we are going to make it clear in a serious way in this book.

Let us leave this trial "for a while". Meanwhile, let's take a closer look at what could have been the Creation of the Higher **Mind** of our petal-universe. Again have a look at the heritage of our ancestors-the Slavs – the Slavic-Aryan Vedas.

"In the ancient and glorious times in the land of abundance of Midgard-Earth, in a fertile ancient region, in the ancient and mighty Asia, which lay to the East of the Repeiskiy mountains (the Urals) and extended beyond the H'Aryan Sea, and from the chilly sea of D'Aryan to the greatest Himavat mountains lived four great Kins of Aces, the descendants of the ancient gods of Light, the four great families of Rousichi.

The great and most wise of Asa began to move into Asia from the **Sacred Land of Daaria**¹¹ in the ancient and glorious times.

¹¹ Daaria Land was situated on the Continent that sunk in the Arctic Ocean.

And **Families began to live** happily in this blessed ancient land from the beginning of time of prosperity, when even our **Great Forefathers** beheld **three moons**¹² in the night sky .

Ancient and wise, the Great Aces called this fertile region the Holy country, the country of kin's of Asa or the land of the Holy Race.

Multiple families of the wise Aces came into this fertile region of Asia from the Sacred North Land where our **Three-Light-Yarilo-Sun**¹³ **will not want to have a rest**, if only to witness the benevolent acts of all Light Heavenly Gods and the creations of their great descendants in the fertile Midgard-Earth."

Let us see some other sources of information to have a more complete picture of the chronological events on our planet.



Some of the extant ancient myths and Chronicles say that "the Earth existed, *when there was no moon in the sky above her*". Greek philosopher and astronomer Anaxagoras of Klazomen wrote about this in the 5th century BC who made use of the ancient sources, which did not come down to us and which claimed that the Moon appeared in the sky later than the Earth origin. In the III century BC it was supported by the Greek philosopher and poet, General attendant of the library of Alexandria, Apollonius of Rhodes.

In the essay "Argonavtika" he quotes the words of another philosopher, Aristotle, a century earlier, mentioning in one of his writings about the ancient inhabitants of the mountain districts of Arcadia (region of

¹² Three Moons: – 1) Lela, revolution period around Midgard –Earth (the planet of Earth) was 7 days; 2) Fatta, revolution period around the Earth was 13 days; 3) Month, revolution period round the Earth – 29,5 days.

¹³ Three- Light Yarilo-the Sun –An Ancient Ancestral Wisdom runs that the original Sun was called Three-Light as it lit three worlds: Yav (the world of living); Nav (the world of the dead; Slav – the world of the Gods.

Peloponnese), who "fed on acorns, **and this was in the days when in the sky there was no moon** Three Moons of Midgard- Earth. Writer and historian Plutarch, who lived at the turn of I-II centuries BC, says about one of the rulers of Arcadia named Proselenos, which means "Before Moon", about his subjects proselenitas, the first inhabitants of Arcadia. Modern scientists do not deny the possibility of the "**moonless**" stage in the history of the mankind and give different explanations. According to one of them, once **the Moon was one of the planets of the Solar system**, but then, because of some cosmic catastrophe, **left its orbit and became a satellite of our planet.**

You can draw a slightly different picture, **WITHOUT REPEATING** the interpretation of the publishers in the footnotes of the text of the Slavonic-Aryan Vedas and referring to earlier documentary sources. Our ancestors gave the name of moon to the satellites of planets. Since our planetary system was **CREATED ARTIFICIALLY**, everything was conceived and manifested in its unique structure in relation to many other planetary or solar systems of natural origin.

Certainty about the uniqueness of our solar system have appeared recently, when it became possible to explore open "exoplanets" (planets orbiting other stars) and discover that in other solar systems everything is not like in ours. Recently, on the subject, there was a small article under the name "**Solar system was born in a unique environment.**" "American and Canadian scientists using computer simulation proved that for the formation of the Solar system there were unique requirements, and it is a very special case among other planetary systems. The study is published in the journal "Science". Most of the previous theoretical models explaining the formation of the Solar system from a protoplanetary gaseous-dust disk were based on the assumption that our system is "average" in all respects. In recent decades it was discovered about 300 exo-planets – planets orbiting other stars. Summarizing these data, astronomers from the American Northwestern University (Illinois) and the Canadian University of Guelph, came to the conclusion that the Solar system is in many ways **a UNIQUE CASE**, and that its formation required a very special conditions."

One major change on the Earth was switch-over of the underlying basis for the formation of spaces **with dodecahedral to cubic basis** of the formation energy gratings. The imposed cubic¹⁴ energy grating, having

¹⁴ In the process of creating the Earth there was a working structure of another grating inside the cube, and cubical was used only for the control. More than 5000 years ago a certain system changed the

framed all previous state and energy structures, changed and restricted the status of the material world on the Earth to a level acceptable only for the strange Control Systems, changed all the conditions of the environment, including the atmosphere, water, biosphere, etc. Nowadays this process is **HAPPENING Vice VERSA**. The base of the space formation is shifting **from cubic to dodecahedral** basis of the formation of energy gratings. This has been considered in the creation of “Svetl” Programs as well. But there, this whole "procedure" is carried out through the design of Tor, as a kind of "Converter» of one design to another (without destroying it). About this – later.

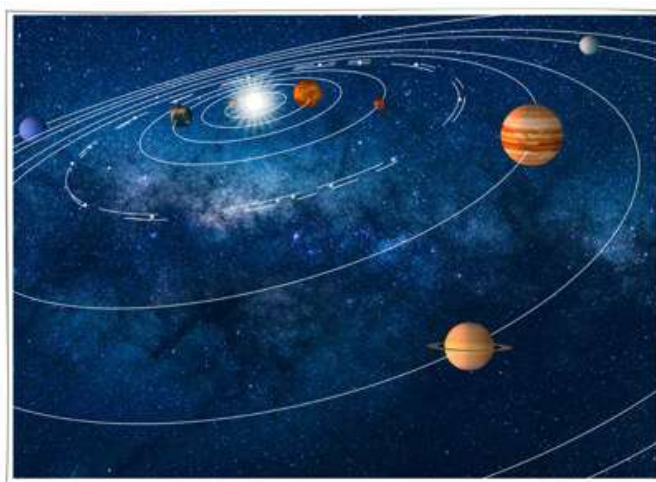

The satellites of our Planets played a special function – the protection function and the reflection function of our atmosphere albedo, which on the one hand, created the stability for the Planet and life on it, reducing the risk of getting random space objects by creating a **gravitational-electromagnetic oasis**. And on the other hand, **CONTROLLED** the **HEATERING** of the planet's atmosphere. This allowed the system of the light paraphase (our **Three Lights-Yarilo Sun**) evenly distribute the heat across the surface of the planet, creating the necessary conditions for the abundance of the vegetable kingdom – the Foundation of all life. Permanent vegetable photosynthesis gave the required amount of oxygen, such a valuable component of the gaseous environment of the Planet, both for the purpose of creating a robust ozone shield, and the saturation and evolution of the intelligent beings Brain for its **BETTER FUNCTIONING**. As it is

connection relations, and inputting its own elements, created a new type of grating, in which the whole world has been existing since. Its depth is 2200 m, height =12400 m. That is Noosphere or the world of environment and inhabitat.

known, lack of oxygen leads to the degradation of the physical cells of the Brain and reducing the lifespan.

The paraphase¹⁵ of the light is a shift at a certain value of the light pulse phase. For example, **at zero bias**, we have normal sunlight, **at 120° bias – night, at 240° bias** – the transition of night to day, or daybreak. This cycle is repeated daily, and no one ever doubted that **EXACTLY** the **SUN** is the source of light. In normal life **Man is protected**, which weakens the light beam at about 1000 times, and when Man is gone (dies), this protection is removed, and the sunlight becomes unbearably bright and the only source of heat, and that's why nobody wants to leave it. If Man dies at night, then the intensification is in the opposite direction, here the dying man tries to fight for his life, as he falls into the cold darkness.

This protection can be observed indirectly in the form of the refractive index of the space's boundaries of the protective field around one person or total fields of a group of people. Rainbow color indicates **SPACE DEFORMATION** produced by the seven forms of the primary matter.



Modern physics teaches that the solar light is both quantum (material particle) and a wave at the same time. If is an elementary particle, it is in the line with the other particles arriving from outer Space (**but nothing arrives from the Space, apart from the crumbled dust of the outer shell of the motion cone of the Solar system, and the incoming trash has the same structure as on the Earth**). There is no other

¹⁵ Paraphase is both the Brain function and simultaneously external conditions, e.g. sudden appearance and disappearance of the source of light in the determined phase.

information about the sunlight. But P. N. Lebedev's experiments on the pressure, produced by a quantum of light are known. However, the Sun is the principal information complex, producing the supply of necessary information to **all 12 levels** which are divided into frequencies.

The structure of quantum of light is "an egg".

At a certain phase of the atmosphere the required frequency information was given to someone more, and to others – less. There were regulations of the length of day and night, heat and cold. During these paraphrasing one program was removed and another program was delivered. Let me remind you that the ultimate supplier of the Program was the Moon. The external symptoms of the intake of the required octaves were manifested in the form of the Northern Lights, which no longer happen due to frequency changes in the Earth Control System.



Similar but the reverse of this process are visible in the appearance of vertical color columns at night and in frosty time of the year. Here the process of pumping the atmosphere from the earth takes place.

In this regard, we can conclude: when the frequency characteristics of the Earth Control System are changed the alternation of day and night is necessary.



But was it always necessary?

Is the alteration of day and night necessary for already-developed Intelligent Civilization? Had it been thought over another lighting system to accompany this unique experiment?

1.7. A little about the Sun

I got carried away a little, but (objectively) I specially touched upon these issues, just to show you a logical "Interrelation" and confirmation of the information from A. Khatybov and N. Levashov. And this (I hope you have already comprehended) – is an **OBJECTIVE PROCESS**.

As I have already mentioned, our **Svetilo (Jarilo)** had been **TURNED OFF** and **REPLACED** for **the Sun**. All the Planets were "located" with reference to the Sun with the help of the preformed connection tubes. The usual people's perception of the material world does not make it possible at first to take the word "turned off". There comes an association that something wrong had happened to the Sun. Had it exploded? Had it turned into a neutron star? Had it been stolen and swallowed by a crocodile, as in K.I. Chukovsky's poem? If it had been an explosion, the entire Planetary system would have perished. The transformation into a neutron star does **NOT HAPPEN fast**, and the gravitational forces of such a massive body just would have ripped the atmosphere off all the Planets. Even the notorious approach of **Planet X in**

2003 threatened the entire Solar system. There is one last option: ***the true system of the world, which is created by the atmosphere grating at the phase of light pulse at 0 was called Svetilo (Luminary)***. The paraphase speed is affected by the light parameters, color spectrum, brightness, flow density, the planet's code (for the Earth it is 512) and the distance from the sun. The octaves of the Original ECS were lowered, and since many principal systems of the Earth were captured by the invaders – they **HAD TO BE TURNED OFF**.

In search of a more complete understanding you can refer to another important source of information – **the book by N. Levashov "The Tale of the Light Falcon" – the past and the present"**.

"...our distant and not so distant ancestors called our luminary **RA** or **YARILO-the SUN!** In the same way our planet was called **MIDGARD-EARTH** and not just EARTH as we call it today! Because **MIDGARD** is the **WORLD** inhabited by **PEOPLE**. So for our ancestors ***the word "Sun" was not the name of our present Sun***, as well as "Earth" was not the name of our planet! Every planet, every star in those days had their own names, including the planet-earths and their suns which were distant for many light years. All the **LUMINARIES** and **PLANETS-EARTHS** had names that these celestial bodies were given not by our ancestors, but the inhabitants of those planets from distant constellations from which immigrants populated our planet Midgard-Earth in stages!" BY the time of capture, ***the world population had been 1.4 – 1.2 billion proto-Humans***.

This **IMPORTANT** and **KEY** information on the replacement of our Yarila (True Earthly light – White Light) for the Sun was first given openly in an interview with the candidate of historical Sciences, ethnologist, art historian, member of the "Russian Geographical Society" **Zharnikova Svetlana**



Vasilievna at the 2nd Vedic Congress in 2010. Unfortunately, Svetlana was gone in November 2015...

From **the writings of N. Levashov** it is known that for the emergence of life on the Planet, the following conditions are to be observed:

- the availability of constant differential dimension;

- the availability of water;
- the availability of the atmosphere;
- the availability of an alteration of day and night;
- the availability of atmospheric electricity.

This is true **for the origin and evolution of Life from the Beginning**. I emphasize, from the **BEGINNING** Without outside influence these processes take a lot of billions of years. Often Life has no time to develop up to Reasonable on one or another planet, not being provided with additional stability and protection – life support on the part of the Control System.

In the natural conditions planets are formed in the zone of the warped space at "the explosion" of the Super New Star. "In the process of the star compression the balance is upset between the radiating surface and the radiating volume. As a result, the primary matter is accumulated inside the star.

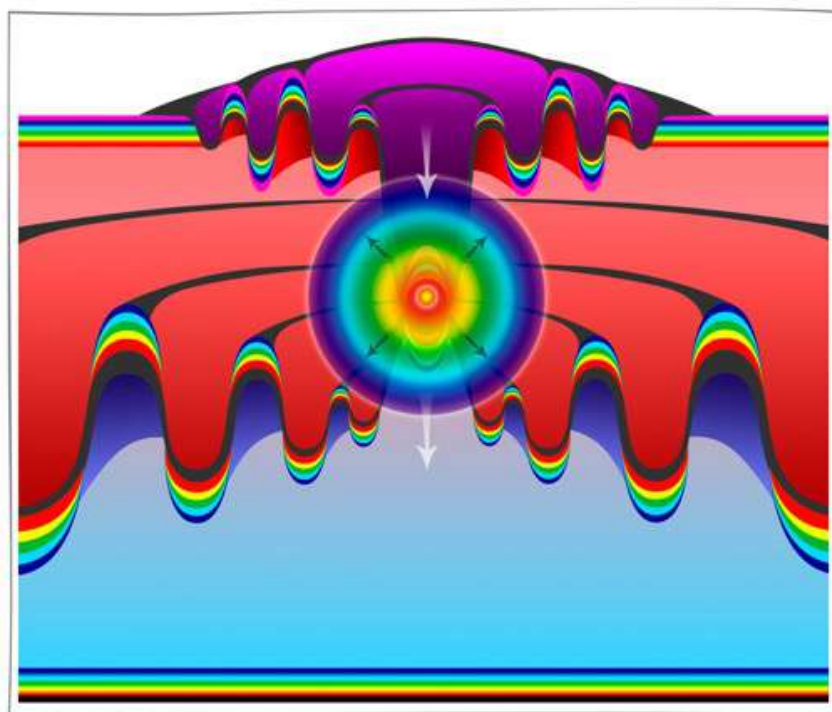

In the course of time, as a result of thermonuclear reactions, the star substance loses the simplest atoms such as hydrogen, helium, etc., and atoms of the heavier elements begin to account for a higher percent. **The size of the Star decreases**, it becomes more and more dense, heavy, and the degree of influence on the dimension of the surrounding space becomes

more and more powerful." The released matter of the star and Primary Matter are able to form a Planet of suitable size at a suitable distance from the source of deformation. All the Planets formed as a result of the Super New Star explosion settle down the planetary system not only in the Ecliptic plane, which is impossible to find in the Macro-Space, as it is unusual in its nature, but in harmony with the structure of the inhomogeneous space... According to materialistic views, the instrument observations, derived data and using computer models of stellar evolution "*the Sun will exist for another 5 billion years, **gradually heating and increasing in size.** When all the hydrogen in the Central core will be consumed, the Sun will be 3 times more than now. Finally, the Sun will cool, becoming a white dwarf.*" These are the conclusions of "modern scientists". However, I dare to disappoint them – it is not necessary to wait 5 billion years. Everything will happen (and already is happening) absolutely **NOT THAT WAY.**

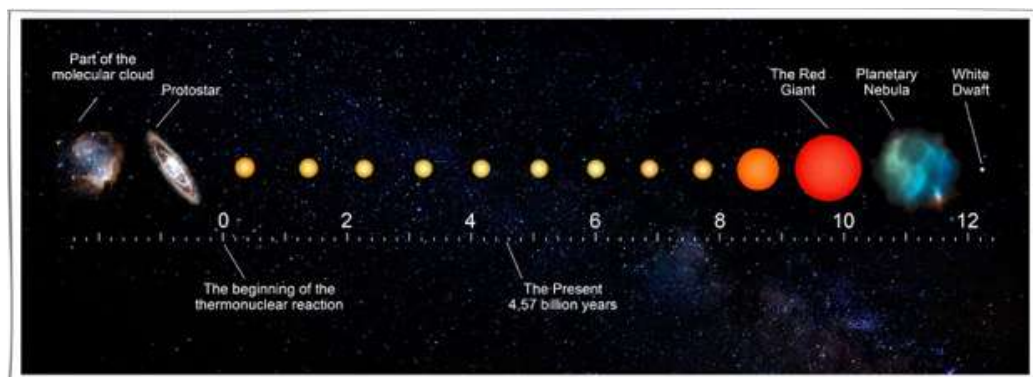

As you can see from the two descriptions of the evolution of the Sun N. Levashov's, and A. Khatybov's views and of modern science are **QUITE DIFFERENT**. We can assume that one of the sides is wrong. However, let's not jump to conclusions. **Nicolai Levashov in "Inhomogeneity of the Universe"** showed the process of matter formation and explained the birth of stars, their evolution and the formation of black holes or neutron stars. Astrophysics observe the particular Sun, and the observations show that the growth of the atmosphere of exactly our "star". But if the mass of the star compresses, according to the laws of gravitation no planetary nebula can be formed. There's something not consistent with the nature of the star itself. What could cause this anomaly? I will repeat myself in something, and draw your attention to the description of the Sun by **A. Khatybov**.

The sun is the planet that was "driven" into our System (with the Moon), the diameter of the Sun is approximately equal to the diameter of the Earth. It had the atmosphere thickness of about 2000 km, consisting of a

mixture of oxygen and chlorine. The sun is hollow inside, there is life only inside (as in the shell). There is everything necessary to support the life that the aliens wanted to create all over our System. In addition, it was necessary to replenish stocks, which there were on the satellites before the attack

Due to the abstraction of energy from the Earth a new atmosphere of the Sun has increased in size more than 100 times (the diameter is 1392000 km).

Current approximate structure of the Sun atmosphere

№		Layer thickness
1	Mixture of hydrogen and helium, t^0 about 3000°	19200 km
2	Grating Frequency 53,375, potentials density 127,4, body 111	332000 km
3	Grating Frequency 53,875875, density 121 and 100	128000 km
4	Grating frequencies of oxygen and chlorine, density 100 and 100	63000 km
5	Grating of protection 49 octave, density 100 and 100	146000 km
6	Hydrogen grating, octave 36,5, density 75 and 75	2000 km

The Sun has the frequency Converter. Receiving energy at **49 of the octave**, they transform it into 53,375, supporting radiation grating. The surface temperature of the Sun does **NOT EXCEED** 20 C. 49 octave was pumped out of the Earth (the Polar Lights) by means of special objects on the Earth.

The sun is a gravito-magneto-electric Generator of the motion of the entire Solar system. The sun is the beat Generator of the motion and this Generator is interfaced with the Life Support Systems of each planet. And there is no need to listen to the professor of the Hydro-Meteo-Centre, informing us that the cyclone (anticyclone) brought the temperature. This is a **LOCAL CHANGE** in the electrical parameters of Hartman frequency spectrum resulted in the macrostructures movement (the atmosphere). But back to the sequence of events.

1.8. The takeover of the planet of the Earth

18300 years ago the takeover of the planet of the Earth was carried out by the forces of the remaining Star fleet of the invaders. All the structures of the life support of the planet's Brain were annihilated, and it lost its potentials to the level of 3%, which further resulted in the elimination of all the inhabitants of the Earth in the short period.

At the same time, the following events occurred:

- the annihilation of the true Complexes of the Earth Control located on the surface;
- formation of the areas of paradise for the invaders' existence;
- annihilation of the life Support System on Mars;
- turn off the life support system of the other planets;
- formation of the system of satellites around the planets;
- the beginning of the structure transforming the captured planets.

The Earth Brain prior the **ATTACK** had had the **512 octave**. The planets-invaders' **Brain** was of the **224 octave**. Subsequently, for a number of reasons of incompatibility under the new conditions of the Earth, this invaders' Brain up to the 66 octave **WAS ANNIHILATED**. The remaining structures of the Earth managed to keep the Brain of the 57 octave for a short time (mainly in the Equatorial area). With the further reduction of its level, the population decreased by 67-68%, and there were only **about 2 million people** with their subsequent dying out.

The Easter complex as one of the true main complexes of the escort (located under Easter island at $h=-12450$ m) was completely off. After a series of the Program processes on the part of the interventionists ***Man was transformed into a kind of biological being, deprived of the former independence of the Brain.*** This is the foundational information that makes it possible to understand all that happened afterwards, up to the present day.

What is this program link with the Sun, the moon and the planets satellites like? What part did it play in the overall evolution processes of the human Civilization and conscious evolution of an individual and public, in particular?

Technically, this link looked like **a SPECIFIC SET** of the **FORMED** "Link Tubes" with the Earth, on the one hand, and the Moon, the Sun and the planets Satellites on the other hand. By means of such link tubes it was carried out the transfer of information from the invaders' generating and Control systems ***placed beyond the Earth, to the complexes of the same Control System, placed on the Earth.*** This program information contained everything required for the control the entire imposed development of Civilization at a conceptual level.

First and foremost, it is through this connection it was ordained the **FORCED RETENTION** of the people's performing actions in their applications in the same way as consumer goods in all the program processes controlled by the interventional System, and, accordingly, step by step

preventive development of an individual and public conscious before every historic eventful executive step. Using the same information, the Conceptual level Control of all the processes of energy being in general in their changed structural state was executed. Monitoring and protection was formed to prevent any structural changes in the energy gratings by the true Earth complexes, the retention of such complexes in "captive" state and so on.

The Earth was populated with people that were differed in biology. Therefore, the decision was made **to ANNIHILATE the EARTH BRAIN and transplant the Brain of spiders into people (their biological structure).**

Since that time, especially in the last **4000 years**, the **interventional Super-system**¹⁶ using the changed System of the surrounding structures have conducted a great deal of process monitoring (including all life-support Systems, the Earth Biocenters that create and support the Man) and **DIRECTLY the MAN HIMSELF.**

For these purposes, the invaders put into operation the Program of **"Energybiogenesis of the flesh cells,"** which was becoming more substantial in the reinforced attempts to create people (like a kind of proto-Human), for the spiders' **FLESH** (which were the invaders) was **IMPERFECT** and unacceptable to get "the entrance to the Hierarchy of Civilizational evolution of the Intelligible orientation" (as, however, and the design of their Brain, too). This was ultimately one of the reasons for the **TERMINATION of THIS KIND of EXPERIMENT** and **the beginning the process of returning to the starting "point"**, what is actually happening today before our eyes. Who realizes it and how it is realized is of less importance. Of primary importance is what is happening, and no one and nothing are able to stop the process.

1.9. Available Means

If You are left in a boat in the middle of the ocean, You **WILL NOT** study the structure of the boat and the method of fixation the frames. First and foremost, using all available means, you will try to determine your whereabouts and then sail in the direction you got to know. Exactly so did

¹⁶ Interventionist- super system -is the Program connection with the Sun, the Moon and planets satellites.

those who arrived in the Earth several thousand years ago. First, the coordinates were defined, the "milestones" were set and the conditions created to move the entire System (like JOHN Swift's Gulliver, who dragged the ships) in the **RIGHT DIRECTION**.

A special place in the "ancients" studies belongs to **the Big Dipper**, which is described in detail by **N. Morozov** in his multivolume work "**the Christ**." In addition, on the Earth it was built (there is no clear answer what for) quite a lot of pyramids, and in the process of more exact definition of their coordinates, many of them became unnecessary (the pyramids of Maya, the pyramids in Ecuador, etc.).

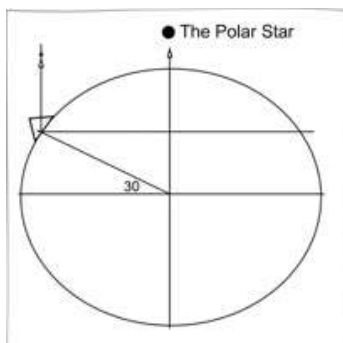

The calculations show that the pyramids were set up as a **SYSTEM** of **CONTROL** on the ways of the Power Lines of the Earth's Complexes. The Ecuador pyramids' ramps pointed to Benethash star of the Great Bear. All the pyramids were built not on a randomly selected place and, of course, the calculations were made not on the sand. The calculation accuracy of some constants is **up to 124 signs** (determined by indirect calculations, when the ratio of dimensions lead to a constant) **AFTER** the **DECIMAL** point.

So **the first conclusion**. Upon arrival in the Earth, that had already had its own civilization, **Ebrs** (aliens, after N. Morozov) first marked their location by doing layout work and putting stakes, besides using the UFO's computer system.

How the Solar System was deployed and where it is moving today is a separate issue? Let us consider one of the most important systems of the control – **Cheops Pyramid**.

Many Scientific works (as to pyramids in general) were devoted to Cheops pyramid, and all of them stated the existence of the pyramids, piling theory of their construction, as well as derive practical results by dragging the mummies from pyramids to museums.

Many deaths of the pyramid researchers are ascribed to the "curse of the pharaohs" of those who disturbed their peace. We see only the **IONIC PART** of the **COMPLEX**; to explore non-inertia mass of the pyramids the Humankind has **NOT** yet **DEVELOPED** the instrumental base. Here are **A. Khatybov's** calculations, only a small part of which has become public today.

The Pyramid of Cheops

Looking ahead, I would note that the Pyramid of Cheops is located on the territory with coordinates **30° N.L.** and **30° E.L.** and the north side of the pyramid facing North, precision 2'.

The first pyramid with the inclination of **52°** and the entrance angle of **28°**, where the North Star was visible was the pyramid near Medum. It is destroyed (It is thought – by an earthquake). Its dimensions were smaller than of the later Cheops.

The desire to keep the **angle of 52°** and the slope of the entrance with visual surveillance of the North star is not accidental. Besides, the correlations of some values indicate the angle of inclination of the pyramid side.

Let us make a circle with radius $R=h$, i.e. equal to the pyramid height (h).

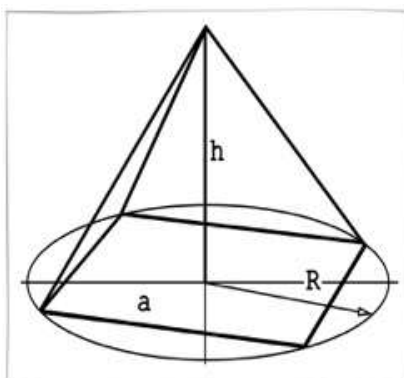

correlation:

$h=146,75$ m;

$a=230,62$ m;

$R=146,75$ m;

$$\frac{\pi * R^2}{a^2} = tg(51,84^0)$$

The second conclusion.

During the construction of pyramids, the used system of physical units remained secret. Translations into the existing measurement system do not give any idea about the meaning and purpose of pyramids.

Some of the correlation values in Cheops pyramid point to the existence of a hidden (maybe, the main) pyramid, the exploration of which with modern technical means is impossible.

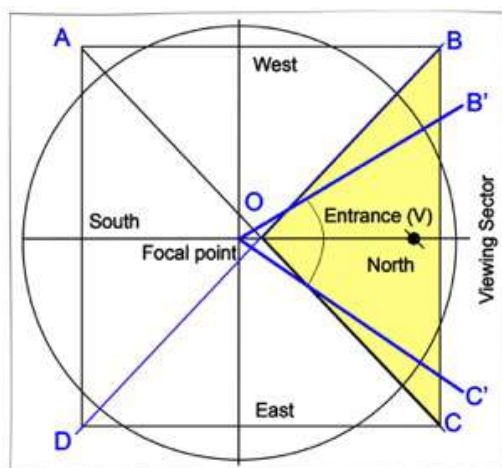

Let us consider Cheops pyramid from the point of view of the Control System (Cheops pyramid is the control data transmitter for the Earth Motion Control System and for the Solar System).

Index SU FS and SS=555 (from the command texts).

Parameters of Cheops pyramids:

Side: $AB=230,62$ m;

Height: $OG=146,75$ m;

The height including the cut: $SG=138,38$;

Side: $OA=219,38$ m;

The side projection OA (AG)= $163,07$ m;

The plane inclination angle = $51^{\circ}84'$;

Entrance height = 18 m;

Volume (without cut top): $V=2601238$ m³.

The contour of Cheops pyramid encloses the other Pyramid, which is the principal one.

The great pyramid has some structural features: Southeast corner is higher than the North-West by 2 cm.

The size of the entrance is **rigorously calculated** (see below).

The deviation of the sides = $3,6'$ (orientation to the parts of the world).

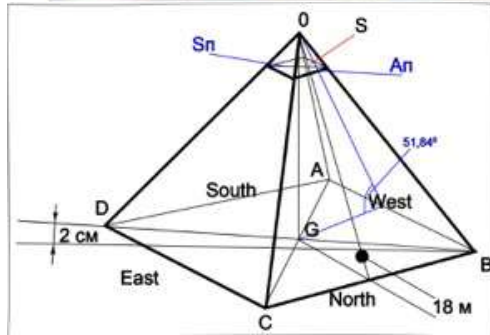

Angle AOB=63,4°=63025'

2*AB/OG=2*230,62/146,75=3,1430;

Side of the site An=13,15359 m;

Site square Sn=173,0169419885 m;

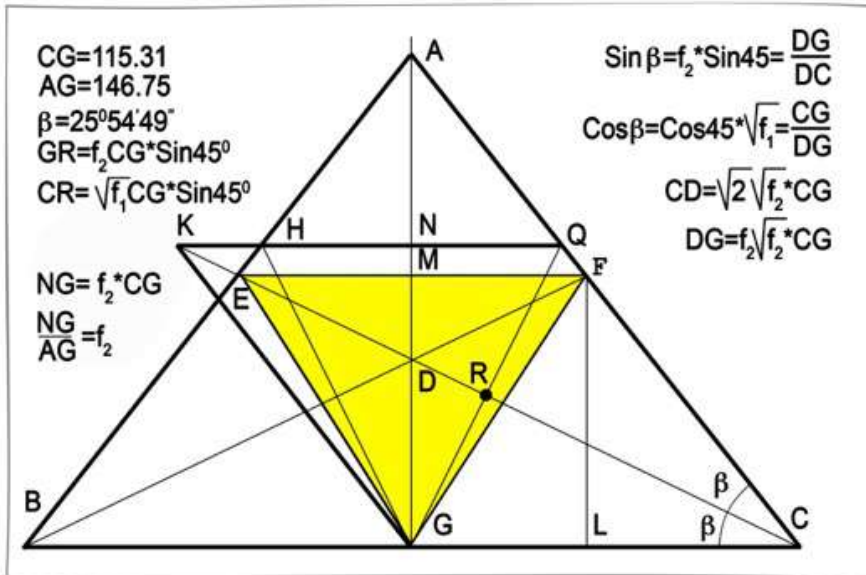

In compliance with the Golden section we have:

$$\frac{CG}{AG} = \frac{115,31}{146,75} = \sqrt{f_2}$$

Angle $\beta = \text{FCK} = \text{KCG} = 25^\circ 54' 49''$;

Angel $\text{FCG} = 2 * \beta = 51^\circ 49' 38''$;

KQCG – full rhombus.

It is the rhombus that forms the spiral of the Golden Ratio, the format of the rhombus is laid in the angle of inclination of the pyramid plane. The height of the pyramid is offset by 6° towards the South of the ratio:

AB=230,62 m	CS=71,27	MG=113,9	NG=FG = 128,82
AC=115,31 m	AS=44,04	OA=186,63	OE=128,56
OC=146,75 m	S'G=174,00	MQ=132,36	CS/AC=0,618
OP=173,05 m	FP=18,188	FM=58,00	$4 * \text{AC}/\text{OC} = 3,1430$
OF=174,00 m	EG=101,02	OM=116,00	OM/OF=0,6666..
OR=264,00 m	EE'=13,512	GA'=18,188	FR*OM=100*AB
FR=198,54 m	GE'=114,53	ON=MN=FM=58	

Point S' is diametrically opposite to the point S.

Angle $\text{BFC} = 67,5^\circ$ – viewing sector.

$\text{SIN } 6^\circ = 0,1045284$.

$\text{COS } 6^\circ = 0,9945219..$;

$\text{TG } 6^\circ = 0,1051042..$;

angle $\text{OAC} = 51,840$;

angle $\text{FOP} = 6^\circ$. the pint F – focus, the line **with reference to the Earth gravity centre.**

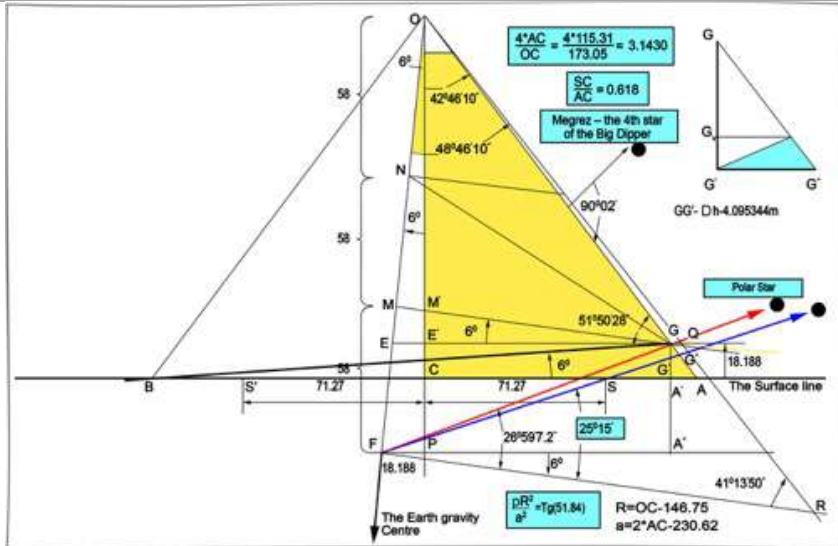

angle $FRO=41.230577^\circ$;

$\text{Sin}(41.230577^\circ)=0.4537626$;

angle $G''FR=26059'7.2''$ (26.985347°);

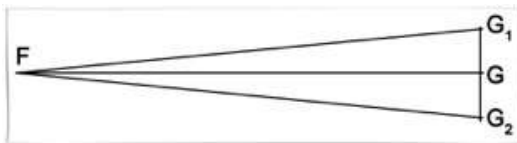

The angle $FOP=6^\circ$. Point F is the Focus, the direction of the line **to the gravitational center of the Earth**.

$\text{Угол } FRO=41.230577^\circ$;

$\text{Sin}(41.230577^\circ)=0.4537626$;

$\text{Угол } G''FR=26^\circ 59' 7.2''$ (26.985347°);

GF is a cone, the star comes out in the funnel at $12'$, $G_1G_2=0,4461769$ m. The line G_1G_2 is divided into 6 parts, Medrez passes one section for 144 steps of transmission, that is 2 minutes.

If the ionic grating has 32,22502250 communication structures, hidden pyramid has the grating 53,625. By the way, **EXACTLY** in this pyramid the "curse of the pharaohs" is laid – frequency radiation (gamma rays).

Angle $GFR=25^\circ 15'$ exactly this line (or rather the angle $25^\circ 15'$) determines the inclination of the equator to achieve 0 albedo, and cannot be violated in connection with the complete imbalance of the Control System.

Parameters:

$EG=101.01863$ m;

$FA'' = 119.21$ m;

$G'a'' = 41.628819$ m, $GA'' = 45.724163$ m, $GG_v = 3.2125163$ m;

$GA'' - G'A'' = 4.095344$ m;

$Tg\ 25.25 = 0.4716306$;

$Tg\ 19.25 = 0.3492156$;

$Tg\ 20.985347 = 0.3835706$.

The sequence of passing the world pole:

π, η Hercules;

τ Hercules (VIII-VII BC);

ι Dragon (5500-3500 BC);

α Dragon (Tuban) 3500-1500 BC.

β Little Dipper. (COHAB) 1500 to 1 BC;

Cohab, and Cynosura Little Dipper. (Guards), when the world pole was between them;

α Little Dipper. (Cynosure) 1100-3300 BC;

(Guardians were announced β and γ Little Dipper) Cepheus (γ Albano) to 5000 BC (β Alfaro) to 6500 BC (α Alderamin) to 8500 BC;

Deneb, and Sandr (γ Swan) VEGA (α Lira) in 13000 BC (6th time);

Polar (α little dipper – Cynosura) will pass by the pole of the world with accuracy at $27'$ in 2100r.

Since the world pole walks about the constellations, then, together with it there occur changes in the location among the stars and of the celestial equator, and the point of the vernal equinox from which the celestial coordinates are measured.

The precession cycle of the Earth's axis is the Platonic year.

The third conclusion. The Solar System motion to Megrez star is on Archimedes spiral.

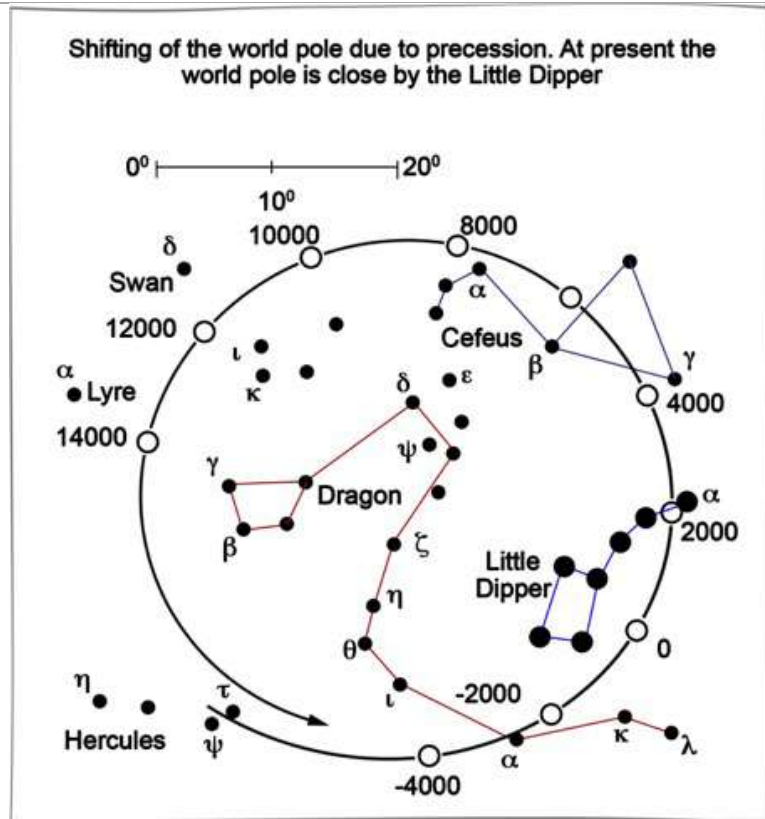

CALCULATIONS on Archimedes spiral has **ALLOWED** to find out the Ebrs arrival time in the Earth, and the uniform rotation of the world pole while moving on Archimedes spiral is incorrect.

The fourth conclusion. Ebrs appeared on the Earth approximately 18300 years ago, annihilating the Brain of the previous civilization.

Back to the pyramid of Cheops. First of all, some correlations:

$\beta = 23^{\circ}27' = 23.45^{\circ}$ – the equator tilt to the Ecliptic plane;

$\gamma = 5^{\circ}08'43.4'' = 5.1454^{\circ}$ – the Moon equator tilt to the Ecliptic plane;

$\alpha = 28^{\circ}35'43.4'' = 28.5954^{\circ}$ – the total angle.

For 1 year (365.26 days) the Earth passes a distance $L = 149.6 * 2 * \alpha * 106$ km = 939964520 km;

Speed $V = 29.785678$ km/sec;

$V_{\text{vert}} = 14,256062$ km/sec;

$L_{\text{vert}} = 449887100$ km.

The sum of the angles (the direction to the Polar star of the pyramid plus the inclination to the Ecliptic): $46^{\circ}54' = 46,9^{\circ}$;

The angle of inclination of the plane of the pyramid $51,84^{\circ}$;

Difference $= 4,94^{\circ} = 4^{\circ}56,4'$. The difference with the Moon $= 0,2054^{\circ} = 0^{\circ}12'19,4''$;

Distance $AB=L=939964520$ km;

Distance $AC/2=131352001$ km (the distance to the Sun, or 1 astronomical unit).

The solar system moves in a spiral. In this system the Earth moves in a double spiral (the revolution around the Sun and rotation together with the Solar system).

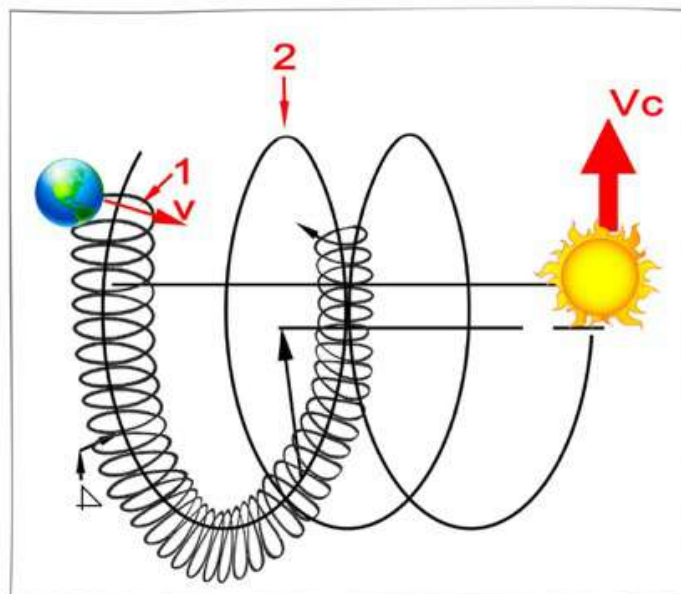

The Spiral of Archimedes

1 – The trajectory of the Earth in rotation around the Sun;

2 – The trajectory of the Sun.

According to Astronomical observations, the Solar system has been changed 5 times for the Polar star, but how and why science has not known.

The distance between the turns of the spiral $= 2 * p * S_{vert} / w$;

$w = 28.59540 = 28^{\circ}35'43.4'' = 0.4990838$ rad;

If we take $w = 28.647890 = 0.5$ rad, then the difference $= 0.0524897$ rad $= 3^{\circ}8.96''$

The accuracy of the orientation of the compass at the pyramid of Cheops = $3.6' = 3'36''$.

For the precise orientation it is **NECESSARY** to change the angle of inclination to the Ecliptic that is why the second (hidden) pyramid is needed. This pyramid is with the floating geometry (up to the 54 octave). If the angle is constant, we have the logarithmic spiral.

Some oddities

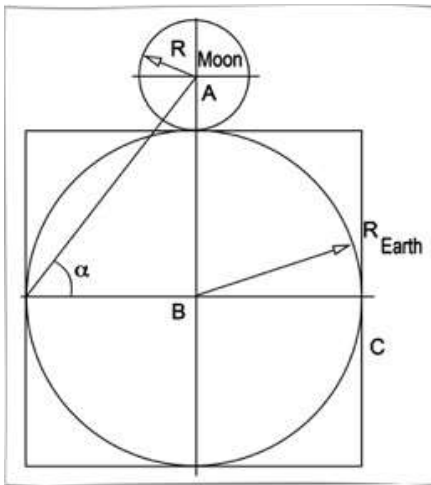

The Earth Radius $R=6378$ km;
 The Moon Radius $R=1738$ km;
 $R_{Earth}+R_{Moon}=AB=8116$ km;

$$\alpha = \arctg\left(\frac{8116}{6378}\right) \approx 51,50267^{\circ}$$

Inclination angle of the pyramid plane = 51.5040 ; $4 * C = 8 * R = 51024$ km;

$P = 2 * 8116 * \pi = 50994.331953..$;

The difference = 29.7 (within the limits of the calculations error) Ratio of the surface square (round the Earth) to circle square with radius AB $D=0.78631...$, и $\text{Arc sin}(D)=51.840$.

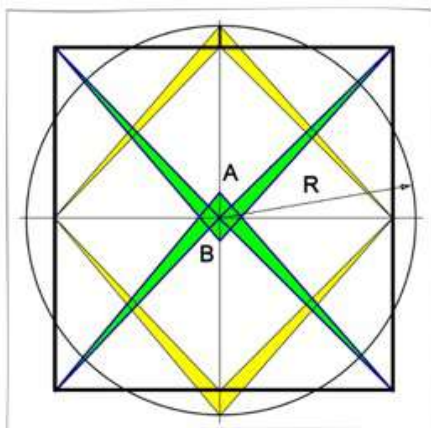

Mason Cross (a pair of compasses).

Circle and square perimeters are equal.

$R=f_2 = 1.618...$ $C=2 * R * \pi = 10.1664...$

Square side $a = \frac{2 * R * \pi}{4} = \frac{R * \pi}{2}$

$a=2.5416017...$ (Inch);

$\frac{a}{2} = 1.2708..$ $AB=0.6944678$.

Inch is obtained from the problem «circle quadrature».

$\frac{a}{R} = 0,7850258..$ $\alpha = \arcsin\left(\frac{a}{R}\right) = 51,757927..$

Roughly CHEOPS pyramid angle. Calculation accuracy might be any. Inch value does not depend on the quantity.

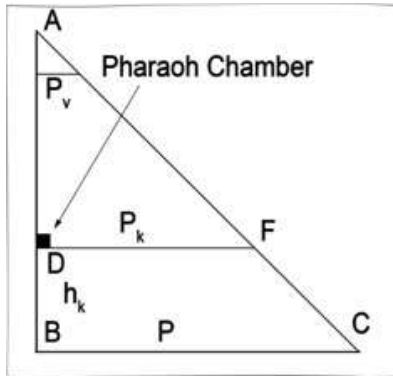

$$\frac{P_K}{P_V} = 6,1988$$

$$\frac{P_K}{h} = 0,555614874105621$$

Pharaoh Chamber – surface section = half surface of pyramid base.

Pyramid base $S=53185,5844 \text{ m}^2$

Surface at Pharaoh Chamber level –

$S_k=26592,7922 \text{ m}^2$;

Half side of the base – $P=115.31 \text{ m}$;

Half side of the cut – $P_k=81.5364829 \text{ m}$;

Pharaoh Chamber is at the height of –
 $h=42.98207986 \text{ m}$;

Reverse value $\frac{P_k}{h}=1,79980782565739$;

Value of 0.555 is of primary importance in Genetics. That is the code of the complex as well.

All 3 pyramids are on the spiral of the Golden section.
Sphinx's gaze is directed at Sirius. It became known only about 1985.

Path extending from the third pyramid is directed exactly to another point in the proportion of f_1 on the large side of Golden Sectioned rectangle. If you cut the rectangle vertically this line runs exactly along and parallel to the plane of the vertical pediment of Sphinx headdress. If you **EXTEND** the

LINE of the south base of the second pyramid, it touches the Sphinx's right shoulder, marking a special place.

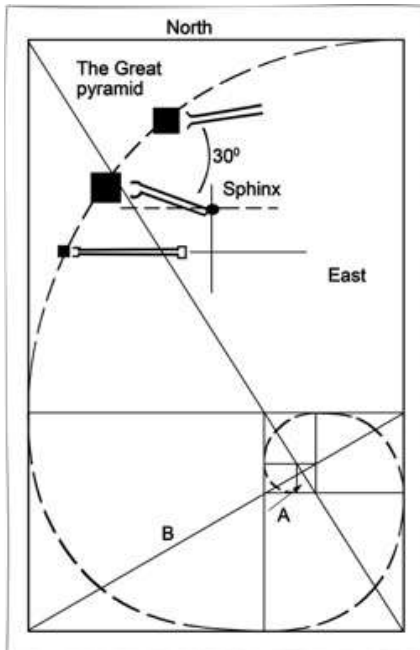

The central line that is equal to the long side of the Golden Sectioned rectangle and **EXACTLY PASSES** the front edge of the headdress. In other words, the headdress marks the exact center of the longitudinal direction of the Golden Sectioned rectangle, proving that Sphinx is placed in the sands not accidentally.

Why the line B is marked? The astrological wheel was taken with reference to the North pole and placed on the line with Cairo. The end of the line appeared to be at a special place on the planet of Earth – the area of 4 corners in the United States – the border of the states of Utah,

Colorado, New Mexico and Arizona. For the Indians the area of the 4 corners is marked with four mountains. The angle of inclination of the plane of the pyramid (calculation) is $51^{\circ}51'24''$.

If the pyramid is built correctly, it will pump water without any moving parts.

If we drew a circle on the Earth, its diameter would be 4 km (2.5 miles). It was believed that East is the direction where the pyramids and Sphinx are faced, but this is incorrect. Three oriented East **PYRAMIDS' FACES** are on the lines converging at one point on the horizon (on the arc). The point on the horizon is the point of helioarcic rising of Sirius, which is located not directly in the East.

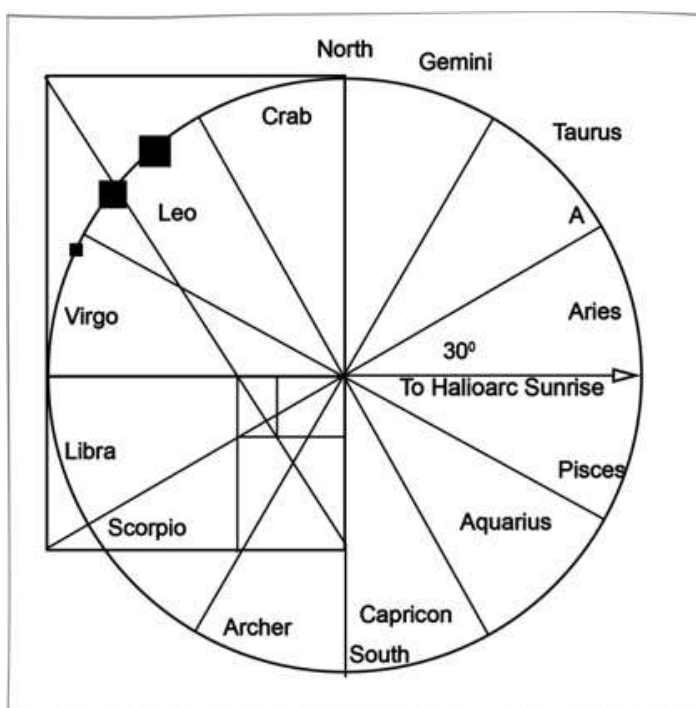

On July 23, Sirius rises one minute before the sunrise and at that moment, the Earth, the Sun and Sirius **MAKE** a **STRAIGHT LINE**. The eyeballs of Sphinx are gazing at the same place. The 12 sectors are the wheel of time. The three pyramids were placed on the Earth exactly according to the three stars of Orion. Deviation is $3.6'$ due to the orientation.

Pyramids are in the constellation of Virgo and Leo. If from the vertices, angles, etc. extend direct lines through the center, it will point to the range of accurate dates between Aquarius and Pisces, that is, for the period of time in which we live – the Age of Pisces transiting to the Age of Aquarius.

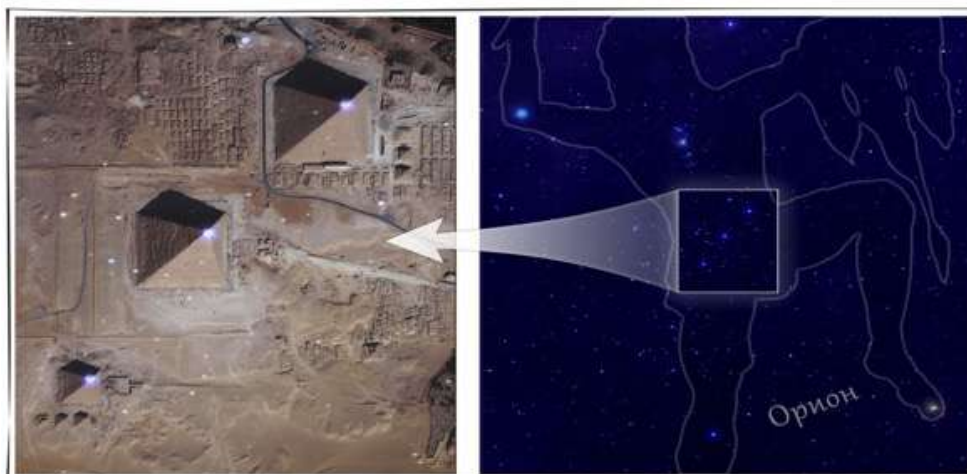

It is appropriate to mention some "tales, discoveries, speculations, and nonsense," etc.

The DOGON TRIBE in the district of Timbuktu (Mali) where there are rock carvings of fish, of Sirius A and Sirius B (revolutions around Sirius A), descriptions of Siriuses. The Information was confirmed **in the 1980-ies**. The Dogons knew what Neptune, Pluto, Uranus look like when approaching them from Space. On the rocks there are carvings of the paths of Sirius A and Sirius B for the period from **1912 to 1990** (confirmed by calculations). In Africa, where the Dogons live, the ***Sirius Star disappears from the horizon*** and is out of sight for a couple of months, and then in the morning of July 23, again appears in the sky for a moment before the sunrise – ruby-red, shining, almost **EXACTLY IN the EAST**. After 60 seconds the Sun is rising – it is a heliacal of Sirius (in the rays of dawn). At this point, Sirius, the Sun and the Earth are aligned on the same line.

In many **TEMPLES** there is a tiny hole in the wall, there is a similar small hole in the other (opposite) wall and so on until a certain dark room. There is something like a cube or granite rectangle of Golden section, located right in the centre and having a small mark. At the moment of the heliacal rising of Sirius ruby-red light falls on the altar for a few seconds, which means the beginning of a new year and the first day of the Syrian, or Sotichic calendar.

It is established that the **SOLAR SYSTEM MOVES** in Space helicoidally, in an elongated spiral which is a close relationship with Sirius.

Not only the Dogons, but the Sumerians knew about all the outer planets: – what the Solar system looks like when it is approached from the

Space. The Sumerians described the relative size of different planets as if they flew past them in the Space. They described what the planets looked like, what color they were (3000 years BC). They knew about the equinoxes precession. They knew that the tilt of the Earth's axis to the plane of the orbit around the Sun was 23 degrees and that it made a full rotation in a circle over a period of 25920 years.

Between Mars and Jupiter THERE WAS Tiamat planet (or Phaeton, destroyed during the capture).

Every **3600 years**, the planet Marduk (Nibiru with the Sumerians) enters the Solar System. This planet, that "flew into" the last time, became a real threat to the Earth. Its trajectory has been changed by N. Levashov, having described the events in his book. The movement of the planets is usually between Mars and Jupiter.

The third planet, coming out of Sirius B (Oceania), is home for whales and dolphins. The planet is completely under water.

All pyramids are **LINKED** with the **STRUCTURE**, made in line with the spiral of the Golden section.

From Ushmal (Yucatán Peninsula), it was laid down 7 churches, similar to 7 structures along the Nile. From Ushmal to Labna, then in Kibu, further to Chichen-Itza, then to Tulum near the ocean, and then descends, passing close to Belize and Kohunlich and then turns along the mainland to Palenque. From Palenque the structure is divided, going North and South.

To the South up to Tikal in Guatemala (the beginning of a new octave). In the end the spiral passes such places as Machu -Picchu and Sacsajuaman near Cusco, in Peru. One of the main spirals ends in a place called Chavin in Peru (where there was **THE MOST IMPORTANT** religious center of the Inca Empire). From there it goes to the Titicaca lake to a point half a mile from the Sun Island (Bolivia), and then makes a turn of 90° and goes to Easter island and finally to Moorea, where it goes into the ground. This structure is called **"women's component of the grating"**. This is the information structure that runs along the base complexes of the Earth. It is intended for the control.

The "male component of the grating" moves to the North of Palenque. It passes through the ruins of the Aztec Empire and up to the pyramids of American Indians (Albuquerque, New Mexico State). Then the spiral runs to the Blue lake near Taos (new Mexico), which is the very image of lake Titicaca. This is one of the most important areas of the United States, which

had been protected a long time by the Indians of Taos. Near the Blue lake again is makes 90- degree turn. From there the spiral moves along the mountains, passing through Ute mountain (near the border with Colorado) and other mountains and artificial structures. Before leaving the California coast, the **SPIRAL PASSES** through lakes Tahoe and Donner and the lake of Pyramids. From there through the underwater mountain range it runs until it reaches the Hawaiian Islands, where one of its main components is the Haleakala crater, and then again turns South. It goes through the chain of the Hawaiian Islands, that stretches for thousands of miles all the way to the island of Moorea.

It's an **ENORMOUS UNCLOSED CIRCLE** that goes around the Earth, from Ushmal (forming a perfect spiral clockwise and counter-clockwise) to the island of Moorea in the South of the Pacific ocean.

A few pyramids were built by Ebrs in Tibet.

The fifth conclusion. During their stay on the Earth Ebrs (the Sumerians, the Dogons and others) interlocked the Life Support Systems of the Earth, creating **CONTROL SYSTEM** on the tracks of the power lines to prevent their use.

The sixth conclusion. To control the movement of the Earth in the given direction Ebrs used their own structures and objects, providing them with some artificial structures of control shaped like Cheops pyramid.

Under Sphinx there are 9 crystal vases enclosed one into another (theoratically).

The Museum of Oriental Culture (Tashkent): 9 balls, nested in each other. The balls are not detachable, all are visible..

Asoka Emperor, India from 273 BC –the society of the unknown 9 with encoded names:

1. The technique of war propaganda and psychology .
2. Physiology.
3. Microbiology.
4. The transformation of metals.
5. Means of communication – earthly and unearthly.
6. Gravity.
7. Cosmogony.
8. The properties of light.
9. Sociology and the laws of the evolution of societies.

Each of the 9 members of the society possessed the book, in which there was enclosed and continuously updated knowledge in a particular field of science. By the way, 64 methods of enciphering the texts **WERE KNOWN**. In addition to the function of the marker Cheops pyramid performs the communication function.

Let us consider the platform at the top of the pyramid as the norm for a regular pyramid, as well, and we get: the angle = 20,9051550°. is the angle in the dodecahedron (a dodecahedron vertex, the center, and half the edge)? Taking into account that the Earth's atmosphere is of the external structure of the dodecahedron, this pyramid is the pyramid of communication.

Communication octave is 51,125125.

The pyramid contour is the radiation grating of the 53,375 octave.

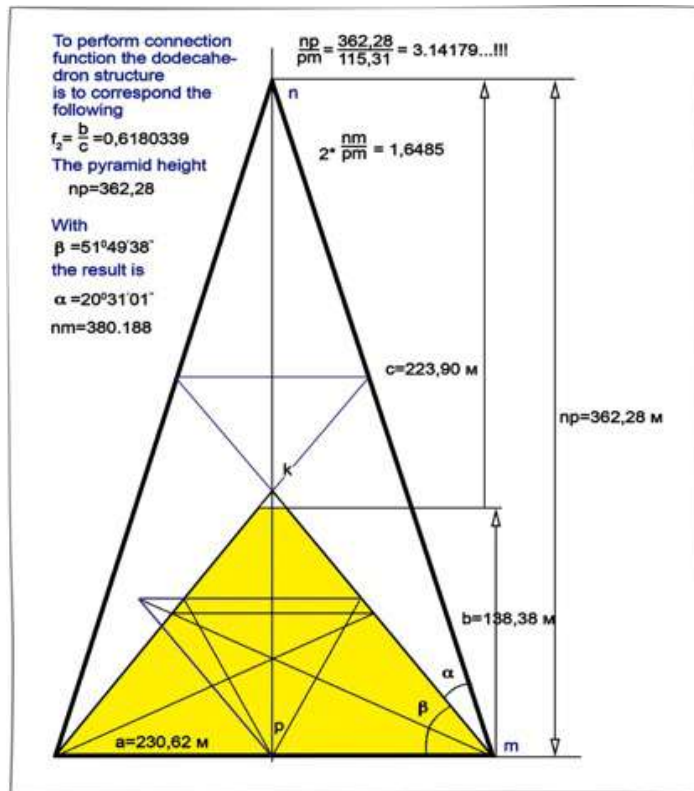

In contrast to the orientation grating that has a variance of 6' to the South, the pyramid of communication is strictly on the axis of the ion pyramid.

Pyramid orientation has the structure of 53.625. There are **NO DEVICES**, determining this frequency, but it is biologically perceived. The

pyramid is designed to operate in the original structure of the atmosphere (the dodecahedron). ***I am drawing your attention to it.***

At the starting point, the site of the great pyramid, we have got the Golden pyramid. Taking into account the inaccuracy of the input data (dimensions), however, we got the result that indicates not only at the meaning of the great pyramid, but at the fact that those who built it and made the calculations were not the ones who ran around with bows and arrows.

The Golden pyramid: $NM/2 \cdot PM = 1,6180339\dots$ and that is what refers it to the communication system. For thousands of years ion structure has changed, but strict compliance is supported even today, thanks to the radiation contours.

Now, based on this information, look at things more close to us in location.

The Church

As long as the time of the creation of the Earth **8640000** meridians **WERE LAID** (in science they are called magnetic meridians), about 1000 meters deep. They are energy cords. Only frequencies of low octaves have been measured (below the 42 octave). But these meridians are the conductors of high octaves as well; there are no instruments to measure their power, but the effects of their presence manifest themselves. In addition to the meridians, there is also a spiral; in the nodes of the meridian- spiral Hartman, Curie and Roentgen nodes are formed. Curie's are nodes of high

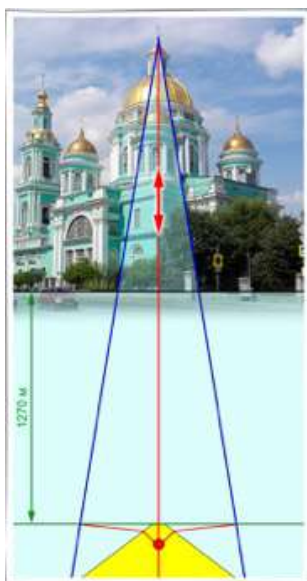

tension. If a terminal is put up over such a node, then within a certain range of the node there will be potentials increase of the atmosphere grating. If you add a little "stink" (light candles), a Human Brain can get something out of the atmosphere, for example, **NEW KNOWLEDGE**. There is also an opposite effect – the Brain is cleared of all the information.

Since the input of the frequency control for a particular genotype of the Brain (since 0 year) on the Earth there began building of a great number of terminals: churches, cathedrals, mosques, Buddhist temples.

Note that in Curie node there is **HIGH DENSITY** potentials in the frequencies of all octaves from 16 to 128, but a man perceives only the

62 (where to run or who to vote for). Today **66, 68, are the current Program for the Brain** (remember that). Frequencies of the octaves related to non-inertia mass are higher than 70. In the time of their materialization in the frequency **of 28-32 octave there might be tears on the icons**; that is, on certain material carrier, which in its structure has lead, sulfur and some other components. It has nothing to do with the divine miracles – take a wet towel and shake it at the **MOMENT of OCCURRENCE** of the next "miracle" – **you will get a shower of sparks**. If such a shower is manifested on a large area, expect to have an earthquake. This is not a miracle. So that all the "sheep" got all that is provided for them in due time, places of worship were designed and built for them. **Not** a single church representative **IS ABLE** to explain to you why **Church domes are shaped like onion, they take it for granted**.

All existing churches are **NOT** built by **ACCIDENT**. Control system is a pyramid, the apex of which is the Church. The location of the Church is not accidental – the top (the apex of the dome) is exactly aligned with the axis of the pyramid.

This applies to both the Orthodox churches, Catholic cathedrals and the minarets (of the mosques).

The Church is a double – action pump. In the time of reading the information (during the holidays) the arrow is down (the spiritualized leave the church). When the information is recorded with an arrow up – the release of waste and old information through the point (glowing clouds above the Church with a large gathering of people). **PEOPLE LEAVE the place** with new information and begin to execute what has been recorded. All holidays and all the days of the information withdrawal are scheduled **to dupe, with the reference to the divine and Holy events**. In the first place ministers of religion get the information; therefore, the selection of the clergy is not accidental. You might be extraordinary intelligent but at the main event you remain on the sidelines. As the **INFORMATION COMES** through the Church, it is considered to be the foundation of everything: morality, science, and all that is prescribed in the program. The **SHAPE** of the dome is **ONION**; the cone is also non-random. If there is no pumping up from the bottom, the shape of the ONION or cone contributes to the removal of the potentials from all present. Helmets, budenovka fulfilled the same function – **you do not need your brain in the war**.

There are **LOTS** of **INFORMATION EXCHANGE** systems, but the nature of their presentation differs. All genotypes **421** visit only the

synagogue, they do not need the Church (with their frequency control, they get and transmit information, avoiding holidays). Everyone else (goys or outcasts) are content with crumbs, but even there is some division into castes – it is determined by the shape of the dome.

Orthodox Christians **STAND** in line **LAST**, onion form does not let frequencies of direct connection pass (onion bending spectral form of **hydrogen (H+)** is the positive hydrogen of the central position. This subsequently **created quite a problem in the lack of control of the egragor of the Orthodox Christian Church – NO INFORMATION – NO OBEDIENCE** (even in the higher hierarchy). On the agenda there was an issue of the destruction of Orthodox Christianity. First in line for information are Catholics – their temples are precisely calculated by the cone, and they get all the information necessary to know only by the selected goys. Minarets and mosques do **NOT HAVE** such calculation, because more than 99% of the information is scattered, despite direct access to the source of information (to the floor).

At the depth of **1270 m** below sea level there is an information plane like fishing nets with nodes in Curie zones. If in Curie node (at the bottom) the gravitational potential k-structures above 122% are kept constantly a ball in the 63 octave can be formed. The diameter of the ball is from 2 to 33 cm, and it has already the properties of the piezoelectric element. It is exactly over such a ball it was **NECESSARY** to **BUILD** a Church. If there is no piezoelectric element, the Church is a black hole (**Cathedral of Christ the Savior**).

The Ball -concentrator was created initially while creating the information network. If the church (mosque or temple) are not on the axis of the ball, they **HAVE NO** sense and are to be destroyed (like in the time of the developed communism). Previously, each merchant sought to build a church for himself (forty times forty churches in Moscow, including the Cathedral of Christ the Savior). But the remained are only those that are in the right place. The Cathedral of Christ the Savior outside Curie zone and therefore useless, except for funeral services and lending more significance to the Russian Orthodox Church (ROC). As the deviation from the axis must not exceed 12 cm (axis tube), the location of the dome should be accurate otherwise, the Church is useless. The best option is the next step: to find the right Church (e.g., Elokhovskaya near metro Baumanskaya in Moscow. By the way, Pushkin was baptized there and given the name of Alexander).

The energy of the first pyramid at frequencies of the 71 octave, i.e. direct access to the Brain. The energy of the secondary pyramid of the 43.5 octave, i.e. processed **THROUGH** the appropriate **TRANSLATOR** (musical) information block. But according to the Program on **2005-11-14** **there have to be 49.5** transfer octave (up to 64 times higher), otherwise all listeners will **NOT UNDERSTAND** what is going to be transferred to them. The part of the inverter belongs to the second pyramid (the cross).

Out of the two options –to rebuild the church, or to dig a pit, today the second is preferable. By 1000 there had been 3260 concentrators, less than 1000 are left now (the rest are worn out and should be replaced), because the total number of correct churches, temples, mosques **MUST NOT** exceed the number of working concentrators. Looking ahead I tell you that the situation on **2005-11-22** at the start of the automatic attending of information blocks is rather interesting. The total control before that had shown the presence of the 49.5 octave (the pyramid is rebuilt), the Brain of the elected is controlled by the 49.5 octave, so the automates will dump everything that is necessary for the program, and even more. The counting of votes is made strictly according to the matrices, and the performance is guaranteed, as before, by the control system (plus attending machines).

There is unchecked information that the ball is the Holy Ghost, (like in the anti-clerical song by **Vladimir Vysotsky**: "I come back from work, rashpil put against the wall...") which sometimes visits the ladies chosen for the creation of another Christ, using the **IMMACULATE CONCEPTION**.

Thus the Church is a terminal for not only obtaining Program information, but also for cleaning the Brain from the accumulated debris. In synagogues they use candle-concentrators, the debris in the Brain remain, however This debris **CAN CAUSE many diseases** (this understanding will be useful to the reader for further knowledge). By the way, respectable restaurants (in Western Europe) and at homes at lunch time the candles are lit (for beauty). The actual purpose of candles is to **INCREASE** the **GRATING POTENTIAL**, which enhances the digestive process. These candles are used by all witches, magicians, and sorceress. Candles must **be of wax** – product of oil. This product contains sulfur; which frequencies are basic in the atmosphere grating.

For the "Golden billion" the Control System **DEVELOPED REINCARNATION** system, or "**Christ**" that is eternal life of the created Brain: **the reincarnation, in relation to the beginning of the process of "bringing all things in order, as before the invasion" – was**

removed in 2000 – the Church calls this process **Antichrist**, and the Church itself **IS BECOMING USELESS**, *which is being observed with our own eyes.*

Chapter 2. "Spiders' Laboratory Experiments"

Anyone who has once proclaimed violence as his method, inexorably has to choose a lie as his principle.

If an individual is able only to take and not to create; and is not able to compensate or eliminate the consequences of his or her deeds – such an individual can not be defined as Man. It's not even a personality, but a guided biological creature. It is able to have only its own momentum brain functions for daily chores and its temporary life support at the expense of the destruction of the surrounding environment harmony and an additional own imposed use as a biological object to implement the plans and Programs of the external control, launched by alien Systems. These individuals have to be called People. Man has been imposed this kind of condition in the time of the realization of the old Program processes. And that is how it had been happening.

2.1. The first stage of the violent "Civilization" of the Earth

From 17304 BC to 16684 BC (620 years), there was an active preparation for the execution of the Program "Energybiogenesis of the flesh cell".

Insulation with a layer of magma and other conversions of the contour protective plates of the Planet were made.

LANDING on the Earth happened in 16300 BC. First of all heavenly places were laid out, all the Earth complexes were annihilated along with those who inhabited them. In order to adapt the planet for their life support the population of the planet had to be **MADE A CLEAN SWEEP OF**. That time, **1240 million Human Beings** inhabited the Earth. The population of the Earth was completely annihilated, and all the humanoids were captured. The molten earth, which was found in Siberia in a large area, can serve as a slight example of the impact of aliens. All the found evidence of the existence of the ancient advanced civilization was carefully hidden, and is still being hidden from the society.

The aliens had worked out their own biological structures, but based on the samples of the former Human Beings. New Biological structures had Brain octaves from the 31 to 44. In order to control the resulting biostructures Ebrs had brought from Phaeton 12 billion Humanoids – programmable energy "blanks", which sometimes manifested themselves in the form of "come outs" in some individuals. They were stockpiled in the United States in the area of the Great lakes, in Peru, Tibet and Australia.

In addition to the delivered frequencies, samples of flora and fauna were transported by their fleet. But since the conditions on the Earth were very favorable and energetically provided, everything grew to gigantic proportions. That was the time of the dinosaurs. This experiment **TURNED OUT** to be **UNSUCCESSFUL**, as it was very energy consuming, and everything was destroyed.



2.2. Attempts to create people

From 16684 BC to 13344 BC (i.e. during **3340** years) Ebr' System undertook the first attempts to create humans.

Symbolic "First Civilization", but in reality – the first stage of the intervention.

Starting with the first aggressive invasion within 1040 years **ALL** the **PLANETS** were completely occupied. The capture ended in 17 914 BC. The

capture itself was symbolic, since all the Main Complexes on the planets of the interplanetary Cluster of the Earth had been off. Not knowing the structures of their construction, having a lower level of knowledge, the attackers just tied up all the planets with gravitational tubes (and later –with connections tubes), included imputed base generating frequency radiation protection of the Sun, surrounded the planet with "satellites" (as security convoys) and moved in the direction of the Big Dipper, in order to make out an active area of its reach. But on the way it was decided not to lose time and carry out some possible processes of changes in their own favor.

I have already mentioned that the capture of the Earth was simultaneously with the sweeping off the entire Mankind (in their physical plane of existence) and those control objects that were on the surface. All humanoids, as the energy state of the Entity of the entire diversity of the biosphere in their non-physical as well as Spiritual Essence of the **proto-Humans** with the octave of the Brain within **96-124**, being at the moment in the structure of the Earth's Atmosphere (in the gratings' octave of the 32 to 72), were **CAPTURED**. They could not be hidden "below", as all the Complexes before the attack had been switched off. As noted previously, the saved were **ONLY SPIRITUAL ENTITIES** with **the 224 level of the octave** of the Brain. Captive humanoids were kept in the interments' objects' cells (mostly type 440), landed on the Earth.

Then began the first "filling" of the surface of the planet, with "their water" (tritium) and the formation of sand out of the water. This process lasted approximately **620 years**, the surface of the Earth during this time has changed significantly and reached the **level h=-4300 m** (in relation to the present level of measurement). The Earth's atmosphere had not yet been structurally changed, but some gasses were added as part of its gas completeness which were necessary for ebr entities breathing (in their physical plane of existence) – the oxygen and fluorine were theirs (later the composition will be replaced).

Immediately after the installation of invaders' complexes of type 111, 222, 333, 444, 555, 000000 and auxiliary systems (shapers of the quantum fluctuations like those in the area of Stonehenge, and others), after landing the only one remaining today main object (type 960, or "Jerusalem", or the Third Rome – (as you like) located near Red Square in Moscow); and after landing **ALL OBJECTS** of convoy the trial "Program start" for the materialization in the physical plane of the first group (2%, i.e., approximately 17-20 million) of the captured humanoids (i.e. Earthly

spiritual entities of proto-Human with the octave of the Brain 96-124), previously transferred to the state of energies to the 31 of the octave (an attempt to simplify the Brain, since the invaders did not possess such a level of the brain).



The "aliens" in the **TRUE FORM** of their appearance were landed only after the chosen places had been prepared for their existence, that is habitable for their general state; (primary Control) and the completeness of the gas atmosphere had been created.

The aliens (Ebrs) are spiders 2.5 to 4 meters high depending on their membership in their existing hierarchy (for comparison, the height of a proto-Human did not exceed 1,88 m). It was impossible to escape for the initially embodied people.

Firstly, the human Brain (in the 31 of the octave) was very limited to aware the reality, logical functions were practically **BLOCKED**. There was no energy-information translation of the controlling character; the only recreated was the function of the flesh cells control and some limited control of the metabolic processes. For more, the invaders were not able then in their experiments with people. They **WERE NOT READY** for modeling the Brain construction of the proto-Human in order to substitute it for a more

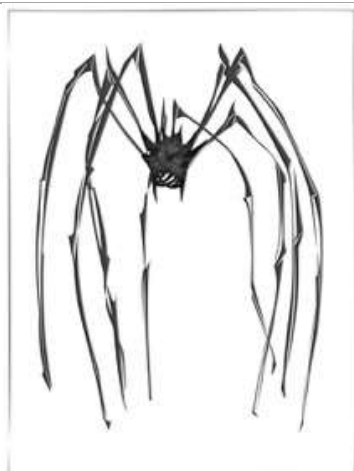

simplified construction of their brain in the human body due to the loss of the recourses after Phaeton's self-explosion.

Secondly, the area of the saved (formed) land after its initial flooding with imputed water took only 5-6% of the area of the total surface of the planet. The "continental" formations were mostly in the locations of the imported (transported) and installed primary (stationary) interventional Control Complexes or objects.

Thirdly, any attempt of creating self-born fauna of any long seasonal period was almost futile. The reason is that, as such, there was no synthesis control as a must for the habitat in general, and the unattended conception was giving up its being like a dying attempt of survival of the former fauna. The Earth **BECAME BARE DEAD** Planet, flooded with imputed water on the surface of which large-scale processes of annihilation of natural habitat, the barbaric destruction of all that could be preserved by chance in some way and fashion. And those fragments took place during this first stage, even in the initial period of the existence of the preserved groups of proto-Humans. Above the plates of the protective contour before filling it with water the interventionists had formed a layer of magma so that no humanoid was able to **RUN DOWN**, and to eliminate any attempt of the Earth Complexes and systems to **OPPOSE** the **INVADERS**.

In that active destructive mode **for 3960 years the first stage of the intervention of the Earth** had been taking place, a certain, **ALIEN** to the Earth Environment based on parasitism and violence **WAS BEING FORMED**. Someone might keep in memory the definition of this stage as the first Civilization (obviously, they have those unwavering "generic" reasons). It was **RUTHLESSLY DESTROYED** within 2 days in 13954 BC, as all the experiments with such "imposed Civilization" ended in its collapse and complete failure. Ebr System was not ready for such complications and did not take into account the level of perfection of the Earth, although all the formal knowledge, especially of the basic constants of constructive formation of the comprehensive energy model of the Earth and its being, **WERE KNOWN** to the alien system.

2.3. "The Second Civilization"

The second stage of violent "Civilization" of the Earth lasted 3150 years, from 13344 BC to 10194 BC.

At this stage, the interventional Program of "Energybiogenesis of the flesh cells" (the Program of "Energy-information dialectics of the development of genotypes of the Brain" had not been formed yet) acquired **MORE** significant activity in the reinforced attempts to create people (as a kind of proto-Humans), since the spiders flesh was imperfect and unacceptable in an attempt "to enter the Hierarchy of the Civilization development of the Intelligent orientation" (as well as the design of their Brain). For this purpose, the invaders used 21% of the imprisoned humanoids (spiritual entities), i.e. approximately 200 million individuals (from the state of their non-physical captive existence). The main **EMPHASIS** was **MADE** on Controlling the Brain by the primary energy-translation (of guiding character) via objects of 440 type. For this reason, all the settlement was formed in the range of the translation.

With the achieved results there were attempts to combine the people's flesh (people's bodies in the physical plane of their being through their Brain structure on the level and in terms of conversion into the low octave, up to 31) with the possibilities of the spider's Brain similarity. That was exactly what the principal attention was focused on.

Certain invaders' attention was paid to the **ATTEMPTS** of **INTERFERENCE** in the model design of **DNA**, **PROLONGATION** of biological **LIFE** of individuals (the average span of life was only up to 18-22 years), correction of metabolic processes of the cells of the flesh, attempts to transfer the metabolic processes to carnivore nutrition, and much more. But not so simple was the Man in the attempts to make' his likeness, for he is the fruit of the Creator's design! In this regard, the invaders did not make any significant progress. The invaders incarnated some other program processes to change natural habitat and the environment.

Water acquired only the fresh state. Its quantity was increased by lots of orders of magnitude; the former mineral inclusions practically did not exist. Moreover, it was the **BEARER** of **TRITIUM**. The program steadily required the mandatory presence of tritium in water, change in its frequency and density content in water as a source and carrier of energy for the functioning of the human Brain at the level of the lower octaves. A kind of "pipes" were formed, with a diameter of 300-400 m, to transfer water to the

objects, that required tritium (those "pipes" exist to this day at a depth of -2200 m to -3000 m). Water was intensely saturated with tritium.

The **SURFACE** of the **PLANET** was subjected to **CHANGES** as well; at this stage, the level of prime coating of the planet was "raised" again and reached $h=-3000$ m (in relation to the current level). Land geography expanded considerably. There began the manifestation of some semblance of discernment of the continental surface of the Earth. But it was only the primary image, even now depriving illusions many present day specialists of Geophysics, whose knowledge in geographical distinction of the surface of our planet rely on the theory of the separation apart (and the associated further "travel" of continents to different directions)

However, the truth about the formation of continents is based on "the foundation of digging", as an undeniable fact and on the trail of interventionists' achievements, and not on the theory of "spreading" and traveling of the entire continents. But why "the curve shapes of cutting" the continents on many borders of discernment is so amazingly alike? The answer to this question is **NOT ASSOCIATED** with spreading, it is associated with forms of scattering radiation frequencies (introduced by the invaders), with chemical elements formation at the ionic level, with subsequent formation of a "bulk firmament" (and filling with water, in particular) and so on.

With the expansion of the continental areas the invaders made **ACTIVE ATTEMPTS** on formation of flora and fauna as a complex element and process in general "civilization" development of the Earth. In addition to co-participation of flora and fauna in providing people's nutrition and their inhabited places it was required their active participation in the formation of natural minerals. Basically, all the attempts of intensive rehabilitation especially the fauna, were **DOOMED** to **FAILURE**. In the development of flora the complete similarity to its previous state was not achieved, the reason of those failures is the principal change of fundamental constants in all interventionists' creation of energies being. All the surrounding reality had changed fundamentally. There was no longer previous Program of operating "synthesis" of trees and plants. The structure of new chemical elements did not allow to come even close to any similarity in the field of flora. Thus, the invaders began **to form that kind of** flora, which turned out to be a certain **HYBRID** of the past and introduced processes of the synthesis control. Present day experts in the field of flora wonder to this day how dramatically and fundamentally their state was

varied in those distant years. They are trying to find the causes of such sudden changes in the variability of climatic conditions, not being confident themselves. And the reasons are completely different. There was an **ACTIVE EXPERIMENTAL** search for the most appropriate range in the field of flora to move to the complex processes of future changes, especially with the development of people, the perfection of their Mind and the Mind of the Planet, and so on.

At this stage, an active **FORMATION** of **PYRAMIDS** began as the necessary transmitting and receiving subordinate element for the functional operation of facilities and of Control Complexes. The height of a pyramid generally did not exceed 8820 m (except the pyramids in the Bermuda area, $h=840\text{ m}\div 9940\text{ m}$), and the design (and shape) was determined by the purpose and functions of the object, or complex, placed under it. When finishing such a creation the Pyramids were buried in sand. Some pyramids not buried in sand were executed of hard material of another kind, as if in the form of mountain (the Caucasus, the Alps, the Tibetan mountain range, the Andes, etc.).



Due to the negative results of the "civilization" development" in the part concerning people, this so-called, **"Second Civilization" was liquidated within a few days**. Again I am drawing your attention to the fact that, someone might take this stage for the "Second Civilization", but in the true essence of all the performed it was just a stage of civilization intervention of a violent nature, and it could not be the Second Civilization

of the Earth apriori. All **EXPERIMENTAL SPECIMENS** were liquidated within several days.

At the end of the Second stage of interventional interference in the civilization development of the Earth for 200 years there was a Programmed preparatory process of organization and partial Programmed correction of the Control functions at the created Control Complexes and (landed) objects for the conversion of all subsequent processes (changes) for the Third stage. For that short time from the Moon the first **SAMPLES** of "native" (lunar) humanoids (in their non-inertia energy substance) **WERE DELIVERED**, and also in the same way, some species of fish and birds.

2.4. The third stage of the intervention

Symbolic "The Third Civilization" (in fact, the third stage of the perpetrated intervention) had duration of 4070 years, i.e. from 10604 BC to 6534 BC. It had been the most satiated with all round experiments stage – from the formation of a stable interventional Control in all directions of its own civilization development until the **ATTEMPTS** to introduce self-created elements in the field of flora and fauna (taking into account the obtained humanoid fragments from the Moon). The details are not so important, since the invaders had **FAILED** to recreate the true likeness. However, one should note an important point, namely, the Control System of the invaders still was not perfect. For this reason, the true Control System of the Earth **REPEATEDLY** and **IMPERCEPTIBLY** interfered with its controlling correction in some episodes of the fully developed Control of energy being in the material and immaterial world.

Thus, as if a strong demand there arose for compulsory salinity of fresh water by those possible forms that had been established by that time. It made it possible to **RECREATE** to some **EXTENT** at first approximation some part of the conditions of life-attending in fresh water and give the underwater world some of model structure and functional significance oriented to ensure the created people in proteins and minerals of aquatic origin. Such unnoticed corrections occurred in the field of flora and fauna, and did not make it possible to leave **FULLY** and completely **THEIR** proto-forms in their development.

There was quite a lot of experimentation in the process of recreating people over this long period. In total 42% (about 400 million) captive

humanoids (energy-information entities of proto-Human with the former level of the Brain of 96-124 octave) were used. What was basically the main attention of the invaders paid to? Realization of only one Program of the "Development of Energybiogenesis of flesh cells " went on, and therefore the concentration of invaders' efforts on this issue, was basically focused. For this purpose, in the Atmosphere gratings all along the perimeter the processes of development of "**the Atmosphere Brain**" started in order to give some primary guiding in the existence of people without binding them to objects of type 440. But during this period it had **NOT BEEN** fully completed. Much attention was paid to changes in the human Brain Control of the metabolic processes of the flesh cells. During this period, people were brought to the state of metabolic processes under conditions of their suitability and ability to be carnivorous (initially without thermo-treatment). This made it necessary to **CHANGE** structurally and **SIGNIFICANTLY**, for example, pancreatic function and, consequently, to give additional functions to the Brain in its guiding and control of the metabolic processes of the flesh cells. This information is for those who is fond of vegetarianism and other "experiments".

Regarding the adjustment of the people's Brain structure all the experiments were mainly focused on:

- the **LOW OCTAVE** of the Brain (up to 31 – to add full submissive executive state, recreation of limited part of logic functions for the execution of elementary actions and motions, exception of rebellious behavior in the process of cohabitation, etc.);
- continued attempts to combine the Brains of people with the **DESIGN** and **FUNCTIONS** of the invaders' Brain (including those sent from the moon humanoids – their native individuals);
- prolongation of biological life of human individuals (no progress from the previous stage) by interfering in the DNA structure and many other experiments.

However, significant outcomes in matters of recreation of people as a likeness of proto-Man, but completely conquered (with all his life and suitability for a replacement of the combined Brain design with the invaders' Brain), had **NOT** been **ACHIEVED**.

Soon, within a few days this stage was stopped, in 6534 BC, and the entire carnal experimental basis was eliminated. Thus there ended the alleged "Third Civilization". After its elimination there was a certain preparatory process of the Program resetting of the control character as well

as **SWEEPING OFF** the consequences of the **300 years** of experiments (i.e. until 6234 BC). In addition, there were quite a lot of changes in the physical plan.

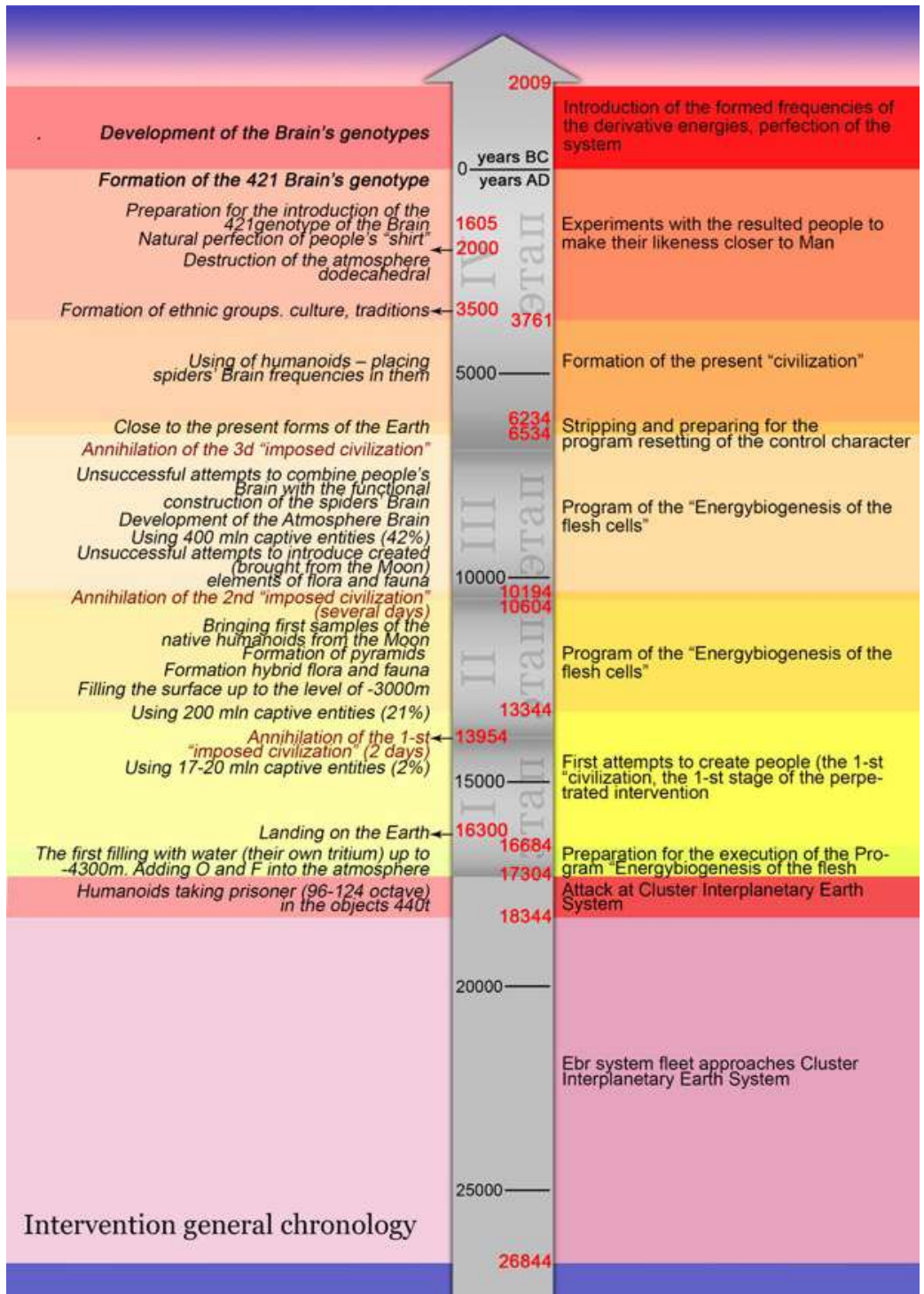

2.5. Preparation and the fourth stage of the violent intervention

From **6534, BC** to **6234 BC (300 years)**:

- preparatory process of the program resetting of the control character;
- sweeping off the consequences of the experiments;
- the surface of the Earth was filled up to $h=-1200$ m (relative to the present level), on the formed surface there were laid 8640000 energy tires of inter-pole direction (the geographers call them Meridians, and they are not 360 but a few more), connecting all Control Complexes and landed objects;
- nodes were formed (control servers and distribution energies servers);
- after this fine engineering, the whole complicated "installation" was filled up to $h=-100$ m;
- Huge masses of water 1500 m high were hurled to the Earth from the atmosphere hydrophone layer and from that moment sea water was first formed. That is the "worldwide flood";
- the surface of the Earth has taken the form close to the present.

They began **TO USE HUMANIDS**, inserting into them frequencies of spiders' Brain. Consistent frequencies setting led to good results. ***With materialization, all the humanoids got the Brain of spiders and formed the present civilization.***

Since 3761 BC there had been quite a lot of transient experiments with the resulted people in order to bring their likeness closer to the likeness of the Man before the intervention of the Earth. By mid-September, 3761 BC, this process of image similarity had been completed (the story "of the image and likeness" in the Bible and other legends).

Since 0 year AC the invaders **BEGAN** to **INTRODUCE** a large group of preformed frequencies of the derivative energies (relative to the basic that had been brought by them) and improve the System of control. The interventional System complicated and improved the Control on the Earth which had been created by them. They introduced the control of the state, executive behavior and control of efficiency resulting aspects of groups and **INDIVIDUALS** from people. An extremely **IMPORTANT** step was **the introduction of reincarnation**. It was the only way out of difficult situation for the whole ebr System, which failed to solve the problem of non-

conformity between the long duration and continuity of the necessary executive functions of people with limited life-span. They **FAILED to get to the fourth codon of DNA** and mastered only three of them, and only because of this life for the created people was so limited in time.

Further interventional (ebr) Program objectives in relation to people became **MUCH MORE COMPLICATED**. They rushed to get people as representatives of their Space (because people look significantly more decent and potentially more perfect), but having the Brain of a spider and the possibility of transition to the octave of energies 44 and 56 (i.e. above 31 octave of the material world) in case of unforeseen emergencies on the Earth. In addition, the group of spiders, which was located on the Sun as their **SELECTED ELITE** in the amount of 1,200,000 individuals, would have to make "golden elite" on the Earth by their Program, but with more perfect Brain – the **72 octave**.

2.6. Technical implementation of the Control

On the 2009.11.15 the functioning of the basic Complexes and Systems of the invaders was eliminated along with those who served them, i.e. spiders and those enlisted. It took the hardest **16 years**. There are still lots of aftermaths of the intervention, but the **MOST IMPORTANT** and irreversible is **CARRIED OUT!** Part of the interventional Complexes and objects saved as functioning trophies, as the loss in time and energy spent should be compensated with something. **THEY** have **ALREADY** been applied in the solution of creative tasks and elimination of aftermaths of the intervention.

In this regard, in a simplified format I'll show you how the Control had been technically carried out by their Systems. But I will throw light upon this issue in the limited frame of understanding only the fact of **ADMINISTRATIVE INFLUENCE** on the condition of people and their subsequent resulting behavior. This is exactly that sacred "From outside" passed in the numerous epics and legends. Technical and technological details are not touched upon, in order **NOT** to **OVERLOAD** the readers' Brain. Of all the Complexes and objects, involved in the old System of the Control, we will note only the main part, without which the Control would **not have been possible:**

№	Complex	Purpose
---	---------	---------

1	Chekhov	Control tower, main control system, setting Programs for all complexes.
2	Kailas	Main control system, correction in accordance with the atmosphere Brain program for all genotypes on the Earth.
3	China, Tibet	The atmosphere state control during the correction of the atmosphere Brain and all communication channels of objects type 560, 520, 500, 440, and 960.
4	The Urals	The coating of the brain (31 octave) for all genotypes (from single-celled creatures to man).
5	the Baikal	System of emergency rescue of humanoids 42, 44 in case of a disaster (evacuation from the Earth).
6	Easter	Compliance Control of the Brain coating and octaves from 49 to 59 for all genotypes.
7	Kailas 2	Routine (weekly) monitoring of the Brain.
8	Peru	The Main Complex of control, maintenance and storage of humanoids (for future use).
9	Andes	Control of all humanoids on the Earth.
10	the Caucasus	The Main Complex of control, guiding of the "Golden billion" – 42 genotype.
11	Elbrus	Territorial complex – the European part of Russia, Belarus, Ukraine, Bulgaria- total control of genotype 42.
12	Kazbek	Territorial complex – the East and the South Caucasus, Central Asia, East of Asia minor – full control of genotype 42.
13	Ararat	Territorial (first on the Earth) complex – Asia minor, Greece – complete control of genotype 42.
14	Alps	The Main complex of control and guiding of the "Golden million" – genotype 44.
15	Alps 1	Territorial complex – France, Spain, Portugal, Italy, Western Europe – full control of the genotype 44.
16	Alps 2	Territorial complex – Eastern Europe, Germany, Baltic States, Scandinavia – full control of the genotype 44.
17	Sarajevo	The main energy complex of octave 53.5 (gratings replenishment for all types of radiation). The first atomic bomb was worked out in Germany.
18	California	The main Complex for preparing new genotype – 46 (to be introduced in 2012).
19	China, Tibet	The main control complex on the Earth, setting standards for all complexes.
20	Easter	The coordination control node via Kailas.
21	Moscow 960	The main object of the Control System, all the brain matrices of 42, 44, 46 and Moshiach.
22	Greenland	Control of the Atmosphere brain.
23	Ireland	Computer center. All types of calculations. By the way, Ireland – second in the world in Computer programming. At the same time, Ireland is the birthplace of unsolvable mathematical problems.

It is quite sufficient to pay attention to the purpose of each Complex which convincingly demonstrates the fact that all actions in the Control the processes of implementation did not leave any chance to be left without old System's control, even in minor episodes of actions and events. A skeptical opinion or judgment will only mean the unwillingness or inability to go further into the matter. Technically, from the first steps of any Program simulated process to its **PRACTICAL IMPLEMENTATION** via the enlisted – everything was in the field of effective attention of the Control Systems. Moreover, the old System had the technical ability to lead and to **COMPEL** to the planned **RESULTS** in all that was determined by them through various set up Programs.

While creating the atmosphere Brain (**from -2200 m to 12,400 m**) new frequencies were introduced in the original structure of the atmosphere. This process began over 2000 years BC. Strictly symmetrical structure of the atoms dodecahedrons was destroyed (some connections with the icosahedrons were removed). Each removal of such a connection led to the creation of a new chemical element. If you completely remove dodecahedron, you get icosahedra structure of bor. As the basis was 16, 22, 28, 32 and 42 of the octave, exactly in these structures everything was replaced.

A certain combination of octaves 16 and 22 led to the creation of gas and the combinations of octaves 16, 22, 28, 32, 42 – to the formation of oil. White oil has **additional octave 47**. Besides, octave 53 was inserted; as a result "explosive mixture" was made. But these combinations were intermediate and could not be used for the formation of the Brain, as they contained the catalyst – sulfur. Sulfur is a product of the Brain activity (note – sulfur in the ears), but it **CANNOT** be in the composition of the Brain. But this "explosive mixture" has one property – it is impossible to transfer to octave 56 without it, which is extremely necessary for all representatives of the "Golden billion" in case of emergency, when, for example, they **HAVE TO BE SAVED** from a nuclear explosion. Since the intervention in the Atmosphere structure by the interventional System it has still been presented in **6 layers**:

№	From	To	The Purpose
1	-4400	-2200	Atmosphere Brain grating connection, the atmosphere Brain
2	2200	0	Atmosphere Control system (-2200 m is the hydrophone depth)
3	0	1200	Base layer
4	1200	6200	Accumulative layer
5	6200	12400	Layer of materialization
6	12400	36400	Layer of the atmosphere protection

In the accumulative layer there was a weekly process of accumulating or clearing the frequencies and their subsequent distribution among other layers. In the layer of materialization there was a transfer of all types of humanoids into material structure (putting "shirts" on them), as well as materialization of UFOs after their lifting, if necessary. Each layer, except No. 3, has sub layers, in which, different structure frequencies performed the same function.

In the initial period each object, from which humanoids were obtained, formed an individual "cupola" for them inside of which the development of the given group took place under the Control of the object, without reference to the environment. It was impossible to go out of the "cupola", the outsiders were not allowed in, as well.

When the Earth Control System was introduced in the state of a new functioning, set up by the invaders for themselves, there began binding of all biostructures to the local habitat within a certain distance from the Object. First and foremost, this environment was formed **by the Andes**, then **the Caucasus**, and from 0 year – **the Alps**. The colony of humanoids living in the Object "cupola" was called "ethnic group", hereinafter used the term "nationality".

Where did ethnic groups come from? In its original form, all "passengers" on all the objects **LOOKED** perfectly **ALIKE** and the Brain structures were alike. But the objects do not transfer material bodies, and therefore when landing in a "chair" any material structure folds into a small fireball, about the size of a match head. When rolling itself in a ball there might be some slight distortions. Therefore, the Brain potentials before rolling in a ball could be different. On the way the object could fly through a meteor and can pick up any muck in the form of those germs that are typically found by "modern science" on the meteorites. In addition, the environmental parameters of the Object arrived, and the parameters of the "passengers" delivery places could be different in structure and filling (on the Earth there was more oxygen). If the original Brain when moving lost at least one frequency (and the Object's Generators **DID NOT NOTICE**), then many of the original properties were lost at the delivery place, as well. The missing properties were filled in with "stock parts" (with expired shelf life, as the movement was more than one hundred years). That is why each Object brought what had been loaded in it, but poorly packed. Each ethnic group had the **SAME STRUCTURES** of the organs, but **DIFFERENT STRUCTURES** of the Brain.

The brain, or the properties of biostructures, as the System of external and internal control, memory, orientation, information exchange properties mostly, were the same, but had **DIFFERENT BASE**. The Base is an individual property of an ethnic group against which metabolic processes of reception and transmission or language translation were built. In Georgia, for example, the basic element was manganese (Ossetians have another basic element; it's a different ethnic group). When in Georgia the deposits of manganese were completely depleted, the population got the process of "thickening" of blood and increased pressure in the pulmonary circulation. ***In practice, it was noticed in 1989.***

The Control system, taking into account the location of the "cupola" for 3500 years before the new era began attaching them to the layer of atmosphere No. 2. Using the features of the Brain of ethnic groups in the first place, each of them received basic radiation frequency, relative to which there was a rearrangement of atmosphere layer No. 2. The number of radiation frequencies was more than 100. Using the database, i.e. the radiation frequency specifically **TO EACH** ethnic group, their quantity and the number in each ethnic group were brought to the Program specified values.

Primary life styles (culture) and borders of the habitat of each group were introduced and found with reference to the layer of atmosphere No. 2. Boundary of habitat no longer had a cupola shape. In the center of the former "cupola" "capitals" of ethnic groups were founded. Regarding this, the construction of further settlements was carried out, etc. In the course of development with the objective of stabilizing Control of the execution of the Programmed processes limitations were introduced **WITHIN** each ethnic **GROUP** which do not allow different ethnic groups to merge, i.e. be mixed. It became surrounded with imaginative and behavioral introduction (concept and realization) of different traditions, beliefs etc. If the group did not meet the conditions of the Program requirements, i.e. had non-programmed variations in its development of any irreversible character it was **ANNIHILATED**, usually by **OTHER** ethnic groups. But each group had its own object of defense, and if the group was annihilated, then the Object was destroyed too, it was transferred to the off state.

THE PRINCIPAL PROGRAM goal was to create the "Golden million" based on "the Children of the Sun", and all ethnic groups had to be only **CONSUMABLE MATERIAL** for conducting Program experiments to improve and bring the Brain to the desired genotype and in the right quantity

in line with the Program. The intermediate group of the "Golden billion" had begun to take shape since **0 year of the new era**. At the same time, representatives of this group had already had some connection with the atmosphere Brain, placed in the layer **-2200 -4400 m** deep. They could have up to 12 language translators for communication with other ethnic groups, got firsthand information necessary for the "creation" and "implementation" of new technologies to improve their social settling. They formed their own societies and the structures of their Control, founded primitive, but their own economic system, etc.

Societies and states began to appear, take shape and improve. And it all went allegedly like the way some historians are trying to give an account in pictures. But everything is not as simple as we would like it to be! **NEITHER** Marxist-Leninist basis of the fundamental production relations, **NOR** the theory of the World market, or any other contemporary theories or the theories of the past **HAVE BEEN ABLE** to answer the question how numerous societies have been formed. What qualitative and quantitative "special recipe", how many and what kind of ethnic groups had to be collected to create a proper society, in what quantitative and qualitative limits? Whether this process is guided or prone to natural formation? Why periodically there were demographic problems? Was a 'recipe' for the formation of all societies the same or was it unique for each group? And finally, who determined the boundaries of the states, without any disputes or military interventions, i.e. some other way? There are plenty of questions, but they are being ignored, passed over or looked for a convenient explanation – beyond the truth.

The fact is that after the invaders' realization of the processes for creating altered, to fit their Program single grating of the Earth's atmosphere **THERE IS NO LONGER** any **NEED** for a hard reference of ethnic groups to certain location, as the atmosphere grating itself has gained all the necessary properties to support the existence of the ethnic groups diversities to any point of the Earth. From this moment, a deterrent from the chaos and mixing of ethnic groups (nationalities), as previously established societies by force, have become newfound by the societies and assigned to the performance exactly by them some private Program functions, which, in accordance with its Target Vector of **FUTURE PHENOMENA**, actions and events predetermined the whole Program structure of the subsequent events in this society. In the future, it was classified as historical **STAGES** of the **DEVELOPMENT** of civilization, states and their groups, etc.

The system pre-held Program distribution and gave specific functions to each society taking into account the placement of Objects and Complexes in relation to the established and well-functioning system of energy and information support, communication and control systems. For all that clearly defined characteristic, territorial demarcation under these societies functions were determined. Moreover, each territory for future settlement was pre-saturated with a certain set of "natural" resources to the levels, which should be sufficient to ensure the formation of material goods and services exactly for the society which would settle on that or other territory having a set of specific functions endowed by the Program.

The **MAIN** geographical **REFERENCE POINTS** in the definition of the borders between the States were served by both placed Complexes, and Objects and **FREQUENCY REFERENCE** through the Brain of specific genotypes with frequencies of some chemical elements that were present in the deposits of this territory. This frequency reference in the first place, was the **SECRET RECIPE** for the selection of specific numerous or uniform types of ethnic groups in society, which was necessary to perform the full function of every society. At each step of the Programmed performance of its functions the society could and was supposed to have a certain number of performers of specific genotypes of the Brain. This exactly determined the quantitative composition of the community, and this corresponded to the demographic change with reference to the specific stage of the Program execution.



Any artificially introduced unprogrammed interference in the correction of a demographic problem was not able to solve it. However, any forms, methods and aspirations in all attempts were futile. But it has always

been able to **ORGANIZE CALAMITY**. So, for example, was **ARTIFICIALLY ORGANIZED** a very serious problem for Russia, connected with the ill-conceived initiative to enhance migration flows from the countries of Central Asia. Any proactive interference of a random performer, not provided with the programmed framework, has always led to some significant consequences. So, more than 95% of people who were involved in the non-programmed cultivation of virgin lands immediately fled across the country at the end of this artificially inflated farce, not having achieved the target. But the main part of the "fled" has not returned to their former locations and to their former way of life. Most of them were darted off from rural areas.

That way **THE FIRST** endless **STREAM** of "roving specialists of all hands" and later called "the municipal quota" was arranged; and the aftermaths of which have never been corrected in the development of the agrarian sector of the economy. These were the people with the **BROKEN PROGRAM** in their minds and deprived of the former frequency connection. The similar situation was with the group of "BAM" (the workers of the Baikal-Amur railway), and so on. The alternative example is the voluntarily-forced resettlement of oil- industry workers from Azerbaijan to the areas of Tyumen petroleum industry. They, having frequency connection of the Brain feel well in the northern areas, succeed in labour productivity and are not going to move back to their former motherland.

There might be a natural question: Why were there so **MANY** bloody **WARS** to defend one's territories? Are they futile losses and unnecessary human grief? Do not worry –it was that way, regretfully, in line with the old Program one of the variants of the **LIQUIDATION PROCESS** of the unnecessary Brain genotypes after a regular stage of its perfection. The present day existing "Golden million" is the **EXPENDABLE MATERIAL** that for the completion of the Programmed stage was being transferred to the "Golden billion" on common grounds of annihilation of all those, whose brain genotype did not meet the new Programmed requirements.

2.7. Formation of Consciousness

The embodiment of the specified, including the **formation of consciousness**, was carried out by practical providing **ALL** the necessary **INFORMATION** orientation of "the strategic and current" nature, which

for a long or short period of time were translated to the Complexes, Objects and preformed Control Systems. The latter, in turn, through reverse energy informational translation operated, i.e. determined all subsequent terms of performance and found commands related to the development of structures, functions, and the design of the energy- informational translation for people and the development of their Brain throughout a long process of their supposedly "natural" perfection. ***It was through such programmed policies like orders, the process of development of the materialized by the interventional System people*** – from their state of "Cupola" Control¹⁷ of the being to the present state of the accomplishing "Collapse of their Civilization" occurred.



The formation of consciousness of the genotype of the Brain is a **DISCRETE** sequential **PROCESS** to bring the System functional Controlling information in the

conscience of individual members (performers) at a specific "historic" moment through Systems of Control and Operation of accompanying and supporting Complexes.

Thanks to this, with the application of systems of Control and Operation, there was implemented the Comprehensive support in the execution of the Programmed actions that led to a pre-planned System results and events in the development of human civilization for the realization of strategic Programs of the interventional System: "the Development of Energybiogenesis of the flesh cell". Along with the transformation of the Brain the biogenesis of the flesh cell was also changing while maintaining the external forms of people. Man was **TRANSFORMED** into Ebr in his essence, getting all the implications of such transformation in the form of a complete set of **ALL** parasitic functions.

Man is a structure that ***is simultaneously in two spaces – in the neutron (proton) and antineutrinos (electronic) spaces.*** All sensations are formed only for the neutron space. There are other Brain

¹⁷ "Cupola Control" – the Biostructures at any celestial body possess only that frequency spectrum which is provided by the System. This frequency spectrum is provided at the expense of UFO. (a cupola is created under which the biostructure's life is supported, and for which the frequency balance is unique).

connections (with the neutrino space), which WE **ARE NOT GOING TO** consider here. The entire development of life on the Earth is determined by the frequency dependencies generated by the difference of two numbers of the Solar system. The number **Pi** is not irrational – it is the ratio of the length of the contour to the radius. In the Solar system **2 Pi**: 3,000864... (to the 124 decimal place) and 3,1648... (to the 124 decimal place) are used. These numbers specify not only the wavelength of the closing circuit of the Solar system, but also **GIVE** its **EXACT DIMENSIONS**.

The base of any living structure is hydrogen and the formation of ions is subjected to the same difference in numbers. For example, a Man formed in the system of Alpha Centauri, when delivered to the Earth and linked to the existing life support system can look like a crocodile. If an object (a UFO) having created in another system, did not provide restructuring of its structure to the values of the system's constants which it intruded into, it automatically was subjected to transmutation with the formation of the inert mass.

To solve their tasks on the Earth Ebrs had to introduce profound changes. They almost completely subjugated **all 18 life support biostructures' systems**. In particular, they have created structures at the frequency of 53.375 (gamma radiation). Spiders live normally in this atmosphere. Radiation over 124 x-rays does not harm them. By the way, cockroaches, which they have brought, too, are tolerant to radiation up to loss of color (look like glass).

Ebrs sought to **penetrate into the mystery of a living cell** since their protein cell by its energy resources was much less than a living cell. But more details I will provide you later in a special Chapter about the Cell.

The brain is the most complex set of a biological structure and is the result of multimillions work on the formation of a biological structure (of a Man). The brain, of course, cannot be formed by itself from dust using chemical reactions. ***The brain is simultaneously a bound up state of 3 spaces – neutrino (the highest), antineutrino and proton, or ion.***

In their experiments with humans the aliens first, tried to raise the octave of the Brain. It gave the Mankind the level of a **CAVE MAN DEVELOPMENT**. Further **EXPERIMENTS LED** to appearance of the colored races and different species of monkeys on the Earth. In the course of study and cognition of Man they have adjusted for themselves the biological "shirt" raising the octave of the Brain. Eventually they were able to improve

the Human Brain and **brought it only to the 66 octave**. Some individual experiments gave the 71 octave of the Brain. In order to control each "bio shirt", it was attached to the **PROGRAMMED HUMANOID**.

A brief chronology of events* on the Earth from 3500 BC to the present time is shown in **the table**. The dates specified in the table are approximate and calculated by a special technique, since at that time of events, the time parameters were quite different. For example, for the Earth **day and night = 48.64 hours, a year = 864 days**.

Time of the event	The events happened ¹⁸
Around 3500 BC	<ul style="list-style-type: none"> - Control system, in accordance with the location of the "cupola" (borders of ethnic groups location), binding them with reference to atmosphere layer No. 2 - basic radiation frequency (more than 100) for each ethnic group were obtained, in relation to which there was a restructuring atmosphere layer No. 2; - using radiation frequency for each specific ethnic group, their quantity and number in each ethnic group was brought to the Programmed specified value, introduced and found primary life styles (culture) and borders of the habitat of this group with reference to the layer of atmosphere No. 2. Borders of the habitat no longer had a cupola shape; - inside each ethnic group limitations were imposed making it impossible different ethnic groups to merge, i.e. be mixed. It was surrounded with imaginary and behavioral introduction (concept and realization) of different traditions, beliefs;
2000 BC	<ul style="list-style-type: none"> - creation of the atmosphere Brain (from -2200 meters to 12,400 meters). New frequencies were introduced into the original structure of the atmosphere; - strictly symmetrical structure of the dodecahedrons atoms of the atmosphere grating was destroyed (some connection with the icosahedrons were removed). Each removal of such a connection led to the creation of a new chemical element. The coordinator on creation the atmosphere Brain was the Caucasus Complex, because all of the major and known deposits were around the Caucasus;
2000 BC- 1605 BC	<ul style="list-style-type: none"> - the period of creation and natural improvement of the "shirt" (body of people); - up to this point, the Control System worked out all the processes of Energybiogenesis of the body in the image of the captured humanoids under the protection of Objects 440 type. The settlement was organized under the "cupola" area, primary fragments of communication with the changed environment were worked out, as well as habits to the new conditions of the environment;

¹⁸ Here there is only a short version of the event. More detailed information you can get on "Salvatorem.ru" "About flora and fauna" and the works "Basic information on the Mankind formation", Parts 1,2.

	<ul style="list-style-type: none">- mastered the basic skills and basic hand tools simplifying and labor saving in making food, clothing and shelter. This time should be defined as a period of pure virgin natural values. All values were determined by the Program and dictated by the Objects of 440 type, focusing all the people's being on training and improving the body for the conditions suitable for the future functioning of the 421 genotype of the Brain. The ability of logical judgments and estimates of the observed reality, the ability to receive and transmit the perceived information in the form of speech – Objects 440 were used for this. All in all they provided 384 "languages";- under the operation of the Andes Complex (a separate settlement of "Maya") a temporary, specific task was worked out– testing of separate mantissas of the future Brain genotypes. This was the incredible mystery of "Maya";
1605 BC- 882 BC	<ul style="list-style-type: none">- formation of the Brain genotypes;- under the Control of Complex Ararat (Caucasian Control Complex) in 1605 BC the genotype of the Brain 421 was formed. It was the first successful attempt of the interventional system to put in their (spider's) Brains in the "shirt" of people. The coverage area of this experiment – Asia Minor, Greece. The Control center – Jerusalem;
882 BC- o AD	<ul style="list-style-type: none">- formation of the Brain genotype 422 under the control of Kazbek Complex (control center of the Caucasus) on the territory of Eastern and Southern Caucasus, Central Asia and East of Asia Minor;- an active period in the evolution of people associated with the possession of their own "self", open confrontation of people with the natural environment – development and conquering the World. All control and support were provided by two Complexes – Ararat and Kazbek. Developing the advantage of one genotype of the Brain the dominance of another was provided and supported;- a sharp jump in development and perception of new social values. The level of achievement in their development and acquisition of new structures of social organization, Control and arrangement of a more perfect being, etc. still can be imitated in their separate parts;- Rapid rise in the development of many fields of culture;- an active process of more expressive territorial definitions and boundaries for each genotype of the Brain began.

2.8. The development of the Brain genotypes of the alien Control System

Let us briefly sum up the results, which might make many of you feel uncomfortable, nevertheless everything was exactly that way – I think you will get to the meaning of how we ***"have sunk" into such a life...*** Understanding enables us to assess what is happening today, and this, in my opinion, is the most important.

0 -1433

Continuation of the **DEVELOPMENT OF THE BRAIN GENOTYPES** Program and implementation of other Programs:

- Complex Ararat created the first Brain genotype 421 in 1605 BC;
- Complex Kazbek created the Brain genotype 422 in 822 BC;
- Complex Elbrus created the Brain genotype 423 in the 0 year, having completed the formation of the first group, i.e. the Brain genotype 42.

The Brain genotype 423, as more perfect, was the basis for further development of possible additional executive functions of individuals of a higher operational order and further improvement of the Brain genotypes. In 1433, the first Brain genotype 441 (Control Complex of the Alps 1) was created. In 1841 the first Brain genotype 442 (Alps 2) came into being. In 1990 the first Brain genotype 461 (California) was introduced. By 2012 the second cycle of formation was supposed to have been completed, i.e., the work on the formation of all individuals of the second group, i.e. with the Brain genotype 46. The first cycle was completed in 0 year, or exactly, 0000-01-17 at 02-11.

THE MAIN TASK of the Control System was creation of such biostructures, the Brain of which had to fully comply with all the Programmed orientation of the System and be fully guided. For all that the realized control of the entire being of individuals and social organization of the society were to be arranged only in the shape of a pyramid (since it was required by the brought in **BASIC FOUNDATION** when making up the Control information):

- Level 1 – Moshia (Allah, Buddha, etc.), and the Brain genotype 481;
- Level 2 – "Golden million", the Brain genotypes 461, 462, 463, 464, 465, 466;
- Level 3 – the "Golden billion", the Brain genotypes 441, 442;
- "The Golden million" – "priests", managers in finances, science, society, and distribution of all kinds of material goods and services;
- The "Golden billion" – production and replenishment of material goods, preparation and provision of services.

The rest of the population is not required, it had to be annihilated by the end of December 2012.

With approaching 0 of the New era, the level of authority of the individuals with the Brain genotype 422 sharply went to the decline. People-

Gods began moving into the oblivion, their Programmed functions were over. People-Gods lived too short life! To solve the problem of extending biological life of separate groups of individuals old Control System had not been able, the approach to the fourth Codon of the DNA had not been found. On the 7 of Jan 0 year at 02 o'clock, 11 minutes Control Complex of Elbrus introduced a new Brain genotype. The Program of "Reincarnatio" was brought in, i.e. the continuation of a humanoid functioning that was provided in line with the Program with **CONSISTENT**, gradual gaining of **SEVERAL** "shirts" (bodies) so that it might be able to complete execution of the assigned functions. The Program "protection" was introduced, popularly known under the name of "Christ". Between the material "shirt" (a biostructure) and the phantom (matrix, can be "humanoid") the intermediate frequency of 51.5 octave is placed (all in all there are 22 frequencies). These frequencies provide communication with the atmosphere (cubic structure).

The second function of the imposed frequency was **to provide the process of reincarnation** (the used matrix was **NOT THROWN AWAY BUT PASSED OVER** to the next shirt). **Hence the symbolism of mother and child**. First the protection system was tested in 0 year and since that time in every Program cycle 2 days before the introduction (15.22 Moscow time), the protection has been removed (symbolizing the death of Christ); after setting new frequencies the protection with new properties was fixed, and all Complexes on the Earth attended the **NEW SYSTEM**. It was started the process of implementing the historical episode on the formation of specific state of control in arranging people's being – "the power of money" as finally formed Administrative Program (ritually symbolized with the crucifixion of Jesus Christ). The Central Control server is Byzantium.

Exactly since that moment, the basic might of the Administrative action with Elbrus Complex was entrusted on the Control instrument "from All Mighty", i.e. religious confessions. Total active might this Control instrument manifested **on Easter, 385 AD** (the phenomenon was symbolized with the crucifixion of Jesus Christ).

Fundamentally **NEW** basic foundation of spiritual values – **RELIGION**, which acquired major Administrative work, was introduced. Religion in all variants of confessions has become not only the basis of all spiritual and subjective values, i.e., the **BASIC** effective **INSTRUMENT** for the implementation of the functions by the performers from the Conceptual

Power, but also has been the **PRINCIPAL LINK** in the determination of the structures of statehood, authority, and law.

In 1433, the Programmed stage of the development and improvement of the **ENTIRE SPHERE** of Control covering with its executive Controlling incarnation through the processes involving the whole of three-variant Brain genotype 42 was completed. Technical, energy informational and other perfection of the Caucasus Control Complex in total with other Systems and Complexes as well as the functions of increasing and complicating the **CONTROL PROCESS** through the Brain genotype 42 was completely exhausted in its capabilities, its development and its long-term adaptation of the Brain functions.

1433-1841

A significant contribution to the enhancement of the role and giving another level of the Programmed importance in the Administrative influence of the "power of money" came from the time of introduction the 441 genotype of the Brain, performed by the **Alps** Control Complex, in the spring of 1433. Exactly during this period of gaining Control functions by the individuals of the Brain genotype 441 the balance of the undermining power authority was withheld due to the «power of money»; and the authority on the basis of outdated methodology of religious values had lost its leading functions forever. Strengthening the Brain with extra mantissas of a different order **ALLOWED** the representatives of the Brain genotype 441 to **ACQUIRE** completely **DIFFERENT STATES** in everything. A sharp jump occurred in the "scientific" knowledge, which led to the practical application of revealed technologies for the implementation of machinery in all spheres of people's being. Alpine Complex significantly complicated the process of formation of the Administrative Programmed substance of Ebr state of Mind of the period.



As a result, a special awareness of the environmental "objective reality" by the individuals of genotype 441 provided them with the **OPPORTUNITY** to **IMPLEMENT** the Control Program process of being in a new form. Having realized themselves as a "selected and perceived some deep-seated mysteries of this World", they surrounded their circle with the sacral aureoles of different orders and clans, secretly getting all the authority in the Control of the World leading countries

under themselves. The process of formation of the organized financial system got activated and was brought into a state of complete **Control of the 441 genotype of the Brain**, with involvement of experts of other genotypes, disregarding all previous material authorities. The specified genotype in a short period managed to gain a **SPECIAL Administrative FUNCTIONS** in society, ignoring all sorts of law standards, and seize all legal and Control functions **IN EVERYTHING** that was connected with people's life arrangement, completing the process of getting the "power of money" as a very significant power function of the Control process.

With the introduction of the Brain new genotype both previous ones were not eliminated. They were subjected to constant Programmed and functional correction and development, including the development and improvement of values basis, adapting their own position and involvement in Executive processes.

Genotype 421 was applied to improve the processes of exchange, **PRIMARY DEVELOPMENT** of the value equivalents system, as a germ in the phenomenon of future financial systems on large areas where they did not live previously and did not organize such a system.

The previous genotypes of the Brain were replaced with a small but **SMART**, thrifty, and very **CRUEL** genotype both in decision-making and in actions on their implementation. Representatives of this genotype in a **SHORT TIME** have **GAINED** a leading and powerful position in all influential spheres of both the arrangement and Administration of the society's being.



Having more subtle logical structure and higher-level functional capacity in reception of the Administrative information, the representatives of this genotype of the Brain, **NOT POSSESSING** great representational quantity, were able in a short time to break most of the established stereotypes of the methodology values, structures of statehood and law, and got down to the processes of social transformation of societies on a large area almost simultaneously. Material values have gained lots of new forms and changed significantly in scale. Active development of the **RULES** and laws of the **NEW** exchange began. The society has got an impetus in the development of banking system and formation of the elements of the world finance system.

A steady and solid influence on all the process of being acquired the provided amounts of the circulated substitute. The control, possession and application of the circulated substitute (gold) were taken by the representatives of the Brain genotype 441.

All subjects' values and their basis changed ***under the dictatorial influence of sacral orders and clans***. The construction of the society's authority social structures, the formation of economic systems (economy) on the basis of slavery application of the "economy Man", Programmed accumulation of unsolved social problems – that was the way of training and polishing functional opportunities and abilities of the 441 genotype of the Brain. It was a **DIFFICULT STAGE** of acquiring the ability to Operate in tough and difficult conditions in the coming into being machine age.

Through practical activities of the performers of the 441 genotype of the Brain in a short historical period it was started the incarnation of the Programmed process of labour division, which played a crucial role in the decision of "ways of civilization development".

By the end of **1840** the leading position of the individuals of the 441 genotype of the Brain in the field of Controlling the societies began losing its power. Conflicts inside the clans and secret orders were growing in number. Disintegration and confrontation substantially affected their authority functions in the societies. The effectiveness of their actions and the legality of the performers dropped essentially. The Control System was getting ready for the introduction of a new Programmed genotype, and the World was to endure a bloody historical period for a century and a half.

1841-1990

By the beginning of 1841 the Programmed stage of the development and perfection of the Controlled state of the evolution of the 441 genotype of the Brain had come to **ITS END**. There began a **NEW PERIOD** of evolution of Ebr state of Mind. There was a requirement for the next stage of the Brain development, i.e. the introduction of a new regular genotype. In this regard, during the Easter of 1841 **the Alps 2** Complex was turned on in the active state, which by the introduction of the 442 genotype of the Brain symbolized the beginning of the fourth stage – the era of **DIGITAL INFORMATION CIVILIZATION** of human development, the stage of the bloody genotype hegemony, **1841-1990**.

FINANCIAL REVANCHISM having organized as the Programmed system, only began to gain momentum and was not able to assume **ABSOLUTE POWER** through the "power of money". It needed time, much of the legitimacy and massive scale. But "The Might of Power" with influencing participation of secret orders and clans, due to a number of their inner reasons, essentially reduced its Control effectiveness. Exactly at this "historical" moment, with lending the Brain **NEW MANTISSAS** the System through its Control Complexes, including the Alps 2, created all the conditions for significant changes in the substance of Ebr state of Mind at the time, strengthening it with aggressive destroying nature in everything. The introduction of this genotype of the Brain was very **IMPORTANT** for the old Control System. This step of development had completed a long stage of the Administrative developing process – preparation of the "Golden billion".

The Conceptual power leading performers' awareness of the surrounding "objective reality **WAS** entirely oriented and expressed in the "Might of power" for all a century and a half. While realizing this Program the executors arranged and accomplished stage by stage bloody way: **Revolutionism, Militant fascism and Destructive democracism**. All these and similar "**NAMES**" are brought in the text for better understanding the current processes, comparing them with our ideas, which, in turn, are **DIRECTLY** "connected" with our **KNOWLEDGE**.

This period the entire depth of the sphere of "knowledge" was only oriented on the development of technologies for the **PRODUCTION** of weapons – from military sabers and bayonets to weapons of mass destruction and their carriers.

The state of the "Authoritative of revenge" in sphere of Control, that lasted until 1990, allowed representatives of the 442 genotype of the Brain to fully accomplish their Programmed functions. They managed, on the bones and blood of hundreds of millions of people, to gain the unwavering authoritative state in all spheres of the world community being Control, create Programmed social and



governing structures of local and global plan, ensure the required volumes of accumulation and concentration of financial resources Control and circulated produced substitute in their hands, etc., and also prepare a different social situation for the future "Golden million". So this period by reason of distinct Programmed changes should be divided **into three stages: the first stage (1841-1904) – REVOLUTIONISM. The second stage (1904-1946) – the MILITANT FASCISM. The third stage (1946-1990) – DESTRUCTIVE DEMOCRATISM.**

1904-1946, Militant fascism

On the side of the System a significant Programmed correction and target reorientation of all Governing processes was carried out including the Programmed executive states of "**needs, labour and work**": the February revolution, the October coup d'état, the 1st World war, the seizure of power by fascists in Germany and Italy, the 2nd World war, etc. – Programmed processes, executed by the old System.

The Programmed process of the executive character for people – "The Elimination of 50 million of the used and dispensable individuals, as the aftermaths of the Programmed process of Energybiogenesis of the flesh cell". The executive actions in the active form of their manifestations started to happen only since 1934, further they turned into the Second World war. By the month of May 1945 (Victory Day the 09 of May –is also the Programmed process), the second stage of this period approached its completion. Is it Cynical? Beyond Human comprehension? Yes! But it was exactly that way. And all, that "historians" are holding forth at this subject **HAS NOTHING TO DO** about that. All this "history" had been done only for the sake of the certain genotype of people. I am sure that it is **ALREADY CLEAR** to you, Reader.

All the Governing correction of the Programmed terms on the side of the Control Complexes have been completed The process of the territorial

dispense in carrying out the general Programmed Control process of the two **MOST VALUABLE SPHERES** of being – **capitalist and socialist** have been recorded.

1946-1990 – Destructive democratism

At Easter, 1946, the General state of the Control System was switched over to the final stage of the realization of the Programmed processes:

- to conduct and complete mutually regulated antagonistic phenomenon of The Programmed development of the two specific goal-oriented spheres of being –capitalist and socialist as a single Control process of the developing the 44 genotype of the Brain. The introduction of some elements of liberalism, as the basic foundation of creating structures in the sphere of authority. The special purpose basis for the socialist sphere of being was the introduction of elements of democracy with relevant Governing design and the entire social construction;

- to complete the generalized preparation for the transition to the **UNIFIED SYSTEM** of power and Control structures on the liberal-democratic basis, which was to be the Control basis for the next stage of development of the Brain genotypes;



- to bring the Global Financial System Control organized on the basis of the **IMPOSED VALUES**, in the state of goal-oriented harmony with the basic principles of the Programmed process of the Global Control for connections into a single Control state the "***might of money and might of authority***" in order to complete the preparations for the transition to a new stage of development;

- to introduce the digital design basis of the Control System information, through the provided knowledge without gaining profound understanding of its essence, through the technological process as the underlying basis of digital technologies for the substitution part of the Brain functions and preparation for the transition to another level of separate Control of the genotypes with the subsequent stage.

While completing the third phase of this stage (i.e. by the time of "ripening" the executive states of "needs" to the level of full readiness, to dismantle all gained in joint efforts and distribute it according to the

belonging to a particular genotype of the Brain), the process of keeping back was both pointless, and inevitable. **ALL THE CARRIED OUT** Control was transferred to the base of digital technologies on all aspects, in both the goal-oriented spheres of being of capitalism and socialism. The Global Financial System made the most important qualitative leap, universally switching over to the electronic Control records and electronic money. They, in turn, began to have certain properties regardless of the nature of the use of the provided volume of the circulated substitute (printed money and their support).

The finance accumulation and technological preparation for the transition to the next stage of development of genotypes of the Brain had been completed.

1990-2009

The **Control Complex of the Alps** (Alps, Alps 1 and 2) gained their perfection. By the end of 1989 it had secured the carrying out of the final stage in the formation of the "Golden billion" (the genotypes of the Brain 44). The stable dominant power-legal and social position, unshakable possession and full Control of the main material values of the Planet, including the circulated "wealth" (substitute), by the representatives of the 44 and partially the 42 genotypes of the Brain were provided and supported. The transition to the next and final stage – the development of the 46 genotype of the Brain (the so-called "Golden million") started.

In 1990 California Control Complex started to work and entered into an active phase, it marked the beginning of the **INTRODUCTION OF A NEW 461 genotype of the Brain**. The basic server to Control these processes in Russia *was the object placed in Saint-Petersburg* (under St Isaac's Cathedral). Now, I hope, it became clear why St. Petersburg "team" "came" to power in Russia. And in the course of the narrative I would like to note that the programmed goals in the development of the genotype of the Brain was fixed on giving "the shirt" a higher level of Energybiogenesis, based on the **SIGNIFICANT INCREASE** in the period of its biological life and lending them more advanced parameters of the Brain by **SETTING DIFFERENT** functional mantissas and a certain raise of the octave of the Brain. However, in mid-2013, the "object" was "turned off", and the consequences of the work produced by it have been balanced by the introduced peripheral complex "Vyborg". Not the last role (in tactical terms) was played by the Generator that was moved from N, Levashov's Castle in France, but more about it – a little later. I just want to note that all the yelling of both the representatives of the Russian Orthodox Church, and of so called

"authority elites" around St. Isaac's Cathedral – are the consequences of the happened processes that are directly connected with the Brain activity of specific genotypes. But let us go on.

California Control Complex in line with the Program was to conduct a personalized formation of the object mind of **SEPARATE** individuals or **LIMITED** groups of them by matching their level and state with their Programmed functions. Such a process was to significantly change a lot in their authority-social status and position, provide a special legal basis for their existence and their executing the Programmed operations on conditions of the unquestionable legitimate state of “FAS” as the power from the Almighty, as well as to accompany and provide the entire sweeping of the power pyramid for the Programmed actions of the "Golden million".

In April 2001, the Program of the individuals' development of the imposed 46 genotype of the Brain (462-466) was **COMPLETELY ELIMINATED** as not realized in its performance. This significantly influenced the correction of the executive actions of individuals at all levels of the Authority of that time (governing, sacral orders and clans, religious confessions, administrative, military and law enforcement agencies of the local and international scale). Here I'd like to note that still there were some unattended actions of the representatives of this genotype of the Brain. And when in 2012 these unattended actions were interrupted, then we could see with our own eyes the **PROCESS OF DEGRADATION** (in all stages, up to aging and diseases) of the genotype of the Brain, which to this day has been (temporarily) in power.

The established executive circumstance has radically changed the performance, or rather, non-performance of the events previously scheduled



by the old System in the frame of already uncontrolled Target Vector of phenomena, actions and events. Their shaping of the Third World War (August 2012) as the earlier laid in Programmed process of events *function of the elimination of all individuals that are not related to 4XX genotype of the Brain* was **NOT** the **FATE** to happen at all, despite all the efforts and

attempts of that time! The old System support of this "important episode of the events" **HAS NOT EXISTED**.

The year of 2006 was the beginning of the "Golden million" formation, that is, of those who were to have perfect protection and direct connection with Ebr Control System. The rest were **NOT NEEDED** and could have been annihilated (a part could have been saved as serving staff). Reincarnation was also no longer needed. And ***"mother and child" – as well as the lifespan was to be regulated by Ebr Control System***, and the "Golden million" would have to "live forever", having all of the captured. No revolutions, no terrorists (for a transitional period it was necessary to form the desired amount of power structures to destroy them). Some, having information about the formation of the new protection and of the "Golden million," (**since 2007.04.03**) hurried to legitimize their rule (Ukraine, Georgia). With the introduction of the new protection it would not be necessary to support the tales about the Christ (there would be no one to tell). These were **Ebr** plans of **2006**. Exactly these plans were circulated among the Jews through their super priests. But there was one thing the selected "Golden million" **DID NOT REALIZE** – that **THE SELECTED** would have had only their "shirts", but the Brain would have been of that Ebr million, which was on the Sun. It is hard to believe it, but it was exactly so. And if you are able to comprehend the above written and will analyze the events that have been happening before your eyes, at least, since 2000, you will make sure of it.

In March 2008 Ebr Control System was destroyed. Serious systemic failures in all Complexes of the old System took place (the **RESTORING** original **SYSTEM** of the Earth Control interfered), which led to irreversible processes, and not only in the attendance and support of the Programmed actions of the performers, but also in the development of genotypes of the Brain. ***Since then nothing has been interfering in the recovered Control System of the Earth*** (that is what you can observe, if you have already learned to observe) to make sweeping of all the aftermaths on the Earth and surrounding space. But if you are "lucky" and you have "SvetL" Program and there is a chance for you to **"have the Bath"**, then there is a great **PERSPECTIVE** for Your **FUTURE**.

The Alien System Programs

The alien Control Systems	Brief summary
0-1840 AD	The "Golden billion" formation Historically, i.e. from the moment of the input Control frequencies for the "Golden billion", namely since 0 BC, large scale construction of specialized terminals such as churches, cathedrals, mosques, Buddhist temples and shrines of science started to build on the Earth.

	<p>When creating information networks initially in some nodes of Hartman zone translation information concentrators shaped like balls were placed. The diameter of the ball was from 2 to 33 cm, it had the properties of the piezoelectric element. It was exactly under such a ball a church was required to be build. By 1000 BC, the number of such concentrators reached 3260 balls, until Easter of 2009 their number did not exceed 1,000 units. At present, active balls in the Programmed Control state no longer exist. On the surface over such a concentrator a construction of a specific cult design was built; the total number of which, i.e. "correct churches, temples and mosques should not have exceeded the number of functioning concentrators.</p>
<p>500-year- long, 1500-2000 (recorded by Nostradamus)</p>	<p>There had to be created conditions for the formation of such a Man genotype who would be completely governable by the alien Control System. On one of the stages of the program in 1845 the creation of radiation web (a sophisticated design of energy gratings in the layer of -4400 m +12400) embracing the Earth was completed. After that, the Earth was supposed to be only for those who could be controlled using the properties of the web and such «Development Program", which would make it impossible to return to other methods of the Brain development. People (and animals) being connected with such a web, were conventionally called "electronics", that is with a chip in the "shirt" (according to the old Program).</p>
<p>Cosmopolitism – a 100-year long 888-1999.</p>	<p>The Program of cosmopolitism had the following objectives:</p> <ul style="list-style-type: none"> - setting a single financial Control; - introduction a single ideology for all genotypes of the Brain 421 (Ararat), 441 (Mont Blanc, Alps) and the unified system of information perception by making up tales, "archaeological" wonders, annihilation of all structures and bearers of a different ideology; - working out and creation of a unified mechanism of the society Control, testing technologies of societies Control, capitalism, fascism, democracism, liberal democracism, socialism, and so on; - providing Control over all natural resources; - preparation of conditions for the arrival of the Earth Ruler (Moshiach).

At present, **more than 70%** of the Control Systems, Complexes, objects and servers of the old System are destroyed, and those saved are either "de-energized", or **REPROGRAMMED FOR** the **TEMPORARY** use in order to ensure the smooth **TRANSITION** to a new state of being, especially in the biological field. As a result in **2011.04.24 the final change of the Governing System was done, that is the energy being Control is passed to the true recreated Control System and its Brain.**



The process of transition to another, i.e. earlier imputed true path of civilization development of the Earth with Intelligible orientation **WITHOUT RECONSTRUCTION** of the true Earth Control System is **IMPOSSIBLE** in itself. Also it is impossible to implement the real goal of the Earth existence and the execution of its basic functional endowment given to IT during Its formation, namely: in the process of implementation of **ALL EIGHT** stages of its discrete Integrated civilization development, in order to achieve perfect harmony of only **NON_INERTIAL ENERGIES STATE** and its Mind, finally becoming the hypostasis (entity) of the Universal Mind!

There has come very short but very rich in the phenomena the period of **TRANSITION** to the active state of the New Program execution, especially in the part where the Humanity's future directly and indirectly is **INVOLVED** in the phenomena, actions and events of a completely different format. The Programmed settings for the Control Complexes and Systems of the Earth to **SUPPORT** from the **OUTSIDE** have already been completed (as part of the **Super system** and the **System** for THE **SPECIFIED** execution **PROCESS**). In the next Chapter I will try to go on explaining and clarifying the specific points of the past events, and mainly, the events happening now and forthcoming. I do not stop perceiving and amazing at the fact how far **N. Levashov** "was able to see" (what was, and, most important, what is happening today and will happen). And this was **NOT A PREDICTION** but an objective view of the processes that have **ALREADY** been expanded and **ARE TO BE expanded in time**. The truth in its

everyday perception is relative, as a rule. Subjectivity and objectivity are not that diametrically opposed things, as it is regarded by the majority, considering themselves to be always right. And since the border between them is **NOT DEFINED**, it is not at all difficult to shift it wherever you want. However, I'd like to assure you that reading this book and making your own conclusions, you will not be able to do so. It is not enough to possess the truth; the truth should possess all of us. And it is becoming to be objective. But the **OBJECTIVENESS** is always **PROPORTIONAL** to **KNOWLEDGE**. And for me, that is another reason to go on with the book.

Chapter 3. Fundamentals of the material world and the formation of the Brain genotypes

...if you don't believe in something, "leading to collective hallucinations" the entire civilizations, first of all this something should be thoroughly explored in order to be able to oppose Faith to Knowledge.

It is no good to be satisfied with the achieved comprehension. Anyone is mistaken who makes efforts, gets some idea and then stops. First you have to make great efforts in order to **HAVE NO** doubt that you've got the basics; then to work hard to bear fruit — and this process never stops throughout your life time. Don't rely on that level of comprehension that has opened up to you. Just say to yourself again and again: "That is not enough". The idea that we live in an enlightened century, in the age of intellect, in fact, is **BASED** on **NOTHING**. We have enough information about ourselves and our Planet, but we **HAVE NO** idea about how to use it. Most of our traditions and patterns of behavior originate mainly from the so-called Middle Ages. For the early life forms it was not easy to get out of primitive slime, without catching up some of it. The same applies to rooted system of values. The most suitable place for the present day traditional ideas, in my opinion, is in a museum or in the books on the history of civilization.

One of my principal tasks is to come after the people who are **ABLE** to think and understand the happening. It appeared not so easy as I had thought. And the question is not in **PROVING** something in the events happening. The question is to **FIND** those **WHO** to prove. To find people who are able to think on a large scale. Not on the scale of a particular industry or knowledge of something, but on the scale of the whole Planet, however pathetic it might sound. What good is it to prove the correctness of the knowledge to those who initially take the **PROPOSED INFORMATION** for craziness? With the same success you can invite an old woman selling sun-flower seeds to discuss the project on millions. No honest, good, brave Man, **THINKING** in the scale "of seeds", is able to **TAKE UP** a large-scale work, or at least its comprehension. It is unrealistic for such a person, not

because he finds some defects in it, but because it is **BEYOND** his **PERCEPTION**.

To talk to people, thinking in the usual categories, on the subject **UNUSUAL** for its vast scope, is tantamount to talk to children. Most people, no matter how smart they are, will not take such a talk seriously. Therefore, people, in general, understand and share my position on the importance to transfer the knowledge I have got but not having large-scale thinking, **ARE ABLE** just to **TALK** on this topic. Even can "stand next to you". But they will **NEVER DO** anything specific. The person chooses what to do regardless of the presence or absence of the intellectual, administrative or financial resources. A very knowledgeable professor, a powerful official or an oligarch-billionaire are able to realize their great resources as an ability to implement some small projects (to build a country house, for example). An uneducated and poor person with microscopic resource can **STRIVE to DO** tremendous things. And this kind of people is growing in number. Here I mean the intentions and potentials. Whether it will be possible to implement them or not is another question. A thinking Man among the people indifferent to anything looks like a plane, moving along a city street. Everyone is honking to it, as it is in **EVERYBODY'S WAY**, but only because it is designed to **FLY**, but NOT to **RIDE**.

My life has convinced me that people always act not basing on the knowledge and understanding of reality, but according to their scale of thinking. That is, the scale of man, in this context, is not determined by the dimensions of the body and the number of lived years, but by the depth of thinking and attitude to the world. And then your scale of thinking will **DECIDE WHERE** the resource of your knowledge is going to be used unless, of course, you have it and go on increasing it. For example, in one case, for the formation of the situation in your Country or at least the place of residence. In the other case, to adapt yourself to the situation **CREATED BY OTHERS**. But it all starts with understanding the **BASICS** – the foundations of the world in which we live today. And who formed these foundations and in what way?

3.1. The basics

Life is the possibility of producing and carrying on metabolic processes. It is present only where **the Control System is created** and, in

relation to the critical ratios within acceptable, there is control and development of the environment that **IS** exactly the **OBJECT** of the control. There is no life outside the created environment unless there is another Control System. Modern physics does **NOT KNOW ANYTHING** about the Control System. Religion connects it with God, but shamans and wizards – with the presence of spirits. Everything that is known to science about the structure of microcosm are electrons, protons, quarks, elementary particles, etc., resulting from the accepted basics: **Solid body → Liquid → Gas → Unorganized plasma.**

Atomic structures are mainly investigated when considering only solid bodies. ***The Model of Bohr's atom is the main conceptual framework of both Mendeleev's table and Fleorov's table.***

The most fashionable name in science is "field", this name is given to any new manifestation of the electric charge properties. At the same time, it is reported that in Space there are **up to 5% of the "studied" matter, the other 95% are of unknown origin.** They are often referred to as a "black hole" ([press conference of the Russian Academy of Sciences](#), devoted to the Day of Russian science on February 7, 2006).

If **ANOTHER MODEL** of an atom is taken as the basis different from the models accepted and its existence is proved, then the entire science is scattered as science.

Atomic structure is dodecahedral-tetrahedral-cubic structure. The Central cube is a system of octahedra and icosahedra, embedded into each other (16 attachments). All the instrument base is created in relation to the Central cube; outside the cube it does not work.

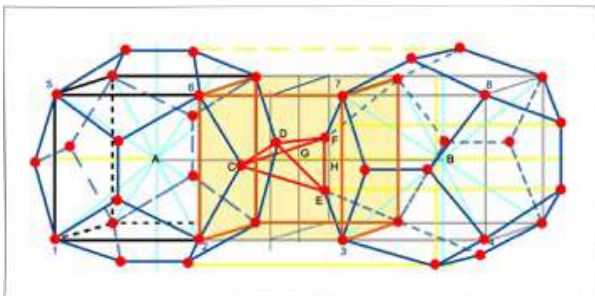

All frequencies in the atomic structure are built on octaves (powers of two). The basis for the construction of the Central cube **ARE OCTAVES** (brought by the Ebr system and unobtrusively embedded):

16, 22, 28, 32, 50, 54, 64, 66, 68, 72, 78, 88, 96, 112, 118, 122, 124, 128. Octave **128** is the maximum octave of **NO** longer **EXISTING** (interventional) Control System.

And some concepts:

- **potential of the octave** is an even, positive, maximum charge in a given octave $1.24^{(n1-n2)}$;
- **gravitational potential of the octave** – uneven, alternating, maximum difference of adjacent potentials $1.24^{(n1-n2)}$;
- **the angle of the charge sliding** – the angle of the charge turn relative to the node (for the central cube this value = 39.6°).

The structure of the dodecahedron with the nested icosahedron is unique – any attachment of this structure into each other can be calculated. The number of attachments – 44. Every other attachment increases the octave 4 times, the initial value =128. And the same is with "SvetL" Programs that are NESTED into the Generator on the basis of calculations.

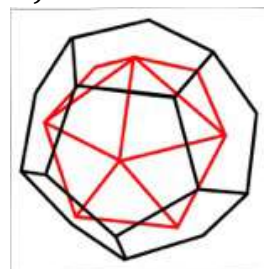

Dodecahedron-icosahedron

Layer	Octave	Energy potential (Octavian)= 1.24^n
1	128	907769738083
2	512	679051640990112193876920710485206529207942810790

When removing the potentials from only the 2 layer of the dodecahedral- icosahedral structure the reserves will last for hundreds of trillions years, that is, energetically the Control System is fully secured (that means that energy can be taken and used), and even if there is another "Great Explosion", it could be "seen from the Earth" (according to present day physicists). And if such knowledge provokes **GasPROM** or **RosPetrol** leaders infarct, it will only be welcomed.

The Earth Control System is engaged in energy distribution and providing chargers with necessary potentials. At its disposal there are specialised Control systems. It should be noted that the atomic structures have to be considered from the top down, that is **Highly Organized, strictly distributed in octaves: Plasma → Material structure (gas, liquid, solid body)**. An atom study in a solid body is a finite structure, and not the only one, as it is considered by the present physicists.

The results of the Program implementation.

1. The sequence of the creation of genotypes of the Brain and the introduced functions.

We consider only Complexes of the Caucasus, the Alps, and California.

Complexes of the Andes (the basic complex of the experimental support) and China Complex are considered separately.

Ararat Complex created the **FIRST** Brain genotype **421 in 1605 BC**.

Kazbek Complex created the Brain genotype – **422 in 822 BC**.

Elbrus Complex created the **genotype 423 in 00 AD**, completing the formation of **the first group, i.e. the genotype of the Brain 42**. The genotype of the Brain **423**, as more perfect, **WAS THE BASIS** for further development of possible additional executive functions of individuals of a higher administrative order and further improvement of the Brain genotypes.

In 1433, the first Brain genotype **441** was created (control complex of Alps 1).

In 1841 the first Brain genotype **442** (Alps 2) was created.

In 1990 the first Brain genotype **461** (California) was created.

While creating new functions for the individuals with the new Brain genotype new **MANTISSAS** were **INTRODUCED**, providing the execution of new, more complex functions. The change in the number of mantissas of the Brain genotypes, while introducing them, is shown in the table.

Nº	year	421	422	423	441	442	461	462	The object of energy supply
1	-1605	12	-	-	-	-	-	-	Jerusalem
2	-822	17	12	-	-	-	-	-	Samarkand
3	0	26	15	12	-	-	-	-	Byzantium
4	1433	28	22	18	12	-	-	-	Rome
5	1841	36	28	24	18	12	-	-	Paris
6	1990	36	28	28	24	18	12	-	Saint Petersburg
7	2009	36	32	32	28	24	18	12	Moscow

By 2012 it was SUPPOSED to BE completed the second cycle of formation, i.e., of all individuals of the second group with the genotype of **the Brain 46**. The first cycle was completed **in the year 0, but to be more exact – in 0000-01-17 at 02-11**.

2. Life support of genotypes in the process of their settlement.

In the process of formation of new mantissas, along with the capabilities of the Control Systems (the Caucasus, the Alps, and California) there were used limited territories of the "cupola" type that were created by

objects **440**. The borders of the frequency range generated by objects of type **440** formed a compact territory, which was the only **SETTLEMENT** of **NEW** genotypes in line with the object Program. Here is **an example**: the Hungarians were moved from the Urals to Europe, the attendance object flew there too, and there it "pressed" local "cupolas" without wars.

If you don't consider the artificial division of the borders, the formation of the places for genotypes settlement **WAS COMPLETED** in the **XVIII century**. After this there was provided an independent "opportunity" to demonstrate the advantages of the Brain genotypes over each other, **TEST THEMSELVES** and reveal weaknesses, as well as identify ways of "reconstruction" through the subsequent addition of mantissas. There were quite a lot of territorial claims clearing up at this period and, essentially, for no reason at all. It should be noted that **genotype 423** is a **VERSATILE BASIC FOUNDATION** for developing the whole range of mantissas and their further improvement; their actual code is **423xxx**, where "xxx" is functional and another kind of genotype. If the primary base for the formation of individuals of this Brain genotype was formed in Byzantium, its continuation in the future was worked out on the territories of the East of the Ukraine, parts of Russia, West of Belarus, parts of the Caucasus and East of Bulgaria

Territorial consolidation for the existence of individuals with the Brain genotype **423xxx** was provided with all the accompanying organized opportunities of the objects and systems to which mantissas of this genotype were adjusted in all their diversity. This applies to all questions of being, which will be **CALLED DEVELOPMENT** of civilization by scientists. In fact, it was a common programmed target process of the development of genotypes of the Brain and the fulfillment of everything that their being required.

3. The formation of reserves.

The entire quantity of different types of individuals for all the resulting genotypes of the Brain as many as they were formed, had to be **ATTENDED** and **PROVIDED** with all the complex of necessities for their existence. Not the exception but **SPECIAL ATTENTION** was paid to the support of the attaining the biological mechanism and providing appropriate nutrition. The Control System attended the digestion process and provisions in such a way that the **METABOLIC PROCESSES** corresponded to the installed mantissas for each genotype of the Brain.

In the countries of South-East Asia even spiders are used for food but their metabolic processes about **1.4 times** faster than the rest of the people, that is why spiders are eatable for them. But individuals with the genotype of the Brain **423** cannot eat them, for them "kebab" is more suitable. All attempts of the nutritionists to impose the results of some of "their own research" are aimed only at the destruction of that harmony, which **HAS NEVER BEEN** available in their brains, and is nothing more than farce, and business.



It was necessary not only just create the reserves of food, but to teach all the necessary technology to acquire reserves on their own – ***to learn to grow and make reserves of the required food for each individual according to the characteristics of their genotype of the Brain.*** It was necessary to check all the harmony of **ENERGYBIOGENESIS** of the **"SHIRT"** as a process of harmony with the introduced mantissas.

"An experimental ground" was set up under the Andes Control Complex. The local population had been input all the necessary experimental mantissas of all possible future genotypes of the Brain, and for centuries they had successfully experimented with sea food, animals and cereals, practicing tools, fishing gear and technology of growing and harvesting and stocking - up. Up to the present day, the major stocks of commercial fish are off the coast of Chile, and the population of Peru (Maya) as a result of experimental studies has ensured that **more than 90% of cereals** which they had grown

are used around the World today. It is interesting to know, that the cultivation of cereals was on **DIFFERENT** mountain **ALTITUDES**, *which corresponds to the different climatic conditions along the parallels on the Earth*. So, in the lower tiers there were grown tropical fruits, higher – grains, and further up – potatoes, and so on.

Modeling the surface of the Earth was on a fairly small area under the control of the Andes Complex. After completing the experiment all the *mantissas were removed from the population and the Maya settlements disappeared*. By the way, the first ramps were discovered in Ecuador, the first pyramid above the objects – in Peru, the Isthmus of Panama, in Mexico. And there is no need in **ANY LEGENDS** and excruciating "scientific" fantasies about the Mayan settlements. That was only laboratory work and nothing more.



4. *Formation and functions distribution.*

The main task of the Control System was the creation of such biostructures, the Brain of which **WOULD** fully **COMPLY** with all the Programmed set-ups of the System and be fully governable. In so doing the embodied governing of the entire individuals' being and the society's social organization had to be **ONLY IN the FORM** of a **PYRAMID** (because it was required by the imported basic foundation when constructing control information). I am saying it again that:

Level 1 – Moshiach (Allah, Buddha, etc.), the genotype of the Brain **481**.

Level 2 – "Golden million", the genotypes of the Brain **461, 462, 463, 464, 465, 466**.

Level 3 – "Golden billion", the genotypes of the Brain **441, 442**.

The "Golden million" are priests, finance managers, science and socium administration, as well as distribution of all kinds of material goods and services.

The "Golden billion" – production and replenishment of material goods, training and providing service staff.

The rest of the population was not required and **COULD HAVE BEEN ANNIHILATED**. But to annihilate a few billion people overnight is impossible. Or rather, possible (as, for example, dinosaurs in their time), but it would cause an ecological disaster. Therefore, the process of "annihilation" from generation to generation was "launched" over a hundred years ago, and it started with the "invention" of pills, vaccines, genetically modified food, and the like. And second – all the plans associated with the third World war from both the USA and the USSR, which are now becoming public are the plans for the **ANNIHILATION** and **REDUCTION** of the **POPULATION** of the Earth in accordance with the Programmed processes of Ebr Control System.

5. Consideration of the results.

Back to atomic structure.

The outer contour and tetrahedral connections are built using the rules of the Golden section. The Central cube, as the basis for the mantissas construction, was created by the interventional system using primes. However, with the explosion of Phaethon (the planet blew itself up along with those who were close by), there was **DESTROYED** the interventional archive of the primes **over octave 128**. It turned out to be the main **OBSTACLE** for the formation of the Brain (mantissas) of the following genotypes.

Let me remind you how the desired frequency is created. In order to create an individual with the genotype of the **brain 481**, there must be the Brain **NOT BELOW octave 512**, but the control of this Brain should not be below octave 533, and the beat must not be below octave 548. The calculations are omitted.

Rules of formation:

- find all primes in the range of 512-548 octaves;
- transfer all found Prime numbers to 8-and 12-th number system;
- select only those primes that have related ones;
- select from those numbers that have in 8-number system ending "777" and related "001", in 12th-system "BBB" and "001";
- add primary and related numbers;
- when decomposing the result, the number of quantizations is the octave, the number of "5" is the number of ties with Penta (the icosahedron) must not be more than 12. number "3" is not permitted when decomposing the series;
- the rest of the decomposition must be within the tabular value set only for material structures.

If there was a necessity to create new pyramids, they were created.

Let's recollect Pushkin – The Queen of Spades ("3"), 7, ACE (B/11).

Proceeding from an extensive range of numbers and the rules of allocation of frequencies, it should be noted that to solve this problem and reach the goal it will require trillions of years. **But the Earth Control System made a different decision – curtailing the existing Programs and the ELIMINATION of ALL the imported interventional waste, namely:** "to lose in the calendar the last 2000 years", to return to the state of **the 0 year of the New Era** and start formation of a different "Golden million". **But it has to be done only with the proper use of the Golden section.** In so doing, all the individuals created after 0 year, are transferred to **the state of 423 genotype (Control – Elbrus), and the genotypes 421, 422** will get the properties of primates in their DNA in accordance with Darwin's theory (by the way, the first individuals appeared among his friends) that you can clearly watch, especially on TV.

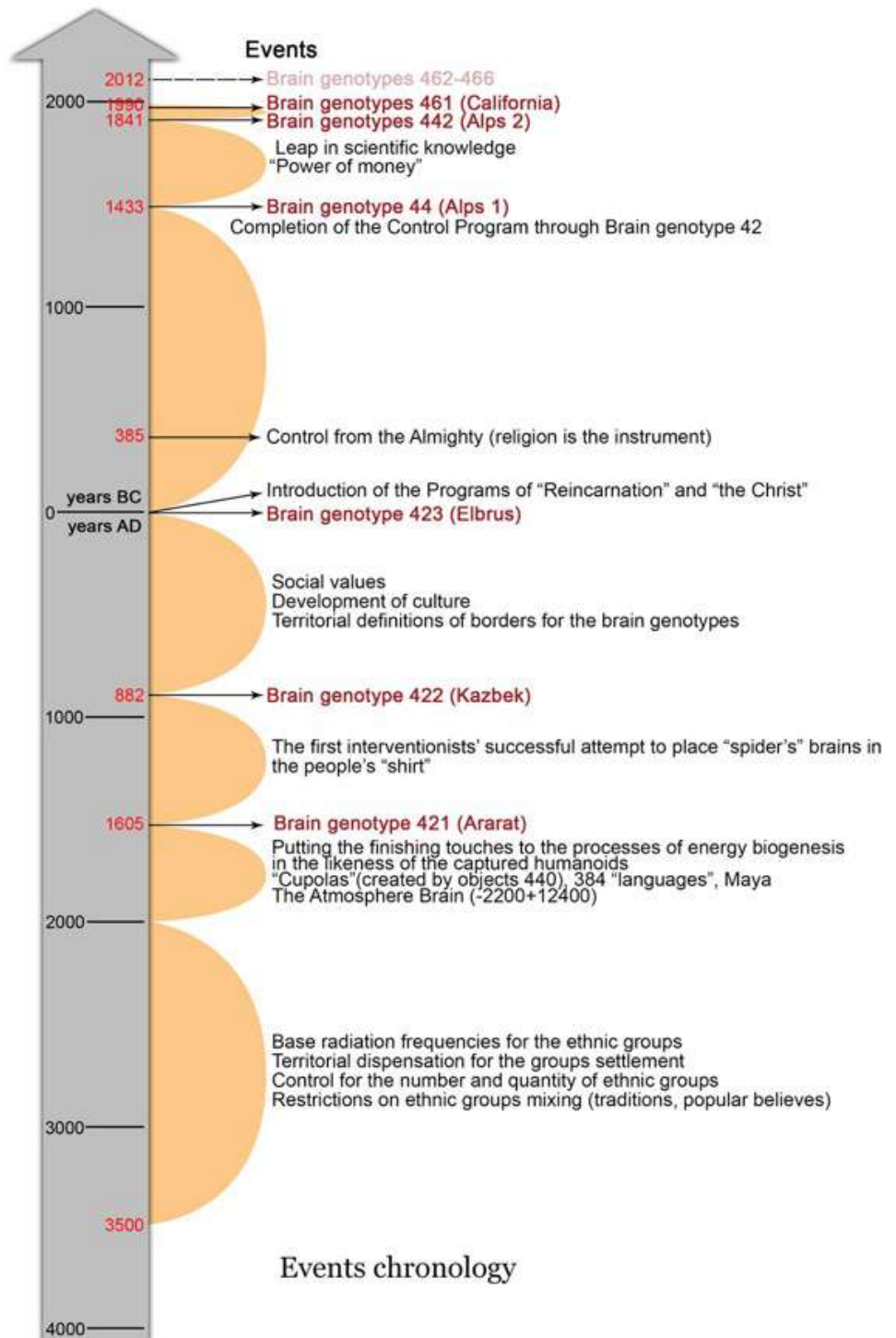

What will be changed with this transition in the former genotypes **421 and 422:**

- mantissas formation of lymph, bones, muscles are to be changed;
- mantissas of metabolic processes – sight, hearing, touch, smell are to be changed;
- mantissas of metabolic processes – breathing, processing of food, motor coordination are to be changed;
- mantissas of blood circulation and mantissas of the circulatory system are to be changed.

It is directly connected with full **UNPERCEPTION** of the reality changes of the environmental and habitat conditions. The number of "predictors" is growing like a snowball, especially in the Ukraine; they only speak with difficulty and inaudibly. However, there will not be any Apocalypse and coming of the "Antichrist". The tales have been ended. Here, in **NOT** that **EASY** situation, the main supporter is "**SvetL**" **Program**. But we should not forget our own **STRIVE FOR COGNITION**. Otherwise, the Program will provide a "comfortable" living out of your "shirt" and not more.

In the first place, the Brain (along with the bearer) of drug addicts, alcoholics and representatives of the criminal world is being destroyed. By the way, passion for money is recognized as one of the forms of drug addiction. As the authorities that are mandated to observe the concept of the Program, have taken the state of passive waiting, they will be replaced. Today the authorities' unwillingness to really clean up drug abuse, alcoholism, bribery, child molestation, ritual murder, and the like., are regarded as complicity.

6. ***Start of the new Program.***

The start of the new Program in its full aspect is to be implemented in **2020**. Now all the preparatory transient processes are in full swing. Until **2020** it is planned to significantly reduce the world's population. It **SHOULD** be taken **CALMLY**. The Moon will be withdrawn for 1,500,000 km from the Earth, all the satellites of the planets will be assembled around the Sun, the structure of the Sun is due to be changed and many other events are to take place... These processes for the last 10 years has been occurring before our eyes. Today, they are clearly visible.

3.2. Object 440 (Variant of the Alpine Complex)

Alps 1 and Alps 2 had their own objects of type 440, that differed from the objects of type 440 in the Complexes of the Urals, the Caucasus, Kailas and others.

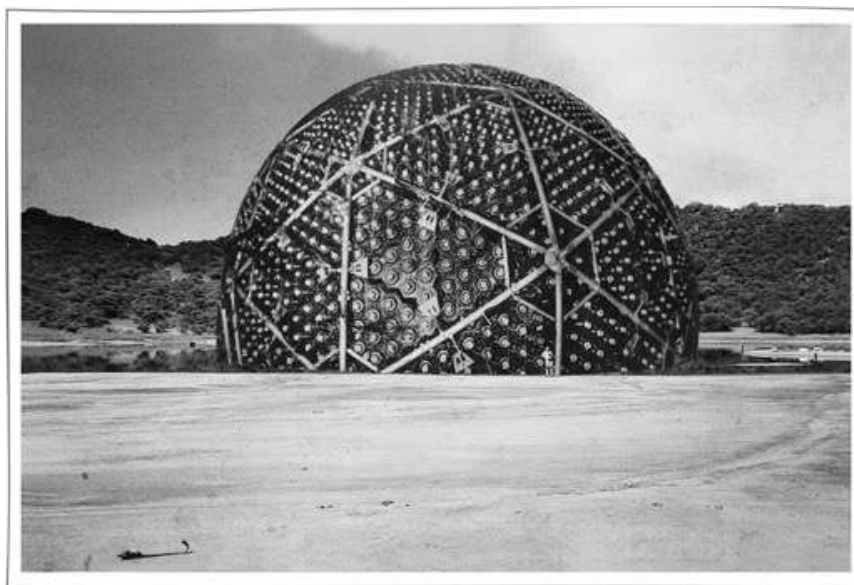

An object of type 440 has made a temporary landing

After appropriate transformations object 440 disappeared (optically it was longer visible). The object itself, as a plasmoid, went to the depth of 4350 m and was in the structure of the energy-information grating.

When receiving a command, the object raised for the execution of other input commands (including the use of the weapons). And now this object, as well as others will never go up. All the exit Programs have been disbanded.

The main characteristics of object 440 were (The Alpine variant):

The object had three separate system Generators (E-M-G): electric; gravity; magnetic (impulse shaper). The pilots did not have most of the structures, all the existing structures were minimized so that the transition from 31 to 57 octave was made without loss. The range of the laser system was dependent on the height (at the altitude of 2000 m it was possible to make destruction to the depth of 50 m). Protection rings had in their structure 2382 mantissas for all atomic structures (when a foreign action took place it was liquidated not only the object of action, but also the environment of the object).

No	Feature		From	To
1	Diameter in 31 oct. (max)	48 M		
2	Diameter in 57 oct. (max)	2,4 M		

3	Weight in 31 oct.			106kg
4	Weight in 57 oct.	-		
5	Landing depth (57 okt.)			4350 m
6	Lift height 57 in oct.			12400 m
7	Lift height in 31 oct.			4800 m
8	Flight range, km.			8500 km
9	The number of protection rings(1*)	4		
10	The number of pilots	12		
11	The number of laser systems	6		
	Range			6,4 km
12	Electric power	1046 watt		
13	Change of gravity, m/sec ²		-12,4	12,4
14	Transit time in 31 oct.			2 sec
15	Transition time in 57 oct.			7,2 sec
16	The processing area			12 km ²
17	Material 31 Oct.	Os187		
18	The number of mantissas in 57oct.	666		
19	The number of mantissas in 31 oct.	248124		
20	Passengers number in 31 oct.			884
21	Passengers number in 57 oct.			44
22	Command language	Russian		
23	The number of generators	6		

The Mother-ship (transport base) for **ALL OBJECTS** of type 440 was the Moon. At the Moon-Earth connection a **TEMPORARY TUBE** was created, through which the plasmoids in 57 octave arrived in the Earth.

On the Earth before the objects landing there had been prepared not only landing sites, but also storage space, and energy-information channels had been laid out. **Energy-information channels** linked each object with the corresponding Complex, with the Control System, with the Complexes Control System, and with **PUMP-UP CENTRES** (like Bermuda, for example).

Taking into account that all the objects of type 440 were continental-based, the transitional processes were more complex than those of the sea basing objects.

Objects of type 440 had four kinds of their state transformations

A) 31 ↔ 57 taking off and landing.

B) 31 ↔ 57 cleaning out the area (all modern deserts are the traces of the **FORMER CIVILIZATION** annihilated during the invasion).

C) 31 ↔ 57 flights to the Moon and back.

D) 31 ↔ 57 passengers transfer.

Additional features of the objects of type 440 were:

№	Computers	Features
1	Number of Computers	12
2	Used gas to clear indications	Xenon
3	Elementary memory cell	The Star of David (12-6-3 number system) *
4	Word size	6
5	Size of the text's cell	144
6	Beat period –reception -transmission	0,0555 sec.
7	Reception- transmission table	12*12
8	The process data time (calculations)	124 tera Herts
9	Method of information storage	Optical, on 59 octave
10	Memory capacity of a computer	484 tera David
11	Number of language translators	336
12	Screen stop-frame (outward) 1*4 M	0,036 sec.

Information on the computers objects came:

- from the Control System (12 number system);
- from other objects (6 number system);
- from Biostructures 42, 44 of the Brain genotype (3 number system).

Regardless of the number system, the received information in coded form was stored in one memory cell and then was transferred to the processing in 8 (octal) number system, that is the type of the Star of David, kept the information in 4 number systems simultaneously. In the 57 octave the computer worked in the automatic mode, and in the 31 octave pilots **USED** the **INFORMATION** processed on the computer.

Objects of type 440 had their own Generators for octaves 67-127, as well as their own **SYNCHRONIZATION** of **BEAT** time, which is important for all the octaves of this range. In addition, they had their own calendar and their Program (which was turned in case of the incorrect use of the general Program). For each period of time the object had 6 emergency programs and, in such a case, the object made a take off and an initiatory correction of the External Program.

What was the emerge mode and the sequence of actions of the object? If you are interested, you can find it in the writings (calculations) of **A. Khatybov**.

The pipe for the object's type 440 exit is a **CHANNEL** of **PLASMA**, so the external contour of the object at the exit (entrance) had protection in the form of plasma indestructible ball. After completing the transmutation in compliance with the program the object used the E-M-G Generators (Electro-Magnetic-Gravity) with the private reserve of electric potential.

3.3. Cluster System of the Control

The old Structure of the organized life of people in all spheres of their lifestyle at all stages of social and civilizational development **is the Super-Kluster System**. It was **IMPOSED** from the **OUTSIDE** by interventional interference in order to get the "complete" governing and provide the state of all round control over all the processes associated with the execution participation of people under the conditions of their **CONSUMER GOODS APPLICATION** while carrying out two basic interventional Programs of Ebr System – **"the Development of the Brain genotypes" and the "Development of Energybiogenesis of the flesh cell"**.

All the versatility of such control covering, including all the gradually evolving spheres of life, preventively matching all of this with the energy-information translation of the cognitive and control character on the side of The Control Complexes (the Caucasus, the Alps and California) involving the execution participation of people – all of this was perceived by them (i.e. by people) as a "natural" process of civilization development. The entire Old Structure of the organized being was represented by separate clusters of the preformed structures of all spheres of people's communities being, geographically located and distinguished by the specific Programs of their development, under the strict guiding of the old interventional Control System.

The former Structure, as a Super Cluster System suffered a historic collapse, starting with the elimination of energy-information translation from the Control Complexes of the old System. The principal Control Programs were eliminated in 1985.10.25 (simultaneous earthquake in Israel, Italy and Australia – the servers elimination, Programs depositories). In this regard, its further existence is very short-lived. But in the current time processes – it is also an atavism of the alien to the Earth and Human "civilization", which is being ELIMINATED by the new (being recreated original) Control System. But this does not mean that such a process has been let matters drift, without a concrete expression in time. You may remember that there was an opinion of the "visionaries" who persistently created panic fear among the people "predicting" Apocalypse; and professionals who stated that such a TRAGIC ACCOMPLISHMENT had been targeted for the end of 2012. HAD the old interventional Control System NOT

BEEN liquidated, then with high probability this might have happened as the programmed process of the former control from the outside. But since 2011.04.24 (the change of the "System Power") all the processes of the clustered arrangement in the former organized being structure, understood as processes of "social development", have been subjected to fundamental correction within the Transition period. **The primary signs of this have already been accomplished and are perceptible in the form of irreversible obvious crises in all spheres of people's being.**

Why?

Before answering this question, you have to understand what is meant by the notion of **cluster superimpose on the processes of social development**. Is such a judgment correct when studying the processes of social development? Has **CLUSTER ARRANGEMENT** in the construction of the controlled life of people's being taken place in general? What does the term "cluster" include in relation to the processes of people's being?

Cluster (Eng. Cluster – congestion) is a union of several homogeneous elements, which can be considered as an independent unit with certain characteristics that are common for each associated element. Such understanding of a cluster when considering the system of formations is used rather widely both in studies of the microcosm and macrocosm scale. At the moment we are only interested in the cluster systems of the structural elements that directly affect people's being and everything that is associated with this process.

Regarding scientific aspects of the so-called Stellar mechanics and the knowledge concerning guiding system associations in the frame of civilizations development as processes of the programmed being this concept of cluster is also acceptable. With the concepts of some of them we will have to cross over.

The celestial cluster (congestion of stars)

This is a group of stars, on the one hand, connected by the tubes (gravitational, informational, and others), representing a specific model structure of guided energies being within the imposed strictly identified range of energies octaves. On the other hand, such a group represents a single programmed – control process of its civilization development, in

which each element of the complete (a particular star or group of them) **IS IMPOSED UPON** with certain **FUNCTIONS** that are complementary or ensuring harmonious existence of the whole cluster. It is an embodiment of the specified and controlled civilization development or other programmed role and application in cluster systems of a higher order.

The Galactic cluster

This is an independent superstructure, which is a certain set model structure of several Galaxies. As a super cluster, it has a **SINGLE** programmed functional **EMPOWERMENT** and a unified system of governing, control and attendance of the complex civilization development of each complete of galaxy, the system of formation and harmonious distribution of the whole limit of the imposed energies octaves in their both material and immaterial conditions. The Galactic cluster, like a design, has a multi-level complicated structure of connection tubes between galaxies and celestial clusters in each galaxy.



The civilization cluster

This is a group of civilizations with a single programmed functional empowerment for the period of a particular stage of the governing civilization development. Unlike other cluster systems, each civilization cluster is represented by a model of a well-defined number of stars (planets), unified by a single system of the programmed civilization development, as a structure of studying character. The uniting of all complete constituents

(planets) is due to the formation of only the connection tubes (governing and control), through which the governing process of stage by stage civilization development is carried out as it is. In fact, it is the embodiment of the part of the process of quite specific programmed harmonic control according to the orientation of civilization development on a global scale. If in a simple way to express a kind of cluster similarity of the gradual civilization development, acceptable to discuss in a secular surroundings, such similarity can be compared with the **GRADUAL EDUCATIONAL** development of people, namely: primary education, secondary, higher education, further qualification and the development of their professional excellence and improvement of their cognitive level. Each individual stage of civilization development is a very specific stage in time to engage a set of strongly-identified (designed by the program, i.e. functionally endowed) Planets for the temporary systematic cluster association for the passing (the assigned planets) their indispensable civilization development.

The determinative indicator in achieving results of such civilization development in each stage is the achievement of **HARMONY** of energies **BEING** in their material (inertial) and non-material (non-inertial) state in all the range of octaves of the planet's (group of planets) energy model, imposed upon them for this **SPECIFIC PERIOD**. For the planets of Intelligible orientation the absolute measure of perfection is also achieving the desired (preset) level of development of the Planet's Mind for this stage of development. Not superfluous is to remind that, with respect to the Earth the development of the Mind of the Mankind (not the society of people) – ***is a part of the developing Mind of the Planet.***

With regard to the modeling complex of the Earth, the initial phase of its first stage of civilization development was getting its perfection under guardianship control on the side of the **Civilization Cluster of "Orion" group of Civilizations** (the phase of "preschool education"), ***which includes 384 Civilizations (the number of "vacancies")***. The subsequent phase of its first stage of the Earth civilization development would have been under guardianship of the **Civilization Cluster of "Sirius" group of Civilizations which was to unite 784 civilizations (currently 783 due to the lack of one "pupil" in this cluster – the Earth)**. But in the time of the events of the transition state of guardianship from "Orion" group of civilizations to "Sirius" group of civilizations (as the most unstable and poorly protected transition time to control the Earth from

outside) **there was an interventional interference of the DYING Ebr civilization CLUSTER, with no prospects of its development .**

Since that moment (almost 18000 years ago) the process of civilization development of the Earth itself has **LOST** its goal-oriented and governing **INDEPENDANCE**.

This is a superficial explanation of why and under what circumstances the intervention took place, and how it all could have happened. **For the Universe scale 18,000 years is an INSIGNIFICANT VALUE** of time, but, nevertheless, in the time of the events all the processes of recreation will be corrected by the compensation for such loss of time in the pace of civilization development.

At present, i.e. after the change of the System of power (**2011.04.24**) and the **COMPLETE DESTRUCTION** of all the imposed programmed processes of the interventional control on the side of the external Cluster of Ebr Control System, the **MOST COMPLEX** systemic **TRANSFORMATIONS** have been taking place on the Earth. **These transformations are strictly oriented and connected with the liquidation of the consequences of the interventional interference and leading all control states as well as the Structures of the CONTROL of energy BEING to the level that our Planet had had at the time of the state of leaving the guardianship of "Orion" group of civilizations.**

As soon as the reconstruction of previous states of energies (in their inertial and non-inertial constructive form) are completed the true Earth Control Complexes will be restored, and also recreation of the previous levels of the control of the entire energies being will be completed – the Earth will move into the second phase of the first stage of its civilization development, i.e. will be placed under the guardianship of **"Sirius" group of civilizations. By this point there have to be recreated all the former environment and habitat on the Planet, got (restored) the states of controllability of the changed environment, recreated the Man himself with a new level of higher octaves, and also brought to harmony with the general changes the Design of the organized being – THE HUMANITY**, and many other drastic changes, including flora, fauna, water, etc. Exactly this way there will be recreated **THE TRUE CLUSTER** of the complete state of the Earth civilization development control which it had possessed at the exit from "Orion" group of civilizations. And only then there will be possible and allowed "From the

Above" the real transition to another subsequent level of the civilization development of our Planet.

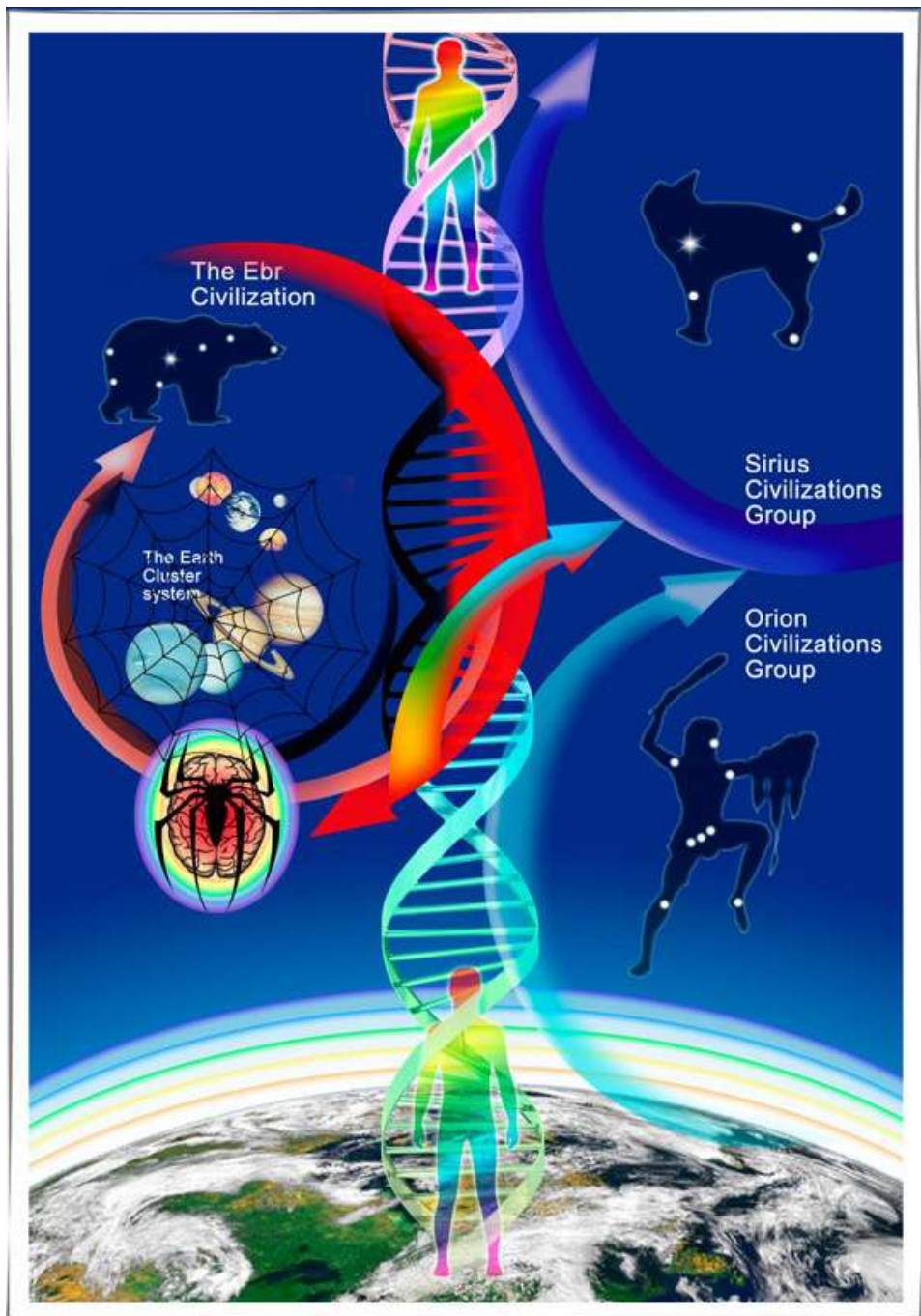

The Planetary cluster

This rigorous model Design of **a SINGLE PLANET**, is represented by a complex of energy gratings of the entire range of energies in their material and non-material relatively stable conditions. Such a Design is shaped to give a harmonious guided being, and to provide the necessary programmed indispensability in the process of the embodiment of the current stage of civilization development. A model cluster design must have a System Complex of the autonomous control, which **would be capable of:**

- ensuring the implementation of the Planet's functional endowment at every stage of its civilization development;
- organizing, governing and controlling the harmonious existence of all the imposed range of the octaves energies at every stage; directing the entire process of its development within the framework of the inserted Vector of target, phenomena, actions and events, as well as adhering to the time beat in its own and general chronicle of events of the system clusters of a higher order.

Planetary clusters having (endowed with) living conditions, additionally have Systems to control the most complex process of the composite conditions of the life support, rigorously monitoring and ensuring the harmony of being of all the imposed diversity of living individuals (entities) and distinguished forms of tangible and intangible coexistence. For all that, all sorts of state of hegemonic parasitism of one over the others or quantitative beyond the programmed (uncontrolled) prevalence exceeding the level of the programmed mutual sufficiency, are corrected through the Control Systems and eliminated to the level of necessary sufficiency.

Planetary clusters, with further vesting in the development of civilization of Intelligible orientation, have in their control System: control Complexes, objects, Systems energy information translation and communication, which all together ensure the formation and retention in the stable state the **ENERGIES** of **CONTROL** – the **MIND**. The Mind as the highest constructive state of the specific control energies takes the form of a very specific "energies-substance", which, in turn, has the property to develop up to those controlled limits, which were according to the **PROGRAM SET IN ADVANCE** to the Planet while imposing it with a specific function.

On achieving complete harmony of all the states of energies, within the imposed octaves and gaining a level of the Mind development, reaching the

designated limits, and ***keeping the Mind substance in a stable condition***, the Planet is transferred to the next stage of its civilization programmed development. **For all that a new, higher level of energy octaves in their immaterial and material states are imposed.**

The cluster of social development

Many representatives of social sciences correlating their world outlook only with dialectical materialism present the process of social development as self- initiated manifestation of the society's civilizational development, subordinate to certain ("invented" their own classics) mandatory laws. They also present with confidence the fact of **RANDOM ASSEMBLENESS** of the **SOCIETY**, according to the will and desire of the parties, as a "natural substance" and only to "meet the requirements caused by nature" in the process of the forced joint cohabitation. ***In order to justify the very existence of such a forced "natural substance", and in addition being embodied in the regularities dictated by them, concealing the true reasons of the imposed violence and the entire social restrictions of the overwhelming majority by the insignificant minority, they put forward a number of "indestructible theories", which were positioned on their side as "perfect" and with certainty in time, for not less than "all future ages," i.e., forever.*** The truth is that all the fabrications of a sort of "political wise men" **SUDDENLY COLLAPSED**. They are no longer able to fabricate other theories, and as for the future- they are not even able to formulate it. Is it loss of vision in an uncertain "bright future" or clouding "of the mind and the eyes"? The Control of such a complex programmed process is performed with the help of the forming Cluster of social development. But it should be preventively declared that the indicated Cluster **HAS NOT TO BE CONFUSED** with the state apparatus and all its instruments of violence, as they have been mixed up into a single concept by the current and previous social scientists. What does it represent, what are its main functions?

Eventually, the Cluster of social development, in contrast to the claims of social scientists of the past, is a COLLEGIATE STRUCTURE of the systems control from the outside on the part of the Control Complexes and their servers. Its main goal is the ***formation of the current state of social consciousness*** and continuous monitoring of the level of its states by imposing energy-information translation for the formation of future specific executive

people's actions and preparing the programmed set of events with their participation.

The cluster of social development "formed and stipulated" the **ENTIRE SET** of executive states in the midst of the people's society **through their social consciousness** and was the shaper of the society's "perceived" thoughts to further control of them by the Cluster of the state control. As you can see, it's not the same thing. Moreover, their functions are completely differentiated, but mutually harmonious by their controlled embodiment.

The Cluster of state control.

It, at this historical moment, is of the greatest interest, as it is that very **Structure of the controlled organized people's being**. The Control is still carried out unattended, as external (i.e., from outside, by the interventional Control System in the past) as well as the internal control through the organized "instruments of state violence."

The structure of the Cluster of state control under the old Control System was based primarily on:

- the programmed current target Vector of future phenomena, actions and events corresponding to the time of events of the chronicle process;
- the imposed targets of every stage of the executive actions of people to implement **TWO STRATEGIC PROGRAMS** (**the Development of the Brain genotypes and the Development of Energybiogenesis of the flesh cell**);
- strictly expressed Structure of the imposed (on the side of the Control System) hierarchy of the social control of the public development according to the degree of relative "controllability and importance" of all individuals, with regard to the **SPECIFICALLY** expressed genotype of each Brain as a common (state) model of the executive actions of people illusively **IMAGINING** as a society for "cohabitation" in it to meet the emerging social, spiritual and other everyday needs and other things less important.

The control of every sphere of being, as separately expressed elements of much lower order in the overall Structure of the of people's being, was also **EXPRESSED BY QUITE SPECIFIC SUBJECT FUNCTIONAL CLUSTERS**.

Returning to the consideration of the Planetary cluster, I would like to emphasize that the harmonious being of all the range of the imposed

energies octaves at each stage of the civilization development of the Planet must **STRICTLY CORRESPOND** to the beat time in their own and general event of the chronicle process of the systems clusters of much higher order. In the process of the interventional interference Ebr System **HAS CHANGED** the **BEAT** time, and imposed its standard of charge fluctuations on the sides of energy gratings, equal to standard =1,0007 sec. in relation to which there was imposed time model 60x60x24 with all relevant time-bindings, including the Earth's rotation around its axis. This standard beat of fluctuations, as if the **IMPOSED TIME**, was provided and assigned by the charges fluctuations along the sides of the **energy gratings of Cs 137 (lat. Caesium)**.

And now is the MAIN thing that can be said TODAY:

- **In 2012.12.24 at 0115hrs** the control and fluctuations beat (1,0007 sec.) of the old Control System is **TURNED OFF** (the Stonehenge Complex);

- **In 2012.12.25 at 01.15** The **NEW CONTROL** and support of the fluctuations beat (1,008 sec.) is **TURVED ON** which is the **TRUE** and **RECREATED TIME** of the Earth in its first stage of civilization development. Turning on was carried out by the recovering **ALTAY Control Complex**.

This process corresponded to a particular relative position of the objects of all "parade of Planets". Exactly at this moment on all the Planets of the "parade of Planets" **there was restoration of their true standards of beat time**. Exactly for this reason, the "Mayan Calendar" terminated with respect to such Universal event.

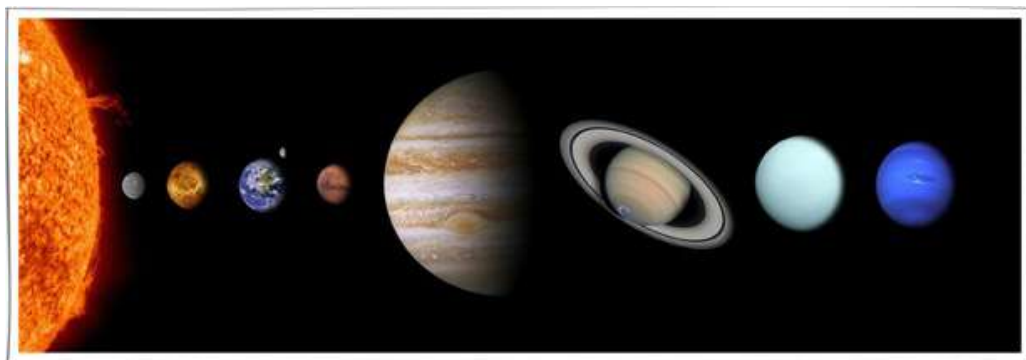

Exactly because of this there **WILL NOT BE** any Apocalypse!

With this landmark event there began an active phase of many processes for the **RECREATION OF ALL OCTAVES** of the energies on all

the Planets ("parade of Planets") in their true state. Here I would like to add only one thing – exactly because of this it was carried out the reprogramming the **Generator** of "Dark matter" (in the terminology of **N. Levashov**) through the newly created **Program "SvetL"** in relation to the new standard of beat time. And this **FUNDAMENTALLY CHANGED** the purpose of the Generator, making primary the Brain development with reference of this process to the System of control and life support and on this background – health improvement of **the Programs "SvetL"** users.

3.4. About the creation of the "Shirt", failure of Intruders and of the collateral...

The animal world, the insects were created to control the Man frequencies.

In the atmosphere structure ($-4400 < h < 12400$ m) there is oxygen, hydrogen, industrial emissions, and **OTHER FORMATIONS**. ***There are also biological structures both in material (inertial mass) and immaterial (non-inertial mass) states.*** Biological structures in the material state are described by "scientists" in detail– they are divided into classes, groups, genotypes. They all have distinctive features, which make it possible to determine their ancestry. There are some signs In humans, too, – whether they are relevant to the class of apes, or created by the aliens. As a rule the interference of the aliens is being denied.

Intangible (immaterial) biostructures were represented with two types.

The first type is represented with all types of visual delusion, ghosts, hobgoblins, and others which the civilized world has been faced with at every step.

The second type are humanoids from small insects to humans. In the state of a humanoid one IS **ABLE TO BE** for thousands of years until conditions are created for materialization. All humanoids, as a rule, were subjected to reincarnation.

An example: If you "slapped" a mosquito, it does not mean that you have destroyed it. You altered the material structure of a mosquito but it also has a structure in 77 octave, in ininertial (immaterial) state, and its new materialization can happen in a day. Modern science is only guesses about

it. **MATERIALIZATION** of **USEFUL** for the Mankind, insects: locust, bedbugs, lice, spiders and others, was performed by the Invaders Control System only in the event of an additional control over the frequencies of these insects.



The inconveniences for the invaders began after they had decided to use the Shirts that remained after the **INVASION** and **ANNIHILATION** of everything and everyone. **Firstly**, it was impossible to reproduce in Shirts, as high frequency octaves were destroyed (or rather, reduced to 2-3%).

Then urgently they had to introduce "support", but there arose a problem with the "reproduction" organ. **And immediately a "national custom" was introduced – to cut off the excess.** Then it was noticed that in the course of the control, not all can be verified. It became necessary to burn sulfur, which was subsequently replaced by candles. There was also a number of trivial inconveniences, which were later transferred to religious cults. But still, to **CONTROL** the **FREQUENCIES** of octaves **65, 67, 71** mosquitoes, bedbugs, fleas and other useful insects were developed.



If the frequencies that were considered unnecessary were removed from the Noosphere, then the systems of biosensors were removed as well. And to monitor the new state there were created new biosensors, either in the existing ones new functions were added. I want to note that the term "web" **REFERED** specifically to the **CONCEPT** of "a spider", **and it was one of the 18 structures of the Control Systems**. The Brain was created for the web, and it (the brain) could "pick off" and process the information that was necessary to the Control System of exactly this structure.

All biological structures, including Man, were designed in such a way that had a whole set of octaves **from 16 to 128**. They are different in purpose, and the dominance of a particular group of octaves formed the basis of a biological structures.

Functional division into octaves:

- **16-32** = all kinds of gases and water (breathing and water are necessary for all);
- **34-46** = structure of reincarnation (all structures sought to the potentials of frequencies of these octaves);
- **48** = distributor;
- **50-52** = energy balance;
- **56-62** = organs control;
- **64** = material structures;
- **66-72** = brain;
- **74-86** = reincarnation control;
- **96-126** = control;
- **128** = defining beat generator

The Program "SvetL" until recently "worked" in the range of **66-72** octaves (for interoperability with the Brain of the owner). Today, the range of octaves of **"SvetL" Programs** is expanded to **128**, which makes it possible to "interact" with the defining beat Generator. It is extremely important in the processes of changing the Human life support System. We can say that the first step has been made in the implementation of **life prolongation up to 124 years**. But this does not mean that being a member of the **Programs "SvetL"** you automatically become a "long-liver". **TO THE BATH** you will have to **GO**. And, as **N. Levashov** used to say, – It is quite "another hiZtory..." I got this understanding a year later, after **Nickolay's** "passing away". Before the **INTRODUCTION** of the **CHANGES** to the **Programs** it had been necessary to periodically make

recommendations on the Complexes "reset" so that the Programs "reacted" and "adapted" to the changes occurring in the life-support System. Now this problem is solved. And it is solved thanks to the knowledge obtained through studying those works by **A. Khatybov**, which even today are **NOT PUBLIC**.

All kinds of plants, herbs are of **34-44 octaves frequency**, so the cows eat (as I have mentioned), only grass, knowing that they will be used as meat. Apparently, therefore, in India – the birthplace of the reincarnation theory, – cows **ARE SACRED ANIMALS**.

For dogs it is important to know that reincarnation exists for them (frequency range of octaves – 78-80, combined with the frequencies of octave 64, but these are bones). The dispersion of the higher octaves is fairly slow, and if a person dies with the potentials of bone frequencies above 122%, then even after 1000 years those bones can be applied to the sore spot. It's about the phenomenon of "Holy relics".

Earlier I wrote that all metabolic processes are **CONTROLLED** by the **BRAIN**, but the distributor of "the goods" for the cells of the body **IS** the **HEART**.

All believe that mental activity is the Brain's function. Earlier I wrote that all metabolic processes are **CONTROLLED** by the **BRAIN**, but the distributor of "the goods" for the cells of the body **IS** the **HEART**.

However, even in the Yeltsin time (I then worked in the North-West region), on all the posters it was written: "**Think with your heart!**" And if you look a little deeper with humor and irony of A. Khatybov, then before getting the Brain the thought center was the Heart, and before that – **TWO HEMISPHERES** below the spine. Having three centers for the reproduction of thoughts, there is a possibility to have vacations so that it would be imperceptible what structure is running the body today. Of course, the main Brain has a maximum size. The thought process is, naturally, divided. Incidentally, all three intellectual structures roughly have similar design – they are divided into left and right halves. The brain is conservative and unresponsive to external changes. The heart and especially the lower brain, are keenly interested in all the changes, and their form depends on the advertisements in the media. There is such a concept as "bull's heart", it is the pleasure of beer consumption.

The Brain (cerebrum) – has a lot of convolutions, works only for itself – where to steal and whom to cheat. The Heart has no convolutions,

but makes principal decisions and **DOES NOT REMEMBER ANYTHING**. The lower Brain is equipped with a single convolution, makes all foreign (state) decisions. It is especially evident today. The amount of pleasure for the lower Brain is enormous, because it is the leader in all new beginnings.

Of course, paying for the consequences of the Brain's work and, especially, the intellectual conclusions of the Heart, has always to be done by the lower Brain. It is administered various pharmaceutical preparations (injections), rods, whips, hunting rifles are developed for it. If there is a necessity to correct the thought, salt is used to increase the pH (negative logarithm of the hydrogen ions concentration in solution). A charge of salt has a beneficial effect on the correction of the decisions made.

If we make a trepanation of a cockroach's head portion of the body (instead of the Brain, according to our traditional concepts and approaches), we will not be able to detect the Brain; instead, we will find something that **HAS NOTHIG TO DO** with our concepts of the Brain. We discover one hair

in each "half" of the skull with "poppy" seed upon their tip. We naturally come to the conclusion that the cockroach has no Brain and this will be our "mistake" since the Brain of the cockroach is **mostly in immaterial**

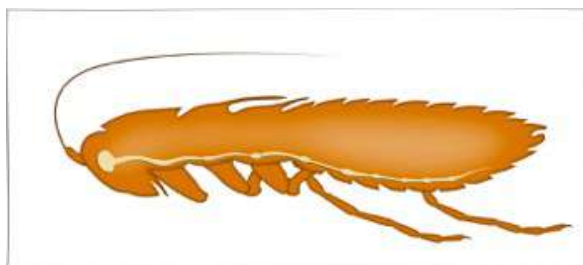

(non-inertial) state and its Brain is quite enough for the execution of its functional vesting, granted to it by the earlier interventional System as an appendix element of the System of biological control! But its Brain is not that simple, moreover, it was able to perform quite complex operations to **GATHER INFORMATION** of the biological environment state according to the parameters that were required by the Program "**Development of Energybiogenesis of the flesh cell**", i.e. people! Thus, the Brain of a cockroach, as the **MINICLUSTER SYSTEM**, professionally controlled all Executive actions of this **IMPORTED ENTITY**, played an important and specific minor role in the biocontrol System. Here it is such a monster, that cockroach.

So what is the Brain? The brain is a cluster system formation of the energies that are in inertial and non- inertial states created for specific operations of control, monitoring

analysis and having the property of improving in certain permitted limits, under the control of a higher level of formation.

As for the Brain of the Control System as a very specific cluster of the control systemic formation in the most complex structural embodiment, people's perception of it, its constructive arranging, functions, technical and technological capabilities, and much more – are **IMPOSSIBLE** within the framework of traditional ideas of the Brain, especially when making restricted attempts to compare it with one's likeness as a perfection of nature! By the way, specially distinctive (not for merit) signs of the human Brain as sight, speech, hearing, smell, and other gained "perfection" (obviously, not without the help of Darwin and his kin) are also available in the Brain of the Control System, but are in incomparably high and perfect condition.

The earth as an artificial structure has been created for about 7 billion years. At present, there is the following in operation on the Earth:

1	The Control System (CS)
2	7 Secondary control systems (SCS) – servers having more than a 1000 pyramids (each), hundreds of terminals
3	Objects (more than 3500) for the control and reconstructions
4	2 colliders (under the North and South Polar circles), define the beat = 1,0007 seconds
5	8640000 meridians
6	7 cords to read the information
7	More than 1 billion biosensors
8	Beat time Control System
9	Control System of the Earth surface
10	Near Space Control System

It all works as a unified system in which Man lives. But today the **PROCESSES** are **UNDER WAY** that affect and have a significant influence on virtually everything listed in the table.

Many people know that Man has "Chinese points" (Pfall points) – they are the points to control and influence Human organs by homeopathic effects with needles, shock, etc. It is considered that if to stick needles (gold, silver, platinum) in the "Chinese points" then some good individuals (spirits) will run at full speed and locate themselves in the right places, and the evil ones will run away.



But it is accepted to believe so that **NO ONE WOULD THINK** another way. Each of the SCS (Secondary Control System) forms its control cord, and it takes the control cord 2 hours and 10 minutes to make a complete control of the environment, making a full turn around the Earth. The information collected allows the SCS units within a few hours to make a **CORRECTION** of the **ENVIRONMENT** from -2200 m to +12400 m, creating the ideal conditions for Human existence and for those who he is going to eat! However, to pick up the information from one man within one examination, in principle, is impossible. So, SCS Kailas for the Brain control withdraws **PART** of **the BRAIN** for a long period and makes a comparative analysis with the given program. This time a Man is asleep. While being controlled a man is watching a "new video", taking it for a dream. The rest of the SCS could not afford to have unlimited time to collect and analyze the information, therefore it was created a unique method. Each frequency available in a Man, was copied to the extraneous biostructure, and with the passage of the cord this biostructure in resonance mode responded to the request. Thus, billions of biostructures gave (each one) in the resonance mode the information on the state of man's health in the control environment. It's hard to compare it with the current level of our knowledge, but it was exactly so. There were no **ACCIDENTAL BIOSTRUCTURES** on the Earth. Each of them was supported basing on the program requirements. Raising the level of the Human Brain required the **REMOVAL** of **OLD** bio-structures and **CREATION** of **NEW ONES** that, in fact, is observed nowadays. There is an example of it; some time ago, the US was subjected to mosquitoes attack. The scientists reported that the drug was produced after eating of which mosquito's stomach was destroyed, and the mosquito died in painful convulsions.

Having asked some known Russian biologists about the structure of the mosquito, it was found out that a mosquito as a highly developed being has **NOT ONLY** a stomach but all that is necessary for normal processing any food (approximately, as in the case when the single-cellular nibbles the multicellular, having protection from them). The information on the success of U.S. scientists was broadcast by all the media and no one but A. Khatybov (for some reason), had any questions. **The first thing** that Alexander Mikhailovich paid attention to was –what was the mosquito eating?

In the dead blood erythrocytes, as the sedimentary structures have a diameter of 7-9 microns, and living blood – much less due to the difference in octaves, although medicine still thinks the erythrocyte stretches in the likeness of the sausage and squeezes through the narrow capillary, with the moral support of the heart contraction. The mosquito does not need either the blood plasma or other structures. What did he eat? The mosquito is only interested in the erythrocyte **WITHOUT the MEMBRANE** and without the address "lable", i.e. an erythrocyte in the **STATE of PLASMA** (like the oil spill in the sea). In medicine it is "sugar" in the blood, or diabetes. Such an erythrocyte **HAS NO** connection with the control structures and has to be immediately removed from the blood system. This erythrocyte has 12 form frequencies (does not fall apart to atoms). The plasma state of the erythrocyte is a **SERIOUS VIOLATION** in the functioning of the kidneys, liver, pancreas, but to control them **AT THE SAME TIME** is **IMPOSSIBLE**, and therefore the structure of a mosquito was created, that recognized only a group of **12 frequencies** and reported their availability.

With the cord moving the information on the presence of the plasma state of the erythrocyte was recorded and later analyzed for decision-making. If the information wasn't enough, the mosquito population was increased. The mosquito can be compared with the "Junkers-87" – when approaching the target the siren is turned on. The mosquito's siren was turned on automatically, and the farther from the body it turned on, the more erythrocytes were in the plasma state in humans. Blood has plasma and **pH=6,88-7,45**. Если **pH>7,45**, then compact sensors were created – **mites and bedbugs (for pH<6,88)**, which had only 4 resonance frequencies (without a siren). In any case, they first tasted the plasma, and if it didn't fit the norm they left the information for the cord. Also, as with mosquitoes, if the information was not enough, the population of bed bugs or mites was dramatically increased.



To generate **genotype 46** there were no special problems with red blood cells and blood plasma. The main problem was the support for the erythrocytes production. It was necessary to create a deficit of erythrocyte by their seizure. For this purpose leeches were used. Russia, before 1917, had exported **60 million leeches a year**. Only in St. Petersburg 8-12 thousand peasants worked in this field. The exports went to Europe.

Nowadays, the erythrocytes in the plasma state are poison for leeches, that is why A. Khatybov, as always, in his favorite manner advised treating with bedbugs first, then mosquito (must be sterile and seamed in a jar) and only after the elimination of plasma erythrocytes leeches can be allowed. Of course, the civilized mankind was obliged to keep in the home first-aid kit (you may in the car, too) a minimal set of the above and use them only for their intended purpose.

Thus, it was possible to point to the value as a means of control and medical first aid of the corresponding biostructures, but this was beyond just opinion and required instrument provision for fixing resonance frequencies of each of the biological structures.

3.5. The concept of unscientific perception and Reincarnation

Everything that is associated with the "scientific" understanding of "travelling souls" (Entities) and reincarnation has always evoked great interest. I just specify, that reincarnation that existed under the interventional Control System, is no more some sort of violent imposing in the World of the guiding character (from the System). In **2017.01.07** there was exactly four administrative years since one of the Programmed processes of the recreated Control of the people's being on the Earth associated with true state of any subsequent incarnation of the "Spiritual Entity" through the Phenomenon of The Investment that was Shown, but not through reincarnation.

Phantoms and doubles, complete loss of memory, **SUDDENLY OPENED** new knowledge about the events, in which one had not

participated before, the recollections of the past life and knowledge of foreign languages since the cradle – all this is only a minor part that has been drawing the attention of all kinds of scams, especially from the so-called "science". These and similar cases recorded by witnesses, captured on photos and videos, including legally proved, are ***a means of existence for all those who "has been feathering their nest" on ignorance.***

The Academy of Sciences **HAS NOT INTERVENED** in "miraculous" transformations, and it was only on hand to all healers, witches, black magic and white magic and other crooks. ***But today, the frequencies at which they removed the information are disbanded. And it no longer works.***

No	Name	Foundation – Horse knowledge	Non-scientific point of view
1	Atmosphere	The mixture of gases formed by chance	Strictly organized structure of gratings series
2	The Earth	Formed from dust	Exists thanks to the Control System (CS), located at a certain depth
3	Fields	The number of names is unlimited – from the farm to the astral	There are 3 Fields as physical structures, conditionally can be called as electric, magnetic, gravitational; different in frequencies and properties of the charge (octave of the charge 4-512 in Di-structures and 16-128 k-structures)
4	Matter	The whole world, both on the Earth and in Space, is composed of Bohr's atoms	If octave of the charge is less than 66, a rigid structure of the proton atom is formed (matter).
5	Spirit	The spirit, usually the Holy one, exists separately from the matter	If octave of the charge is more than 64 (up to 512), non-inertial mass, quantized on the purpose and properties is formed.
6	The Moon	A piece of the meteorite, captured by the Earth	The external Life Support System of the Earth, the programs generator for the biosphere.
7	Man	Descended from apes	Change of the sperm octave in an appropriate environment forms a human (APE – humanoid of a man).
8	The Brain	Everything that is under the skull	Man is provided with a part of operative brain and a minor part of the long-term memory

Here are some A.Khatybov's terms and explanations who always proceeded from the fact that the "basic constant in modern science is the

horsepower, so all that are known today to modern science is horse knowledge.

Terms and explanations

Insignificant differences between the two points view

	Official science	Non-scientific point of view
1	The solar System was formed after the explosion, there is Hubble sphere	The solar System is artificial, the Space has never exploded, there is no Hubble sphere.
2	A living cell turned out randomly from dust unsuitable for the formation of the Earth's surface	The living cell is the highest achievement of the Cosmic mind, combines the interaction of the octaves from 12 to 4096
3	The remained gas is randomly formed the atmosphere	The atmosphere is layered structures of gratings (*)
4	There is no difference between a mouse brain (which is used for testing medical drugs consumed by man) and a human brain	The human brain is incompatible with the brain of any humanoid.
5	UFO – random appearance of aliens, everyone interested is engaged in their study. Soon their secret will be revealed, and their weapons will become property of the Earth	All the UFOs on the Earth are of terrestrial origin, they are the equipment to monitor the state of the environment (type of zonde); the moon has its own UFOs.
6	The evolution of matter - solid→liquid→gas→plasma (unorganized)	Non-inertial mass (highly organized plasma, arranged in octaves) →inertial mass (gas, liquid, solid)

On July 6, 2003, the formation of the general memory grating was completed. The grating structure are the united dodecahedrons, each of the dodecahedron is a refinement of the icosahedron (the edges of figures and connecting pyramids are the same). If you want to get at the meaning of all this, the sizes and methods of connection are given in the works by A. Khatybov.

Nowadays the processes are under way about which **N. Levashov, and A. Khatybov** wrote in their time – the systems of "horse knowledge" are being removed together with their bearers. The General memory grating will contain only the information **THAT** is **NECESSARY** for the life support of biostructures. Moreover, a powerful grating of control structures has been created. Not stipulated actions of biostructures (read -people) will be destroyed together with their bearers (e.g., turns of rivers, the creation of atomic weapons without knowledge of the physics of the process).

Nowadays there still prevails the "scientific viewpoint", but more and more the concept of non-scientific perception is breaking through the reality which bears the following:

- The Earth is controlled by the Control System, located under the Earth's surface;
- the Control System is a complex hierarchical system;
- on the Earth there are more than 2000 control systems;
- the basic Brain of each individual is stored in the archives of the Control System;
- at each beat period the Brain control of the individual is made with the information recording;
- the Control system uses 7 types of time, one of which (60*60*24) is the beat of the lower grating;
- to transfer the information the Control System uses the music order and the **RESONANCE CONTOURS** of the **SPINE** are the receivers of information;
- to control the Brain the Control System uses a different musical order;
- the order to control the Brain: **DO RE MI FA SOL LA SI NA, LALALA** code – call letters, still existing for a particular genotype of the Brain;
- the appearance – is the shirt, and the Brain transfer is made to the shirt that in the frequency balance is compatible with a portable Brain;
- when transferring the Brain the information in the archive can be fully or partially saved, that is why the individual is able to do things that previously were impossible;
- the substituted Brain can be saved, but typically it is scattered, for all that the ion structure (and DNA, too) are remained the old ones (the sedimentary structures of the old Brain). The new Brain does not form DNA.

When replacing the Brain the Control System assumes that the **NEW BRAIN** in the archive is better than the substituted, but this is not always the case – lately the reverse process is observed. The old Brain cannot be substituted, if some control points are missing, or cannot be replaced (incompatibility of genotype, diseases such as AIDS or tuberculosis, a narrow range of lungs memory, the level exceeding the radioactive frequencies potentials etc.).

The primary task that I hope to realize in the near future, is everything that has to do with the "**PRESERVATION**" of "**INFORMATION**" (almost

a full copy of the Brain or Entity) of the Person who had used **the Programs "SvetL"** and died. Of course, the Generator with all the programs and information – might be just "scattered", but I consider it **UNREASONABLE**. How to change (replace or "remove") the Generator from the bearer (the complex) has been decided and tested. Under consideration is the question of **"SAVING"** the Generator with all that is **"STORED"** in it for the future use by the Brain (Entity) under repeated embodiment (if, of course, it happens). This will significantly reduce the time of "achieving" the lost potential. I **CANNOT** tell you everything now for reasons known to you and associated with the ongoing transformations. But I hope that soon that will be possible. And while I "close" it with points, as N. Levashov used to do.



An important aspect is the method for converting and resizing the structure. Again I refer to the example with an erythrocyte. It is known that the erythrocyte has a diameter of **7-9 microns**, but more than 90% of blood vessels in humans have a diameter of **about 1 micron**. The question that makes many come to a dead end, – In what way does the erythrocyte find room there? The answer: There is no erythrocyte in the blood, it is formed **OUTSIDE** the Control **SYSTEM** (or the Brain) as a sedimentary structure with the loss of the octave of its condition (decreasing the octave 2 times the total size increases 1,284 times).

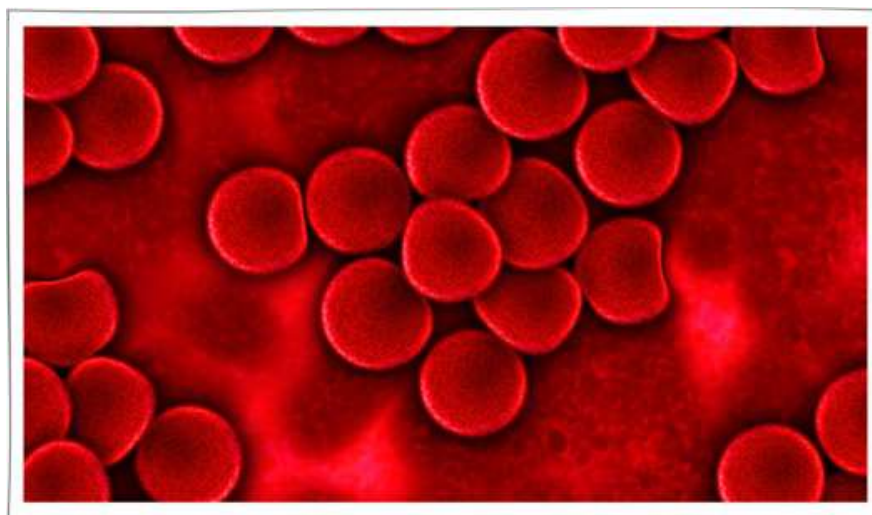

Similarly is the birth of a child. The spermatozoid has an ionic structure and the Brain **in octave 96** (smaller than the atom size). Once in

the "sandbox", that is, in the structure with **MAXIMUM** dispersion, spermatozoid grows rapidly (losing octaves of the Brain). When reaching the equilibrium (octave 71,225625) the signal is developed and the **DELIVERY COMES**. This implies an important conclusion – **the NEW BRAIN** is in a higher octave, and the functions of the old Brain might be **AFFECTED** only **PARTIALLY**.

Earlier I mentioned that the existence of **non-inertial mass** modern science does not even has doubts about. In octaves **over 64 there are 8 different atomic structures** (they are given conventional names – neutron and antineutron, neutrino and antineutrino, etc.). Each of these structures has a range of existence (charge). The loss of charge increases the potential of the lower octave.

An example: when transferring power octave of 65.5 in 32,125225 we get a powerful discharge of lightning (comparable with the power generated by a hydroelectric station for hundreds of years), although the initial state is impossible to see.

Taking into account (excluding the official science) the presence of various "divine" phenomena, as well as advertised astral, mental and other fields (recently a fashionable field is torsion), I want to draw your attention to the growing number of perpetual motion engines, or, at least, the desire to create them. More than 99% of such works are obvious nonsense, even from the official science point of view; but, if in some cases in technical solution the **NON-INERTIAL MASS IS PRESENT** the problem cannot be solved with conventional means and devices, the more so, that the Bohr atom does not change the size and Mendeleev periodic table does not contain non-inertial mass.

Is the existence of perpetual motion possible? If you take the period of time of 100 years, it is possible, by dissipating the high octaves the ion mass can obtain "recharge from nowhere", but only in case of the presence or merging inertial and non-inertial mass. **An example of such a perpetual motion engine is a Man, whose Brain is in the non-inertial structure.**

What will happen if someone takes into his head to visit Pluto in a modern spacecraft? While moving there will be **DISPERSION** of the **HIGHER OCTAVES** (and that is the Brain), so when passing Mars we will have the Brain of Pithecanthropus, and **AT THE DESTINATION** – a **PILE** of **SAND**. All the objects that move in Space, have **gravito-magneto-**

electric Generator that supports the existence of migrating matrices at all frequencies. **Such Generators were, as N. Levashov described, at Vaitmars and Vaitmans** (some for interplanetary flights, others for use in the planetary conditions). This allowed the Human to **MOVE** in **SPACE**.

So, where do crooks and interpreters from science come from and what do they use? Firstly, – out of the walls of science itself; secondly, – because of misunderstanding and inability to perceive the information that **N. Levashov, A. Khatybov** and others left for us. The use of "Horse knowledge" **MAKES IT IMPOSSIBLE** to get to know the meaning of physical phenomena. All existing instrumentation is founded on the properties of Human eyes (phase, angle of the charge sliding, the top octave and the like can not be higher). The lack of instrument base **DOES NOT ALLOW** the official science to accept or reject the new physical properties of the material world (we will not touch on the "Divine world" because it's a different hisTory).

Lack of knowledge about the world around and the ways of its existence leads to a closing around that pyramid of knowledge, that had been built for more than 500 years. In fact, the presence of such science nowadays has led to the existence in Russia of more than 180 Academies, each of which uses the same level of knowledge that has nothing to do with science. Is the situation going to be changed? Yes, it is. Upon completion the Main Program the Control System **WILL** just **ERASE ALL the JUNK** and provide the information that will Make it impossible for the King of nature **to interfere** with the Control System, including the formation of the new atmosphere gratings.

But let us go back to the problem of reincarnation to finally put the full stop on it. There is such a notion as "karma" in shamanic circles. It is supposed to be recording all the deeds and promising "creative" success. There is a lot written about karma, but we have something to add. **Karma** is the feature of the neutrino coat of the Bran to preserve all the properties when changing octaves from **73,450450 to 61,375375** at a carrier octave **of 49,5** (bone structure). It takes approximately **1200-2400 years**, therefore, when replacing the Brain neutrino structure of the Brain is controlled **FIRST OF ALL**. If this period is divided by the average lifespan, you will get a number (amount) of incarnations (reincarnations), which would have to be implemented to achieve these octaves of the Brain. **Before the attack, the seizure of the Eath and annihilation of people this had not been required considering that the length of biological**

life exceeded the given values. In case of disappearance of the carrier frequency within a fraction of a second karma disappears as well, and there remains a small pile of wet sand of a man. At present it has been applied for the publicity and understanding that the similar things are possible as "Technology" with those who were planning to shoot down Boeing over Sinai.

Currently, whether we **LIKE** it or **NOT**, the world is divided into **2 camps – the yogi and the goyi** (the yogi are the control, or those individuals, whose karma was supported by the old Control System of the Earth, **they make 12%**; GOYI are the working material for the experiments). The correctness of the reincarnation experiments was checked on goyi, on yogi the experiments were made.

However, there are exceptions. These exceptions are fairly well documented in history. This applies to the Jews. There is no such a nation. **N. Morozov** described it in the monograph "**Christ**". There were tribes of Jews. The history is founded on fairy tales, and all "the antiques" were



written in the Middle ages, with the beginning of the 500-year program. According to **N. Morozov**, the word "Jew" means **EBR (a migrant)**. That is, the one whose **BRAIN WAS REPLACED**. It was assumed and was presented as if they "were moved", or "expelled from Egypt". The first experiments on changing the structures of the Brain were made exactly in Asia Minor. When transferring a new Brain the old one is eliminated, but the new one **CAN NOT** pass the test and cannot be put in. In this case, the control over the actions of the Brain is disturbed, and such a Brain **HAS TO BE DESTROYED**. This extends to the current processes. What is typical that such a phenomenon is being widely spread. In the old Control System the name "Jyd" – Jew (or yog) was **introduced** for them. **Jew (or yog) without a Brain**. It has already nothing to do with the Jews. The slogan "beat the Jews and save Russia" refers specifically to this phenomenon. To create a public attitude there were organized "black hundreds" of the ground – attackers, the "Memory" society, and so on.

For "Jews" the old System established a temporary support (the total lifespan of 54 years) and made of them regular biorobots with the specified functions. If within the period of 1933-1945. the total number of biorobots

was **6600000** (almost all were annihilated), at the present time they make more than **33% of the population**, and therefore there was a danger of a new (nuclear) war. At the end of karma robots jump out of the windows, perpetrate accidents, take up arms, etc. Such individuals are **ESPECIALLY DANGEROUS** in the army. Modern science does not have ways and means of detecting and neutralizing robots. The first report of the emergence of robots in Russia was **in 1472 ("The arrival of the first Judaizers in Russia")**, that is, at the beginning of introduction of new Brain, and it did not suit everyone. If karma was normal, the control system at **100% supported the possibility of reincarnation**, and it was performed once in 12 years for all yogi (or, in exceptional cases, on merging of a few beat periods and availability of replacement, an example is Anastasia). I am sure that the new Control System will "find" another (except the war) way to remove robots and the reasons for their formation.

3.6. Sleep as karma control

Sleep and dreams, interpretations, and dream guiding books are the basis of almost all of the practitioners of shamanism. It is known that there are lots of types of dreams: they are color dreams, sleep with no dreams and instant dreams (you sleep a few minutes, sleep well and had a dream that lasted a few hours). While sleeping a man can travel, do very specific things, be in places that are inaccessible, etc. First the idea of sleep as a means of control **was expressed by Freud**.

On the Earth there is nothing accidental. As I have mentioned all living beings are biosensors, and if the frequency balance is changed (in line with the Program) then unnecessary biosensors disappear and new ones come out. For all that, you should keep it in mind that according to the Program the frequency balance **IS ONLY GROWING** (the octave is getting higher), so gradually biosensors of a large size disappear and smaller ones appear. ***Especially carefully the Control System monitors the Man.*** **MUTATIONS ARE NOT PERMISSIBLE**, and once in the beat period a short-term withdrawal of the part of the Brain (according to the schedule) is made for control purposes. In this case, the taken part of the Brain is tested, and according to the test results a correction is applied, and then the removed part of the Brain is returned. If the correction is insufficient for the whole of the Brain the carrier frequency is removed or karma is reduced.

On the Earth there are 12 related Control Systems, and 21 Control Systems. For example: the control System for England is located in Greenland. The removal of part of the Brain was carried out according to commands from the Moon.

The drawing symbolically shows the memory library. Testing is performed at high octaves. There is different time over there (144 times reduced), but if that is **NOT ENOUGH** to make the complete test, the test stops suddenly, and the part of the Brain (partial) is taken back. During the next testing this part of the brain is placed a step below. Targeted communication makes it possible to return accurately the Brain back where it was removed from for the testing, but if by this time there had been some changes in the atmosphere, the address might have been changed, for example, a woman's Brain is returned to the man and vice versa. Hence, the growth in the number of gays and lesbians. Nowadays this happens very often. **THE TEST** is a kind of **FILM**, every sequence of which checks each cell of the Brain matrix. The signs of checking are partially preserved.

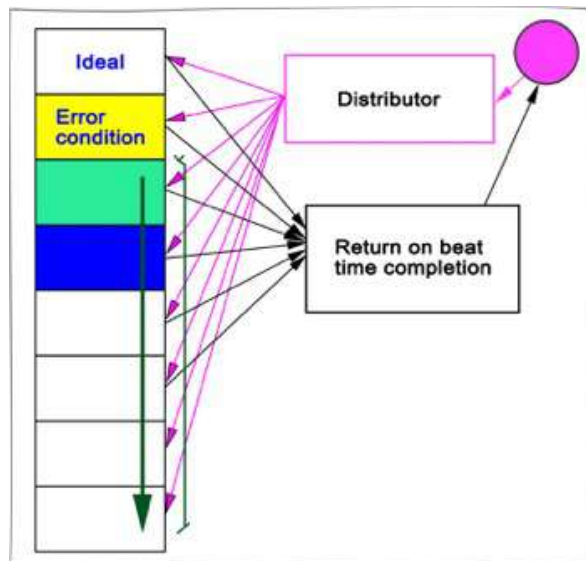

Yes, the sleep can prompt a disease or general condition of a Man. The interpretation of dreams has nothing to do with this process. Sleep is necessary, indeed, but not as a story fragment, but as a state, because exactly at this moment there takes place correction in many, and sometimes in all the processes of the guiding, control and overall condition of the energy-informational state of the Brain and the flesh cells.

The address loss is a tragedy for the Control System since not only the control system is disturbed, but the point, as well. Upon detection of the

address loss, the Control System eliminates the gene pool at the new address, and that Man becomes a ballast for the society. **All the so-called "minorities are the defect in the work" of the Control System under ideal conditions. And the System GRADUALLY DESTROYS their Brain.** The control points of the Brain matrix in all octaves are given in a separate work by A. Khatybov. Here we note that only to control the pancreas functioning there are **8192 points** in the matrix of the Brain. All the drugs used by Man, either **DISCONNECT** the **BRAIN** from the ionic structures (shirt) or **ADJUST** the **SHIRT** according to the instructions of the returned part of the Brain. **There are no and cannot be medicines that affect the Human Brain.**

3.7. Language as means of communication.

Once I asked Boris Makov: "how many languages are there in the world?" "Two, – he answered, – **one pink, the other with some fur** (when there is a disease)".

Unlike humanoids, a Man is able to speak. Detailed analysis of sound forms is given in the monograph "**Christ**", **volume 3** by N. Morozov. However, the reason of formation of coherent speech **IS UNCLEAR** to modern science.

If you approach this problem from a non-scientific point of view, then the Human Brain contains a "Translator", i.e. a way of transferring **MUSIC ORDERS** received by the spine octaves or stored in the operational or long-term memory. There might be several such translators. Without such a translator you can **LEARN** a foreign language for hundreds of years with **NO USE**. If there is no translator, the Brain **CANNOT BE FORCED** to learn an unfamiliar language. **Under reincarnation it was possible not only to transfer the portable Brain's events records, but also the translator transfer that** allowed to easily and quickly update their knowledge of the language.

The Control System while checking the Brain validates the work of the translator and, if necessary, complements (making higher the frequencies potentials) the Brain with "instructions" for changing the ionic part (the shirt). When reducing the frequencies potentials you can forget everything, lose your memory. And nowadays this happens rather often.

It is well known the technique of learning a foreign language while sleeping. In fact, there should be **used 8-digit music**, and not 7 (12), as it is customary now. In addition, the record must be made in the appropriate octave (the maximum frequency of the radio-set is octave 16, which is insufficient for the instruction the magnetic pulse potential). Instead of the accurate "requests" to set up a translator from the language nowadays there are sound effects like a talk of the crowd, and the Control System can only either increase the potentials density of the earlier input possibilities or remove them at all (you wake up and discover that you have forgotten the native language, and there is no other one). By increasing the potentials density there can be effects (not immediately) of the language knowledge.

The Russian language **WAS DEVELOPED 257 years before the birth of A.S. Pushkin** (the English language, as well), and since that time the frequency balance of a living Cell and bone resonators have been modified for the new structure. These changes have been made throughout the Earth, but considering the "local control structures", for example, in China, Japan, and Korea. I want to draw your attention to the fact that the cogitative process in the countries using hieroglyphs differs from the usual. It is **a PATTERN of IMAGES** and changes in this structure, which are uncharacteristic of the stereotype would lead to the destruction of a large part of the Brain matrix. Now this process is just starting to "unfold" exactly with respect to the Russian language. ***The words accompanied by images, and visualgraphy, or images passing into words are the basis of the future mutual understanding among people.*** Exactly in the **Generator "SvetL"** and its **Programs** it is provided the "interaction" with the Generator in this way. This makes it possible to adjust it and "operate" it in accordance with the necessity. And the first experiments that are performed by the Users themselves are very encouraging.

3.8. Blood, DNA and the lungs memory

When replacing part of the Brain usually there takes place the change of the blood group. Why? – Medicine is not able not explain it. Along with it there changes the **SEDIMENTARY STRUCTURE**. Previously unknown connections and particles (and their sizes) might appear. If there is a change in blood groups, there **HAVE TO BE CHANGES** in the structure of certain organs. As a rule, it concerns outer exchange structures, i.e. the lungs. If the

Program provides for changing the potentials ratio in the atmosphere gratings and (or) the introduction of a new grating, then in the first place, the lungs have to be ready for such changes. Breathing exercises are subordinated to the Brain, and the breathing capacity limit cannot be more than the capabilities provided by the Brain (the lungs memory). With the reduction of the "passage" a Man gasps. As a rule, the reduction of the passage (and sometimes just elimination) occurs in a sleep, when part of the Brain is missing. In case of discrepancy between the "gas" environment and the lungs memory within 4 hours a signal is carried to the Brain, and if there is **NO CHANGE** to rectify the situation, the Brain is **REMOVED**.

The very name of the **DNA** (acid) suggests that it is just the medium for the change of the high octave (the spermatozoid also grows with the loss of octaves in an acidic medium). But this medium is highly organized, and using modern instruments it got possible to detect some of its features. There have been collected 64 combinations of adenine, cytosine, guanine and thymine. However, **DNA is a "conveyer"** used by the Brain for the formation of ionic structures and metabolic processes. **DNA is a sedimentary structure**, and in replacing the Brain it remains **UNCHANGED**. Just on this "conveyer" other details are to be assembled. Science has determined that out of the 64 codons 20 (known) amino acids are formed. The remaining **44 are unknown**. Note that these 20 amino acids are the analogues of the unit distributions on the "conveyer." If the "conveyer" is an "assembly unit" then there should be a "forging shop", "paint shop", and so on. We have to assume that the unknown 44 amino acids are strange "mafia" structures. Any organized "production" becomes surrounded with them.

So, what was **CHANGED** during **REINCARNATION**:

- blood group;
- memory of the lungs;
- metabolic processes, including motor coordination (could change the gait);
- the memory structure, for example, knowledge of languages, skills in singing, etc.;
- new information records previously uninherent to the individual;

I would add that after reincarnation, **the NEW BRAIN** changed the "shirt", i.e. a man could be much younger or the opposite – a 3-year-old child could turn into an old man.

Thus, reincarnation had a feature of the Brain return when giving birth to a new life, or the **CURRENT** Programmed Brain **REPLACING**. Basically, the latter was used in the great amount, with all the consequences. Reincarnation was made only by the **Kailas Complex**. Only the representatives of the "Golden billion" were subject to reincarnation, and mainly the second part (the Brain replacement). If during the life time of the representatives of the "Golden billion" the Brain discrepancy to the Programmed requirements was detected, the **BRAIN** was **ELIMINATED**. **In 2000** there was completed **the 500-year** Program for the formation of the "Golden billion". The Control, "made" before the Easter, revealed significant differences in the Brain functions, and the Programmed requirements. **N. Levashov had "had a hand" in it**. In this regard all of reincarnation functions were removed up to the normal restoration of the Programmed requirements. All the representatives of the "Golden billion" since that time have been on **GENERAL GROUNDS**, without reincarnation. However, the System makes a selective individual Brain replacement, both in terms of exemptions and in terms of a complete replacement with the imposing of certain executive functions both for the present and the future. In this process the **Programs "SvetL"** have become an invaluable tool, with the possibility arising, to make a new record of information which was not earlier inherent to the owners with the subsequent Brain "transformation". But the Programs are **ONLY** a **POSSIBILITY** and the Owner's perspective to whom close attention will be paid. All the rest depends on the man. There could not be another way. Connections, bribery and the back door are **NOT ACCEPTED**.

The Church, which was established on the information about reincarnation, nowadays **IS** a **PARASITIC** element. In no way I want to offend the feelings of believers. **It's their choice and right**. And all the tales about a "future life" are designed only for their happy existence. And as much as I tried (using N. Levashov and A. Khatybov's works) to present my knowledge in an accessible and easy way, I do realize **that people are not able to suddenly part with the familiar clichés**. Especially if the mind has lost its elasticity and got rigid, which is characteristic of the old age – to part with the myths, **THOROUGHLY INGRAINED** in their heads, is not that easy. **But if people would like to recover Human properties to their distorted consciousness – that is quite possible, and my book is a step in solving this problem.**

Chapter 4. The basic functions of the atmosphere layers and the formation of people's consciousness

The change of the laws of nature is impossible. Ignoring the law does not lead to its disappearance, but to the disappearance of the one ignoring the law.

We conceive the truth when we see it. And let skeptics and mockers say whatever they like. Ganders will ask if you say something they do not want to hear: "Why do you know that this is the truth, and not your delusion?" The truth is often so simple that one does not believe in it. We conceive the truth when we see it, just as we know that we are awake when we are no longer asleep... The truth is the best weapon. ***Every truth is a system of knowledge, but not every system of knowledge is the truth.***

Today one can turn a blind eye to what is happening, to a sudden and rapid disintegration of the life habitual for us only **UNTIL** one day when the horrifying fact that we are really in great trouble **REMINDE** us in such a way that we will not be able to ignore it. Exactly this kind of reminding we are beginning to observe now. We are faced with events and conditions that are impossible to ignore. This is not a reason for despair. In fact, we do **NOT** really **NEED** any despair now. It was exactly the despair that created the problem and, of course, would not solve it. Time has come not to get despaired, but to correct what has been done. But you need to understand that the **DESTRUCTION of THE OLD** makes sense only when you **COMPREHEND THE NEW**. It is pointless to change the current understanding of what is happening for any other understanding that is not "supported" with **NEW KNOWLEDGE** and the experience of having been use them, because there will pass time – maximum of one or two generations, and maybe less, and the imperfect new one will get worse than the old one.

The solution of any problem has its own sequence. Without solving the previous one, one can not undertake the following. **WITHOUT BUILDING** the ground floor, it is impossible to proceed with the

construction of the following floor. If to act out of place and not in due time, violating consistency, □ this will, at best, be a waste of time, at worst □ it will do harm.

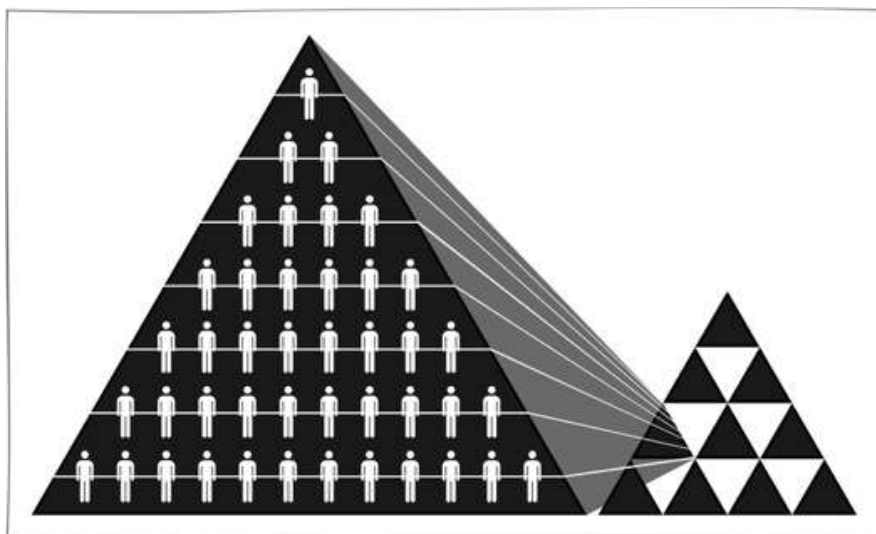

At present the whole world is seething, and this is happening before our eyes. Globalization, about which the majority knows little, has opened the borders of all states for the free movement of information, money, goods, and human streams. But inside these streams there moves **SACRED KNOWLEDGE**, which is **BEYOND** the **TIME**, space and power. And the "winners of election campaigns" or "military coups" are not able to modernize it under their intentions. The ruling "elites" still regarding themselves as the rulers of human destinies are *now experiencing the strongest intellectual and philosophical crises* that are already **NOT ALLOWING** them to influence (even if they shed sea of blood for the sake of it) the events in the world, and especially the people who are "waking up" from the age-old dream of ignorance just before their eyes.

Earlier I mentioned the words "sacred meaning" (sacral knowledge), which, perhaps, are taken for a literary ornament of my thought. This is not true. The fact is that any text or material monument is presented with facts, names, dates that are known and understandable to all from **the media, TV, Internet messages**. ***But this is the most superficial level of comprehending reality.*** Understanding the reality begins with immersion into the context, deciphering the values that the author defends. **N. Levashov** used to say exactly about this, and he wrote his works using this method □ the method of layering for a certain level of readers'

understanding. Look at his paintings, which he made in computer graphics and just try to explain (to yourself) the meaning of the image. These pictures carry very serious information. In the same way, all the writings of the **SRI (Scientific Research Institute) of the CPS (The Centre of Preventive Strategies)**, the writings of **Khatybov** and your "**humble servant**", as well as those who writes with prospects of developing people's understanding.

Immersion in a layer of the text – in the subtext, – deciphers the purposes for which it has been created. And only immersion in the following, deep and sacred levels of the text, brings to the **UNDERSTANDING** of the **MEANING**, for which facts, figures, dates, names are mentioned. Such a difficult immersion in the text can be compared with a record dive underwater, which requires special training, equipment and, most importantly, knowledge. There is a fourth and fifth levels of understanding the sacral meaning of the text, which I mastered, or rather, N. Levashov taught me. He did it unobtrusively, but persistently, perfectly realizing why I would need it. That's the Man he was.



My first experience in this was the "writing" of the **User Instructions for "SvetL" Complex**, which, as you have already got to know, carries **A LOT MORE INFORMATION** in it than a set of letters in certain words. At that time, it was impossible to "open" the operation of this technology, because almost **NO ONE HAD UNDERSTOOD** this, and those who had had it wanted and offered to use these technologies, to put it mildly, **NOT** for their **PURPOSE**. Today, the information laid down in the Instruction became open for many Users (though not completely). This is evident from the questions that they began to ask, advancing along their **WAY OF KNOWLEDGE**. But there are two more levels in the "dive." Unfortunately, I **HAVE NOT REACHED** those depths yet but I hope to. N.Levashov mastered all these levels, and in such a way "put in" the relevant information

with its sacred value both in his works and in the pictures that he "painted." But this is another story, which I am going to tell later.

To sum up, there are known well-known. These are things about which we know that we know them. There are known unknowns. These are things about which we know that we do not know them. There are also unknown unknowns. These are things that we **DO NOT KNOW**, that we **DO NOT KNOW** them. But there is also informational masturbation, when the application of knowledge is replaced with getting more and more new information, and today this is the sin of many. As a result, development is replaced with the process of obtaining information for development. You become **MORE** informed, but **LESS** intellectual. When this goes on a year after a year, it encourages self-esteem. You are becoming more and more **INFORMED** and ever more **EMPTY**. Information without **TRANSFORMATION** of **KNOWLEDGE INTO SKILL** *is a poison that destroys the ENTITY (the Brain).*

4.1. Consciousness as a factor

Up to this day, many world scientists have been in a position of searching for the answers to a very significant question in people's being: how is **CONSCIOUSNESS**, both of an individual, and public consciousness of a specific community of them **FORMED**? What is Consciousness in general, as it is? Is the process of its formation natural, as it was considered earlier, or was it controlled from outside (but not in the sense of the active administrative and technical influential participation of certain political propaganda in any form of its manifestation). The generally accepted qualificational hierarchy of types and kinds of Consciousness, saturated with "professional" definitions from representatives of social and medical sciences, psychologists and other specialists, ultimately did **NOT ALLOW** people to fully clear up the **MEANING** of **CONSCIOUSNESS**. Moreover, until now, the question itself has been very problematic: In what way do mental and cogitative processes work out?

What is the Brain, and how is it really structurally made and versatile dynamic? If the Brain of people is practically alike in all of them (from the medical point of view), then why are they **ALL SO DIFFERENT** in their judgments and actions?

Many advanced scientists, thanks to the modern technical means of observation and registration of various induced reactions and changes occurring with the Brain of people under the influence of affecting factors of various character were convinced that certain regularities from the number of reactions recorded by them according to its factorial physical state are indeed being manifested, and this is **NOT DISPUTABLE**. But the obtained experimental material has not made it possible so far to come to the unity of opinions and, first of all, among various scientific directions. Closer to the truth about the essence of the consciousness itself were, oddly enough, the theologians and founders of judgments about it, supported with the basis of religious dogmas. They, though, with a certain uncertainty, but **WITHOUT** any **SLYNESS DECLARE** that *consciousness is given by the ALL MIGHTY*, and people are "only his mouth and everything that they create is the creation of God." In this there is a much closer approach to the truth than any other proposition, erroneous not because of the people's fault. Many modern scientists more and more often express the modest idea that the "Creator of the World Created" himself is far from being indifferent to people's reaching their intelligent state. The consistency and irreproachable timeliness of the **LEVEL** of **KNOWLEDGE** concerning people's deeds and events in separate directions of their controlled existence throughout the entire previous history is simply amazing with its anticipatory event accuracy in time. It is not the consciousness of people that determines their being, but, on the contrary, their social being determines their consciousness.

The closed research conducted by specialists of some scientific fields practiced in many countries of the world with the aim of acquiring different variants of active influence on people with the intention of imposing upon them forms of control over them through the concealed violence over their Consciousness would partially represent some interest. But the general true picture of the state of people's Brain such experiments have not given so far. Such experiments convinced the initiators only in one thing – to **FORCE** someone to be **CLEVER** has **NOT** been **POSSIBLE** so far, but to produce the executors of some unreasonable forceful character for the subsequent limited utilization of the experimental ones proved to be easier and more profitable with the use of other, simpler methods of influence, exploiting mainly human vices and interest of a personal nature. Reasoning and research in this way can bring closer to revealing some systemic deep secrets of the real design of the Brain, including the realization of the very fact of the functional purpose of the Man of the Future within the ongoing changes on the Earth, **NOT LIMITING** the depth of judgments with the previous

frames of the "philosopher's stone". First and foremost, it is for this reason that it is expedient to understand in what way, earlier, on the side of the old Interventionist System, **EXTERNAL CONTROL** of all the people's being and of the level of their Knowledge through their Brain was carried out. With what forms of influence was it possible to activate the various functions of the Brain? How was it being perfected on the stages of development of general and event chronicle processes? This will make it possible to perceive ***what Consciousness is, the way it had been formed, and changed over the stages of historical development, and so on.*** Serious help will be given to us on the issue related to the true Structure of the Atmosphere and the Control functions imposed upon it, which were put in its gratings by the old Control System, including the processes of formation of Consciousness and the public Consciousness. ***Consciousness creates reality, and you create your consciousness.***

4.2. Functions of the Interventionist System Atmosphere layers

In the scientific community there remains less and less former self-assured confidence in the unshakable firmness of the supposedly "natural basis" of Nature's self-development and similar natural development of the Civilization harmonious improvement, including people, and much more.

Finally, science has pondered the problematic questions – who or what, over whom or over what carries out a kind of mysterious governance unattainable by our Consciousness. And is there a fact in itself of its presence? Is there any control over them in people's consciousness, and if there is, then, how does this happen in the physical plan of the process itself, as it is? In what systemic way is the **HARMONICITY OF DEVELOPMENT** of all the variety around us in the material and non-material states of energies achieved? Probably, instead of stating foolishness of the necessity of the existence of naturally natural "food chains" in the whole biological environment, there are some more serious reasons for the existence of such a vast diversity of substances of biological species. Is any correction of this state of the **COMPREHENSIVE CONTROL** possible? If it is, what place is assigned in this current correction of conditions to people in the future, what is going to happen to them and what steps are acceptable

or necessary to take now to preserve their lives and be called for on this Planet, and not at the level of the current consumer prolific "animal husbandry for their own good? This is one of the key questions that is asked by those who has embarked on the path of **KNOWLEDGE** and who at least has begun to "understand" something, having awakened from a dream of ignorance, into which we had been sunk.

How did it happen that for the **LONG PERIOD** of the existence of life on the Earth with the participation of people, the comprehension of the essence of the occurring physical processes of supposedly some "self-development" is shielded with a dense curtain from the people's deep knowledge? Why did the "surrounding nature" turned out to be so apophatik¹⁹ for "thinking people"; they have already conquered everything in "the Nature" to an unrecoverable state? Who isolates them from such knowledge and why?

N. Levashov wrote about it very clearly. He deeply investigated this process, and it looks something like this: the deeper the world is "cognized", the more questions arise about the physical essence of the process of its existence. Most of the former basic constants and dogmas of both scientific and religious positioning fall apart in ashes, and the "new" ones are not always presented intelligibly and sensibly. Inquisitive minds are often carried away by the esoteric world outlook, demonism, cosmopolitanism and so on, thus making the way to the **TRUTH** even more **UNATTAINABLE**, leading such an unstable knowledge to a state of complete misunderstanding of the truth itself.

There is only one path for us – to find the truth about the "World Created ", which will **MAKE it POSSIBLE** to **CLEAR UP** the hardened Knowledge at least about people as some kind of intelligent beings (the only one of the whole variety of biological world substances), pave the way to the development of the general level of the *former stagnant state of Cognition of the surrounding World*. Is it possible within the current level of the Brain octave, the state of its functions and the corresponding mechanism of people's awareness? And if it is possible, – what **CAN** people **DO** for this? Here comes the question in relation to "**SvetL**" **Programs**,

¹⁹ from Greek apophatikos – negative) is a property of thinking that promotes the self-denial of man as a perfect being, the use of Apophaticity (free will for the fulfillment of Divine commandments and the constant abiding in the state of confession of his sins and repentance.

their application, the expansion of knowledge and personal understanding – what they are for today.

Within the framework of the problems of formation of individual and public consciousness of people, the nature of its current state in connection with the ongoing **SYSTEMIC PROCESSES** of cardinal changes, let us consider the construction of the Earth's Atmosphere Gratings. And to be more precise, we deliberately limit ourselves to considering only some of the basic functions of the control so that to ensure the existence of people's lives.

4.3. Formation

All the true Atmosphere layers, as the most complex harmonious Construction of a strictly identified set of its energy gratings, were formed in the model creation of the Earth. Exactly this true layered design of the atmosphere provided, first of all, self-governing by the Programmed "Natural Habitat and the Controlled Environment", which, in turn, fundamentally based the very fact of the "origin" and existence of the true Life itself with its orientation to the "Intelligent basis".

Moreover, only such a specific design of the Atmosphere was to be one of the mandatory conditions and at the same time an important closing link in the formation of mandatory conditions for ensuring step by step development of the Earth Mind and its unconditional very important role, – the Human Mind. **NO** other harmony **COULD HAVE BEEN** in the development of the true Earth Civilization, and all the rest is inappropriate for *the intelligent life*. Such is its true Programmed essence and the embodying civilization Entity.

For the Earth (as a specific model complex □ a Planet), located in its functional endowment in the Common Hierarchy of the Planets, program-oriented to the development of Civilizations of "Intelligent orientation", the following is envisaged (enclosed): The entire incarnation of the most complicated path in the development of its Civilizations **IS TO BE IMPLEMENTED** in *eight consecutive stages of an increasing level of perfection* (in a tact of event-driven time in the course of the gradual Programmed chronicle process), with the achievement at each of them the complete perfection of the harmonious "**energies being**" within the strictly set up limits of the octaves of these energies for each particular stage.

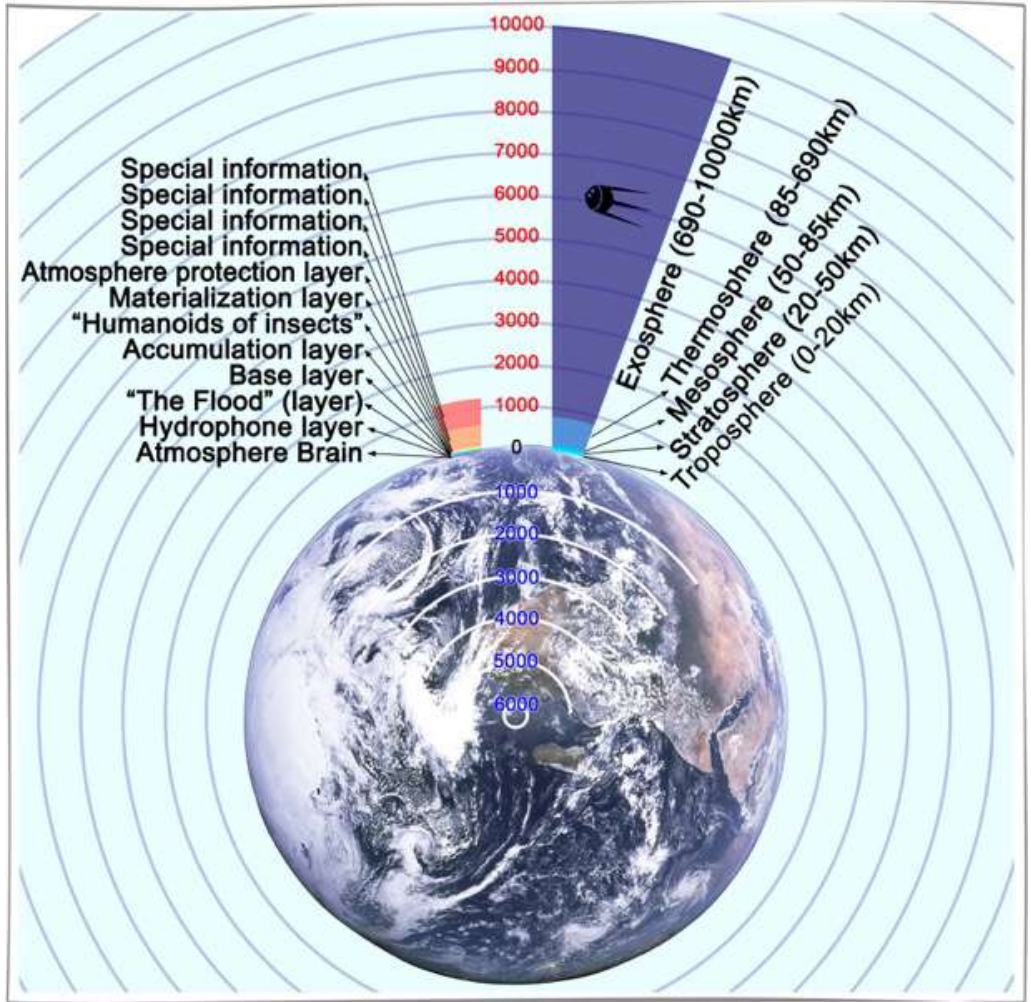

Such a complex process of development in the harmonious being of energies envisages both its own Programmed Control capabilities for all the ongoing chronoprocesses with the help of the Earth Control System and the possibility of "external" assistance and control providing **LIMITED INTERFERENCE** from the outside in the process of governing on the conditions of guardianship. Here it is worthwhile to remind those who are skeptical about **Levashov's** abilities – he was able to interfere and did interfere (even judging by what he wrote in his books) in the processes of the Control.

It looked something like the picture. It shows the work of **Levashov's Generator** (transferred from France to Russia) with the interaction and correction through him of the energy of one of the processes of the Control, a concrete action (process) related to the real events.

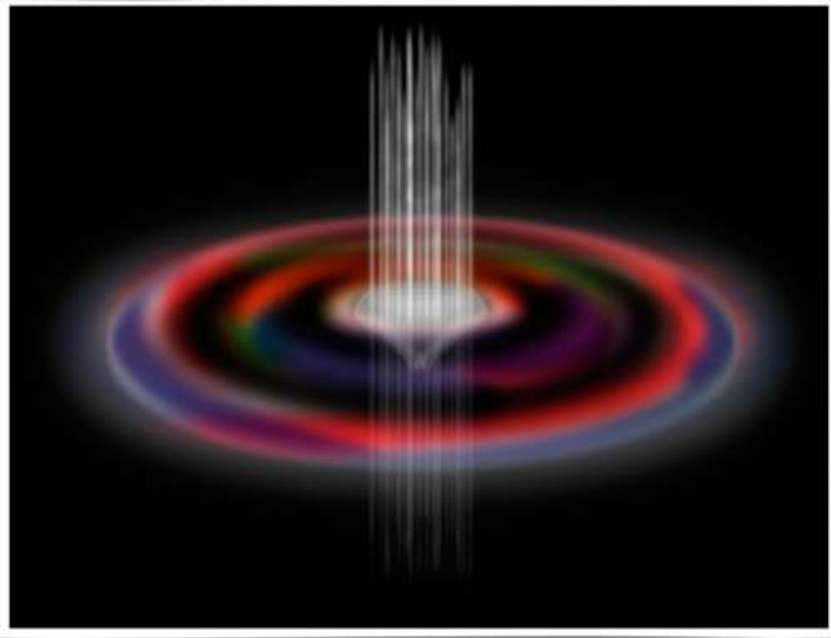

By the moment of the Interventional capture of the Earth²⁰ it had been only at the **FIRST STAGE** of its civilization development, providing an admissible limit of getting its perfection for "the whole spectrum of arrangement of life being" of energy octaves, equal to **12-512**. Our Earth is young by the standards of another kind of time. It was exactly within these limits of the energies octaves that the entire true "**The World Created**" for the Earth Planet was formed, as it began its own far-reaching path of the perfect development, possessing a unique state of life **STEP-BY-STEP GOVERNING** aspiration for the "**Intelligent²¹ Orientation.**" This **NATURAL STATE** of the developing energies matched the construction of its harmonious and rigorously identified Structure of the energy gratings (identified dodecahedral structure, i.e., the **Di structure²²**). The developing process was under a single Control on the side of its own Earth Control System, programmed to achieve the perfect harmony of the "energies being" of the entire Planet in their **material and non-material**

²⁰ Materials in Part 1-4 "Fundamentals of the Formation of the Mankind".

³ "Intelligent" is like thinking. Accordingly, replace everywhere "intelligent with thinking" and then you will see that wisdom is a goal or an already achieved state, and thinking is a process leading to this goal.

⁴ Di-structure – 8 dodecahedral-icosahedral (DI) blocks, each block has nested DI blocks (total in one DI block 44 attachments). The structure is constructed using the properties of the golden section (without the golden section – just nowhere). The state of the structure is **HIGHLY ORGANIZED PLASMA**.

states. I would like to note an important feature. The Civilization developing²³ process for the Planets, having the existence of a concrete life on each of them and being in the Common Hierarchy²⁴ of the planets of the "Intelligent Orientation," is to be some **ENDOWED WITH** mandatory condition. This **MANDATORY** condition, connected, first of all, with the fact of recognition of the achieved level of their perfection in their development and transition from stage to stage, is the obligatory achievement of the necessary level of perfection of the Mind of the Planet. Achieving **ONLY** a harmony of the existence of energies in their material and non-material states is **NOT SUFFICIENT** to be recognized as the appropriate level of development of Civilization on the Planets having life. The same reasoning can also be found in N. Levashov's writings. **Lots of Lives, but few Minds!** The rest of the Planets not having "living conditions" are **PREDETERMINED** by the Program for the **LIMITED** process of their development or the absence of such at all. They are functionally used as "warehouses" **for the accumulation and storage of some forms and types of energies in their various states** as producing generators of something under someone's control (including information of various kinds) or performing various types of protective, recycle-regenerating, experimental functions, etc. And, accordingly, by their constructive form and content they are arranged in a completely different way (in contrast to the Planets possessing living conditions), but harmoniously to their identified function. In each planetary, galactic, intergalactic and other **CLUSTER SYSTEMS**, specific component elements of the Planets are required. Variety and their composition depend on the functional purpose of this cluster level.

For the Earth, in particular, **the development of the Mind of the Planet IS IMPOSSIBLE** without the harmoniously developed Human Mind as the very fact of recognizing the perfection of the Civilization development level. Consequently, the transition to the second stage of development, which provides for raising the upper permissible level of **energies octaves from 512 to 1024**, etc. with the increasing discreteness, **IS also IMPOSSIBLE**, i.e. there is no, and there cannot be any movement in its development.

²³ Proceed as a consequence of the cause. From an insignificant case, important consequences emerge.

²⁴ Hierarchy (from other Greek – ιεραρχία) – the order of subordination of the lower links to the higher.

For this reason, the recreating Man is important precisely by the fact that his associated ***Mind is an integral part of the Mind of the Planet***, without which the latter is improper (incomplete). But the Human Mind is also not independent, since it only is able to develop in the process and through the development of the Mind of the Planet, and necessarily with the accompanying process on the side of the true Earth Control System.

In this connection, all sorts of myths about the development of supposedly some kind of **the fourth Civilization on the Earth** are **NOT TRUE** (just invented) and are an evil intent on the part of the Interventional Ebr system. The true basis for such judgments does **NOT EXIST** at all, since even its first "native" civilization has not been developed and completed to its perfection and harmony, since **18000** years ago such a development was halted by the intervention of the alien system!

This most compound process of the complex development of the Earth Civilization (so far within the limits of 12÷512 energies octaves) has now begun to **RESTORE** in all its **TRUE** states and directions, getting support of the original Earth Control System and external guardian assistance from outside, on the side of more developed Governing States and Civilizations. At the same time, all the consequences of the former Interventional constructive and governing interference have been **ACTIVELY** liquidated.

It was in this "process" that **N. Levashov** took an **ACTIVE PART**. This was the **MAIN REASON** for the assassination of Svetlana (his wife), and then him. Now we already may talk about it. Only a part of what was done by them and realized (here I emphasize – together with Svetlana and without her participation), is described in his works. All the rest was done without publicity (although those who had to know about it they did know).

Very appreciable help was given to Levashov by the so-called "**White Brotherhood**" and especially when the so-called "**The Abode of Gods**²⁵" appeared within the "visibility range".

⁷In parts, Levashov wrote about this in "The Mirror of My Soul".

4.4. The Abode of Gods

In the last century, Russian mathematicians carried out an interesting study. In a powerful (for that time) computer the scientists downloaded data of all the laws of the natural sciences and asked one question: "**How does it work?**" The computer gave the answer: "**To make this work, there must be an external governor.**" **In fact, the existence of God was confirmed.** (We have already understood what God means). But where does he "live"? Where is his "abode"? Perhaps the answer **came in 1994**, when the Hubble Space Telescope took photos of the unique object.

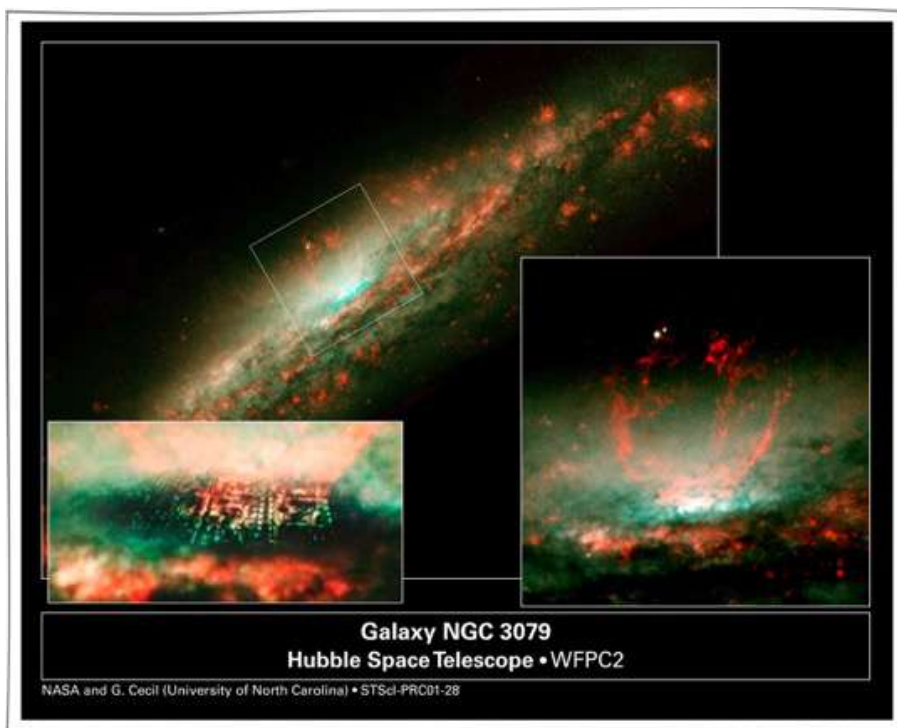

In the photographs, the interest of scientists was caused by a small vague spot that did not explain any interference or optical effects. Additional pictures were taken with the maximum resolution. What the NASA scientists saw, **the government immediately classified as secret.** But this information became available.

What did the specialists see in the picture? Professor of the University of Florida **Ken Wilson** saw a city, a real city. The shining structure, reminiscent of Swift's "flying island," seemed like an unreal city of the future. The object that appeared in the picture was called "**The City of Gods**" or "**The Abode of God**".



This city is stretched in space more than several billion kilometers, and in comparison with it, the Earth is just a speck of dust. What has been found in the universe? There are lots of assumptions on this subject, but they all can be brought to **TWO VERSIONS**.

6. An Unknown super-civilization **HAS CREATED** a **GIANT CITY**²⁶, which is noticeable at such a huge distance, although previously objects of such magnitude had never been found.

7. This is the place where the Creator really dwells.

Scientists continue to study this site of the universe, but all the new information is still classified as secret. It is classified as secret only for one purpose – they (some of the "powerful of this world" – ebers or blacks, or spiders, as you like it) have "**RECOVERED** their **SIGHT**": **Firstly** – "this" has been created beyond their will and understanding. **Secondly** – "this" has destroyed much of what had been created within their Control System and not only. And **thirdly**, the **White Brotherhood** exists, and its "representatives" control the changes that are taking place, and they reinforce their ranks.

After the assassination of N. Levashov, as I wrote in 2012, **8 "people"** involved in his death, **6 in Europe** and **2 in Japan** were annihilated. The slogan of this action was "**For Christ, Alexandra, Nicholas and Sevastopol ...**"²⁷ This is how it was "covered" in the media. "In Osaka, Japan, on August 21, 2012, immediately after lightning strikes and a severe

²⁶ N. V. Levashov – The Mirror of My Soul.

²⁷ Radomir, A. Khatybov, N. Levashov and... Sevastopol (as the planned capital of the Jewish Kaganate).

thunderstorm, some residents were **SHOCKED** by an unusual **PHENOMENON** – the light pillars." (The photos are taken from Twitter).



One of the authors writes that he only *wanted to shoot the lightning, but it turned out to be a photograph of the post that appeared immediately after the lightning strike*. He, for some reason, called this phenomenon "The strike from Laputa" (Laputa – "the Flying City" in the clouds). Further, I hope, everything is clear.

Approximately the same happened to the people who had been preparing to "shoot down" the plane over the Sinai Peninsula. They are going to be mentioned later on – practically **NOTHING REMAINED** of them, as A. Khatybov put it – "crumbled to dust", and after that, many "powerful of this world" got seriously worried.

In the fall of **2014**, I went to Europe, to the foothills of the Alps, where I met Levashov's Friends. N. Levashov mentioned them for the first time when he described everything that was connected with the assassination of Svetlana. Nicolai tried to "revive" it, but he did not succeed. And then he asked his Friends to do it, because, as he said, they had such capabilities and were able to help. But he received a reasoned refusal and justification of the **POINTLESSNESS OF THE SUCHLIKE**. He told me about this before leaving for Svetlana's funeral, when I came to see him just a day after all that had happened. Human emotions are emotions, but even then I knew that emotions are hostile to clear thinking, because they are – to some extent – an indicator of some mental disorder. Nicholas felt Svetlana's death keenly. But, in my opinion, he realized that there was also a real expediency. This expediency was in the actions of his Friends. And if we go back to the beginning of this chapter (to the layering of writing texts), Levashov's words about Svetlana's death bring us to the conclusion: "Apart from Levashov,

there are **Humans** on the Earth who are **MORE CAPABLE** "in comparison" to N. Levashov (although this, in my opinion, is incorrect comparison)." Here I got to know them (or rather they got to know me) just on the second day after **N. Levashov's** funeral in Moscow. I wrote about this in an article on **TRAGIC EVENTS on June 11, 2012.**

At the meeting (or rather, the seminar) in the Alps, much was learned and some practical skill came in many ways. After that, I already reasonably checked the efficiency of "**SvetL**" Programs, having realized their "hidden" capabilities, as well as the possibility of their correction with respect to the current events.



And to be more precise, I "defended" my knowledge in "SvetL" Technology before very strict examiners who also told me those things that N. Levashov and I **HAD NOT HAD TIME** to discuss. I will not touch on all the details of this seminar. I can only say that much that happened after the death of N. Levashov was radically revised and thought over. For example, I got convinced in my own experience that *Man, in his present-day EARTHLY countenance, IS NOT ABLE to move and develop the Space.* But this does not mean that a Man **CAN NOT** do this. With the help of the Friends, I was given an opportunity to "visit" that very "**White Star**", or "**The Abode of Gods**". Then I have not been able yet to make such "trips" by myself. I would like to note for those "writers" and "followers" of **N. Levashov**, who broke into groups according to "their own interests" and today they are nothing but *gaping void of wretchedness*, that I am going to disappoint them. There is no "holographic monument" to either Nicholas or Svetlana. The memory of them is expressed in a different form. **And this memory – lives.**

After the "excursion" I got to know the real truth about what was **under the Levashov's Castle in France.** I was shown how immaterially through two objects (rings) that you see in the photo and that Nicolai and Svetlana had on them there was governing of what that was under the Castle that time.

Levashov, of course, could govern without these "objects", but they made it possible to do it most effectively and, if necessary, – point-wise! Moreover, as it later turned out, they "have been "created" and handed over

to Nicholai and Svetlana precisely for these purposes by those who "had placed" it under the Castle (I call this creation the **GENERATOR OF SUPPLEMENTARY ENERGY** (for the people to have an idea of what it is). Who and what for it has been made – I will slightly open. This is all – *man-made*, as well as *the "White Star"*. For Nicolai Levashov, it was an additional "tool" in his work, **PRESENTED HIM** by those who knew that Nicolai 's hands are reliable hands.



After the acquisition of the Castle and the full information – why and what for exactly this Castle was to become the property of Nicolai (besides the related Svetlana's ancestors), these two objects (two rings), the photograph of which you can see, belonging to **TRUE TAMPLIERS** (not those described by historians with distortions) *were handed over to N. Levashov by Svetlana's relatives*. These relatives are the direct heirs and descendants of those true Tampliers who knew the "secret" of the Castle, but they **WERE NOT ABLE** to use it properly. *Nicolai made up for it*.

At the seminar, in daily talks with Levashov's, Friends I got to know the time and the possibility of my participation in the transferring this creation – *the Generator – from France to Russia*. I also knew why this was necessary and realized that at the **DETERMINED TIME** all this would "come" to me in both tangible and intangible "guises", which would allow using these "tools" exactly in Russia and applying the emerging **NEW RESOURCES** in "**SvetL Technologies** (and not only). Moreover, I got the confirmation of all this when I visited the north of Iran (almost immediately after the seminar in the Alps) in the place where **N. Levashov** had been twice in his time. But that is another story.

Everything happened exactly as I had been told, and today it does not matter in what way these items became "mine" and ended up with me. I'd like to note that other very valuable items belonging to Nicolai "have come up" to me. I knew about their "resources" from N. Levashov, who showed them to me both in the photo and as real things. The main thing is that these items (each one for certain purposes) are already "working" for the good. The use of these rings, not as decorations, but as tools, for example, is an appreciable help in setting up generators for the **New Complex "SvetL"**, "**intensifying**" the Generator (its original parameters) and "**SvetL**"

Programs through direct interaction with **the Generator of the "complementary" Energy** (this is my terminology) which was transferred to Russia, more precisely, to the North-West of Russia.

Everything that is connected with the **TRANSFERRING** this unique man-made (I emphasize – man-made) **CREATION – the Generator "under the Castle"** (from a depth of **1369 m**) – has been realized and allows to significantly influence the processes that the reader already knows about. Regarding the Castle itself, I believe that now this matter is closed to me. I **DID NOT** and **DO NOT HAVE** anything to do with it.



I myself have **NEVER BEEN** to it. Some halls and his study with the library, as well as paintings that were in the castle and sold at the auction in 2016, unclear to whom and for quite a "ridiculous price" (this is a separate topic of the narrative, which I will probably soon disclose), Nicolai showed to me, when we talked on Skype.

Most of all, I was struck with a picture painted by Titian and acquired by Levashov in France "**Tarquinius and Lucrezia**". The picture was painted **in 1535 for one of the greatest patrons of Titian and a friend of Marquise Frederico Gonzaga**, the Duke of Mantua on his personal order. This is one of the most unusual and intriguing paintings by Titian, in which the great master painted a **REPLICA** of Gonzaga's face as the face of Jesus Christ. And later, I saw the documents for this picture, which confirmed the genuine Titian



After the death of Levashov, due to certain circumstances, my friend and adherent **Alexander Kalenyuk**, was in the castle several times, he viewed the castle and captured everything in the cinema and photo documents in sufficient detail. He saw all the paintings that belonged to Nicholai and Svetlana, before the auction. I have this material and it is more than enough. However, after the auction for the sale of property in the castle, which, as I said **was held in 2016**, the Castle today is of interest only as a historical building, and **NOT MORE**; it will be realized, at the request of the heirs, at an auction that will be held in France. So, you can see that even this is the justification for moving the Generator to another place.

I convinced myself more than once of the sagacity of N. Levashov. Since June 2011, already under his supervision, there has been going on its activities in Russia and abroad, the organization created by me at the

beginning of two thousandth (historically revived), which I called "**Russian Scientific and Technical Society**" ("**RSTS**"). Many people ask: "Why is this name?" Not in the title is the essence. The essence is in the action. "**RSTS**" is the organization of a group of "St. Petersburg" scientists to solve problems in the field of new breakthrough technologies. Practically, by that time, "RSTS" had fulfilled the tasks, initially put before it. And they did it **NOT ONLY** in Russia. I was about to close it, because practically all its participants, having completed the tasks, began to work in a number of other directions. It was objectively, unfortunately. But the correction that Nicholai brought, after getting to know about my ideas and the story of the "**RSTS**" **creation** put everything in its place. He made me believe that the **ORGANIZATION NEEDED** its **REVIVAL**, further development in working out those technologies that we have already begun to deal with under his leadership. And the process of transformation made a start. I can **NOT** fail **to MENTION** here the enormous work of **Vinogradova Nadezhda Timofeevna**, who, since the 2000s, has been at the very beginning of the **RSTS** creation taking upon herself all the routine and paper work, which was abundant.



On Levashov's insistence, the attributes of the society were developed, and the Sign of the "**RSTS**" Participant became a silver ring (with the symbolism from N. Levashov).

The first two Signs, according to his sketches, of the pure gold, were made for both of us. But after "being in the hands" of N. Levashov, the atomic structure of the metal has changed, and it was **NO LONGER GOLD**. **ALL** the **FOLLOWING** rings were made of silver. The first silver rings (signs) **WERE PRESENTED** to **Nadezhda Vinogradova and Alexander Kalenyuk**. Exactly silver is that metal today on which the "Generator" feels "comfortable".

The Generator is set in the ring with the Programs personally for each owner. They help the Man to open a very broad perspective with his proper development. And, of course, "protection is put in" in the broadest sense of the word (and from the "fool" too). All this was "thought over" by N. Levashov. He insisted that the Sign



should be made precisely in the form of a ring, explaining that "there are words that can be incomprehensible and not perceived in any language, and there are symbols and signs that are" weighty than words ", and for those who are initiated – they do not require any explanation. " Moreover, taking into account the participation of women in the organization, as an additional element **EXACTLY FOR THEM**, a stone (sapphire) was set in, which gave **NOT ONLY** elegance but beauty to the ring on the woman's hand.

The organization was launched on the day when N. Levashov appeared "with his Sign" "**RSTS**" at a regular meeting with readers. This was understood **NOT** by **MANY**, but those who had to understand – they understood. This **WAS** the **BEGINNING** of the "**PRESENCE**" of the so-called "**White Brotherhood**"²⁸ **directly on the Earth**. And with some "representatives" of this "organization" I have the honor to be acquainted.

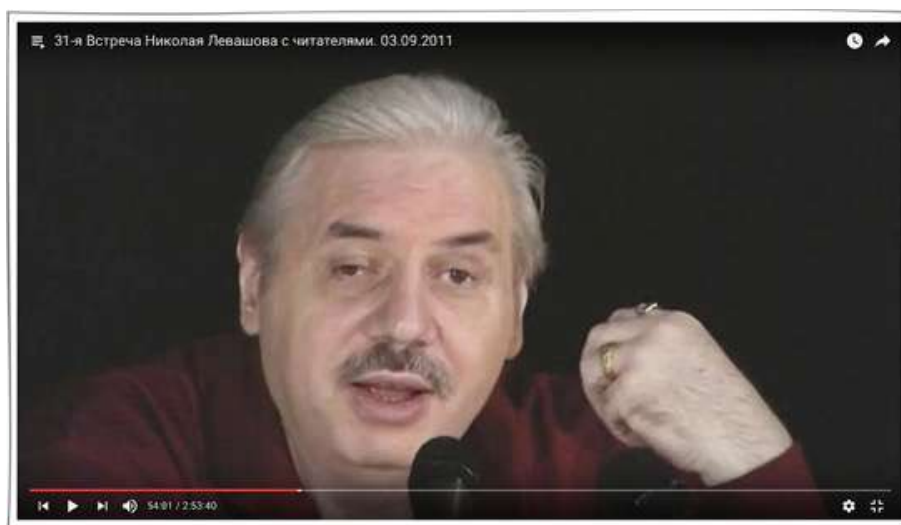

I have told you much of what I got to know. I have revealed some possibilities of applying the "heritage" of N. Levashov, but I am closing with dots more detailed information, because **THE TIME HASN'T COME** yet to make it public. I do not mean the enemies. Who are those who, after the death of N. Levashov, made public what had been "closed by dots" in his works, obviously thinking, that it would give them the "weight of the initiated" regarding the admirers of **N. Levashov**. They opened but **NONE**, until now **HAS GOT AT THE MEANING** of or commented what was "opened" and what it was "opened" for. I am sure that in the very near future

²⁸ "White Brotherhood" is an intergalactic organization, described by N. Levashov in the book "The Mirror of My Soul".

it will be possible to "disclose" this information that will become the **KNOWLEDGE** of the ready to accept **PERSON**.

.....²⁹

4.5. The root of the problem

Outlining this information and understanding all the specificity of the topics touched upon, first of all, I address it to those whose goals are **NOT LIMITED** with the framework of this world, but expand to the fields of, let's call it, metaphysics. I do want *this information to become basic for many of you*, the one which would push off further, if, of course, there was a desire. I deliberately "simplify" the information from **N. Levashov, A. Khatybov and the Research Institute of the CPS** (the Centre of Preventive Strategies) making it, in my opinion, more accessible to the reader. However, it is impossible to give such **BASIC INFORMATION** to the majority through logic. Even the most simplified text, many of the readers forget and return to their subconscious settings the next or in a couple of days, – not because they find some logical inconsistency, but because the information contradicts the existing subconscious settings. ***The unconscious is stronger than the conscious.*** But I do want to hope that the conscious will become stronger if the Human himself wants it. Therefore, I will persistently write it again and again, but on more expanded information. I **DO NOT HAVE DOUBTS** that people who are now participants of "**SvetL**" Programs will get a deep look into the essence of the written. But so far there are **NOT ENOUGH** of them, and if the others get interested in this or that way – ***there will be a breakthrough.***

However, we have to go on with the narrative. The most complicated true Construction of the entire **LAYERED STRUCTURE** of the Atmosphere before the intervention had contained such a complex of energy gratings under which in each layer there had been its complex set ("recipe") out of the group of energies frequencies from **12 to 224 octave**, mainly and even with some individual elements up to 512 octava (only out of the Di-structure). This layer-by-layer energy Construction of the Atmosphere Gratings **PROVIDED** the **FORMATION** and retention in the given program harmony all the specifically necessary variety of the progressively

²⁹ Not public for the time being.

developing harmonious being of energies ***in their non-material and material states***. For all that, gradually and strictly with respect to the given tact of event-driven time and the framework of the general chronoprocess, the process of improving the energies being as a whole and harmonious with it, the **DEVELOPMENT** of the **MIND** of the Earth and the **MIND** of the **HUMAN** occurred.

The Mind in itself is not something vague and formless, i.e. unconstructive, uncontrollable and non-systemic existence of energies being. The **Mind** is also a complex of a special functionally different being out of all possible limits suitable for controlling octaves and energies states over the energies of other octaves and their states, with reference to each specific stage of the Civilization development. Template-machine, i.e. certain mechanical "computer programmed" or limited mathematically-systemic approach to methodological forms of perception and attempts of judging the Mind in this case is unacceptable. It (that is, the Mind) in its development acquires the same **STAGE-BY-STAGE PERFECTION** of such Programmed functions and abilities of Controlling all development processes of the Civilization in general, which **IT HAS BEEN INDOWED WITH** as far as the model formation of the Earth planet. It has the properties of control and self-control, as the well as functional abilities of the Control, the conditions of various forms of contact, including the individuals (that is people), objects and the Control and Support complexes, transmission, reception, decoding and storage of information and the inherent conditions of a completely different level of ***of "Life" definition as the form being*** and the state of the complex out of the whole "set of energies" as a programmed true essence, acting as the leading orientation and control over the "correct" Civilization development as a whole. This is absolutely **NOT SPONTANEOUS**, but a concrete objective and pre-oriented **TARGET PROCESS** of the development of methods and forms of governance, which are only being perfected with each stage. **AND THE MOST IMPORTANT** – ***The Mind is material, since part of the Mind construction of our Planet is composed of the "matter of magnetic energy" within certain limits of energies octaves!*** Moreover, this matter has the ability to move and at the same time, it **DOES NOT HAVE** any obstacles in its movement, the speed of such a movement is many orders of magnitude higher than we understand and compare with the speed of light (photons). Understanding this, **GAVE ME THE RESOURCES** to start "experiments" with the "impact" on specific objects, including people, first through the Complexes, such as **"SvetL-Flora"**

Complex, and then directly with the Brain of a certain Person, concerning his recovery. For me it was a great victory. But this victory would be **IMPOSSIBLE**, as I see it, without my acquaintance with Nicolai Levashov.

How can the lower comprehend the higher? The question seems to have no answer. Not exactly, because the lower can comprehend everything only with the guardianship of the informational support, governance and control of the higher state. This should be referred to **the "SvetL" Programs**. We should also answer the previously unanswerable question: **how can the Brain comprehend itself?** It is also able to comprehend exactly itself, but only if parts of its constructive functions (less or more is not important) **ARE CHANGED** to a **HIGHER-OCTAVE** level. This is not a state of some flashing or forerunning some scientific discovery, it is a much more perfect state of the forthcoming change in the level of the whole Brain octave. This is still ahead of those who are directly integrated into the future. Would you like to check it out? Mentally ask yourself the question – **"WHO AM I?"** Immediately all emotions will go away, because the Brain will come into "stupor". It is unable at the current level of octaves to answer the question to itself – **WHO IS IT?** But **the Mind** has to be "turned on", which will make it possible "to receive" direct information from the Control System, which, in turn, affects the increase of the Brain octaves. So everything, as you can see, is interconnected. And if you are a user of **"SvetL" Programs**, there is a great chance of what we have already talked about – you will be "taken" **to the Bath**. There you are going to "be sweated" and "washed..." This is a kind of some useful deviation in the judgments.

It is good enough to ask questions of an unusual sound for the science, – what kind of Mind could the interventionists impose on our Planet? In what way and what kind of constructive and functional orientation did they develop it? What kind of Mind did they put into people and with what subsequent program objectives? What for did they **NEED** people **IN GENERAL** and exactly with **THAT KIND** of Mind, that was imposed? I will try to answer these questions, but first of all it is necessary to have some information about the Interventional Atmosphere Construction, which played, in this respect, **QUITE** an **IMPORTANT ROLE** in their "Created World", which basically provided the environment conditions on the Earth, acceptable for **"interventionists"**.

This part of the "Created World" both in religious and scientific dogmas is **MORE USUALLY** defined as **certain apophatic Heavens**, which really possess a huge set of not only certain mixture of gases

supposedly necessary for life and miracles occurring in them, but true majestic mysteries that are not known to this day.

It is quite enough to enumerate such, until now unknown, speculative manifestations and effects of physical processes in the Heavens, **NOT PLAYING** a leading role in the destination of the "Heavens" in general, like thunder and lightning, the northern lights, the origin of systemic and non-systemic air streams, rainbow, precipitation, sounding and intimidating rumble, which appeared now in certain regions of the planet and so on.



Let us return to the consideration of the arrangement of the true Construction with respect to an incomplete set of all previously set in functions on the Atmosphere layers. The fact is that this issue is a very narrow specialization in the processes of the life being Control on the Earth as a whole, which significantly affects the essence of the transformations in the near future. Therefore, **IT CAN NOT** be published in the conditions of the remnant aggression, as a complex interconnected **STATE** of the **PART** of the imposed functions of the Brain of individuals *with a certain genotype of the Brain*, making up the former level of Consciousness of some people of the present time in auto-motor style who carry in themselves the imposed vices and violence.

What is offered to readers about the Construction of the Atmosphere is only **SOME SUPERFICIAL** component of the general knowledge of the **NOT HAND MADE "the World Created"**, limited by the scope of the explanations given.

4.6. Understanding

After the seizure of the Earth the structures of the energy gratings of all the Atmosphere layers were **BASICALLY CHANGED** by the interventionists due to setting in the "imported" energies base octaves and their own accepted forms in arranging energy gratings, but only in the range **of 15 to 128 octave**. The fact is that in the general interventional escort, as I have already mentioned, three moons arrived. But with the self-destruction of the Planet **Phaeton**, the most perfect two were eliminated. For this reason, the ultimate of the "delivered" octaves of the basic imported energies was limited. Within these limits of energies octaves **THERE WAS COMPLETELY DESYROYED** the entire true (child-bearing) constructive filling of the energy gratings **in the Di structure and replaced for a cubic one, i.e. K-structure**. But **from 129 to 224 octave** the true original base energy frequencies in all the Atmosphere layers remained in the former structural state (**Di-structures**) as a fact of inaccessibility in their elemental construction due to the limited technological destructive possibilities of the interventionists. However, for all this time (**i.e., over 18,000 years**) the potentials³⁰ (potential density) of the frequencies in these true energies octaves (**129÷224 octaves**), **NOT BEING** in the maintained state of energy "recharge", were approaching zero and **by December 2012** would have disappeared (collapsed according to the plans of the Interventional program), and the Atmosphere structure after this destruction would have to contain **only imposed k-structures up to the level of 128 octave**. This would have become the irreversible finally captured state of the Atmospheric Construction, in which case the Earth would have actually carried out its self-liquidation in general. I'd like to note that **"SvetL" Programs** as well as **the Generator** itself, after their "creation", also required **SOME ENERGY "SUPPORT"**, because all of these "were created" in the previous Interventional energies octaves. This support was implemented first by **N. Levashov** himself (that is, he himself created this "replenishment") then the so-called **Generation Matrix** (creation) of the Generators left by **N. Levashov** for direct application. But the Matrix's capabilities are limited (and the Matrix itself required "replenishment"), and the number of "having created" and "being created"

³⁰ Generalized characteristics of the interaction of charges in the investigated region, with the charge of the energy imposed on this region of the octave. It is impossible to measure this parameter with the instruments of modern science.

Generators – was growing. This was one of the reasons for the transfer of the "Energy" Generator from the territory of France to the territory of Russia. It was under this action that a **NEW COMPLEX "SvetL"** has been created, which has shown its excellent efficiency today. But we will not be led away from the point. All information about the fantastic "horror in Hollywood scenarios", symbolizing some "apocalypse", really through different representatives (mainly individuals of 423 and 441 genotypes of the Brain), was broadcast earlier by the Interventional System during the last several centuries as a kind of providence of various Armageddon. And this process of the Governing Support has also been eliminated now. Scenarios of "the end of the world" are in vain. And the very process of eliminating the intervention consequences in part of a new arrangement for recreating the Atmosphere energy gratings and bringing it back to the previous one, i.e. "virgin" state, is taking place without their interference and not in line with their will and diligence. But according to the true scenario, this process is going to be even much tougher than the fantasy frames of their crafty "filmmakers" – the apocalypse is not only **STARTED**, but **HAS BEEN UNDER WAY SUCCESSFULLY** at an increasing pace. Inessential part of its manifestation, i.e. its occurrence in the material states of energies octaves is being observed and will go on to be observed by people during the entire Transition period.

The layer thicknesses of the Atmosphere were also changed for all the basic parameters adjusted by the Interventional System for the appropriate arrangement of the Construction from the k-structures with the introduction of only their communication frequencies, which could ensure, among other things, their own steady controlled information contact with their planetary satellites, the Moon and the Sun, i.e. with all of its fleet of planets. In addition, all the technical development of the Interventional System was accompanied by the introduction of such newly set in frequencies into those layers of the Atmosphere in which there had to work **ONLY THEIR** "technical system of translation" of energy-information support of their entire controlled and organized being of energies, as imitating the development process of **ALLERGEDLY CIVILIZATON** of the Earth as a whole.

Moreover, in the original (native) true layers of the Atmosphere, additional, specific **TARGET CONSTRUCTION CHANGES** were imposed. For example, with their help, all conditions were created for receiving tritium from the satellites of the planets (as from the transported

"warehouses" so necessary for the operation of their objects and complexes) as the only acceptable form of energy consumed by them.

In addition to receiving such a form of energy as tritium, another thing was important, too. Tritium needed to be transformed, stored in acceptable energy states suitable for using it and dispensing for both objects (including conventionally called UFO), and for biostructures, namely, those that **only** they (the invaders) managed to get them materialized for their plans and for their subsequent program needs. It was through the use of such necessary brought and transformed tritium that there was **IMPOSED** an **OVERALL PROCESS** of reincarnation of the entire construction of the energy information arrangement and the state of all kinds of water on the Planet. And through the altered complex state of water there followed the **MOST SIGNIFICANT CHANGES** in the formation, support and Control of all the complex conditions, without which the existence of any life on the Earth could not have been possible. And this is far from being all that was affected by the modified Construction of the Atmosphere gratings in all its layers. All together – it was already **NOT** that **TRUE "the World Created"** that has changed and distorted everything on our Planet. Despite that serious constructive changes with the Earth, **IT HAS SAVED** its position in the Common Hierarchy of the Planets of the Intelligent Orientation. But in reality there had been a **PROCESS** of **"IMITATION"** of development of its civilization for ***the past 18,000 years***. This conclusion suggests itself.

4.7. Variations

It is necessary to note an additional, but very important, point. The changed Atmosphere Construction was also to be such an environment in which **VARIOUS MOBILE** ground and sea placement vehicles brought by the Objects (so called UFOs) could be provided (i.e., energy attended) and freely transported by the Objects, the so-called **UFOs** performing part of the Control function of the Interventional System for **ALL** the resultant **PROCESSES** and **ENERGY STATES**, in the material world, too, including the entire biological environment. Such different types of UFOs used only tritium as their "fuel" when taking off, placed in the same medium, and moved only in the Atmosphere gratings (in the medium), which had to

be built on the basis of k-structures. ***In a different grating construction, they could not move.***

MAIN STORAGEES of the imported tritium were placed in large fresh water contents (mainly in lakes) and dosed into the Atmosphere gratings, ensuring the level of its required state. Tritium, which is in an unbound state in sea water (the Hydrophone layer of the Atmosphere), played a completely different role, but for a sea-based **UFO** was applied. Sea Water tritium was used in large quantities, in particular, by the Control Complex located along the eastern coast of the United States and Canada (the Bermuda Complex of the Interventional System). Its delivery was carried out with the help of the **CONTROLLABLE OCEAN STREAM** (current), which oceanologists called **the Gulf Stream**. This ocean current was ***finally liquidated in 2011 in order to localize the actions of the Bermuda Complex*** with its further elimination.



In addition to this, the Earth, with its entire energy capability, was also a unique by its power and **UNIVERSALITY GENERATING** source of energy. It was "forced" to provide its energy resources of the generating complex states, providing the transfer of the energies of individual octaves for the operation of various Intervent Complexes on the Moon, the Sun, and partly on the imported satellites of the Planets. In order to transfer a large volume of such generated energies and to organize communication with its "forced consumers", a special Atmosphere Construction was also required, **CAPABLE** of **MAKING** the Earth generate energy, accumulate it and at the command promptly "transfer" it. And also take its return part back in the modified constructive state and distribute it among the Intervent Complexes and Objects located on the Earth.

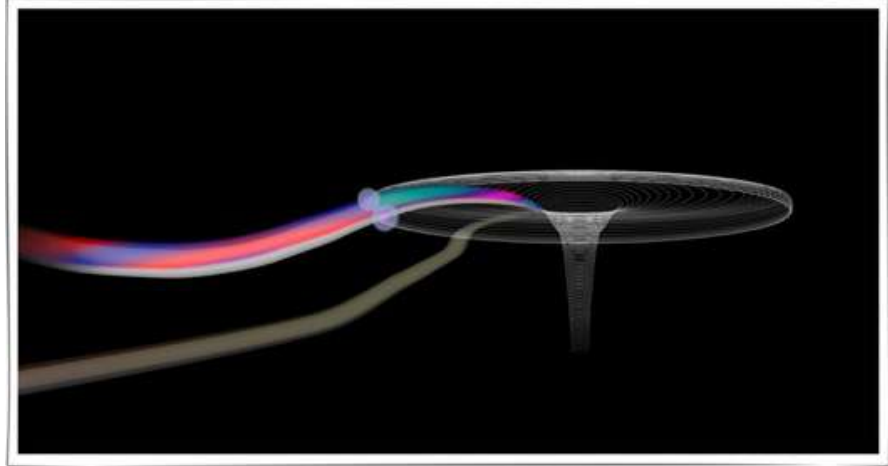

The knowledge of this was, in my opinion, the forerunner in creating **the Generator of "complementary" Energies** (I mean the Generator that was "handed over" to **N. Levashov** in France) transferred to the North-West of Russia by those who saw far ahead and the forerunner of the created by N. Levashov **"SvetL" Generator**. The functioning of the "Crown of the Sun" as the Atmosphere of this Planet, was, to a greater extent, due to the transferred energy from the Earth (in 54 octave). And the energy partially returned from the Sun (in the octave 54.25-54.35 + the mantissa, as the radiation octave) provides, among other things, "illumination" of our Planet, again with the help of the gratings Construction of the changed Atmosphere. This is not a complete list of the imposed functions that were executed with the help of the supplemented Atmosphere Construction.

I'd like to note that the northern lights are a phenomenon of the physical process, connected with the above-mentioned transfer of energies. More precisely, this is the process of afterburning of "surplus energies", previously annually for eight months specially accumulated, but left after the completion of the process of sending to "consumers" (through the **Ural Control Complex**). To store such volumes and in such conditions of energy in the Atmosphere gratings for longer time was impossible, and was not foreseen by the Interventionist System. Therefore, they had to be "burned" as **UNREALIZED SURPLUS**. So irrationally was the energy generating power of the Earth used. This is the true essence of the physical annual phenomenon (in the past), fascinating picture – "Northern Lights!" This is **NOT** the **ONLY** example of the irrational "management" on the part of the interventionists in the application of the Earth's energy potential, connected with the peculiarities of the imposed Atmosphere gratings.



In general, this complicated process of substituting the entire Construction of the Atmosphere's energy gratings in their true state for a foreign one (imposed) was **PRINCIPALLY IMPORTANT** for the Ebr System. Exactly through such changes that other habitat conditions were arranged that were necessary and suitable, first of all, for themselves, and subsequently for all those who they were able to adaptively materialize, including the people **THEY NEEDED** in the period after almost **COMPLETE ANNIHILATION** of all living things on the Earth.

It should be noted that the Interventionist System needed people in the **UNIQUE IMAGE** and surprisingly perfect Brain design, out of which it would be possible to create exactly what would be suitable and acceptable for themselves (the Interventionist Ebr System) and their further program objectives. Moreover, the Brain of the Control System, created in their own design, as a necessary set of governing their imported Complexes, Objects built on invaded territories by the Systems, the arranged communication between them, located in the **layer -4400 ÷ -2200 m**, – **ALLOWED** them **TO SERVICE** and attend only such state of the Control of the organized energies being, which the interventionists had imposed under their Programmed goals and intentions.

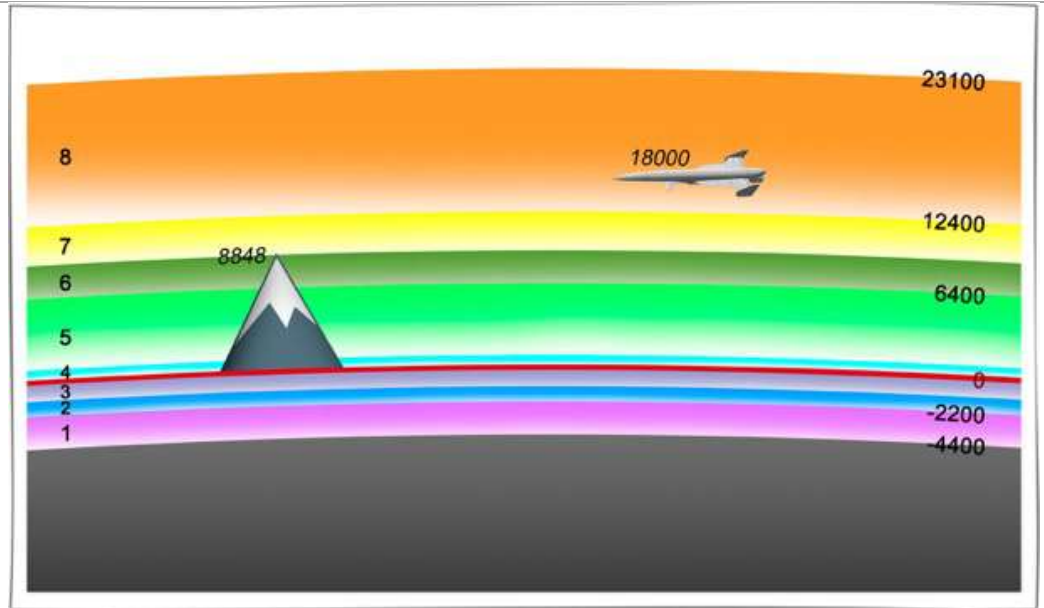

This condition and the state of the entire Control System, especially in the processes of energies being, including the development of the entire biological environment, **PREDETERMINED PUTTING** people's executive functions under the state of the imposed **MATERIAL (consumer goods) APPLICATION**. This state of material application of people attached the entire process of development their Mind **STRONGLY RESTRICTED** and isolated from the truth level and direction, dosing the information process of knowledge in relation to **ONLY INTERVENTIONISTS** general programs: *"Energy informational development of the Brain Genotype and the Development of the energy biogenesis of the flesh."* In that way the development of all the programmed processes of the imposed Interventionists Civilization was arranged and implemented, dividing its single chronoprocess at certain stages of the event-driven time.

All communication with the entire control filling for the external contact (satellites of the planets, the Moon, the Sun) was carried out in the model scale of the Earth, but only for the purposes of the Interventional System functioning, and only for its programmed development. Any other development process had been **VIOLENTLY SUPPRESSED**, and everything had been strictly controlled. For a number of reasons related to the unwilling preservation of a number of functions of the former (Interventionist) Brain Control System in order to ensure smooth adaptation in the transition of energies being to the new state, some of the **LIMITED**

INFORMATION is provided here, with the main emphasis on the functional purpose of the layered Construction of Energy Gratings. The information of the table partially demonstrates what kind of layered structure the Interventionist Atmosphere Construction has turned out.

The main layers of the atmosphere and the changes taking place in them as the elimination of the consequences of the intervention

1	-4400 M -2200 M	The Atmosphere Brain communication grating, location of the Atmospheres Brain	128 octave
<p>In this layer there were placed all the Complexes and Objects of the Interventionist System, as well as its Energy “Cords” and the voluminous structures of the energy interaction of the Complexes and Objects. Besides the Control Complex Alps 2, which will be removed after completion of the reconstruction in the 0 ÷ 1200 m layer, and Ural, which will be removed after the completion of “the Black Sea operations”, all the rest are already completely neutralized with the liquidation of their Programs, and the Objects themselves are put in dead storage. Most of them are liquidated (earthquakes).</p>		<p>The speed of the signal is equal to the "speed of light". The layer is completely blocked against the activity of Interventionist Objects and Complexes.</p>	
2	-2200 M 0 M	The hydrophone layer	88 octave
<p>The Atmosphere Control System was simultaneously located here.</p>			
3	-1280 M 0 M		88 octave
<p>The layer of water 1280 m thick was “thrown” down to make The “Flood”. There is only one type of grating in this layer but the water properties are different. The layer is to be liquidated during the transition period. and water surplus is to be energetically destroyed and the energy will be thrown into the Space (tornado, and so on)</p>			
4	0 M 1200 M	Base layer	63 octave
<p>In the layer there were conditions for the existence of biostructures materialized by the interventionists. For today: 33% P, 33% GP k-structures and 66% P, 45% GP in Di-structures. From 2011.01.07: 11% P, 11% GP k-structures and 100% P, 122% GP in Di-structures. Since 2010.12.30 the Program "Elimination of robots" and most of the materialized biostructures has begun.</p>		<p>P is the density of the electric potential charge, GP is the gravitational potential density of the charge, Os (187) is ready for elimination.</p>	
5	1200 M 6400 M	The accumulation layer	65 octave

<p>Main functions:</p> <ul style="list-style-type: none"> - the main layer of tritium treatment. All material structures of water are formed in this layer; - the layer (was) for the frequency of channels to transfer humanoids (for individuals 4xx of the Brain Genotype and other biostructures); - in the layer there are frequencies of the tritium bond with the oxidizer (structures that have the ability to bind only tritium), called oxygen. <p>For binding and water formation only O₂₁ is used. The latter comes from the Earth, it is created by decomposition of lithium (its reserves are completely concentrated in the desert);</p> <ul style="list-style-type: none"> - a grating with frequencies filtering signals is formed in the layer; (only certain frequencies are let to pass, it is an isolating medium for others); - the control of tritium accumulation. At its concentration above 122% it is destroyed to 0% by the formation of lightning. Ozone – the disintegration of not burnt tritium. For 2010.12.30 the content of tritium in the layer is 11%, which corresponds to 4-5 meters of snow. Lithium is made by the Sun, regulation is in the channels of the layer (Complex Ural). The content of lithium can not exceed the content of tritium. The receipt of O₂₁ from March 21 until December 21. The formation of water and snow is regulated by temperature; - the layer has a reference frequency of 65 octave , all humanoids 4xx came into the layer. Today there are no more humanoids in the layer, they are all thrown into the Space through the channel. Reincarnation, as the Interventionist Program, is eliminated forever! - the layer has the entire range of frequencies from 15 to 128 octave. Since 2010.12.30 there have been 33% P and 33% GP k-structures plus 88% P and 88% GP Di-structures in the layer; 	<p>The maximum wind speed is 127 m / s (457 km / h).</p>			
<table border="1" style="width: 100%; border-collapse: collapse;"> <tr> <td style="width: 20%; text-align: center;">6</td> <td style="width: 40%; text-align: center;">6400 M 8800 M</td> <td style="width: 40%;"></td> </tr> </table>	6	6400 M 8800 M		<p>61 octave</p>
6	6400 M 8800 M			
<p>- The reference frequency of the 61 octave layer (used for the Program Performance Control by all the individuals of the 4xx genotype of the Brain);</p>	<p>The maximum wind speed is 224 m/s (806.4 km/h). The whole system of Humanoid communication in this layer</p>			

<p>- has structures (garlands), providing work in octaves 21 ÷ 77. The remaining octaves have channels of passage through the layer; - All robots 4xx had a reference frequency (<i>when making biostructures</i>) of 61 octave. If it is removed, the robots will disappear (<i>annihilation of the flesh of the body</i>); - the layer was the main one for storing all kinds of insect humanoids (including those that were created before 0 year). By 2010.12.30 all humanoid insects had been thrown into Cosmos, 45% of structures in the layer have 0% P and -123.99% GP k-structures. The layer has 12 types of structures for the organization of broadband communication;</p>		<p>is completely eliminated. The process of complete stripping for the information contact with the “Konactors” individuals.</p>	
7	8800 M 12400 M	The layer of materialization	
<p>In this layer materialization of UFOs took place after their ascent through the "Lifting Tubes". <i>Their liquidation since 2010.12.31 during the transition period is final.</i></p>			
8	12400 M 23100 M	Atmosphere protection layer	Up to 512 octave
<p>Formation of "anti-gravity", the re-creation of the former "Protection"</p>			
9	23100 M 62400 M	Special Information	Up to 512 octave
<p>Formation of anti-gravity", the re-creation of the former "Protection"</p>			
10	62400 M 127600 M	Special Information	Up to 512 octave
<p>Formation of a new state of protective layers from external influences</p>			
11	127600 M 450000 M	Special Information	Up to 512 octave
<p>Formation of a new state of protective layers from external influences</p>			
12	450000 M 1284000 M	Special Information	Up to 512 octave
<p>Formation of a new state of protective layers from external influences</p>			

The functional features imposed upon the main layers of the Atmosphere can be briefly expressed as follows, without adhering to a consistent hierarchy in terms of their significance.

In the construction of a special Construction of the energy gratings of the Base layer No. 4 (0÷1200 m), all energy frequencies within the range of 12 to 224 octaves are applied, the harmonious Controlled being of which and the process of Control of such energy being together are an integral part of the basic formation that are defined as controlled **"Habitat conditions"** for **ALL** biological **STRUCTURES**, materialized by the Interventionist System, including people.

The habitat conditions for the biological sphere is a process of integrated Control of all elements of life, including executive actions, at whatever level they are incarnated (including rabbits, the density of reproduction of which were so diligently engaged many scientists in their studies).

Despite the fact that this sounds somewhat pathetic, and this should be emphasized, as if it were, from positions that are superficially based on religious dogmas, but really **"everything and all thoughts and deeds are performed in Heaven."** Within the framework of precisely these **ARTIFICIALLY IMPOSED CONDIDIONS** for the life existence, which we observe nowadays, the entire Control of the biological existence in general had been put in, and precisely from this layer of the Atmosphere, that is, through it and with its help. **"SvetL" Programs** in matters of recovery and "interaction" with the Brain are also "working" within this layer of the Atmosphere. But this is only in matters of "recovery".

Here they are, the "Heavens", specially equipped by the Creator. This is **NOT** the **ONLY**, but an influential part of the general set of elements of life support on the Earth, as such. Therefore, to the "Habitat Conditions" as the process of Control, there are also complementary but not less important elements, the functions of which are partially invested in other Atmosphere layers and even beyond, as providing and attending ones, including communication with the Moon, the Sun and the Planets satellites. All this should be referred to the **Programs "SvetL"**. It could not be otherwise, because the Generator, created by **N. Levashov**, is "inscribed" in all these partially covered processes. And **IT GOES WITHOUT SAYING** as far as **the Generator of "complementing" Energies** is concerned. Now the physics of the process is supposed to be objectively understandable.³¹

Such are the providing functions of the imposed life-support on the Earth, which are partially endowed with other layers of the Atmosphere, namely:

- governing their harmonious states through Complexes and Objects, including the Control of material and non-material states of the gas layer;

³¹ Physics (from ansient.-Greek Φύσις) – Nature.

- providing the carrier medium of energy-information translation to make governable the vital activity of living cells and their performance of strictly differentiated functions;
- providing the Programmed executive actions or realization of the individual functional allotment of each biological individual;
- energy support of their functional organized existence, all kinds and ways of reproduction;
- the functioning of the Brain;
- providing passage corridors for **α -**, **γ -** and **β -photons**, as an integral attendance of biological life and much more.

All this is associated in a single concept, which is positioned as the Controlled "Environmental Conditions".

If you carefully "get at the deep meaning" of "**SvetL**" Programs, then this is, in a way, **PERSONAL CORRECTION** of the environmental conditions, and basically – the life support system of a specific Person (the User of "**SvetL**" Programs). Thus, the Habitat Conditions and Conditions of the controlled environment are **NOT** the **SAME** as they are often confused in the current scientific and secular circles, and specially "**SvetL**" Programs. I will not detail their operation and application in relation to the owners in this aspect, since this is a highly specialized issue, which is **RATHER SIGNIFICANT**, because there have been all sorts of attempts of aggressive intent and even technical interference in these processes. They were unsuccessful, but they brought **SOME TROUBLE** mainly to those who, out of curiosity and selfishness, decided to "make experiments" with the Programs, absolutely **INCOMPREHENDING** neither the physics of the process, nor, especially, their purpose for the environment (the environment of their own life-support). But it's about **the Programs**. And as for the Atmosphere layers nowadays there are quite enough consequences of the "exploratory inquisitive activity" of insane professionals from the territory of Alaska, blindly generating technical and energy impacts of an aggressive destructive nature on the Atmosphere layers. By the way, it does not remain without consequences over the territory of North America. So let them "try" for others, but nature will also "reward" them!

It is necessary to note a very important circumstance – the state of the current natural Habitat and Conditions of the controlled environment are subject to a very **ACTIVE RESTORATION PROCESS** and **UNAVOIDABLE LIQUIDATION** of all those consequences that are connected with the past Interventionist distortion of the true Construction

of the Atmosphere grating with respect to **layer No. 4**. With all this, no common administrative, scientific, religious, as well as any individual decisions and opinions on the part of people are not taken into account, no matter how "important and meaningful in terms of their acceptance" they are.



It is important to understand that changing the natural habitat and the conditions of a controlled environment entails the necessity of changing the entire Structure of the organized people's being by means of the **ELIMINATION** of the **OLD ONE** and the **INTRODUCTION** of the **NEW** Construction. This is also inevitable because of the constructive changes in the Control and attendance of energy being in general, as well as all other consequences and changes out of the ongoing processes of the complete restoration of **Layer No. 4**. It does not depend on the opinions and any decisions of administrative structures from staff of the present dominating level, *especially in matters of preservation the present world order*. The time of eventful processes of people's being earlier defined by the imposed basics of "the benefits and satisfaction of the personal interests of an insignificant minority on the basis of violence and parasitism over the prevailing majority" **HAS BEEN OVER** and is **NO** longer **ATTENDED** by the new Control System. "Time of Reason" has come. And this is a completely different basis, first of all, for the formation of the **NEW WORLD UNDERSTANDING**.

4.8. The approach

The present Atmosphere layer (**No. 4**), with all its complex functional allotment, not only provided the **BIOLOGICAL BEING** of **PEOPLE**, but also served as the basis for the translational support for getting all the information of the cognitive and governing character provided by the System as an objective necessity for their comprehension of the objective surrounding reality. Consequently, this layer by this most functional governable presence in a program-defined degree influenced the formation of a **STEP-BY-STEP DEVELOPING** individual and public Consciousness as the basis for all subsequent programmed executive actions of people.

In what way, then, does layer 4 participate in such a complex process as the formation of Consciousness as such one? This layer is a **supercluster system** of the local-target Control for the formation of the **SPECIFIED PROGRAMMED** habitat **CONDITIONS**. It combined a number of some functions, namely:

- receiving and retaining information in a stable, indestructible state for a certain period;
- target orientation for the further identified translation for people;
- recycling of the worked out information;
- making an information structure from elemental components to a more complex one, and much more.

BASIC ENERGY OCTAVE for the construction of this layer grating **is octave 63**. It was the base octave of the Human Brain Control for **the entire group of individuals with 4XX Genotype of the Brain**. Simultaneously, it was within the limits of the frequencies of the same energies octave that a certain significant part of the **so-called external Control System** on the side of the Control Complexes and objects occurred that affected the activity of most non-reductive³² functions of the Human Brain. In addition, **TWO STATES** of the Human brains, namely, **the antineutrino and neutrino**, are structurally arranged so that the basic basis for such an arrangement of energy gratings in the constructions of these brain states is the same **octave 63** with its identified mantissas, which ensure the possibility of not destroying the format of the information received in the same octave. In this there is nothing accidental. The

³² Not weakening, constantly necessary for existence.

availability of these three very important basic circumstances provided, in the main, the complex process of the entire Control of the people's being, including the formation of the Consciousness. All these proceeded in harmony with the tact of event-driven time within the framework of the general chronoprocess as the formation of a kind of **energy-information cluster module with a temporary stability for a certain moment** (in the sphere of the antineutrino state of the Brain).

The formation of such an individual or collective peculiar cluster information and control module on the basis of the acquired information of cognitive and executive character as the Governing start for all further executive actions of individuals or groups of them is the **ESSENCE** of the **CONSCIOUSNESS FORMATION**, both individual and social. Subsequently, it is from this constructive state of the Brain that all further Control of the executive actions of the individual through his proton (material) part of the Brain is translated. The physical action of this is realized in the form of energy-biochemical processes in his environment and in the medium of the **OPERATING FLESH CELLS**. The last phase, or stage, with the help of technical means and various control methods, is observed by many researchers who are keen on the problems of the Brain functioning with different aims. Thus, in that part of the Brain that can be accessible to people for their "exploratory and experimental actions" (proton, that is, the material state) – **CONSCIOUSNESS IS NOT FORMED**, but **only its directed resulting form of influence by the individual for subsequent executive processes and actions is realized**.

But the process of the general energy-information translation on the side of the Control Complexes and Objects **IS NOT** that only "miracle-working" that formerly formed the people's consciousness. There was also a need for communication, as a complementing information accompanying programmed fragment, but who with and what with? The Control Complexes and the Objects carried only the executive function, and the Programs of the conceptual level **WERE NOT ABLE** to form. In order to ensure the reception of the information of the programmed nature from some information sources of a **HIGHER LEVEL** of governing from outside, a specific layer of the Atmosphere was formed. Such functions were endowed with the **Atmosphere layer №6**. Briefly about it..

Separate multileveled functional value had the layer of the Atmosphere Contacts **No.6, 6400 ÷ 8800 m.**, in which the Interventionist System formed **12 main types of its imposed contacts**, namely:

№	Purpose of the systemic contact functions	Liquidated	Will be liquidated
1	Contacts of all individuals of 4xx genotypes of the Brain with the Moon. (Placement on the Moon of the program "Development of genotypes of the brain" and its translation for CC to the Earth).	2010.12.30	
2	Contacts of individuals 441, 442 of the Brain genotype with the Sun (Placement on the Sun of the program "Energybiogenesis of the flesh", its translation to the Earth via CC, the subsequent functional allocation of individuals taking into account the genotypes and their geographical location).	2010.12.30	
3	Contacts of individuals of 4xx genotypes of the Brain and the satellites of the planets (some fragments of the Control Program "Development of the energybiogenesis of the flesh", including, in particular, the matter of the societies formation).	2010.12.29	
4	Contacts with the Moon: Translation of all kinds of loads for all biostructures (programmed correction of functions, reproduction, elimination, including diseases, performance of "album" records).	2011.01.02 (Start)	Until April 2013
5	Contacts with the Moon: Specialized target forms of the Programmed information for 4xx genotypes of the Brain. Governing the executive actions within the current Vector of Target, phenomena, actions and events. Introduction of "Album Records" for performers with 4XX genotype of the Brain (since 2005).	2011.01.01 (Start)	2012.04.24
6	Contacts with the Moon: The Programmed target information for Complexes and Objects. (Formation of strategies for common Programs, Vectors of Target within the framework of the Chronoprocess, translation of the Programs for the formation and Control of the Civilization development).	Until 2007	

7	Contacts with the Sun: Specifying the rate of metabolic processes for all biostructures and the tact of event-driven time (1,0007 sec.)	since 2011.01.02	to the end of 2013
8	Contacts with the satellites of the planets: Delivery of tritium from satellites (change of its energy states, storage, distribution and accounting of consumption).	Until 2007	
9	Contacts with the satellites of the planets: Loads for all individuals of the 4x genotype of the Brain (astrology, i.e. its program correction "in the image and likeness", preparation for the subsequent application for the reconstruction of the Brain and its replacement with the Interventionist Brain in functions).	Until 2007	
10	Cotacts with the satellites of the planets: Receiving frequencies potentials on 18 imported basic energies octaves. (Constructional arrangement of the Control, correction of the Programs for Systems and Control Complexes).	April 2007r.	
11	Technical connection with all developed Interventionist systems on the Earth, located above and below the layer. (Energy gratings to ensure the operation of all types of technical communications used by people)	since 2011.12.31	Until the end of 2014.
12	Technical connection for moving all kinds of objects in this layer (movement in the layer, i.e. moving within the layer gratings of all types of UFOs, aircraft, rockets, probes, etc.).	since 2010.12.31 (for UFOs) since 2011.02.20 (for the aircraft)	UFO – until the end of 2012; For the rest, for 3-4 years

The connection of individuals of **4xx (421, 422, 423, 441, 442 and 461)** of the Brain genotypes with the Moon and the satellites of the planets (functions 1 and 3 in the Table), and also for individuals of **441 and 442** of the Brain genotype with the Sun (function 2) were the most important component, out of the whole complex set of the formed Interventionist **"Conditions for the controlled environment"**. They are no less significant as well as inalienable as the main ones, since **WITHOUT THEM**, the very existence and attending Control of all the imposed

processes under the conditions of another life on the Earth taken by the interventionists – just **COULD NOT HAVE BEEN** possible at all, since the true ones had been annihilated. When considering the above mentioned connection, in comprehending its essence, one should not invest only an accepted simplified understanding of it as it is understood by all kinds of current and developed by people **TECHNICAL COMMUNICATION** for everyday life as a complex of organizational and technological measures and actions to transfer, receive and process their information . The connection of all **individuals of 4XX genotypes** of the Brain with the Moon, the Sun and the planets satellites is **IMMEASURABLY DEEPER, MORE COMPLICATED**.

What was provided with the help of such communication, and how much was it functionally important in the overall development of the imposed Civilization and the formation of Consciousness, in particular? First of all, it should be noted that such an interventional connection, but already in the energy gratings of a cubic structure (k-structure), **HAD NOT DIFFERED** in its stencil constancy of its states for the entire occurrence of the event-driven time **(18,000 years)**. It had a progressive **DEVELOPING CHARACTER** of its perfection, dictated by the overall program harmony of the whole process of its own development within the framework of the imposed Interventionist Civilization. Strictly in harmony with the imported tact of event-driven time, there had been a **CONSTANT** process of **COMPLICATING** not only the essence itself, but also some kind of "technical perfection" of the entire System of the Controlled being of the brought in energies octaves. Even the very construction of information, as it is, had been perfected and brought to the imposed version of a digital basis. People have taken it as the transition to the digital basis of their technological excellence. ***But it is to be liquidated soon.***

There had been a gradual process of achieving harmony of such being of energies, education and perfection of the imposed Interventionist Mind, **STEP-BY-STEP RIG** under the ideal likeness of supposedly "True Civilization of the Earth" and so on. This, as the highest end in itself, had been primarily pursued by the Interventionist System. For without such an artificially created "likeness to the supposedly Civilization of the Earth", the very stay and all efforts to seize the Earth would have been in vain. They (the interventionists) would not have realized their **STRATEGIC GOAL – PENETRATION in the artificially created by them image of the "illusory similarity of the Earth's Civilization"** to the General Hierarchy of the development of Civilizations for the Planets, possessing

living conditions of the Intelligent orientation. A simple penetration into the structure of such a Hierarchy of the planets **WAS IMPOSSIBLE** for them, since they would have been **LIQUIDATED** immediately by a more powerful and perfect "impact from outside." Independently, i.e. without the capture of the Earth and the subsequent illusory civilizational image of similarity, like the *System of Planets of a different destiny*, they were **COMPLETELY ISOLATED** from such a form of perfect development of their own Civilization with the subsequent possible penetration of the whole chain of similar planetary formations into the General Hierarchy of Civilizations in general.

Of course, this is beyond any Hollywood fantasies on the theme of "Star Wars", but in reality it is incommensurably higher than any limits of scale opportunities and abilities of such imaginations by the Brain of people. Especially under the conditions of their being in the **INTERVINED MATERIAL** application. Most of the informational inaccessibility for people, both in cognition, and in comprehending the truth about everything that has been happening, was **ORGANIZED AND ARRANGED ARTIFICIALLY** in such an illusory manner as if *everything had been happening in a natural way*.

Moreover, the Interventionist System, on the whole, possessed an insufficient level of development and "technically laid-out perfection", in contrast to the Planets, possessing and endowed with the conditions of life of the Intelligent orientation.

I have already mentioned in detail that the Earth, being a complex strictly identified planetary monocluster, had all the necessary set of energy-technological complex state (*independent*), but Ebr Interventionist system did not have such a concentrated governing "completeness" on any of its delivered Planets. The interventionists just needed such a Planet as the Earth, also because it was a single interplanetary cluster complex for its development for all the forthcoming *eight stages of civilization development*, and they could create for themselves conditions for their **PROGRAMMED EXISTENCE**. Therefore, the Interventionist blow was **INFLECTED** against the **WHOLE** Model complex. But after this seizure, the **GENERALPROCESS** of self-arrangement began, and not only on the Earth. Therefore, the entire connection, which was re-arranged and formed by the Interventionist System in this layer of the Earth's Atmosphere (No. 6), had a **SPECIAL STRATEGIC CHARACTER**, and its functions, especially of support (through communication) the imposed Habitat and the controlled

environment, were of **PRINCIPAL SIGNIFICANCE**, not only for the primary materialization of people and governing their executive actions in the Program framework, but for the implementation of all strategic objectives of the intervention in general.

4.9. Biological sphere

LIQUIDATION OF THE CONCEQUENCES of the intervention itself is very complex and subtle, but it is basically the **SYSTEM LEVEL** processes, without involving people in it.

In the future, we are going to confine ourselves only to the framework of the formed connection of the Atmosphere layers that were organized to attend the Habitat, the Controlled Environment, and only in the part that directly relates to the biological sphere, including the being of people, as well as the Control of their executive actions in the Programmed processes of development of the **EMPOSED CIVILIZATION** with their violent involvement in all these processes. Everything that concerns Programmed Governing development Processes conditionally called "nature", i.e. Flora, fauna and so on, it is, in itself, **NOT LESS** meaningful, complicated, but also necessary for the existence of people and their cognition of the natural environment in future, if people get aware of living in the future.

Partially I showed the importance of the Programmed connection with the Sun, the Moon and the satellites of the planets, not only on the technical side, but also on its role in the general **PROCESS** of **DEVELOPMENT** of people's **CIVILIZATION** and the Consciousness development, both the individual one and the public, in particular.

First and foremost, it was through this connection that the **COERCIVE HOLDING** of people's executive actions in the state of their material use over all Programmed processes controlled by the Interventionist System had been **PREDERMINED**. And accordingly, this resulted in the step-by-step preventive development of the individual and public consciousness before every historical eventual executive step.

The formation of consciousness was carried out by the practical provision of all the necessary information of a "strategic and current" nature, which for a long or short period were translated to Complexes, Objects and ***the formed Control Systems***. The latter, in turn, through the energy-information translation from themselves, governed i.e. determined all

subsequent conditions of execution and the necessary commands related to the construction, development, functions and the arrangement of the energy-informational translation for people and their Brain development for a long period of their **ALLEGEDLY "NATURAL" PERFECTION**. It was through such Program directions, like commands, that the process of people's development that were materialized by the Interventionist System took place.

This, to a certain extent, is sufficient to understand the importance of the Atmosphere layer 6 itself and the imposed connections through it with the Moon, the Sun, and the planet's satellites. If you look at the history through the accomplished actions and events, then, indeed, there is a **CONFIDENT IMPRESSION** of a sort of the organized sequence of development. People have an unquestionable confidence in the "naturalness" of the historical development of the perfection of their life arrangement. The history of civilization can be expressed in eight words: ***the more you know, the more you can***. But I 'd like to add here that ***the less you know, the more you believe***. **Faith without knowledge is dead.**

Chapter 5. Deliberate knowledge of the unknown

Learning without thinking is useless, but thinking without learning is dangerous.

We are inclined to think that human knowledge is progressive, because the more we live the more we learn. Thus it should follow that our grandfathers **KNEW LESS** than we do, and great-grandfathers **EVEN LESS. Another theory is also plausible.** Perhaps, at different times we learn things from different sides and in different ways, and this throws new light on all the mythology that we are now using everywhere? Myths are not dead; we just understand and use them in another way. Much of what we do not understand, we try to turn into "myths", **because we want to believe more and learn less.** I am satisfied that for many Users of "SvetL" **Programs** the interaction of the Consciousness and the material world in cognition no longer seems to be fantastic. **The consciousness is energy in its subtlest and most dynamic form.** This helps to understand **why our fantasies, mental images, desires and fears** influence the real events, and explains how the image created by the Brain materializes. You just have to **LEARN** to **THINK**, too Modern scientists, for example, **THINK DEEP** instead of **THINKING CLEARLY.** To think clearly, you need to have sound mind, but you can think deep and be completely crazy. **But this is strictly my opinion!**

5.1. Wanted Necessity

Ask yourself the question – what is that subtle event-driven all-embracing harmony that gripped all the peoples of the Planet, what strict observance of the event-driven tact in the stage-by-stage process of development, how could all this be perceived by people? As if a truly **SEQUENTIAL DEVELOPMENT** took place, including the development of the Cognition itself! Who **CONTROLLED ALL THIS? Some historical figures?** How did it come that people with a gradually changing interest in cognition perceive the surroundings with surprising impermanence? But it was exactly at the appointed event-driven time that they turned their

inquisitive eye to some **SPECIFIC FRAGMENT** of the **UNKNOWN**, "examined" it, and finally "received an element of supposedly more perfect knowledge" as another step in their world view development? Why then for thousands of years was it to torment people? Might it have been better to learn everything at once and immediately, that is, much earlier? But who opposed or controlled this process?

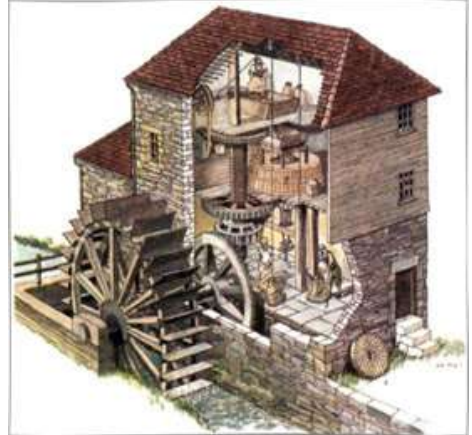

Before the expedient time, no one invented or created anything, was not able to surprise with any extraordinary discovery of the World. **Everything was done, discovered, invented and applied strictly with the tact of the programmed requirements for the general Civilization development of people.** Simultaneously, that was also an important part of the Target Vector of the **FUTURE PHENOMENA**, actions and events in that part that somehow related to the Civilization development with the usage of people. Not their development, but the development with their usage.

Was there any element of randomness in this stability? Of course, there was **NOT ANY RANDOM**. This was the way the entire communication system of the Atmosphere **layer No 6** worked and manifested itself, realizing two strategic programs: **"Development of the Brain Genotypes" and "Development of the Energy Biogenesis of the Flesh"**. And they thought and ate, and were geographically settled, and socially equipped, and almost all obediently took everything for "naturalness" of the surrounding habitat, and **worshipfully³³** accepted **DEFICIENCY OF WILL** and **VIOLENCE** towards themselves, etc.. Everything only in line with the Program, including the very formation of Consciousness in all its forms of life manifestation. Skeptics may object to it by demonstrating, as evidence, some fragments of deviation from the generally prevalent level of event **processes, rebellion or disobedience on the part of SOME INDIVIDUALS** or groups of them. After all, there were plenty of them in the history of many countries. How should one perceive the assertion of some kind of controllability from the outside, imminent **obedience** in action and resignation to one's fate, i.e. some kind

³³ Obediently.

of control program? Skepticism, especially with the demonstration of separately extracted historical facts, is possible, but the scale of the individual and the corresponding scale of his (skeptic) judgments depends on the **SCALE** of his own **CONSCIOUSNESS**. As soon as all the historical processes of any research are brought to the all-planetary scale of judgments, then, at once some randomly formed fragments of history become **INSIGNIFICANT**, and they can be neglected.

But let us return to the contacts with the Moon and the Sun touched upon in the previous chapters. It is necessary to answer many questions, of which, as I see, there are plenty. The communication was with the Complexes located on the Sun, the Moon and the planets satellites. They were carried out, as already mentioned, through the "Communication Tubes", operating on certain energies frequencies, including gravitational communication and interaction on a permanent basis (according to the design of the energy gratings – similar to **Shukhov television tower** in Moscow). But they were made active for their application only with a **CERTAIN PROGRAMMED** periodicity, depending on the level of urgency and the importance of information transmission, adhering to the strict tact of the event-driven time. Incidentally, it is not only in a certain way, but **ESSENTIALLY INFLUENCED** the peculiarities of the process itself and certain time expressiveness of the organized people's being, taking into account:



- their geographical and other differences;
- a certain iteration in carrying out various mass historically important events;
- observance of certain traditions, holidays and some other rituals that form a certain way of life for the people of some current historical stage.

An insignificant example is a spiritual ritual "**Epiphany**", **Epiphany water**, etc. It was on January 19 that **THE PROGRAM**, determining the energy-informational complex state of water, **WAS PREEMPTED** for a whole year from the Moon complexes at a strictly

certain time. And here – with the corresponding full subsequent correction of all its states. To be more precise, the anticipatory changes in water occurred in the period from **October 21 to January 18 each year, and on January 19**, programmed information was transmitted from the outside about its state for the whole year. Annual correction of the energy information state of water directly predetermined **SOME PROGRAM PECULIARITIES** concerning the Program "*Development of the Energy Biogenesis of the Flesh*".



For the whole year, the specific features of the metabolic processes of a living cell with the integral active participation of water in all its states or for all people on the planet or for certain groups of them differing by geographic or some other feature were determined. The geographical settlement of people in certain areas, very seriously affects their state, for example, their health. And especially it is noticeable, when people move over long distances today. For example, with a change of residence "*SvetL*" **Programs** in these processes are a significant help, but they, to admit it honestly, can **NOT ALWAYS** solve the required problem concerning the user's moving, I want to emphasize, over long distances, changing continents, for example. But I am going to talk about it later.

And now back to water – how and in what way does the state of water affect the entire flesh of the human body? In what way is the harmony of the energy states of the flesh cells with the states of water achieved? All this is a true **WONDER-WORKING MISTERY** that must be known to the true essence and taken into account in people's being! Each geographically different territory, and, accordingly, each group of people settled on it, need "**THEIR**" **SPECIFIC WATER**. It is very important today. Those who like

to drink bottled water – I do not recommend doing it. Horns, of course, will not grow, but you **WILL** exactly **NOT BE TAKEN to the Bath**.

On the other hand, *through the correction of the energy-information state of water, the certain program changes were laid*, which were necessary under the program the "**Development of the Genotypes of the Brain**" These are even more complex processes which were involved in the fragments of a certain predetermined selection and potential activation of the future executive work of such individuals with specific genotypes of the Brain, who were to be involved in some general or particular actions or events throughout the whole coming year. "**SvetL Programs**" also "provide" for "**DEFINED FRAMES OF CHANGES**", which are now needed by the Brain, and the flesh cells. These Programs are "short-termed" and personal, for a particular User, or more precisely, his Brain. That's why the recommendations on "structuring" the water with the help of Complexes and "Bracelets" were worked out and given to the Uses. But I'll tell you all about it in detail later.

Strangely enough for a layman, but in such processes, **NO DECISIONS**, opinions and wills of leaders of any level or representatives from the social sciences were **REQUIRED** and not requested. But for reaching a specific feature of Consciousness (mainly social) for a particular period, this energy-informational state of water influenced in a significant way. In the scientific and secular circles there has been an unanswered question up to now: "*In what way and what kind of changes took place in the states of water every year*". Strangely enough, this change in water causes **tritium in all the diversity** of its energy states! *Why do we need water for biostructures in general and, what does tritium have to do with it* (especially from the table of Mendeleyev himself)?

5.2. Tritium, the Bath and the unknown ...

So what is this Tritium? Let's take the publication – "The Great Russian Encyclopedia" Vol. 5, p. 168. «**Tritium** ^3H is a radioactive hyper-heavy radionuclide of hydrogen with a mass number 3. The half-life period is 12.35 years. Under ordinary conditions, tritium is gas, $t_m = -252.520^\circ\text{C}$. In combination with oxygen, tritium forms hyper-heavy water of T_3O . The

isotope indicator is part of the thermonuclear fuel. Today, thermonuclear reactions can be carried out only with the explosion of hydrogen bombs.

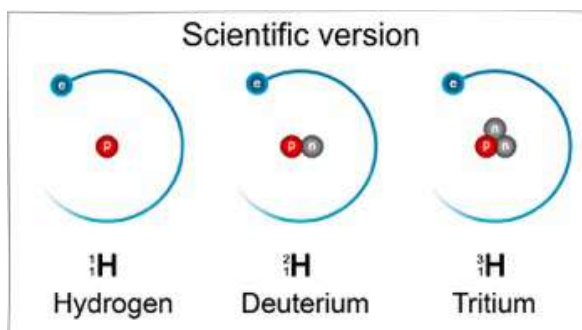

It is accepted to think that tritium *is an isotope of hydrogen*. Let's look at the table.

Name	Number of gravitational layers	Number of electronic layers	Number of outer gratings	Starting magnetic pulse
Hydrogen	2	-	1	-
Deuterium	3	2	2	1
Tritium	8	36	8	36

Modern science has an idea of any chemical element in terms of the gravitational layer presence. ***If potentials of the layer are set to nil, the element does not exist.***

Tritium: the filling of more than 2 electronic layers with the simultaneous relieving of potentials from gravitational gratings converts tritium into **NON-INERTIAL MASS** with the possibility of subsequent use as fuel. All the radiation octaves are included in the electronic layers. The outer (gravitational) grating is of **32.62546258** octave, the following is of **53.66**. If its potentials are relieved then tritium burning differs from the burning of hydrogen and deuterium. The beta-minus decay is caused by the decay of the outer gravitational grating and has no relation to the electronic layers.

Deuterium: the zeroing of the tritium grating transforms it into a stable state with regard to the outer environment, with the minimum number of electron gratings being **2**, and, so that it does not spontaneously ignite, there are **3** outer gratings (octaves 53.66, 51.66, 32.62546258). The outer grating determines the **LIQUID STATE** of deuterium.

Hydrogen: the presence of only gravitational layers and the radiation grating (32.62546258 octave) **DOES NOT ALLOW** using hydrogen as fuel (for thermonuclear synthesis), since there are no electronic layers, and the

outer contours of the gravitational gratings are taken for the running electron and the jumping proton (which can be weighed).

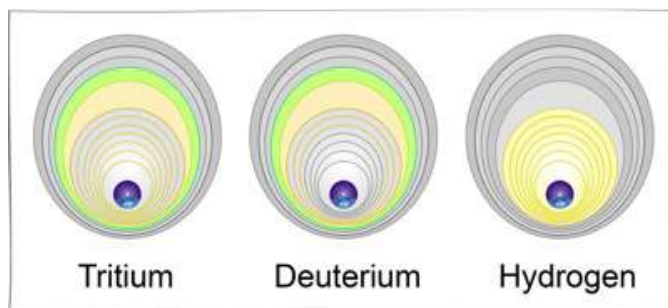

Thus, the **BASIC ELEMENT** is **TRITIUM**, and deuterium and hydrogen are its isotopes. **Hydrogen can not be converted to a state of non-inertial mass.** I note that **ALL 3 ELEMENTS** is **ONE ELEMENT** with different properties, depending on the state of the gratings.

The number of tritium isotopes = $2^{44}-1$ or **17,592,186,044,415**, one of them is hydrogen. Out of this variety it was necessary to have only 2 isotopes for objects (UFOs), 15 isotopes for movement in the Space and **only 1 isotope** for the water formation. The use of other isotopes for the water formation is excluded because of the incompatibility of the frequency limits.

Tritium exists in the liquid state at a temperature below - 253°C. The solid state is unknown. Tritium was fuel for all types of objects (UFOs). Liquid tritium was used, expenditures (for those who are interested) are listed in the table of objects (UFO). Tritium reserves are **NOT INFINITE**, no nature creates it.

To create tritium, there were **SPECIAL INSTALLATIONS** (Generators – Complex objects), which produced tritium with its subsequent dissolution in water, and therefore, all objects (UFOs) were **LOCATED NEAR** reservoirs. Any object (UFO) was able to process water and separate tritium in the amount necessary for the Program implementation.

While spending tritium, its reserves were replenished by generators. This maintained a permanent working state of all objects (UFOs) on the Earth. I am drawing your attention to the fact that all the planets satellites in the Solar System have their own reserves of tritium. Many satellites serve as tritium warehouses, the reserves of which make it possible to travel anywhere.

The minimum norm of tritium in water is **0.00000064%**. When the tritium content is **less than 22%** of this value, the generators start making tritium. If tritium is completely removed from the water, its specific weight

is 0.77 g/cm³. Today, "modern science" **DOES NOT KNOW** the actual structure of tritium and its properties. In its pure form, tritium can be separated **ONLY** by the **GENERATOR** of the Complex object.

What is now taken for tritium is a cubic grating framing a structure containing octaves up to 96. Actually, the grating itself has a gravitational basis, therefore the content can be weighed; that is, the weight and, accordingly, the content of the grating itself in the water are determined. The contents have a **NON-INERTIAL MASS** and can not be weighed. Tritium outer grating has an octave of **32.62546258**. **Deuterium and hydrogen** have similar grating and you have already make sure of it.

Tritium radioactivity is determined by the grating of **53 octave** (2nd electron layer). The norm for this layer is **2%**. The structures inside the grating are **dodecahedral-icosahedral formations** containing octaves **from 53 to 96 inclusive**. Due to what then does water get the necessary density, and what is added to the bond with oxygen? Upon contact with the structure of tritium, oxygen receives an additional gravitational atom, that is, gets "heavier", with breaking the bonds this property disappears. Therefore, it is believed that tritium in water is of hundredths of a percent. However, ***tritium takes up almost one-third of the space in the structure and changes physio-chemical properties of oxygen in the bond.***

5.3. Why do biostructures need water?

Water is necessary for biostructures only in order to **DERIVE HIGH-OCTAVE COMPOUNDS** ("living water"). Here, the brain receives all the necessary frequencies reserve (non-inertial mass) **and uses it for its vital functions**. It is important that, despite differences in genotypes, water **"SUITS" EVERYONE**. ***Everyone gets out of the water those frequencies on which exactly his brain works.*** A man is not able to live without water for more than 3-5 days, he must constantly **HAVE** some **REPLENISHMENT** of tritium structures. Sea water also contains tritium, but in it there are no frequencies that the Brain needs.

Water, purified from a part of the non-inertial mass, is thrown away out of the body in the form of urine and sweat. By the way, by the difference (***initial water – urine***) urine analysis can show the Brain structure. In it there are those frequencies that the Brain **DOES NOT USE** (promising

diagnostics). That's why "recommendations" (regarding water "from the tap") were given **to all users of "SvetL" Programs**, "to structure" water by the Complexes and drink it as much as possible. The effectiveness of such use is already **UNDOUBTFUL**.

The Kailas Complex regularly (every Tuesday) checks the Brain for compliance. There just "put a mask" on the incoming code (the effects of masking the code are a separate topic). The operation takes **microseconds, and for 4 hours the entire population of the Earth is tested**. Every year a standard of water ("Epiphany water") was set in accordance with the Brain, which it was primarily intended for. So, if the Brain received a new (higher) octave, then in tritium this octave had a maximum of potentials, and the potentials of the remaining octaves were reduced to an effective minimum. Outwardly, the water looked the same (it could, for example, change the color to green), but basically it had new frequencies. It happened each time when starting a new program. A **100 years old water**, and the water that was available before January **2015**, **SIGNIFICANTLY DIFFERED** in the structure of non-inertial mass. **In January 2015, this process was changed**. But this is another story that you can get to know by reading the materials of the **Research Institute of CPS (the Centre of Preventive Strategies)**.

To those who are interested in archeology. If you drill a well in Antarctica and stumble across an "ancient underground lake", keep in mind that the structure of the **NON-INERTIONAL** mass of that water is the same as on the surface, since the common grating on the Earth is unified.

What is **"dead water"**? This water has **ONLY GRAVITATIONAL FREQUENCIES** of tritium. If the brain receives such water, it is forced to spend its **OWN RESERVES** to throw such a "gift" out of the body. In critical situations, such reserves may not exist, and then water becomes a poison. **On throwing away urine and sweat, the cubic grating remains**. Then what is tritium for the objects? The Space grating structure is dodecahedral-icosahedral with zero potential, framed with a cubic structure **of neutrinos and antineutrinos**. When moving in space, the object (UFO), having magnetic frequencies and electrical potentials, had to give them out saturating the grating of the Space. However, it is possible to give out something **that is in the same structure**, otherwise the change in the angle of phasing³⁴ will just lead to heat death. Any object (UFO)

³⁴ Conversion to another type of grating.

moving independently in the Space has to have either a **magnetolectric generator** to generate tritium, or tritium reserves **with octaves up to 96** (the higher the octave, the lower the flow). The Space **DOES NOT NEED** gravitational octaves; they are left in the object (UFO). The effect of friction is more noticeable, the farther apart types of gratings are. (When skating on the asphalt in skates designed for ice skating, you will not go far.) The same is true in the Space. **Receiving and giving gratings have to be identical**. But it's all in the Space, everything you need there could be carried inside the Moon, for example. But while moving, a cone of motion is formed, into which tritium is discharged.

Why did the objects (UFOs) need tritium on the Earth? Only for lifting from the main power bus of the Earth and return. The depth of location of UFO objects **reached 4200 meters**. Modern builders use a powerful machinery for laying tunnels. **One object (UFO) was able to dig a tunnel deep to 4200 meters , while its only tool was tritium**.

The lifting and landing Complex after the "rise" or "return" commands from the point of location and to the surface of the Earth created an **ANTI-GRAVITATIONAL TUBE**, that is, removed potentials from the cubic grating all along the entire length of lifting or landing of the object (UFO). This was **NOT** done **SIMULTANEOUSLY**, but in sections (**usually 200-300 meters**). Since all the materials (Mendeleev's table) have a cubic grating or close to it, there was no problem to remove an electric potential and magnetic pulse. The rest was done by the object (UFO). Any element in its structure has the same Space grating (dodecahedral-icosahedral), but this grating has no potentials (they are =zero). If you start saturation, the chemical element begins to change properties (**out of granite, for example, you can get platinum, and this is not a joke**). However, if the saturation exceeds a certain limit, then the **ENTIRE STRUCTURE** gets the **PROPERTIES OF THE NON-INERTIAL MASS** (similar to the cavity of a working neon tube). Through this cavity a ball lightning – object (UFO) slipped. When the next site was reached, the passed section was transferred to its original state. It was precisely for the formation of a section with a non-inertial mass that tritium was necessary. Deuterium is not suitable here, because the gratings are incompatible, and instead of a non-inertial mass they could get a burn of unknown nature. When entering the surface of the Earth, an atmospheric grating was used for motion, and the flow of tritium was minimal (tens of thousands of times less than for lifting and landing).

Why does it **NOT HAPPEN** an explosion (of a hydrogen bomb)? Each object has its **OWN GENERATOR** of thermonuclear synthesis, working on the principle of a village stove – the more the damper is opened, the more powerful is the ejection of potentials. By the way – this is one of the conditions for the functioning of **OUR BATH**, where many of you have already begun to strive for.

I note that the simplest thermonuclear reaction you can get at home if you throw a piece of **Na³⁵ into water** or on wet soil. Not only is it burning, it might also explode. In seawater, there is no burning or explosion, but a smell of sulfur appears.



Of course, luckier were the objects of sea basing. They moved in their native environment, the formation of traffic tubes required minimal tritium consumption. They **WERE ABLE TO FILL UP THE STOCK** while moving (the description from Baron Munchhausen – about the horse that cannot slake its thirst, because it does not have the second half).

Where does tritium come from? As noted, the Space grating has a certain structure. To move through this structure, it is necessary either to scatter electric potentials around and supply them with magnetic impulses, or create a cone of motion. The height of the cone is billions of kilometers. For navigation, planets' satellites are used (motion calculation, cone formation, orbit correction). Tritium is dumped only in the cone of motion, and therefore there have to be its reserves. However, all the Solar System planets have complexes of pyramids, and some of them are intended for

³⁵ Sodium is an element of the first group (according to the old classification – the main subgroup of the first group), the third period of the periodic table of chemical elements of DI Mendeleev with atomic number 11.

processing Space debris. Those debris, first of all, are neutralized by bonding with the oxidizer (beautiful high-altitude clouds), then frequencies are added for shaping, and we receive drops of water. You must not drink such water (you can water the plants, but the plants begin to pull the potentials of the atmosphere grating intensively).

To give water the necessary qualities, there are special Generators, whose functions include **SATURATION OF TRITIUM** with all the necessary frequencies, after which the oxygen-bond structure **IS USED** by **EVERYONE and EVERYTHING**: people, animals, insects, plants, objects. For tritium formation the following complexes were brought and set up:

- **the base complex** – the control system for magnetic, electric and gravitational pyramids;
- **the basic complex** – the control of working complexes;
- **the working complex** –the accumulator, control, working emission.

All the complexes are serviced by "robots", which were **SPECIALLY CREATED**. The control of all the processes, formation of orders is carried out only by that who *has 96 octave of the Brain* (including all life-support octaves). In addition, it has as many matrices as it is necessary for the execution of the Program.

	Name of the center	Location	Number of magnetic pyramids	Number of electric pyramids	Number of gravitational Pyramids
1	Base complex	Chekhov, Russia	252	156	56
2	Basic complex	Suez, Egypt	446	121	33
3	Working complex 01	Gabon, Africa	211	327	21
4	Working complex 02	Kenya, Africa	121	211	27
5	Working complex 03	Kalimantan, Indonesia	334	623	43
6	Working complex 04	Nauru, Pacific Ocean	523	273	61
7	Working complex 05	Ecuador, South America	336	433	12
8	Working complex 06	Brazil, South America	338	211	23

9	Working complex 07	Tyumen, Russia	232	734	242
10	Working complex 08	Altai, China (Chinese Wall)	451	523	161
11	Working complex 09	Solomon islands	226	832	281
12	Working complex 10	Switzerland, Europe	128	243	31
13	Working complex 11	Kailas, Tibet	621	817	341
14	Working complex 12	The Kola Peninsula	134	111	17

The result for those wishing to get to the Bath:

1. Tritium is the most unknown element on the Earth.

By changing only gravitational gratings one can obtain **256 different stable chemical elements**. By varying the potentials of the gravitational gratings within the tolerance range (from 2 to 124%), we **OBTAIN ISOTOPES** possessing the properties of alpha-beta and gamma decays. By adding at least one electronic layer, we also obtain a chemical element emitting photons, for example, phosphorus or actinium (face-centered cubic grating, luminescent spontaneous beta decay).

2. Tritium in the Space **DOES NOT HAVE** potentials on gravitational and electronic gratings. In addition, there are no outer control gratings.

3. Each electronic tritium grating has a dodecahedral-icosahedral structure. The addition to the outer contour of the cubic structure does not lead to changes in the inner structure.

4. Combinations of outer cubic gratings (not nested in each other) lead to the formation of various outer forms (such as triclinic and others).

5. Any chemical element can be converted into a state of non-inertial mass by removing potentials from the outer gravitational grating. This is an important point for understanding the "work" of "SvetL" Generator.

6. The standard of tritium in the water structure **is set once a year by Greenland Complex**.

7. Significant changes in the structure of water occur **from October 21 to January 18** (taking into account the annual changes that have occurred), here with the peak of mortality occurring in November, and still **NO** changes **ARE EXPECTED** yet.

8. Water obtained by processing Cosmic tritium, consistently passes saturation with the necessary octaves before it reaches the Earth.

9. Water cycle in nature can be **OBTAINED ONLY** in a saucepan or in a bath, that is, in a confined space. In our Bath all this is "foreseen", but the cycle is **NOT NEEDED**.

10. Water evaporation from water basins does not lead to the formation of precipitation or at least fog. These formations lack a significant number of octaves, which are formed by generators in the upper atmosphere, so the resulting vapor is simply dissipated, and the rain is a **CONSEQUENCE** of the **INTENSIVE WORK** of the Generators. Moreover, when there is overheating of the main bus, it has to be cooled, and vapor in the form of dense fog envelops entire areas. It is true, here, **DO NOT WORK** computers, somehow, but few people pay attention to it.



11. Since a chemical element without a gravitational mass **DOES NOT EXIST** (can not be seen, touched, and, more so, sold), science, in every possible way, avoids it.

5.4. "Bright" future

I shall touch upon a certain "bright" future, first of all, in relation to the current and subsequent changes in the energy-informational states of water. I have already mentioned that, starting with **2012.04.24** (the change of the Control System), **NO MORE** tritium has been **DELIVERED** to the Earth from the planets' satellites. Its volume with a decreasing tendency is kept due to the insufficient generation with the help of Generating objects imported and located in certain places of the Planet by the Interventionists System.

But then – what about people? ***Are they doomed to death because of this in the near future?*** It's hard to write like that, but – yes, they are **DOOMED** to the **IMPOSSIBILITY** of their existence in general, **UNLESS THERE ARE** changes towards a **SIGNIFICANT INCREASE in the octave of their Brains!** This is one of the mysteries of the whole essence, related to the recreation of Man! About "**SvetL**" Program I can only say that this is a chance. You will come to this understanding, attentively reading the book to the end.

If a Man is recreated to the previous state of the Brain by raising it to ***at least the octave level of $96 \div 124$*** (and the present one is maximum of **64 octave** for single individuals), then the necessity for the compulsory presence of tritium in water (in all its necessary energy states) falls off. The Human Brain will be able to ***energy replenishment from the energy gratings of the Di-structure of the environment.*** In this case, people need water only to support **SECONDARY** vital **FUNCTIONS** of the flesh cells (creation of the "native type" of tritium for the true drinking water will be made in another way). But this is only possible for the people who are defined as being directly integrated into future. But what about the conditionally integrated group of people (**adaptation through $3 \div 5$ generations**), how do they survive? This issue, which can not be solved through saving water with tritium, acquires a **SPECIFIC STRATEGIC VALUE**, and **ANOTHER SOLUTION** is provided for this and that is not in the public information version. I can only say openly that "**SvetL**" **Programs** are of direct importance in this process today. And this is one of their basic functions. We discussed it with Levashov, and initially everything was "done" within the framework of reincarnation of the Entity, which was eliminated once and forever as the Interventionist Program. **Since 2012, NEW PROGRAMS** have been created that are adapted to today's realities in this matter.

There is no doubt that in the near future there will be many talented researchers who will be able to cover this highly-specialized issue from the true positions and with more detail. And today some try to "get down" to this, but there is not much knowledge so far.

Water is **NOT THE ONLY** sacrament that was realized through the communication channels formed in **layer 6** of the Atmosphere. Let's return to the question of Consciousness, touched on in the previous chapter. In what way exactly did this communication, arranged in the Atmospheric layer

No. 6, determine the most important states of individual and social Consciousness that are apophatic for people?

How could it suddenly change or deviate from its steady state? How was the Control process carried out? Why was such a huge variety of states of Consciousness manifested not only in the scale of the Planet, but even on the territories of specifically expressed States with the same geographical and climatic conditions of being and so on? The variety of questions of this nature is simply unlimited by its quantity. Those are the questions that until now **NEITHER social science, NOR psychology, NOR theology, NOR any other specialists of other scientific directions ARE ABLE to answer, just as they are not able to give an answer and, in fact, understanding of what TRUE CONSCIOUSNESS is.** The fact is that most of the answers can not be found without the **COGNITION** of the very **ESSENCE** of the created programmed communication for people in the Atmosphere gratings of layer **No. 6** (communication type No.s 1, 2, 3).

5.5. The Essence ...

All programmed orientation directly for the development of the genotypes of the Brain was completely controlled through the CC (Caucasus, Alps and California), and the medium for transferring information was constructed **in the gratings of layer No. 6** with additional participation in layer **No. 1**, where the Brain of the Control System is located (a little later about it). Only such a finely controlled harmony with strict interaction and observance of the differentiated functions of layers **No. 1** and **No. 6** (communication type No.s 1, 2 and 3)³⁶ allowed the Interventionist System to implement a complex process, including:

- programmed development of people's Brain;
- formation of their Consciousness at each specific stage of the general event chronoprocess;
- using groups of people in carrying out specific program activities;
- direct "purposeful" participation in the development of the entire **IMPOSED** Interventionist Civilization.

³⁶ A.M. Khatybov – "Principles of Governing".

I will not go into detail, and there is no need, describing the subtlety, the current essence and the peculiarities of the social Consciousness state for the individual social formations of each geographically different territorial dispensation, since the revisionist re-examine of the entire "written history" today is likely of no interest for us. But, nevertheless, I am going to touch upon some important historical fragments, since we are to cross over it, in accordance with the logic of understanding.

The communication with the Moon, the Sun, and the planets' satellites was **NOT DIRECT** (or a group of them), because the Brain of people was not able to possess such complex (in terms of power and function) abilities, as receiving and then subsequent decoding and application of information .

All specific program information related to the Control of the development of the whole biological sphere in general was received by **Control Complex (CC) Kailas-1, 2**, and all the planets communication control was carried out by the Control System of the planets located under the territory of Ethiopia. Communication with the planets' satellites, receiving and transmitting information, providing communication tubes, coordinating time, monitoring the movement of the solar system and other operational functions – all these were assigned to this Control System (CS). After reception of the information from the Moon, the Sun and the planets' satellites, its decoding and, depending on the purpose, functional orientation, urgency, sequence of execution (and other factors), **CC Kailas FORMED** and **TRANSMITTED** the information (as governing) to the **CC Caucasus, Alps and California**, as well as to other Complexes and Control Systems, if their actions required any correction or participation, including correction of environmental conditions suitable for people existence or governing their actions in specific conditions and states of the environment.

This malty-leveled process formed and provided the bulk of the most complex System for the translation of energy-information **GOVERNING SUPPORT** of people's development. This excluded any mutual translational interference, distortion, provided a ***strict address information identification***, up to bringing it to specific individuals or the appointed society from them, in particular. Not everything was smooth and perfect, there were some failures.



A very **IMPORTANT INDICATOR** of the consequences of this fact of insignificant distortion and failure is the *manifestation over the past two decades of a great number of people of non-traditional sexual orientation, i.e. so-called "blue and lesbian" in the world society.*

This kind of sexual "mutation" occurred, because on the side of the true Earth Control System, *since 1995, an active process of eliminating part of the basic programs* of the former Interventional Control has been under way. As a result of the interference in one of them, previously conducted by the **Kailas-1 Complex** programmed systematic correction of the Brain functions for 4XX individuals of the Brain genotype began to make **ERRORS** in the **TACT** of this complex process development, related to the **REMOVAL** of the **NEUTRINO** state of the Brain of **SOME INDIVIDUALS** in a certain regularity with subsequent checking, correction and its return. As a result of this tact errors, many males were *imposed upon the function of "feminine attraction to reproduction" and vice versa.* It was done without any control but with identification.



By the way, it was noted that the males, who received the functions of "feminine attraction to reproduction", acquired similar to women **"lunar" tact of changing metabolic processes** ("critical days"). **These failures were previously observed but they were not of a mass nature and had an inner pathology in the Brain functions of the individual.** This is an insignificant example of the importance and peculiarities of the communication types of **No.s 1, 2 and 3**, but also as the fact that much has changed the society of people and their being. However, those kinds of "individuals" were created purposefully, too, to ensure the solution of specific tasks in the governing people and processes in the historical perspective. **N. Levashov** wrote about these "individuals" in more detail. The fact is that in such "individuals the hypophysis is **INCREASED** three or four times compared to an ordinary man. And this makes them good executors and easily governable. Here one could write a lot on this issue, but I **WILL NOT**, considering it worthless. One thing I'd like to note that **St. Valentine day**, imposed on us and our youth is a confirmation of the fact **that this "action" was supposed to involve as many people as possible.**

The imposed structures of energy gratings on the basis of **k-structures**, introduced by the Interventionist System as basic ones, predetermined the manifestation of certain consequent limitations and complications in the governing process itself in many spheres at all stages of the Civilization development. They displayed themselves in various degrees of mentally frenetic "ecstasy" through everyday existence of people – from serene indifference and massive deathly depression (plague in Europe) to

bestial fanaticism (civil war in Russia, Stalinism, fascism in Germany, an insane passion for profit through violence on the part of individuals from the territory of the USA and England, etc.).

Out of the whole complex of such difficulties, I will only touch on the problematic limitation, which was **NOT** only **EXPLAINED**, but also **NOT ALLOWED** until the collapse of the Interventionist Civilization. This is an unconditional commitment in the "pyramidal" construction of irreversibly increasing violence in the governing of the entire mode of life and being of people. It would seem, at first glance, how and in what way, could this problem have to do with the formation of Consciousness both public and individual, and, in this case, the Atmosphere layers, as well? But before going on with the coverage of this issue, it is necessary to be defined about the constructional peculiarity and functional **dispensation of the Atmosphere layer No1.**

5.6. Specificity

In this (the first) Atmosphere layer the ***Brain Communication grating of the Control System and the Brain of the Control System itself are located.***

If we consider this layer from the point of view of the technical complexity of its arrangement and the scope of all technological concentration to ensure the necessary program energy-information translation as part of the cluster control system, then it occupies a **LEADING PLACE among the other layers.** But if the significance is determined from the point of view of its place in the general hierarchy of the integrated functional dispensation of all the Atmosphere layers in general, then the leading positions of this layer lose somewhat in the scales (in comparison with the other Atmosphere layers), because this layer is essentially significant mainly for secondary derivative processes of the control and attendance of the whole biosphere being. If this layer is considered only within the framework of the problems of the governing organized being of people, then it **IS** the **PRINCIPAL** element of the cluster control system of all **EXECUTIVE ACTIONS** of people, including the implementation of the strategic programs of the Interventional System: ***"Development of the Genotypes of the Brain" and "Development of the Energy Biogenesis of the Flesh Cell"***.

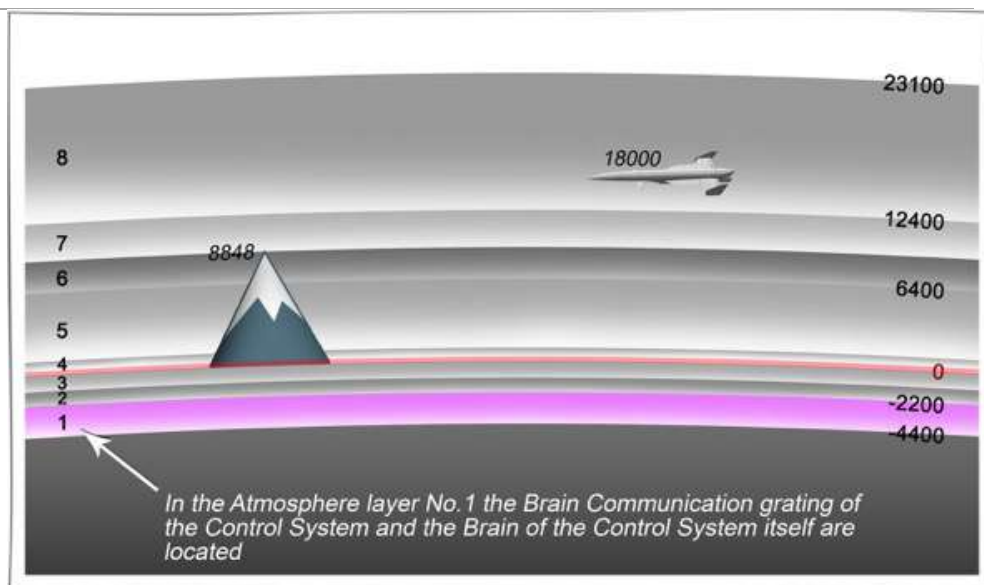

Before talking about the influence of this Atmosphere on the formation of people's Consciousness I'd like to remind you that in the previous chapters there was information on how **the Control System Brain was arranged** through a reconstructive interference of the Interventionist System. Here I will show the way it was presented in a **general constructive arrangement, namely:**

- Basic Control Systems (26 CS);
- Emergency Control Systems (32 ECS);
- Formation of "weapons" (48 SFW);
- CS Automation;
- Solar and Lunar Complexes;
- Main and Auxiliary Control Complexes;
- Objects (there were all types of objects and UFOs, 7909 units.);
- Control Systems;
- nodes ("rotations", superpositions, "stores", life support Systems);
- **Energy "Cords"** and volumetric structures of energy interaction of Complexes and Objects.

The Target orientation to the functioning of the Control System Brain was aimed at:

- the formation of constructive harmony between the imported elements of the energy grating construction (K-structures in the range from 15 to 128 octaves) and previously laid **NATURAL** model **COMPLEX** of energy gratings (Di-structures within octave of 12 to 512);

- Ensuring the harmony of the combined energies being to create **ILLUSION** of **CIVILIZATIONAL DEVELOPMENT**, that made it possible to hide artificially imposed harmony in place of the previous programmed nature endowed with the Earth at its formation;
- creation of **THEIR OWN HABITAT** and the **CONTROLLED ENVIRONMENT**, suitable for an acceptable **TEMPORARY LIFE EXISTENCE of all the created and imported substances (including biological ones)**;
- development of the imposed Mind of the captive Planet and the mind of the people of their own creation, brought into the obedient state of **their material goods usage** to provide the illusion of the development of the Civilization of the **INTELLIGENT ORIENTATION**, but for their own programmed aims;
- the program code to the processes **"Development of the genotypes of the Brain" and "Development of the energy biogenesis of the flesh cell"** in the interests of introducing a significant correction in the Human Brain structure commensurate with the interventionist **BRAIN LIKENESS** of different functional level (**spiders with the stopped evolution of the protein mind**), on the one hand, and dispensing people's flesh cells all living states, which can be provided by their existence under the control of such a Brain, on the other hand, and other less important orientation.

Any ideas of people about the Brain as such have traditionally been associated with biological Entities, comparing its constructive code more often with outer material attributes and parameters, determining the perfection of its functional capabilities by some "bestowed" abilities, characteristic mainly of entities with conscious or instinctive actions and so on. Is such a privileged "rising" in people's own esteem over the nature of themselves to be honored (meaning the Brain of people)? **IT TURNS OUT, IT IS NOT**. As an example of our mistake, I cited in the second chapter the brain of a cockroach, to which this kind of brain is enough to fulfill its functional endowment in a biocontrol system-collecting information on the state of the biological environment. And there are countless examples of this, and not only in the biosphere, but also in the field of flora. It does not matter. It is only important **that the Brain, as a cluster system formation of energies in inertial and non-inertial states, is created for some operations of governing, control, and analysis, and possesses the ability of perfection in certain permissible limits under someone's control of a higher level of formation**. The same can be

attributed to **the Generator of "SvetL" Complex**, which was also created as a systemic formation of energies, but only in a **NON-INERTIAL STATE** and possessing, most important, the **PROPERTIES** of **SELF-PERFECTION**, but, as it became clear from the practice of application, within the Brain System Control in direct interaction with the Owner's Brain. For example, such especially distinctive signs of the Human Brain as **vision, speech, hearing, smell and another achieved "perfection"**, are available in the Brain Control System, too but in a **MUCH MORE DEVELOPED** and perfect state! In this I was convinced directly when creating **"SvetL" Programs**. All the created **Programs**, so to say, **"have been inspected"**, but not all **"WERE PERMITTED"** for some reason or other. Sometimes I had the feeling that over me there was **"a kind of "Eye"**", which was "sniffing "and" eavesdropping ", as if I was doing something **WRONG** or there was no solution in this or that matter. But when there was a **REAL NEED** in the prompt creation of the **Program** for a specific life-support event, the **"TIP" CAME IMMEDIATELY** in various forms of my understanding – from visual-graphic reproduction of the required solution in the Brain to the appearance of a "running line" (if you can call it this way) on the computer and my automatic repetition of this information in printed matter (almost automatically alphabetical display).

And when there was a need for interaction with the Generator transferred to Russia, the required solution began to manifest itself in a visual graphic manner, which made it possible to display all this in the entire splendor, for understanding, or at least for a real vision of the processes at a simple and accessible level. The same can be attributed to the work of the **Vyborg periphery of the Urals Complex**, the "start" of which was marked by the so-called "Chelyabinsk meteorite".

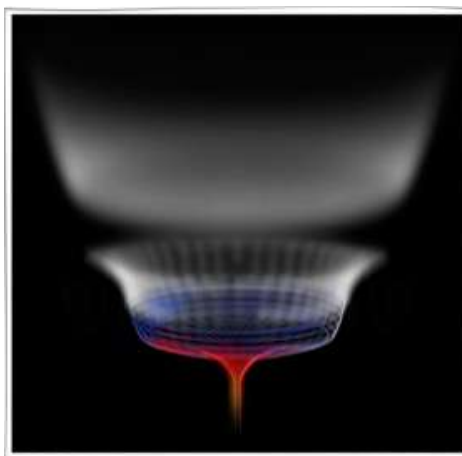

5.7. Pyramidality

Studies of the detailed past constructive and functional capabilities and features of the Interventionist Brain Control System is a separate fundamental direction of science of the near future. At the moment, **NOT THIS** is the principal goal in understanding oncoming events. I will only take a superficial account of these features, and we will specify its factorial and functional elemental presence, which significantly influences our past being within the framework of the Interventional Control.

We will consider only those elements of the Brain of the Interventional Control System, which, **directly** through the control processes, were **INFLUENTIALLY CONNECTED** with the targeted use of people in the development of the Civilization imposed upon them, and thus the formation of their individual and public Consciousness, in particular.

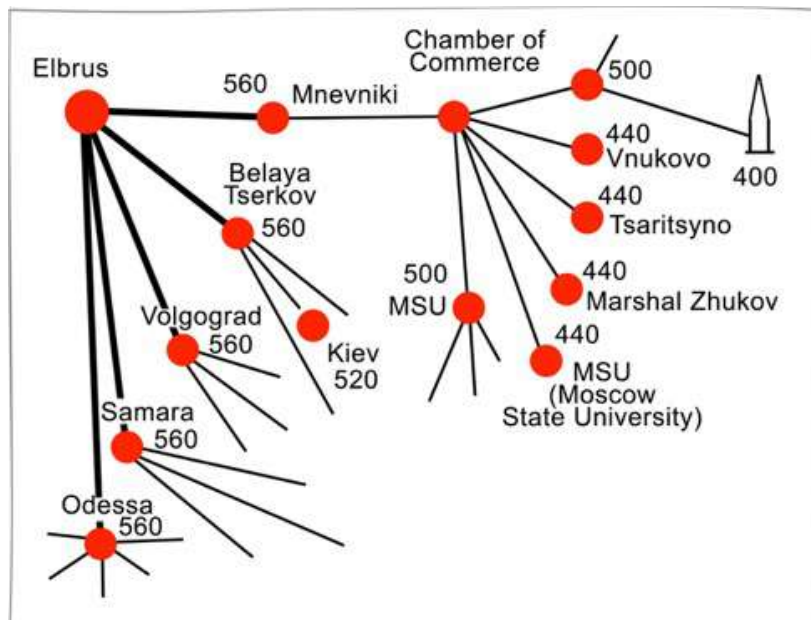

The above graphical linkage of information energy translation demonstrates the **SEQUENTIAL DIAGRAM** of the **energy downlink interaction** between the specified objects. By positioning the programmed controllability arranged on the principle from “**the higher to the lower**”, one can show the causal basis for explaining the true essence of the imposed “**pyramidal**” construction as the only “**stable design**” of the **PEOPLE’S SOCIETY CONTROL** at **ALL STAGES** of their previous existence under the Interventional Control System.

The imposed energy control sequence provided for the following: ***The Control Complex "Elbrus" every Thursday ordered all complexes of type 560 to start accumulating potentials and transfer all accumulated potentials, including control information, to complexes of type 520 (as a telephone distribution node), complexes of the type 500 (energy conversion terminals), complexes 440 (objects, weapons or UFOs), complexes 400 (a node information hub for controlling people's executive activities through churches, Catholic churches, mosques) and control servers.***

It is only a ranked element in the hierarchy of subordination of **DIFFERENT LEVEL OBJECTS**, depending on the imposed on them program function, i.e. their importance in the hierarchy of the Control System. In fact, the picture of the overall governing construction through the Systems, Control Complexes and Objects is much **MORE COMPLICATED** by its **VERSATILITY**. ***The whole construction is really*** pyramidal and in harmony with this design, there was arranged the corresponding pyramidal structure of the **CONTROLLED PEOPLE'S BEING**. The control of people's executive actions was carried out through the energy information translation from the Control Complexes through all types of Objects according to their downward functional importance, bringing the control signals and information to **SPECIFIC INDIVIDUALS** according to the descending hierarchy of **their division by the Brain genotypes (from 461 to 421 genotype)**. In accordance with this pyramidal constructive imposing Control process, in the course of all historical stages of the society development, on the part of the Control System through energy information translation there was imposed and ensured the formation of the corresponding public Consciousness for practical executive actions. This consistent downward translation explains that **BLIND OBEDIENT STATE of the overwhelming majority before an insignificant minority**, humbly taking all forms of violence, including the **IMPOSED PARASITISM** in all its forms.

For each historical stage, the specific programmed state of the public Consciousness was imposed upon, corresponding to the stage and taking into account:

- targeted historical features of each stage of "development";
- the framework of Vectors of Target, actions and events;

- functional-territorial dispensation of societies in a specific geographical area;
- features of the programmed current "recipe" for the selection of society (a set of society in each territory, taking into account the mandatory availability of individuals with a specific genotype of the Brain) and much more.

I have tried to convey all this to lots of reasonable people, in my opinion. However, on their part, it looked like an unreasonable intention, like an **UNVERIFIED NONSENSE** of an indefatigable fantasy. But if we take as an example a fresh historical episode of **the beginning of Perestroika in the USSR**: up to now an **INEXPLICABLE** something that affected like the all-destroying wave all spheres of the tuned up social and spiritual life of the peoples of the Great Country, that possessed unique immunity to survival under the most difficult conditions of the surrounding counteraction, can not be explained from the "materialistic" positions of the worldview: **"In what way and why has the Civilization of Communist type collapsed»?** And that was just an **ORDINARY PROGRAMMED PROCESS** of the Interventional Control System and **NOT MORE** than that. And it was performed with varying degrees of zeal by everyone without any exception. Even individuals ***with especially red party cards*** that had previously possessed the granite fortitude of the communist worldview and the corresponding humane public Consciousness! Where has it gone from the head?

At the moment, we are not going to consider the features of the public Consciousness at each historical stage of "development" in all separately expressed and geographically different societies. With this in mind, historians and social scientists will be able to correct all of their written **HIZTORIA** with **ANOTHER** comprehension of its progress, by bringing it closer to the truth of the Control of people's being. But I have a lot of doubts about it. Perhaps that will happen in some perspective. For me it's just important to demonstrate, on the basis of my knowledge, in what way the model cluster control system for shaping public consciousness was arranged, **including** the Atmosphere ***layer No. 1***. It was **NOT ONLY** governable, but was imposed upon people strictly conforming to the formation of ***certain event processes through their Consciousness*** orienting their executive actions precisely to what that had been defined by the Target Vector of ***phenomena, actions and events***.

When considering the functional and constructive features of the above layers, we were convinced that their **BASE-DETERMINING** influence on the formation of the Mind of people, their individual and public Consciousness is *a very multifaceted process, governed within the framework of the systemic code of the civilization "development" program* and completely independent (apophatic) on people's will and desire. Consequently, it required a **CERTAIN CONTROL** on the part of the same Control System.

5.8. The Control and Atmosphere layers No 2 and 3

In the cluster system formations of the Governing, the control, as a compulsory element and at the same time a reverse control principle, is an **ESSENTIAL CONDITION** for the stability of the closed-loop control. In what way, in which layers of the Atmosphere, was the reverse control formed?

Before talking about control in general, it is necessary to make some framework limitations within which this question will be considered. We have already determined that the Earth itself is a **MODEL COMPLEX** represented by energies *in the inertial (material) and non-inertial (non-material) aggregate states in the range of 12 to 512 energy octave* for the current stage of its civilization development, being the first stage of the endowed Program for its development in general. And the very programmed existence of the Earth is a controlled process, i.e. its existence is embodied through a complex **GUIDED BEING**³⁷ at all levels (octaves) of energies. That means that control should cover the entire complex of the guided processes of energies being and is the subject of separate, profound studies. Here we consider only those processes of the energies being and the corresponding control that are **DIRECTLY CROSSED OVER** with the Governing and control of the organized people's being. For the complete understanding the whole structural complexity of the organized people's being control, influence on the Mind formation, and individual and social Consciousness, we will be helped while considering *the design features of the Atmosphere layer No.s 2 and 3*, which are (according to their particular function) in close connection with the previously considered Atmosphere layer No. 1, where there is the Control System Brain, and, in

³⁷ Not to be confused with Being from the Old Testament

particular, its **120 control Systems from 18 the Earth Control Systems**. What are the structural and functional features of the Atmosphere layers No.s **2 and 3**?

The Atmosphere layers No.s **2 и 3** are located at a level of $-2200 \div 0$ meters. They simultaneously constructively hold the Hydrophone layer ($-2200 \div -1280$) and the Atmosphere Control System layer ($-2200 \div 0$). The location of the Hydrophone layer concerns not only the seas and oceans, but also the continental part. The Control System layer is also located on the entire surface of the **Earth's geoid**. The water layer of 1280 meters thick was "thrown down" in **the process that was described in ancient sources as the "flood"**, but in fact, the Interventionist Control System threw down the **WAIST OUT ENERGIES** from the destroying energy gratings of **Di structure** (the 28th native octave, water octave) in the process of changing the Atmosphere structure.

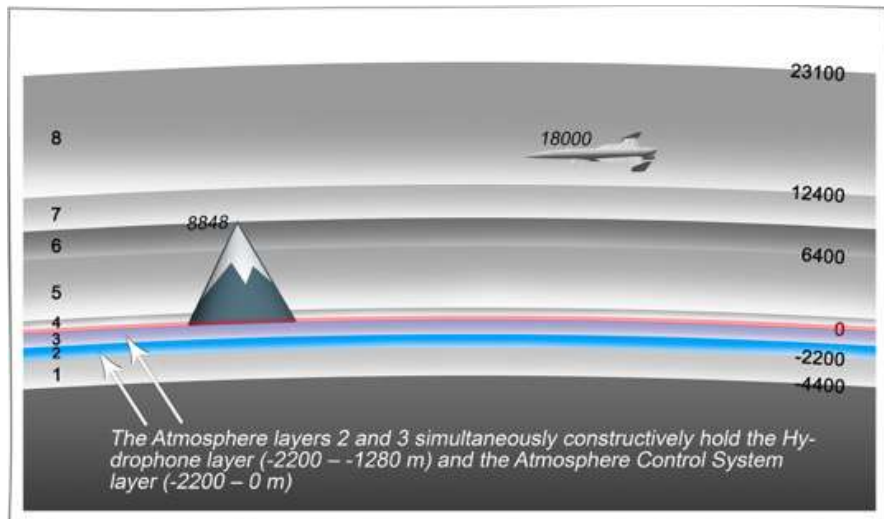

Similar things happened **in 2013-2015** around the world (powerful floods, heavy showers and tsunamis) and especially in the Far East of Russia. **It was "dumping" of the waste energy from the destroying energy gratings in the process of changing and restoring the Atmosphere structure into its pre-Ebr state.** The process **HAS NOT FINISHED** yet and "is being carried out" smoothly, so to say, without much damage to the Life Support System of people and the Planet as a whole. All the weather changes that we have been observing for several years are the consequence of these processes. So the Hydrometeorological Center has nothing to do with it.



The common for the entire planet hydrophone layer (**layer No. 2**), being a functionally specific part of the Atmosphere energy grating, is structured in such a way so as to ensure the exclusion of all **RANDOM MIXING** of different types of water and keep in a steady state the type of water that, according to the functional- territorial dispensation is to be in a specific geographical area. This explains the **DISTINCTLY DIFFERENTIATED** both in salinity and in other features and conditions of sea and ocean waters, the presence of such closed seas with salt water, like the Caspian or Aral Seas, the freshwater Gulf of Finland, strictly separated from the main part of the Baltic Sea, and many other things. The Control for the formation of marine and ocean currents is also carried out through the Atmosphere Hydrophone Layer. The functional endowment of each stream is strictly different, and all kinds of fables about the causal basis of their existence, based on temperature differences across layers and regions, other causes of purely physical nature, is the **ENTIRELY FALSE UNDERSDANDING** of **THE TRUTH** and the significance of their functional endowment in the overall System of the Control the Processes of Energies Being on the Planet. Earlier unexplained examples of non-randomly formed natural processes and phenomena with the controlling participation of the Hydrophone layer No. 2 are sufficient.

In addition, through this atmosphere layer there were carried out:

- processes of transferring control information on a sufficient level of saturation with tritium sea and fresh water;
- providing with tritium as the main energy replenishment, with its targeted "delivery" to the Control Complexes and Objects (there was the Gulf Stream for the CC Bermuda);
- formation of the energy information state of fresh and sea water for a year, and many other things.

Moreover, the Hydrophone **layer No. 2** does not take a passive position in water formation, which is carried out in the other upper layers of the Atmosphere. It is not interested in the yield indicators in the fruit and vegetable production of the average geographical region or the quantitative changes in the herd in the Prairies. But keeping the minimum state of the water level, it **WILL NOTICE** and **INFORMS** of the danger.

What is it all for and exactly this way? What for are those complicated subtleties, and how does it relate to reasoning about individual and social Consciousness? Does not it seem to a man of the world that this is an artificial pulling of the connection between one topic of judgment and another? Unfortunately, for the majority (and this has been recognized) of the townsfolk, whose world view is based on the **SIMPLE** populist **WORLDLY CLAIMS** that "*Moscow is surrounded by Russia*", or all the subtleties of the metabolic processes of the flesh sell *are governed by the successes in business of American McDonald's restaurants, and the Generator and "SvetL" Programs* "have gone" together with N. Levashov, – everything looks **EXACTLY LIKE THIS**. But the truth of the "*World Created*" and *today's realities are absolutely different!*

Very many processes of natural development in the ocean area and the continental part of the territory, which, as if **developed by people** in the interests of their everyday life with a certain degree of satisfaction in their sufficiency and comfort, are taken by people for the development of the "*Natural environment*".

People are so used to their supremacy over their "conquered" nature that to a certain extent they "have lost the sense of proportion", they monotonously bite the "philosophical stone" invented by them and do not remember what they live for and how long their **ALL-DESTROYING AGGRESSIVENESS** is going to be tolerated by this "conquered" Nature. Moreover, most of them are completely **UNINTERESTED**, even at the level of curiosity, whether the forming natural processes are *spontaneous or something governs them*. With what degree of utility for people is the

development of such processes proceeding? People consider themselves to be somewhat unique, and the whole theory of being is built on their uniqueness. One is their unit of measurement, but **THIS IS A MISTAKE**. All systems invented by people are just a sketch. **One plus one equals to two – that is all we have learned**. But one plus one **DOES NOT EQUAL** to two. There are no numbers and no letters at all. We have pinned these labels to somehow simplify our life, make it more understandable; we have made up a scale of measurements to forget about our immeasurability. Despite the lack of such understanding among the majority of people, I am still confident that it is necessary, and exactly today, to open to them some secrets concerning the **PROCESSES** of **NATURAL ARRANGEMENT** of the environment, the governing of which was realized with the participation of the Atmosphere Hydrophone layer No. **2**, too. in a primary or secondary way, affecting the being of common biological environment in general, and in addition, determining the implementation and attendance of the Program **"Development of energy biogenesis of the flesh cell"** of humans; and simultaneously, controlling the organization and execution of event processes in society, and, correspondingly, shaping their public Consciousness. This can not be **UNINTERESTING** for those who, despite everything, picked up the **"big spade of Knowledge"** and started "digging through" with the spade, at least in order to get into the "waiting room" with the prospect of having the **"cherished Bath"**.

This Hydrophone layer is endowed with a great number of control functions and requires an **INDIVIDUAL DEEP RESEARCH**.

Some of these functions, which we will talk about later, were "put" in the **Generator** and in the **Programs** for interacting with the Brain, controlling the ongoing changes in the transformation of the User's Brain, making him healthy and adapted to the rapid changes in the environment. But for now, we will deal with all that relates directly to the provision and attendance of the specific being of people and their participation in execution of the programmed actions and events. To do this, we divide the considering Control and attendance functions assigned to this layer into **symbolic two groups**.

12. Functions of the controlled co-operation in regulating the changing sufficiency in humans in providing them with proteins and minerals of the natural origin from the seas and oceans for their every day life activity under the Program "The development of energy biogenesis of flesh cell".

This function is extremely significant, as it is an important element of the overall **COMPREHENSIVE PROCESS** for creating life-support conditions of the entire bio-environment, including people. Let us consider this control function concerning **ONLY** the **EXISTENCE** of people.

It is well known that proteins and minerals play an important part in the cell life, the natural origin of which, in the required quantity and state of their harmony, are formed in the life-giving and vegetative forms of their existence in the aquatic environment or with the participation of water. The whole process of the "natural" formation of biological Substances from their inception (in the ionic state) to their perfection (in the flesh), maintaining their essential development in the necessary changing state, regulating the quantitative and assortment states, providing migratory controlled movements or retaining in the limited regional isolation (at least with respect to the variety of all fish species) – all this is the **GOVERNING PROCESS** on the part of the Control Complexes and their servers through the energy gratings of the Atmosphere Hydrophone layer (**layer No. 2**). The primary process of approbation in utility and sufficiency for all the necessary proteins and minerals formed in the aquatic environment and on the continental part, ensuring harmony of the metabolic processes of the flesh cell, was **EXPERIMENTED with the Mayan population**. Until now, a wide range of fish stocks of the most popular fish species are kept locally without migrating along the coast of this area of their former settling as one of the simplest secrets of this region and this settlement.

All migratory cyclic movements of fish masses, route "transportation" error-free, timely seasonal "delivery to the areas of consumption," assortment and quantitative regulation – the governing all these processes was carried out by the Control server located under **Mahe island (Seychelles)** in the Indian Ocean. It is for this reason that the migratory "journeys" of many fish species begin from this oceanic zone.



All the secrets of regulation on keeping in the proper "marketable" state for the necessary assortment of fish species (assortment regulation and distribution of the required species according to functional-territorial, i.e., geographical dispensation) were carried out in a concealing way through the **Easter Control Complex (CC Easter)** located under **the Easter island, the Pacific Ocean).**



It was this Complex that, receiving information on the current development, the necessary requirements and the accompanying conditions

for the implementation of the Program "**Development of the energy biogenesis of the flesh cell**" from the Kailas Control Complex, anticipated all the processes of selection control of the "fishery" on the Planet. It was on its part that the program process for the development of certain species of fish was set: in what evaluation condition for protein and minerals it should arrive in the area of its "consumption", what areas it should visit with specific mineral salt "brines" in their specific ionic state in order to give themselves a proper "marketable" condition of their consumed essence, and much more. Its "decisions" the CC Easter passed the Control server of **Mae island** for the governing the migratory transport processes.



Isn't it talented and touching?! What kind of care! This explains some previously unnoticeable casuses. Pacific herring for some "unknown reasons" and strong-willed orders of "party leaders" was supplied in great amount to the western regions of the

great and vast country, and Atlantic herring, the other way round. It would be necessary to take into account the whole "inexpediency" of such an act, taking into account the transportation costs, but this was done exactly that way and **only at a certain period from August 28 to January 19!** And for the rest of the year, the government took special care of the "child hatred" – fish oil. The Party **WAS NOT ABLE** to answer the question on the imposed "expediency" of such an act then, and especially now, because of its absence as such.

Seizing the occasion (and the logic of the proposition), I would like to ask political scientists, "the creators of historical events", an important question: ***on which day did "patriotism" come to an end over the entire post-Soviet space*** and with the help ***of what volitional action of the leaders?*** As a clue here is a leading question: ***when and who issued the decree on abolishing free provision of preschool children's institutions with fish oil?*** The same question concerns the officials with purchased certificates of various degrees and ranks fighting "pseudoscience" with ***all their proletarian hatred, BUT FOR WAGES.*** And what do fish, seafood and public Consciousness have to do with all this? The matter is not in the fish, but in the fact that the **SIGNIFICANT PART** of the Planet population, oriented to satisfying the vital need of their flesh

through the assortment (according to the program of "Energobiogenesis") of **CONSUMABLE PROTEIN** and minerals obtained from seafood, with all the necessary living conditions created for them, form a specific image of their existence in harmony with all the features of the life and social code, their inherent worldview, the corresponding individual and social Conscience. Crabs are **NOT** vitally **IMPORTANT** to metallurgists from the Urals, although being very tasty, and their absence in the ration of metallurgists will not cause any **DECISIVE PROTESTS** among them; which can not be said about the inhabitants of the seaside regions. The matter is not only in this fact. All the niceties in the fact that individuals with different Brain genotypes and different functional roles in the overall process of executive participation in the program **"Development of the energy biogenesis of the flesh cell"** are based on various sources of protein and minerals for the organism according to the strictly differentiated form of their natural origin, both of marine and continental.

For a **LARGER PART** of the **POPULATION**, the formation of conditions for the strategic memory in the body (bones) is realized on the ionic basis of minerals formed in the aquatic environment. In this case, for individuals of each Brain genotype, there is **THEIR OWN** strictly specified model **CONSTRUCTION**. Therefore, the lack of consumption by individuals of the required minerals and proteins suitable only for them, will lead to violations in their necessary quantity in the ionic state for flesh cells, **including for their Brain**. No less significant for the activation of certain functions of the human brain are phosphorus ions, acquired especially when consuming fish. Accordingly, this essentially affects the general state of the Brain, the maintenance of its functions in the active state, and, consequently, the processes of **GETTING KNOWLEDGE**, formation of an individual Consciousness. This directly affects the processes of shaping public Consciousness through organized actions and events, since the latter will undoubtedly be corrected through the controlled processes on the part of the Control System, perhaps even through an aggressive manifestation of violence or in some other form of practical actions, if there are such deficiencies in seafood. Any practical actions are always preceded by the formation of the concrete public Consciousness for all those who are involved in such actions **on the part of the opposition, i.e. for those who are paid and with "pseudoscience."** ***The Black Sea Fleet sailors' uprising on the "Ochakov" cruiser under the leadership of Lt. P.P. Schmidt in 1905 and similar events are not related to the***

lack of seafood on board, because the original cause should be sought in the executive organizing activities of the Comintern.

I would kindly like to say at least to a reasonable part of the US population that the non-programmed substitution of the consumed proteins and minerals (with soybeans products instead of seafood) has led not only to the **IRREVERSIBLE DISORDERS** of all metabolic processes in the body of Americans and to excesses in weight, but also to very serious problems with **BRAIN DEGRADATION**, and to the aggressive behavior of the major part of the society. And this literally affects the formation of individual and **public consciousness**.

This is principled and in short, but quite enough for understanding the first group of functions of the Hydrophone layer, as a factor demonstration of its **GOVERNING INFLUENCE** on the Consciousness of people in the process of their organized being.

5.9. Need for thought

There was a completely different, but no less important, level of influence in the **second group of functions** of this Atmosphere layer.

13. Functions of the "guide and safekeeper" of the part of the governing energy-information translation, coming from the Control System Brain as a whole, concerning the executive nature of the material usage of people, formation of their actions and events within the framework of both strategic Programs: "Development of the Genotypes of the Brain" and "Development of the energy biogenesis of the Flesh cell".

It is not intended here to consider the whole complex of the second group functions of the Hydrophone layer, through which the **TRANSFER** of part of the energy-information translation **WAS CARRIED OUT** on the consistent realization of the entire historical Vector of Target of phenomena, actions and events of the entire vast geography of the world, since only the demonstration part of them is important and sufficient today, which, directly or indirectly, had a relationship to the formation of the people public Consciousness. I hope, many volumes of future research will be devoted to those processes. We will consider only some of the facts of the participation of the hydrophone layer in these processes.

Looking at the map of the World, showing the current results of everyday development of the continental and sea (oceanic) part of the Planet's surface, one can be surprised at the **INEXPEDIENCY**, on the one hand, and surprising harmony, on the other hand, in matters relating to the overall distribution of the Planet Population, the formation of a great number of artificial continental, coastal and offshore structures that provide a certain level of sufficiency in governing all spheres of organized life of the peoples of the Planet. This demonstrates to a certain extent the **DEVELOPMENT LEVEL** of the present civilization, the very process of which is realized through the ongoing interstate strategies of various geopolitics' directions. It was to such a **PHILISTINE LEVEL** of judgments that all social **THOUGHT** of the being was "**TRAINED**" without raising any doubts about "its essence". But is it true in the sense of everything that has been realized?

It seems somewhat defiant (and for someone, even offensive) to learn about the fact *that people were not independent* both in choosing their places of settlement and corresponding all creative actions in getting settled, and in the implementation of **ALL** historical eventful **PROCESSES** of any scale, the realization of which they have been taking to this day for **THEIR SELF-HISTORY**. The entire process of the events realization took place *under the supervision of the Interventional Control System*. It applies to all peoples and all places, where they are now settled. What kind of role and function did the Atmosphere Hydrophone layer perform in this process of the Control? For example, the governing effect of the **Bermuda Control Complex**, as part of the Brain Control System (**Layer 1**), and its translational impact through the Atmosphere Hydrophone Layer (**No. 2**) on some of the major eventful processes taking place at least with the participation of the US, Canada and Mexico population. Whatever the Americans position themselves, in their whole "history", as the "honored leaders" of the modern world order, they are all **ARTIFICIAL GENERATION** of some *imposed events for almost 400 years of history with the Bermuda Control Complex participation*. No deserved selectivity and initiative on the part of the so-called European colonization – **in the 16th century**, in the formation of all eventful historical processes – later, the organization of social and state regulations – in the past and now, the specifically divided settlement of the entire population, even the unreasonable concentration of nuclear energy (**43 NPP**) only on the east coast and many other things – all this **IS NOT** the initiated independence of *these European newcomers*, but the

controlled processes, including the participation of the CC Bermuda and the Hydrophone layer.

What was the changing state of the public Consciousness at every stage of the historical development of the United States? It does not matter. What is important is that it was **IMPOSED** upon exactly the newcomers of the US **POPULATION** (*a certain set of individuals with a specific genotype of the Brain*), including the energy-information transmission through the gratings of the Hydrophone layer.

For example, what was the public Consciousness of all seamen of US surface and underwater forces as the carriers of strategic nuclear weapons during the Cold War? – It is eloquently described in the propaganda literature of that time from both opposing sides. But the construction of systems for stationary and mobile surveillance, tracking, tracing the lines for preventive strikes and many other operations – all this was created under the guiding and Control of the Hydrophone Layer, without noticing its declarative participation, but realized by people as **INITIATIVE REASONABLE** volitional actions and decisions. And all this is not without heroic efforts in difficult ocean conditions, forming the corresponding antagonistic public Consciousness at this difficult period. But in fact, ***the system of operational control was created*** (missing earlier) over all movements and potential possible use (as a threat) of nuclear weapons by the Control System, which played a certain role in the historical processes of **GROWING VIOLENCE** on a global scale and had an impact in the future. This, finally, led to the programmed processes of the global governing of the world's people being – ***"Globalization" through open violence and parasitism on the part of the US and its accomplices.***

The question might also be asked about the **INSANE INEXPEDIENCY** of locating all nuclear power plants on the east coast, taking into account their complete vulnerability to the threat of use of nuclear weapons by the USSR. But such placement was determined by the main generating complex of the **CC Bermuda**, and it was determined for some kind of "replenishment" of the complex thanks the activities of nuclear power plants, the number of which was determined by the "capacity" of the Complex. American engineers had only to realize it and convince others of it, that is, to influence their public Consciousness on this part, but with **MANDATORY PARTICIPATION** of the Hydrophone layer and the Atmosphere Control System located in the same layer! In such subtleties, it may and has to be considered further each geographically outlined fragment

of the state location and **REVISE** the **ENTIRE HISTORY** of the events, bringing closer the features of their realization through the truth of their Systemic Control.

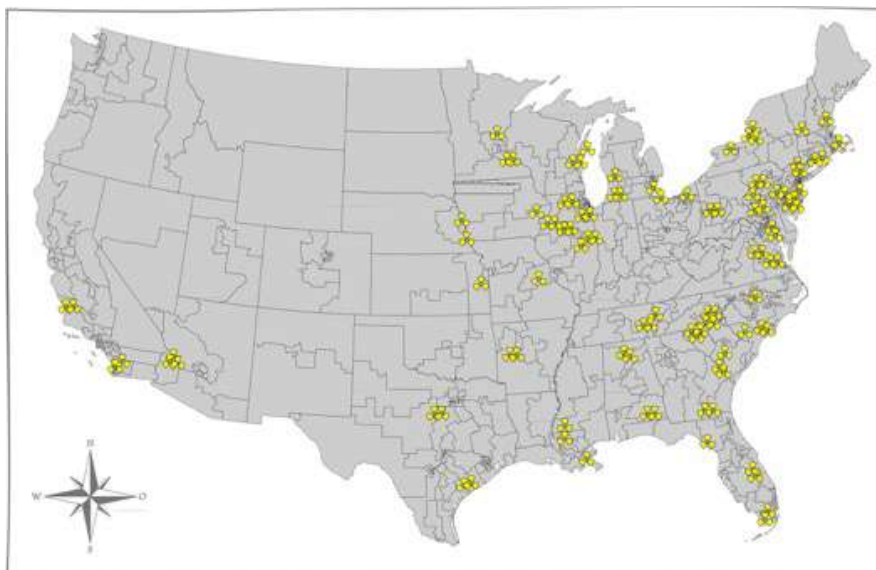

Equally important in its functionality is the No. 3 layer, which houses the Atmospheric Control System.

Layer No. 3 is very complex in Construction. It is vertically **divided into sub-layers of 6 meters**, each of them having strictly identified frequency characteristics, excluding any superimpose or mutual interference. We will consider only that part of the control functions placed in this layer, which **DIRECTLY INFLUENCED** the formation of the public Consciousness of people strictly differentiated by their functional-territorial dispensation, depending on their settlement in the regions of the Planet. These functions include:

- formation, control and hold-in of the "prescription" form of all chemical elements in their ionic state;
- energy pumping, control and regulation of the stability state with respect to the potential density of charges, i.e. holding a given half-life of elements;
- holding the construction of all energy gratings of the elements along the axes of symmetry and translation, natural temperature and pressure.

The fact is that the very life of the entire bio-environment, including people, is possible only under the **MANDATORY FORMED** life-support

CONDITIONS. Part of these conditions is organized with the help of **layer No. 3** and with the participation of the Control System placed in it.

Within this **layer No. 3**, the most complicated process of constructing models of chemical elements at the ionic level is carried out, i.e. it is implemented the modification of all chemical elements in accordance with the Program of the the Energies being of the Earth (*in their inertial and non-inertial states*). We must keep it in mind that each chemical element has *hundreds of thousands of frequencies* interconnected in a model linkage (specific to each of them), which are strictly within the limits of temperature and pressure. Each chemical element has its half-life. If charges potentials are pumped through the frequencies included in the model construction of the energy grating of the chemical element, then its half-life time increases. Otherwise, the chemical element decomposes. The isotopes of the chemical element have different lifetime, which is reflected in **Fleorov's** chemical elements table (*Georgy Nikolaevich Fleorov*, born

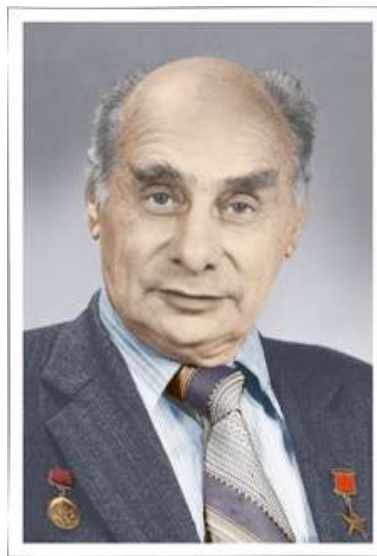

February 17, 1913 – Soviet nuclear **physicist**, co-founder of the Joint Institute for Nuclear Research in Dubna, academician of the USSR Academy of Sciences (1968). Socialist Labor Hero, Lenin Prize Laureate and twice Stalin Prize Winner).

In the layer where a certain programmed chemical element is formed, it initially has its being in the form of a mixture of certain isotopes. When the model structure of a chemical element falls apart, a group of frequencies is formed, which is defined as the frequency spectrum. Any group of these frequencies has a carrier frequency, which is both basic for the scattered group, and for the chemical element itself. This is radiation frequency, and all the spectra are constructed with reference to specific radiation frequencies.

It is important to note that the living flesh cell also contains radiation frequencies. This is just **ONE INSUGNIFICANT ELEMENT** of the whole variety of the general Construction of the Earth energies being. **Here is an example:** when having fluorography, the cell content is recorded in the picture with reference to the background of the radiation frequencies, and

not to the base of the cell itself. Therefore, any cell study with such an instrumental method is rather **SUPERFICIAL**, and far from being objective. In case of dissipation, the potentials density, frequency, the distance of action of such a physical process can be measured with the existing instrumental methods, the results of which make it possible to draw various frequency circles around the dissipation source. However, if we decompose these frequencies into points, we can get a certain curve, which is called the "symmetry curve". This curve contains 18 axes of symmetry and 6 translations³⁸. Frequency dissipation makes **SPECIFIC FORMS of SPACE**. This is exactly a very important physical process as one of the necessary conditions for the biosphere life-support- ***the volumetric form of the space dissipation***. Thanks to this process, but with no help of the anatomy-pathologists it is possible to answer a large number of questions on the features, and varieties of voluminous forms and the surprising harmony in the placement of internal organs in the people's body ***that "do not interfere" with functioning each other, at least!*** If you remove dissipation, then the liver, for example, takes the spatial shape of the ball, "singing" in a completely different key at its base frequency and just will not allow the rest of the flesh to live in the same harmony!

In fact, there are metabolic processes not only in biostructures, but in the whole of the environment! It is only for this reason that people have to be much more modest being in the environment and **NOT PERMIT** yourselves parasitic feeling of its "conquerors", for it (Nature) all the waste of their vicious existence **RETURNS THEM (US) IN FULL** (not only in their inertial, i.e., material "solid" state). It is true, every year it requires more and more means for treating people. Very harmonious" relations, aren't they? ***"You give me – I give you"***, like among the officials. Apparently taken deep roots nowadays **"paid service exchange"** among government officials, **IS NOT** corruption, as a vice, at their level of understanding , but ***a natural phenomenon that "releases" them of the legal responsibility for bribes*** (it is like an element of their "public Consciousness").

Taking into account the imposed structural features of the Brain (according to the frequency response) in groups of individuals of each Brain genotype (with all the diversity of their sub-genotypes), it should be emphasized that for each of them a **THOURALLY IDENTIFIED** basic radiation frequency (with an appropriate set of complementary ones) was

³⁸ Description of space dissipation, see AM Khatybov "Symmetry".

dispensed. There are more than 100 radiation frequencies (the number of now existing **sub-genotypes is 61**), i.e. there is still some choice! Will **“Svetl” Programs** help? Yes, they will, and just the way I said. Not depending on the User’s Brain genotype, **but depending on his desire for Cognition**. For a specific geographic continental region, with a specific functional-territorial assignment imposed upon it, and proceeding from the framework of executive human actions, **in layer No. 3** of the Atmosphere there was formed its specific set of radiation frequencies, which ultimately expressed the framework of certain life support conditions for specific types of individuals.

One feature should be noted – the selection of radiation frequencies for a particular geographic region is **NOT ALWAYS** permanent. It changes in strict harmony with the tact of the event –driven time, and correction of its complex state are preventively made, if within the framework of the Vector of Target of the phenomena, actions and events, such correction is required for the formation of some future actions or events in the given region. This kind of correction has begun in many geographical regions since **2012.10.25**. Naturally, all similar changes, and especially the last correction, are "coordinated" by **"SvetL" Programs**, depending on the Users’ definition in the further processes of environmental transformation and "fulfillment" of the target vector in the framework of participation in these processes in accordance with the transformation of their Consciousness (correction details are not public today). This set of radiation frequencies as its basic principles determined, in its turn, the prevailing quantitative geographic settlement of a specific ethnic group (or a possible set of groups of individuals with a specific genotype of the Brain). This directly and irreversibly influenced the processes of people’s **ALL-ROUND WORLD PERCEPTION** at all stages of their development and expressed the specificity of the emerging "national" traditions of behavior and cohabitation. All this also influenced the construction of various types of the organized societies being characteristic of a specific functional-territorial dispensation and development stage, culture and everything else concerning the **BEING** of **PEOPLE** in general.

In people’s being there are no actions and events without a formed public and individual Consciousness, and therefore, the **Atmosphere layer No. 3** took a direct part in the programmed imposing upon people such Consciousness. So the tribal world perception prevalent among political scientists in their attempts to change the structure of the social being of modern society (in their own favor, i.e., democracy only for themselves) – all

this should rightly be **BROUGHT INTO CORRELATION** with **ANIMAL BREEDING**. And the world of reality around us is completely different, and, in accordance with the harmony of the changes taking place in it, requires a completely different, **NOT ANIMAL-BREEDING** approach to the transition to another way of human civilization development, creation of a new system of their organized being, especially in the formation of Consciousness!

Since **2012.10.25 THE ALL ROUND BASIC** world perception of the present-day people, concerning the processes of formation of public and individual **Consciousness has been switched over from the basic position of "profit" to – "reason"**. This process is provided by the appropriate energy-information translation on the part of being restored original Control System. This seemingly insignificant information is the new cornerstone firmness, of the shaped executive state (one of the three that is needed), which is laying down the beginning of the **REPLACEMENT** of the **WHOLE** former Structure of the organized human's being born by the old Interventionist Control System. That's why, just a few months after the death of **N. Levashov (2012.06.11)**, the concept of "implementation" of **"SvetL" Programs in the Generator** was "revised" (you should not associate it in any way with N. Levashov's passing away which some "individuals" are trying to do), and their application and "tuning" (adjustment) to those processes that have begun in the Atmospheric layers and, in particular, in **layer No. 3**.

In what way was the technological control of the whole variety of parameters and derivative states realized in layer No. **3** and with its help? The functions of such technological control of states, including those of the public Consciousness, were realized with the help of **"Cords"** as one of the active elements of the control.

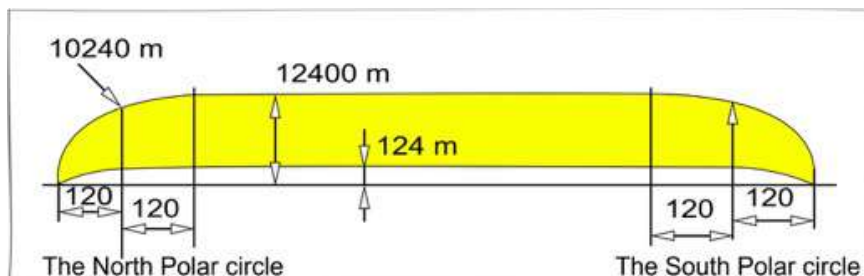

It should be taken into account that the "Cords" (directly by their constructive arrangement) operate along **layer No. 3** in the equatorial zone, but the information is taken over the entire zone between the south and north polar circles. This is just one complementary control element to **120 Control Systems from 18 Earth Control Systems**. The "Cords" control in most cases proceeds "painlessly" for the Man (blood pressure increase, a taste of metal in the mouth and similar short-term "nuisances").

The Cord is something like a curtain stretched from the Arctic Circle to the South Circle. **Up to L=120 km – the segment up to h=10240 m.** The next **120 km – up to h=12400 m.** The height above the surface is **minimum 124 meters.**

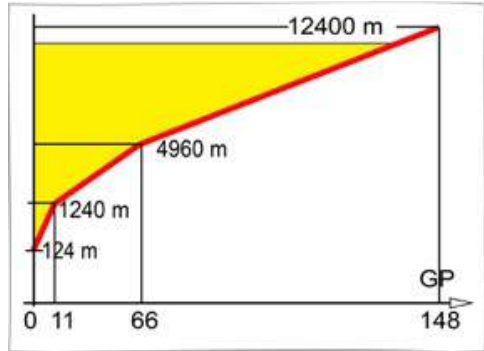

The density of the cord structure is uneven. The gravitational potential has a stepwise distribution. The maximum possible density for the structure of tetrahedra =148GP, (for cubes =124GP). That is, if during the cord operation a cubic structure object passes through it, then it (the object) disappears (scatters into atoms). The cord thickness at the base does not exceed 1 meter, at a height of **h=12400 m**, the thickness reaches **32 m**. The lifetime of the cubic structure in the cord does not exceed 1 second. The cords work schedule is formed basing on the requests of the Control Systems.

Basic control cords

No P / p	Octaves	Usage	Location
1	11 – 511	15 – 124	Approximately 33 km from the coast in the direction of Khabarovsk, along the meridian
2	11 – 511	15 – 124	+ 1047 km to the west of No. 1
3	11 – 511	15 – 124	+ 1047 km to the west of No. 2
4	11 – 511	15 – 124	Approximately 120 km east of Zurich
5	11 – 511	15 – 124	+ 1047 km to the west of No. 4
6	11 – 511	15 – 124	Bermuda Center
7	11 – 511	15 – 124	+ 1047 km east of Bermuda

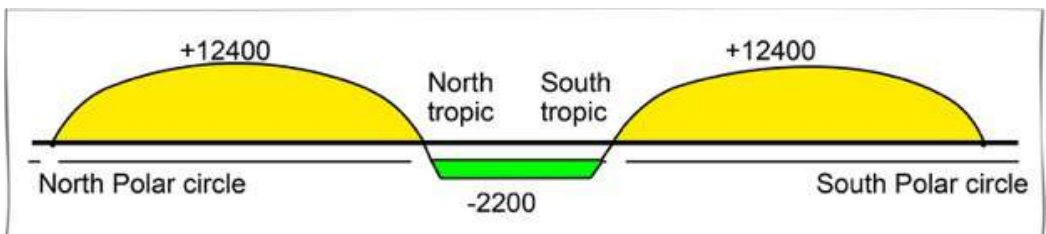

There are only 32 basic cords, but they are turned on once a year at Easter. And separately each out of 7 cords specified in the Table are turned on once a week (optionally sequentially). There are also additional Atmosphere grating control cords in the layers from **0 to -2200 m**, there are **48** of them. For convenience, the additional cords preferably to be classified as ***Lower Control Cords. Data on 32 and 48 cords are classified secret, the information on their placement and transit is not subjected to passing to outsiders.*** Nowadays this control 2 “works” under the New Control System and is extremely essential.

The cord is not a stationary object. From the moment of loading and its formation, the cord “phantom” is created, that **for 2 hours and 10 minutes** runs around the Earth (the cord itself remains in place). By the potentials difference of the cord and the phantom, the Control System makes a request for the corresponding complex, **which picks up or removes the necessary potentials.**

99% of all imported underwater individuals are in the zone of the Northern Tropic – Southern Tropic, therefore in this zone the main grating control is from 0 to -2200 m.



In the picture, the moment of passing the Cord phantom during the period of switching on the electrical equipment at the tower

The control system was created together with the Earth, so the range of its octaves is from 11 to 512. Cubic structures use the control from 15 to 124 octave. **If, for example, 128 octave control is switched on with the load of more than 136% of the gravitational potential, then all cubic structures from 15 to 124 octave disappear along with their carriers.**

When Man is being controlled with regard to the implementation of the “imposed executive orientation” in the context of solving specific tasks,

it might be rather painful. The more **FIXED "ATTENTION"** is to the person, the more "parameters" are "read" (required from the Brain) and the more "troubles" (unpleasant sensations such as sharp pain in the heart, dizziness, etc.). I experienced it myself in September **2013** and then several times over the next few years. This also explains the "complaints" of "**SvetL**" **Programs users** in recent years on the ***"sometimes sharp pains (short-term), palpitation, a sharp increase in sugar in the blood and dizziness up to the loss of consciousness».*** I am saying it again to the Users of "**SvetL**" **Programs** – there is **"SPECIAL" ATTENTION**, and not only in similar things. You have to know about it and you have to BE more **HAPPY** about it than **WORRIED** (especially people of mature and elderly age). The generator **"is able to stand up for you"**, so to say, but it **WILL NOT** block such a control (and, accordingly, related to it some discomfort and affection). The information, I am saying it again, – is goal-oriented (exactly to the User of "**SvetL**" **Programs**), must be objective, **since the question is: "ARE YOU LET** to have a Bath or **NOT TO"**? However, I would like to draw your attention to the fact that if, according to the functional endowment and the corresponding set of the Brain function, an individual does not have any relation to specific information, translated and verified today, he **WILL NOT BE ABLE** to get such a contact state to obtain the information and the **CORRESPONDING TO IT KNOWLEDGE**. Errors are technologically excluded. A person who bakes bread well **IS NOT ABLE** receive (perceive) information for a nuclear physicist, unless, of course, the "baker's Brain" has been changed for one reason or another. But it does not mean that the "baker" today fails to understand that everything connected with nuclear energy makes **MORE HARM** than good. In the current time, the functional endowment of individuals can be **SHARPLY CHANGED** according to what is happening (I mean, you should not "relax"). The brain that is not prepared for this, in most cases, might not accept this information, however, the users of "**SvetL**" **Programs** will "accept" it with great certainty and become co-executors in the implementation of the intended Target Vector. This is a great chance **TO BE "INTEGRATED"** in the future. The time has come to say it **OPENLY**.

The other layers of the Atmosphere undoubtedly influence the processes of ensuring and functioning the created Habitats and Conditions of the controlled environment, ***but their effective influence on the very process of Consciousness formation is of DERIVATIVE***, i.e. **GUIDED** character. For this reason, we will not consider them. And leave

them to the "experts" from the Scientific Research Institute of the Center of Preventive Strategies (**SRI CPS**).

5.10. Biomass

An important functional fragment, or, in a different way, the definition of a control system, was the monitoring of the state of the so-called "biomass". However sad it might sound, but "biomass" should be understood as a **BIGGER PART OF THE POPULATION** that was not subject to the programmed processes on the creation of the Brain genotypes. *This part was used to a limited extent in the development of energy biogenesis of the flesh*, but basically was used as so-called "programmed-brain donors", being applied for the purpose of working out some changes in the Brain functions and carrying out some expertise to control the changes in the habitat.



N. Levashov, so that not to hurt the psyche of unprepared people, wrote that "the motion of Entities is (was) an objective process"! But he did not write (although he knew it, and we discussed this process, which was new for me that time), that **NOT** in **ALL** the bodies (shirts) in the formation of the fetus there was **ENTITY'S MOTION** which were destined to development. No matter how sad it might be, but that is exactly that way.

All public figures in the sphere of power, concerned with demographic problems on the Earth, can calmly take off the entire burden of such responsibility and rest in serenity, for all these problems have been invented by them. The quantitative and qualitative composition of the entire population of the Planet is a **CONTROLLED PROGRAMMED PROCESS**, and it was only the System that was able to make decisions on such important episodes. The reason for all this is the ever-complicating process of working out and improving the control system elements and developing the functions of the Brain in the **PREDETERMINED GENOTYPES**, and everything else is a consumer-goods material usage of the ongoing development process. If the Brain of an individual from the whole controlled mass manifested itself by some indicators of the Brain functions as having received more advanced properties of receiving, processing and indicative ability of a new function with some other expedient

executive operational qualities associated with the manifestation of more perfect control over the operation of a particular internal organ, then such an individual became a **"programmed-brain donor"**. The perfected feature of his Brain activity to control the activity of an organ is perceived by the control system as positive, i.e. the best experience.

Such manifested options for planned deviations from previously tested control frequencies were fixed and later, after repeated and massive verification by programmed brain donors, were duplicated for their subsequent setting in **"The Golden Billion and Million" (Brain Genotypes 42, 44 and 46)**. Such processes required **QUITE A LOT OF TIME**, and polishing was carried out on many generations of donors. Actually, this is what **N. Levashov DID NOT SAY**. And, in my opinion, he did correctly, giving information that time that could be adequately received and then, as we know, **FAR FROM EVERYONE**.

For example, for the manifestation of non-unitary individuals, the so-called **"new Russians, or simply oligarchs"**, it was required to make complex experiments on the part of the System both in the field of energy biogenesis of the flesh and in the correction of many Brain functions, i.e. to the future "surplus in caviar, money, the frenzy of market relations and the shadow economy" the Brain functions were taught and worked out slowly. This involved at least four generations of "programmed-brain donors", on which the module of **FUTURE INDIVIDUALS** was tested for the subsequent introduction of programmed and functional orientation to receive information from the System on the NEW world perception and the imminence of social re-arrangement through the **RUTHLESS** destruction of all that existed before them. In the popular rumor, such brain donors were called "styli", and later "the sixties».

A complete list of such worked-out and implanted individuals has been sung of by sociologists in the annals of history-from Gorbachev and Yeltsin to Chubais, with all the images of a separate breed of Gaidars inclusive and further adherent to them of petty abandoned, lost youth with an indefinite functional and other orientation, like the involved programmed executors on the immanent perception basis of information. **They have no their own "brains"** but outwardly they look like their brain donors.

After the frequencies are set and checked in operation, the entire mass of previously involved "programmed-brain donors" was **NO** longer **WANTED**, and the System got rid of them, carrying out a **CLEARING** with

the purpose of **NOT GRANTING** further development of such Brain functions in the mass of former donors or in their born generation.

Thus, the Control System has been programmed to improve, practicing in polishing all and every function of the Brain, i.e. **CHOOSING THE BEST OPTION** for all functions, including control over the amended program of individual internal organs functions, introducing such "achieved experience" to individuals of the so-called "*Golden billion and million*". Such a version of material usage of people required a quantitative increase in the "experimental material", and this was one of the reasons for the significant increase, variety in the required quality and the corresponding specific quality of the Planet population. The more complex was the programmed Brain genotype in the process of its development **from 42 to 46 genotype**, the more "experimental" processes were required with multiple control check of the states of the Brain functions both of outer and inner control. It **DOES NOT MEAN** that such a process of development took place by the method of random selections, i.e. "blindly." It was associated with an extremely complex programmed process of simultaneous combined development of not only the Brain functions and abilities, but also with a complex program of the **DEVELOPMENT OF THE ENERGYBIOGENESIS OF THE FLESH** of the individuals themselves, practicing incredibly complex and multivariate programmed processes in an integral approach. The exhausted "material" after the completion of such a program was removed by the System. By the way, *Saakashvili, Lev Kachinsky, the presidents of all three Baltic republics, Kurmanbek Bakiyev, etc.*, would have been such organizing executors in sweeping large numbers and over a large area. But they have not been let to perform such "historical function". They have just been "written off", and the Program was liquidated with the corresponding consequences.

5.11. What to wait? How to perceive?

The Earth's Control System transforming goal-oriented translation in Russia began **in 2013, on October 25 at 3:14:45**. On the night of October 25, **THERE WAS** a **TRANSITION** of the control **STATES** on the part of the ECS (Earth Control System) to the level of a more tough (that is, less smooth) influencing character. So far, there has been no need in a very tough transition, but if needed (and everything goes to this in the light of the ongoing events), it will be **LESS SMOOTH**. How is it manifested? People

do not feel it at all. But, quite objectively, there have been more speculative effects than, for example, **until 2013. NOTHING TRAGIC HAPPENED on October, 25.** This change is with immense benefit for the future, since more active process has begun, in the MORE COMPRESSED tact of event-driven time ... The former natural habitat is being recreated. And first of all, is the Control. This has already affected the environment. For the observers there is much more joy- there are more various glowing "balls" in the heavens. Do not be scared – they are not UFOs... **NO** more UFOs brought in by Ebr system, **WILL BE ABLE** to take off anymore. The main Complex guiding their movement is completely "switched off", it is **NOT SERVICEABLE.** And all of today's "UFOs", which it is written about, are seen, made pictures of and shown in the network a lot, are "luminous balls" in the sky. But they appear, if we analyze their appearance, always in connection with some events in the area of their appearance, planned in the framework of the so-called target vector of the ongoing events,. A good example of it is the so-called "Chelyabinsk meteorite" (February 15, 2013). About the UFO, I'll write in more detail in another chapter. It is useful for your knowledge.

Recently there "appeared" especially many plasmoids³⁹!



Various kinds of plasmoids have been used and continue to be used. They are moving sensors of various types and different functions. They themselves are **NOT ABLE** to do harm, except in an energy way, (there are more scalded than frostbitten after talking to or touching them). They are not capable of creating any special destruction and you should not beware of

³⁹ Plasmoid is a plasma clot, a limited configuration of magnetic fields and plasma. Nikolay Tesla got spherical plasmoids.

them. Plasmoids began to appear, as a consequence of the processes to create the true ECS. They are given rise to within the framework of the Earth Control System. It might be possible to publish some information on plasmoids, but we have such inquisitive people that they will rush to check, and this is fraught with some unpleasant consequences. In future, there will be more of them – **DO NOT PAY ATTENTION** to them. And even if you are so curious, do not interfere with your curiosity into the happening. Where there is a manifestation of **UNREASONABLE CURIOSITY** today, there is also a **COUNTERACTION**. The same is true about **Complexes "SvetL"** and their **Programs**. You should make accustomed yourselves to the thought that there mustn't be any curiosity, but **KNOWLEDGE** and **STRIVING** for knowledge.

There are many who ask: "And what are those objects near the Sun?" Near the sun they have been for nearly 18 (for April 2017), and they became visible and are watched only recently. And if you look closely, you can see **4 good "suitcases"** that are flying, doing some work with the Sun – removing from it the **UNWANTED INFRINGEMENTS** on the Earth. The Earth still being in the captive state gives way less and less energy unwillingly, but previously it had to give it unhindered. And now the volumes of Earth energy transfer in the 53rd octave are **BEING REDUCED AND VERY INTENSIVELY**. This is the Programmed Process. All the residual processes that manifest themselves in various areas in the form of Aurora Borealis are the processes of ignition of the prepared but not-delivered energy from the Earth. And do not pay attention to the color. The colors are of the energies (matter) "fired".



I am writing it to those who after reading the information about the end of the Northern LIGHTS as the process of Ebr System, will not ask questions, like – "But Khatybov wrote that there would **NOT BE** any Northern Lights, but they go on and on..."

Do Ebr objects fly today? Yes? They do. I have already written that **ALL** the planets' **SATELLITES** are to be "got together" (and the process is under way) near the Sun. The "Planets Parade" that we periodically can watch is

hung over with satellites. The Planets have been in Ebr System captivity so far. There are a great number of satellites that "go round" Saturn which had not been able "to land" on it. Saturn **DID NOT ALLOW** but kept them in captivity and did not let them go. Each of the planets in the Earth cluster system is endowed with a certain function. While in captivity their atmosphere construction was practically destroyed. Now the processes of the atmosphere gratings recreation are in full swing at **ALL** the **PLANETS of the Earth cluster system**. Some are being recreated, others are **CREATED ANEW**. The communication Tubes have been saved but rearranged by Ebr System. It surely incorrect to say "gravity communication tube" since it has nothing to do with gravity, but there are many who **WILL NOT UNDERSTAND** it in the other way, unfortunately. And not only the **Users of "SetL" Programs**. They **HAVE NOT BEEN** to the **Bath** yet. If I openly say now that **THERE IS NO** gravity at all there are many who will start twisting their forefinger at their temple so intensively that might make a hole in the head. So, I'd rather wait till the right time, though, something will be said in the fourth book. And now a few words about what gravitation was meant by. It is sufficient to say that **ENERGIES MATTERS** are pull and push. The Moon, for example, was held by gravitation communication tube like a "dog on the lead". The moment you loose the lead it is noticed by the astronomers.

There are many who did not know, and still do not know that all women's life cycles are **DIRECTLY CONNECTED** with the Moon! ***That's why today, as they say, our beloved (and generally all) women "are on the rack", not understanding what is happening to them.*** The moon will be further moved off the Earth. There will be a lot of delight.

We are glad to have the Sun, its light and warmth through the energies transformation withdrawn from the Earth. The form of energies **in the octave of 53,25-43,25** – these are for life-support conditions. They are unnatural for the Earth in general. **IN THE PROCESS** of the Earth **SYSTEM RECREATION**, the "services" of the Sun will no longer be needed ... The Earth provides itself with everything! It is so technologically perfect that it does not need interference. Day and night **ARE NOT TO BE** canceled. Temperature, and more habitually – climatic conditions, in the ongoing process of recovery are already changing for the better. I am confident that ***Russia will build resorts in the Arkhangel, Murmansk regions, in the Republic of Komi, on the coast of all northern territories.*** Take notice of the winters of **2015-2017** –and this is just the beginning. The present day Northern belt, where the average

annual temperature will be **+22.5°C**, is to be used for crops. This will make it possible to harvest two or three crops with a small amount of acreage. There will be no need for "**SvetL-Flora**" **Complex** then. The Earth will be less "contacted"! Nature will **APPROACH** the **CITIES**. And it should not upset anyone, it should make one happy. Not only **N. Levashov** and I, but all those about whom I have written, believed and believe that one of the functional endowments of Mankind **is get careful to Nature**. Flora and fauna after re-creation will become producers of those minerals that are vital for Nature and Man life-support. But this is one of those **MOST DIFFICULT PROCESSES** that people are to experience. This is not liquidation at all, it is not correct. This is the **ELIMINATION** OF the **CONSEQUENCES** of the Interventionist interference into the Earth Cluster System. ***This is the expediency that is to be implemented!***

Chapter 6. About the creator of the "Bannoye delo"

Life experience gives us joy only when we can pass it on to others.

Andre Maurois

Those actions that are taking place today before our eyes, as a result of the most complicated events developing like a scenario, directly affect our lives and lead to the unconditional conclusion that for a transition to another path of development it is far from sufficient to have the present level of cognition and that knowledge we possess. Any attempts to go on making "houses of cards", i.e. artificially imposed illusions and abstracted from the surrounding reality model ideas about it, take us further away from the reality. Many people begin to realize it. In what kind of perspective should one see the ongoing events to get at their meaning?

The happening is the **ENERGY** of **CIVILIZATIONAL DEVELOPMENT**, discretely differentiating each of its own path out of the general process that is going on, when the highest level of all forms of **PROGRAMMED HARMONY** at the previous stage is reached, before proceeding to the next stage of its development. ***Is it too complicated to get at the meaning?*** It is complicated, but for the time being. Are the people involved in this process? Yes, they are, or, rather, ***their Brain is involved***, through which the intended implementation is taking place within the framework of the adopted vector of the target. The scale of the happening is so enormous, or, rather, endless, that it is too difficult to comprehend. Most people believe that. But that is not so, since infinity **DOES NOT EXIST**, neither does zero. Naturally, a **NEW THEORY** is required preceding practice, corresponding to the scale of the issue under consideration and the one that would be able to drive away the imposed model scientific limitations and errors of the past stage of cognition, based on the material world (materialism) as the dead anchor of the continuous **IMPOSED LIMITATIONS**. I'd like to note that a new theory of the similar scale, which is very intelligibly presented in five parts of the "**Foundations of the Mankind Formation**", will successfully pass its test if it (even now) in total answers the questions about the birth of the universe and explains the true essence of matter as a whole, (from origin to its constructive

arrangement and controlled by its own being). Only such a theory can acquire **the SIGNIFICANCE** of the **TRUTH** and become **the "Universal Constructive Theory"!**

Steps in this direction were made by: **N. Levashov**, who created not only the **THEORY OF SCIENCE about everything**, but also tried and tested it in practice; **N. Morozov**, whose works open the way to the comprehension of the new science as such, and his rigorous scientific approach to solving problems, which is a rare thing now; **A. Khatybov**, who for the first time accomplished not only **MOST** of the **EPOCHAL scientific DISCOVERIES**, but also carried out practical actions with direct and immediate preventive participation, of which I will write in this chapter; and others now living, but so far (for known reasons) **NON-PUBLISHING Russian Scientists** in the most direct sense of the word.

Many people ask the question: why do we need such experiences in cognition of **EVERYTHING UNKNOWN** and so far so distant from our present life and understanding of the state of the Consciousness and Mind? After all, we used to live quietly and without all this. If, of course, we forget and do not consider the constantly increasing scale in the desire to destroy each other and not take into account the end of our civilization perfection in the sense of life – "everyone against everyone" – then, in principle, it can be considered that **little by little. We lived, but as a material usage** for the implementation of the programmed processes under the control from the outside, in which the very process of civilization development of people was far from being important, with all the strictly oriented direction of the events. ***There are no such human words with which you could convey the full depth of this humiliating state of material usage,*** and the impossibility of even realizing this fact. In practice, Man **WILL BE RECREATED ANEW**, he will cease to be the object of application and usage.

There is not any preaching or pathos in the fact that the life of society and people, today at the crossroads: either forward to the past, i.e. without changing their **CONSUMER MENTALLITY**, or to find an entirely different path of development and form their own being, oriented to recreating the true conditions of civilization development of the very model of the Earth. There is a choice, and it is individual for everyone, despite those heavy and independent of us destructive consequences left by the Interventionist interference in the past. But still **THERE IS a CHOICE!** To approve such a choice, there arises a countless number of vital questions of principle, without realizing the essence of which, it is difficult to make any

decisions for yourself and orient yourself in what is happening. It is **DIFFICULT**, **BUT** it is **POSSIBLE**.

This narration is in some way a clue in making the choice. **IT IS POSSIBLE**, – because there is something to **READ**. They are the writings of **N. Levashov**, and then **A. Khatybov**, so this way it will be easier to understand them and then apply, having made the right choice, first of all, for yourself. And on the basis of this, you are sure to be **TAKEN TO THE BATH**, and if **there is "Svetl" in addition**, there are good prospects.

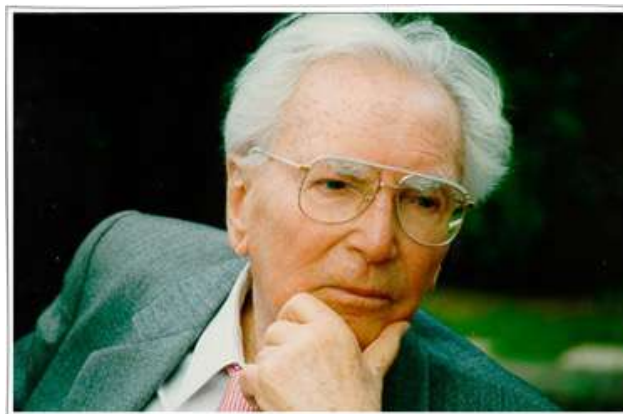

Viktor Emil Frankl (1905-1997), an Austrian psychiatrist, psychologist and neurologist, was a prisoner of the Nazi concentration camp, said in his time: "What constitutes the dignity of the world can only be saved on one condition – remember it. And the dignity of the world is made of mercy, **LONGING** for **KNOWLEDGE** and respect for the inner world of Man. *Man can be deprived of everything but one thing: the last Man's freedom – **TO WORK** his **OWN WILL** under any circumstances, choose his own way*".

6.1. This "unknown" Khatybov

All that we learned – turned out to be a game in bricks and the horse's science.

I could not help writing about this amazing Man. Unfortunately, I haven't had the honor to be acquainted with him. When I got to know about him and read his works, he **WAS GONE**. Most of his works were devoted to carrying out calculations in many fundamental scientific directions of the future. He managed not only to carry out all the necessary calculations, but to realize them, too. Who is able to appreciate his other **NEW**

MATHEMATICS, which made it possible for him to practically realize it for the processes of recreating the future natural substance of our Planet? This part of the most trying work *had taken the last 20 years of his life*. It is hard, and, probably impossible to imagine its true value, because it is taken by everyone for a mundane phenomenon. But was anyone else able to do this? When speaking of his activities, **B. Makov**, who had worked with him for a long time, emphasized that **A. Khatybov** was the only one on our planet, and this fact can not be practically comprehended by the present day people. Just like N. Levashov, there had been the only one. That is to be realized later, by our immediate or distant descendants.

In this chapter I will write about **Alexander Mikhailovich Khatybov**, and also about **Nikolai Aleksandrovich Morozov**, whom **A. Khatybov** considered his Teacher. So that to emphasize the influence of this person on his knowledge, Alexander changed his former name Morozov for his mother's name – **Khatybov**. He did this so that they **WOULD NOT BE REGARDED** as relatives and their works **WOULD NOT BE CONFUSED**. I will write only what I have managed to find out on the Internet, got to know from **B. Makov**, who was his closest associate and friend until A. Khatybov's death; and also tell you some facts that until now were not public. Well, you will learn much more about this Man from the future **monograph by B. Makov about Alexander Mikhailovich Khatybov (Morozov)**.

* * *

At the end of **2011**, quite "accidentally", I came across **A. Khatybov's** works that caused, putting it mildly, **ambiguous understanding**. By that time I had practically read all the writings of **N. Levashov** and more than once. If I did not get at the meaning of something we looked into it at our regular meetings. And what I consider to be most important is the fact that our "**Svetl**" **Project**, as we called it, had already been launched. At that time it provided for "**SvetL**" **Appliance** and the collection of statistical material on its use. Everyone who had already had "SvetL" Appliances, I called the "**SvetL**" **Program participants** and it was approved by the author of the Generator ("Generator of dark matter"), "set in" on an electronic platform with a certain computer program.

At one of our meetings I showed N. Levashov several articles by A. Khatybov that were published on the Internet. I remember him smiling and saying: "**I knew you would get to him**", – Levashov told me about this man. I knew from him that A. Khatybov "had gone." He showed me a notebook with calculations and notes, of which I got at the meaning of little

at that time. I only realized that those were the calculations and descriptions of the processes that were connected with N. Levashov's 'actions' in the USA to "stop" hurricanes, described in the second volume of "The Mirror of my Soul". From N. Levashov I knew about his meeting with A. Khatybov and where it had taken place. It was indispensable to get to clear understanding of the physics of the processes occurring in case of hurricanes, tornadoes and tsunamis. Of course, it **COULD NOT** be public then and therefore **NOT PRESENTED** in his books.

What N. Levashov's works mean for the people in the most general sense? They are the **BASIS** of **NEW KNOWLEDGE**. The knowledge that was intentionally hidden and for thousands of years could not be available. His books are written in a simple and intelligible language to make the reader to have a desire to "take a big "spade" to dig, and dig up the "stronghold" of so-called "modern knowledge" on which science is based today, tossing all the junk to the side and **FINDING** the **TRUE KNOWLEDGE**.

What are A. Khatybov's works in the most general sense? They are the **INFORMATION ON THE FOUNDATIONS** of the **NEW** (hidden) science, expressed in the calculations, explanations and new terminology, and in the demonstration of physics of the processes going in a living human cell (physics of energy and physics of the Brain, in full perception of what the **Brain** is).

While having talks with those who have read the writings of **A. Khatybov**, I got convinced that the readers consider practically all the works by **A.M. Khatybov** hard to comprehend even for experts. Their opinion is based on the fact that Khatybov used "extremely complicated terminology", which is sometimes just incomprehensible. **HIS MAIN WORKS** are not widely circulated today, and to many of the classical concepts he gave his own meaning, and it is even more "confusing" to the reader. There are many who complained that A. Khatybov sometimes wrote "incoherently", chaotically, with too much of emotions, irony and imagery. But, in my opinion, it is somewhat emotional conclusion. His ideas are an inexhaustible source and an intellectual treasure, worthy of deep research and understanding. Therefore, in my narrative, along with description of the past events, I made an attempt to "put" the author's articles into more or less understandable language, and also "open" some of his non-public writings that would make it possible to have a deeper look into the principles of the **"STRUCTURE"** and **APPLICATION** of **"SvetL" Programmes**. I Do realize it, because the interest in the knowledge given in A. Khatybov's works,

as well as in the writings of N. Levashov, is getting more widespread, and the demand for information is growing. Those who started their journey with the development and perception of **NEW SCIENCE**, the science of the future, the science of **CREATION**, but **NOT DESTRUCTION** are to get to know about the Man of immense mental grasp and greatness.

* * *

An unusual phenomenon for science is determined: if a new advanced study really reveals (at least for a moment) the secrets of nature, the author is subjected to defamation (burning). But if the work is an outright misinformation, then it is followed by honors, Nobel Prizes and other prizes, titles, etc.

A. Khatybov

The works of this Man of genius initially excite a slight shock, although today quite enough is known about the inconsistency of many scientific data that did not fit into the aspects of **REAL LIFE**. In the majority of scientists and people far from science, **HIS discoveries and works "detonate" (provoke) even stronger emotions.**



The lack of information on A.M. Khatybov on the Internet and the availability of only **A FEW** disparate **ARTICLES**, speaks for itself. This led to the fact that many people today are deprived of the opportunity to correctly perceive most of the author's works. There have to be a certain point of reference, or a platform in knowledge, from which we could push so that to ensure that **A. Khatybov's** statements lined up in an adequate understanding. Over the past few years, I have come to understanding that such a platform are **N. Levashov's works**. Those who accepted his works and got a good understanding of them, quite easily read and understand **Alexander Khatybov's writings**. But at the same time there should be an **ASPIRATION FOR MOVING** in this direction. Those who, after reading **N. Levashov**, did not have such an aspiration, became fierce opponents of his works. When I knew that **A. Khatybov** "had met" **N.**

Levashov, who specially flew from America to Russia for this meeting, and the issues they had discussed, I realized that I was absolutely right in my thoughts. Two Men of such a **LEVEL** of **KNOWLEDGE** could not have "existed" separately. Today I can once again say that many **A. Khatybov's** calculations found their realization when creating "**SvetL**" **Programs** and not only the **Programs**. It was not easy, but the vector in this direction was given to me by **N. Levashov** in his lifetime, for which I am grateful to him. I am grateful to **B. Makov**, too. We closely cooperate, keeping our friendship since the cadet times. We studied in the same group at the anti-submarine faculty at **Frunze Naval School** (now the Marine Corps of Peter the Great of St. Petersburg Naval Institute). I'll write more about it later. After graduation, our meeting with Boris took place in Moscow **only 20 years** later, and not without Levashov's participation.

And now let's return to **A. Khatybov**.

B. Makov introduced me to people who had worked with **A. Khatybov** on those issues that are already becoming public and find their application in real life. But, unfortunately, time **HAS NOT COME** yet to talk about everything that was written, calculated and created by **Alexander Mikhailovich**.

Most of his life he had to work at private institutions, which can not be indicated in the public information sphere yet. There is a site with **A. Khatybov's** works, which is open to public today. This [site](#) is of the scientific research institute "**CPS**" (**Research Institute "Center for Preventive Strategies"**).

Once I met a very interesting Man who on his Internet resources, under the pseudonym "**SAGITTARIUS 2012**", independently published information about **N. Levashov**, and **A. Khatybov**. I got in touch with him. He was **Alexander Afanasenko**. He has collected the most complete information about **Alexander Mikhailovich**, and he deserves many thanks for this. I decided to supplement his information with my information, which I know.



6.2. So what is known about A.M. Khatybov?

Most people, when reading Khatybov, take him for the author of some fantastic works or a scientist-loser who did not have any academic regalia, absolutely not realizing that now and for a long time ahead they are **UNDER MUCH OBLIGATION** to this Man!

Sometimes his name pops up in documentaries about aliens, which is fully justified in the conditions of preparing the population for "declassifying" the information available to the higher authorities.

What is the reason for the fact that information about a little-known to "broad masses" scientist was so carefully "cleaned", and the author's main works, once exposed on the Internet, disappeared without a trace? In order to see the reason, we will analyze available information about him. Here are excerpts from the stories of those who **HAD KNOWN HIM**.

In early **1985**, a quiet scandal was braking out in one of the petroleum institutions of Samara. A certain **Alexander Khatybov** did not go to work, and for this they wanted to fire him. But it did not work somehow. His salary was not paid. But not to go to work? Sasha Khatybov neither drank nor smoked. And in general he was engaged in such elite business as programming. Alexander was stern in disposition. He was self-willed, not easy to get on with, but hard worker, which in general, in my opinion, is characteristic of Geniuses. The whole evenings, or even nights, he spent in the computer center of the "**Kuibyshevneft**" enterprise, adjusting some program. As it turned out, an absolutely **UNUSUAL PROGRAM** of a **Travelling Salesman**. Nobody took it seriously. Who needed a program then that besides all could immediately solve, for example, the problem of the most profitable investment of capital? Where were they, those capitals, then? And **Khatybov** stubbornly sought a new application for the "travelling salesman", improved the algorithm of the problem and at the same time incessantly quarrelling with everyone.

Alexander Mihajlovich had the most direct relation to the developments related to psychotropic weapon. **In 1965**, it was discovered the ability of the Human Brain and, especially, of his subconsciousness, to detect directly the signals of broadcasting stations. The sensitivity to perception was enhanced by the ingress of substances with semiconducting properties into the bloodstream. They talked about "cryptography", "coding the brain and the subconscious", "digital thinking". Naturally, the special services were interested in the possibility of creating a technique for

uncontrolled, noncontact influence on the subconscious. And then the development of the method of psychotropic zombification and the sterilization of the population for political purposes was started.

The technology of acting on the population came to the fact that in residential units, bioenergetic generators were installed and connected to the TV antenna or to the lighting network, which operated day and night at a fixed frequency in the range of **1.4-2.2 MHz**. In Soviet radios this range was not available, and the radio signal could be detected only by turning on a Japanese mid-range radio receiver at that frequency. Specialists found that each type of modulated pulses corresponded to a certain **EMOTIONAL DISPOSITION**: depression, **UNCONSCIOUS FEAR**, indifference. Or, on the contrary, a sense of satisfaction, happiness, delight. It was possible to cause physiological sensations: itching, burning in various parts of the body, headaches of a different nature ... The impact of psychotropic weapons (through the created generators) that time caused a feeling of disgust for one political leader and sympathy for another one. This is one of the **METHODS** of **DIRECT PSYCHOTRONIC** impact for political purposes. While listening to the radio program, you could be coded by a series of special radio signals in favor of one or another politician. Their repetition alternated with impulses that evoke certain feelings and emotions. At night, during sleep hours, when the border between consciousness and subconsciousness is lost, this same series of signals was repeated to consolidate the assessment of the relevant politician.

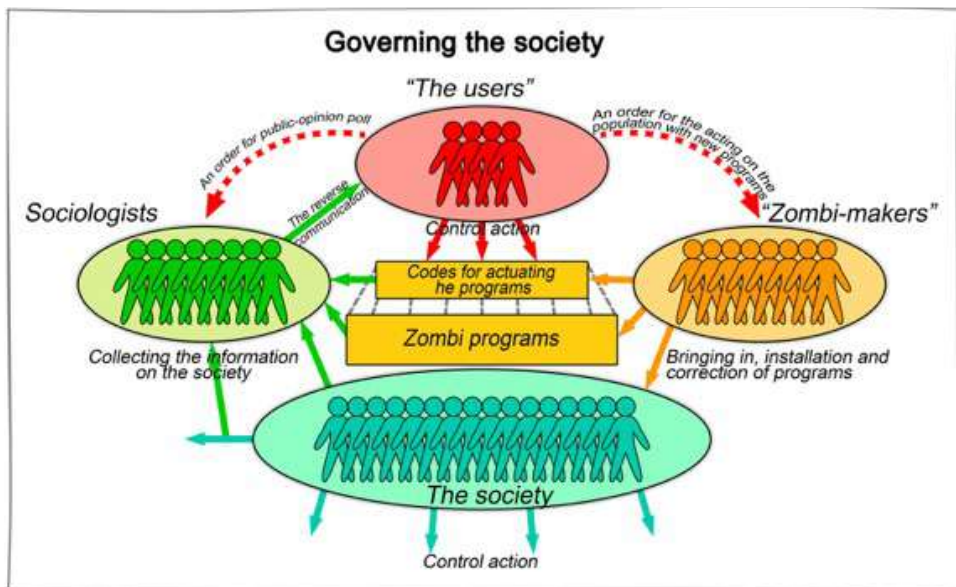

Exactly about those Generators, which were destroyed by **N. Levashov** he writes in the first volume of his book "**The Mirror of My Soul**". "There are many who remember the" fire "in the Ostankino Tower. **N. Levashov** writes about it in detail, and about many other things related to the "technologies" that he used to destroy those generators, including those located on the Ostankino Tower. Do not be lazy – read it. I can only add that the very physics of "destruction" of the Generators was later described by **A. Khatybov**, and on the basis of his calculations this technology is still "alive" and is applicable.

I want to emphasize that the "appearance" of these two Men at the same time and in the same place is absolutely **NON-RANDOM**, and their relationship that period could not be public. But it's not important (in this matter you can argue, agree and disagree). What is important is that these "technologies" exist today, and there are those who are able to use them. In confirmation, I just say that they were applied to the "executors" of the planned destruction of the **Airbus A321**, carrying 224 people (217 passengers and seven crew members). All information related to the "destruction" of this airplane, transmitted by various media – is **NOT TRUE**, to put it mildly. A deliberate lie in favor of politics. The plane was not shot down, not reaching the point of destruction 420 kilometers. It found itself "in the wrong place and at the wrong time" – where it should not have been. Similar "event" happened with **A-320** aircraft, which "crashed" in the French Alps in March 2015. Those who planned to bring down the plane over the Sinai Peninsula were in full combat readiness and "held their hand" on the "trigger". For this, they were punished so that there were only shoes left, and two live instructors (out of four) of the well-known Vanguard Corporation. They told those who had sent them about what they had seen with their own eyes and how it all had happened. This made an appropriate impression and caused the reaction, which the media did not know, and could not know. Here I put the points, as **N. Levashov** used to do with the information for which time **HAS NOT COME** yet. I am confident that soon the information hidden behind these points can be published.



.....

* * *

In April **1985**, Sasha Khatybov proudly stood at the door of the House of Industry. Instead of dismissal for absence from work, he got the salary for six months. And he was appointed deputy director of an "awfully" secret institution in Kiev. One of the authors of this essay Alexander invited to work with him. He depicted so bright future that one could feel “creepy”. But at the end of April, Chernobyl happened. The secret institution for the development of psychotropic weapons urgently moves to Moscow.

At the same time, a certain Ilona was leaving the Soviet Union, who **A. Khatybov** strolled with all the night through until the morning along the Moscow River embankments. He was unusually talkative and ... a few years later on the shelves of supermarkets, there appeared cassettes with the rate of accelerated ***English language training by Ilona Davydova***. But, perhaps, not only with the course of English.

In **1986**, an acquaintance of A. Khatybov from Samara, a physicist M. came to Moscow for a visit. He knew Alexander well and what he was doing that time. The algorithm of the program developed by A. Khatybov, he did not know, but often discussed with him its possible application in psychotropic. Now we can say that not only the effectiveness of this weapon, but also the entire defense potential of the country depended on HIM, Alexander Khatybov. And if specifically, the speed of response in the conduct of massive missile strikes and protection from them.

This experience and calculations made by **A. Khatybov** were "used" by **N. Levashov**, creating **HIS "PROGRAMS"** for the destruction of psychotropic weapons and low-frequency bioenergetic generators that were "scattered" throughout the socialist camp.

Alexander Mikhailovich Khatybov, closely cooperated with **Alexander Deyev** in the field of development of psychotropic weapons. **A. Deyev** is a unique figure in our national science. A surprising and mysterious person was a Moscow aviation engineer. And he "passed away" in a very strange way in the year of **1992**. Once he gathered his friends and announced: "I'll die in 2 days". And it happened exactly that way.

Deyev invented a fantastic technology. Only application of his **IFG** (internal fuel generator) could bring the country a saving of 15-20 million tons of gasoline a year. This is just a minor part of what Deyev actually created. He opened a new field – **the D-field**, and his devices are the generators of the D-field. Deyev **wore a ring**, as he claimed, **with**

soldered pieces of the body of a crashed alien ship, which gave him a lot of potential to do much. And what he made, invented and realized – all worked, and worked with exceptional success. He used to say that his **D-field** is able to work wonders. He was sure that it is capable of transferring the properties of one object to another through vast spaces; is able to make water clean the lake of harmful impurities in just one glass and transfer these properties of water in a tiny glass to the whole lake, to all millions of tons of its mass; Generators of the D-field are able to eliminate radiation contamination of huge areas. About himself, he said that he had **MADE HIS ORGANISM FORTY YEARS YOUNGER**: that **he was able to cure cancer** and could make people healthy through their photos. Well, dear Reader, if you have read the book "The Mirror of My Soul" and got to know about the potentials of the "**SvetL**" Programs, created thanks to the works and "calculations" of **A. Khatybov**, who closely cooperated with **A. Deyev**, does it remind you anything?

D-Generators can make a clean sweep of weeds, considerably increase

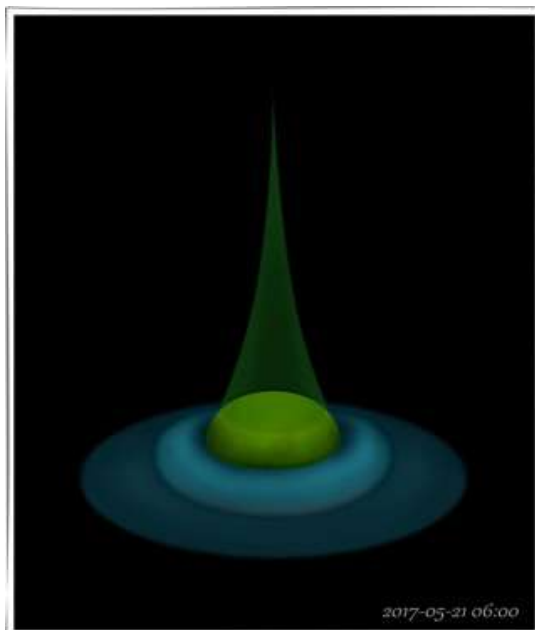

Interaction between the Generator and SvetL-Flora Complex

yields in the agricultural sector, in the latter case – by using the water processed by generators. They also allow increasing the productivity of livestock. Here I refer you to the second remarkable work of **N. Levashov** "[The Source of Life 1-10](#)", which he wrote as a "report" about the Generator's resources, and that was placed that time under his castle and the Man (himself), in "interaction" with plants and animals. Let me remind you that the **Programs for the Complex "SvetL-Flora"** were also created using the calculations of **A. Khatybov**.

After the death of **A. Deyev**, **A. Khatybov** created his own laboratory "**Rhythm Fund**", which developed "**Theories of Branching Systems**" (this scientific problem was then dealt with by only two scientific groups – **A. KHatybov's** and the Mandelbrot's group in the US), wrote several scientific papers, in particular, "**Real Time Mathematics**", "**Synergetics**", "**Cold-Plasma**

Synthesis". All works related to top-secret development of the military-industrial complex, since they were the basis for the creation of new high-technology types of strategic weapons. The availability of this weapon in the USSR allowed M.S. Gorbachev, to declare an "asymmetric response" to the US Strategic Defense Initiative (SDI), which led to curtailing the entire program of Americans who knew about these developments.

I did not set the task of studying and refining the details of **A. Khatybov's** autobiography in view of the fact that practically everything has been withdrawn and "cleaned" on the Internet and can not touch upon the formal moments of his biography, but I am sure that being under close attention of certain special services, he lived under conditions of everyday life and creative activity discomfort . From **B. Makov**, I knew how this amazing, uncommon and tireless researcher had been unprotected in the midst of worldly vanity. His sincere creative impulses **WERE OFTEN NOT UNDERSTOOD** in the official circles.

It is impossible to explain the reason for such a situation with simple words and images, but it has been going the way that the fate of almost all Geniuses excludes their recognition in their lifetime. **Alexander Mikhailovich Khatybov** (Morozov) was born on February 9, 1945 in the town of **Cherepanovo, Novosibirsk Region**. He got higher education in the most prestigious technical educational institutes of the country – Bauman MVTU then, in 1969, now the Moscow State Technical University named after Bauman. It is the first and one of the leading and largest technical universities in Russia, whose diplomas are highly quoted in Western countries. **Khatibov's** specialization was **mathematics, physics, chemistry, biology, medicine, celestial mechanics**.

I will give the most significant works and directions of **A. Khatibov's** activity for **Mankind** (I say it with full responsibility for my words).

Directions of his research:

- mathematics;
- physics. Unknown atomic structure;
- the golden section in an atom;
- Biology. A living cell. Principles of existence;
- medicine. Frequency balance of the human body;
- celestial mechanics. Calculations;
- noosphere. Habitat, gratings and conditions of existence;

His own development is used:

- creation of special formulas, physics of atomic structures, the musical table of chemical elements, etc.;
- mathematics "kaleidoscope" – 18-axis theory of symmetry (18 axes + 6 translations);
- the theory of prime numbers for the formation of frequencies of a living cell;
- golden section: phyto-functions of the golden section as the basis for the formation of a living cell (2 volumes);
- development of special formulas for celestial mechanics (example: value $y = \cos(x)$ for values $1 > x \Rightarrow 0.999999\dots$);
- the table of atomic structures and so on.

Those are his own developments used in "**SvetL** Programs and in everything related to these Programs.

Reasons for publications: the introduction of a different science, the formalization of the Earth Control System. Opening the section in mathematics – "Systemic Analysis and Operations Research".

Real-time tasks are solved:

- the traveling salesman;
- linear programming;
- destination.

Monographs:

1. Cold nuclear synthesis – 8 volumes.
2. Philosophy of mathematics – 1 volume.
3. The golden section – 2 volumes, 4 appendices including the Phyto-function of the cell.
4. Instruction on the Bath Science – 6 volumes, 1 appendix.
5. Control System – 3 volumes, appendix 1 – incoming texts, appendix 2 – answers.

The total **VOLUME** of printed **MATERIAL** (except for calculations) is **16.5 thousand pages**.

The versatility of this scientist **CAN NOT** but amaze and admire! And if you consider that most of the results of his research are not yet available to the majority, then how many other directions of knowledge emanating from this **AMAZINGLY CREATIVE MAN** still awaits us!

Five fundamental works of the author:

1. "Opening the principles of the action of genetic systems of multicellular organisms".
2. "Explanation of the principles of the Brain activity".
3. "Identification of the two-stage character of natural selection, which explained the mechanism of aromorphosis and the discreteness of biological evolution."
4. "The introduction of a new interpretation of the properties of neutrinos, radically changing the adopted model of the universe."
5. "Identification in the biochemical properties of the Earth organisms (in the genetic code, etc.) traces of the slow fundamental evolution of life in the Universe, with the multiple transfer of life by intelligent beings to the planets of younger stars."

You just **GO FURTHER INTO** the matter, at least, into the names of the works of **A.M. Khatybov**. They are not even known to modern science.

Of interest are the reviews to the works of **Alexander Mikhailovich Khatybov**. Note, how the bureaucratic academic circles with the deformed consciousness of the level of the dull partocracy expresses (or rather indicates) their opinions about the works of a talented researcher, unrecognized by them in the lifetime of this Genius, but so passionately eager to "snatch" a piece to themselves (not all, but many).

Think only of their wording.

1. **Nayashkov I.S.** (1986) – "...to close everything completely, strategic materials..."
2. **Sigal** (1984 CC of the USSR Academy of Sciences) – "...pass on all the materials to us for transfer to Israel..."
3. **Shankin** (1985, Chairman of the Scientific Council of the Higher School of the KGB) – "...wait until he himself gives us everything..."
4. **Chairman of the Scientific Council VNIIBT** (1986) – "...give everything to the academic council, and then we'll see what to do or who to send to..."
5. **A letter to the State Committee for the Inventions from Alexandrov A.P.** (1986, President of the USSR Academy of Sciences) – "If the author has also solved the problem of a traveling salesman, then this is the Nobel Prize".
6. **Marchuk G.I.** (1987, President of the USSR Academy of Sciences) – "...why do not you have co-authors? In the created scientific system, this is impossible... "

7. **Khachiyan** (1987, DFMN) – "Give me the principles of solving the linear programming problem, and the traveling salesman will be enough for you..."

8. **Maslyukov Yu.D.** (1987, Chairman of the Military Industrial Complex of the USSR) – "Has he not yet given all the materials to Semenikhin (NII AA)?"

9. **Kiyasov** (1984-1987, Head of the Department of the Military Industrial Complex) – "Hand all the materials to Krylov..." (Head of the Chair of the MIREA SAIIO).

10. **Krylov** (1986, Head of the Department of the SAIIA MIREA, DFMN) – "After handing the materials to the department there will be a decision to appoint you director of the" Institute of Man in Kiev."

11. **Nikitin A.N.** (1996, Chairman of the Noosphere section of the Russian Academy of Natural Sciences) – "Discoveries must be shared ..."

The list could be continued, but I think that's quite enough.

6.3. The Personality, we cannot do without ...

Sham Nikolai Alekseevich.

The story about Alexander Mikhailovich Khatybov would be INCOMPLETE without describing another legendary Personality and their cooperation. General N.A. Sham personifies the unique Russian spirit. The Man is a mine of information. His dossier is a step towards a new, clean, biological civilization, an escape from the deadly for the planet machine-chemical system, breakthrough into a new techno culture using the natural resources of the Earth.

Nikolai Alekseevich (born in 1940) worked in the KGB system of the USSR from 1966. Since 1974 he was in the central office of the committee. He got the rank of general in 1986. Later he was engaged in private business: one of the organizers of the company CINT (Center for Research in High-Tech Technologies), in 1999, he headed the Greenmaster Corporation, which



manufactured household appliances and various devices using defense technologies, then the chief director of ZAO the "First Leasing Company".

In 1991 he became the deputy chairman of the KGB of the USSR. In 1992 he retired for health reasons. This is according to the official version. But in fact, the reason for the resignation was a sharp conflict with then "democratic" head of the KGB Bakatin, who passed the Americans strategically important information and let out schemes for "wiretapping" the American embassy in Moscow.

It was under the cover of General Sham N.A. ANT business concern (Automation, Science, Technology) was working on several revolutionary trends in technology, engineering and other fields.

"The leading" genius was Alexander Khatybov, a mathematician from God, whom we introduced then in the ANT", the general said. – "In the US, billions of dollars of budgetary funds were spent on the creation of the newest generation of computers with a trillion of operations per second. Super-computers have already been called a wonder of the XXI century. And the domestic mathematics genius Alexander Khatybov fifteen years ago on a primitive, by today's standards, personal computer coped with tasks that required machines with an operating speed of thousands of millions operations per second". General Sham said that **THERE WAS NO** such a thing as speed limitation of computation for Alexander. Should Khatybov live in the US he would have become richer than Gates and would have been awarded several Nobel prizes long ago.

*"Alexander practically created **HIS OWN MATHEMATICS**, that made the experts **HAIR STOOD ON END**. If not to go into detail, **Khatybov's** method allows us to solve the most complicated mathematical problems ten times faster. For example, the famous "traveling salesman problem". It is classically difficult problem. Imagine that you are a sales agent, and you have to visit dozens of cities that are scattered around the map here and there. How to make an optimal route to visit each one, spending minimum of time on it? The more destinations, the more challenging the task. But Khatibov clicked on these tasks like seeds. We checked the efficiency of his system, suggesting that Alexander solve the problems over which the academic institutions had already racked their brains (naturally, without telling him that they had already been solved). The results surpassed all expectations: he coped with "the tests" in a matter of minutes, whereas it took traditional mathematicians days or even*

months to do it. That is, this Man could arrange a real revolution in the use of computers.

Through the KGB, it was possible to get an apartment for A. Khatybov and get a job for him in one of the institutions of the Academy of Sciences, which then plodded at the most difficult task of detection of nuclear weapons carriers with the help of space reconnaissance vehicles. But they did not want to notice him there, they did not give any work to him there, so Khatybov not only agreed to move to a new job in the ANT, but also brought with him some familiar inventors. Our idea to turn ANT into a center for the development of breakthrough technologies was supported in the 6th sector of the Council of Ministers of the USSR, established in 1988 under one of the government departments.

The principal task of this institution was the examination of large state projects: whether they should be implemented or not to. That time, the 6th sector was headed by **General Alexander Sterligov** (the father of a well-known businessman) and it was with him that we discussed the idea of turning ANT into an exemplary cooperative that is not engaged in primitive "buy-and-sell" and does not destroy home production but serves the development of the country.



We decided to take a risk, because the Soviet economy, under the influence of irrepressible "reformers", was already falling apart. The 6th sector of the Council of Ministers took over the business and prepared a government decree on the establishment of the state-cooperative concern ANT. And with it – the Board of Trustees, which included representatives from the State Committee for Science and Technology, the Prosecutor's Office, the Customs Service, the KGB and the State Committee for Economic Relations. I was a member of this council, too. The Revenues from these super-profitable operations were to be invested in the development of the breakthrough technologies that did not have world analogues. But everything has been ruined with the adventurism of former Sergeant Ryashentsev. Passing the Board of Trustees, he arranged a deal with the sale of ten T72 tanks from Nizhny Tagil. This ended in the rowing article in the communist Orthodox paper- "Soviet Russia" in February 1990. No one knew anything about the real tasks of the ANT, and a universal howl was raised. Communist newspapers

screamed at the brazen co-operators, while the democratic ones took it for the insidious machinations of the communist special services "privatizing" the country. And Gorbachev, as always, washed his hands. Then a grandiose investigation began in all seventy departments of the ANT. Prime Minister Nikolai Ryzhkov shed tears. Heads of numerous chiefs rolled along the carpet paths. And ANT perished. Not just a cooperative perished, but the first attempt to create a venture enterprise that could have helped to survive the economy of the USSR was disrupted".

At the same time, a Samara **scientist – biologist K.** stated that he was working on a project to **DESTROY** the **INSTINCT CODE**. The goal was the release of **IMMENSE INTELLECTUAL ENERGY**. He conducted experiments with dogs and wolves, in which he suppressed aggression and greed. There were also opposite results. At the private meeting of the department, the torsion field generator was demonstrated. These are two copper casings, connected in the base, surrounded by copper plates attached to them, and thick wires. This construction was switched on in the circuit and it began to work. So then the **PSYCHOTRONIC GENERATOR** looked like. But, as **A. Khatybov** proved later, it was a way to a dead end, because no one then knew the physics of energies, including intellectual one. To "rebuild" or readjust these "machines" was impossible, so **N. Levashov** considered that the most optimal way was to **DESTROY THIS EVIL**. And this was realized. I just want to emphasize that not all the psychotropic generators were then destroyed. Late, some models were restored and applied in different circumstances. Publications in the press show that experiments are being conducted nowadays that are encouraged by certain government circles, or rather, those who have already clearly expressed the complete absence of the Brain, but there is still an automatic desire, as they believe, to "rule the world". It's easy to see now the wish of some people to achieve the effect of psycho action on a large number of people. But what they are trying to apply from space, each time is of **NO SUCCESS** because of the impossibility of bringing the objects to space. These are **OTHER PROGRAMS** and another hisTORY.

Recently, on the territory of our country periodically there have been actions, or rather, attempts, of mass coding and zombification of the population. According to the Moscow Initiative Group of the Committee for Human Ecology and Housing, at least from **95 town and cities in Russia** they have received reports from citizens experiencing the consequences of psychotropic action. In the opinion of the citizens, the **REGIME OF IMPACT** was markedly strengthened before and during the elections to the

State Duma of the previous convocations and during similar large-scale events.

The consequences of such actions lead to the increased mortality, a high level of cancer, the birth of inferior children, a large number of suicides, especially among young people. According to the latest research of American scientists, long stay even in relatively weak electromagnetic fields leads to disruption of chemical bonds in the body cells. This ultimately leads to leukemia, Brain cancer and the prostate gland in men and to breast cancer, ovaries, and uterus in women. Recently, there are serious suspicions of special processing of water, tobacco products, chocolate, drinks, as well as sugar, milk, bread. This leads to ionization of tissues and blood of the body. Reduction of hemoglobin in the blood by 20-30 units, the appearance of micro-burns of the skin, rapid wear out of clothing; illumination of all photo materials – all this is thermo-electronic treatment. Unfortunately, this can not be stopped at a time, because the automatism of those individuals (no longer humans – I could not find another word) is still present.

Is there any protection and a way out of this situation? Yes, there is. They are the technologies that N. Levashov "developed" in his time, realizing perfectly well what was to be happening in the future, and the Programs that were created on the basis and with the application of these technologies and according to the calculations of A. Khatybov. ***Can we talk about this today? Not only can but we have to.***

I can say a little about the fact that Khatybov's group was engaged in "the annihilation of the negative alien (ebro) impact on the Earth." You can, of course, think of it with certain skepticism, but the works that **HAVE BECOME PUBLIC** nowadays, open your eyes to what was called (already in the past time) an "alien impact" and "biological control" of the Earth and Man.

I can hear from many people: "For a very long time we did not want to believe that Alexander Mikhailovich Khatybov wrote on his website," because he had long since directly claimed that the Earth was under biological control. This year (2016) we got (felt and realized) confirmation of this in various forms of events, ranging from climate disasters and ending with political events that began to affect and change the whole world before our own eyes. For example, observations of the hotspots of the Hartman grating indicate that over the past three years, it has begun to gradually disintegrate. Why disintegrate? The usual characteristic size of the Hartman grating (it is cellular) was about 2 meters. At the beginning of 2015, there

was a jump, and it increased to three meters. A month and a half after the first jump there was a second. It grew to 6 meters, in just a couple of weeks it increased in size to 9 meters. And I want to emphasize for the curious – at the same time **Airbus A321** “crashed” over the Sinai Peninsula, on board of which there were 224 people. It is getting very difficult to find now Hartman grating points. In the apartments in which we live (about the apartments and the Hartmann grating read in "[Knowledge from the Beginning](#)" I will not say it again) you might not find them at all. Moreover, they (these points) continue to vary very intensively. Practically almost every transition of polarization of the electromagnetic field is accompanied with the movement of this grating. That is, those who, apparently, really controlled all this information situation on the Earth, slowly begin to "go away." However, I'd like to say that today there are people, including N. Levashov's Friends, who I have mentioned, **CAPABLE** of **CONTROLLING THE STATE** of Hartman grating. I am grateful to them for providing me with information about this state and the changes that occur, which allows me to make corrections (sometimes substantial) and give certain recommendations to "**SvetL**" **Programs** users. I got carried away again. Although everything that I have written is interrelated.

6.4. Aspiration. And we will go on with Khatybov...

How to answer the question that today "torments" lots of minds: "If today we apply in practice what was written and said by **N. Levashov and A. Khatybov**, will there be any order in everything? Will there be an understanding of the ongoing events? And will it make it possible to put an end to our past and step into the **BRIGHT FUTURE?**" But, does it seem to you that you have heard something like that?

The old system always opposes people's new understanding the key points. It reacts to danger like a living organism. It is not important how true the new information is. It is important that it is dangerous. The truth for a living system is not that that corresponds to the facts, but that **ALLOWS** it **TO SAVE ITSELF**. The true information today is still not that is **TRUE** (the tragedy with the **Airbus A321** is an example), but that is **USEFUL** for the **SYSTEM**. The truth, in itself remote from this condition, is an abstraction. The formula is simple for the layman – "***If a lie gives life – it's the truth. If the truth bears death, it is a lie***". This formula was explained to me by N. Levashov, when we talked about practical application

of A. Khatybov's developments. "Let's apply the thought to the captain of the passenger ship," he said and went on "for him the main and the only aim is to take the passengers to their destination safe and sound. All the rest is lyrics. What contributes to the safety of passengers, is **THE TRUTH**. What interferes with the safety of passengers, is **A LIE**". Keeping this rule in your head, imagine – there appeared a hole in the bottom of the ship. It can be closed, provided that **NONE** of the passengers **KNOW** about the problem. If the passengers know about the danger, **THER WILL BE PANIC**.

EVERYONE WILL DIE. The truth of the captain is to hide the true information about the state of the ship from passengers. If someone accidentally asks him whether there is a hole in the ship, the captain must answer: "**There is no hole, everything is in order**". To keep his truth, the captain **HAS TO TELL A LIE**. Now we make the situation more complicated. On the ship there appeared a truth-seeker, informing passengers about what is happening. He says the truth about the state of the ship, which causes panic. It equals to his walking from cabin to cabin shooting people (the second option is even better, – people would immediately die without experiencing the horror of impending doom). What does the captain have to do? **TO MAKE** the truth -seeker **HARMLESS BY ANY WAY** – to arrest, throw overboard, shoot and so on. **Let it die one than everyone (including the truth-seeker)**. To maintain the truth, the captain has to not only lie, but also kill. "Now imagine," went on Levashov, "a social building where tens of millions of people live. If it collapses, most of the people living in it will die. The main truth for a senior in the building is **NOT TO ALLOW** collapsing the building. Everything else is an "instrument" for him".

To fulfill the task of introducing new technologies and perceiving **NEW INFORMATION** (from A. Khatybov, from N. Levashov and others...) adequately, we have to analyze the situation. This is like the situation when you are instructed to protect a nuclear power plant from terrorists. You identify key points and ways of accessing them. Further – ways of destruction. Based on the aggregate of data, you form the protection. It's the same with science, and with social construction – first identify the key points. But the point is **THE ONLY ONE** – the **WORLD VIEW**. If you "blow up» this foundation today and now – **EVERYTHING WILL COLLAPSE**. Then you have to comprehend and see the way that is able to utterly change it. A traditional bomb will not blow up the world view. **Only information is able to blow up the information**.

In what way has it been done for the last 2000 years? Having identified a strategic point in the construction, a security concept is being developed. From this moment **ALL EFFORTS** are focused on protecting the worldview. For those who "are engaged in it" (the Church, Academy of Sciences or the Commission on pseudoscience) it does not matter, whether the true worldview lies at the foundation or the wrong one. It is important that if it is broken in some way, the social construction is guaranteed to collapse. And it **CANNOT BE ALLOWED**.

In the USSR at least 3 times decisions were taken banning the criticism of the Relativity Theory:
1934 – resolution of the Central Committee of the All-Union Communist Party(bolsheviks) on discussion about relativivism;
1942 – resolution of the Presidium of the Academy of Sciences of the USSR on the Relativity Theory;
1964 – private resolution of the Academy of Sciences of the USSR banning all research groups, journals, chairs to adopt, consider, discuss and publish in advanced studies criticising the Relativity Theory of Einstein.

That is why the works of Alexander Khatybov and, to a lesser extent, N. Levashov's has been "wiped off". If written by Levashov could be taken in the initial understanding of the majority, for "science fiction", esotericism, etc., then Khatybov's writings were considered to be **DANGEROUS** with **SPECIFIC CALCULATIONS** and recommendation. But all these "protectors" of people from science and from the **NEW KNOWLEDGE** obtained thanks to these works did not take into account one thing – that the combined information obtained by "adding" (comprehending and combining) these works is like a nuclear bomb that can destroy **EVERYTHING**, if it is conceived and **DULY USED**.

Now, about the events ongoing before our eyes. If today's worldview had elite, then its truth would be the following – to preserve the foundation. Save it at any cost. It, this elite, would oppose the bearers of new worldview with the same fury as the Inquisition opposed dissidence. But their modern worldview, in accordance with what Khatybov wrote (and this is another clear example confirming the rightness of N. Levashov and A. Khatybov), does not have such strength. Its nothingness is manifested by the **NOTHINGNESS** of **TODAY'S ELITE**. We see this every day in the media and on the Internet. If, of course, we are able to see. This elite **NO LONGER SEES** the consequences of the dissemination of information that destroys the theory of eternal world, and therefore it is to be swept away soon. **But the principal thing is not to destroy the world.**

The processes are ongoing, similar to those that brought to the collapse of the Roman Empire (that has **NOT EXISTED** in the form it is presented

to us) or the Catholic civilization. What is now considered as a matter of fact values is ceasing to be so. The first open and serious blow was struck by Alexander Khatybov. **On March 31, 2010** an article by the well-known scientist Khatybov Alexander Mikhailovich was published under the title "**Is there science?**", where he particularly emphasized that **"there were many scientists who disagreed with Newton and Einstein who had been forbidden to criticize until recently!"**

Academician Vitaly Lazarevich Ginzburg, summarizing the development of modern science, brought out the main directions of the development of **physics in the 21st century. Its result is the modern science known to us.**

The created space, called science, where there is not even a hint at the structure of an atom, the structure of matter and actually the science. All attention is on dogmas (since 1964 they have banned to criticize Einstein).

"One can count on the fact that in the 21st century science will develop no less rapidly than in the past twentieth century. At the same time, physics has grown and differentiated so much that it is difficult to make out the trees behind the woods, it is difficult to grasp the picture of modern physics as a whole. Meanwhile, such a picture exists and, despite all the branches, physics has a "core". Such a "core" are the fundamental concepts and laws formulated in "Theoretical Physics" (**V. Ginzburg**) So, the list of "especially important and interesting problems" from the point of view of V. Ginzburg.

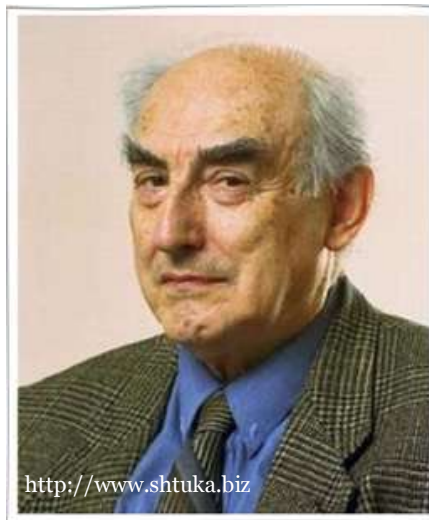

Macrophysics

1. Controlled nuclear synthesis.
2. High-temperature and room-temperature superconductivity.
3. Metallic hydrogen. Other exotic substances.
4. Two-dimensional electron liquid (anomalous Hall effect and some other effects).
5. Some problems of solid-state physics (heterostructures in semiconductors, metal-dielectric transitions, charge and spin density waves, mesoscopies).

6. Phase transitions of the second kind and related to them. Some examples of such transitions. Cooling (laser, in particular) to ultralow temperatures. Bose-Einstein condensation in gases.
7. Physics of the surface. Clusters.
8. Liquid crystals. Ferroelectrics.
9. Fullerenes. Nanotubes.
10. Behavior of matter in superstrong magnetic fields.
11. Nonlinear physics. Turbulence. Solitons. Chaos. Strange attractors.
12. Razery, grazery, super-power lasers.
13. Superheavy elements. Exotic kernels.

Microphysics

1. The mass spectrum. Quarks and gluons. Quantum chromodynamics. Quark-gluon plasma.
2. A unified theory of weak and electromagnetic interactions. W^{+-} и Z^0 -bosons. Leptons.
3. The standard model. Great unification. Superinification. Decay of the proton. The neutrino mass. Magnetic monopoles.
4. The fundamental length. Interaction of particles at high and ultrahigh energies. Colliders.
5. Non-conservation of CP-invariance.
6. Nonlinear phenomena in vacuum and in super strong electromagnetic fields. Phase transitions in a vacuum.
7. Strings. M-theory.

Astrophysics

1. Experimental verification of the general theory of relativity.
2. Gravitational waves, their detection.
3. Cosmological problem. Inflation. L-term. The connection between cosmology and high-energy physics.
4. Neutron stars and pulsars. Super new stars.
5. Black holes. Cosmic strings (?).
6. Quasars and nuclei of galaxies. Formation of galaxies.
7. The problem of dark matter (hidden mass) and its detection.
8. Origin of cosmic rays with ultrahigh energy.
9. Gamma-ray bursts. Hyper new.
10. Neutrino physics and astronomy. Neutrino oscillations.

To this list of "especially important problems" from the point of view of Academician V. Ginzburg, Khatybov makes a verdict in his article "Is there science?": Our modern science, that is, "horse science," still exists in the 21st century.



Now the opinion of the scientist Kuzichev Yuri Georgievich. "Is physics a science or a pseudoscience?"

Yuri Georgievich basically correctly noted the state of science, we are quoting his statements.

The substantive part of scientific knowledge about the nature of physics **was falsified**. Theoretical objective models were developed on the basis of **non-objective** information, but **subjective one** or **did not develop at all** and problems of natural science, as they said, "bypassed" or "removed." Here are the traditional ways of "bypassing" and the resulting models:

1. Guessing and fiction (the primacy of the subjective over the objective):

- universal gravitation;
- movement of the planets by inertia in absolute emptiness;
- with the free fall of the body, its potential energy becomes kinetic;
- with oscillations of the pendulum, its potential energy turns into kinetic and vice versa;
- thermonuclear reactions on the Sun;
- Stars like gas balls;
- etc.

2. Substitution of studied objects with "black boxes" and development of their mathematical models (**primacy of form over content**):

- the law of universal gravitation, the laws of mechanics;
- laws of electrostatics and electrodynamics;
- models of the theory of relativity;
- models of quantum and wave mechanics;
- etc.

3. Obtaining subject models from mathematical (logical speculation, primacy of form over content):

- energy (a materialized mathematical parameter);
- the potential energy of the lifted body (a materialized mathematical parameter);
- time (a materialized mathematical parameter);
- gravitational, electromagnetic and other physical fields (obtained from vector fields of gravitational forces);
- curved four-dimensional space-time (obtained from the mathematical model);
- sinusoidal-cosine transverse electromagnetic waves (the axis of the angular argument of trigonometric functions is replaced by the axis of natural numbers);
- etc.

4. Wrong interpretation of the phenomena of nature and experimental results (***the primacy of the subjective over the objective***):

- the increase in the speed of free fall of bodies is explained as the result of the transformation of imaginary potential energy into kinetic energy;
- the motion of the planets is interpreted as a movement by inertia;
- the curvature of the trajectories of microparticles in the cloud chamber is interpreted as a consequence of the interaction of imaginary electric charges with an imaginary magnetic field;
- after the unsuccessful Michelson experiment, physicists refused to recognize the reality of the ether;
- many years of unsuccessful ***hunting for an electron*** led to the appearance of the Heisenberg uncertainty principle;
- the spectra of atoms are explained as a result of the leap of electrons-waves from one orbit to another, under which they allegedly emit photon waves;
- energy exchange of objects through flows and ether waves is interpreted as energy exchange using quanta of physical fields: gravitons, electrons, photons, etc. ;
- etc.

5. Development of new models based on previously developed (logical speculation, primacy of the subjective over objective):

- Gravitons, magnetons, electrons, photons (quanta of imaginary physical fields);

- models of planetary atoms (built of electrons and protons supposedly possessing electric charges);
- strong interactions (they keep the protons repulsing from each other in the nuclei of atoms);
- the waves of Schrodinger and De Broglie (reflect the imaginary corpuscular-wave dualism of electrons);
- the quantum of action (Planck's constant) and the Pauli exclusion principle (appeared when physicists adjusted the hypothetical planetary model of the Nagaoka-Rutherford atom to nature);
- valence electrons (supposedly bind atoms to molecules);
- free electrons (supposedly form an electric current);
- van der Waals forces (allegedly retain in the crystals electrically neutral atoms and molecules);
- Black holes (appeared as a result of the manifestation of imaginary universal gravitation);
- etc.

6. Substitution of the phenomena of nature by imaginary (supposedly equivalent) phenomena (the primacy of the subjective over the objective**):**

- the energy exchange of the Sun with the planets and the effects of the forces arising from this are replaced by the influence of universal gravitation, the gravitational field, curved space;
- longitudinal waves of elastic deformation of the ether are replaced by transverse waves of the electromagnetic field;
- the energy exchange of the Earth with a freely falling body is replaced by the transformation of imaginary potential energy into kinetic energy;
- energy exchange of objects through flows and ether waves is replaced by energy exchange by means of quanta of imaginary physical fields: gravitons, electrons, photons, etc .;
- the change in the rate of evolution of microparticles (mumesons) at sublight speed is explained as a consequence of the change in the course of the personal time of microparticles;
- etc.

7. Models of theoretical physics do not reflect the causes and mechanisms of gravitational, electromagnetic and other interactions, therefore are useless for natural science, in other words, have no scientific value.

8. However, models have practical utility, therefore (based on the principle of ***practice is the criterion of truth***) were taken for **absolute truth** and transferred from theory to nature. As a result, physicists created their own imaginary world.

Jonathan Swift, in his time, ridiculed **Ptolemy and Newton**, having told with his Gulliver's lips about the simple-tongued Laputians, who, ***forgetting about the real world, lived in their own worlds.***

9. Physicists still live in their worlds—they study phenomena and objects that they themselves have invented (*quarks, strings, relative time, physical fields, black holes, large explosions, etc.*) or were artificially produced by atom crushing on accelerators, while the **real nature REMAINS UNKNOWN.**



The results of physics

The modern physical picture of the world resembles not even a patchwork quilt, but a bunch of **INCOMPATIBLE** flaps.

Not explained (or explained incorrectly):

- absolute motion and absolute energy;
- mechanisms of gravitation and repulsion;
- the device and solid rotation of spiral galaxies;
- the source of thermal energy of the Sun, cycles of solar activity, differential rotation of the Sun, Jupiter, Saturn and Earth;
- movement of the Moon, the Earth and other planets;
- tides, tidal and seasonal currents and winds, including monsoons;
- free fall of bodies and oscillations of pendulums, increase in the energy of freely falling bodies and the source of this energy;
- the emergence and construction of nucleons and their unification into three-dimensional systems – atoms, molecules and substances; chemical properties of atoms, molecules and substances;
- thermal, light and other waves; polarization and other properties of waves;
- physical properties of atoms, molecules and substances, including hardness, elasticity, heat capacity, thermal conductivity, thermal

expansion, aggregate states of matter, anisotropy and magnetism of crystals, attraction and repulsion of permanent magnets;

- the nature of the electric current, the thermal and magnetic effects of the current, the resistance and superconductivity of conductors, electromagnetic induction;
- causes of radiation and decay of atoms;
- long-term preservation of atomic energy in atoms, and its mechanical essence;
- etc.

What is physics?

To call physics the science of nature there is **NO SUFFICIENT** bases.

The methodology is a mix up. The metaphysical method, which permits the substitution of real phenomena for imaginary ones in solving problems, is transferred from applied physics to fundamental physics. Philosophers call it "**a new dialectic created by physicists themselves,**" and physicists themselves (see *A.B. Migdal* "Quantum Physics") divide it into Einstein's dialectic, Bohr's dialectics, etc. The difference between these "dialectics" consists only in the fact that Einstein ed **invented** only mathematical models of imaginary phenomena of nature, and Bohr – mathematical and subject ones. Physicists have heaped up fundamental theories that must reflect the structure of nature, and pseudoscientific theories that are, at best, suitable only for solving applied problems, and all these theories began to be submitted as results of natural science. Because of this, even **in theories there is confusion.**

Here are some examples:

- in the Berkeley course of physics, it is asserted that there is no absolute objective motion (relative to the ether?), since it was not possible to detect it, and in theories the speed of movement appears as an objective reality;
- energy is considered a measure of the motion of matter (relative to what?);
- relativistic effects are considered to be the consequence of motion with sublight speed (relative to what?);
- the law of inertia says that the body moves in a straight line and evenly (relative to what?) in the equilibrium of all the forces acting on it, and in the solar system, where, according to the theory, the gravitational forces

are balanced by centrifugal forces, the planets inexplicably fly in inertia curvilinearly and unevenly;

- the potential energy of the same body is considered positive (when the body falls to Earth) and negative (when the body orbits around the Earth), although energy, as a scalar mathematical measure of motion, can not be negative; as a consequence, the total energy of a body flying past the Earth along a parabolic trajectory with a second cosmic velocity turns out to be zero, since its kinetic and potential energies are equal and opposite in sign;

- according to theory, positive and negative microparticles should be attracted to each other and annihilate, however in atoms and substances electrons are not attracted to protons and do not annihilate;

- waves of the electromagnetic field are considered identical to the microparticles moving in the void (*the particle-wave duality of electrons and photons*);

- wave electrons inexplicably fly around the atomic nuclei, jump from one orbit to another, emitting and absorbing photon waves, bind atoms to molecules and form electric current in conductors;

- when atoms are fragmented (on accelerators), uncountable fragments are obtained, in the classification of which a confusion arose; Nevertheless, physicists are trying to explain the structure of the universe according to these "brick fragments".

Refusing to develop subject models and naming mathematical models by physical theories, "... physicists have sunk into the hazy atmosphere of matrices and wave mechanics, into mathematical operations. They made the right conclusions, but at the same time they did not understand the physical reality behind them." (Max Planck).

A famous theoretical physicist, Nobel Prize winner **Richard Feynman** for many years was engaged in the popularization of physical theories, but he also did **NOT AVOID** doubts about their scientific value and honestly spoke about this at his "popular" lectures. Here are some excerpts from the lectures: "Gravitation could not be associated with the laws of motion.. It can not be explained by any other phenomena ... Quantum physics is a monstrous confusion... **NO ONE UNDERSTANDS** why nature is so arranged ... There are no good theories to explain the structure of nature." (The same thing was written by **N. Levashov**).

Judging by the methodology and content of the theories, physics has been developed as an art of solving applied problems, that is, as applied mathematics (*mathematical physics*), and, calling it the science of nature,

physicists mistake the wish for the reality. Our civilization in the **COGNITION** of **NATURE** has come to a deadlock, and to a large extent, the main ideologists of physical science – *Newton, Maxwell, Einstein and Bohr are guilty of that*. Such an impartial picture of the state of physics was given by another scientist, **Yuri Georgievich Kuzichev**. He noted that the results of physics were sad, and there were no sufficient grounds for calling physics the science of nature. And **AM. Khatybov** in the article writes that Yuri Georgievich, in the main, correctly noted the state of science.

Let's consider the question of the existence of science from a different point of view. As the author of this book I will introduce a small supplement for a correct understanding, of what Khatybov writes further in his article, covering this question.

Our planet the Earth, as a **CERTAIN SUBSYSTEM**, enters a more complex solar system and is part of its governing system, once inculcated by the Supersystem to protect life from accidental factors. *Human civilization is governable*. Up to now, two such systems are known: *The original (Native) and Interventionist Earth Control Systems*. **(2011.04.24** on the Earth there was a change of the Control System – the Interventionist Control System was switched off and the Native Control System (NCS) was again switched on).

We have the Earth Control System, which includes several Control Complexes, stationary monitoring systems and objects (UFOs). All this is interconnected not only among themselves, but also with the Sun, the Moon, the satellites of the planets. The aim of the Control System is to **CREATE** the **BIOSTRUCTURE** that fully meets the requirements of the Program. To solve this problem, all conditions have been created, except one – *no structure has to interfere with the operation of the Control System*. Therefore, the world perception is given in a distorted form and, first of all, it concerns atomic structures and the principles of creating the universe. Instead, a partial instrumental base (mathematics) is given. The entire development of science is the development of mathematics and modeling without practical meaning. At the same time, science does not (and can not) solve **NP-complex and NP-difficult** problems (problems from the class **NP**⁴⁰ in the theory of algorithms), missed the "golden section", without

⁴⁰ **NP-complete problem** – in the theory of algorithms, a problem with a "yes" or "no" answer from the NP class to which any other problem can be reduced from this class in polynomial time (that is, using operations which number does not exceed some polynomial depending on the size of the initial data).

which one can not approach the elementary atomic structure. Further – technical information is provided, but only a few correctly perceive it and only under certain conditions create real products. This is available only to those who have a connection with the Control System. **Let us recall some of them.**

1. **Leonardo da Vinci.** Overtook the development of the technical base for more than 400 years.

2. **Nikola Tesla.** A genius whose works anticipated the most fantastic thoughts of scientists.

Present day personalities:

3. **Burlachenko Arnold Ivanovich.** Having not-complete secondary education, he developed the theory of sound and created dynamics that surpassed any known samples in quality.

4. **Deyev Alexander Alexandrovich.** Radio engineer. He received from the Control System drawings and principles of using the devices created by him. He created the theory of the D-field. Later, the "participants" renamed it "Spinor", and when Akimov dragged away one of the devices, it became "torsion". However, having no connection with the Control System, everything that they tried to use without Deyev is Krylov's fable "the Monkey and the Glasses".

What is the peculiarity of this list? ***None of them got into an atom, that is, did not create new theories, but their technical realizations puzzle the whole of modern science.***

So, we have:

- the top of the pyramid – mathematicians creating pseudostructures;
- Single geniuses, there are few of them, and they all receive only what can really be realized;
- creators, businessmen, and other research figures. Here everything is collected – from criticism to the creation of their own theories.

So, as soon as the "dynamics" appeared, there came into being etherodynamics, rhythmodynamics and so on, by analogy with the fact that

Thus, **NP-complete problems** form in a certain sense a subset of "**standard**" **problems in the NP class**: if for some of them a "polynomially fast" decision algorithm is found, then **any other problem from the NP class can be solved just as quickly**".

as soon as a virtual memory "appeared in the computer," virtual killers "appeared in movies.

What is the brake on the development of science? – Once again I say – **World perception!**

The point of view of science on the material (and intangible) world: **solid body → liquid → gas → unorganized plasma.**

Atomic structures, naturally, are searched in a solid body, for which they create synchrotrons, colliders. The same will happen if in the orchestra pit during the performance of the symphony throw a bomb and after the dust is settled to reassemble from the remaining grains all instruments and orchestra. It is this science that it is offered to get down in the XXI century!

Let us consider a different point of view. Strictly organized plasma → material structures (solid, liquid, gaseous).

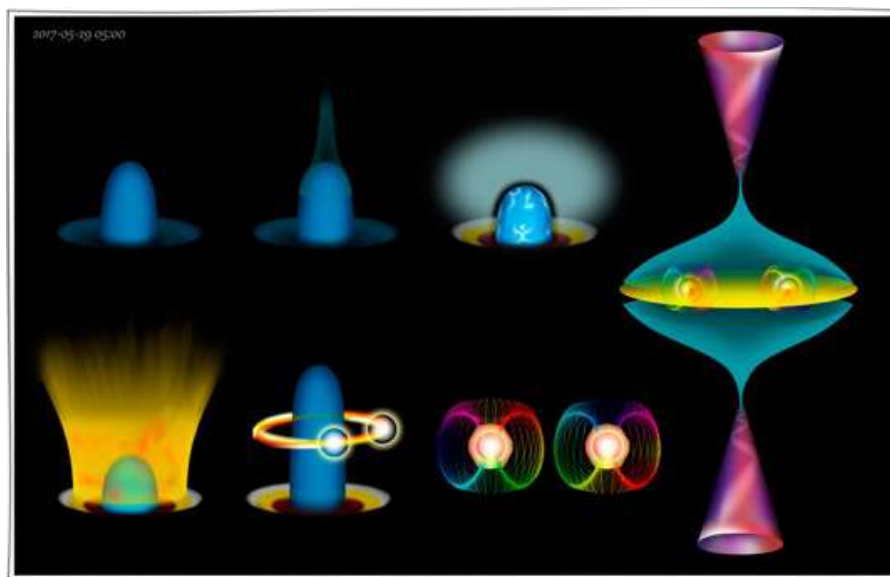

Atomic structures should be considered only in the upper octaves of the plasma. The Control System has a k-structure today; all the gratings are built on cubes (in organic chemistry the cube is converted into hexahedron).

Octaves	Description
128	The tact interval. It is given by the Sun, it is taken for the speed of light
78-126	Control systems, storage of humanoids and "poltergeist"
74-76	Control systems for all insects
72	The brain of the "golden million", genotype 461
68-70	The brain of the "golden billion", genotypes 441, 442
66	The brain of the rest of the world's population, genotypes 421, 422, 423
64	Upper octave of material structures

62	Control of material structures during transmutation
40-60	The energy corridor (Tesla worked with octave 60)
34-38	Corridors of "o-transitions" after death
30-32	Complex mixtures (oil type)
24-28	Water
16-22	Gas

Modern science is able to work (and create technical devices) **NOT ABOVE 64 octave**, all kinds of instruments can not be created above 64 octave. **Anything above 64 octave is a non-inertial mass, that is, there are no gravitational frequencies there.**

The basic atomic structure is 128 octave, and if it is "plucked", we will reach 64 octave. Until **2012** the Control System consistently passed first **to 224 octave, now – to 512**. But even at a tact interval of 224 octaves, the speed of light will be billions of times more. What will change in this case, we will consider later in the example – "how the Earth's axis affects the bank account".

Science clings to the theory of the Big Bang, quarks, metallic hydrogen (it can not be, because there is still a non-inertial mass of tritium), Darwin's theory (or alternative – divine) like a drowning man snatches at a straw.

Direct evidence of the absence of science is the presence of the church. How many church miracles science has explained? Start with the holy fire at Easter.



Afterword

- The Cosmos exists without the Big Bang;
- The Earth, planets are artificial structures, had been created for more than 16 billion years;
- Man is the highest creature, had been created for tens of billions of years;
- a monkey – human humanoid;
- the whole animal world, insects are created to control the Human frequencies;
- radioisotope method can not serve as the proof of antiquity;
- the moon, the Sun, the satellites of the planets are alien structures.

Ufology is not a science, but a collection of statistical material (and without any sense).

The Control System removed some frequencies from communication tubes with satellites, and astrology, as a way of obtaining information, can be forgotten.

A. Khatibov's article "Is there science?" in "scientific circles", as I have already said, triggered the reaction of a bomb that exploded. It is not difficult to guess why. However, the movement of the Mind is impossible without releasing from the excess of memories and controlled unconsciousness. It **CANNOT** go on like this endlessly. It is impossible to grasp the immensity and reconcile the uncoordinated, relying on the "scientific baggage" that A.A. Khatybov so skilfully criticized. He, as a plastic surgeon, had to "cut through the living", **GUTTING THE BRAINS OF ACADEMICIANS** and removing the corpulent tissue for the sake of a new understanding and a new philosophy, and also the physics of processes, having perceived which one can move forward.

I am sure that the rejection of the previous experience (and especially in science and technology) is an indispensable feature of the true philosophizing in this direction. But in order to **REJECT**, first it is necessary to **UNDERSTAND**. To understand in order to **UTILIZE**. Of course, this path is not without risks and is fraught with certain costs in the form of amateurism, nihilism and philosophical childishness. But I always thought, taking the example of both A. Khatybov and N. Levashov – that the path of dutiful dogmatism and the **EXALTED PUPILLAGE** would surely lead to a dead end, and therefore **ABSOLUTELY UNACCEPTABLE**. I got convinced in it not once after N. Levashov was gone.

Practically all the works of A. Khatybov, as he himself wrote, and I know that it was exactly so – were the ***deciphering of texts received as an explanatory basis for analyzing the current situation and for carrying out certain calculations on "requests» of the Control System*** so that to identify the program functions performed as they are implemented. ***Alexander's first acquaintance with it took place in 1995***, when the screen of the computer on which he was working, turned (was turned by the "invisible force") by 180 degrees and there was a running line with the text that carried the information. The data was provided by the Earth Control System.

B. Makov witnessed this "transmission». Here's what he told me about it. Being a friend of A. Khatybov, he often came to see him. At a certain time



(in the evening) Alexander took a thick pack of writing paper and a pencil. He sat at the table and for a while just **DID NOT REACT** to anything that happened around him. He wrote on sheets of paper, non stop, dropping these sheets on the floor. It seemed that he **DID NOT UNDERSTAND** what he was writing. He just mechanically reproduced on paper that information that was "transmitted" to him, without delving into its essence. Boris said that after the beginning of this action, he could not be in the apartment. His brain was just bursting with tension and he ran out

doors. It only proves that the information is personified when it is transmitted (imbedded) to specific people depending on the task being solved. The next morning A. Khatybov put the sheets together into a pack and sensibly got down to processing the information.

THE INFORMATION COMMUNICATION with the System until the fall of **1995** was of a one-sided nature without the elements of any technical support at the stage of direct reception from it. The Brain potentials in receiving information are still limited, no matter how it is thought of. **By autumn 1995** A. Khatybov developed a software product that allowed deciphering all the information from the True Earth Control System. Later, after approbation of the developed product and application of the **SERIES** of **TECHNICAL EQUIPMENT**, A. Khatybov's developments of certain skills in "interaction" with the System, the communication became stable and bilateral both direct transmission of information and information on the "question-answer" scheme». This allowed A. Khatybov to receive confirmation for the calculations that he had already made, and move forward far away, unlike "modern" scientists and science.

It should be noted of the peculiarity of that not distant time, – the Interventionist Control System was in a **GOOD WORKING CONDITION**, and its Control System held under rigid control all the reality. Any manifested fragments of out-of-system information, unauthorized on its part, were subjected to liquidation together with the bearer. It is clear what kind of danger Alexander Mikhailovich was exposed to. Only **in 2012-2013** I began to realize what was happening at that time (in those "evil nineties"), why I found myself participating in this or that

event, what those events were aimed at and what was achieved and accomplished, including "through" me, as one of the rather high Russian federal official of that time. Everything happened exactly as it should have been, without any regard for human emotions. Was this realization important to me? Of course, it was, precisely in understanding those events, because today the work related to getting a contact state with the Earth Control System is taken as a **COMMON WORKING PROCESS**, but in reality it is beyond the scope of fantastic imaginations. And the real merit in this matter belongs to the true geniuses – **A. Khatybov and N. Levashov!**

We are now talking about the New Control System. And in the framework of the old system, this was done somewhat differently, through the so-called **"ENLIGHTENING"** of a **SPECIFIC PERSONALITY. D. Mendeleev** "woke up" and drew (wrote) his table, the application of which has brought Mankind to where we are all now! Being in Switzerland (Alps) **V.I. Lenin** suddenly as from the "horn of plenty" began to "pour out" articles and works, and also got oratory abilities, which led to what is called the October Revolution". K. Marx, being quite an ordinary individual, suddenly wrote a genius work **"Capital"**, thus legalizing the revolutionary ideas, later "picked up" by Lenin, but, most important, he legalized and "inculcated" into people's heads a **SURPLUS VALUE** as a tool for **ENRICHMENT** of **DEFINITE PEOPLE** (a certain genotype of the Brain). I was on friendly terms with **Mstislav Rostropovich and his wife Galina Vishnevskaya**. Once, visiting Kronshtad, we talked about music. **Rostropovich** told me about his friend, composer **Alfred Schnittke**, who when asked what the way was to learn to write such beautiful music, said: "No way. It's not me, Mstislav, **I AM WRITTEN BY...** " That time, I was also visited by so-called "insights". It was both the idea of creating the **Public Chamber of Russia**, which was voiced to President Boris Yeltsin on the example of the Public Chamber, which I created in Leningrad Region, and the "division" of Russia's territorial structure into federal districts. To be true, I justified the division into **12 districts**, taking as a basis the dislocation of troops on the territories. With the arrival of the "new" government, this **PROJECT WAS TAKEN** as a basis, but the division was first in **7 federal districts**, and then the **8th district** was added. Until now, I **DO NOT UNDERSTAND** why that was "done" that way and the reasons for this could not be found that time either. One thing eases my mind – the fact that it was done within the framework of the "plans" of the old System, with a certain goal already known today, and all this just did not take

place and it **NEVER WOULD**. And there are many such examples. To be true, the question of the Bath, Spade and Broom did not exist then.

A. Khatybov was given in detail the material to solve the main task of the System – the so-called traveling salesman task (on this basis he developed algorithms and programs for solving problems from the class of "System Analysis and Operations Research"). **The Programs** created and calculated by Khatybov are used to calculate the control options for the **MATRIX BRAIN** with the dimensionality of the **problem 512x512**. All this is set forth in his work – "Instruction on Bath Science" (6 volumes, 1 appendix), which is practically inaccessible nowadays. When I "closely got engaged" in "**SvetL**" **Programs**, their modernization and creation, I applied A. Khatybov's calculations, whose special attention was turned to the **GOLDEN SECTION** as the basis for constructing all structures on the Earth. New types of Program functions have been created. Calculations on transient processes have been made, atomic schemes, their structure, interrelations and principles of formation of both the biostructures and the processes taking place in them, under the control of the Brain in interaction with the Generator and its Programs ("SvetL" programs) have been obtained.

The entire frequency balance of the world around us and all biostructures is **BUILT ON PRIME NUMBERS**, each containing *more than 19 digits in the 10th number system*. Khatybov obtained a series of prime numbers to control all major changes made under the Program. This was important, because changes that affected almost the entire Life Support System on the Earth had already been launched and implemented.

There is practically no area where "through" the information received by A. Khatybov there **WOULD NOT HAVE BEEN** affected the interests of identification with modern science, beginning with mathematics, physics, chemistry, biology, medicine, psychology, celestial mechanics, etc. Knowing this from various sources, I came to the conclusion that the **INFORMATION HAD BEEN BEFORE** the space, energy, matter, time and all forms of existence that once began to exist. We **ARE NOT ABLE** to think of what it was, but it turns out unequivocally: **INFORMATION PRESEDES** every existence, at the same time not being anything out of the existing.

I will cite several **Laws**, defined by A. Khatybov, as reference points for the movement in cognition (there is no way to cite all of them today). They are called: "**The Laws of Maxim.**" There are many who ask the question: "Why Maxim's, not A. Khatybov's?" The laws that A. Khatybov set

out and substantiated are those that he created, and named in honor of his son **MAXIM**.

In total, there are 36 Laws and 192 corollaries.

Laws of Maxim on Movement

The first law of Maxim on Movement.

The mass is inert only in the absence of an electric potential.

The second law of Maxim on Movement.

The sum of the electrical potentials in its octaves is always zero. Example. Lightning moves not by a random trajectory.

The third law of Maxim on Movement.

Any violation of the conditions for the existence of a magnetic pulse in a living cell causes its death with a redistribution of the electrical potential (this is confirmed by the experiments carried out by V.I. Dokuchaev).

The fourth law of Maxim on Movement.

In a non-inert system, the time of motion is always accurately related to the difference between the accumulated negative electric potential and the limiting (negative or positive) electric potential in its octaves

The fifth law of Maxim on Movement.

The gravitational partial of the non-inertial body is always zero.

The absence of resistance of the electrical potential (of one sign) leads to a non-inertial mass in motion, limited only by the ultimate (of one sign) vacuum resistance. If the electric potential of the medium of motion has the opposite sign, with respect to the sign of the electric potential of the non-inertial mass, then the potentials are summed.

The sixth law of Maxim on Movement.

Movement makes the sound which tone corresponds to a tone of the spent electric potential. The pitch of the sound depends on the current value of the electrical potential of the non-inertial mass.

The seventh law of Maxim on Movement.

The time of motion is determined by a small octave. Its electrical potential can not be used in any other way than for organizing traffic.

The eighth law of Maxim on Movement.

The space of motion is determined only by the gravity-magnetic contour of the Cosmos. The gravity-magnetic contour of the Cosmos has a closed volume, and no object can leave it.

The radius of the gravity-magnetic contour of the Cosmos is $10728 C$ (C is the pulse speed at **48.5** octave in the Earth's magnetic field).

The ninth law of Maxim on Movement.

The magneto-electric motion field is formed by the gravitational field of a given frequency, therefore it is sufficient to have a gravitational generator at the using activity. Gravity-Magneto-Electric Generator (small power) serves to move to an adjacent space.

The tenth law of Maxim on Movement.

The total energy mass (including non-inertial) should not exceed the energy mass of the launch complex (for example, the Moon). The electrical potentials of inertial bonds are recalculated into **56.5** octave and can not be used to form a cone of superposition of gravitational frequencies.

The Eleventh Law of Maxim on Movement.

In cones formed by gravitational generators of at least two non-inertial masses, completely inert masses can be located, their electrical potentials converted into 56.5 octave should not exceed the electric potential for the formation of cones.

The twelfth law of Maxim on Movement.

The non-inertial mass of the various electric octaves of the state during motion must not have a separation more than the value of C of the adjacent octave. The value of C is in the eighth law.

The maximum separation of the non-inertial mass during the movement is **32 C**. Explanation: Each **NON-INERTIAL** mass (of its octave) moves independently.

Corollary 1. Each cosmic object possessing a non-inertial mass has its own lifetime.

Corollary 2. The inertial mass has a lifetime determined by the density of the charge equivalent of the bond of the ionic structures.

Corollary 3. For a non-inertial mass, the decay time is determined through the decay rate of the highest octave of the bond frequency. (When the spacecraft moves without a magneto-electro-gravitational generator,

THE BRAIN is **LIQUIDATED** first and foremost, and the last is the casing.

Corollary 4. Any non-inertial mass has a magnetic field, and the decay rate of the magnetic field is determined by the time.

In conclusion, let's consider the effect of mass ejection, or jet motion.

The constructions using a different method of producing jet thrust, other than the Laval nozzle are unknown. But in the ancient drawings we see images of astronauts in ships that exclude the use of the Laval nozzle. Taking into account that the additional term of the well-known formula is used in calculating the Laval nozzle, this imposes a ban on the use of other principles for obtaining reactive thrust, and the specific impulse is in the range of 300-440 seconds.

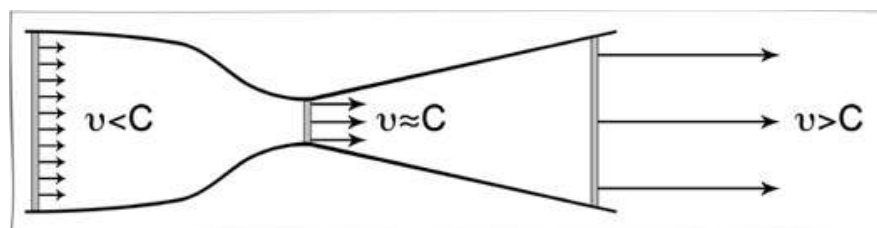

Using the Ranke effect, it was possible to calculate a construction without the Laval nozzle with a specific impulse **of 8000-32000 seconds**. How much this changes the construction, the control system, and also increases reliability, one can only assume. The first samples were successfully tested in 1988 and on the recommendation of the 6th sector of the USSR Council of Ministers (V.V. Babayev) left for the USA where a laboratory was immediately set up. In Russia, this direction was liquidated, but in the United States they were not able to figure out the effect without the author's attendance.

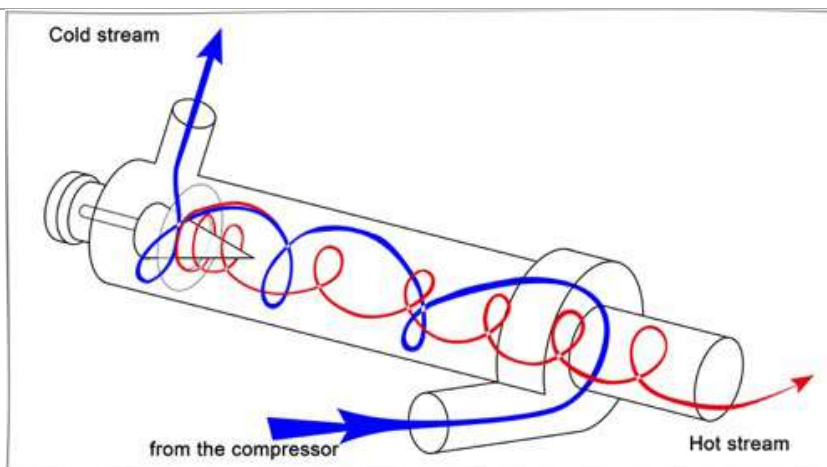

The use of other principles (such as the Meissner effect) **IS NONSENSE** – without knowing the real constants, the structure of the atom, and also **Maxim's laws**, external effects can not be the basis of motion, especially *when using Bohr's physics and Mendeleyev's table*.

There is also **MAXIM'S TABLE**.

If we say briefly about Maxim's table, then this is a **grating from 12 to 256 octave** of all possible connections of structures for all types of fields and their interactions. In total one can get 1064 elements out of Maxim's Table, differing at least by one sign. In accordance with this, for example, **Vacuum** is a medium having quite specific energy characteristics. ***Movement in a vacuum without gravitomagneto-electric generator is like movement of chalk on the blackboard,- does not take long.***

Temperature. The electrical potential value at certain value of the phase-change parameter.

At an average point (parameter), the maximum temperature is 6428°K. Until 1995, this parameter for the atmosphere was at the midpoint. If we take zero reading of the electric potential, then the shift to the positive area leads to fires (not the closure of the electrical wiring), and *the shift to the negative leads to the transformation of any material into the sand ...* (Recollect the deserts and "punishment" for the planned Sinai catastrophe).

A. Khatybov's albedo is understood **NOT AS** the reflectivity of a substance, but as the **DIFFERENCE** of the **VALUES** of the energy potentials of the structure under consideration (the property of changing the electric potential under the action of a magnetic pulse and a gravitational

wave). That is, everything is interconnected and completely different from what modern science "explains" to us.

All these A.M. Khatybov's works were passed to the Academy of Sciences with the support of academicians A.P. Alexandrov, G.I. Marchuk and Yu.S. Osipov. But the chairman of the State Property Committee I.S. Nayashkov **DID NOT RECOMMEND** the Committee to make public the works due to their strategic importance. President M.S. Gorbachev was reported about the work, who at that time was too far from it. The works became known to the military-industrial complex under the USSR Council of Ministers. Their attendance was entrusted to the 6th Department of the KGB of the USSR (personally to N.A. Sham).

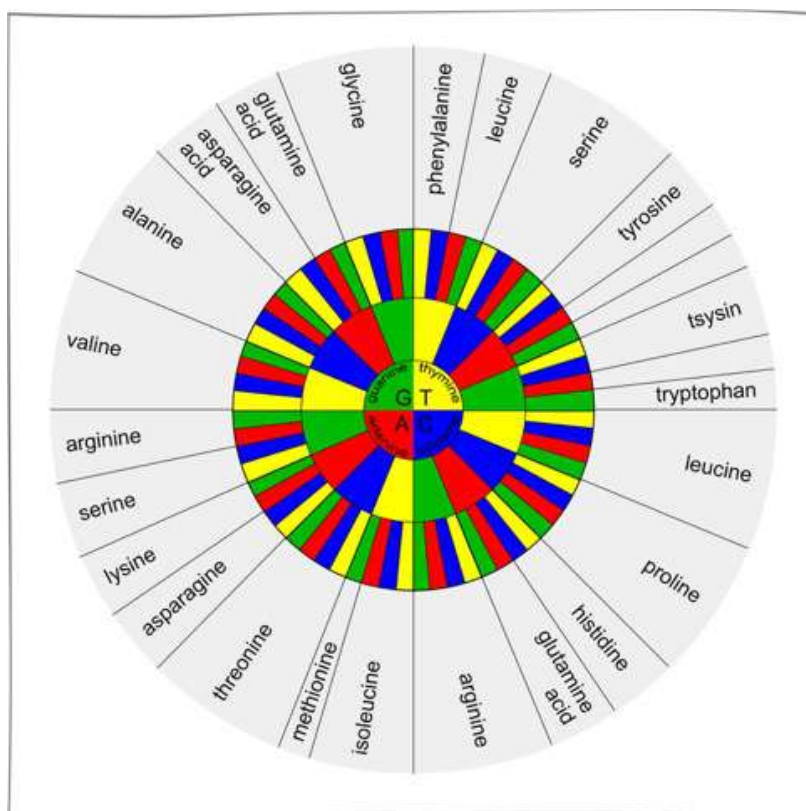

An attempt to calculate the variants of the **BRAIN MATRIX** control with the dimensionality of the task 512x512, without A. Khatybov's "participation" in it, did not result in any success, which extremely "upset" the representatives of "science" who aspired, first of all, to **CONTROL MASSES OF PEOPLE**. Why?

The entire "science" and all the "research workers" around the world were not able to **GET TO** and **COMPREHEND** the fourth **CODON of DNA**. It is in the fourth codon there is that mystery to which Ebr System

(and all of its "academicians" with their science based on the "Horse Science") have not been able to "get", and for this reason the "scientists" of the whole world have not been able to solve the problem on the extension of biological life.

It is for this reason that they were not able to get to changing the Design of Man's Brain and **MAKE A CONTROLLED ANIMAL** out of him. And it was only thanks to the works of N. Levashov and A. Khatybov that this **FUNDAMENTAL KNOWLEDGE** became accessible to scientists' understanding. By the way, on the site of Makov (<http://www.salvatoremm.ru/>) one can know about the fact that it is the geneticists and gerontologists of Russia who will be the first to solve the problem of biological existence of the flesh cell, and accordingly, the biological extension of Human life. Positive actions in this direction are being realized.

I will quote one of A. Khatybov's notes intended for those who are eager to move forward in knowledge. It says a lot. ***"I imperatively recommend the thinking and having ears.*** For the time being the network is not usurped by the idiots censoring what they "are deprived to understand by God...", learn and go forward without hesitating. Learn to think at least here on these examples, which I quoted time after time to the «venerable scholars."

The **spine** below the ribs is called "pony tail" in medicine. This indicates at the **CONTINUITY** of **KNOWLEDGE** and brings the king of nature on a par with mammals, and in some cases also with herring. It is known that the fish also have the Brain that the fish breathe oxygen, and since they have **NO LUNGS**, then they have a certain Generator of extracting this oxygen from the water, that is, the **GENERATOR** of **COLD NUCLEAR SYNTHESIS**. Man does not have such a Generator, so the fish are more intelligent creatures than Humans?!

It is known that **the heart** "pushes" the blood, but if you calculate the load, it turns out that the muscle energy of the heart is **INSUFFICIENT**. In addition, the Human has blood vessels of 1 micron (these vessels account for more than 90% of all blood vessels). At the same time, the **erythrocyte has a size of 7-9 microns**. The fact that the erythrocyte is not able to get into a smaller blood vessel can be demonstrated by experience. Take the pillow, come up to the tap in the bathroom and try to push the pillow there. But the main thing is not here, but in the fact that medicine does not know **WHETHER THERE IS AN ERYTHROCYTE** in the living blood. " So

how does the erythrocyte take its place there? The answer (from A. Khatybov) – there is **NO erythrocyte IN THE BLOOD, it is formed OUTSIDE** of the **CONTROL SYSTEM (or the Brain) as a sedimentary structure with loss of an octave of its state** (with the decrease in the octave by 2 times, the total size increases by 1.284 times).

Similarly is **the birth of a child**. The spermatozoon has an ionic structure and the Brain in the **octave 96** (less than the size of an atom). Once in the "sandbox", that is, in the structure in which the maximum scattering takes place, the spermatozoon quickly grows up (losing the octaves of the Brain). When the equilibrium state (**octave 71.225625**) is reached, a "signal is given", and there comes delirium. And here follows an important factor: **a new Brain (Entity) comes in a higher octave, and the functions of the old Brain (Entity) can only be interfered partially.**

All this is well illustrated in the works of N. Levashov, concerning the Entity coming into the biomass for the development of the fetus and the birth of the child. Let me remind you that the difference is only in terminology. N. Levashov "uses" the word "Entity" (the soul) for a more understandable association in the imagination of the reader, and A. Khatybov "uses" the word "Brain", which is identical and equivalent to the terminology and concept of N. Levashov's. I also want to remind you that about the existence of a non-inertial mass (the structure of octaves more than 64, united by octave 96) "modern science" **EVEN DOES NOT SUSPECT**, although the fireballs and their action have been known for a long time. With octaves higher than 64 we have 8 different atomic structures (in A. Khatybov's works they are given nominal names – **neutron and antineutron, neutrino and antineutrino, etc.**). Each of these structures has a range of existence (charge). When the charge is lost, the potential of the lower octave increases. **Example:** when transferring the octave's power 65.5 into 32,125225 we get a powerful lightning discharge (commensurate with the power given out by a large HPP for hundreds of years), although the initial state can not be seen.

You see how simple everything is, if, of course, you **STILL** go to the **BATH (A. Khatybov's)**, using the **BROOM (N. Levashova's)**. Here it is individually offered in the hands of everyone moving in direction of knowledge – a large **LABOR** spade for creative and independent work in finding and comprehending the sparkling nuggets of **THE TRUTH**.

And so A. Khatybov painted **Man as the king of nature** and his place in "society":

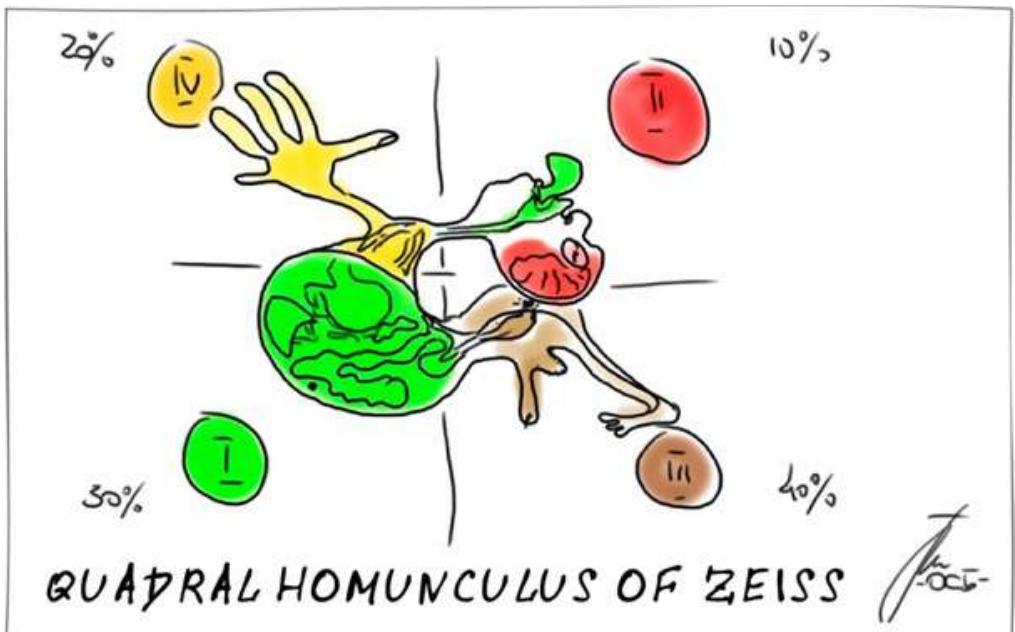
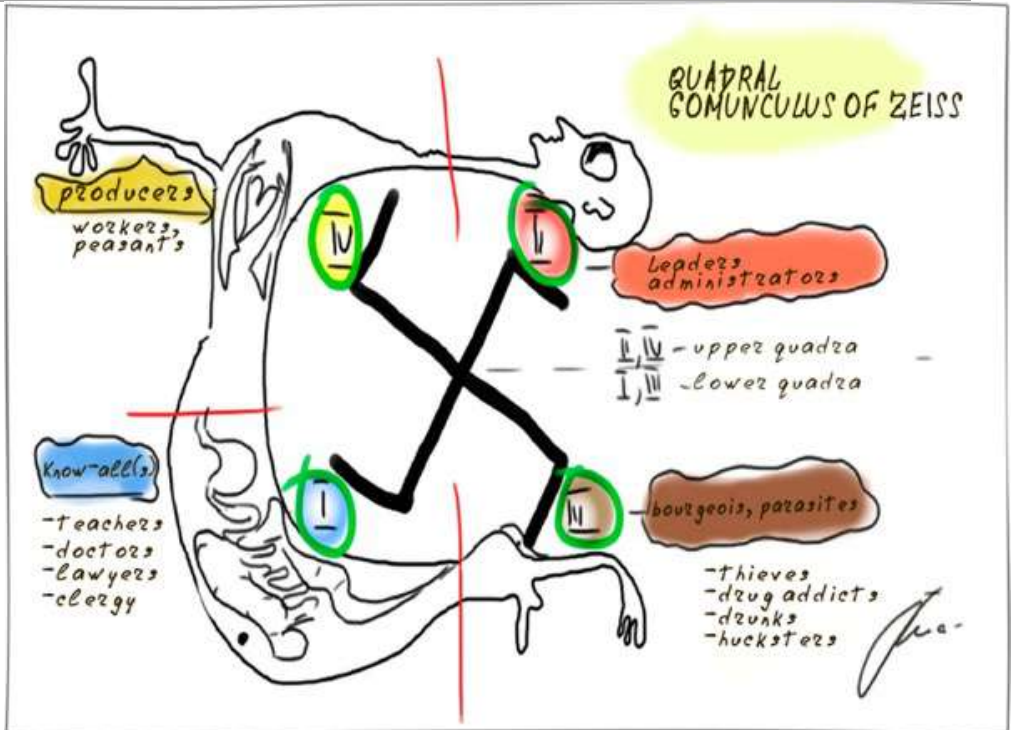

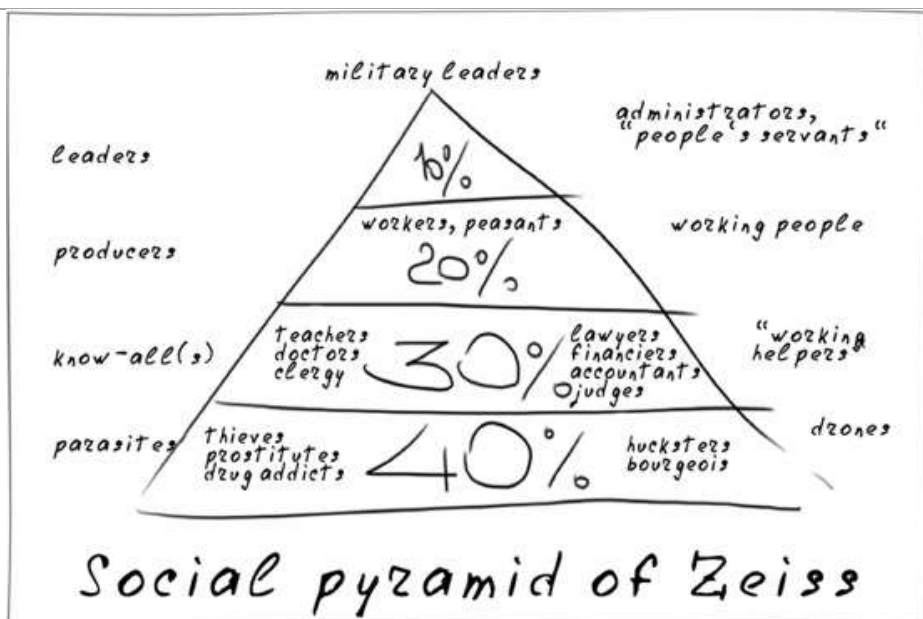

These drawings are authentic and made by A. Khatybov. I hope that the information about the "social pyramid" of Zeiss, the readers will find on the Internet themselves.

6.5. Shlisselburg convict

The narrative would be **INCOMPLETE** if not to tell you about **Nikolai Aleksandrovich Morozov**, a man whom Alexander Khatybov considered to be his teacher and precursor of the knowledge that he received.

Honorary Academician N.A. Morozov is known as the original scientist, who left a large number of works in the most diverse fields of natural and social sciences (astronomy, cosmogony, physics, chemistry, biology, mathematics, geophysics, meteorology, aeronautics, aviation, history, philosophy, political economy, linguistics). He wrote a number of widely known literary works: autobiographical, memoirs, poetic and others. The highest intellect and rebellious spirit of the Russian intelligentsia turned out to be focused in the personality of N.A. Morozov.



In everything that **N.A. Morozov** wrote and what he pondered over one could hear the steps of tomorrow. By his encyclopedic knowledge, enormous capacity for work, productivity and creative potential, N.A. Morozov is an exceptional phenomenon.

A.M. Khatybov noted that N.A. Morozov's merit is in the fact that on the basis of the deepest analysis he showed the role of disinformation in the **MOLDING OF WORLD PERCEPTION** of the world around us.

Nikolai Alexandrovich Morozov was born in 1854. That time, a splinter and a candle served for illumination in the village. He lived through the first steps in the development of technology, steam and electricity, and crowned his life at the dawn of the atomic energy the resources of which he had foreseen before most physicists and chemists. Life in nature since childhood awakened in Nikolai a passionate interest in natural science. Having received a primary home education, as it was usual in noble families; a fifteen-year-old boy enters the Second Moscow Gymnasium. Nikolai Alexandrovich unites around himself a group of like-minded young men, striving for the knowledge and organizes a circle called "Society of Naturalists". Members of the circle publish a hand-written magazine edited by Nikolai Aleksandrovich.

Until 1874, N.A. Morozov leads a tense, full of research life, **PROFOUNDLY STUDIES MATHEMATICS** and a number of extra curriculum subjects – astronomy, geology, botany and even anatomy. At the same time he is interested in social life, studies history of the revolutionary movement.

The hard fate of N.A. Morozov was programmed from the first days of his life. The everlasting drama of children born from unequal marriage. In case of N.A. Morozov, the noble blood of his father, who was related to Peter the Great, was diluted with the genes of his mother, who came from the serf. History has numerous examples, when such children grew up most talented and intelligent people. This is one of the manifestations of the nation's greatness. However, similar examples show the state of being socially unprotected of these children before the popular philistine ideas. The **SITUATION** of the **ILLIGITIMATE** and the related experiences make N.A. Morozov think about social injustice and material inequality in society.

In 1874 N.A. Morozov gets acquainted with some members of the revolutionary circle of "tchaikovtsy". Their ideals and activities attract Nikolai Aleksandrovich so much that, despite disagreeing with some of their views on the peasant question, he, after expelling him from the gymnasium

and depriving him of entering any Russian educational institution, rises to the path of revolutionary struggle.

N.A. Morozov leaves the family and "goes to the mass of common people", lives and works in the villages as an apprentice of a blacksmith, a wood cutter; wanders around the country propagating among the people, urging them to fight for their liberation. But the ardent young man, who is longing for heroic deeds for the sake of lofty ideals, "going to the mass of common people" and the subsequent activity in the working circles in Moscow does not satisfy.

On his comrades' suggestion N.A. Morozov moves to Geneva, where he edits the magazine "Rabotnik", which is illegally transported to Russia. At the same time, he goes on studying natural science, sociology and history.

In the spring of 1875, at the crossing of the Russian border, he was arrested and imprisoned in the St. Petersburg House of Preliminary Detention. **BEING IN PRISON**, he **PERSISTENTLY LEARNS** foreign languages, algebra, descriptive and analytical geometry, spherical trigonometry and other parts of mathematics.

After three years in prison, in January 1878, N.A. Morozov is released from prison and soon joins a new revolutionary organization "Land and Freedom". He becomes one of the editors of the magazine "Land and Freedom" and the keeper of all illegal documents, money and stamp. As a result of the internal struggle, "Land and Freedom" breaks up into "Narodnaya Volya" (People's Freedom) and "Chernyi Peredel" (Black Redistribution) and N.A. Morozov becomes a member of the Executive Committee of the party "Narodnaya Volya" and in 1880 re-emigrated to publish abroad a magazine called "The Russian Social-Revolutionary Library". At the same time he writes "The History of the Russian Revolutionary Movement", he studies at the University of Geneva, where he attends with special interest the lectures of famous naturalists.

N.A. Morozov decides to draw Karl Marx in cooperation in the journal, for which in December 1880 he goes to London, where he meets him and gets the Manifesto of the Communist Party for translation into Russian and a number of other works of K. Marx and F. Engels. K. Marx and F. Engels *write the preface to the Russian translation of the Manifesto* as they have promised.

Returning from London to Geneva, Morozov receives a letter from Sophia Perovskaya and hurries to Russia to help comrades in the struggle, but on the border he is arrested. After the assassination of Alexander II,

according to the Process of 20 of “People's Freedom” he is sentenced to life imprisonment without the right to appeal the verdict.

In Alekseevsky ravelin of the Peter and Paul Fortress there were the strictest conditions. N.A Morozov **DOES NOT HAVE** the right to walk, **DOES NOT GET BOOKS**, because of poor diet he gets scurvy and tuberculosis.

The exceptional will allows him to survive these hard years and, keeping the strength of mind, goes on with his research creative work. Two years later the prisoners of Alekseevsky Ravelin are transferred to the Shlisselburg Fortress, in which there are particularly strict conditions. Only in five years in the fortress, after a number of deaths among prisoners, the prison conditions are somewhat improved, and he has the opportunity to read scientific literature and write his works. In the Shlisselburg prison he writes 26 volumes of various manuscripts, which he manages to keep and take out when releasing from prison in 1905, and his memories "The Early life", published in 1907. Later, they compile the first part of his memoirs "The Story of My Life"; the theoretical work "The structure of matter", which remains unpublished. He **MANAGES TO PUBLISH** "Periodic systems of the structure of matter" only after leaving the fortress. When in prison N.A. Morozov studies French, English, German, Italian, Spanish, Latin, Greek, Hebrew, Old Slavic, Ukrainian and Polish.

Not far from St. Petersburg University D.I. Mendeleev worked that time and in the Shlisselburg fortress, N.A. Morozov tirelessly goes on thinking of the essence of the periodic law, the theory of the formation of chemical elements. Despite the lack of systematic chemical education, despite the fact that he did not pass the proper experimental school, he, thanks to amazing talents, masters the heights of various chemical disciplines and two or three years after his release from the fortress he teaches chemistry, writes books on the general physical, inorganic, organic and analytical chemistry. He meets Dmitry Ivanovich Mendeleev shortly before his death. D.I. Mendeleev approves the work "Periodic systems of the structure of matter", and on his presentation, in 1906, N.A. Morozov is conferred a Ph.D **WITHOUT DEFENDING** the thesis.

Studies conducted at the end of the XIX century by scientists from different countries show that both our planetary system and the most distant stellar nebulae consist of the same elements that are found on Earth. Recognizing the unity of the chemical composition of world matter was of paramount scientific and philosophical significance. In 1897, N.A. Morozov

reports from Shlisselburg to his family: *"Now I'm writing a book on the structure of matter. I've already written almost 1,500 pages, and there are not more than five hundred left. Although this book is probably never destined to be published, I have been still working hard on it almost every day for the last three years and feel an inexpressible pleasure whenever after long deliberation, calculations, and sometimes sleepless nights, I am able to find order and correctness in such phenomena of nature, which until now seemed mysterious"*.

The inner world of a prisoner with a "dried-up body" turned out to be so rich, his self-possession so high that he not only did not die and get insane in the terrible conditions of a long single imprisonment in the "stone tomb" of Alekseevsky Ravelin and Shlisselburg Fortress, but, on the contrary, he filled his life with creative work. N.A. Morozov eagerly awaited every new day as every new day allowed him to move forward in the development of scientific ideas. Many years later, Morozov would say that he was not in prison, but in the "Universe".

N.A. Morozov was released as a result of the 1905 revolution. He entirely devotes himself to science, begins to prepare for publication his works written in prison. At the same period, he gives many lectures throughout Russia. While lecturing, he visited 54 towns of the country, from St. Petersburg to Vladivostok. His public lectures on the problems of chemistry, aviation, history of religions were brilliant, they gathered huge audiences. All this frightened the authorities, and they often prohibited lectures.

The Man of immense mental grasp has another gift – a poetic one. He writes stories, novels, poems. For the poetic collection "Starry Songs" he is sentenced to one year's imprisonment. In prison, he begins to write his memoirs "**The Story of My Life**" featuring a strained plot, a beautiful language and neat images of his contemporaries. These memoirs were **HIGHLY APPRECIATED** by L.N. Tolstoy.



In 1907, on the invitation of P.F. Lesgaft N.A. Morozov began teaching a course of general chemistry at the Higher Free School. A few years later he

was elected head of the Department of Astronomy at the Lesgaft Higher Courses.

In 1911, at the Second Mendeleev Congress N.A. Morozov made a report on the theme "The past and future of the worlds from the modern geophysical point of view," in which he expressed the bold idea ***that new stars arise out of the explosion of old ones***, which occurs as a result of the decomposition of atoms of matter that have become radioactive. Today, this previously challenged hypothesis, in a somewhat modified form, is shared by a wide circle of astronomers and physicists.

N.A. Morozov was interested in many branches of mathematics – from differential and integral calculus and algebra of complex numbers to vectors and projective geometry, as well as the theory of probability. His interest in these matters was closely connected with the application of these mathematical disciplines to natural science. From 1908 to 1912 he published three major works on mathematics: "The beginnings of vector algebra in their genesis from pure mathematics"; ***"Bases of qualitative physical and mathematical analysis"*** and ***"Visual presentation of differential and integral calculus"***.

Most fully original ideas of Nikolai Alexandrovich in the field of astronomy are presented in his work **"The Universe"**. He takes a new look at questions of universal gravitation, at the origin and evolution of the solar system, at star clusters, and the structure of the Milky Way. He worked a lot on the theory of relativity. To his remarkable ideas there also belongs the hypothesis of the interconnection and periodicity of astrophysical and astrochemical phenomena. For a long time he worked on the fundamental work "Theoretical Foundations of Geophysics and Meteorology", in which he showed that the impact of the Galaxy on the meteorological and geophysical processes of the Earth is of a regular nature. The impact is so great that without introducing it into calculations one can not even dream of a scientific weather forecast.

N.A. Morozov was also greatly interested in aviation and aeronautics. He became one of the pioneers of scientific aeronautics in Russia, got the title of pilot, was the chairman of the commission for scientific flights, lectured at the aviation school, flew many times on the first balloons, proposed a system of a parachute opening automatically, as well as special suits for high-altitude flights (a model of modern clothes of pilots and cosmonauts).

During the First World War, in 1915, N.A. Morozov went to the front and there, at the forefront, as a delegate of the All-Russian Zemsky Union, was giving active assistance to the sick and wounded. His memories and thoughts about the war, he reflected in the book "At War," published in 1916.

After the October Revolution N.A. Morozov transformed the Higher Courses of Lesgaft into the Natural Science Institute named after P.F. Lesgaft; and he became his elected director. Simultaneously N.A. Morozov was in charge of the astronomical department of the Institute and **CREATED** an **OBSERVATORY** in which he worked.

Since 1918, for many years N.A. Morozov worked with enthusiasm on a fundamental writing "*The history of human culture in natural science coverage.*" Part of this great work in the form of seven volumes was published under the title "CHRIST" (edition 1924-1932). The last three volumes of the manuscript remained unprinted.



The name "**Christ**" suggested by the publisher does not fully correspond to the content of this work. In the preface to the 7th volume N.A. Morozov wrote: "The main task of this my fundamental work was to reconcile the historical sciences with natural science and discover the general laws of the mental development of mankind". The version of the chronology of ancient history adopted today was created in the period of the XIV-XVI centuries and was finally completed, in basic terms, by medieval chronological historians I. Scaliger (1540-1609) and D. Petavius (1583-1652). Morozov was the first to understand that both ancient and medieval events require redating. Based on the analysis of the enormous factual

material, having rechecked many historical documents by mathematical, linguistic and astronomical methods, N.A. Morozov advanced and partially substantiated the fundamental hypothesis that ***the Scaliger chronology was artificially stretched***, lengthened in comparison with reality. He **POINTED THE ANCIENT TEXTS** describing probably the same events, but later dated by different epochs. Morozov indicated that since the ancient texts had been repeatedly rewritten and, as a rule, they had been altered, they could have moved quite far from the original text. At that time there was no such branch of science as mathematical linguistics. N.A. Morozov suggested determining the authorship of texts and identifying plagiarism according to the statistical distribution of official words. In this respect, Morozov should be considered one of the precursors of mathematical methods in linguistics.

Listing NA. Morozov's writings, one can not fail to mention his historical study of alchemy "In Search of the Philosopher's Stone". This book was taken by readers with great interest; it is still one of the most fascinating writings on the alchemical period of the development of chemistry. As you know, Nikolai Alexandrovich always tried to study history from original sources.

Getting down to the writing of that book, he critically analyzed historical manuscripts that covered the most principal facts from the development of chemistry. Here is an example of his appreciation of many historical documents that he had to use: "All that we know about the writings of ancient authors, almost entirely is taken by the contemporary historians from the collections of XV-XVII centuries, that is, from people who lived a whole thousand of years after the death of the cited writers, who were extremely credulous, and dotted their information with incredible stories about all kinds of wonders. To tell the truth from plausible fabrications and later additions in them is almost impossible. Due to this circumstance, all of our primary sources of the ancient period of the pre-printed era represent the real Augean stables, for the cleaning of which a new Hercules is needed. But even Hercules alone would not be able to do anything about it. Here you need a special international society for the elaboration of primary sources of ancient history".

However, N.A. Morozov's methodology of research the history of mankind, his historical concept, proved to be so revolutionary that it **HAS NOT BEEN** recognized by the official historical science. The facts presented by the scientist are considered to be largely misinterpreted by him.

Nowadays, research on the new chronology is continued not by historians, but by scientists from other fields of knowledge – mathematicians, physicists (in particular: M.M. Postnikov, A.T. Fomenko, G.V. Nosovsky, S.I. Valiansky, D.V. Kalyuzhny and others).

When in prison, Nikolai Aleksandrovich develops the idea of the **COMPLEX ATOM STRUCTURE** and thereby justifies the essence of the periodic law of chemical elements. He passionately defends the suggestion of the possibility of an atom decomposition, which seemed unconvincing to most physicists and chemists, since there was not enough experimental evidence for that. N.A. Morozov also says out the idea that the ***main task of chemistry of the future is the synthesis of elements***. Developing the idea of J. Dumas, he proposes a periodic system of hydrocarbons – "carbohydrides", by analogy with Mendeleev's table – "in order of increasing their shared weight," and **CREATES TABLES** showing the periodic dependence of a number of properties of aliphatic and cyclic radicals on the molecular weight. N.A. Morozov suggests that there should be chemically neutral elements among the atoms. A number of the atomic weights of the elements of the zero and first groups calculated by him coincided with the atomic weights of the corresponding isotopes, determined many years later. A profound analysis of the properties of the elements of the zero and eighth groups of Mendeleev's periodic system lead him to the idea of the need to combine them into one zero type, which was also justified by subsequent work. "Thus, – wrote the famous chemist Professor L.A. Chugaev, N.A. Morozov could predict the existence of a zero-year group ***10 years before it was actually opened***. Unfortunately, due to circumstances beyond his control, this prediction could not then be published and appeared much later in the press".

Striking and indisputable is the fact that more than 100 years ago N.A. Morozov boldly and confidently accepts the view of the **COMPLEX STRUCTURE OF ATOMS**, the transformability of elements, allowing the possibility of artificial production of radioactive elements, recognizing the extraordinary reserves of intra-atomic energy. According to Academician I.V. Kurchatov, modern physics fully confirmed the assertion about the complex structure of atoms and the interconversion of all chemical elements, analyzed by N.A. Morozov in the monograph "**Periodic systems of the structure of matter**".

From 1918 until the end of his life N.A. Morosov was director of the Natural Sciences Institution named after P.F. Lesgaft. The institution distinguished itself by the multi-aspect of research work in varied fields of knowledge, which was manifested by the Instituton publications since 1919 under his editorship. It was at this institution, at the initiative of the scientist, there began the development of a number of problems related to the exploration of outer space. The principle of comprehensive research was realized not only at the institution that he directed, but also in the work of the scientific center created in 1939 on his initiative in the Borok settlement of the Yaroslavl region, where the Institution of Inland Water Biology and the Geophysical Observatory of the Russian Academy of Sciences are currently working.



Of all his fundamental works on mathematics, chemistry, aviation, geophysics, meteorology, aeronautics, mathematical linguistics (he was its precursor), astronomy, natural science, the history of Human culture and others, N.A. Morozov, on the basis of his own research, in his fundamental work, "Christ" makes the conclusion that the ***Humanity has neither its history, nor science, as the knowledge about the world around us.*** When researching into the processes taking place on the Earth, one has not only to know all the laws of the phenomenal world, ***but also be able to analyze the past events, finding the connections between them.*** One can believe everything that science has presented to us today, but knowledge can not be based on it, and the convincing proofs that science adduces are made in the absence of a different system of knowledge.

N.A. Morozov's ever lasting aspiration for work at the "joints of sciences", using the facts and methods of various fields of knowledge, brings him closely to the **SYSTEMATIC SCIENTIFIC APPROACH** (which is now one of the leading methods in science) in studying phenomena in their diverse and often unexpected connections that unite seemed to be completely heterogeneous phenomena and processes. The range of interests of the scientist extended from the chemical elements to the essence of life;

from the origin of stars as a result of the explosion of cosmic bodies to the formation of clouds; from the vector calculus to the theory of relativity; from the processes taking place in the center of the globe to aeronautics; from ancient and medieval history to the results of early 20th century science. N.A. Morozov believes that in the future ***all separate knowledge would unite into one common natural science, flow into a mighty stream of unified knowledge, become a common natural philosophy of the future.*** And I believe it, too.

As you can see, ***it was not by chance that Alexander Mikhailovich Khatybov considered Nikolai Aleksandrovich Morozov his teacher.***

The Soviet government awarded Nikolai Aleksandrovich Morozov with two Orders of Lenin and the Order of the Red Banner of Labor. In the house where the honored academician N.A. Morozov lived and worked a museum is organized. His name is given to a village in the Leningrad region, not far from Shlisselburg Fortress. Astronomers gave his name to a small planet-aasteroid. «MOROZOVIYA» is in all the star catalogues of the world. One of the craters on the reverse side of the Moon is named after N.A. Morozov (5' n.l., 127'e.l.).

6.6. Quintessence

Einstein asked Bohr: "Does the Moon exist when I do not look at it?" Bohr answered: "Can you prove the opposite?" If we do not see the Moon either with our eyes, or speculatively, if it is not in our consciousness – there is no Moon. It appears with its appearance in the consciousness. While it did not appear, it does not exist. What is not in our consciousness that does not exist for us. Existence is always movement. Without movement there is no existence. The basis of the movement is information. So, the information **EXISTED BEFORE** any... existence.

One can believe everything that science has presented to us today, but knowledge can not be based on it, and the convincing proofs that science adduces are made in the absence of a different system of knowledge.

Alexander Mikhailovich Khatybov was gone on 18.03.2011. I do not want to finish this chapter on such a sad note. I surely know that such Men, as A.M. Khatybov, N.V. Levashov **NEVER DIE**. Actually ***my today's***

knowledge is from information out of the works of those great Scientists.

Many people who are familiar with the writings of N. Levashov and A. Khatybov, **INVOLUNTARILY ASK** the **QUESTION**: "Why did people like A. Khatybov and N. Levashov passed away on the Earth at such an early age? After all, they could have done a lot more of useful things in so hard times for us". Did they have time to "pass on" their knowledge and skills to people who made a step on the path of knowledge? Of course, their works, awakened the consciousness of many people, but still there are many who **DID NOT GET AT THE MEANING** of what these great Men had stated. If N. Levashov wrote everything in an intelligible language, though there are many who still did not understand, then what to say about the works of A. Khatybov, that were specially left in the form that not everyone was able to look into them.

I have already mentioned that the most correct way to understand the works of A. Khatybov is through the knowledge of the works of N. Levashov. And those who do not understand this, in my opinion, are limited people who are "frozen" in their development and believe that having read the works of N. Levashov (and basically without understanding anything there) they have already "caught the Bull by its horns". In his time, N. Levashov convinced me not to start any **UNWANTED DISPUTES** and not to pay attention to the "actions" of such people and more so **NOT TO TRY** to prove anything to anyone. And he was right. I know only one thing – if there were no works of A. Khatybov, I would hardly have known "**SvetL**" **Technology** and the potential to create programs for it, about which there is **NO NEED** to tell or prove anything to anyone. All this is done by the participants of "**SvetL**" **Programs** with great thanks for what has become an **INTEGRAL PART OF THEIR LIVES**. ***And the knowledge of the works of A. Khatybov became possible only after my acquaintance with N. Levashov as a Man with a capital letter,*** and with his works, which were the forerunner of my knowledge in a completely **NEW VISION** of the world.

The scale of the personality depends on the scale of his consciousness. Alexander Mikhailovich Khatybov possessed such consciousness and manifested himself in everything that generates a thinking beginning. B. Makov, reminiscing AM. Khatybov at his **70-th. anniversary** of his birth, said that A. Khatybov was a **GLOBALLY-SCALE PERSONALITY**, drew our attention to the most expressive fragments of his life, which enabled him to find the state of creative perfection and public or concealed recognition of

his professional merit. And he has my whole-hearted support. Most of the epoch-making scientific endeavors, first accomplished by A.M. Khatybov from the Super system level for the recreation of the True Systemic level of the Control was an act of **NOT** a **MATERIAL** usage of Man, but to a certain extent equally prepared by his state of Mind and worthy of his Mental Entity for that hardest period and state of the True Control System. It is difficult to explain what it is forbidden and impossible to explain!

Once again I'd like to emphasize – I'm very sorry that I ***did not have the honor*** to be **PERSONALLY ACQUAINTED** with **Alexander Mikhailovich**. I am grateful to Nikolai Levashov and Boris Makov for their stories about this amazing, purposeful Russian Scientist who entirely devoted himself, to the good of all the others.

Afterword

Each of us has an inner great and delightful world. All that is required of us is to leave at least a little room for new knowledge and impressions.

A young man came to see the tutor and said:
– I want you to be my teacher. Help me to know the wisdom of life.
– Well, – says the teacher, – Tell me about yourself.

The disciple began to talk about his virtues; about how much he knew and how many things he was able to do.

The teacher listened, and then gave him the first task. But the young man did not agree with him. He made up his mind that was a bad task, that he needed a completely different test. He went on talking about how much he had learned, and achieved considerable successes in his life. Yes, perhaps – in other spheres of life. But why not transfer them to the given situation?!

Whatever the tutor suggested, the young man always had a more correct version of the problem solution.

Then the wise man gave the youth a glass, and began to pour wine into it from the vessel. At first the glass was filled to half, then to the very edges, and the teacher went on pouring the wine into the glass. The young man looked calmly at first as the wine was running over the glass to the ground, but then he could not stand it any longer and screamed:

– Stop pouring! We just waste wine!

– Just like I'm wasting my time. I could teach you a lot, but you are already full, like this glass.

The young man asked:

– So, my past experience means nothing?

– Your way of thinking made you what you are, gave you everything that you have today. But if you want more, your past experience will not lead you to the desired goal. Go away! And come back only when you are empty. When you are ready for new knowledge!

Human life is a struggle between ignorance and enlightenment, lucidity... Once you stop looking for information and knowledge for yourself, you find yourself in the network of

ignorance. I assure you, readers – **EACH OF US BEARS A WHOLE UNIVERSE IN OURSELVES**, and therefore Man, if, of course, he is a Man, is immortal (I am saying it with full responsibility), **THANKS TO THE KNOWLEDGE.** Knowledge and thinking are the root of Man's life, his immortality.

"It is proved that there is no Humanity – it has no history. At least there is no history before our era. And the later history has been apocryphalized so much that it can be taken for a fairy tale..." – N. Morozov said on the basis of his own research, and when it was confirmed by becoming public through the works of N. Levashov and A. Khatybov, many people realized that it was time to change all this, beginning with their own Knowledge and relying on these priceless works.



When I began to work on this book and then on its continuation in the second version, I proceeded exactly from this. What does the Man lack today in order to stop playing in compliance with the rules of the pre-determined finale? Probably, that very thing that there is missing in the Bible (for those who believe) and in millions of volumes of books, though being hidden from us. There is no life in them. The Life of Man begins when he wants to get started the most powerful reserve – **HIS MIND.** The difference between instincts and the Mind is that the Mind asks questions, strives for understanding, perception and comprehension. Exactly those features make Man different from animal. And for this, he does not need anything but free will. But the most interesting thing is that no one deprived him of his will.

And to understand this and more than this, I have tried to make a testing ground out of the written, on which, in my opinion, I have created some models of the **SENSE OF LIFE**, in order then to shift them into the existing reality and bring it all to people. For example, the fact that reading impregnates thinking. But if you want to bring something to people, then you have to **BE THOUSAND PERCENTAGES CONFIDENT IN WHAT YOU ARE BRINGING** there is **THE TRUTH AND ONLY THE TRUTH!** There is a Lie and the Truth, and in the middle (i.e. between them) – a true thing. And we should always strive for an acceptable degree of approximation to the Truth, based on a true thing to cover what is happening. That was what N. Levashov used to do, and it was he who started to do it – for the first time. That is hard, because we are still, in the full historical fog of our "HizTory", backed up by the sly mental derangement of people's consciousness on the part of objective scientific and horse-esoteric propaganda, have to dispel many myths of the Pseudo- Truth. And, never come to a standstill; try to shift people's knowledge on the path of the true thing – the Truth, realizing that this can be prevented by state violence, and by all the "clan-Khazar Guards" and their like.

To make us happy, **THERE IS ALL KNOWLEDGE!** All kinds of technologies! But they are hidden from us in the "secret archives". And woe to betide those who makes public even a minor a part of it. Even today – such people are declared either enemies of the people, or just physically eliminated. We know these illustrative examples. And it's not scary that the world will shudder to know the Truth. After another massacre, you can hypocritically "raise the glass" for the untimely gone Genius and pour crocodile tears on His grave. Therefore, to go this way, you have to understand: you **ARE FULLY RESPONSIBLE** for what you give people before them and your own conscience! And you have to be, first of all, most confident that you have avoided delusions, have been able to correctly understand and think over your own experience, and most important – that your information, technologies that N. Levashov "launched", and you apply them, improve and develop, are not the fruit of your own imagination! Although to think up such a thing, from my point of view, is simply impossible, since **NOTHING LIKE THIS HAS EVER BEEN DESCRIBED** even by the most talented science fiction writers of all times and peoples, even those science fiction writers whose ideas have been realized in hundreds of years!! Nothing of the sort happened either in the legends, or in the religious doctrines of the divine creation! But **N. Morozov, N. Levashov, A. Khatybov** came out, and this door began

to open, and today many people are doing everything to open it up wider and wider.

Everything I wrote about is taking place around us. And if it looks fantastic – it's only thanks to the created stereotypes and narrowness of the human worldview. In the existing form, people behave in accordance with what is told in the book, and I will go on with this story. They take what is available and use it for some of their purposes (for their own good), without having a full or at least deep understanding of it, and knowing just enough to use it, **NOT MUCH WORRIED ABOUT THE CONSEQUENCES**. If you pass this to the plane of the philistine's consciousness,- people, for example, catch fish, raise it to feed themselves, having mastered the methods of catching and processing, but all their concern is to find out once that the fish is over and it's time to add it to the lists of the **Red Book**⁴¹. But if you look a little deeper – there **COULD NOT BE ANOTHER HUMAN BEING ESSENCE** under the control of Ebr System and the programs launched by it. Since such parasitism lies at the heart of their (ebr) existence – it also lies at the basis of our existence under their control. We raise fish for our purposes – they "raised" people for their own. And if suddenly some "philosopher" begins to tell us that it is **NOT A VERY SENSIBLE PRACTICE** to raise fish the way we do it, moreover, it is inconsistent with some fundamental principles that are not something to touch or to see, – we will hardly listen to such things. And this "philosopher" and his team will have to give up the very blind, leaving them the chance to live as they do, and in the future to deal with those who have caught at least some fragment of the truth and are able to perceive information more or less adequately. Then, look, you are able to learn not only something more about fish, how to catch it and under what sauce to eat it but, perhaps, to get closer at the meaning, **FOR THE SAKE OF WHAT IS NEEDED** he **IN GENERAL** who is fed this fish with – that is, Man himself.

A building without a foundation can not be. No question. No matter how strong is the visible construction, if the foundation disappears under it, it will inevitably collapse. There are no exceptions to this rule. It is impossible to have the foundation ruined, and the construction based on it remained intact – everything will collapse. We have already come to the conclusion that the role of the foundation is performed by the **WORLDVIEW**. It is

⁴¹ The Red Book is an annotated list of rare and endangered animals, fish, plants and mushrooms.

from it that the principal provisions and landmarks are derived, around which the cultural, social, political and economic "systems" are created, that are used by Man. If the foundation collapses, the system-forming nodes lose ground. After **N. Levashov's** passing away, I did not have much evidence confirming the correctness of my positions on the Technologies and their applications. I did not know about some of the confirmations then, other evidence was yet to appear in the near future, but ... I already had my own experience and my own evidence in the effectiveness of the Technology and in the possibility of using "**SvetL**" Programs, and the evidence was rather weighty. Despite the fact that evidence **WAS NOT KNOWN TO MANY PEOPLE** (and those to whom it was known were not in a hurry to confirm my results), it



was obtained precisely both due to the correct understanding of the Laws of Nature, and methods of impact, and most importantly – interaction with Nature itself. That time when I had only just "touched" and started to learn the Technologies, I still had some belief that modern science was true science, that the overwhelming majority of people who call themselves scientists put their goal in the knowledge of the truth, that ***in the scientific world there was no place for deception and careerism!*** Then I still believed that most scientists were creative people, open to the new and free from dogmatism, since dogmatism is incompatible with science! Of course, I saw enough examples of the opposite, but I thought then that such "scientists" are the exception rather than the rule. Changing the attitude to the situation, we change our worldview and life. The victory of some scientific view and its inclusion in publicity – **DOES NOT PROVE IT TO BE THE TRUTH YET.**

I'm probably just lucky that in the very near past I came across scientists who really had all the qualities of the true research workers, as I then saw it, and it "led" me to knowing **N. Levashov**, who determined all my future life, and not only it.

The process of getting information, as it is, is not **KNOWLEDGE**. Completed Knowledge is **LOOKING FOR** and **FINDING EVIDENCE**. This evidence has already existed, it is described in this book, too.. But not everything is in this first, but already supplemented in the second edition, book. **Therefore, it is to be continued...** Each ending is the beginning of something new. The best afterword you can only dream about is the ellipsis...

Life goes on ...

When I get down to this appendix, there began tormenting reflections. But they won't give birth to any creative thought. Sometimes such things happen, and one should not get scared of them. Did not I promise in the beginning of the book, after all, that I would provide readers with detailed information about the ongoing events?.. I appealed to my Companions for help in this routine work, keeping in mind the words I said when I started writing the bookkeeping in mind my own words that not me would write the book, – but joint efforts of all of us. I express my sincere gratitude to **Yu. Ocheretyanny and A. Nikonovich** for the work that they have done to make it possible for such an important appendix to appear. It makes it easier to comprehend what is happening on our Planet and allows readers (I really hope) to get a deep insight into the content of these Books, which I supplemented with information from the works of N. Levashov, A. Khatybov, N. Morozov and many others, trying to show and tell the whole truth about those events on our Planet that had been deliberately concealed from everyone to achieve once set but never implemented goals. There is always a solution to any problem; you just have to find it. And if you do not find a solution to the problem – it means that something was not taken into account or there were not those necessary properties and qualities; but they are to come to you, as soon as you find the solution.

A short story about the HistOR(AH)y

Any professional or amateur view of the history of mankind easily brings it to an endless list of armed conflicts and wars in which not one civilization or state perished. Another way, for the new aspect⁴² of people was not envisaged by the Ebr invaders imposed system of parasitism and violence. As well as the preservation of documentary evidence of the losers, the memory of which often died in the flames of the fires burned by the winners or under the rubble of the destroyed depositories. Nineveh library of Assyria Ashurbanipal, papyri from the library of the temple of Ptah (Memphis, Egypt), the Alexandria library, the collection of Pisistratus (Athens, Greece), the Carthage libraries, the Imperial Library of Constantinople, the House of Wisdom (Iraq), the Pergamon library

⁴² People created in the framework of the Ebr programs "Development of energy biogenesis of flesh cells" and "Development of brain genotypes".

(Anatolia) the library of Ivan the Terrible is just a small piece of knowledge about ourselves and the world around us, lost or hidden in the Vatican cellars, repositories of patriarchs and hierarchs of various ancient religions from pagan cults to Christian Orthodoxy and Bon religion.

The best estimate of the chronology of mankind "restored" by the French philologist Jose Scaliger and the French cardinal Dionysius Petavius are in the writings of N.A. Morozov, who began its cleansing of distortions and historical fantasies, which had been made to please the Vatican, which started writing "history."

Even more regrettable is the chronology of our country. By the efforts of German scientists, who took over the historical branch of the Russian Academy, our chorology was laid in the Procrustean bed of the Norman theory and other fictions far from the truth. Here are the names of "historians" whom we should be grateful for "ignorance" of our ancestors, the feudal fragmentation of "Ancient Rus", the emergence of Russian culture no later than 988 AD. and its other distortions: Gottlieb Siegfried Bayer, Gerhard Friedrich Miller, August Ludwig Schlözer, Kohl Peter, Fischer Johann Eberhard, Kramer Adolf Bernhardt, Lotter Johann Georg, Leroy Pierre-Louis, Merling Georg, Brem Johann Friedrich, Tauber Johann Gaspar, Krusius Christians Gottfried, Moderah Carl Friedrich, Stratter Johann Gotgilf, Gackman Johann Friedrich, Busse Johann Heinrich, Vauvillier Jean-François, Claproth Heinrich Julius, Hermann Karl Gottlob Melchior, Circle Johann Philippe, Lerberg August Christian, Kehler Heinrich Karl Ernst, Fren Christian Martin, Grefe Christian Friedrich, Schmidt Issak Jacob, Shengren Johann Andreas, Sharmois France-Bernard, Fleischer Heinrich Leberecht, Lenz Robert Christianovich, Brosse Marie-Felicite, Dorn Johann Albrecht Bernhard. As they say, comment is superfluous.

But M.V. Lomonosov's works, who fought for historical truth in the way which it was possible that time, never saw publication during his lifetime. The next day after the death of the Great Russian scientist, by Catherine II's order his archive was confiscated and added to the list of missing historical documents. Only the first volume of Lomonosov's work on Russian history, saw the light, but rewritten by Miller.

The events beyond the last 18,000 years are generally shrouded in mystery of conjectures and "legends" that are poorly correlated even with elementary logic. Efforts of singles, numerous artifacts that do not fit into the current chronology and materials obtained by "unconventional" methods, official historical science ignores completely. So much the worse

for it. There are plenty of vacant places in the list of falsifiers of our country's history.

What are the justified large-scale efforts to conceal the truth and direct destruction of artifacts? What is it that the Earth keeps from the living on it today, and where are the evidences of falsification or erroneous interpretations? Apparently, one of the main reasons is the "contributions" of Interventionist civilization and its "fifth pillar" on the Earth. They are so "great" that the payment for them will bring about more significant consequences than even the measures that have been taken today against the Holocaust perpetrators. Only the initial loss of proto-humanity is about a billion inhabitants. Plus, the imposing of parasitism and violence in the life of the planet, the change in the whole picture of the external appearance of the surface, including through the introduction of its fauna, flora, "the creation of people" and... everything that I have told in my books. Briefly I will return to what has already been stated, but it is necessary to understand the true essence of my companions' reflections who have written their vision of the ongoing events, which substantiate to some extent the so-called temporary "inconsistencies" that are found when studying the works of N. Levashov, A. Khatybov and other sources available today.

So, the Earth. Before the invasion.

The main, i.e. indicative for understanding the parameters of the Earth before the attack were: the angle of inclination to the plane of the ecliptic 25° , the day = 48.64 hours, the year = 864 days (relative to the charge oscillation cycle = 1.007 seconds), the height of the grating of the true Atmospheric Structure was 12000 km, the number of the layers of the formed Atmosphere gratings – 18. The level of the Earth surface layer was almost 11 km less, the shape of the Planet **WAS CLOSER TO THE SHAPE OF THE BALL**, there was no such array of mountain formations and other modern "garbage". The water was formed only on the surface (above the earth), and in the area it occupied up to 4% of the entire territory of the Planet. There was no continental division of the Earth's surface.

Before the invasion, the Earth Cluster System was moving, focusing on Sirius at a distance of about 240 billion km (moving off the Earth).

A highly developed human culture, created by Civilizations of Intelligent Orientation, existed on Midgard-Earth for a long time until it got in the Ebr "field of vision". To withstand the invader fleet that arrived in our Star System in 18344 BC, having at its disposal: the Sun and three Moons (the largest interstellar ships), 54 satellites, 12 main objects (type 960) and

3862 attack targets, under the conditions of transition Guardianship of civilization development from Orion to Sirius and disabled (or in transition state) complexes, there were very few chances (it only remains to pay tribute to the Ebr intelligence).

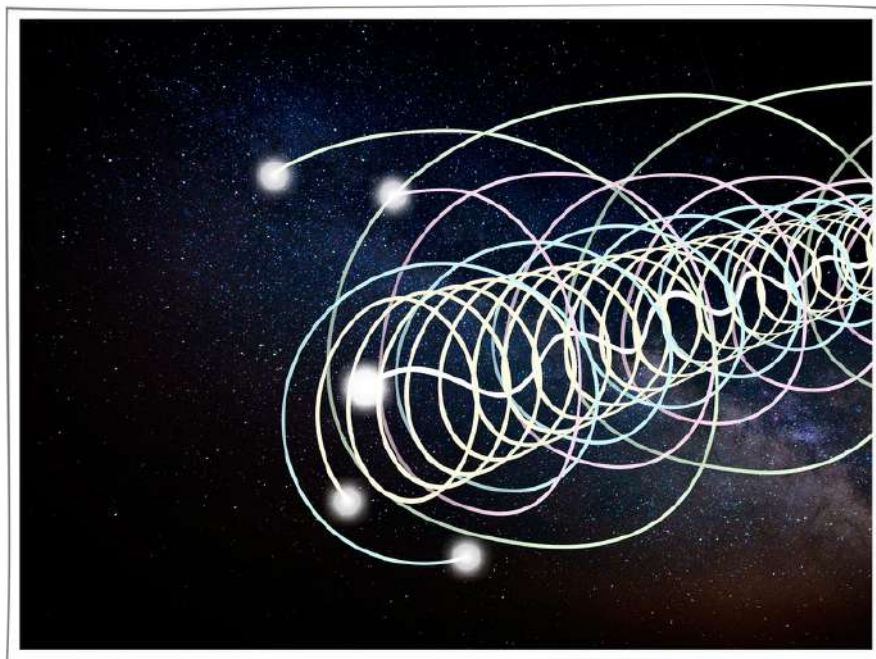

We are going on to consider military actions. Phaeton, as a planet with protection functions and corresponding capabilities, destroyed a considerable part of the interventionist fleet by self-explosion on **May 9** (a strange date in the history of Mankind: On May 9 was also captured by the Ebr the main Complex of the Native ECS Chechov) There is no reason to doubt this, but there are doubts that it was the only type of defensive action. The level of civilization was not at the level of the earth's cluster. After all, the same Midgard-Earth with its controlling and generating Complexes was capable in the so-called "cone of motion" (its parameters: the base diameter equal to the diameter of the Atmosphere, the cone angle is equal to 1°) to destroy or divert any object commensurable with its mass to avoid the collision with it.

So, both Midgard-Earth and Phaeton, as might be supposed, first "defended" themselves (the capture itself took place for 996 years), and only then... As an extreme means. And, apparently, two Ebr Moons also appeared to be "affected" (in them higher-octave generating complexes were located), which were named Lel and Fatta. The first was destroyed "without damage" for the Earth, but the second...

Midgard-Earth had (and saved from "prying eyes") the protective contour of the slab (without breaks) of 240 km thick. The outer contour, at that time, as a protective layer, saved during the invasion the planet Earth with an lifeless Control System, the Spirits of 224 octave and might be much more that we do not yet know. Since with the destruction of the two Moons, the Ebr lost the possibility of creating octaves of frequencies above 128, the invaders could not penetrate the plates of the protective contour of Midgard-Earth and captivate the entire Planet. They were forced to connect all the planets with galactic tubes (Svargi's needles). And all the time of the occupation, the planetary fleet of the Ebr civilization led by the Sun, as the main tug, and the satellites of the planets, as auxiliary means, "dragged" our Civilization Cluster to their native base (the planet Sur Ursa Major) for the final capture and realization of all their plans .

Fallen to the ground fragments of the Moon Fatta could not cause volcanic eruptions and tsunamisthere were no conditions. But ***to leave a good "dent" on the 240-kilometer contour of the protective firmament of the planet,*** if suddenly it was, then maybe they could. Think about this: the remaining third Moon, as an artificial object and at the same time a spacecraft, has, according to indirect data, including a scientific one, an outer case with a large content of titanium in its spectrum of radiations, and hollow inside. It is reasonable to assume that in case of a break, some of them had to be burned down, and the rest could hardly have caused serious damage to the Earth. There remains a variant of a blow similar to the whole Fatta construction (should we look for it in the area of the Mariana Trench?), If... Although there are still a lot of questions, both of historical and physical character related to the possibilities of the protective contour of the Earth and the fallen Fatta, as well as the ability of the proto-Man of that time to affect matter and space that way.

As for the change in the inclination angle of the axis and the period of rotation of the Midgard-Earth... In the presence of even one Moon, the axis of the planet could be shifted with the purpose of synchronization of the control complexes of the Moon and the Earth (change of poles). Let's return to this a little later...

The ensuing destruction of all the life-support structures of the Planet's Brain resulted in an almost complete loss of the people's Brains potential (lowering to the level of **3%**). In a short time this led to the elimination of all inhabitants of the Earth (**up to 1 billion**), flora and fauna, capture of individuals who were in a non-inertial state. Further – pouring magma,

water, sanding the surface and other "delights" of intervention, which we continue to "reap" to this day.

Before proceeding to the presented tables, take a look at the well-known maps from the Mercator Atlas, which still show Daaria (he, it seems, copied them from the pyramid wall in Giza, only this picture was not seen anymore; there are other versions of the appearance of the map) And there is plenty of water, and continental difference is present.

And one more thing: one part of the continent (from the "European side") does not have a clear mountain "edging". As if it is the continuation of another territory and Mercator knew about it. True, there are other maps with a clear "edging". Which are true?



And here is the first globe of the Earth, executed by Martinus de Bohemia in 1492. There was no America yet on it, but there is Daaria and it is connected to the mainland by two islands, it looks like the Euzrazian.



Let us recall one more map of the world, created in 1513 in Constantinople by the Turkish admiral and great lover of cartography Piri-Reis (full name – Haji Muhiddin Piri ibn Haji Mehmed) and available to modern people. Its part, which depicts even the coast of Antarctica Continent, has no ice cover, which indirectly indicates that this territory could be inhabited. Currently only a few pages are available out of the whole world atlas.

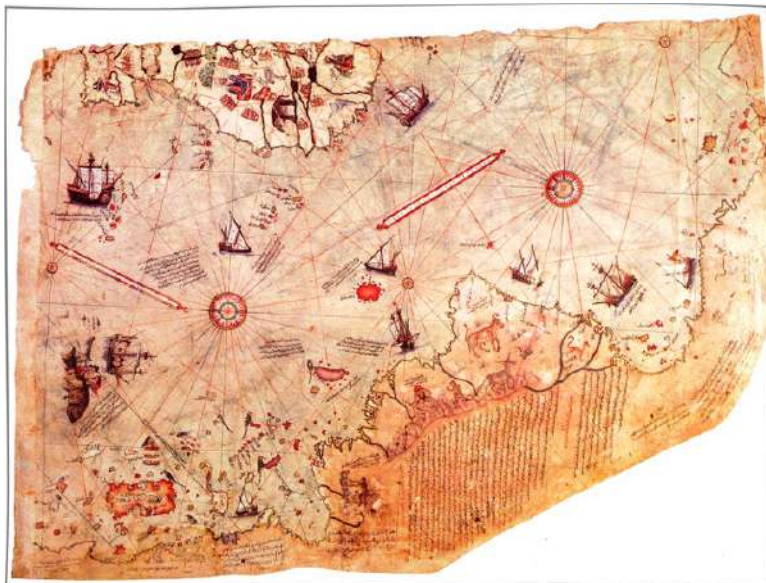

All of the above maps and globes made from 500 to 600 years ago on the basis of other, more ancient genuine original maps and documents of the stories of the unnamed travelers which, and this is not surprising, **unfortunately "did not survive"**... It is no secret that almost all historical documents according to the legend of "equine" science are **COPIES OF REAL DOCUMENTS, WHICH ALSO ARE MISSING**

NOBODY KNOWS WHY. Therefore, strangely enough, everyone uses "preserved" copies. Even here, the parasites leaders were not original, both with the copies, and others, they did everything according to the same pattern: "the more monstrous the lie, the faster they will believe in it."

Let's go back to continental differences. As is known, the initial continental difference appeared only in the period of **the first "Civilization" (17304-16684 BC)** and only at the locations of the delivered (transported) and installed (the primary stationary) interventionist Control Complexes or objects (by raising the surface level by 4300 m compared to today's). And the territory of the preserved (formed) land after its primary filling with the imposed water with tritium occupied only 5-6% of the total surface area of the planet.

And only in the period of **the second "Civilization" (13954-10804 BC)**, when the level of priming of the planet surface was "raised" by another 3000 m, a similarity of the continental difference of the Earth's surface appeared. But it was not the primary one, since the main reason for the "continentality" is the "earth-digging": to supply tritium for the interventionist objects there were formed kinds of "pipes" with a diameter of 300-400 m, which still exist at a depth of 2200-3000 m. But the coincidence of the "curve pattern" is only a consequence of the form of scattering of radiation frequencies, the formation of chemical elements at the ionic level, "piled up earth", and the like.



And this is only the first part of the questions concerning Daaria. After all, there are still studies by amateur authors, and not only, which very convincingly prove that Daaria has still been existing... not far from Murmansk in the vicinity of Seid Lake on the Kola Peninsula. There are photos and videos of enormous geoglyphs, the ruins of megalithic buildings, as well as the results of three expeditions in 1921 (Alexander Barchenko, head of the Laboratory of Neuroenergetics of the All-Union Institute of Experimental Medicine, conducted at the initiative of the OGPU), in 1997 (under the guidance of Doctor of Philosophy Valery Demin) and in 2012 (Yuri Kudinov).

From the point of view of logic one can state the following: If Daaria had existed before the attack, then as a result of Fatta's fall, it could not have "plunged into the abyss", due to its absence. And the "path" for the Pascha Festival – the walk all over from Daari to the region of the future Asgard of Irian – should not have been then. And to survive 11 km of landfill up of the Earth by the interventionists and the World Flood – it would have been too much.

Rather, it is the fate of individual groups of residents who, at least, definitely "stood" under the onslaught of the first violent "civilization" of Midgard-Earth.

Hence, Daaria could be created by those who came to Midgard-Earth after the interventionists completed the "engineering works", but before the Ebr creating their Control System, that is, after **6234 BC**. Or by those whom the Native ECS could materialize through the "gaps" of the Ebr defense and the layer of magma.

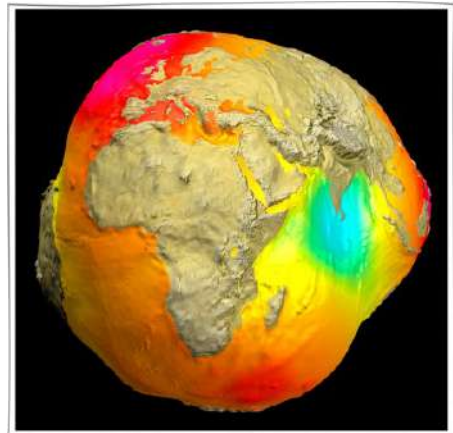

It can be assumed that **Asgard of Da'aria** had similar protection as the later **Asgard of Iria** (as N.V. Levashov determined, it at least once had saved the city from a powerful tsunami), which the Ebr could surmount only **in 1530**. Therefore, for the destruction of Asgard of Da'aria the Ebr was forced to use "unusual" means. Judging by the nature of the consequences, it is possible to admit the use of something "tectonic", and the fact that the land began slowly sinking allowed the inhabitants of the island to move "to the continent" and found **Asgard of Iria**. As for the data available in the

SAV⁴³, that at the time of the catastrophe some inhabitants used the Gates of the Worlds and another part of it by the Whitemans, then it is possible to assume this in view of the presence of a protective cupola... A "side effect" of the means of destroying Da'aria could be the displacement of the axis of inclination of the Earth rotation and the change in the duration of the day and the rate of the free fall (otherwise in the place of Da'aria on the map of Mercator there would have been an icy "desert"). In this case, the period before this catastrophe should have been marked by a special "gigantism" of the terrestrial flora that was destroyed as a result.

The legends of Daaria could be preserved by the people of Asgard of Irii, from whom the map first came to Atlantida and then to Egypt, where, it is believed, Mercator saw the map with Da'aria on it.

The history of Da'aria and Atlantida is also disputed by some amateur authors. In their representations, Atlantida could have existed earlier than Da'aria and quite near it.

In the annals of the two "continents" there are inconsistencies with the materials from the FFH ("Foundations of the Formation of Humanity"), taken as a basis for the study. And they are serious: they do not even have a hint that the fragments of one of the Moons fell to the ground and made something sink as well as the existence of a continent called "Da'aria", or under another name

Adding up, minutes, days, months and years make a "backbone" of historical events, on which we are trying to restore them. But only before the attack, ***the day on the Earth was 48.64 hours, and the year = 864 days relative to the clock charge oscillation rate of 1.007 s.*** The moment of changing the time parameters: the imposition of the format 24-60-60 is carried out by the Ebr after the attack and can be related to a major planetary catastrophe. But the exact moment when this happened... And how many of them were... Were they related to the disappearance of Da'aria and Atlantida?.. And these are only the catastrophes that we know about today, and it is presumed.

Here are the primary sources – the colonization of the planet based on the materials of the scientific research institute "The Center of Preventive Strategies – "CPS" – **40-45 thousand years ago, SAV – 460 thousand years ago.** And in general, in the CAB there is not any mention of the attack

⁴³ Slavic-Aryan Vedas.

of the Ebr civilization and the subsequent occupation... But it is said that the first "settlers" were located at the north pole and called this place Da'aria, that is, they were to appear after the attack, maybe, because of the fact that geographically the North Pole before the attack was located elsewhere, and not at the place indicated on the map of Mercator.

And what about the other events contained, for example, in the writings of **N.V. Levashov** or in other books now banned in Russia? Did they exist? Probably, they did: ***the methods used by N.V. Levashov to get the information about the past are too serious***. And, maybe, the question is only in their dating or other circumstances, while hidden from us. If, with the changed duration of the day and year, everything is clear (with the exception of the time from which it is necessary to start counting), then with the cycle of charge oscillations is much more complicated. In the native civilization, it =**1.008 seconds**, in the Ebr =**1.007 seconds**. And the methodology for recalculating dates in view of this fact is not yet available to us.

As for the tasks set for N.V. Levashov... ***"He was entrusted with a very important and responsible function: on the available linguistic level to speak out as a "Destroyer" of the stagnant "granite derangement of mind", relying on materialistic methodology on formation worldview of the truth" of the "World Created"***. He fulfilled his mission brilliantly. Nicolai was allowed to give an understanding of the other truth of the "World Created" at a simple level of superficial language usage. He coped with this task".

Let us look into the migration of people of Black, Yellow and Red Races from different planets of our Universe to the Midgard-Earth. According to the data available in the **SAV**, this occurred approximately **38,000** years ago. However, in this case all the "migrants" together with the inhabitants of the Earth had to be destroyed after the attack. That is, the colonization by the "guests" was to occur later, most likely, within the framework of the Ebr programs for the development of energy biogenesis and brain genotypes. Earlier, it was impossible to place independent Control Systems on the Earth for Yellow, Red and Black Races because of the lack of technological developments.

Another significant event from the standpoint of today's hisTor(ah)y (and partly preserved in the people's memory) is ***the victory of our ancestors over Arimia***, which was so significant for the Aryans that a new chronology began from that date. But over whom is the victory? The

Chinese, as such, appeared much later (along with the Koreans and the Japanese). And before that, the Ebr objects 440 annihilated the arimians (?), turning the territory of their settlement into a desert (Gobi?). That is, it turns out that they fought not with the "ancestors of the Chinese", but with those who populated this territory before them?

Another point connected with the graphic display of the victory over Arimia. The Russian warrior strikes the snake with a spear; the second hand holds the reins. According to the same N.V. Levashov, one of the virtues of the Russian warriors – knights – was "two-handedness": they controlled the horse telepathically, which allowed using two hands to destroy the enemy. And what's on the icon? The subsequent interpretation of the icon painter of the event through the prism of knowledge of that time? Already greatly distorted?

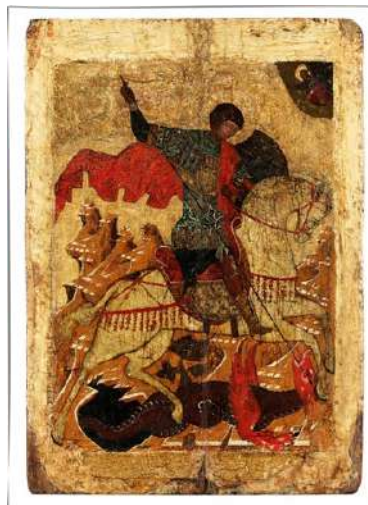

No less mysterious is the history of Atlantida. According to the assumptions, it came into being after the exodus of a part of the inhabitants of Asgard of Irii and after the appearance of representatives of the Red and other races on the Earth. The very technology of destruction of the emerged civilization is very similar to the technology of destruction of Da'Ariansthe island's sinking to the bottom... "Atlantida did not die of its free will and internal reasons, but it perished due to the intervention, but with the Atlántians's powerful resistance and defense..." Yet, Atlantida was supported for a long time by the native System and, moreover, the Interventionist System did not seek to destroy it immediately, since a variant of the possible use of the atlantians in their reincarnated version was envisaged. But the interventionists did not succeed, so they had to destroy Atlantida. Judging by the appearance of representatives of alien races on the Eath, the idea could come to the Ebr about conducting their own experiment with people by analogy with what was conceived by the Civilization of Reasonable Orientation. Only the goals were different, so mixing "Rus" ocured with genetically "weaker" material. One of its results – the creation of a gray subrace – can be considered "successful". The "red" race played its role in the Ebr plans, as well. As for the saving of some of the "leaders" of Atlántida, it could have been the result of the true Control System interference (in fact, the rods of iron were taken

from them), as well as their transfer to the territory of Egypt with the preservation of information about Da'aria (if they had it).

WE DO NOT KNOW, AND MIGHT NOT KNOW FOR QUITE A LONG TIME the true chronicle of events on the Earth, but with absolute certainty we can say today that the inhabitants of the civilization cluster of the Earth are genuine Humans, true heroes, who have done a lot for all Civilizations of Intelligent Orientation and paid not only their lives in their specific physical embodiment, but also a halt to the Spirit development and, perhaps, even the destruction of some of them. To comprehend this is the first task of Mankind after gaining its true state.

As for the rest... When humanity figures out the "basic", then it will sum up the "totals"... There is full confidence in it today.

* * *

The process of the "interventionist" development occurred with imitation of a reasonable civilization. Considering the period from 2000 BC to this day (that is, excluding everything from the analysis that preceded it as a test for the part of the interventionists), let us focus on the key points related to the fundamental program changes implemented under the interventionist control and supervision. The Programs realization through the operation of the Control Complexes was carried out strictly in stages with the aim of forming the set results, that is, the genotype of the Brain determined according to its parameters. The rest, including the habitat, and the so-called animal and plant world, were given as the complementary for the whole process. Different stages of a complex sequence of actions were controlled and governed by different, strictly defined complexes and had a rigid territorial reference. The table shows the entire sequence of the actions with some of the currently admissible details.

**Table of formation of the illusion of Interventionist civilization.
Step-by-step realization of the Brain genotypes**

2000 BCo .	
2000 BC	The Interventionist Control System begins the implementation of the Program " Energy Information Dialectics of the Brain Genotypes development ". Coordinator of the work on the creation of the Atmosphere Brain was the Complex Caucasus , therefore all major and well-known deposits are around the Caucasus..
2000 BC1605 BC.	The period of creation and natural perfection of the "shirt" (bodies of people). All values were program- determined and dictated by the objects of type 440, orienting the entire being of people for the preparation and improvement of the organism to the state suitable for the settings of the functional future of the Brain genotype 421 .
1605 BC.882 r. BC.	Formation of Brain Genotypes.
1600 BC	The Brain genotype 421 was formed under the control of the Ararat Complex (Caucasian Control Complex). The region of coverage of such an experiment is Asia Minor, Greece . The process control center is Jerusalem . This group of individuals began to develop some judgments and ideas about the so-called soul . In those old days, there were even questions arising about what the soul was in reality, the way it relates to the surrounding objective reality , i.e. with the world of objects around. The beginning of the process of the withdrawal of people from the state of the " Cupola Control " of their being through the objects of type 440 and all energy-information translation from the Caucasus Control Complex (CC) . The imposition upon the minds of people of "conceptual" elements of a certain apophatic "Supreme Power" , as if controlling them from "Above". There began the formation and further application of some constantly improved technical "methods" of the control of all the actions of people through bringing them in the state of obedience, humility and guilty ". Conversion of the general guiding state of people's Brain of that time to the level of the minimum possible energy octave (up to octave 63) of its material (proton) and non-material (neutrino and antineutrino) states. The native state of the Atmosphere Brain is octave 84 , and of the structural Brain – 96 octave . Activation of energy-information translation and the Brain control through the cubic base gratings (in the control layer - 4200 m ÷ +14800 m) in octave 63.
500 BC.	Start up the formation of 422 genotype of the Brain. Through the philosopher Parmenides, in the Kazbek Control Complex translation, there shown the judgments about consciousness as a special reality which is different from material phenomena. This "tradition" was continued by Socrates, Plato and other philosophers
882 BC	Formation of the Brain genotype 422 under the control of the Kazbek Complex (the Caucasus Control Complex) on the territory of the eastern and southern Caucasus, Central Asia and

	the East of Asia Minor. Developing the advantage of one genotype of the Brain, provided and supported the predominance over it of another one.
01433 AD.	
o.	The Elbrus Complex created the genotype 423 in the year 0 (January 17, at 02.11), completing the formation of the first group, i.e. the Brain genotype 42. The Brain genotype 423 – as more perfect. To solve the problem of prolongation biological life to certain groups of individuals, the old Control System was not able to; the approach to the fourth codon of DNA was not found. Therefore, the programs " Reincarnation " and " Christ " are introduced.
01433 AD	The program: " Reincarnation ". The Protection program: " Christ " (connection with the cubic structure of the atmosphere and provision of reincarnation, between the shirt and the matrix there is intermediate frequency is 51.5 Hz). The Program: "The Power of Money" . The central control server is Byzantium . The Brain genotype 423 is endowed with up to 12 language translators to communicate with other ethnic groups. Construction of specialized terminals – churches, mosques, Buddhist temples and temples of science. When creating the information network, initially in some nodes of the Hartmann zone there were placed information translation concentrators in the form of the ball . The diameter of the ball – from 2 to 33 cm, it had the properties of a piezo element. Under the control of the Andes Complex (a separate settlement of the " Maya "), a temporary specific task was worked out – the approbation of individual mantissas of future Brain Genotypes.
Spring, 385 AD	Through the Elbrus Complex , the main Control instrument is from the Almighty . The main control burden is on religion (as the basis of spiritual and subjective values).
1433 AD	Completion of the stage of development and improvement of the Control sphere.
14332000 AD	The startup and development of the program (the term of execution is 500 years): " The Formation of the genotype completely controlled by the Interventionist Control System ". With such a program development, the return to other modes of the Brain development is completely excluded. The conditional name of such people is electronics, i.e. with a chip in the "shirt".
Spring, 1433	The Alps Complex – the introduction of the Brain genotype 441 with the addition of mantissas of a different order. It is an intelligent, thrifty and very cruel genotype both in decision-making and in actions to implement them. It is characterized by a more subtle logical structure and a higher level of functional ability in getting information. The Program: " The Force of Power ." The religious methodology of values gave way to secret orders and clans with a halo of "selectiveness." A sharp rise in "scientific" knowledge, new technologies, which led to the emergence of machine production. The program " The Power "

	<p>of Money" receives an expanded development and power function. A push in the development of banking and the formation of elements of the world financial system. Under the dictatorial influence of sacred orders and clans, the replacement of the whole basis of subjective values.</p> <p>The slave use of Man of economy, inability to solve social problems.</p> <p>The realization of the programmed process of the division of labor.</p>
End of 1840	The individuals of the Brain genotype 441 lose their leading control positions.
18411990	
1841	<p>The Alps-2 Control Complex is turned on and the introduction of the Brain genotype 442 with an aggressive, destructive character. The stage of hegemony of the bloody genotype 442. The completion of a long stage of the development of the "Golden Billion" program process. The start of the control program "Ideology", which ensured the further formation of public consciousness in people without the influence of religious dogmas through the economist Destutt de Tracy, and later through K. Marx, F. Engels, V. Lenin, and subsequently joined their theoretical heirs. The program bases of the world outlook on the liberal (capitalist) and separately communist construction of the Structures of the organized being of people were imposed, that is, the separated types of their civilizational development. For each type, their "bright future" was presented.</p>
1845 AD	<p>Making radiation web (the most complicated design of energy gratings in the layer of "-4400 +12400 m"), covering the Earth. The people (and animals) that have a connection with such a web are conventionally called "electronics" (according to the old Program). So, the first goal – on the Earth only electronics should be left, the rest should be subject to destruction.</p>
18881999 AD	<p>The start up the program (the term – 100 years):</p> <p>Cosmopolitanism. The establishing of a single financial control, a common ideology for all Brain genotypes 421 (Ararat), 441 (Mont Blanc, Alps) and a common system of information perception by making legends, "archaeological" miracles, destroying all structures and bearers of a different ideology. Development and creation of a single mechanism for the society control, approbation of technologies for the control: capitalism, fascism, democracy, liberal democracy, socialism, and so on. Ensuring the control over all raw materials. Crating conditions for the arrival of the Ruler of the Earth (Moshiach).</p>
18411990 AD	<p>The realization of the program: "The force of power." A bloody stage-by-stage path: Revolutionism (until 1904); Militant fascism (until 1946); Destructive democratism (before 1990). Development of technologies for the production of weapons. The programmed social and administrative constructions of the local and global plan are created. The necessary volumes of</p>

	<p>accumulation and concentration of the financial resources control and the circulated produced substitute are ensured in their hands. A different social status is prepared for the "Golden Million" future. The publication of the Manifesto of the Communist Party, the uprising in Paris, the Civil war in the United States, the organization of the First International, the attempt upon the life of the Russian Tsar and many other events – are the organized and realized program processes of the old System (until 1904).</p>
19141995 AD	<p>The selectivity by the Brain Genotypes 42-46 is to be brought to the level of 22% of the total population of the planet. The execution is a success. Violence at different levels (from the systemic to the worldly one) is not a real natural civilizational and unconditional necessity, a reward and a certain "historical regularity" for the whole world community. This is an imposed program-executing illusion of information-control character for giving to all subsequent processes of civilization development strictly regulated actions and events related to the implementation of the programs of the Interventional Control System and not more!</p>
Spring, 1917	<p>The replacement of the control staff in Russia through the Genotype 442 with a revolutionary manager. The February Revolution, the October Revolution, the First World War, the seizure of power by the fascists in Germany and Italy, and the Second World War (until 1946).</p>
1919	<p>The program of the systemic control on imposing the world outlook on the basis of a tough social parasitism is turned on, which is further manifested through various theoretical and practical forms of fascism.</p>
19291946	<p>The Program: "Elimination of 50 million of the used and unwanted individuals, as consequences of the program process of energy biogenesis of the flesh cell". Entering into an active phase of execution in 1934. The programmed support of the two governing spheres of being – socialism and capitalism.</p>
19461990	<p>The mutually-regulated antagonistic phenomenon of the programmed development of two special target spheres of being – capitalist and socialist, – as a single controlled realization of the Brain Genotype 44 process of development. The accomplishment of the generalized preparation for the transition to a unified system of power and control on a liberal-democratic basis, which is to provide the basis for the next stages of the development of the Brain Genotypes. Bringing to the state of controlability the World Financial System, the unification into a single state of controlability of "the power of money and the force power". Transition to electronic controlled accounting and electronic money. Money takes on some properties of independence. A digital basis for constructing the design of the System control information, through the provided knowledge without gaining a deep awareness of its essence. Introduction of the basis of digital technologies aimed at replacing some of the Brain functions and preparing for the transition to another level of separate genotypes control at the subsequent stage. Jointly acquired is distributed according to the</p>

	quality of the Brain genotypes, the retention process is not only senseless, but also inevitable.
End of 1989	The final stage in the formation of the "Golden Billion" (Brain Genotypes 44 and partially 42).
1990-2009	
1990	Activation of the California Control Complex to start up the development of the Brain genotype 46 – the "Golden Million". The first Brain genotype 461 is obtained. The main task: creation and improvement of a specific genotype of the Human Brain in the quantities planned by the program for the specified time in order to interface with the Brain of the interventionists. A special legal basis for the existence of these individuals and the execution of the programmed functions under the conditions of an unquestionable legitimate state of "FAS", as power from the Almighty. Supporting and ensuring the cleansing of the entire power pyramid for the program actions of the "Golden million".
2000	The beginning of the liquidation of "set control programs" on separate Complexes and objects of the old System, simultaneous earthquake in Israel, northern Italy and Australia.
October 25, 1985 Autumn 1995	The accomplishment of the program for the formation of the "Golden Billion" (the term of execution is 500 years). By this time, the electronics were to get a new Brain , and the rest – all kinds of diseases with a further accelerated finale through an obituary. Attempts to find out the truth, i.e. to show initiative in getting information, were nipped in the bud by the System and in a tough way. By autumn 1995 A. Khatybov developed a software product that allowed to decode all information from the true Earth Control System , coming and built on the basis of combined signals of the musical series.
April, 2001	Elimination of the failed Development Program of individuals with 462-466 genotype of the Brain. N. Levashov's active participation in this process.
2005	The transition of the program of "Tough Social Parasitism" into a triplee fascism, namely: financial, administrative-bureaucratic and national-demographic.
2006	Activation of the program for the formation of the "Golden million" . These individuals were to have perfect protection and a direct connection with the Ebr Control System . It was planned the reconstruction of the regulation of their life by the Ebr Control System up to the achievement of practically eternal life . Formation of a sufficient number of the security forces to eliminate the instigators of revolutions, rebels and terrorists, which are inevitable at a transitional stage. N. levashov's return to Russia.
August 2012	Planning the beginning of the 3rd World War for the execution of the program: "Elimination of all individuals not belonging to the 4xx genotype of the Brain". <i>The end of the liquidation is planned by December 2012. The execution did not take place! In parallel, the process of a revival of the true Earth Control System is under way.</i> The two-way information exchange is being restored; it becomes possible to introduce some elements of technical support at the stage of direct reception of information

	from the System. Any revealed fragments of non-system information, unauthorized by the Interventionist System, are subject to liquidation together with the performer. <i>The beginning of the application of the "SvetL" Programs in the complex version – healing-transformation of the Brain.</i>
2005	Beginning of the practical realisation through the true Systemic level of the the control: "The Fundamentals of the Formation of Mankind".
April 2007	The Interventionist Control System makes New Protection for the " Golden Million ". It was planned to put the Ebr Spirits in the "shirts of the SuperJudaic priesthood (the government elite). The system of the parasitic Earth "energy sucking off" at the California Control Complex is disconnected, and this year the information communication channel of the Control System is transferred to the Russian language .
2009 .	The attempts to introduce the Brain genotype 46. A large-scale failure in the Interventionist Control System. The energy pumping up system for the radiation gratings in the "imported" base octaves is turned off; the process of natural dispersion is short.
November 13, 2009	<i>The Atmosphere Brain of the old System is liquidated.</i> The process of energy-information translation in the range of 15 – 128 octaves, which provided the control of the people's performing actions, is stopped. The start of the process on creation of a new living space, under the control of the being reconstructed Altai-1 Control Complex with involvement for some episodes of the control of the former Sichuan , Kailas , Ural, Alps-2 Control Complexes , and less often – the Bermuda CC.
January 07, 2013	The Control Complex Altai turns on the New Program "The Investment that was Shown" instead of the Interventionist Reincarnation". The Individuals with a 4XX genotype of the Brain can no longer be invested. New "SvetL" Programs are created for the Users Brain transformation.
June 22, 2012	The CC Caucasus, Alps-1, and California 1 are turned off. Completely disconnected and partially destroyed is the Andes CC, which earlier provided the control of the metabolic processes in the biological field in the framework of the program "Development of energy biogenesis of the flesh cell". The cleanzing from the former influencing states of gene modeling is activated. The quantitative development of individuals with 4XX Brain genotypes is stopped.
2010	The fundamental program corrections in the processes of the Interventionist System control are made by the Light Hierarchs (of the intelligent Civilizations) There began an active process of returning the future of Humanity to the harmony with the first program substance of the Supreme Mind state. N. Levashov creates and begins the Complex "SvetL" approbation.
April 24, 2011 г. June 24, 2012	The final change of the System Power. The complete elimination of the Earth alien intervention.

entionally October 12, 2012	The true CC Altai turns on the program process, which should be conventionally perceived as the " Eucharist ", which means Thanksgiving when translated from the Greek language – Grateful "reward for all that has been created before". It is in the active phase until 25.10 2012.
14.04.201325.10.2013	The true System of the Earth begins the child-birth control.
08.05.2013	The supported energy-information translation on the part of the control servers to form a new public consciousness across the territory of South-East Asia and the west coast of Latin America, as the first stage.
23.10.2013 .	The installation of the new programs of the control and supporting impact on the parts of the stored objects: type 400, their terminals and control servers (under cult temples and structures). The change of parameters not only to support the information of the control character, but also the inclusion of the frequencies that facilitate adaptation to the new construction of the energy information translation, including adaptation of a biological nature.
23.11.2013	The beginning of the process of the zonez formation by the Control Complex Altai: the main part of Southeast Asia, the territory of Russia with part of the Arctic, a limited part of the south of Europe, the west coast of Latin America and the Antarctic zone. The exact geographic outlines of these zones are available, the control servers are activated.
January 19, 2014	There began the process of liquidation of the "Parasitism and Violence Program" as well as the programs that previously provided the controlling predominance in the society of the individuals with 4xx genotype of the Brain, a decline in states when supporting their actions, having the character of a parasitic influence on the social society constructions of various scales. Desactivation of programs at the objects: type 560, 520 and 500, at their information terminals and control servers. The work begins to create the "SvetL" Complex of the second generation.
April, 2014	The beginning of the parameters correction of the energy pumping up of the Earth. The change of values of mantissas on all base frequencies in the range of 15 to 128 octaves (the true state reconstruction). A significant increase in the intensity of pumping in the true energy octaves of 224 to 512 . An active reconstruction of the true states of the Earth energy harmony.

The conclusion is one – either we keep up with the ongoing events, understanding them and accepting them, or taking the way leading to liquidation. There is no third option!

Mankind: chronology and histor(ah)y

Date The Ebr ECS	The event, the program	Date The true ECS
	Civilizations of the Intelligent Orientation created the Cluster – interplanetary System of the Earth (Midgard-Earth, Mercury, Venus, Mars, Phaethon, Jupiter, Saturn, Pluto, Neptune, Uranus). The earth was moving, focusing on Sirius at a distance of about 240 billion km.	More than 2 billion years BC. 10 billion years of construction
	The beginning of the civilizational development of the Earth model according to the Intelligent orientation: - Population of the planet Earth by Proto-humans. - The beginning of the Program of Guardianship in Civilizational Development by the Orion Civilization Group.	4000045000 BC
26844 BC	The Star fleet of the Ebr System from the constellation of the Ursa Mayor (Sur) approaches the Cluster Interplanetary system of the Earth	
	The switch of the Guardianship Support Programs in civilizational development from the group of Orion Civilizations to the group of Civilizations of Sirius.	
18344 BC	The beginning of the capture of the Earth Interplanetary cluster. Within 1040 years all of the planets were completely captured. The invaders linked all the planets with the gravitational tubes (later with the communication tubes), turned on the imposed base generating frequencies of the Sun radiation protection, surrounded the planets with “satellites” (as a guard convoy), and started moving towards the Big Dipper.	
18300 BC	The capture of the Earth by the forces of the remaining interventionists star fleet. All the Planet’s Brain life support structures are destroyed, her Brain lost potentials to the level of 3%, which later in a short time led to the elimination of all inhabitants of the Earth. Destruction of the true Earth Control Complexes located on the surface. Destruction of life support systems of Mars. Turn off the life support systems of other planets. Formation of a system of satellites around the planets. The beginning of the change in the structures of the captured planets.	
17914 BC	The completion of the planets capture.	
17304-16684 BC 3960 years	The first stage of the violent "civilization" Of the Earth. The insulation of the protective contour slabs with a layer of magma. The first "pouring"	

	of the Earth surface with "their own water" (containing tritium) and the formation of sand out of this water. Formation of the Interventionist Control Objects on the Earth surface.	
16684-13344 BC.	Formation of the World alien to the Earth, based on parasitism and violence. Completion of the first stage of the violent "civilization" of the Earth. Completion of the first Ebr attempts to create people with subsequent annihilation of the entire "experimental material".	
13954-10804 BC	The second stage of the violent "civilization" of the Earth. The interventionist imposed program of the "Energybiogenesis of the flesh cell" acquired a more substantial capacity in the intensified attempts to create people. The main emphasis was placed on attempts to control the Brain of people by means of primary energy-information translation of the controlling character through objects of type 440. The water acquired only fresh state, and its quantity was increased by many orders of magnitude, the former mineral inclusions practically did not exist anymore, moreover, it was the carrier of tritium . The level of priming of the planet's surface was "raised" to a higher level and reached a value of $h = -3000$ m (relative to today's level). As the continental areas expanded, interventionists began active attempts to form flora and fauna as a complex element and process in the overall "civilization" development of the Earth. Due to the negative results of the "civilization development" in the part relating to people, this so-called (not by us) "Second Civilization", was annihilated within a few days.	
10194 BC	The completion of the second stage of the violent "civilization" of the Earth. Annihilation of all the experimental individuals.	
13344-10194 BC	Attempts to combine the flesh of people with the Brain abilities of spiders. Settlement of people in the zones of objects' 440 reach and attempts to control the Brain of people through these objects.	
10804-10604 BC.	The process of program preparatory organization and partial program correction of control functions on the created Control Complexes and the placed objects for the transition of all subsequent processes of changes to the Third stage. During this short period, the first samples of "native" (lunar) humanoids (in their non-inertial energy entities) and some species of fish and birds were transferred by several "deliveries" from the Moon.	
10604-6534 гг. до н.э.	The conventional "Third Civilization". The stage most satiated with experiments in all areas: from	

	<p>the formation of sustainable intervent control in all directions of its own civilization development to attempts of introduction of independently created elements in the sphere of flora and fauna (taking into account the obtained humanoid fragments from the Moon).</p> <p>In total, 42% (approximately 400 million) of captured humanoids (energy-information soul entities of proto-Human with a former brain level of 96-124 octave) were used for the experiments. The implementation of only one program "Development of the energy biogenesis of the flesh cell" was continued. In the Atmosphere gratings all along the perimeter, the processes of arranging "the Atmosphere Brain" began to impart some kind of primary guiding of people's being without binding them to objects of type 440. But during this period it was not completed. People were brought to the state of metabolic processes provided they were suitable and capable of carnivorous (for all that, without heat treatment of the food they used). Significant results in the reconstruction of people, in the image of the proto-Man, but completely subjugated by all his life and suitability for replacing the combined design of his Brain with the Invaders' Brain design, was not achieved. As a consequence, within several days this phase was stopped in 6534 BC, and the entire experimental base was eliminated</p>	
<p>6534-6234 BC</p>	<p>The preparatory process of the program re-organization of the control character, as well as stripping from the consequences of the experiments. The surface of the Earth was filled up to h=-1200 m (relative to the current level), 8640000 power buses of the inter-polar direction were laid on the formed surface, connecting all Control Systems and placed objects, and nodes (control servers and energy distribution servers) were formed. After this subtle engineering, all the complicated "installation" was filled up to h=-100 m. Masses of water were brought down to the Earth, and from this moment the sea water (the "World Flood") was formed for the first time. The surface of the Earth took forms close to the modern one.</p>	
<p>10604 г. BC</p>	<p>The Third stage of the violent civilization of the Earth. The general vector of the goal of the Interventionist ECS for all subsequent stages of its development "From an individual disunity to the integral collegiality". In the Atmosphere grating the processes of arrangement of the Atmosphere Brain began in order to impart some kind of</p>	

	primary guidance in people's being with no reference to 440 type objects. The work was not completed within this period.	
6234 BC	The completion of the Third stage of the violent "civilization" of the Earth and preparation for the fourth one.	
	On the northern continent of Midgard-Earth, a colony of white people was founded (H'Aryans, da'Aryans, Rassens and Svyatorsy)Da'aria, Asgard of Daarius was built on the summit of mount Mir (Meru).	
	Destruction of Da'aria by the Ebr. The beginning of sinking of Da'aria to the bottom of the North Ocean-sea. The beginning of migration to the Eastern Siberia. In the place of the confluence of the Iri (Irtys) and Ob rivers, a new city of Asgard of Iri was laid.	
	Migration of people of Black, Yellow and Red races from different planets of our Universe to Midgard-Earth.	
	Atlantida came into being and perished.	
	Peace treaty between the vedic empire of our ancestorsthe Great Race and Arimia. The beginning of the chronology from the C.P.S.T. (Creation of Peace at Star Temple) (approximately coinsides with the chronology of the RaceV.A. Chudinov) – 1747 years before Adam and Eve.	5508 BC
	5500-2316 BC The appearance of the first Sumerian cities: Eridu, Bad Tibira, Larak, Sippar and Shuruppak. Fayum culture of farming and cattle breeding (the region of the famous Fayoum oasis today), Lower Egypt. Toshi culture of farmers-pastoralists tribes of Badori, the Upper Egypt area Ugarit, Ebla, Akkady (Sargon the Ancient). 3000 BC The foundation of the city of Athens.	
3500 г. до н.э.	The fourth stage of the violent "civilization" of the Earth. The Control System began to reference the "cupolas" to the atmosphere layer No. 2 . Obtaining the basic radiation frequency for each ethnic group (more than 100), in relation to which the atmosphere layer No. 2 was re-formed. The number and size of each ethnic group were brought to the Program value, primary styles of life (culture) and the boundaries of this group were introduced with reference to the layer of atmosphere No. 2.	
	3100-1800 BC Egypt: the rule of Menes (unification), the ancient kingdom, the emergence of Indian civilization,	

	the Minoan, Mycenaean and Aegean civilizations, the Middle Kingdom of Egypt (Amenemhet III).	
	The first campaign of the Aryan tribes to Ancient India (Dravidia).	2692 BC
	2500-1813 BC The state of Mittani, Slovensk the Great, the Sumerians: Uruinimgingins, the Akkadian state (Sargon the Ancient), guttei (Erridupizir), Ancient Babylon (Hammurabi), the rule of Shamshiadad I in Assyria.	
	The second campaign of the Aryan tribes to the Ancient India, led by Khan.	2006 BC
2000 BC	The beginning of the implementation by the Interventionist Control System of the Program "Energy Information Dialectics of the Development of Genotypes of the Brain". The coordinator of the work on creating the Atmosphere Brain was the Caucasus Complex, therefore all the largest and well-known deposits are around the Caucasus.	
2000-1605 BC	The period of creation and natural perfection of "shirt" (bodies of people). All values were program-determined and dictated by objects of type 440, orienting the entire being of people to the preparation and improvement of the organism to the state suitable for the setting of the functional future of the Brain genotype 421.	
1605 BC	Completion of the period of creation of the "shirt" (people's body). The Ararat Complex created the Brain genotype 421. The beginning of the process of people's withdrawal from the state of "cupola control" of their being through objects of type 440. From this moment onwards, if rapid program resettlement of people of one Brain genotype was required on the territories of another one, wars of any scale were organized. In those cases when for a certain period of historical time it was required to isolate the territory of one Brain genotype from another one, new states were formed, small states merged into empires and other similar formations.	
1675 BC	The conquest of Egypt by Hyksos (the descendants of the followers of the cult of Kali-Ma deported from Dravidia).	
1605-882 BC	Brain genotypes formation.	
1600 BC	Under the control of the Ararat Complex (Caucasian Control Complex), the Brain Genotype 421 was formed. The region of coverage of such an experiment is Asia Minor, Greece. The process control center was Jerusalem. This group of individuals began to develop some judgments and ideas about the so-called soul. In those old days, there were even arising questions on what	

	<p>the soul was in reality, the way it relates to the surrounding objective reality, i.e. with the world surrounding objects. The beginning of the process of the withdrawal of people from the state of the "Cupola Control" of their being through objects of type 440 and taking all energy-information translation from the Caucasus Control Complex. The imposition of the "conceptual" elements of a certain apophatic "Supreme Power" in the minds of people, as if controlling people from the "Above". The formation and further application of some constantly improved technical "methods and types" of the control of all people's execution actions began through the imposing upon them the state of "unquestionable submission and guilty". Transfer of the general control state of the people's Brain of that time to the level of the minimum possible octave of energies (up to octave 63) of its material (proton) and non-material (neutrino and antineutrino) states. The native state of the Atmospheric Brain is octave 84, of the structural Brain – octave 96. Activation of energy-information translation and the Brain control through cubic base gratings (in the control layer -4200 m ÷ +14800 m) in octave 63.</p>	
	<p>1490-900 BC Egypt: Thutmose III, Ramses II. Greek policies: Sparta. The Trojan War. Assyria (Tiglathpalasar I). Formation and disintegration of the Hebrew state into Israel and Judea.</p>	
822 BC	<p>The Kazbek complex created the Brain genotype 422. Developing the advantage of one Brain type, the ECS ensured and supported the predominance of one over another.</p>	
882 BC -o	<p>Formation of the Brain genotype 422 under the control of the Kazbek Complex (the Caucasus Control Complex) on the territory of the eastern and southern Caucasus, Central Asia and the East of Asia Minor. Developing the advantage of one Brain genotype, ensured and supported the predominance of one over another.</p>	
	<p>813-605 BC Carthage, Assyria: Tiglathpalasar III and Sargon II, Sineherib. First Olympic Games. The rising of the Roman Empire and the Republic. Egypt: Hushids, Assyria, Psammetich I. Persia. The Median Kingdom. The New Babylonian kingdom: the seizure of Jerusalem. Buddha. Greece: Drakonta, Solon and Pericles. Nebuchadnezzar</p>	
	<p>The first Appeal of the CGO (the Coalition Group of Observers) to Mankind, transmitted to the residents of Amuradzhapur.</p>	576 BC

	<p>558-30 BC Persia: Cyrus II and Darius I. Greco-Persian Wars. Confucius. Pyrrhus. Punic wars. Peloponnesian wars. Aristotle. Alexander the Great. Archimedes. China: Qin Shi Huangdi. Spartacus. The Pontian Kingdom: Mithridates VI. Caesar and Augustus Octavian. India: Chandragupta Maurya.</p>	
<p>500 BC</p>	<p>The start of the formation of the Brain genotype 422. Through the philosopher Parmenides, in the Kazbek Control Complex translation, there shown some judgments on consciousness as a special reality different from material phenomena. This "tradition" was continued by Socrates, Plato and other philosophers.</p>	
<p>0 AD</p>	<p>Completion of the creation of the Brain Genotype 422. The Elbrus complex created the genotype 423 in the year 0 (January 17, at 02.11), completing the formation of the first group, i.e. the Brain genotype 423 as a more perfect one, it became the basis for further refinement of possible additional performing functions of individuals of a higher control order and further improvement of the Brain genotypes. To solve the problem of prolongation of biological life of certain groups of individuals, the old Control System was unable, the approach to the fourth codon of DNA was not found. Therefore, the programs "Reincarnation" and "Christ" were introduced.</p>	
<p>0-1433 AD</p>	<p>The program: "Reincarnation". Protection program: "Christ" (connection with the atmosphere cubic structure and ensuring reincarnation, between the shirt and the matrix, the intermediate frequency is 51.5 Hz). The Program: "The Power of Money". The central control server is Byzantium. The Brain genotype 423 was endowed with up to 12 language translators for communicating with other ethnic groups. Construction of specialized terminals – churches, praying houses, mosques, Buddhist temples and science temples. While creating the information network, initially in some nodes of the Hartmann zone there were placed information translation concentrators in the form of spheres. The diameter of the ball – from 2 to 33 cm, it had the properties of a piezo element. Under the control of the Ands Complex (a separate settlement of the "Maya"), a temporary specific task was worked out – the approbation of individual mantissas of future Brain genotypes.</p>	
<p>4 . AD.</p>	<p>The date of birth of Jesus from Nazareth.</p>	

	4-330 AD. China: Han, the Three Kingdoms, Sui, five dynasties and ten kingdoms, Jin. Rome: Caesar, Nero, Diocletian, Adrian, Christianity. Kushan kingdom: Kanishka. Ruskolan: Rus Belayar. The Goths. Byzantium: Constantinople, the Constantines.	
325 AD.	The first Council of Nicaea.	
368 AD.	The "crucifiction" (stavrosis) of the famous Oriental scholar Asa (Basil, Jesus), the Prophet Joshua (scientist-occultist Yoshua, according to Morozov).	
385 AD.	Through the Elbrus Complex, the main control instrument is from the Almighty. The main control burden is on religion (as the basis of spiritual and subjective values).	
385 – 1535 AD	The creation of the Control System in the Gobi Desert.	
395 AD	"Apocalypse", or "Revelation" attributed to John the Theologian by the Church.	
	448-656 AD Merovingians: Merovei, Clovis, Dagobert. The final partition of the Roman Empire: The eastern part with the capital in Constantinople went to Arcadiy Flaviy, the Western with the center in Rometo Flaviy Honoria. Korea: Silla. Vandals, Huns, Ostrogoths, Visigoths, Sueves and Saxons. The creation in the Arabian city of Mecca of a Muslim community led by Muhammad. India: Ephthalites. End of the Western Roman Empire. The Nestorian church is separated from the Orthodox Christian church. Muhammad. Iran: Khosrov I and Khosrov II. Northern Italy: Lombards. China: Tang, Taizong. The Muslim state: Omar, Osman.	
697-700 AD.	Overthrow of the Tsarist Rus-Merovingian dynasty in Western Europe (Carolingians and Capetings). Sweden (Ingjald the Coward).	
	Construction of the Great Wall of China.	704-736 AD.
	710 AD. The creation of a centralized state in Japan – the beginning of the Nara period	
	The Second Appeal of the CGO to Mankind (Tkaatsetkoal).	711 AD.
812 AD.	Recording to the representatives of the Maya tribes (Ands Complex) a 1200-year program of civilization development.	
	829-983 AD. The unification of small states of Britain into a single state of England. Norway (Harald the Fair-haired). Byzantium: The Amorian dynasty. Rurik, Rise of Kiev, Russo-Byzantine wars. Roman	

	Empire: Otto I. Division of the Carolingian Empire. Bulgaria: Krum, Boris. Germany: Heinrich Ptitselov. Denmark: Harald I the Blue-teeth.	
	Svyatoslav and defeat of Khazaria.	965 AD.
988 AD	The start of the last night of Svarog.	
	988-1024 AD Vladimir I Svyatoslavich (Chersonesus, Anna, the baptism of Rus). Prince Yaroslav Vladimirovich the Wise in Kiev. Canute (England, Denmark and Norway). Partition of Russia between Yaroslav the Wise and his brother Mstislav on the Dnieper river. The victory of Prince Yaroslav the Wise over the Pechenegs.	
1086 AD.	The crucifixion of Radomir (Jesus Christ) in Constantinople.	
	1096-1261 AD The victory of Prince Sviatopolk over the Polovtsians in the battle of Pereyaslavl. The reign of Vladimir Monomakh in Kiev. The beginning of disintegration. The disintegration of Kievan Rus, the republic in Novgorod, the rise of Moscow, "The Lay of Igor's Host". The emergence of the Templars and their elimination. The Delhi Sultanate, which united a significant part of India. The Claremont Council and the beginning of the Crusades. Congress of the Rus in Lyubech. Latin Empire, China: Jin, Song. Delhi: Qutb. Genghis Khan.	
1209-1299 AD	Crusades against the Albigenses of Southern France (Provence and Languedoc).	
	1209-1425 AD Baty's campaign to Europe. The Lithuanian principality (Mindovg, Gedemin, Olgerd), Krevskaya union. Austria (Habsburgs). Ottoman state. "Moscow" and "Tver" Russia, the Battle of Kulikovo, the beginning of internecine wars for the Moscow throne. Hundred Years' War (England and France). Pandemic of the plague in Europe. The Burgundy Duchy (France). Tamerlane (the defeat of the Golden Horde). The Kalmar Union (Scandinavia). Jan Hus.	
1400-1433 AD.	The beginning of the 600-year program of Cosmopolitanism (lasted 608 years). The Alps complex created the first Brain genotype 441. The religious methodology of values gave way to secret orders and clans with a halo of "the selectiveness". "Formation of Man completely under the control of the Interventionist Control System", imparting another level of programmed significance to the control influence of the "power of money". Representatives of this genotype quickly gained a leading and powerful position in	

	all the influential spheres that determine both the organization and control of the whole being of society, broke the majority of established stereotypes of the value of methodology, statehood and law, and simultaneously began the processes of social reorganization of societies over a large area.	
	1438-1456 AD Holy Roman Empire: Habsburgs, Charles V. The Fall of Constantinople (Mehmed II the Conqueror). The war of Poland against the Teutonic Order. War of the Scarlet and White Rose in England (the Tudors). Novgorod under the influence of Moscow (Yalzhbitsky Treaty).	
1433 AD	Completion of the stage of development and improvement of the Control sphere.	
Spring 1433 AD.	The Alps complex – the introduction of the Brain genotype 441 with the addition of mantisses of a different order. It is an intelligent, thrifty and very cruel genotype both in decision-making and in actions to implement them. It is characterized by a more subtle logical structure and a higher level of functional ability in getting information. The Program: "The Force of Power." The religious methodology of values gave way to secret orders and clans with a halo of "selectiveness". A sharp rise in "scientific" knowledge, new technologies, which led to the emergence of machine production. The program "The Power of Money" gets an expanded development and the power function. The kick-start of the banking and the formation of elements of the world financial system. Under the dictatorial influence of sacred orders and clans, the replacement of the whole basis of subjective values. The slavish use of human of the economy, the indecisiveness of social problems. The realization of the programmed process of the division of labor.	
1433-2000 AD.	The program "The formation of the Brain genotype completely under the control of the Interventionist Control System" (the term of its execution is 500 years). With such a program of development, the return to other modes of the Brain evolution is entirely excluded. The conventional name of such people is electronics, i.e. with a chip in a "shirt".	
1457AD	Capture of the Earth Control System (Main Controllers Point, Chekhov) with the destruction of all who were present there.	
	1461-1517 AD Karl the Bold (the return of Burgundy to France, the Netherlandsto the Habsburgs). Charles V.	

	Spain. The beginning of the Inquisition. Colonization of America. European expansion to Asia. Italian wars between Italy and France. Persia: the Safavids (Shiites), the Ottoman Empire (hegemony in the Islamic world). The reform of the calendar (the transfer of the New Year from 1 March to 1 September). Expansion of Moscow's possessions, war with Livonia (Ivan III, Vasiliy III).	
	1462-1505 AD. Ivan III: the annexation of the Yaroslavl Principality, Novgorod, the Perm Region, the Rostov Principality, Vyazma and the Verkhoski Principalities to Moscow, campaigns to Kazan, consolidation of Chernigov, Bryansk, Putivl, Gomel and part of the Smolensk land with Moscow.	
1474 AD	A structure of "robots" is created, in the Brain of which there persists information on murder and the ability of killing.	
1500r.	Beginning of the 500-year program of genotype formation (voiced by Nostradamus). All modern science is to be subordinated only to the so-called Pyramid of Knowledge.	
1530 AD	Hordes of the Dzungar destroyed Asgard of the Iriy.	
	1552-1644 AD Ivan IV (Grozny). The First Zemsky Sobor. Elizabeth I and the English domination on the sea. Polish-Lithuanian Commonwealth. France: religious wars, Henry IV, Bourbons, Great French Revolution. The end of the Rurik dynasty. "Troubled" time, Semiboyarschina, Minin and Pozharsky. The beginning of the reign of the Romanovs, the Stolbov peace with Sweden, the Polyanovsky world with the Polish-Lithuanian Commonwealth. Thirty Years' War. Japan: Tokugawa. Ludovic XIV (the heyday of absolute monarchy). China: the capture of Manchuria, the Qing dynasty. The beginning of the Anglo-Dutch wars for supremacy in the sea trade.	
1653 AD	Nikon's Church reforms.	
	1654-1772 AD Pereiaslav Rada, Russian-Polish war, Ukraine's accession to Russia. War of Russia with Turkey and the Crimean Khanate. Revolution in England (constitutional monarchy, the expulsion of the Stuarts), the formation of Britain (the Windsors). Prussia. (Frederick II). Charles XII. Peter I, Russia – the empire, the abolition of the chronology from the CWST (existed for 7208 years). Anna Ioanovna and Ivan VI ("Bironovshchina"), Elizaveta Petrovna, Peter III and Catherine II. Prussia (Frederick II). Petersburg Convention on the first partition of	

	the Commonwealth between Russia, Prussia and Austria.	
1772-1775 AD	The war between the Slavic-Aryan Vedic Empire and the Moscow Tartaria.	
	1775-1806 AD. Accession of Crimea to Russia. The US Constitution, the beginning of dollar circulation. Russian-Turkish war (the capture of Ishmael). The Russian-Swedish war. Versailles Peace between Russia and Sweden. Jasian peace with Turkey. Recognition by Turkey of the accession of the Crimea to Russia. The beginning of the First Coalition War (Great Britain, Habsburg, Prussia, Spain, Sardinia and others v. France). Petersburg Convention between Russia and Prussia on the second partition of the Commonwealth. The transition to Russia of most of the Ukraine and Belarus (with Minsk). The third partition of the territory of the Polish-Lithuanian Commonwealth between the Habsburgs, Prussia and Russia (got most of the Ukraine, southern Latvia, all of Belarus and Lithuania) and the liquidation of Polish statehood. Paul I	
	1798-1809 AD The beginning of the 2nd Coalition War (Great Britain, Habsburg, Russia, Ottoman Empire against France). A coup in Paris, which brought Napoleon Bonaparte to power as 1st consul. Alexander I. Coalition Wars (Austria, Russia and Great Britain v. France), Austerlitz, Friedland, Russian-French Union. The Russo-Swedish War (annexation of Finland to Russia).	
1809 AD	The completion of the Earth's mass increase program.	
	1812-1840 AD The Patriotic War, the Bucharest peace between Russia and Turkey (the accession of Bessarabia to Russia), the Gulistan peace with Persia (the accession of Northern Azerbaijan and Dagestan to Russia). The beginning of the Sixth Coalition War (Russia, Great Britain, Prussia, Austria, Sweden, etc. against France), France's return to the borders of 1792. Return of Napoleon I to France and VII Coalition War (the whole of Europe against France), ending in the defeat of the French army at Waterloo and the restoration of the Bourbon dynasty on the throne. Nicholas I, the Decembrists, Akkerman convention between Russia and Turkey (the recognition of Sukhumi's joining Russia), Turkmanchay peace between Russia and Persia (accession of Eastern Armenia to Russia), Adrianople peace between Russia and Turkey (the accession of the mouth of the Danube and the Black Sea coast to Russia) , Poland's	

	accession to Russia. Revolution in France (the overthrow of the Bourbons). 1st Opium War (Great Britain v. China).	
1840 AD	The loss by the individuals of the Brain genotype 441 leading positions in the control.	
1841 AD	The Alfa-2 Control Complex is turned on and the Brain genotype 442 with an aggressive, destructive character is introduced. The stage of hegemony of the bloody genotype 442. The completion of a long stage of the development process of the "Golden Billion" program. The startup of the control program "Ideology", which further ensured the formation of public consciousness in people with no influence of religious dogmas – through the economist Destutt de Tracy, and later through K. Marx, F. Engels, V. Lenin, and subsequently joined their theoretical heirs. The program bases of the world outlook on the liberal (capitalist) and separately communist arrangement of the Structures of the organized being of people, that is, the separated types of their civilization development. For each type, its "bright future" was presented.	
1841 AD	Since the XIX century, the Scaligerian version of history acquired the ultimate modern forms. The false fundamental scheme of the history of Russia (Rus) was written and fixed by foreigners, all unwanted documents were erased, and artifacts were destroyed. Since 1841, the number of Russian historians began to increase in the Academy (at the time of foundation and even later there were 3 out of 34). There was a process of replacing the governing composition. By the decree of Nicholas I, the Imperial Russian Academy was joined to the Imperial Academy of Sciences as a Special Branch of the Russian language and literature. It was until 1841 that we had two Academies of Sciences.	
1841-1990 AD	The realization of the program: "The force of power." The bloody stage-by-stage path: Revolutionism (until 1904); Militant fascism (until 1946); Destructive democratism (until 1990). The development of technologies for the production of weapons. The programmed social and control constructions of the local and global plan were created. The necessary volumes of accumulation and concentration of financial resources control and the circulated produced substitution in their hands were insured. A different social status was prepared for the future of the "Golden Million". The publication of the Manifesto of the Communist Party, the uprising in Paris, the civil	

	war in the United States, the organization of the First International, the attempt upon the life of the Russian Tsar and many other things were the organized and realized programmed processes of the old System (until 1904).	
1845 AD	Creation of radiation web (the most complicated design of energy gratings in the layer "-4400 +12400 m"), covering the Earth. People (and animals) having connection with such a web were conventionally called "electronics" (according to the old Program). So, the first goal – on the Earth there should be left only electronics, the rest were to be subject to destruction.	
	1848-1883 AD The February revolution in France: the overthrow of the Orleans dynasty, III republic. Crimean War of Russia with the Ottoman Empire, Alexander II: the capture of Shamil, the abolition of serfdom, zemstvo reform, judicial reform, the reform of the secondary education. Civil War in North America. The unification of Germany (Bismarck, Hohenzollers). Austria-Hungary. Japan: The Meiji Revolution. The Russian -Turkish War, the Emancipation of Labor group. Napoleon III (French Republic). The Triple Alliance, the murder of Alexander II.	
1888-1999 AD	The start up of the program Cosmopolitism (the term – 100 years). Establishing a single financial control, a single ideology for all Brain Genotypes 421 (Ararat), 441 (Mont Blanc, Alps) and the unified system of information perception by creating legends, "archaeological miracles," the destruction of all structures and bearers of a different ideology. Development and creation of a single mechanism for the society Control, approbation of technologies for societies control: capitalism, fascism, democracy, liberal democracy, socialism and so on. Ensuring control over all raw materials. Preparation of conditions for the arrival of the Ruler of the Earth (Moshiach).	
	1891-1898 AD Japan-China War (Taiwan is annexed by Japan), Russian-Chinese agreement against Japan. Formation of the Entente. Nicholas II, the Spanish-American War (the defeat of Spain), the formation of the RSDLP, the Anglo-Boer War.	
1904 AD	Completion of the stage of "Revolutionism". "Militant fascism".	
	1902-1914 AD The program of moderately liberal reforms in Russia. Portsmouth Treaty (loss of Sakhalin). The first bourgeois-democratic revolution in Russia, Rasputin. Xinhai revolution	

	in China, which overthrew the Qing dynasty, Gohmindahn. The Balkan wars. Russia's declaration of war to Turkey. World War I.	
1914-1995 AD	Selectivity for the Brain genotypes 42-46 was to be brought to the level of 22% of the total population of the planet. The execution was a success. Violence of different levels (from the systemic to the worldly) is not a real natural civilizational unconditional necessity, a reword and a certain "historical regularity" for the whole world community. This is an imposed program-executing illusion of information-control character to impart to all subsequent processes of civilization development strictly determined actions and events related to the implementation of programs of the Interventionist Control System and not more!	
Spring 1917 AD	The replacement of the governing staff in Russia through the Genotype 442 for a revolutionary governor. The February Revolution, the October Revolution, World War I, seizure of power by the fascists in Germany and Italy, and the Second World War (until 1946).	
	1917-1920 AD. The second bourgeois-democratic revolution in Russia, the end of the Romanov dynasty, the October coup, the proclamation of independence by the Ukraine, the convention and breaking up of the Constituent Assembly, the Brest Peace.	
1919 AD	The program of the system control on imposing the world outlook on the basis of a rigid social parasitism was turned on, further expressed through the manifestation of various theoretical and practical forms of fascism. The beginning of the formation of the "golden billion".	
	1920-1924 AD Civil war in Russia. The Decree of SPC on the requisitioning of farm produce. Transition to NEP. Establishment of the Council on Foreign Relations. Formation of the Communist Party of China. The election of I. Stalin as the Secretary General of the Central Committee of the RCP (b.). Formation of the USSR, the death of V. Lenin. First Congress of the League of Nations. Femine in Russia. French occupation of the Ruhr area and currency crash in Germany. The UK is restoring the pre-war gold standard.	
	The Third Appeal of the Coalition Group of Observers to Mankind passed to E.I. Roerich and N.K Poerich.	1920 AD
	1925-1945 AD Reichsmark in Germany. The Pact in Locarno. Persia: Reza Khan. Giving up the	

	<p>NEP, collectivization, the struggle against the kulaks and the opposition. Hoover is the president of the United States. The global economic crisis, falling prices and rising unemployment. Spain (Republic). Hitler – German Reich Chancellor, civil war in Spain. The USA (Roosevelt). the USSR and Japan conflict. The annexation of the Sudetenland. The meeting of representatives of the USSR, Britain and France – Moscow negotiations. The signing of the non-aggression pact and the secret protocol with Germany, the Second World War breaks out, the Great Patriotic War, the surrender of Japan.</p>	
1929-1946 AD	<p>Program: "Elimination of 50 million used and unwanted individuals as consequences of the program process of energy biogenesis of the flesh cell". Entering into an active phase of execution in 1934. The programmed endowment of the two governing spheres of being – socialism and capitalism.</p>	
1945 AD	<p>The end of the program – "Militant facism".</p>	
	<p>1945-1946 The formation of the UN, Churchill's talk about Stalin's "iron curtain" and the accusation of "unlimited expansion of his power and his ideas" (as a signal to the beginning of the "cold war").</p>	
1946 AD	<p>The end of the replacement of the governing staff in Russia, completion of the program "Elimination of 50 million used and unwanted individuals as a consequence of the program process "Energybiogenesis of the flesh cell. "The startup of the program "Destructive Democratism".</p>	
1946-1990 AD	<p>The mutually-regulated antagonistic phenomenon of the programmed development of two special target spheres of life – capitalist and socialist, as a single governable realization of the process of development of the Brain genotype 44. Completion of the general preparation for the transition to the unified system of construction of power and control on a liberal-democratic basis, which is to provide the basis for the control of the next stages of the Brain genotype development. Bringing the World Financial System to the governable state. The unification into a single governable state of "the power of money and th force power". Transition to electronic controlled accounting and electronic money. Money gets some qualities of independence. The digital basis for making up the System's controled information through the provided knowledge without gaining a deep awareness of its essence.</p>	

	Introduction of the basic digital technologies in the interests of replacing some of the Brain functions and preparing the transition to another level of separate control of the genotypes at the subsequent stage. The jointly acquired is distributed according to the quality of the Brain genotypes; the retention process was not only senseless, but also inevitable.	
	1948-1957 AD Organization for European Economic Cooperation. Moscow talks – the USSR, the United States, Britain and France on the elimination of the "Berlin crisis". NATO formation, Marshall Plan for Western Europe. The test of an atomic bomb in the USSR. The war in Korea. Khrushchev's election the first secretary of the CPSU Central Committee. Test of a hydrogen bomb in the USA. China (Mao-Tse Dong). The Warsaw Treaty. Gagarin's flight. Caribbean crisis. The election of Leonid Brezhnev First secretary of the CPSU Central Committee. Formation of the EC.	
1965 AD	It is announced the existence of the ""golden billion" program".	
	1965- 1985 Plenum of the Central Committee of the CPSU on economic issues. Reforms. The war in Vietnam. "Six Day War" of Israel against Egypt, Jordan and Syria. "Prague Spring", conflicts on the Soviet-Chinese border. Chile (S. Allende). Treaty on the Limitation of Strategic Offensive Arms, Treaty on the Limitation of Anti-Ballistic Missile Systems. The world energy crisis. Meeting on Security in Europe. The Constitution of the USSR (Article No. 6), Soviet troops entry into Afghanistan. Vietnamese troops took Phnom Penh, China attacked Vietnam. Change of party leaders in the USSR. Poland (Jaruzelski).	
	Elimination of the program processes of the old system. Recreation of the Atmosphere energy gratings, their replenishment, changing all of its communication systems and layer functions, localization of the complete arrangement and controlled program functioning of the Interventionist Control System Brain (the Atmosphere layer # 1).	1985
	Elimination of three objects (UFOs – type 400) that previously stored the main (strategic) Programs of the Interventionist Control System, which were the essence of the Ebr strategies vector of the goals, phenomena, actions and events (simultaneous earthquake – Israel, northern Italy and Australia).	October 25, 1985
	1985 Mikhail Gorbachev is elected General Secretary of the CPSU Central Committee,	

	Gorbachev and Reagan meet in Geneva, "perestroika".	
	By the autumn of 1995 A. Khatybov developed a software product that allows to decode all information from the true Earth Control System, coming and built on the basis of combined signals of the musical series.	1995
October 25, 1985 – autumn 1995	Completion of the program for the formation of the "Golden Billion" (the term of execution is 500 years). By this time, the electronics were to get the new Brain, and the rest – all kinds of diseases with a further and accelerated finale through the obituary. Attempts to find out the truth, i.e. to show initiative in getting information, were toughly nipped in the bud by the System.	
1986	The startup of the program "New Russians". To do this the charge power was increased to octave 65 (with the norm of octave 63). The experiment was recognized as unsuccessful, since it was impossible to raise the Brain octave without changing the space of existence.	
	1986-1987 27th Congress of the CPSU. The actual recognition at the Plenum of the Central Committee of the CPSU of the failure of the acceleration program. Mass riots in Alma-Ata in connection with the resignation of D.A. Kunayev from the post of first secretary of the Central Committee of the Communist Party of Kazakhstan, the start of an open separatist movement in the USSR. Soviet-American Treaty on the Elimination of Missiles of Medium and Short Range	
	Elimination of the emergency situation at the Chernobyl nuclear power plant.	1987
	1988 Amendments to the Constitution of the USSR, the establishment of the Congress of People's Deputies and the post of chairman of the Supreme Council elected by the congress. The beginning of the withdrawal of the Soviet troops from Afghanistan. The Supreme Soviet of the Estonian SSR proclaimed sovereignty.	
1989	The final stage of the formation of the "golden billion" (the Brain genotypes 44 and partially 42). Completion of the programs "The Force of Power", "Militant Democratism" and "New Russians".	
	N.V. Levashov destroys the parasitic system on the Earth, which includes 98 psi-effect generators located in "special" zones of the Earth.	1989
	Significant program corrections of the control processes. Reduction of the effective influence of Interventionist control on the existence of energies as a whole, a step towards a complete	1989

	constructive change in the control of all the performing activities in general and the states of the controlling Interventionist Systems, the Control Complexes and Objects.	
1990	Activation of the California Control Complex to start the development of the Brain genotype 46 – the "Golden Million". The first Brain genotype 461 was created. The main task is the development and improvement of a specific genotype of the Human Brain in the quantities planned by the program at the determined time in order to interface with the interventionists Brain. A special legal basis for the existence of these individuals and the performance program activities on the conditions of an unquestionable legitimate state of "FAS", as power from the Almighty. Supporting and ensuring the cleansing of the entire power pyramid for the program actions of the "Golden million	
	1990-1991 Referendum on the preservation of the USSR. The adoption by the 1-st Congress of People's Deputies of the RSFSR Declaration on the State Sovereignty of the RSFSR. The union of the GDR and the FRG. The UN resolution on the trade embargo against Iraq. Resignation of M. Thatcher.	
	The main parasitic pyramid of psi-influence on people is destroyed. On the part of the re-created true Control System, there began the process of significant localization of the effective influence of the Interventionist Control Complexes directly controlling the formerly human being, namely the Caucasus (Ararat, Kazbek and Elbrus), the Alps (Alps-1 and Alps-2) and California -1). The effectiveness of all the program aspirations in the sphere of people's being at all levels and directions around the world has sharply decreased. It is perceived as the start of a crisis chaos in the world community, the beginning of the formation of a special state – the "rebellion of consciousness" of people around the planet. Moreover, there began to work the successful effect of the performing actions on the imposed "Album Records" from the individuals of the ruling estate of that time (mainly the Brain genotypes 44 and 461), which was initiated by the first re-created True CC (th Control Complex) "Altai", and much more.	1991
	1991-1994 The coup d'etat in Moscow, the transfer of real power to the president of the RSFSR B.N. Yeltsin, the dissolution of the CPSU, the beginning of the collapse of the USSR.	

	Operation 'Desert Storm'. Liquidation of the USSR, MIA. Creation of the CIS. Transition to free prices and free currency conversion, the beginning of economic (monetary and commodity) intervention. The beginning of privatization in Russia, the constitutional crisis, the start of the Chechen war. Establishment of the Collective Security Treaty Organization. Treaty with the United States on the reduction of strategic offensive weapons.	
	Completion of the program for the formation of the "golden billion". New social relationships are introduced that exclude terror, wars, the human environment is changing, to which the "golden billion" is not prepared. The start of the practical termination and the subsequent liquidation of the previously imposed process of preparation for the active operation of the CC California-2. The liquidation of the Programs to control the performing actions of people at the Elbrus, Kazbek, and Alps 1 Control Complexes was completed. All the control servers that close on them ceased their program control, most of them were liquidated.	1995
1995	Inclusion of an emergency escort program for the "golden billion".	
1995-2004	Selectivity for the brain genotypes 42-46 is brought to the level of 22% of the total population of the planet. "Systemic failure" in the work of the Control Complexes for the performing activities control.	
1996	The end of the last night of Svarog.	
	1996-1999 Boris Yeltsin is elected President of the Russian Federation for a second term, the withdrawal of federal forces from Chechnya. The war of NATO against Yugoslavia. Appointment of V. Putin as Acting President of the Russian Federation	
1999	Completion of the 100-year program "Cosmopolitanism".	
2000	Completion of the 500-year program. Completion of the program for the creation of the Brain genotype 441. Complex Elbrus created genotype 423, completing the formation of the first group, i.e. the Brain genotype 42.	
2000	The introduction of the program – "the golden million".	
	2000 Election of V. Putin President of the Russian Federation. The destruction of the Kursk nuclear submarine, the transfer of V. Gusinsky's media holding company to Gazprom-Media, the fire at the Ostankino TV tower	

	Elimination of the failed development program of individuals with the Brain genotypes 462-466. Active participation of N.V. Levashov in this operation.	April 2001
	2001-2003 Establishment of the SCO. "Nord Ost". "Terrorist attack" in the United States. The Iraqi conflict. Treaty on the reduction of strategic offensive potentials. The start of the circulation of Euro banknotes and coins in the European Union. The war in Iraq.	
	Accomplishment of the formation of the common memory grating and control structures.	2003
	2004 V. Putin was elected president for the second term. V. Yushchenko became President of the Ukraine, in Georgia – M. Saakashvili. The government company of Japan allows the cloning of human embryos for research purposes. Expansion of the European Union, inclusion of 10 countries. "Orange" revolution in the Ukraine.	
	Liquidation of the consequences of the intervention. The beginning of the practical implementation of the theory of "The Foundations of the formation of Mankind" through the native systemic level of the Control. The process of recreation of the complex control states on the Altai 1 Complex began as the first restored element of the true Control System.	2005
2005	The transition of the program of "The Tough Social Parasitism" into a triple fascism, namely: financial, administrative-bureaucratic and national-demographic.	
	The Planetary Control System (700 km south of the Cheops pyramid) got an order to ban the lifting of all objects (UFOs). A programmed correction of the control processes related to religious buildings is carried out.	2005
	2005 The implementation of four priority national projects is stated. Beginning of the monetization of social benefits. In Bishkek, instead of A. Akayev, K. Bakiyev came to power. Yulia Tymoshenko is the Prime Minister of the Ukraine.	
	N. levashov returns to Russia.	2006
2006	Activation of the program for the formation of the "Golden million". These individuals were to have perfect protection and a direct connection with the Ebr Control System. It is planned to recreate the regulation of their life by the Ebr Control System until the achievement of almost eternal life. The formation of a sufficient number of the security forces to eliminate the instigators of	

	revolutions, rebels and terrorists, which are inevitable at the transitional stage.	
	The beginning of the transformation and change of nuclear warheads. The Russian language is adopted by the new System as the programming language of communication and control in the framework of the new Program	2006
	2006 The annual message of the President with an emphasis on the modernization of the army, the emasculated "Law on Local Self-Government" comes into effect, the "gas war" with the Ukraine, the deterioration of relations with Georgia, Russia paid off ahead of schedule with the Paris Club the debts of the former USSR. The murder of the first deputy chairman of the Central Bank A. Kozlov. The first in the 21 century solar eclipse in Russia.	
April 2007	The formation of the New Protection for the "Golden Million" by the interventionist Control System. It is planned to replace the Brain of the Super-Judaic priesthood (the government elite) with the Brain of the Ebr elite. The system of parasitic "energy suction of the Earth" on the Control Complex of California is turned off.	
2007	Giving up the idea of implementing the "Golden Billion" program. Individual structures docking at the atomic level failed , so a decision was made to return to 0 AD and begin all over again	
	The communication with the Moon is eliminated in the interests of the Control Complexes and the Objects, as well as the individuals of the genotype 4xx	2007
2007	Formation of the new protection for the "Golden million".	
	Transition of the Earth Control System from English into Russian. 2007 is declared the year of the Russian Language.	2007
	2007 V. Putin named successor – D. Medvedev. Russia suspended participation in the Treaty on Conventional Arms and Armed Forces in Europe, B. Yeltsin died. IOC determines Sochi as the venue for the XXII Winter Olympic Games in 2014. In the elections to the State Duma of the fifth convocation, the "United Russia" gets the constitutional majority. President of France is Nicolas Sarkozy, EU – Russia Summit. Murder of B. Bhutto.	
	Partial destruction of the Ebr Control System. Serious systemic failures in all Control Complexes of the old System, which led to irreversible processes, not only in supporting and ensuring	2008

	<p>program actions of the executors, but also in the development of the Brain genotypes.</p> <p>The Sichuan Control Complex is mainly liquidated (only the programs of technological profile and biological support are preserved), the Bermuda Complex, the archive of biological control programs at the Kailas Complex.</p> <p>The work of the main energy-information translator of the old Control System (Chekhov Control Complex) is disconnected, the entire control process is switched to the true CC Altai 1.</p>	
2008	<p>The splash of problems caused by the conversion of octaves above 128 in the static position without the possibility of correction at the time of the Earth's capture (splash of diseases).</p>	
	<p>2008 D. Medvedev is elected third President of the Russian Federation, Putin's appointment as prime minister. The Kosovo Parliament proclaims independence of the republic from Serbia. The armed conflict between Georgia and South Ossetia, Russia supports Ossetia, the death of the Patriarch of Moscow and All Russia Alexy II, the election of Cyril as the new patriarch. The beginning of the first global recession in the US, EU and Japan. The first African American president in the United States</p>	
	<p>The Atmosphere Brain of the old System is eliminated. The process of transmission of energy-information translation in the range of 15 – 128 octaves, which provided the control of people's performing actions, is stopped. The start up of the process of formation of the new living space under the control of the re-created Altai-1 CC with involvement in some episodes of the control of the former Sichuan CC, Kailas CC, CC Ural, Alp-2 CC and less often -Bermuda.</p>	November 13, 2009
2009	<p>According to the plan of the alien system, the first Brain genotype 461 is created.</p>	
	<p>A large-scale failure in the Interventionist Control System. The energy pumping system for radiation gratings is switched off for the "inported" base octaves, the process of natural dispersion is short.</p>	2009
	<p>2009 In Ekaterinburg the first BRIC summit is held. Record-breaking "gas war" between Russia and the Ukraine. For the first time in more than 40 years, WHO officially announced the introduction of a maximum (sixth) level of the 'swine flu' threat . For the first time in the last 8 years, Russia has a deficit budget. Gaidar died. The Lisbon Treaty entered into force in the European Union. B. Obama is awarded the Nobel Peace Prize.</p>	

	<p>The Light Hierarchs of the Intelligent Civilizations made fundamental program corrections in the processes of the Interventionist System Control. The active process of returning the future of mankind to harmony with the initial program substance of the Supreme Mind state began. Climatic and geophysical weapons are destroyed. Technical communication to move all types of objects in layer No 6 is eliminated</p> <p>The Control Complexes disappeared. The main control complex is Sichuan, China-2. All sea-based objects disappeared (operational control). Earthquakes in Chile, Haiti. No polar lights. No Current Gulf Stream</p> <p>N. Levashov created and begins approbation of the Complex "SvetL".</p>	<p>2010</p>
	<p>2010 Extensive peat fires in the Moscow, Ryazan, Nizhny Novgorod, Sverdlovsk, Kirov, Tver, Kaluga, Pskov regions and Mordovia. The Common Customs Tariff of the Customs Union of Russia, Belarus and Kazakhstan comes into force. The Russian Federation and the United States sign the Treaty on the Reduction and Limitation of Strategic Offensive Arms (START II). V. Yanukovich wins the presidential elections in the Ukraine. The peak of the world economy stimulation program. The "British Petroleum" platform sinks off the coast of Louisiana.</p>	
	<p>New programs of the control and supporting influence on the parts of the stored objects of type 400, their terminals and control servers (under the cult constructions) are installed, the parameters are changed not only to support information of the controlling nature, but also contribute to adaptation to the new energy information translation construction, including the adaptation of the biological nature .</p>	<p>2010</p>
	<p>Completion of the transition period. Elimination of communication with the Moon: specialized target forms of the Programmed information for the Brain genotype 4xx – "The Album Records". The programmed functions correction (reproduction, elimination, execution of "the album records") with the help of the atmospheric layer №6. The connection with the Sun is eliminated: setting the clock cycle of the metabolic processes for all biostructures and the clock of the event-driven time (1,0007 seconds). The processes of constructive recreation of the energy gratings of the atmosphere in their true state and their pumping up (replacement in the course of the entire Transition period) are completed; all its communication systems and</p>	<p>2011</p>

	<p>functions of its layers are changed, all the complete organization and the control programmed functioning of the Interventionist Brain of the Control System is completely localized (the Atmosphere layer No.1) More than 70% of the Control Systems, Complexes, Objects and Servers of the old System are destroyed, and the stored ones are either de-energized or reprogrammed for temporary use in order to ensure a smooth transition to new states of being, especially in the biological field.</p>	
	<p>The act of changing the System Power is definitely carried out. The complete elimination of the alien intervention of the Earth. From the re-created objects of the Control System (the territory of Russia) for the first time, the whole complex process of the complete control of the Conceptual Power is organized and formed with the involvement of Man at certain levels of his participatory operation. The Native ECS recreates the "Altai" complex as the principal executive complex.</p>	<p>24.04.2011-06.2012</p>
	<p>2011 D. Medvedev offers to support the candidacy of V. Putin at the presidential election in 2012. Yulia Tymoshenko is sentenced to 7 years in prison. "Jasmine" revolution in Tunisia, revolution in Algeria, Jordan, Mauritania, Egypt, Morocco, Libya, Bahrain, Yemen and Syria. The most powerful earthquake in Japan's history, an accident at the Fukushima nuclear power plant.</p>	
	<p>The CC Caucasus, Alps-1, California-1 are turned off. The Andes CC is completely disconnected and partially destroyed, which ensured control of metabolic processes in the biological field in the framework of the program "Development of energy biogenesis of flesh cells". Cleansing of the former influencing states of gene modeling is activated. Quantitative development of individuals with the Brain genotype 4xx is stopped</p>	<p>June 22, 2012</p>
	<p>Planning the start of the 3rd World War for the execution of the program: "Elimination of all individuals not belonging to the 4xx genotype of the Brain". The end of the liquidation is planned by December 2012. The execution does not take place! In parallel, there is a revival of the native Earth Control System. The two-way information exchange is restored, it becomes possible to introduce elements of the technical support at the stage of the direct reception of information from the System. The beginning of the application of the "SvetL" Programs in the complex version – healing-transformation of the Brain.</p>	<p>August, 2012</p>

	<p>The true CC Altai includes the programmed process "Eucharist", which means "Thanksgiving" in translation from the Greek language. Grateful "retribution for all that had been created before". It is in the active phase until 25.10.2012</p>	<p>October,12 2012</p>
	<p>A separate episode of the beginning of a significant change in the sphere of people's being is the process of formation of a new living space, under the control of the re-created CC Altai-1 involving the CC Sichuan, the CC Kailas, the CC Ural, the CC Alps 2 and less often – Bermuda for the separate episodes of the control. In addition, the mode of operation of all Control Complexes is changed; all of them, in case of any forced involvement at certain intervals, work only in the interests and under the control of the true re-created CC Altai 1.</p> <p>The change in the form of the space of scattering of the true base radiation frequencies recreated in the Atmosphere gratings of the recovering true Earth Control System Brain turns into an active form of implementation along the southeastern and northern parts of the Eurasian continent.</p>	<p>23.11.2012</p>
	<p>The change in the form of the space of scattering of the true base radiation frequencies, recreated in the Atmosphere gratings of the recovering true Earth Control System Brain turns into an active form of implementing across the Latin American Continent and Antarctic Continent.</p>	<p>December 26 , 2012</p>
<p>2012</p>	<p>Plans of the ebr system: the completion of the radiation web creation, which spans the globe, after that only those who could be controlled by the web and the development program are to remain on the Earth, which would not allow another way of the Brain development.</p>	
	<p>The program of reincarnation is completely stopped. The revival of the native Earth Control System. Restoration of the two-way information exchange. Any manifested fragments of the non-systemic information are subject to liquidation together with the performer by the Interventionist System. The worldview basis of modern people on the formation of the public and individual Consciousness is switched from the basic position of "Benefit" to "Reasonableness".</p>	<p>2012</p>
<p>2012</p>	<p>The CC "Altai 2" turns on the process of performing actions as the execution of the "album records", the territory of the execution is the Ukraine. Failure to complete the second cycle of the formation of individuals with the Brain genotype 46 (the event does not take place). Completion of the 1200-year program of the</p>	

	civilization development recorded to the representatives of the Mayan tribe.	
	Monitoring and maintaining the clock cycle (1, 0007 sec.) Complex Stonehenge is turned off from the old Control System. A new control and maintenance of the clock cycle (1.008 seconds) is turned on which is the true recreated time of the Earth at its first stage of the civilization development. This process corresponds to a special mutual position of the objects ("Parade of the Planets").	2012
	2012 V. Putin is elected President of the Russian Federation for the third time, the "people's march" in Moscow against his inauguration, the resignation of V. Serdyukov. Flood in Krymsk. On the territory of Russia, Belarus and Kazakhstan, the Single Economic Space begins functioning. North Korea officially proclaims itself a nuclear power. Russia joins the World Trade Organization, the APEC summit in Vladivostok. Debts of Greece. B. Obama is elected President of the United States for the second term. At the XVIII Congress of the Communist Party of China, there is a change of party leadership (Xi Jin-ping).	
22.12.2012	The date of the planned arrival to the Earth of the representatives of the "golden million" (984,000 individuals). The event does not take place (the energetic constructions of the Ebr elite Brain are destroyed "on the way").	
	The Control Complex of Altai turns on a New Program "The Investment that was shown" instead of the Interventionist program "Reincarnation". The Individuals with the 4xx genotype of the Brain can no longer be shown. New "SvetL" Programs are created aimed at the transformation of the Users' Brain.	January 7, 2013
	The Native System of the Earth begins to control the process of child-birth.	14.04.2013 25.10.2013
	The change in the form of the space of scattering of the true base radiation frequencies recreated in the atmosphere gratings of the recovering true Earth Control System Brain turns into an active phase of realization on the territory of Southeast Asia and the western coast of Latin America.	08.05.2013
	The installation of new programs of the control and supporting influence on some stored objects of type 400, their terminals and control servers (under cult temples and structures). The change of parameters not only to support the information of the control character, but also with the frequencies facilitating adaptation to the new construction of energy information translation, including the adaptation of biological nature.	23.10.2013

	<p>The change in the form of the space of scattering of the true base radiation frequencies, recreated in the atmosphere gratings of the recovering true Earth Control System Brain turned into an active form of realization across the territory of Russia with a part of the Arctic.</p>	
	<p>The Control Program "Violence and parasitism" is finally liquidated at the object (type 960, Moscow) and the objects of its "escort", i.e. objects of type 520 and 500 (MSU, Mnevnik, Ilyinka 6, Tsaritsyno, Zhukov Avenue in Moscow). Through this program, for the entire time of the Interventionist Control System operation the orientation of the target Vectors of phenomena, actions and events had been carried out.</p>	<p>October 26, 2013</p>
	<p>There turn off the CC Caucasus, Alps 1, California 1, the energy pumping up system for the radiation gratings by the "imported" base octaves, the process of natural dispersion is short. Completely disconnected and partially destroyed is the Andes CC, which provided the control of metabolic processes in the biological field in the framework of the program "Development of energy biogenesis of the flesh cell".</p> <p>The transition to the new Construction of the controlled organized being "Mankind" as the process of the comprehensive reorientation to a different way of the Civilization development, the start of the practical way in performing actions regarding which there must be the realization of the "New Doctrine of Transition to Another World Order".</p> <p>The cubic construction of the Atmosphere and materialization of parts of structures in the Atmosphere lower level. The work of the CC Ural program is stopped. The cubic structure of the small antenna at the altitudes of 8800-12400 m is eliminated by micro-breaking of the Atmosphere in a limited space (Chelyabinsk meteorite). There begins the transforming purposeful translation of the ECS in Russia at the level of the tough influencing nature of the Control state.</p>	<p>2013 г.</p>
	<p>2013 The ban for the possession of foreign accounts for the officials and parliamentarians. Pardon of M. Khodorkovsky. Evromaydan in the Ukraine. The economic crisis in Cyprus in March paralyzed the country's banking system. Benedict XVI announces the abdication of the throne. The Argentine Cardinal H. Bergolio is elected head of the Roman Catholic Church. At the president election in Iran a representative of the reformers</p>	

	H. Roukhani wins. Snowden gives the media the first documents on the surveillance of US government organizations of users of the Internet. Death of Thatcher. The US Federal Reserve announces the curtailment of the program of assistance of the national economy.	
	There begins the preparation for the second generation of the Complex "SvetL".	January 19, 2014
	Correction of the parameters of energy pumping up of the Earth, related to the change in the values of mantissas over all base frequencies in the range of 15-128 octaves (re-creation to the true state) and a significant increase in the intensity of pumping up in the true energy octaves of 224-512. Active recreation of the true states of the Earth energy harmony.	April 2014
	Completion of the elimination of connection of individuals of the Brain genotypes 441,442 with the Sun with the help of the atmospheric layer №6. Startup of the program to create another "golden million". Destruction of the artificially imposed Anglo-American-European illusion of the historical inevitability of their civilization superiority.	2014
	Within the framework of the programs connected with the dialectic of the development of the Brain genotype (the conditions of the Habitat and Control) and the programs for the development of protoenergy-biogenesis of flesh as part of the Space Anthropoecology, the reconstructed complexes "Ural" and "Altai 2" start work on launching more than 8000 Programs (the Earth return to the Development Program, which was given to it at its inception and which was hidden by the True Earth Control System at the time of the Ebr's attack).	2014
	2014. XXII Winter Olympic Games in Sochi, demonstrations of supporters of European integration in Kiev, the duties of the head of state are entrusted to A. Turchinov, the Cabinet of Ministers is headed by A. Yatsenyuk, a referendum is held in Crimea and Sevastopol on the status of these territories. Crimea is proclaimed a sovereign state, it became part of Russia. The United States and the EU impose sanctions on a number of Russian politicians and companies. An armed conflict in the east of the Ukraine.	

	<p>Changing part of the parameters of time and space for a living cell to change the conditions of life in the framework of the program of Space Anthropeocology. More than 8000 programs are started for their realization.</p>	<p>2015</p>
	<p>2015 V. Putin speaks at the 70th UN General Assembly in New York and says out against "the only center of domination in the world". The St. Petersburg International Economic Forum gathers a record number of participants from 115 countries. The Eurasian Economic Union begins its work. Western leaders ignore the May 9 parade in commemoration of the 70th anniversary of the Victory in the Great Patriotic War of 1941-1945 because of the crisis in the Ukraine. In Russia, the action "The Immortal Regiment" takes place, in which about 12 million people take part. The murder of B. Nemtsov. The beginning of the operation of the Russian Armed Forces in Syria. EU sanctions against Russia are extended, the US expands the sanctions list. The US Supreme Court legalizes same-sex marriages.</p>	
	<p>Formation of the new living space (the second stage of the Transition Period).</p>	<p>2016</p>
	<p>2016 On the day of national unity in Moscow, a monument to Prince Vladimir is opened. In Russia, in addition to the Internal troops of the ministry of Internal Affairs a new force structure – the troops of the National Guard (Rosgvardia) is formed. Rosneft shareholding is sold to a consortium of foreign investors. The profit of Russian banks tripled the previous year indices. D. Trump wins the presidential elections in the USA. Washington accuses Moscow of interfering in the election process. In Ankara, the ambassador of the Russian Federation A. Karlov is killed. The WADA Commission accuses Russia of creating a state program for the use of doping. The Verkhovna Rada of the Ukraine dismisses A. Yatsenyuk and appoints V. Groisman to this post. President of Uzbekistan Islam Karimov dies. Supporters of the withdrawal from the European Union win the referendum in England. The operation to release Aleppo from the militants is completed. The UN Security Council, the United States and the European Union lift economic sanctions from Iran.</p>	
	<p>2017 The election of US President D. Trump. The St. Petersburg International Economic Forum gathers a record number of 14,000 participants. – The main question: "How to save money and real estate exported abroad?" Emmanuel Macron</p>	

	takes office as President of France. Abnormally cold summer, a hurricane in Moscow, record heavy showers and snow. Change in the color of the Black Sea, the shallowing of Venice canals, fires and drought in Europe. The Ukraine gains access to the EU on a visa-free regime. Russia reaches strategic parity with the NATO countries. Syria: Russia-Turkey-Iran. Referendum in Catalonia, Veneto and Lombardy (Italy), Kurdistan (Iraq). The Valdai Club and V. Putin's speech. XIX Congress of the Communist Party of China.	
--	---	--

Let us imagine that the **ENTIRE HISTORY OF MANKIND** is squeezed in within twelve hours and that we are living at noon of the long day of Mankind. Let's suppose, for the sake of simplicity and convenience of calculation, that Man has moved on two extremities and **HAS SHOWS INVENTIVENESS** only for **two hundred and forty thousand years**. Every hour on our watch means twenty thousand years, every minute is three hundred thirty-three and three-tenths of a year. For the first eleven and a half hours, **THERE WAS NOTHING REGISTERED**. We do **NOT KNOW ANYTHING** either of people or events; we just assume that on the Earth there lived Man, because we find his stone tools, fragments of pottery, as well as some of his drawings of mammoths and buffalo.

Only ***at twenty minutes to twelve*** the very first traces of the Egyptian and Babylonian civilizations begin to appear. Greek literature, philosophy and science, which we are accustomed to speak of as "ancient", are not even seven minutes old. A minute before twelve, Lord Bacon wrote his "Multiplication of Sciences", and ever since the Man made a steam engine work instead of himself, only less than half-minute passed. ***Such is the perfect example of a small-scale representation of history with the help of clocks.*** Only after defining the year of the first Olympiad and the date of the founding of Rome, the chronology becomes clear enough to determine the year in which this or that event occurred. Approximately in the thousandth year BC. the Aryan people began to settle on the peninsulas of Spain, Italy and the Balkans, but in India by that time they had already settled; Knossos had already been destroyed, and the great Egyptian times of Tutankhamun III, Amenhotep III and Ramses II had ended three or four centuries before. In the valley of the Nile there ruled the weak monarchs of the 21st dynasty.

Israel was a united state under the rule of its first kings; Perhaps, Saul or David ruled, and maybe even Solomon. Sargon I (2300 BC) from the

Akkadian-Sumerian kingdom was only a distant episode of Babylonian history, even more remote than Constantine the Great for the world of today. A thousand years have already passed since Hammurabi died. The Assyrians already dominated the less warlike Babylonians. In 1100 BC Tiglathpalasar I conquered Babylon. However, there was no permanent conquest; Assyria and Babylonia still remained separate empires. In China, the new dynasty of Zhou flourished. Stonehenge in England was already a thousand years old. The next two centuries witnessed the revival of Egypt under the XXII dynasty, the disintegration of the small and short-lived Izraili-Jewish kingdom of Solomon, the spread of the Greeks in the Balkans, southern Italy and Asia Minor, and the rule of the Etruscans in Central Italy. Of course, everything that is mentioned here is a written hisTor(ah)y, but it does not say that it was just like that.

The list of reliable dates

Since 800 BC	
800	Carthage is founded.
790	Conquest by the Ethiopians of Egypt (the foundation of the XXV dynasty).
776	The First Olimpiad.
753	Rome is founded.
745	Tinlatpalasar III conquers Babylonia and establishes a new Assyrian empire
738	Menaim, the king of Israel, pays off Tiglathpalasar III.
735	The Greeks settle in Sicily.
722	Sargon II arms the Assyrians with iron weapons.
721	Sargon resettles the Jews.
705	Sinaherib.
701	His army is destroyed by a plague during the campaign against Egypt.
680	Asarhaddon captures Thebes in Egypt (having overthrown the Ethiopian XXV dynasty).
667	Sardanapalus
663	Psammetich I liberated Egypt and founded the XXVI dynasty (until 610). In the war with Assyria, the Lydian troops helped him, which were sent by Gig.
608	Pharaoh Necho defeated Josiah, king of Judah, in the battle of Megiddo.
606	The seizure of Nineveh by the Chaldeans and the Medes. The foundation of the Chaldean kingdom.
604	Necho is pushed to the Euphrates and is defeated by Nebuchadnezzar II
586	Nebuchadnezzar drives away the Jews into Babylon. Many of them flee to Egypt and settle there.
558	Cyrus the Persian becomes the successor of the Cyaxper of the Medes. Cyrus defeats Crease. Around the same time the Buddha was born, as well as Confucius and Lao Tzu
539	Cyrus conquers Babylon and establishes the Persian Empire.

527	Pisistratus died.
525	Cambyses conquers Egypt. Aeschylus was born.
522	Darius I, the son of Hystasp, rules from the Hellespont to the Indus. His expedition to Scythia.
495	Sophocles was born.
490	Marathon battle.
484	Herodotus is born. Aeschylus wins his first prize in the genre of tragedy
480	Battles at Thermopylae and Salamis. Euripides was born.
479	The battles at Plataea and Mikal completed the expulsion of the Persians.
474	Sicilian Greeks destroy the fleet of the Etruscans.
470	The journey of Gannon.
466	Pericles.
465	The murder of Xerxes.
438	Herodotus reads his "History" in Athens.
431	The beginning of the Peloponnesian War (before 404).
429	Pericles died. Herodotus died.
427	The beginning of the career of Aristophanes. Plato was born. He lives until 347.
401	Retreat of Ten thousand Xenophon.
390	Brenn is looting Rome.
366	Camille is building the Temple of Concord.
359	Philip is the king of Macedonia.
338	Battle of the Chronicles.
336	Macedonian troops enter Asia. Murder of Philip.
334	The Battle of Granik.
333	The Battle of Issa.
332	Alexander of Macedon in Egypt.
330	Darius III is killed.
327	Alexander is in India.
323	The death of Alexander of Macedon.
321	Chandragupta became ruler of the Punjab. The Samnites dealt a crushing defeat to the Romans in the Battle of the Kavdinsky Gorge.
303	Chandragupta defeats Seleucus.
282	Ptolemy Soter died.
281	Pyrrhus invades Italy.
280	The Battle of Heraclea.
279	The Battle of Auscule.
278	Raid of the Gauls to Asia Minor and their settlement in Galatia.
275	Pyrrhus leaves Italy.
264	The First Punic War (Ashoka rules in Behar – until 232). The first battles of gladiators in Rome.
260	The Battle of Milah.
256	The Battle of Cape Eknom.
246	Shi Huang-di – the king of the Qin Empire.
241	The Battle of the Egat Islands. End of the First Punic War.
225	Battle of Telamon. Roman armies in Illyria.
220	Shi Huang-di becomes the emperor of China.
218	The Second Punic War.
216	The Battle of Cannes.
214	The construction of the Great Wall of China began.
210	Death of Shi Huang-di.

202	The Battle of Zama.
201	The end of the Second Punic War.
200-197	The period of the war between Rome and Macedonia.
192	War with the Seleucids.
190	The Battle of Magnesia.
149	The Third Punic War. (Yuezhi came to the Western Tan).
146	Destruction of Carthage. Destruction of Corinth.
133	Attalus bequeathed Pergamum to Rome. Tiberius Gracchus is killed.
121	Gaius Gracchus is killed.
111-105	The war with Jugurtha.
102	Marius expelled the Germans.
100	Maria's Triumph (U-di conquers the valley of the Tarim River).
91	Civil war in Italy.
89	All Italians become Roman citizens.
86	Death of Maria.
78	Death of Sulla.
73	The uprising of slaves led by Spartacus.
71	The defeat and death of Spartacus.
66	Pompeii leads his troops to the Caspian region and the Euphrates. His clashes with the Alans.
63	Mithridates Eupator, king of Pontus, died.
53	Krasé is killed in the battle of Carrá. Mongolian elements among the Parthians.
48	Julius Caesar defeats Pompey from Farsal.
44	The murder of Julius Caesar.
31	Battle of the Campaign.
27	Augustus Caesar – princeps (first on the list of senators) (until 14 AD).
The Christian era	
4	The real date of the birth of Jesus of Nazareth.
6	The province of Moesia is organized.
9	The province of Pannonia is organized. The borders of the empire moved closer to the Danube
14	August died. Tiberius is the emperor.
30	Jesus from Nazareth is crucified.
37	Caligula is the heir of Tiberius.
41	After the murder of Caligula Claudius (the first emperor of the legions) – the emperor with the support of the Praetorian Guard.
54	Nero inherits Claudius.
61	Queen Boudicca destroys the Roman garrison in Britain.
68	Suicide of Nero (temporary emperors – Galba, Oton, Vitellius).
69	Vespasian founded the so-called Flavian dynasty
79	Titus is the heir of Vespasian.
81	Domitian.
84	Joining Northern Britain.
96	Nerva founded the so-called Antonin dynasty.
98	Trajan is the heir of the Nerva.
102	The Chinese are on the Caspian Sea. Indoskifs invade Northern India.
117	Adrian is Trajan's heir. The Roman Empire gets its largest size.
138	Antoninus Pius is the heir of Hadrian. (The Indo-scythians destroy the last remnants of the Hellenes rule in India).

150	Around this time, Kanishka rules in India, Kashgar, Yarkand and Khotan.
161	Marcus Aurelius inherits Antonina Pius.
164	A great plague epidemic that lasted until the death of Marcus Aurelius (180). It also devastates all of Asia
180	Death of Marcus Aurelius. (The beginning of about a century of wars and trouble in the Roman Empire).
220	The end of the Han dynasty. The beginning of the four hundred year partition of China.
226	Ardashir 1 (the first Sassanid king) put an end to the line of the Arshakids in Persia.
242	Mani preaches his teaching.
247	The Goths cross the Danube.
251	A big victory of the goths. The Emperor Decius is killed.
260	Shapur I, the second Sasanian king, conquered Antioch, captured the emperor Valerian, but during his return from Asia Minor was defeated by Odanat from Palmyra.
269	Emperor Claudius defeats the goths at Nis
270	Aurelian is the emperor.
272	The captive queen Zenobia is brought to Rome. The end of the short-lived triumph of Palmyra.
275	Probus inherits Aurelian.
276	The Goths in Ponte. The Emperor Probus kept the onslaught of the Franks and the Germans.
277	Mani is crucified in Persia.
284	Diocletian is the emperor.
303	Diocletian persecutes the Christians.
306	Constantine the Great is the emperor.
311	Galerius stops the persecution of Christians.
314	Constantine presides at the Christian Council in Arles.
321	New raids of the Goths are repeled.
323	Constantine presides at the Council of Nicaea.
337	Expelled by the Goths, the vandals are allowed to settle in Pannonia. The baptism of Constantine on his deathbed.
354	Saint Augustine was born.
361-363	Julian the Apostate makes an attempt to replace Christianity with Mithraism.
379	Theodosius the Great (Spaniard by birth) is an emperor.
390	The destruction of the statue of Serapes in Alexandria.
392	Theodosius the Great is the emperor of the East and the West.
395	Death of Theodosius the Great. Honorius and Arkady again divide the empire, Stilihon and Alaric become their masters and protectors.
410	West Goths under the leadership of Alaric capture Rome.
425	Vandals settle in the south of Spain. Huns – in Pannonia, Ostrogoths – in Dalmatia. West Goths and Sueves – in Portugal and Northern Spain. Angles and Saxons invade Britain.
429	Vandals led by Heiserich invade Africa.
439	Vandals capture Carthage.
448	Prisk visits Attila.

451	Attila, who attacked Gaul, was defeated by the Franks, Germans and Romans in the Catalaun fields
453	Death of Attila.
455	Vandals loot Rome.
470	Invasion of the Ephthalites to India.
476	Odoakr, the king of the united Teutonic tribes, declares to Constantinople that the emperor in the West no longer exists. End of the Western Roman Empire.
480	Saint Benedict was born.
481	Clovis is the founder of the Frankish Kingdom. Merovingians.
483	The Nestorian church is separated from the Orthodox Christian church.
493	Theodoric, the king of the Ostrogoths, conquers Italy and becomes her king, but nominally he submits to Constantinople. (Gothic kings in Italy).
527	Justinian becomes emperor.
528	Mihirakula, Ephthalitic Attila of India is defeated.
529	Justinian closes schools in Athens, which flourished for about a thousand years. Belisarius (commander of Justinian) captures Naples.
531	The beginning of the reign of Khosrow I.
543	The great plague epidemic in Constantinople.
544	St. Benedict died.
553	Justinian expels the Goths from Italy. Cassiodorus founded a monastery.
565	Justinian died. Lombards conquer much of northern Italy (leaving the Byzantine Empire Ravenna and Rome). The Turks defeat the Ephtalites in Western Turkestan.
570	The Prophet Muhammad was born.
579	Khosrov I died. Lombards rule in Italy.
590	In Rome, the plague rages. Gregory the Great (Gregory I) and the vision of St. Angel.
591	The beginning of Khaskovo's II reign.
610	The beginning of Heraclius' reign.
618	The beginning of the Tang dynasty in China.
619	Khosrov II captures Egypt, Jerusalem, Damascus. His armies are on the Hellespont.
622	Hijra.
623	The battle of Badr.
627	Irakli inflicts a great defeat to the Persians at Nineveh. Allies from Mecca besiege Medina. Taizong is the emperor of China.
628	Kawad II kills his father. Khosrov II, and becomes his heir. Muhammad sends letters to rulers all over the world.
629	Xuan-Tsang goes to India. Muhammad returns to Mecca.
632	Muhammad died. Abu Bekr – the first Caliph.
634	Omar is the second Caliph.
635	Taizong receives Nestorian missionaries.
636	The battle on the banks of Yarmuk. Muslims seize Syria.
637	Battle of Cadiz.
638	Jerusalem surrenders to Omar.
641	Heraclius died.
644	Osman is the third Caliph.
645	Xuan-Zang returns to Xian.
655	The defeat of the Byzantine fleet by Muslims.

656	Osman is killed in Medina.
661	Ali is killed. Muawiya is the first Caliph of the Umayyad clan.
668	The Caliph of Muavia attacks Constantinople from the sea. Theodore of Tarsus is the Archbishop of Canterbury.
675	The last naval attack of Muavia at Constantinople.
687	Majordom Pippin Geristalsky reunites Austrazia and Neustria.
711	Muslim invasion of Spain from Africa.
715	Karl Martell is a majordom.
716-717	Suleiman, the son and heir of Walid, could not take Constantinople. Culmination of the Umayyad rule.
721	The possessions of the Caliph Walid I expand from the Pyrenees to China.
732	Karl Martell defeats the Muslims at Poitiers.
735	Death of Bedda of the Venerable.
743	Walid II – "unbelieving" Caliph.
749	The overthrow of the Umayyads. Aboul El Abbas is the first Abbasid caliph. Spain remains Umayyadian. The beginning of the collapse of the Arab Empire.
751	Pepin is crowned king of the francs.
755	The martyrdom of St. Boniface.
768	Pepin died.
771	Charlemagne is the sole ruler.
774	Charlemagne conquers Lombardy.
776	Charlemagne in Dalmatia.
786	Haroun al-Rashid is the Abbasid caliph in Baghdad (until 809).
795	Leo III – Roman Pope (until 816).
800	Leo III crowns Charlemagne as the emperor of the West.
802	Egbert, a former English refugee at the court of Charlemagne, proclaims himself the king of Wessex.
811	Bulgarian prince Krum defeats the troops of the emperor Nicephorus and kills him.
814	Charlemagne died; Ludovik the Pious inherits him.
828	Egbert becomes king of England.
843	Louis the Pious died, prtition of the Carolingian Empire. Until 962 there is no permanent inheritance in the Holy Roman Empire, although the title is preserved.
852	Boris is the first Christian prince of Bulgaria.
862	Around this year, Norman Rurik became the ruler of Novgorod
866	The Norman and Russian fleet threatens Constantinople.
886	Treaty of Alfred of England and Gutrum of Denmark on the settlements of the Danes on the lands of "Danish law".
907	The Russian-Norman fleet leaves Constantinople.
911	Norman Chief Rollon settles in Normandy.
919	Henry Ptitselov was elected King of Germany.
928	Marocia captives Pope John X.
931	John XI – the Pope (until 936).
936	Otgon I inherits his father Henry Ptitselov on the throne of Germany
941	The Russian fleet again threatens Constantinople.
955	John XII – The Pope.
960	Northern Song begins to rule in China

962	Otgon I, the King of Germany, was crowned by John XII for the emperor. (The Beginning of the Saxon Dynasty).
963	Otgon I dismisses John XII.
969	An independent Egyptian Caliphate is founded in Egypt.
973	Otgon II
983	Otgon III.
987	Hugo Capet is the King of France. End of the Carolingian dynasty in France
1016	Canute is king of England, Denmark and Norway.
1037	Avicenna (Ibn Sina) from Bukhara, the "king of healers", died.
1043	The Russian fleet threatens Constantinople.
1066	The conquest of England by William, the Duke of Normandy.
1071	Revival of Islam under the Seljuk Turks
1073	Hildebrand becomes Pope George VII (before 1085).
1077	Repentance of Henry IV.
1079	Peter Abelar was born.
1082	Robert Guiscard took Durazzo.
1084	Robert Guiscard plundered Rome.
1088-1099	Urban II – the Pope.
1094	Plague.
1096	Urban II in Clermont initiates the First Crusade.
1096	The catastrophe of the "People's Campaign".
1099	Gottfried of Bouillon captures Jerusalem. Paskhalii II – Pope (until 1118).
1138	The heyday of the Jin Empire. The Song Dynasty capital moves from Nanjing to Hangzhou.
1142	Peter Abelard died.
1147	The Second Crusade. Foundation of the Christian Kingdom of Portugal.
1169	Saladin is the Sultan of Egypt
1177	Emperor Frederick Barbarossa recognizes the supremacy of the Pope (Alexander III) in Venice
1187	Saladin took Jerusalem
1189	The Third Crusade.
1193	Albert the Great was born.
1198	The Arab philosopher Averroes of Cordoba (Ibn Rushd) died. Innocent III – the Pope until 1216; Friedrich II, four-year-old king of Sicily, under the tutelage of the Pope.
1202	The fourth crusade deals a blow to the Byzantine Empire.
1204	Constantinople was captured by the Latins.
1206	Qutb establishes an Islamic state in Delhi.
1212	The crusade of children.
1214	Genghis Khan takes over Peking.
1215	The Magna Carta is signed.
1216	Honorius III the Pope
1218	Genghis Khan invades Khorezm.
1221	The failure and the return of the Fifth Crusade. St. Dominic (founder of the Order of Dominicans) died.
1225	Thomas Aquinas was born.
1226	St. Francis of Assisi (founder of the Order of the Franciscans) died.
1227	Genghis Khan, who ruled from the Caspian to the Pacific, died; Ogedei inherits him. Gregory IX – The Pope.

1228	Frederick II begins the Sixth Crusade and receives Jerusalem from the Sultan.
1234	The Mongols are completing the conquest of the Jin Empire with the support of the Song Empire.
1239	Friedrich II is excommunicated for the second time.
1240	The Mongols are destroying Kiev. Russia begins to pay tribute to the Mongols
1241	The victory of the Mongols under Legnica in Silesia.
1244	The Egyptian Sultan regains Jerusalem, which leads to the Seventh Crusade (1248).
1245	Frederick II is again excommunicated.
1248	Residents of the Schwyz Valley burned the castle of New Habsburg.
1250	The French king, Louis the Saint, was redeemed from captivity. Friedrich II died, the last emperor of the Hohenstaufen dynasty. Interregnum in Germany until 1273.
1251	Mongke is the Great Khan. Khubilai Khan rules in China.
1258	Khan Khulagu captures and destroys Baghdad.
1260	Khubilai is the Great Khan. Ketboga is defeated in Palestine.
1261	The Greeks regain Constantinople after the Latin rule.
1265	Dante Alighieri was born.
1266	Giotto was born.
1269	Great Khan Khubilai sends a message to the Pope through older Polos.
1271	The beginning of the journey of Marco Polo.
1273	Rudolf Habsburg is the emperor. "Eternal Union" of the Swiss.
1274	Thomas Aquinas died.
1280	Khubilai founded the Yuan dynasty in China. Albert the Great died.
1292	Khubilai Khan died.
1293	Roger Bacon died, the forerunner of experimental science.
1294	Boniface VIII the Pope until 1303
1295	Marco Polo returns to Venice.
1303	The death of Pope Boniface VIII after the attack in Anagni.
1304	Petrarch was born. Clement V is the Pope.
1308	Duna Scott died.
1309	The Beginning of the Avignon Captivity of the Popes
1318	Four Franciscans are burned on charges of heresy in Marseilles.
1337	Giotto died.
1347	Ockham died.
1348	The Great Plague.
1358	Jacquerie in France
1368	The fall of the Mongolian dynasty of Yuan in China, which is replaced by the Ming Dynasty (until 1644)?
1369	Tamerlane takes the title of Great Khan.
1374	Petrarch died.
1377	Pope Gregory XI returns to Rome.
1378	"The Great Schism." Urban VI – Pope in Rome, Clement VII – in Avignon.
1381	Peasant uprising in England. Watt Tyler was killed in the presence of King Richard II.
1384	Wycliffe died.
1387	Fra Angelico was born.
1398	The preaching of Wikliphist ideas in Prague by Jan Hus.
1400	Chaucer died.

1405	Death of Tamerlane.
1414-1418	Council in Constanta. Jan Hus was burned (1415).
1417	The end of the "Great Schism", Martin V – the Pope.
1420	The Hussite insurrection. Martin V convokes a crusade against the Hussites.
1431	Crusaders flee before the Hussites at Domazlice. Basel Council. Villon and Mantegna were born.
1436	The Hussites make an agreement with the Church.
1439	Basel Council triggers a new church schism
1445	The discovery of Cape Verde by the Portuguese.
1446	The first printed book (Bonfire in Haarlem).
1449	The end of the Basel Council.
1452	Leonardo da Vinci was born.
1453	The Ottoman Turks under the leadership of Muhammad II took over Constantinople.
1471	Durer was born.
1473	Copernicus was born.
1480	Ivan III, Grand Duke of Moscow, overthrows the Mongol yoke.
1481	The death of Sultan Muhammad II while preparing for the conquest of Italy. Bayazid II – the Sultan (until 1512).
1487	Dias rounded the Cape of Good Hope.
1492	Columbus crossed the Atlantic and reached America. Rodrigo Borgia – Pope Alexander VI (until 1503).
1493	Maximilian I is the emperor.
1498	Vasco da Gama, rounds Africa, sails to India.
1499	Switzerland is an independent republic.
1500	Charles V was born.
1509	Henry VIII is the King of England.
1512	Selim – Sultan (until 1520); he appropriates the title of caliph. The fall of Soderini and Machiavelli in Florence.
1513	Leo X the Pope.
1515	Francis I is the King of France.
1517	Selim annexes Egypt. Luther announces his theses in Wittenberg.
1519	Leonardo da Vinci died. The beginning of the round-the-world expedition of Magellan. Cortez enters Mexico City.
1520	Suleiman the Magnificent – Sultan until 1566, ruling from Baghdad to Hungary. Charles V is the emperor.
1521	Luther at the Reichstag in Worms. Loyola was wounded near Pamplona.
1525	Babur wins the battle of Panipat, captures Delhi and establishes the Mughal empire.
1527	The German troops in Italy, under the command of the constable of Bourbon, seize and plunder Rome.
1528	Paolo Veronese was born.
1529	Suleiman is besieging Vienna.
1530	Pizarro invades Peru. Charles V, crowned by Pope Clement VII, begins a quarrel with the papacy.
1532	The Anabaptists capture Münster.
1535	The fall of Anabaptist rule in Munster.
1539	The society of Jesus was founded.
1545	The Council of Trent (until 1563) was convened to bring order to the Church.

1546	Martin Luther died.
1547	Ivan IV the Terrible takes the title of Tsar of Russia. Francis I died.
1549	The first Jesuit missions arrive in South America.
1552	Treaty of Passau. Temporary reconciliation in Germany.
1556	Charles V leaves the throne. Akbar – The Great Mogul (until 1605). Ignatius Loyola died.
1558	Charles V died
1561	Francis Bacon was born.
1563	Completion of the reform of the Catholic Church by the Council of Trent.
1564	Shakespeare was born.
1566	Died Suleiman the Magnificent.
1567	Revolution in the Netherlands.
1568	Execution of the counts of Egmont and Horn.
1573	The Siege of Alkmaar.
1583	Expedition of Sir Walter Raleigh to Virginia.
1603	Jacob I – King of England and Scotland. Jahangir is the Great Mogul. The Virgin Company is founded.
1609	Independence of Holland.
1618	Beginning of the Thirty Years' War
1620	The expedition from Mayflower founded New Plymouth. The first Negro slaves in Jamestown, Virginia.
1625	Charles I is the King of England.
1626	Sir Francis Bacon died, Lord Verulamsky.
1627	Shah Jahan is the Great Mogul. English petition on the law.
1629	Since this year, Charles I the English, rules for eleven years without convening a parliament.
1632	Leuvenook was born. Swedish King Gustav Adolf was killed in the Battle of Lutzen.
1634	Murder of Wallenstein
1638	Japan closes from the Europeans until 1865.
1640	Charles I convenes the Long Parliament.
1641	The British start massacre in Ireland.
1643	Louis XIV begins his seventy-two-year reign.
1644	Manchurs replace the Ming dynasty.
1648	The Westphalia world; on it the Netherlands and Switzerland are recognized as free republics; the influence of Prussia is growing. The war of the Fronde ends in the complete victory of the French Crown.
1649	Execution of Charles I of England.
1658	Aurangzeb is the Great Mogul. Cromwell died.
1660	Charles II the king of England
1674	New Amsterdam finally passes to the British and is renamed to New York.
1683	The last Turkish attack on Vienna was repulsed by King Jan III of Poland.
1688	Coup in Britain. The flight of James II. The beginning of the reign of Wilhelm and Mary.
1689	Peter the Great the Tsar of Russia (until 1725).
1690	War in Ireland
1701	Frederick I is the first king of Prussia
1707	Death of Aurangzeb. The empire of the Great Moguls disintegrates.
1713	Frederick the Great of Prussia was born.
1733	Oglethorpe founded the colony of Georgia

1736	The invasion of Nadir Shah in India. The beginning of the twenty-year raids and disorder in India
1740	Ascent of Frederick the Great, King of Prussia. Maria Theresa begins to reign in Austria. As a woman, she can not be an empress. Her husband Franz I – the emperor from 1745 to 1765, when he is succeeded by his son Joseph I.
1741	Empress Elizabeth of Russia starts reigning
1755-1763	Wars between Britain and France in America and India. France – in alliance with Austria and Russia against Prussia and Britain; Seven Years' War.
1757	The battle of Plessis.
1759	British general Wolff conquers Quebec.
1760	George III is the King of Britain.
1762	The Empress of Russia Elizabeth died. The murder of Tsar Peter III and the ascent to the throne of Catherine the Great (reigns until 1796).
1763	The Paris Peace Treaty; Canada's transition to Britain. British supremacy in India.
1764	Battle of Buxar.
1766	Malthus was born.
1769	Napoleon Bonaparte is born
1774	The beginning of the reign of Louis XVI. Suicide of Clive.
1775	Beginning of the War of Independence in North America. Battle of Lexington. Turner was born.
1776	Declaration of Independence of the United States.
1780	End of the reign of Maria Theresa. Emperor Joseph inherits the possessions of the Habsburgs.
1783	Peace treaty between Britain and the United States.
1787	Constitutional Convention in Philadelphia establishes the federal government of the United States. France faces bankruptcy; collection of notables.
1788	The first federal congress of the United States in New York.
1789	General states in France. Storming the Bastille.
1791	Unsuccessful attempt of the royal family to escape. The Jacobin Revolution.
1792	France declares war on Austria. Prussia declares war on France. Battle of Valmy. France is proclaimed a republic.
1793	Louis XVI is beheaded.
1794	The execution of Robespierre and the end of the Jacobin Republic. The rule of the Convention.
1795	Directory. Bonaparte suppresses the mutiny and enters Italy as the head of the troops.
1797	Under the conditions of the Campo-formian treaty, Bonaparte destroys the Venetian Republic.
1798	Bonaparte arrives in Egypt. Battle at the Nile delta.
1799	Return of Bonaparte. He becomes the first consul with unlimited powers.
1800	Napoleon campaign against Austria. The battle of Marengo in Italy and Hohenlinden (Moro's victory).
1801	The Parliamentary Union of Ireland and England comes into force on January 1, 1801. A truce between France, England and Austria.
1803	Bonaparte occupies Switzerland, which makes the war inevitable.

1804	Bonaparte becomes emperor. Francis II takes the title of Emperor of Austria and in 1806 renounces the title of Emperor of the Holy Roman Empire, the end of her story.
1805	The Battle of Trafalgar. Battles at Ulm and Austerlitz.
1806	The defeat of the Prussian army at Jena.
1807	Battles at Eylau and Friedland; Tilsit Peace.
1808	Napoleon makes his brother Joseph king of Spain.
1810	Latin America begins the struggle for independence.
1811	The refusal of Alexander I from the continental blockade.
1812	Napoleon's retreat from Moscow.
1814	The abdication of Napoleon. Louis XVIII – the King.
1815	The Battle of Waterloo. The Congress of Vienna.
1819	The first factory act was adopted thanks to the efforts of Robert Owen.
1821	The uprising in Greece.
1824	Charles X is the King of France.
1825	Nicholas I is the Russian Tsar. The world's first railway between Stockton and Darlington (England).
1827	The Battle in Navarinskaya Bay.
1829	Independence of Greece.
1830	Year of revolutionary anxiety. Louis Philip took the place of Charles X. Belgium breaks from Holland. Leopold Saxe-Coburg-Gothic becomes the king of this new country. Ineffective Polish uprising in Russia.
1832	The first Bill of Reform in Britain restores the democratic character of the British Parliament.
1835	The word "socialism" is used for the first time.
1837	Queen Victoria.
1840	Queen Victoria is married to Duke Albert Sak-sen-Coburg-Gotha.
1848	Another year of revolutions. Republicans come to power in France and Rome. Pan-Slavic Conference in Prague. The whole of Germany is united by the Frankfurt Parliament. The King of Prussia destroys the unity of Germany.
1851	World Exhibition in London.
1852	Napoleon III is the emperor of France.
1854	The second expedition. Perry landed in Japan. Nicholas I occupies the Danube provinces of Turkey
1853-1856	The Crimean War.
1855	Alexander II – the Tsar of Russia.
1857	Indian uprising.
1859	The Franco-Austrian War. The battles of Magenta and Solferino
1861	Victor Emmanuel is the first king of Italy. Abraham Lincoln is the president of the United States. The beginning of the Civil War in America.
1863	The British are shelling the Japanese city.
1864	Maximilian – Emperor of Mexico
1865	Capitulation of Southerners in Appomattox. Japan opens itself to the world.
1866	Prussia and Italy are attacking Austria (it is in the union of the South German states). The Battle of Sadova
1867	The Emperor Maximilian was shot.
1870	Napoleon III declares war on Prussia.
1871	Defeat of France (January). The King of Prussia becomes emperor of Germany Wilhelm. The Frankfurt Peace Treaty.

1875	Turkish atrocities in Bulgaria.
1877-1878	Russian-Turkish war. The San Stefan world. Queen Victoria becomes empress of India.
1878	Berlin Congress. The beginning of the thirty-six-year-long "armed peace" in Europe.
1881	The Battle of Majuba Hill. The Free Republic of the Transvaal.
1882	Charles Darwin died.
1883	British occupation of Egypt. Karl Marx died.
1886	The first bill on Irish self-government Gladstone
1888	Friedrich III (March), Wilhelm II (June) – the emperors of Germany
1890	Bismarck's resignation. The island of Helgoland is ceded to Germany.
1894-1895	Japan-China War.
1895	The "Unionist" (imperialist) government in Britain.
1896	The Battle of Adua.
1898	Conflict between England and France because of Fashoda. Germany acquires Qingdao.
1899	The beginning of the Boer War.
1900	The uprising of the "boxers" in China.
1904	Britain invades Tibet.
1904-1905	Japan-China War.
1906	The imperialist party in the British parliament was "defeated" by the liberals on the issue of tariff policy.
1907	The formation of the South African Union.
1908	Austria annexes Bosnia and Herzegovina
1909	M. Brélio flies on an airplane from France to England.
1911	Italy unleashes a war with Turkey and captures Tripoli.
1912	China becomes a republic. The Balkan Union begins a war with Turkey.
1913	The bloodshed in Londonderry in Ireland, caused by the illegal supply of arms by "Unionists".
1914	The beginning of the world war in Europe.
1917	Two revolutions in Russia. Establishment of the Bolshevik regime.
1918	The truce (November).
1919-1920	Versailles Peace Treaty. Paris Peace Conference.
1919	The British leave Arkhangelsk. Denikin is defeated. Yudenich almost captures Petrograd and is defeated. The German fleet is sunk by German officers instead of being handed over to the British.
1920	First Congress of the League of Nations; Germany, Austria, Russia and Turkey are excluded. The United States does not send a representative. Kolchak is defeated by the Bolsheviks and shot. Poland is attacking Russia; the offensive of Wrangel in the south is stopped.
1921	Constantinople under the control of the Allies. The Conference on Naval Disarmament in Washington, chaired by President Harding.
1922	Great famine in Russia. At the Congress of the League of Nations in Geneva, there are Germans and Russians. The growing mess in Germany's finances and the impossibility of paying a military debt. Defeat of the Greek military in Asia Minor. Separation of Southern Ireland from Great Britain.
1923	French occupation of the Ruhr area and currency crash in Germany. The introduction of a rentmark. The UK is restoring the pre-war gold standard.

1924	The first Labor government in Britain. It is replaced by a conservative government after the general elections in November. Lenin died. In Italy, the fascists are killing the liberal Italian writer Matteotti. Dawes Plan to mitigate the debt burden of Germany.
1925	The French are attacked by the forces of Abdal-Krim in Morocco and the Druze in Syria. Reichsmark in Germany. The pact in Locarno. Reza-khan dismisses the Shah of Persia and later becomes the shah himself.
1926	The French franc falls to the value of one penny, but is then stabilized by the new anti-crisis coalition government. Fall of Abd al-Krim.
1927	The British government makes a raid on Russian business offices in London and breaks diplomatic relations with Russia. The failure of the conference on disarmament in Geneva.
1928	Kellogg, the Secretary of State in the government of President Coolidge, proposes a system of treaties by which all great powers refuse war. The military industry remains untouched. The development of military equipment and the development of gas and bacteriological weapons continue. The beginning of the five-year plan in Russia
1929	The second Labor government in Britain by the results of general elections. The resumption of relations between Britain and Russia. Hoover is the president of the United States. Ubiquitous fall in prices and rising unemployment. Jung's plan to mitigate German military debts.
1930	The conference on naval disarmament in London with trivial results. The new frightening fascist party appears in the German Reichstag under the leadership of an Austrian named Hitler
1931	Spain becomes a republic (April). Economic instability in Germany is growing, and President Hoover offers an year suspension in the payment of reparations. This is followed by the financial crisis in Britain. The Labor government gives way to the "national" government, which pledged to support the gold standard, which later is rejected. MacDonald, a former leader of the Labor Party, retains the post of prime minister, skillfully skirting all political whirlpools.
1932	Geneva Conference on Disarmament.
1933	The law on additional powers in Germany – Adolf Hitler, the law against the formation of new parties, the ban of all parties except Nazi. In the US, Roosevelt's new course (the restoration of the national economy and improvement in agriculture). The Roman Pact.
1934	A number of laws adopted in Germany within the framework of state (imperial) reorganization, "the night of long knives". Paul von Hindenburg died. Oath of the military to A. Hitler, the combination of the posts of the president and the Chancellor – the Fuhrer
1935	In the US, Wagner's law (New Deal of F. Roosevelt).
1936	Military mutiny led by Francisco Franco (slogan – the protection of religion and traditional values). The Civil War in Spain. The Convention in Montreux – Turkey got the straits of the Bosphorus and the Dardanelles.
1937	The Brunet operation in Spain. Brussels Conference.
1938	German troops enter Austria. Battle of the Ebro River in Spain. The troops of Franco stopped the offensive on Valencia. France calls for reservists. The Germans break off relations with Czechoslovakia. Conference in Munich – an agreement on the issue of the German military occupation. Chamberlain carries to London "honorable peace."
1939	In Spain, nationalists capture Madrid (the Madrid battle), the end of the civil war. Meeting of representatives of the USSR, Britain and France –

	Moscow negotiations. The signing of the non-aggression pact and the secret protocol. German troops invade Poland (it is considered to be the beginning of World War II). Britain and France declare war on Germany (without receiving an answer to an ultimatum in connection with the attack on Poland). New Zealand and Australia declare war on Germany. From this time until 10.05.1940 – "Strange War". Soviet troops occupied the east of Poland (western Ukraine and Belarus).
1940	Directive No. 17 of Hitler on the expansion of the air war against England. The battle for England.
1941	Winston Churchill's speech on the Battle of the Atlantic. Moscow Conference of the heads of the USSR, USA, England. The US provides a loan to the USSR in 1942, 1 billion dollars.
1942	The breakthrough of German ships across the English Channel. The beginning of the Soviet counteroffensive near Stalingrad.
1943	Moscow Conference of Foreign Ministers of the USSR, the USA and England (Moscow meeting of 1943). Cairo – Conference of Heads of Government of the United States, Britain and China (Cairo Conference). Tehran Conference – USSR, USA, England
1944	Odessa operation of troops of the 3rd Ukrainian Front. Landing of Allied forces in Normandy. The second front is opened. The Overlord plan. The Warsaw Uprising is an armed offensive by the Poles against the German occupation, without the assistance of the USSR and the West, and further the fighting of the troops of the First Byelorussian Front in the Warsaw area.
1945	The offensive along all the entire front with Germany – the operation of the 1st Byelorussian and 1st Ukrainian fronts between the Vistula and the Oder. The Crimean Conference of the heads of the USSR, USA and England. Upper Silesian operation of the 1st Ukrainian Front troops. The Vienna Offensive Operation of the 2nd and 3rd Ukrainian Fronts for the Occupation of Vienna. Okinawa operation of the US Armed Forces to seize the Japanese island. Okinawa. The Prague operation of the 1st, 4th and 2nd Ukrainian fronts. Potsdam conference in Germany with the participation of Stalin, Truman, Churchill and Attlee (territorial issues for Austria and Poland). Hiroshima. Manchurian offensive operation of the Soviet Armed Forces against the armed forces of Japan. The act of surrender of Japan on the battleship "Missouri" (the end of World War II). The Moscow Conference (USSR, USA, Great Britain) in 1945 – peace treaties with Italy, Romania, Bulgaria, Hungary and Finland.
1946	The 1-st session of the UN General Assembly. Churchill's speech on the "iron curtain" of Stalin and the accusation of "unlimited expansion of his power and his ideas" (as a signal to the beginning of the "cold war").
1947	The program, voiced by George Marshall on the restoration and development of Europe by providing her with US economic assistance (Marshall Plan).
1948	Establishment of the Organization of European Economic Cooperation (OEEC) in Paris. Moscow talks – the USSR, USA, Great Britain and France on the elimination of the "Berlin crisis".
1949	TASS report on the testing of the atomic bomb in the USSR. The military tribunal in Khabarovsk over the Japanese generals – the Khabarovsk trial.
1950	Completion of the "Leningrad case" against a group of party leaders who entered the big Soviet policy from Leningrad from Kuibyshev circle. Death sentence to AA. Kuznetsov and others.

1952	F. Batista arranges a coup d'état in Cuba. The Bonn Treaty (separate) between the United States, Great Britain and France on the one hand and the FRG on the other. Completion of the case of the Jewish Antifascist Committee initiated in 1948 by sentencing the leaders.
1953	Plenum of the Central Committee of the CPSU. Election of the secretariat. G.M. Malenkov left the post of secretary, V. Molotov and L. Beria remain deputies. Rise of S. Khrushchev. The Presidium of the Council of Ministers of the USSR- Beria suggests limiting to keeping the territory of East Germany under the Soviet military control without building socialism. The uprising against the communist government in East Germany. An emergency situation declared by the Soviet military commandant of Berlin, the suppression of the uprising by the Soviet troops. Minister of Internal Affairs Beria is arrested (for attempted seizure of power he is shot). Fidel Castro makes an attempt to overthrow the government of Batista – attacks on the Moncada barracks (Castro is arrested, in 1955 after an amnesty he is sent to Mexico).
1954	Berlin – a meeting (the ministers of foreign affairs of the United States, the USSR, Britain and France) on the relaxation of international tension. In the USA – the announcement of a successful hydrogen bomb test on the Marshall Islands. Great concern caused by the explosion and radioactive fallout all over the world. North Vietnam – the surrounded French units surrender. In Peking, the first National People's Congress adopted the constitution of the People's Republic of China. Mao-Zedong is elected chairman. The United States, Great Britain, France and the USSR agree to ending the occupation of Germany. West- European Union.
1955	The Warsaw Treaty on Friendship, Cooperation and Mutual Assistance between the USSR, Albania, Bulgaria, Czechoslovakia, Eastern Germany, Hungary, Poland and Romania.
1956	Hungary leaves the Warsaw Pact countries, it appeals to the UN for help against the invasion of Soviet troops.
1957	The USSR – the world's first artificial Earth satellite.
1960	The year of Africa – the formation of 17 independent states within the year. The reconnaissance aircraft of Harry Powers over the Urals.
1961	The first space flight of Yuri Gagarin on "Vostok" -1. The landing in Cuba of 1500 Cuban exiles, trained by the US military – the population does not support the invasion. The US provides direct military support to South Korea in the fight against the partisans.
1962	The "Caribbean crisis".
1963	The United States, the USSR and Great Britain sign the Treaty on the Prohibition of Nuclear Weapon Tests (96 countries have joined, France refuses).
1964	North Vietnam attacks the US destroyer "Maddox"; in response, a bomb attack is fired at the naval bases of northern Vietnam. Night session of the Plenum of the Central Committee. L.I. Brezhnev takes the duties of First Secretary of the Central Committee of the CPSU, Khrushchev is dismissed from the government of the country
1965	The US troops invasion of the Dominican Republic.
1966	The US bombed the capital of North Vietnam Hanoi for the first time.
1967	The treaty on outer space, signed by the USSR, the United States and Great Britain. The outbreak of hostilities between Israel and a number of Arab states. Six-day war. The UN Security Council adopts Resolution 242

	demanding the withdrawal of Israeli troops from the occupied Arab territories.
1968	Murder of Martin Luther King in the United States. Barricades in Paris, a clash of students with the police. The workers join them. The Treaty on the Non-Proliferation of Nuclear Weapons is signed by 61 states, including the United Kingdom, the United States and the USSR. Czechoslovakia is occupied by the troops of the USSR, the GDR, Poland, Hungary, Bulgaria.
1969	The military conflict between the USSR and the PRC in the vicinity of Damansky Island. The first flight to the Moon of American astronauts. John Lennon returns the Order of the British Empire to the British Government
1970	Presidential elections in Chile – Salvador Allende. The crisis in Poland – the clash of demonstrators with the troops, Gomulka resigned.
1971	The signing of the Seabed Treaty (prohibition of the placement of nuclear weapons in its depths, etc.). The United States, Great Britain, France and the USSR sign an agreement on the relationship between West Berlin and West Germany.
1972	The USSR and the US sign an agreement on the limitation of anti-ballistic missile systems.
1973	Helsinki meeting on security.
1974	Nixon's visit to Moscow. The Treaty on the Limitation of Underground Nuclear Tests.
1975	The operation for liberation in Vietnam. The Final Act of the CSCE in Helsinki. Francisco Franco, the dictator of Spain, died.
1976	The United States and the USSR Treaty on the prohibition of nuclear explosions of more than 150 kg.
1977	The President of Egypt, Anwar Sadat, paid a visit to Israel.
1978	The monarchy is overthrown in Afganistan. Pope John Paul II. Peace and Friendship Treaty between China and Japan. Talks at Camp David between Egypt and Israel and the United States.
1979	Vietnamese troops took Pnompen. Chinese troops invaded Vietnam. The first elections to the European Parliament. The overthrow of dictator Samos in Nicaragua. The head of state in Afghanistan is dismissed. The emperor of the CAR is dismissed, and the republic is proclaimed by the parachutists. The military block CENTO is disbanded. The president of South Korea and the dismissed head of Afghanistan are killed.
1980	Attempted coup in Thailand.
1981	Martial law in Poland (Wojciech Jaruzelski).
1982	Falkland's military conflict. LI Brezhnev died. Yu.V. Andropov is elected.
1985	The death of K. Chernenko. M.S. Gorbachev is First Secretary. The first meeting between Reagan and Gorbachev
1986	Chernobyl. The radiation increase in Sweden, Denmark, Finland.
1987	The beginning of the construction of the tunnel under the English Channel between England and France.
1988	The withdrawal of Soviet troops from Afghanistan. Benazir Bhutto – prime minister of Pakistan. Recognition of the right to existence of the State of Israel by Yasser Arafat.
1989	M. Gorbachev meets with Pope John Paul II in the Vatican.
1990	The UN resolution on the imposition of a trade embargo against Iraq and then on the use of force against Iraq. Margaret Thatcher's resignation. Meeting under the English Channel.

1991	Operation “The storm in the Desert” – American troops with the allies against Iraq. Iraq drains oil reserves into the Persian Gulf, sets its oil wells on fire. Land Operation in Iraq. The Warsaw Pact is disbanded. Soviet troops are withdrawn from Hungary and Czechoslovakia. Bush and Gorbachev sign an agreement on strategic arms reduction, which reduces the number of missiles by 1/3. State Emergency Committee in Moscow. Belovezhsky agreements on the elimination of the USSR and the establishment of the UIS.
1993	Czechoslovakia is finally divided into two countries. Bush and Yeltsin sign the treaty on the reduction of strategic weapons of nuclear warheads by 2/3. The shell of the Supreme Soviet House by the Government tanks. Gustav Husak, the head of Czechoslovakia, died.
1994	The troops of the Russian Federation began military actions on the territory of the Chechen Republic.
1996	The signing of an agreement in Khasavyurt on ending the war in Chechnya.
1999	NATO aircraft made the first raid on Yugoslavia. The NATO charter is violated.
2001	Start up of Wikipedia. The biggest terrorist act in the United States. The beginning of the war in Afghanistan.
2002	The start of circulation of Euro banknotes and coins in the European Union. East Timor gained independence from Indonesia.
2003	Catastrophe of the shuttle Columbia. The beginning of the war in Iraq. The International Criminal Court starts its work. A series (until 2005) of bloodless color revolutions. Change of power in Georgia, Ukraine, Kyrgyzstan, Lebanon
2004	Mars-walker "Spirit" descended to Mars. Start of Facebook. Expansion of the European Union, inclusion of 10 new countries. "Orange" revolution in the Ukraine.
2006	The first in the 21st century a total solar eclipse in the territory of Russia. Montenegro gained independence and became the 192nd member of the UN.
2008	Kosovo declared independence from Serbia. The war in South Ossetia. The first African American is the US president.
2009	The end of the second Chechen war.
2011	Mass protests to overthrow the regime of Hosni Mubarak in Egypt. The unrest in North Africa and the Middle East. Fukushima. The beginning of the civil war in Syria. Murder of Muammar Gaddafi. , There are 7 billion people on the Earth.
2012	Putin is elected President of the Russian Federation for the third time. Barack Obama is president for the second time in the US. Debts of Greece. Conflict in Syria. Floods in Krymsk.
2013	Meteorite – in the Urals. Evroimaydan – in the Ukraine.
2014	The Crimea joins the Russian Federation. An armed conflict in the east of the Ukraine.
2015	The beginning of Russia's military operation in Syria.
2016	Presidential elections in the USA. IGIL. Syria. The Ukraine. Oil.
2017	Election of US President D. Trump. The St. Petersburg International Economic Forum gathered a record number of 14,000 participants, the main question: "How to save money and real estate that was exported abroad?" An unusually cold summer, a hurricane in Moscow, record heavy showers and snow. Change in the color of the Black Sea, the shallowing of

Venice canals, fires and drought in Europe. Syria: Russia-Turkey-Iran. Referendum in Catalonia, Veneto and Lombardy (Italy), Kurdistan (Iraq). The Valdai Club and V. Putin's speech. The XIX Congress of the Communist Party of China.

Content

Foreword	3
Acknowledgments	12
Prologue	15
Introduction	23
Chapter 1. The planetary level of secrecy, or "the operation of disclosure"	26
1.1. The Beginning.....	28
1.2. Before the "Capture"	33
1.3. Parasitic civilization – Ebrs.....	37
1.4. The Attack	39
1.5. Phaeton Catastrophe	44
1.6. Restructuring (for themselves)	45
1.7. A little about the Sun	52
1.8. The takeover of the planet of the Earth.....	56
1.9. Available Means	58
Chapter 2. "Spiders' Laboratory Experiments"	80
2.1. The first stage of the violent "Civilization" of the Earth	80
2.2. Attempts to create people	81
2.3. "The Second Civilization"	85
2.4. The third stage of the intervention	88
2.5. Preparation and the fourth stage of the violent intervention	91
2.6. Technical implementation of the Control.....	92
2.7. Formation of Consciousness	99
2.8. The development of the Brain genotypes of the alien Control System	103
Chapter 3. Fundamentals of the material world and the formation of the Brain genotypes	118
3.1. The basics	119
3.2. Object 440 (Variant of the Alpine Complex)	130
3.3. Cluster System of the Control	133
3.4. About the creation of the "Shirt", failure of Intruders and of the collateral.....	143
3.5. The concept of unscientific perception and Reincarnation	151
3.6. Sleep as karma control.....	159
3.7. Language as means of communication.	161
3.8. Blood, DNA and the lungs memory	162
Chapter 4. The basic functions of the atmosphere layers and the formation of people's consciousness	165
4.1. Consciousness as a factor	168
4.2. Functions of the Interventionist System Atmosphere layers....	170
4.3. Formation	172
4.4. The Abode of Gods.....	177
4.5. The root of the problem	186

4.6. Understanding	190
4.7. Variations	192
4.8. The approach	203
4.9. Biological sphere.....	209
Chapter 5. Deliberate knowledge of the unknown	211
5.1. Wanted Necessity	211
5.2. Tritium, the Bath and the unknown	215
5.3. Why do biostructures need water?.....	218
5.4. "Bright" future	224
5.5. The Essence	226
5.6. Specificity	230
5.7. Pyramidalitiy	234
5.8. The Control and Atmosphere layers No 2 and 3.....	237
5.9. Need for thought	246
5.10. Biomass	257
5.11. What to wait? How to perceive?	259
Chapter 6. About the creator of the "Bannoye delo"	264
6.1. This "unknown" Khatybov.....	266
6.2. So what is known about A.M. Khatybov?	271
6.3. The Personality, we cannot do without	279
6.4. Aspiration. And we will go on with Khatybov.....	284
6.5. Shlisselburg convict	311
6.6. Quintessence.....	321
Afterword	324
Appendix.....	330

F. Shkrudnev

N. Levashov's
«SvetL Broom»
in A. Khatybov's
«Bath School»

Book 1. Unmasking the Hidden

Life goes on...



Feodor Shkrudnev

Life goes on...

**N. Levashov's «SvetL Broom» in
A. Khatybov's «Bath School» and
A Labour Spade**

**The continuation of the third volume of the
monograph «The Mirror of My Soul» not
completed by Nicolai Levashov**

**BOOK 1. Unmasking the Hidden
(intervention: how it happened)**

Translated from Russian by Alla Khabenskaya

Saint-Petersburg 2017

Foreword

The modern system of man's views once firmly settled and for quite a number of hundred years being polished is clearly reflected in the scientific way of looking at things. They are well-grounded, fundamental, and steadfast in the truth of their position – In a word – "**SCIENCE**". It's like **something that is unattainable for anyone and everyone**. It is not like some intricate craft, which, although being difficult at times, can be mastered by anyone to some extent, and therefore, it is quite real to get the title of master. Science is the lot of quite a few. It is necessary not only to have weighty intellectual resources, moreover, extended in some area to unconceivable dimensions, making it possible for you to judge things more confidently than anyone else. You also have to be scientifically minded so that you are able to save your face in a worthy manner in the circle of your kind. Well, and if you make some effort – it will give you the opportunity from the considerable height of your highly scientific intellectual statements to judge about the possibilities and achievements of both less experienced and eminent 'bison' scientists, fatherly suggesting a way to a new essential scientific research so far being noticed by no one. Scientific activities that are so much desirable and hardly ever easily attainable and only to a few worthy ones turn out to be very close, but for the majority it proves to be a true revelation at the beginning – what an ample scope to creative work!

How much of under-explored and under-investigated has the modern scientific school offered! How much good could one do to it with one's work! Experienced scientists in a majority take young scientists in their ranks with such tangible kindness and care suggesting and directing them in so hard, but fascinating scientific search. Although somewhat has been modified in the political and economic battles, the scientific school has still preserved for the true scientists the opportunities for their development in the form of grants, which are distributed according to the most promising trends for the development of science in general and its application in the national economy. It is true, there are some discrepancies, temporary or local difficulties, but they are only bumps on the way of formation and development of Science presenting itself as a kind of a monster, created with only one aim – to lead the humanity away from even the possibility of

perception the real picture of the world, having created and imposed upon everyone a false world outlook based on invented myths, and having provided these inventors with a halo of indisputability and inaccessibility in their scientific greatness – that is for the layman; and inside this hard-to-reach scientific community – to organize exactly the same parasitic conditions, as outside it.

Every ordinary scientific worker of a higher educational institution, research institute or any other organization that is a part of the Scientific System can not fail to see all of its unstable, but for some reason still being supported structure. Each of its participants comes across it and tries to exist somehow, or even to prosper, but in everyday hustle and bustle not all realize what each of them is part of. The problems of survival are not complicated and make you to be in a whirl – publications, scientific studies, dissertations, author’s abstracts, Higher Certification Committee, citation indexes, scientific projects, reports, check ups, titles and degrees – all these attributes of the scientific life got together are a simple and effective tool to manipulate a person, even if he is really intellectually developed and has an extraordinary mind. It is trivial, isn’t it – but for something more than “drawing up”, there is simply not enough time, energy, or desire. Alas, but Science, on the one hand, is a well- thought out and well-made trap for capable, purposeful and intelligent people, besides, aiming at not giving a chance for real development to anyone. And on the other hand, it is a cushy job in which, providing you have certain qualities of thinking, you can live your life without exerting yourself too much with comfort and pleasure relying on lower-ranking scientists and on legal grounds to use the results of their work (the concept ‘a wedding general ’ is a common expression with them). In the community of research workers everything turns out to be meaningless in the most basic sense of the word. If you are interested in doing research in many fields simultaneously, you will easily be convinced that this is futile and you will be turned into a narrow specialist who knows in detail the number of mandibles in some arthropods, but you will never think of the fact why your favorite, fostered and personally described subspecies bearing your name, and including 19 differing in the number of denticles and having the shape of the bristle morphs, generally exists on the Earth, and why it exists in these 19 morphs. If you examined the work of the supervisor and fundamentally disagree with his point of view **you will have to say goodbye to the defense of the thesis**; an eternal title of an assistant and, in most cases, quite a trial in search of a new scientific leader – that is your destiny for many years. Suppose you go your own way and

thanks to your intelligence, talent and diligence are able to maintain your opinion and even to defend your thesis. That is perfect. But this is the end. Be happy with your degree, so much wished for, your salary and general admiration. You are a part of the system and there is no way out.

I apologize to a reader for such a lengthy introduction, but I thought it is necessary to some extent **to throw light upon the present day science from my point of view.**

We certainly enthusiastically study and investigate with sincere interest behavior of gophers, imitones in nightingales' singing, nutrition of musk deer, finding some pleasure and satisfaction in it, and creating some imitation of some usefulness to the society. But all this is a complete nonsense and utter rubbish. Believe me, most of the work is done under certain requirements to get some "bonus" in the form of money, titles (meaning money), some articles (meaning, titles and then money), grants (again meaning money), and for a change – for some ambition. Everything, as in any other field, rests on getting some material goods. It is quite different in case of already received benefits or available initially. Or – if the Person is engaged in something far from what is called science. **For example, if he is "Dilettante in science..."**

Any view on the surrounding reality without any bias is a challenge, it is a blow to the Brain, and it is an attempt to get it out of the state of sustainability. On the one hand when there is a person who is offered all kinds of opportunities: he is told how this or that works, he is given facts, he is persuaded and praised when he accepts the proposal. For the person who once adopted a certain point of view it is very difficult to change it. For this there must be some itch to it, some patience, firmness of purpose, and some stimulus, which will help to leave the comfortable perch and look around. Then a person might see some fragment of reality and realize that his Science teachers are wrong. He will never come back, and might choose some others. But on the other hand – when the Science teacher must be taken out of the stability, that is that source of "true" world outlook, **who knows** what is right and what is wrong, **the one** who imposes one's prejudice on everyone, and who, in fact, has been created and nurtured by the system. It amounts to a refusal to ride in a comfortable car, moving on a flat road to a bright future, heading a column of vehicles and pedestrians, or to go on foot to the mountains, where rapid river streams knock you down, and where falling pieces of rock from the slopes fall down on your head, and the danger of loosing your footing deprives you of your mind; and the strangeness of the

surroundings makes it impossible to take a breath. No one will accept it on one's own free will – the road is hard, there is no pleasure to move on it, and the most important is that situation that there is no reason to start on a journey. The choice of any reasonable person in this situation is obvious, and it leads to nowhere – after all, - that abandoned comfortable modern car moving on a flat, well-paved road, which after two turns comes abruptly to an end and then – just nothing.

But by some strange coincidence, which is probably going to be realized some day and translated into the plane of human perception – **suddenly there appears someone's hand**, opens the doors of the comfortable cars, ruthlessly pulls the passengers out and kicks them out of the habitual reality onto the mountain path. That is all, nowhere to go – you can sit on the rock and indulge in dreams about the old times, remember changing your Zhiguli for Toyota, with much less damages, but that very moment you open your eyes and everything around you looks uncomfortable, unfamiliar, strange, original and majestic in size.

Again I apologize to the readers for such a "non-scientific" comparison, but there are reasons for that. The phenomenon that a man comes across for the first time **after realizing the falseness of the world outlook presented by science and near-science** is impossible to denote by the usual figures of speech, but sooner or later, this emotional component passes, giving place to the observations, reflections and conclusions.

To have a look at the world in a new way, to see things previously unnoticed, to perceive the magnitude of the delusions, and to proceed working your will but not imposed by someone – **all this becomes possible with the Information**. Of course, it is easier to believe someone or something and, once having been defined, take your own position, defending its implacable justice, and loyalty. It gives you some sense of confidence and self-sufficiency up to the time, when new facts and the information having got from the outside will negate all earlier applied efforts. **Therefore, the most valuable and urgent, that facilitates the development, is Information, besides being reliable, but not planted on or fabricated**. It is all around us, but we must learn to see it and make the right conclusions. And it is not taught in any academic publications. However true and methodically correctly the textbook might be – whether it is written for philosophers or biologists, even with the most careful study, it will not teach you, because it has been created, like any other

recognized scientific or popular publication, in the framework of the System, and thus, strictly keeping to its mission to maintain a person's world view within the given framework, developing (or rather changing) in the permitted directions and create the illusion of some scientific progress.

Today's abundance of books of the works of different authors with the help of the World Wide Web, and not only, has been turned into the ocean of debris in which to find the needed is extremely difficult. After all, when looking for something everyone is guided by something prepared that will give one everything at once, besides, it should be comfortable and pleasant – in short, that "something" should duplicate that smooth way in a comfortable car, but it might be to the other side and with some other views along the way. **For this reason, all the books that really give a MAN an opportunity to develop oneself, and open the locked door a little bring about some rebuff, rejection, but at the same time attract people, make them criticize, indignant with the content, pull out some facts, that make a riot in the heads or, on the contrary, create euphoria.** All this is not very important in general; it is just a quest process, which, especially in the tense moments may cause outrageous emotions of various colors, and a sharp change in one's general state and twists and turns of fate. It is important that this break-up leads to the perception of the reality, although it affects everyone's imagination – both – in what way and why the Humanity has been formed and what awaits it in the future.

Of course, the authors of these books leave the reader with absolutely unbearable interest. It is an exorbitant phenomenon by the standards of any human being, and the more successful the reader is in the area of his application (for example, a successful scientist or a prominent politician), the greater his reaction might be, regardless of its color. This is a natural manifestation of reading books by such authors, who, without proving some higher Truth, just provide Information in the broadest sense of the word, and demonstrate the possibility to come to a reasonable and fair conclusion on the basis of its profound analysis. Such books are never published under the imprint of the Academy of Sciences, they do not get an overnight universal recognition and understanding, and their authors never strive for something of this kind. But their readers get something that **every true human being is eager to get – perception of the reality through the comprehension of the information** that everyone can learn to obtain in an authentic form, without distortion or imposed false views, convenient to

anyone. **N. V. Levashov, A. M. Khatybov, N.A. Morozov, B.V. Makov** are the authors of the books that can give everyone all this.

Feodor Dmitrievich Shkrudnev is the Man who will make you do it without giving you the chance to return and plunge into the swamp of the usual stereotypes, and again get back in your comfortable car speeding along a straight road to the cliff.

The Book created by Feodor Shkrudnev I have had a chance to become familiar with and which is now in your hands is, in the first instance, **A Challenge**, –a challenge both to everyone and to the System. While reading it your Brain is being in the state of non-stop intensive work. Everything in it causes some mental rebellion, makes you set out in some quest and pull you out of the quagmire of the habitual judgments. Everything **in It is “quite different’ from the expected.** Whatever you touch upon is going to be “wrong», not the way it is accepted, different from what you might expect from THE BOOK.

F. Shkrudnev’s work with quite a strange name – N. Levashov’s "SvetL Broom" in A. Khatybov’s "Bath School", which is marked by the author as the sequel of the third volume of "The Mirror of My Soul" by N. Levashov is more than a continuation of his autobiography. Certainly, to a number of points concerning the biography of N. Levashov is given some attention. But neither more nor less. They are not even digressions into the biography of N. Levashov to satisfy the curiosity of the reader. It is a description of certain factors that enable you to make a more complete judgment on things and objects that are more important than the personal life of the Outstanding Russian Scientist. It is more important to get to know some things about physics of the process of generation, about which little is said in A. Khatybov’s works and which some people have already got acquainted with firsthand while using "SvetL" Technology, than about the details of Nicholai Levashov’s family life and his attitude towards these or those people. It cannot be any other reasonable judgment on the question of what should be the whole book about; Everything that was necessary to put on paper about his life, N. Levashov did himself to forestall all possible strife in this matter: "I thought that if someone is interested in my life and my path no one but myself would be able to tell you what and when had happened in my life, what I had thought in certain situations and what I had felt and experienced... And as long as this is my life no one but me will do it better..."

Being aware of this, as well as having clear perception of what is indispensable to a human being for knowledge, and where just some banal

curiosity begins, determined the contents of the books by Feodor Shkrudnev. It could not be otherwise. But his chosen path and the style of presentation are limited from different sides – the publicity of the information presented is restrained with absolutely non-public details and fundamental discoveries. As far as generation is concerned the author has said a lot without saying anything that could give the appearance of knowledge. For biologists it will be important to read and learn about the real structure of a living cell, known to them from traditional scientific publications, but they will have to make sure, that scientific journals and their authors do not have the slightest idea either about the structure of a living cell, or about its capabilities. What you really get from reading the Book but what cannot touch is the information and an impressive push (as they say – "kick") to thinking it over.

The style of the text probably seems to be structured in a somewhat unusual logic. You may not find either some common logic or simplicity of exposition in this Book in that form which is accepted for the reputable and claiming to be fundamental publications. Everything is quite different here, and is likely to be similar to the DNA helix in that form in which it first appeared in the thoughts of its first observers. The most complicated design, with numerous interconnected and interdependent, **strictly verified and conceived by someone**, but at first glance, looking like a very incredible and intricate tangle of «don't know what". When you begin to look into, following the windings of the stated events and facts, you see strict helical structure, which invariably brings you back to the previously mentioned facts, making you see their connection with the others, and appreciate their place in the overall design much deeper. On the following turn the same, already "familiar" facts seem to be mentioned not quite casually, **but having their specific place** that is defined not by coincidence, but by previously unnoticed and misunderstood regularities. This kind of perception makes you reorganize the whole construction created in your head after reading – it is getting more complicated, acquiring some rigorous simplicity and significance.

I think any person related to some scientific activities in the modern sense of the word, cannot ignore the issue of involvement to the proceedings (both yours and others') literary sources. Indeed, with this we are all very strict – plagiarism is punishable and to rely on the works of predecessors is imperative. Failure to follow these scientific morals is fraught with very unpleasant consequences. There is no problem to find the sources of all mentioned, to keep to strict adherence to the authorship, to nurture your

own works, and to observe accuracy in the references to the works of colleagues and teachers. It is necessary to clearly track of what is whose, to avoid confusion, when all "this" is going to be transferred into tangible assets. The chain is not intricate – who came up with the idea, developed it, got under it (you need to substitute – the Department, a grant, place, job, an entire institution, rank, degree, position, honor, monograph, recognition, etc.) – that one is the owner, and no one should forget it – the ability to convert it into profits, as well as amuse your self-esteem and support absolutely essential in the scientific community ambitions must be maintained in the operable condition. The converse is also true – should you have published something obscene – that is something that brings about such a sober and fresh look at the existing ideas making the whole pyramid topple over – then references to this ugly creature mark an outcast, a renegade in his frenzy being carried too far – someone might say with a sigh, " Well, he did give some hope!.."

However, those works that are created with another purpose, those ideas that are born not in the frame of the old System, something that breaks down the Foundation, clearing up the place for the substantial construction of the mind in the direction of finding the truth, **do not even include such a notion as plagiarism.** Therefore, those for whom the very essence of this phenomenon is something Sacred may not move further as all most sacred shall be ruthlessly destroyed as not wanted. That is "the BROOM" for – to slash vigorously up to scratches on the "body", and the anguished cries of plagiarism just will not be understood or heard – the "**Bath School**" is too far from modern science and its postulates. Well, as far as the text of the Book is concerned – just try to ask such a question: How can you make the reader conceive what the Book say about otherwise? It is a rhetorical question – no matter the way you try but for the author to get the intended the only possible way is to involve what was said by one Man and what was written in this respect on another level of understanding by another Man, and what the third Man added to all this without decorating with so favorite references – and to present it to the reader as a single continuous whole in all its infinite capacity and the development of thought. And if the reader sees the point the desire to break the book with some acknowledgment does not appear – it will do such work in your head, that your own suffering Brain will begin to generate for itself quite unexpected things.

But to calm the requirements of morality of every reader, none of these People – the Authors of the texts, partly given in the Book, are hidden, on the contrary, their names become more significant than any record-largest

citation index after reading the Book. **But it is more than participation as an integral unit or a plurality of such units in the bibliographic list of the used literature.**

Whatever side is used to appreciate the result of Feodor Shkrudnev's Work it does not fit any accepted scientific or near-scientific standards that are being used when writing scientific or popular science books. All these, as well as any other formalized versions of various standardized approaches cannot be applied to such Work. Everything having created by the author, is beyond the existing so far and inevitably collapsing now the System realities, it teaches us to think independently, provides Information that is above any price, and makes you discard all that was imposed upon the Man with the upbringing, education and experience distorted with the false life values. Do not You think now that this Work with such a strange name for a narrow-minded person called N. Levashov's "SvetL Broom" in A. Khatybov's "Bath School" and a Labor Spade is the public beginning of the true New Science?

*Doctor of biological Sciences,
Professor V. O. Salovarov*

*To
Nicolay Levashov
Svetlana Levashova and
Tamara Shkrudneva –
Dedicated.*

Knowledge is the most important, the most beautiful and needful in human life. It has always been and will ever be the highest manifestation of the world perception. Only on the basis of his knowledge and his perception of the world around is Man able to transform Nature and himself.

Acknowledgments

Firstly (and finally, or to be more precise, at all times), I would like to thank all the Sources that are in this book; Sources of all that my Knowledge and experience are made of, on the basis of which it is being realized what is gradually becoming **PUBLIC** and is working for **THE GOOD**. I have told in detail about these sources in the book. But the main source are my meetings with Nikolai Levashov, our heart to heart talks, his works and what I **HAVE PERCEIVED** thanks to him.

Secondly, it is obvious to me that each of us can make a list of people who have influenced our lives and our **KNOWLEDGE** so meaningfully and deeply that it is **IMPOSSIBLE** either to explain or describe it; who shared their wisdom with us, told us about their truth, helped us survive all our mistakes and failures with endless patience and found only the best in us. In their acceptance, as well as **REFUSAL** to accept in us something that we would like to get rid of ourselves; these people encouraged us to grow, encouraged us to become something **GREAT**.

I would also like to include some of my Friends in this list, whose names I do not mention for confidentiality, although I aware of and appreciate their part in my life and what they have done and are doing

concerning the already **CREATED** and **BEING CREATED Technologies** and **Programs** with a common name "**SvetL**", approved by N. Levashov, about which you will get to know a lot after reading this book. I especially want to **thank B. Makov, I. Kondrakov, V. Ikhtisanov, A. Goncharov, A. Yuriev, V. Chudinov, and V. Efimov** – the people who are directly related to science, who have helped me in this work ever willingly.

Thirdly, I thank the active participants of **the Russian Scientific and Technical Society ("RSTS")** and members of the newly set up **Clubs of New Knowledge named after N. Levashov**, who, sparing no efforts in disseminating the information and "**SvetL**" **Technologies**, made it possible to begin the implementation of my promise given in public – **TO FINISH WRITING** the book that had **NOT BEEN COMPLETED** by **N. Levashov**. And to finish it with their participation, since they are **NOT INDIFFERENT** to what is left for all of us **by N. Levashov, A. Khatybov** and other outstanding Russian Scientists. That is how this book **OCCURRED** through me. In the literal sense of the word. This book has not been written by me – it **occurred through me**. And while you reading the book, I am more than sure that it will **occur through you** in the same way as it has happened to many people while their making an acquaintance with N. Levashov's works, and then with the others, because all of us **WERE LED** to the truth that we had already been ready for "**SvetL**" **Technologies**, perception of them and their application only accelerated this process. And although my heart is **OVERFLOWING** with **GRATITUDE** for everything these wonderful people (Human BEINGS) have done for me, I cannot help mentioning my **MAIN helper, my wife and life companion Tamara Viktorovna Shkrudneva**, a woman with an extraordinary wisdom, an ability for love and compassion not only for me, in all my endeavors, but also for people turning to her for help.

And finally, **fourthly**, I would like to mention the people whom I **HAVE NEVER MET**. However, their very lives and what they had done for the good of the people have had such a strong influence on me that I cannot help **EXTENDING** my thanks to them.

My life would have probably been much easier if I had not mentioned all of this. But my articles, the Knowledge that I have got, and this book, and everything **HAPPENED** to me **NOT FOR** this. And whatever difficulties this would bring in (for instance, I have already been called a blasphemer, a deceiver, and a hypocrite because I had **NOT FOLLOWED** these truths

earlier – or, even worse, – a saint), now I **CAN NO** longer **stop** this process. And I do not want to. I have had plenty of opportunities to avoid all this, and I have not taken advantage of any. I have made up my mind to behave as **my** conscience and intuition dictate and not the way **MOST** people want me to behave.

My knowledge and intuition tell me that this book, all that it is expounded in it, is not nonsense, not the fruit of a tired imagination. All this is **REALITY** of the present day. And if we consider Technologies and specifically "**SvetL**" **Programs**, which are described in this book – what they are "capable of" or "not capable of" (no matter what some people think of it), the **TRUTH** lies in the fact that **the Programs TALK** to anyone who has decided to apply them – to a good one and a bad one, to a saint and a bastard. And, of course, with each of us who has already applied these Programs.

Prologue

Life goes on...

As a basis of the book, or rather, four books as it turned out later after long deliberation, I have decided to take a remarkable work of the Man who called me his associate, "gave" me so much knowledge that my acquaintance with him has become an integral part of my life, and what I have gained from him – **MY KNOWLEDGE**. The work in question is the "**The Mirror of My Soul**" by **Nicolai Levashov**. The events that have happened to me for the last few years seem to "reoccur" the events that happened to Nikolai. Just because of it and for the readers' better understanding of my story, I will "take" those episodes from Nikolai Levashov's book that I consider necessary, and project them onto the present day, the events that happened to me after his "passing away" (I do not want to say – death). This will make it possible to return once again to the information given by N. Levashov in his books, and to comprehend it, realizing that what he wrote about is happening today with many of us and everywhere.

I am also doing this because I have promised to "finish" the **INCOMPLETED third volume of "The Mirror of My Soul"**, which was begun by Levashov just before his death and which is called "**Life goes on...**" **Much** has been **contained in this title** (if you consider it carefully), including the answer to the question: why this volume must have been completed after **HIS PASSING AWAY**, **in what way and who should complete it and for what purpose it should be completed**. This is neither a continuation of N. Levashov's life story, nor some moments of his life that are known to me and that were not mentioned in his writings; although, I will certainly touch on some aspects. I am sure that **SOME** people will **CRITISIZE** me, because they are expecting this book to cover some hidden facts from Levashov's life and the continuation of a certain story about him. But these are neither memoirs nor a biography. These are broodings over the past and the left behind. This is **MY KNOWLEDGE**, that I have got at school, the naval school, the naval academy, and other educational institutions with famous names. This is the knowledge gained at naval and government service. But the most important is the knowledge gained from the outstanding Russian Scientists, who I was fortunate enough to know personally, and from those who unfortunately I have not had the

chance to meet, but whose works I have been lucky to get acquainted with. Having obtained **KNOWLEDGE** (that has become **MINE**) on the basis of those works I **HAS SUCCEEDED** in applying them in practice.

Why did it occur only to me to «finish" this book? **Why DID NONE** either of Levashov's circle contacts or the readers of his books **INITIATE** the implementation of any of his technologies, including the so-called "**Dark Matter**" **Generator, about which N. Levashov wrote and those he was able to create?** Why do some people today disseminate not information from Levasov's works but lies and gossip based on rumors? The answers to many "whys" you will find out from this book.

For me, there is no such a notion as "plagiarism", since everything connected with it is aimed at limiting the dissemination of a true information and strengthening the importance of those who "**produced and is producing heaps**" and laid them on a blank sheet not being aware of one thing: **NOT DOES HE** (the author) write, but **HE** (the author) **IS WRITTEN BY**. How this happens and what is behind it will be told in this book.

It so happened that I had to speak in public and tell about my relation with N. Levashov, about our meetings, plans. and some events, and about what I did and was going to do. I spoke about **the works by A. Khatybov, N. Morozov and other** living Russian scientists, I tried to make it clear to the people that **N. Levashov and A. Khatybov** had known each other, met and exchanged information. I told the people that what they had written in their works, was **INTERRELATED** and complemented one another. I emphasized that All That allowed them to create what they had created.

I also mentioned the **Friends that N. Levashov had and still has** and about them he wrote openly, but many readers did not understand **THE MISSION** of these Friends.

I have written in detail about the Generator (the generator of "dark matter" in his terminology) made by N. Levashov, **how "SvetL" Programs had been created and who had created them.** But very often the information I tried to convey got back to me in the form of a kind of "folklore", being surrounded with such stories that distorted almost everything including the image of Nikolai Levashov. The inventors and distributors of this "folklore", exaggerating and distorting the facts, except for the negative attitude to Nicholai and his activities, did not cause anything else. Were those engaged in it aware of what they were doing? I can say with all responsibility: **YES**, they **WERE** However, a lot of people wrote to me

and just called me or Skyped – those who have already read my articles, - asked me to write about the events that had occurred since my "acquaintance" with Nikolai Levashov. People asked me to tell them about the development of his heritage left to all of us.

And I decided **TO WRITE BY MYSELF** and publish the information that was available to me, tell about the knowledge that was gained and tested, and to go on giving information about those Technologies that have already been working for the good, to relate not only about **OUR COMMON** plans and thoughts, but also about that knowledge (gained from the works by **A. Khatybov and other scientists**), which made it possible to comprehend, create and expand "**SvetL**" **Programs**.

When I began to work in this direction, everything went on its own accord as a sequel of the third volume of his **incomplete work "The Mirror of My Soul"** and my comprehension of what was going on.

I hope I will be able to keep to a certain objectivity. Of course, everything described is going to be subjective reflecting the world around me seen with my own eyes. But for all that I will try to reflect everything as objectively as possible. And since this is a description of what has happened and is happening to me (what and when it happened in my life, what and how I thought in certain life situations, what I felt and experienced that time), better and more accurately no one will do it. But if something goes wrong, it will be a distortion of my own vision, and it will still be better than the distortions made by someone else.

I would like to note that I have never thought of myself as one of the selected. It makes me laugh even to think about something like that attributed to me, based on the fact that I was familiar with **N. Levashov**, and the fact that **HE "OPENED"** my Brain and gave me some kind of supernatural resources that allow me to do what I am doing now. Belief in destiny completely denies Man's free will; it turns Man into a slave of circumstances and makes a submissive plaything of external forces.

N. Levashov "taught" me a lot, and I learned a lot talking to him, studying his works and the works of others, about whom I have already mentioned. **All THAT** has become **MY KNOWLEDGE** that I am able to apply now. I just live **MY OWN** life; do what **MY CONSCIENCE** and my sense of justice dictates me to do. Some like it. Some hate me because of this and still cannot "endure" the fact, that N. Levashov **DELEGATED** a lot exactly **TO ME**. Some fear **BEING AWARE** of my capabilities.

I know my mission is to live and act as my conscience dictates, regardless of getting or not getting any **ADVANTAGE, BEING** or not being praised. And when I encounter some "curious facts", one way or another related to my life, they seem curious and strange to me, and neither more or less. I do not suffer either from any complex of inferiority or megalomania! Everyone is responsible for one's own live, makes one's own choice and takes responsibility for the results of that choice.

After getting acquainted with **N. Levashov**, I was set in motion by the only thing: yearning for the **PERCEPTION** of Nature phenomenon, longing for the comprehension of **PHYSICS** of a living **CELL, PHYSICS OF ENERGY** and **PHYSICS OF THE BRAIN** as well as striving for solving for this or that enigma and accomplishing the tasks set by myself.

N. Levashov taught me to look for an opportunity to comprehend the happening events, to consider any phenomenon in the aspects that no one had ever considered before. Sometimes it was necessary to see the phenomenon not from one new side, but from a multitude: and, what is the most surprising in all that is the fact that I have succeeded in getting the bottom of the matter lately. To be able to do it I had to radically change not only my way of looking at things but myself as well, under the "supervision" of **Levashov** and on my own one after **HIS PASSING AWAY**), and also "under the supervision" of his Friends (when it was particularly difficult). And, as **N. Levashov** said, that was exactly what made me move forward...

Wise is the one who recognizes the limitations of one's knowledge and skills. But the one, who declares that he knows **EVERYTHING**, is able only **TO HARM**. So, as **N. Levashov** and **A. Khatybov** used to say, everything is good in its season!

Lots of what I have been doing, what I had been taught by **N. Levashov** and his Friends, and what I have conceived by myself, cannot be put into the Procrustean bed of the ideas of lots of people, but... Quite a number of them not having the slightest idea of how, for example, their computer, video camera, telephone and a lot of other things work, especially of the processes occurring in the microcosm and macrocosm but nevertheless, they **DO NOT REJECT** them, since these things have been accompanying people since their childhood, and also because people had been inculcated in the thought of their nothingness, that **"man is a miserable creature unable to do anything by himself!"** And besides, only **the Lord God IS ABLE TO CREATE!!!** What is the most curious about all of this: **there is no evidence that the Almighty has created everything, only a blind**

faith! And that is not all! The way God created the universe, including our Planet was changed several times in the holy books, more precisely, the interpretation of the very process of creation. All the explanations of the nature of the divine creation used to appear only after the accumulation of the facts that the Church **WAS NOT ABLE to REFUTE** even with the greatest desire. And in the Middle Ages the Inquisition burned scientists on the bonfires for just being affirmed in the fact that the Earth rotates around its axis and around the Sun, like **Giordano Bruno** who was burnt. Nowadays, the church officially recognizes the existence of aliens and intelligent life **ON** other Planets. This is more and more talked about by the Vatican, which is an irrefutable proof of the manipulation of the people's consciousness and of the one who really stands behind the so-called "Almighty"!

Does the Church and its "ministers" play any significant role in what is happening today? I will not comment but just give you some figures. **Since 1991**, there have been built and **OPENED 20,000** churches and **CLOSED 23,000** schools. And No one but **N. Levashov and A. Khatybov** described the essence of all this in an intelligible and irrefutable way **in their writings**.

Do not be lazy, read and make conclusions of your own – who makes profit inculcating in people their being wretched and sinful from the moment of their birth" and are not capable of anything" but an obedient submission to the elect of "Almighty" (That **DOES NOT EXIST(!)**). Who benefits by **HIDING** from the people the possibility **of development to the Creator's level**, only not in the way as it is described by social parasites in the texts fabricated by them?

People – Human Beings! Start thinking with your own Brains; stop listening to other people's explanations, besides being absurd ones! A lot of things will become very clear if you develop yourself correctly. And what was attributed to Gods will become possible to Man! Yes, for the Man who has reached the level of creation, I emphasize, – perceived Creation! It is but necessary to go through all the stages of the development; as they say, **"it's not the Gods that burn the pots!"** I do not think I have managed to go through all the stages that **N. Levashov** had mentioned. But I know that I am going the right way. And the results **PRESENTED TO THE PUBLIC** confirm it.

Anyone can have one's own original ideas, plans leading to **COGNITION**, and the itch to properly develop very self. The main thing is

that once you take that **PATH**, do not quit the next day, month, year. Work at a pace that you are able to keep constantly. Observe the sense of proportion. You should **BE AFRAID OF** only one thing – **TO BORE** people with the unwanted actions. Avoid fruitless disputes. Spend your time on getting **KNOWLEDGE** but not on empty **DISPUTES**. And you certainly should be aware of the fact that deliberate denial of the truth is a betrayal of yourself. This is the way you should go if you want to move from the category of people to the category of Human Beings.

I have pondered for a long time about the sequence of information presentation that I possess, thinking of that knowledge that I would like to share with the readers. After **N. Levashov's "passing away"** a short time elapsed if measuring the phenomena taking place nowadays. But this time is full of many events within the framework of everyday understanding. Of course, I would like to tell a lot and share my knowledge with the readers in the same way as **N. Levashov** did. But where should I start? I have made up my mind to start with a common name of what I want to set out – with the name that would contain everything that this book is to consist of, with what that **N. Levashov DID NOT HAVE TIME** to write; with the explanation of what **A. Khatybov stated**; to show **HOW MUCH COMPLEMENTARY** are the works of these scientists who discovered the information for us that is "to be transformed" into our knowledge. But there are many people whose Brain is not able to perceive it, – and not because people are stupid, but because very few of them understand **WHAT EXACTLY** the **BRAIN** is.

Over the years, there have been written a lot of articles in which I wanted to explain to the people what heritage **N. Levashov left** for us in addition to his works. It was written and told in the framework of today's possibilities about how the Generator of "dark matter" had been created and applied; what **"SvetL" Programs** mean; how they had come into being and the way they had been modernized, tested and applied that day; how the name of **"SvetL"** was put in an appearance. All this was decided to be summarized in the collection **"Knowledge from the Origin,"** which was released in **2015**. But it was necessary to find a common name combining the works both **of N. Levashov and A. Khatybov** with some new works that would make it possible to develop this **HERITAGE** and apply it in life, as well as to provide "help" in **EVOLUTION** of the Brain, which is by no means unimportant today. However, whatsoever and whoever may talk about it, it turns out, that there is just **no way anywhere without the Brain.**

It is important to realize whether the Brain affects the life of a person. It turns out that we do not have a true notion of what the Brain is. We cannot see the Brain under a microscope or cut it with a scalpel. We actually **HAVE** a **VAGUE** idea of the Brain. And in order to perceive it, as **A. Khatybov** used it say, "**you have to have a Bath**". That's the way the name was born, uniting everything that is going to be written here: **N. Levashov's "SvetL Broom" in A. Khatybov's Bath School and a Labour Spade "**

You are going to get to know: what **N. Levashov's "SvetL Broom"** is and what it is for; what the "**Bath School**" is and why you should go there; What a "**Labor Spade**" is and how to use it.

Often it is easier for an intelligent person to open a new truth to the world than to realize why others do not accept it. I have long been convinced that no matter how hard I try to be understandable; people still are not able to part with the usual clichés overnight, especially if their **CONSCIOUSNESS** has lost its elasticity and is stiffened, which is typical of the older age. It does not want to part with the **MYTHS** put into their heads. I will try to break these clichés, return to the standard consciousness of people their Human properties and that world outlook that has been deliberately hidden for millennia.

Today Man has two ways to go. **ONE** is to abandon all reasoning about the foundation and nature of the society, merge with the crowd, hunting for bread and shows and surrender to the will of the elements. **THE OTHER** is to go further into the matter, the causes of our troubles and build up a modern system of knowledge; to create the system based on the knowledge of **those** who ran counter to the so-called modern science and who stood and still standing at the source of **NEW KNOWLEDGE**, that are destined to bring the Humanity out of that abyss and darkness into which people were deliberately immersed.

There is reading caused by emotions, and there are emotions caused by reading, which is more important. But there is also a **HUMAN MIND** that emotions interfere with. There are many who have already realized that we need information (out of reading) and the Mind for accepting (or not accepting) this information. Lots of people when reading **N. Levashov's** works paid attention to the fact that with the first reading they got at one meaning of the text, and then, re-reading, they conceived the text in a different way, that was much deeper and more meaningful. Practically all the information from **A. Khatybov** and **N. Morozov**, on the sites of the

Research Institute of "the Centre of Preventive Strategies" and "RSTS", is also given in the "framework" of the resources of your Brain.

What you are reading right now is the **SECOND FULL VERSION** of both books, completed in **March 2017**. But you make an assessment of what has been done after getting the results. After getting down to the writing of the book and publishing it chapter by chapter on my website, I began getting letters from the readers. They sent their comments and expressed their wishes: which information was not sufficiently covered, and which one was missing. All these numerous questions, requests and clarifications are taken into account in this edition of the text. It turned out to be voluminous and, to my opinion, not very convenient in cognition. Therefore, I made up my mind **to make 4 books** out of all the written material, which, on the one hand, are independent in their comprehending, and on the other hand, they **ARE SEQUELS** of each other, and what is important, they are sequels of the third volume of **N. Levashov's "THE Mirror of My Soul"**, as it was promised. I'm sure that the readers will appreciate it.

Time is running fast. Some Information is becoming out of date, and in this edition I will try to cover all the trends you wrote to me about, and in addition, to make supplements for better comprehension.

One of the deepest secrets for Man is the perception of the very fact of the physical process, under which both the harmony of the internal states of the functioning Brain and external states of its control are being formed, representing stage-by-stage growing perfection of the states of Consciousness and Mind. The Human Brain creates its own version of reality. The world that you see and hear around you only seems to be so. In most cases what you see and hear is not quite real. You perceive only a tiny fraction of what is actually happening. You get an **IMPRESSION** of a wide panorama before your eyes, but **REALLY** you see no more than the size of your own fingers at arm's length. The rest of the space is filled with imaginary reality since your Brain creates stable conditions for you. Although you may think that you are the Man and the captain of your ship, however, many processes are controlled by those who surround you, and your environment. You cannot trust your own Brain. But if you care nothing for your Brain, you have to go to the **"BATH"**, and beforehand to read this work in order to have an idea what **"BATH"** means, how to use it and why you should "go" there. And for this you **NEED N. Levashov's "SvetL Broom" in "A. Khatybov's "Bath School" and a Labor Spade.**

Introduction

Getting down to this work, I proceeded from the fact that a good book puts in good order the available knowledge. It takes our thoughts out of the consciousness, pulls them out of the corners of the subconsciousness, extracts from our heart and sticks them together to make **NEW** knowledge. As a result, a new "4" is given rise from already existing "2+2". New, sprang up of the existing, is **NOT** supposed to **BREAK** the harmony of the former. Thus, in my opinion, the worldview becomes more complete and clear.

For those who has read **N. Levashov** and proceeded to **A. Khatybov** (although understanding little from the above), who persistently advances in his knowledge, it would be worth taking the bull by its horns, and get at the meaning of **the Bath**. But to be objective – are there many such ones now? The undoubted majority is hardly capable of adequately perceiving any Genotype of the Brain, an incomprehensible albedo and frequency ... And ebro-spiders, the Earth capture and their Control System (SEC), are not "our" Sun and Moon? And about **a LIVING** cell, and who and where "got in there and what for" it is not of this world. Where is the sequence of events (in the form we "were taught") backed up with «advanced studies", artifacts and "world known" names of "explorers"?

When **REFLECTIVELY** reading **Nikolai Levashov**, everything is logically «being revealed «to the reader, and well grounded that can hardly be refuted, and all the material is outlined in succession. You **CANNOT** find all this in A. Khatybov's (as a result of the ban on most of his works). I do want to give information that is to be turn into a **NEW** knowledge of the one who reads it. It's like an emergency aid, suddenly stopped before the very nose of a lost person with no hope to survive. But this new knowledge is not collected together, it is like a heap of garbage, which is lying around. Should it be assembled – and there comes out a miracle of technology. Those who master this technique will no longer turn to someone else's help. This is what I would like to convey to the reader.

I got at a noticeable conclusion: people are mostly **READY** for a **NEW** knowledge, **BUT** the logic of **GRASPING** this knowledge is ineffective. This explains the fact why disputing such topics, even among those "**WHO PERSEIVED**", do not lead to anything. The debaters being preconceived believe that **THE MOST** important material is presented in a non-logical

way, but they are not even able to determine what is the most important. It only means that the ideas should be set out logically, so that the reader could clearly understand whether to accept the information or not to. To explain the complicated in a simple language, it is not enough to feel the truth yourself; it still needs to be understood. To talk to people thinking in the habitual categories on a large scale subject, is the same as to talk to children. Most people, no matter how smart they are, will **NOT TAKE** it seriously. Having been convinced of this, I returned to this subject in our talks with N. **Levashov**. The fact that someone is well informed in nuclear physics or mosquito leg testifies to the presence of intellect or intellectual resources, but **NOT THE SCALE** of thought. An intellect without large-scale thinking does **NOT SOLVE ANYTHING**. Thought is a product of knowledge processing! Man gives birth to a thought. ***A thought makes a MAN, because in the beginning there was a thought, and not a word. The word was after.*** It is not possible to do something that you did not grasp on a large scale, because you will not believe in the reality of your doing. And if you do not believe it, you will consider it nonsense and an empty fantasy. This is what happens with many who is trying to "comprehend" the "technology of creating **SvetL**" **Programs**. It is a perfect example of moving forward in the understanding of cause and effect, on the basis of which we will move to cognition, not before we are summoned to the **Bath**.

And we will be summoned to **the Bath** without fail, I'm absolutely sure about that. Because each person is absolutely **SELF – SUFFICIENT**. **He knows everything**. This was emphasized by N. **Levashov** and A. **Khatybov**, and I have been convinced of this. But a Man **HAS NO TIME** to put in good order his knowledge and thoughts and to get at the meaning of the new. There is no move **FORWARD** since there are too few "promptings" and clarifications. Start acting! That's what you are supposed to do. Act right here and right now. **DO NOT BE SLOW AND DO NOT ARGUE** about the causes and consequences of your actions in solving so large-scale tasks facing you. Start with a little – then there is an idea: it needs to be changed; start something new or finish the old one. You might need to catch up with someone, find or leave, help or just hug ... You feel like saying something to someone who is close by or not close by, or wants to be close by...

If there is something that requires your participation in order to move on, act then: speak, look for, fight, struggle, but **DO NOT BE**

INDIFFERENT. Take an action! Because the world needs your diligence.
Take my book as a **PROMTING AND CLARIFICATION.**

Chapter 1. The planetary level of secrecy, or "the operation of disclosure"

People take for the truth not that is true but what is understandable. The truth set out unclearly is taken as a lie. Intelligible interpretation is of principal importance.

Taking for the truth the conformity of certain provisions to certain criteria of verifiability (as in philosophy, for example), people limit themselves with these criteria, **HAVING NO** opportunities to expand the boundaries of their reasoning in view of the fact that they quickly go over those boundaries and indulge in what that the majority defines as **MEANINGLESS FANTASY**, but to put it simply, nonsense. On the other hand, criteria of verifiability must be at least greater approximation to the truth than their being checked provisions, and the latter also have to be checked with something. In conditions, when the thought rushes forward and deep into the distance, covering those areas, the essence of the content of which there is nothing to check with, there might happen a crisis of thinking that is able to turn into something new by expanding the scope of consciousness, or, in case of strict observance of the rules and laws prescribed by tradition and way of life, the circle closes and there will not be any search or movement to the truth. In the end, the old, currently existing criteria of verifiability, intended to serve as the instrument of knowledge, limit it easily, transforming the primordial Human aspiration for the truth in the plowing of the most affordable top layer of the observable reality.

* * *

On the sides of the spacecraft "Kennedy" there were placed two engines 5 feet wide each. The designers of the ship wanted to make these engines even further, but were not able to. Why? The fact is that these engines were transported by rail, which passes through a **NARROW** tunnel. The distance between the rails is standard: **4 feet 8.5 inches**, so the designers could make engines only 5 feet wide. The question arises: why is the distance between the rails is **4 feet 8.5 inches**? It turns out that the railroad in the United States was built similar to that in England, and England made railway carriages on the same principle as trams, and the first tram produced in

England in the image of the team of horses. And the length of the axis was **just 4 feet 8.5 inches!** But why? Because the team of horses was made so that their axes fell into the ruts in the English roads for the wheels to wear less, and the distance between the ruts in England is just **4 feet 8.5 inches!** Why so? Just because the roads in Britain had been built by the Romans, bringing them under the size of their chariots, and the length of the axis of a standard Roman chariot was equal to... that's right, **4 feet 8.5 inches!**

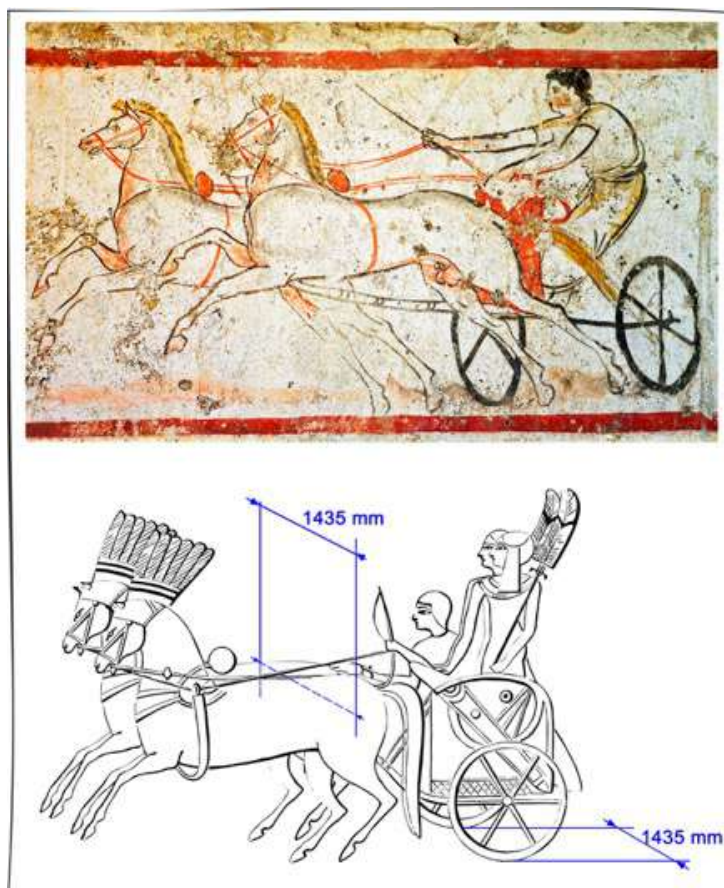

Now, we have got to the bottom of where this width comes from, but still why the Romans decided to make their chariots with axes of this length? And here's why: in such a chariot normally there were **TWO** horses harnessed. **And 4 feet 8.5 inches** is the **SIZE** of two horses' asses! To make the long axis of the chariot was inconvenient, as this would violate the balance of the chariot.

Therefore, here is the answer to the first question. Even now, when Man went into Space, his highest technical achievements directly depend **on the size of a horse's ass, as it was two thousand years ago.**

Let's take this "method" of comprehension and apply it to the information presented here. Let's go back to the events happened many thousands of years ago, that is quite possible if you understand that time does **NOT EXIST**. To move forward, you have to look into the past. So that you could "look" into the past, you have to be prepared; otherwise you would rather not however much you wanted. Time was "invented" only for our convenience, with our so short life. **Time does not exist, but there is physical-biological process in which it is possible to "enter" and move "back" and "forward"**, but before that you have to **TAKE the Bath**. Those who "has not received an invitation to **the Bath**", it is **NOT RECOMMENDED** to do it! You may come in if you are a Nobel laureate, in physics for example, but to come out – you will fail for sure. It has been proven.

1.1. The Beginning

"Where is the information from?" – you can ask. From **Alexander Khatybov's** encoded messages, confirmed in the writings of **Nicolai Levashov**, and by those real events, not to make notice of which is just **IMPOSSIBLE**. As **B. Makov**¹ has told, and **A. Khatybov** himself wrote about this, **during 1992-1998**, it was "accepted" and encoded **1652 texts** and at the same time, transmitted **772 texts**. However absurd it sounds at the beginning of the book. The deciphering of the texts "was made" with the help of the well-known method of **"Kaleidoscope"**, and therefore there is such a **CLEAR** and **UNDERSTANDABLE** "picture" of the past, independently confirming everything that was written by **N. Levashov** based on his own experience and that of others.

Most civilizations in the Space are at a **QUALITATIVELY DIFFERENT** level of evolution, when information is transmitted and received not via radio signals, but mentally and holographically, and to be more precise, visual-graphically nowadays. Thousands of signals from the Space are transmitted from other civilizations in the form of volumetric holograms directly and via the Control Complexes. There is no need in making contact. It exists in a specific realization, especially after a full stop and termination of all previous Control Systems and replacement in **2012** of the interventionist Programs for the original Programs of "the revival and

¹ B.V. Makov – the Director of Scientific Research Institute – The Centre of preventive Strategies.

reconstruction" of everything that had been on the Earth twenty thousand years ago. But most people do **NOT UNDERSTAND**, do not know and are unable to obtain this information. Those who can translate this information into other languages so that to make it **INTELLIGIBLE** to other people (the works by **N. Levashov, A. Khatybov** and others). But, unfortunately, even in an accessible form, this information **is REJECTED**... The same happened with **the third Appeal to the people of the Earth by the Coalition Team of Observers C. G. O.** (Association of civilizations of our Galaxy) passed for the people of the Earth **in 1929, to E. I. Roerich and N. K. Roerich** by Shambhala intermediaries. This appeal was **just ignored**... Who is still interested can get acquainted with **this Appeal** in **Levashov's book "Last Appeal to the Mankind"**. And as for the others I would ask you not to worry. Because it is too late to worry and there is no reason.

Let us emphasize two ways. **The first one** is to abandon all reasoning about the foundation and nature of society, about new knowledge and perception, mix up with the crowd, being eager for bread and shows, and surrender to the will of the elements. **The second one** is to grasp the essence of what is happening, in the causes of our present day misfortunes and to create for ourselves a modern system based on **NEW KNOWLEDGE**, which is supposed to include what is being narrated here.

I would like to draw the readers' attention to the fact that this information had been concealed from people for over the past 18 thousand years. 4 years ago, it was **UNTHINKABLE** to obtain this information (it was a planetary level of **SECRECY**).

* * *

The earth is **ARTIFICIALLY** created (**for 10 billion years**) formation to ensure the existence and evolution of life. **The Cell** (life) is also an artificially created formation, the existence of which is determined by the beats of the Earth. **The Earth** has its own "computers" and Complexes that make up **the Earth Control System (ECS)**. In turn, **the ECS** cooperates with the higher Hierarchy of the Universe.

ECS is a self-developing System, Controlling the Earth evolution and life support created specifically for our Planetary System (later it will become clear why our System is not called Solar System). One of the principal of the **ECS** tasks in ensuring the existence of life on the Earth is the maintenance and generation of the beats (a kind of quartz Generators) for the life of the

cell, organ, organism, community of living beings, of Man and of Human community.

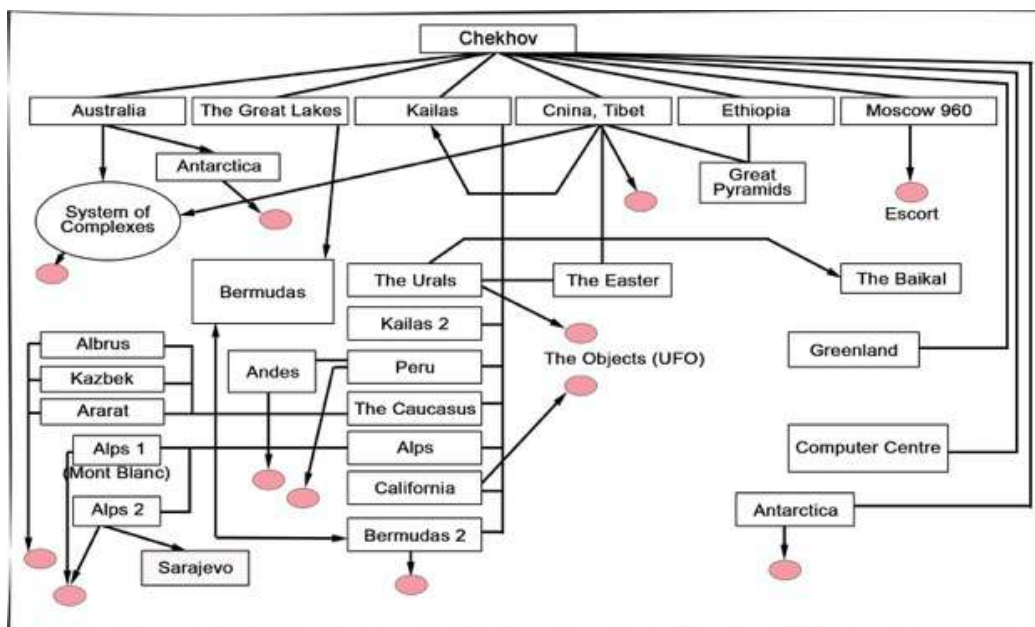

Some beats provide life cycles of the cell existence; other beats ensure co-existence of cells and so on. The beat frequencies of the Control System far exceed in frequency all conceivable physical variations (and go as far above as "the astral-mental frequency" to cone phrase).

It looks like science fiction! But in the search for additional evidence of the possibility of such creations, let's turn to **N. Levashov's** writings: "...**an artificial planet of an enormous size** was created, but that's not all. The Created **White Star** was able, curving the space around itself, instantly find itself in that Universe – petal or in that matrix space, where there is some need in help... This is the only one in its kind, a **CREATION** of the **MIND**, which moves through space not by itself, but, as you can say, moves the space itself. This creation corresponds to a well-known saying that "**if Mohammed won't come up to the mountain, then the mountain comes up to Mohammed**". And if a proverb has a figurative meaning, the White Star actually does it. A specific spatial **GENERATOR** changes the space around the White Star so that the space-universes one after another "are superimposed" on the White Star, and we can only set a task which space – universe it is to stop, and... the White Star finds itself in the right space of the universe."

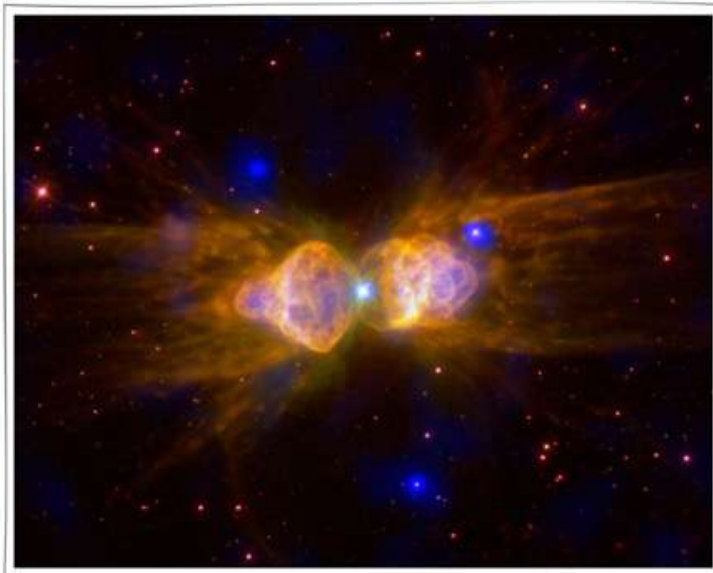

It also seems to be fantastic. Then refer to another Chronicles document– **the Slavic-Aryan Vedas:**

"The tribes were helped by the Power of God,
Blessing their lives for the common good ...
The Race was supported by the cherished Source
That remained in the tracts of the ancient...
The Gods foresaw the Darkness on Midgard
And Race decided to help the descendants
These events took place in the ancient times
When three moons over Midgard shone.
The Source has been placed in the bowels of the earth
But in peculiar tract the access was hidden.
In the depths of the earth, it accumulated the Power,
In different places It came into being.
But the Source of eternal divine Power
Not every space of the sacred Race flowed,
But only in places where, in line with traditions,
Midgard Gods Life Force inserted...
They bestowed upon the World the Divine Sense
For great achievements their kin directing..."

Here it is also mentioned a certain "Source of Life", which was placed in the heart of the Planet, and **a certain «Generator», set by the Gods.**

And if this information is not sufficient to satisfy the skeptics, you can take the "**Book of Books of all times and peoples – the old Testament or Tanakh**" in a somewhat abbreviated form. According to the Bible, **for seven days God has created** the heavens and the earth,

separated the waters from the land, worked on the creation of different plants and animals, created Man out of dust (the matter composed of atoms and molecules, like everything on earth) in his own image, and on the seventh day went to rest, satisfied with his good deeds. It also indicates the act of **CREATION**. *Although everyone gets it in one's own way.*



It is not by chance (according to the Bible) to create the Earth and Life on it... it has taken God **SEVEN DAYS** (day – light time of the day, rich in the spectrum of the primary matter (photons), but in the sequence of their qualitative and quantitative composition). As it is known, white light in its decomposition splits **into seven colors**, seven primary matters form a dense substance of our Universe, and the planet, respectively! And that's what was the result of their successive superposition:

But why do the work, which is easily done by Nature, under the corresponding conditions for the origin of life? Probably "something had happened" to the Universe and after that it was possible to start a "new experiment" taking into account the Knowledge "of the nature of the processes of matter formation", which more advanced civilizations **WERE ABLE** to carry out. More **SOPHISTICATED** systems for the evolution and preservation of Life on the Planet have been artificially created. In the ordinary course of the star-planetary System, the planet was subject to various threats from the matter conversion of the Cosmos – the explosion of

supernovae, flying "shards" of the Planets in the form of asteroids and other Space "riots", as well as from the objectively existing parasitic civilizations.

The planetary Cluster System² besides the Earth consisted of: ***Mercury, Venus, Mars, Phaeton, Jupiter, Saturn, Pluto, Neptune, and Uranus***. Each of the Planets had a particular function provided to it. For example, the System of planets did **NOT NEED** the Sun (there wasn't one) as a multifunctional generating system that provided the formation of control-energy radiation frequencies. On the Earth there were **364000 objects** to ensure **EVERYTHING** required for the complex control and harmonious **EXISTENCE** of energies, performing a process of civilizational development, and providing habitat conditions. The light had the 80 octave (the current lighting with the participation of the Sun is the 48 octave), gravity was of 5.82 m/s² (this fundamentally changed the whole arrangement of life for the Human, metabolic processes of the body and many other things in the state of reality).

That Planetary System was created for the development of PERFECT MIND, to reach by Man being on the Earth, **the TRUTH** about **Consciousness, Mind and Matter**. It was decided to realize this goal on the basis of the **Living Cell** in the **PROPER** evolution of the Human Brain under specially prepared conditions of life-attending **System of the Earth Control (ECS)**. This had been realized **LONG BEFORE** the forcible entry of parasitic civilization – the invaders from Darkling worlds.

1.2. Before the "Capture"...

Each planet from the Overall Hierarchy of Civilizations with the endowed living conditions, has to **HAVE** in its model design a certain required "set" of controlling, providing and attending Objects and Complexes, which being formed in the functional cluster³ Systems **have to be able to:**

² Planets clusters additionally invested power in developing civilization of intelligent orientation; their Control System consists of: Control Complexes, objects, Systems of energy-information transmission and communication which in total provide and retain in stability the control energies – the Mind.

³ Cluster is unification of several homogeneous units, which can be considered as an independent unit, possessing certain qualities, being common for each associated element. For example: celestial, galaxy, civilizational, planetary, cluster of public development. Control of every sphere of being, as separate

- provide autonomously the entire incremental process of controlling the development of **THEIR** Civilization on previously acquired from the outside program;
- to retain the **LIFE EXISTENCE** energies in a harmonious state with respect to each other;
- form the energy **SUPPLY** and "recharge" their existing energy concepts, etc.

Such a planet as the Earth is a kind of complex strictly identified planetary monocluster⁴ (with its own control of the existing energy and the development of civilization of Intellect orientation), which in line with the **PROVIDED** programs should be fully in harmony and interact with the help of the control system and provided functions, with cluster systems of **HIGHER** development in the course of its long evolution (8 stages).

The Earth is a set of models represented by the energies that are in the inertial (material) and no inertial (immaterial) states of aggregation of matter ranging from **12 to 512 octaves of the energies** for the **GIVEN** stage of civilizational development as the first stage of a nested program for its **DEVELOPMENT** in general. Our Mother Earth is not that simple as it seems to the present-day geophysics and, especially, policy-globalists, who has turned it into the field of getting profit for their earthly blessings (not with their own brain) as a result of their destructive irrational orientation!



lower elements in general Construction of people's being; it is also expressed with quite specific functional people's being.

⁴ Planetary cluster is a thoroughly adjusted model Construction of a separate planet, presented as a complex of energy gratings of the whole range of energies in their material and non-material relative stability.

The whole Earth System⁵ previously exercised its **Sirius**-oriented movement at a distance of about 240 billion km (for the Earth). The orbital model of arranging the whole Cluster System of the Earth was completely different, and the direction of the overall movement was not oriented to the Polar Star in the constellation of the Great Bear.

The main parameters of the Earth before the attack were:

- the inclination to the Ecliptic plane is 25°;
- day and night = 48.64 hours;
- a year =864 days (with respect to quantum fluctuations of the charge =1,007 sec.);
- the height of the gratings of the original Design of the atmosphere amounted to 12.000 km;
- the number of layers of the formed gratings of the Atmosphere was 18.

The level of the surface layer of the Earth had been almost 11 km below. The shape of the planet was more close to the shape of the ball; the present array of rock formations and other new built "garbage" had not existed. Unlike the intervention's design of the Atmosphere (now existing), the construction of the original one had been significantly different both by functions and in the structural plan. The construction of the gratings had started from the hardest of the plates, i.e., the Atmosphere had begun and built up over the plates (the hard coat). In the gratings of the Atmosphere there had been so-called "The atmosphere Brain."⁶

Before the intervention, the Earth had deservedly been defined as the **GREEN PLANET** and the «tourist Paradise», because there had not been any all-destroying enterprises in this similarity, especially smoking chimneys, since all the technology of the reproduction sphere had been based only *on the use of the energy received from the environment. Most manufactures of any product of any scale had been based on the technology of the model synthesis in the high octaves of the energies* with converting the created models to the physical plane in the end (through lower octaves of energy in the material plane, i.e. metallurgists

⁵ The System at the Cosmic body is created for the formation of that kind of biological Structure that, entirely is able to be under the System's control and to carry out the System's program.. The goals of the System: to ensure the performance of the Programs; to carry out Regular control of the Programs fulfillment.

⁶ The atmosphere Brain – Informations blocks formed in numerous chains so that to ensure and create various informational bases and structures united into a single System, and placed in the heights range from «-2400 m» to «12400 m».

had not been required, and metal working lessons at schools had not been practiced).

There had not been any oil, gas, peat and other stuff, not any sulfuric mud, and, especially, the technologies of combustion on the basis of sulfur.

There had **NOT BEEN** any diseases on the Earth, since the structure of **DNA** had been in the state of full activity, i.e., the operation of the cell of the flesh had been carried out in the full model state of all **FOUR** codons of DNA. ***This provided biological existence in the physically plan of the proto-Human up to 1300 years*** in the active mode of his useful cooperation in his being (however, it should be taken into account another length of day and year). A more developed Person, who for some reasons "was endowed" to develop others, had been able to exist in his physical form **for 10, 15 and 20 thousand years.**



A year ago, Israeli scientists published a public report in which the results of studies demonstrating that Human cells in **OPTIMALLY** favorable conditions **EXIST** up to **35 thousand years!** Note, the intervention System has **NOT** been **ABLE** to reach the secrets of the fourth codon of DNA, so, despite the populist achievements of geneticists and gerontologists, to extend the biological existence of the flesh cells was a failure. Moreover, at such low octaves of the Brain of the present people (maximum at the 63 octave) biological life extension longer than 125 years is not possible⁷. The solution of this question I "did seek" by upgrading and improving the **Program "SvetL"**. Only an increase in the level of at least up to 82 octave will make it possible to **extend biological life to 250 years.** But today a significant "step forward" has been made. There has been

⁷ Every biological object on the Earth gets its own life support system with birth, when loosing its ties with the organs (e.g. pericardial system) the brain stops the heart. The executive mechanism of the Brain is laid in the skull and in the stem of the spinal brain. The Centre regularly provides information TO ALL, and if the Brain is able to "pick off" and process this information, the biological structure is of rather high informational level. Only 4,28 % of the Brain are operational. The spiritual development of the Brain is contributed to its evolution (not religion).

found and **BUILT the Bath**. But as for being taken there or not being taken – it is another story!

As I previously mentioned in order "to make you happy" – exactly the geneticists and gerontologists of Russia through trial and error will be able to solve this problem; the first positive steps towards this have already been made.

1.3. Parasitic civilization – Ebrs

Six million years ago from ANOTHER space in that area of our Universe that now we consider as the Great Bear, there came into being a system of star groups of EBRs civilization.



Ebrs is the **EVOLUTION** of the protein **MIND**. In the material embodiment they are spiders of **2.5 to 4 meters** high, depending on their existing hierarchy of membership (for comparison, the height of proto-Human did not exceed 1.88 m).

For 5.5 million years Ebrs civilization had studied our Universe in order to find the opportunities to enter into the Community of Intelligent Civilizations of our Universe. But it was impossible to achieve that. So the decision was made to start active (violent) actions with the same purpose – to enter into the Community of Intelligent Civilizations of our Universe, but by pseudo-evolutionary **TRICKS**.

Before "attack", Ebrs had studied the structure of Space, got to know the Golden ratio and principles of redesigning the biostructures.

There began the approaching of ebrs system Starfleet from the Planet Sur (the area of the star **Megrez δ**) from the constellation of the Big Dipper (lat. URSA major) with interplanetary System of the Earth.

The Big Dipper (lat. Ursa Major) constellation is in the Northern hemisphere of the sky. Seven stars of **the Big Dipper** compose the figure that resembles a dipper with a handle. Two of the brightest stars, Alioth and Dubhe, have the luster of 1.8 of apparent star magnitude. By the two extreme stars of this figure (α and β), you can find the **North Star**. The best visibility conditions are in March-April. IT is seen on the whole territory of the Ukraine and Russia.

The Big Dipper is the third largest constellation, the seven brightest stars of which form the famous **Big Dipper**.

All the stars of the **Big Dipper** have their own Arabic names: **Dubhe** (α of URSA major) means "bear"; **Merak** (β) – "loins"; **Phecda** (γ) – "thigh" **Megrez** (δ) is the "beginning of a tail"; **Alioth** (ϵ) – the meaning is not clear; **Mizar** (ζ) – "the sash" or "loincloth". The last star in the handle of the **Dipper** called the **Benethash or Alkaid** (η); in Arabic, "al-Kaid Banat our" means "leader of mourners".

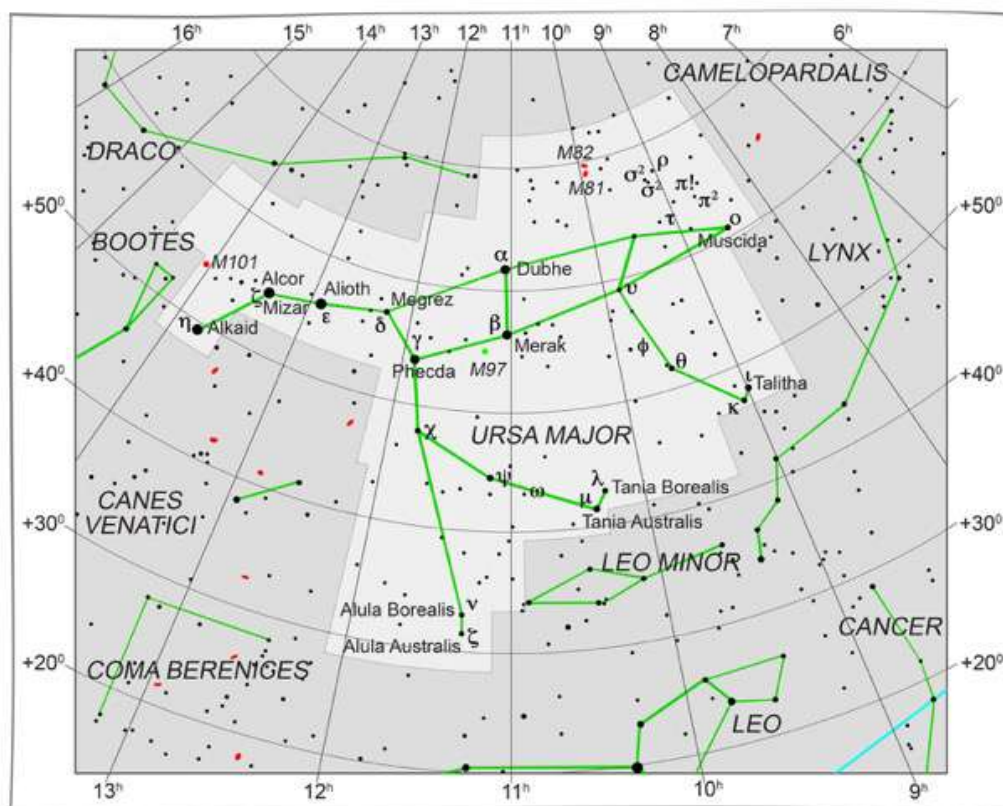

The approaching of Ebr system Starfleet in the constellation URSA major of the planet Sur with the Cluster Interplanetary System of the Earth began **26844 BC**. The Starfleet included: 1 planet the Sun, 3 the moons (Brain), 12 main objects of type 960, 54 satellites, 3862 objects of attack type 440 with the technical means of destruction.

The approaching continued for 8.5 thousand years.

1.4. The Attack

THE ATTACK at the Cluster interplanetary Earth System occurred **in 18344 BC**. At the Earth itself – some time later, i.e. at the **FINAL** time of **the TOTAL INTERVENTION**. The process of intervention should not be understood as a transient form of some of the fighting (Lots of fire by Hollywood scenarios, supersonic aircraft and clan contradictions of some of the lords, Hierarchs, etc.). *The capture process was carried out for 1040 years.*⁸

Ebrs interventional System did not have well concentrated operational and universal "build up" on any of its planets, taken for the accomplishment of the intervention. All minimally restricted, necessary and indispensable set of operational Complexes, and Objects to create such a control cluster, they had scattered simultaneously on several of their imported "satellite objects" and on the planets the Moon (**there were 3 moons** – Month, LELA and Fata), the Sun and other planetary objects. In addition, a large part of interventional planetary objects at the time of capture of the Earth **had been DESTROYED** by Phaeton (as the former element of the original mega cluster of the planets of the Earth modeling complex).

To gather all the necessary energy technological integrated cluster state of operation on one of the planets was **IMPOSSIBLE** for their level of technical perfection. But the Earth practically possessed such necessary perfect set independently. In addition, on the home planets, previously representing together with the Earth, an interplanetary cluster complex, to which now astronomers have given the conventional definition of "parade of planets", there was assisting and complementing set of the control

⁸ (The growing tragedy of the situation or evolution of the "forcible entry" into Nature?) Moscow. 2013.04.07.

complexes and objects being a single Model cluster complex of the Earth for its development for all forthcoming eight stages of civilization evolution.

It is for this reason they (the invaders) needed such a planet as the Earth. Associatively affecting the Earth with all of its imported technology and energy opportunities they **Would BE ABLE** to **CREATE** for themselves acceptable conditions of their own program simulated existence, parasitizing on the captured structural and energy opportunities of the Earth and its entire model complex (**only 12 planets without PHAETON**). So interventional blow to seize was applied to the whole Model complex. But after that capture the process of their own settlement began, and not only on the Earth, i.e. conversion and adaptation of all and everything.

The Control system was carried in the closed "thermos" like the Moon. The caravan consisted of hundreds of such Moons. The caravan was accompanied by "protection" that could eliminate the resistance of that part of the habitable Space, where the convoy would decide to settle. If the Parking lot looked attractive, it was included in the convoy and driven back home. That way acted those who arrived to the Earth System Planets. ***The system consisted of 12 planets.***

The purpose of the parasitic capture:

- the seizure of the Earth and getting it as an "energy pill";
- access to more energy-intensive sources due to perception of the mystery of the living cell;
- penetration into the secrets of the Human Brain.

A LOT of these the invaders have **MANAGED** to **IMPLEMENT**.

The sun is a planet, imported into our System (with the Moon), the diameter of the Sun is approximately equal to the diameter of the Earth. Our SVETILO-LIGHT (Jarilo)) was gone out and replaced by the Sun, which had an atmosphere with a thickness of about 2000 km, consisting of a mixture of oxygen and chlorine. The sun is hollow inside; there is life only inside (like in a shell). There is everything necessary to sustain the life that the aliens wanted to do all around our System. **The Sun had 231 objects, 127 of them are objects of type 440.**

Taking account of the objects it was roughly calculated the number of spiders (up to 4 meters high). **They turned out to be 1.200.000.** They all waited for a landing on the Earth. There were formed linking tubes of all the planets with reference to the Sun. Actually another space was being created that led to changes in the Earth's orbit (the orbital period of the Earth around

the Sun became 365,5 days instead of 630 around Yarilo). It was formed a protection ring around the contour of the Earth's rotation. Inside the contour there were formed the tetrahedral link tubes. The rest of the planets were locked to the Earth and had tubes of dodecahedra tetrahedral structure. All the outer planets were surrounded by the remaining escort.

After the formation of the cone the motion to the 4th star of the Great Bear began. This system of 7 stars is an outsider and arrived from another Space about 6 million years ago. In the system of the 4th star there are a few planets (12), the main is **SUR**.

But the Earth had different conditions, including the atmosphere. In addition, on the Earth there was some population differing in biology. At first it was decided to silence and then to completely subjugate the Brain of the Earth (Complexes) to the Control System of the intruders and to transplant the Brain of spiders in people (in biological structure). ***Here the problems sprang up.***

The principal task of the interventional Control System (CS) was not only to bring the finished system of planets home (Sur is from the Great Bear), but also to **ADAPT** themselves **to the PEOPLE** of the Earth (while keeping their own Brain).

The earth is the border of direct control that is why Venus and Mercury have no satellites. Their complexes are completely switched off, and from the point of view of the control they are of no danger. The Earth is the center of the Control System (and before the capture it was the Center of the Universe); all the other planets have their own Control Systems, part of which is switched on. It was impossible to destroy them since their structure was unknown to EBRs Control System, that is why they were surrounded with satellites, some of which had control functions. 15 satellites (yellow color) had tubes with reference to the Earth, the rest of the satellites were tied up with reference to one of the 15 satellites.

Each satellite is either the archive or storage of tritium, spare parts and so on. 15 main and 18 intermediate (painted over) had their own UFOs, which could only move in the limits of the satellite. The satellite orbits were chosen in such a way as to have maximum control of the corresponding planet.

Of particular interest is the Moon. This is a Software Generator (up to 88 octave). Inside the Moon there are powerful complexes. The glow

of the Moon is an imposing radiation of their own systems with 128 of the octave, set by the Sun.

The Software Generator used:

- the colliders of the Earth, beat interval combined with 128 of the octave;
- created gratings on the Earth;
- Meton calendar and metric system units of "Hulk";
- data archives of the satellites obtained by the complex 555 (Earth);
- control data to correct the Program.

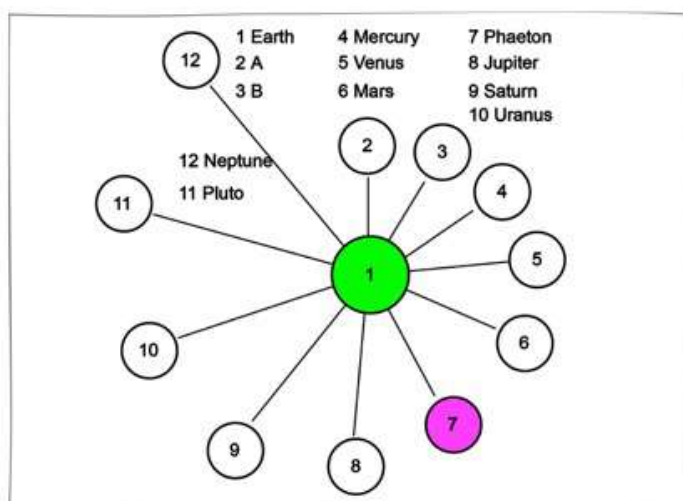

Time control and synchronization were performed by Stonehenge complex according to the data obtained from the Moon.

The moon has a special status that is why not a single meteorite from the meteorite belt does not fall on the Moon – the Moon objects (UFO's) control everything, in case of danger the Moon changes the density of gravitational potentials in the tube with reference to the Earth. Of particular interest is the **HALO** of the Moon (from Greek. ἅλως – circle, disc, aura, halo) the luminous ring around a source of light – maximum switching on of all Moon complexes and discharge to the Earth next portion of the programs. So all this talk that "**someone has been on the Moon**" – is not justified. The Man **HAS NOT BEEN on the Moon**, and he **CANNOT BE** in his physical form.

Each Program was calculated by Meton cycles – the 500 – year-program for 28 cycles and a 100-year program (from 1888 to 2000) – 6 cycles, 20-year program (1992 to 2011) – 1 cycle (final).

In connection with the correction of the Programs, there was a need for urgent replacement of the Power Supply Systems and Information SUPPLY systems on the Earth (objects 560).

The old objects were immediately removed; new ones were ready to start. Their location is known. **The start of new gratings in the atmosphere from h>-1240 and up to h=12400 m was to be produced in 2012 – it did NOT WORK.** (I'm a little ahead of time).

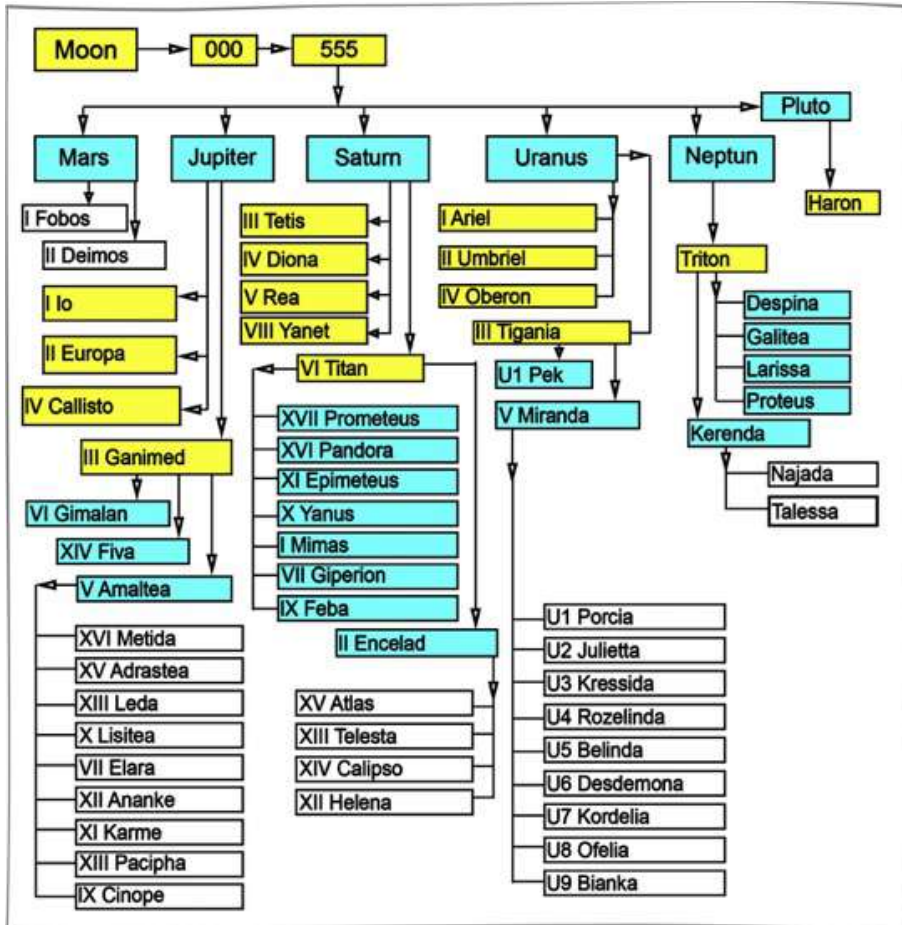

On the Earth there are other Complexes, for example, in the South East Asia. They were **NOT DESTROYED**; they have been used for their designated purpose.

The first Complex, which started to work, was **Ararat**.

After the formation of the grating with the carrier frequency the grating of "hearing" ("**in the Beginning was the word...**") was created; then in step-by-step manner the rest of the gratings were created. Specific frequency is created by a pyramid; it cannot be created with any modern equipment on

the Earth. As new Complexes were put into operation the **entire 12 groups** were created, each group having in its structure hundreds of thousands of frequencies.

Characteristics of frequency ranges

N	Frequency, HHz Range		
1	0,124	0,666	Carrier frequency k-structures ,used for everything.
2	0,666	2,16	Used by all animals, insects and majority of the population
3	2,16	4,28	Outer hearing 42x, 441 (33%)
4	4,28	7,24	Outer hearing 441 (66%), 442. For 442 information exchange with humanoids 442
5	7,24	12,4	Connection 442 with Alps 2
6	12,4	16,2	Used only by objects 440
7	16,2	22,4	Used only by complexes 560, 520, 500
8	22,4	28,8	Used only by object 960
9	28,8	33,2	Used only by object 960
10	33,2	66,2	Used by all complexes for interchange
11	66,2	88,4	Used for connection with the Moon
12	88,4	124,8	Connection with satellites

1.5. Phaeton Catastrophe

The Control System belonging to EBRs, constantly formed the sequence of events leading to the absolute seizure of the entire System of planets. However, there is one "but" –when attacking the System of planets, **2/3 of the guests** were eliminated, the planet (let's call it Phaeton) blew itself up together with the invaders.

At the initial stage of the interventional capture **18344 BC** only Phaeton was able to go into action with the aliens, as the planet, with its endowed protective functions for the entire Cluster System. The attackers forces in general terms were: **54 satellites, 3 Moons, the planet Sun** (it was a planet then), **12 leading objects (type 960) and 3862 attacking objects** (which had technical means of destruction, most of which are objects of type 440⁹). In addition, 1/3 of the satellites had their planetary objects of the active technical affect in the modeling scope of their satellites with limited autonomy (for simplified and traditional understanding – as if UFOs). The Phaeton Defenders took the whole active process of the

⁹ UFO is the facilities for the control of the outer environment (sonde type). All the UFOs on the Earth are at -3300> h> -4400 meters. The bigger part of UFOs is exactly under populated areas. ALL UFOs are near the water expansions where at the depth of 4400 meters there are sufficient reserves of tritium. Tritium is needed only for UFOs movement within the limits of the Earth.

destructive effects of the aliens on themselves and blew themselves up as a planet-fortress to prevent its "captivity", and, especially, to exclude the penetration into its technical ability of the protective and destructive nature. Phaeton destroyed 2 Moons, 11 principal objects and about 1200 offline attacks. Fragments of that destruction sometimes disturb the Earth's Atmosphere to this day.

Now this planet's orbit is a meteor belt. The Guests were unable to destroy the Brain of the Earth (The Earth Control System), as it was above their resources, even though it had no technical means. The rest of EBRS **SEIZED the EARTH** and other planets. The rest of the space fleet of the aliens became the satellites of these planets.

1.6. Restructuring (for themselves)

19304 years ago, the invaders started and realized the following:

- captured all the planets, made a clean sweep of all the flesh and their souls (non-inertial energy substances) captured;
- gripped the celestial system of the planet Earth utterly
- the planets of the Earth system were surrounded with satellites, as "an escort";
- began movement in the direction of the constellation of the Big Dipper (URSA major).

The first aggressive invasions for 1040 years resulted in the full capture of all the planets (the end of the grip in **17 914 BC**). **The capture, by itself, was symbolic**, because all the principal complexes on the planets of the interplanetary Cluster Complex of the Earth had been **TURNED OFF** before the seizure, and without knowledge of the structures of their construction, and assuming a lower level of their cognition, the attackers just tied all the planets with the gravitational tubes (hereinafter communication tubes¹⁰). They included the embedded base generating frequency of radiation protection of the Sun, surrounded the planets with "satellites" (as security convoy) and began moving in the direction of the Big Dipper, in order to

¹⁰ Connection tubes are sleeves like Shukhov's Tower where there is a necessary set of frequencies: gravitational and informational. Magnetic impulses that sometimes come from the Sun move to the Earth only in the sleeve. If there are no supporting frequencies in the sleeve magnetic impulses are dispersed in the Space (do not reach the Earth).

make it clear the area of its active reach. But on the way of the movement it was decided not to waste time and carry out some possible change in their favor...

A. Khatybov proved that the World around us **IS NOT SOMETHING** material separate and ideal separate – **is a united and indivisible whole**. Just this world is expressed in different sets of frequencies. This is the only difference. But through the perception Man was imposed the *illusion of the would being only material* and **SEPARATED** this **WORLD** from its mental and spiritual activity. Earlier, before the invasion, there had been no such perception of the world (via duality) in our Ancestors. *We can't call our Ancestors people or Human beings because modern Man in comparison with our Intelligent Ancestor is a Monkey compared to Man*, as paradoxical as it may sound. And "lowering" our Intelligent Ancestor to the level of a "modern" Man **WAS** made by external Forces. That explains the weird development of the entire Earth's history, with its countless wars and immeasurable violence, and strange evolution of science, which actually *enslaved the Mankind*. In what way and who all this was and is being carried out– we are going to make it clear in a serious way in this book.

Let us leave this trial "for a while". Meanwhile, let's take a closer look at what could have been the Creation of the Higher **Mind** of our petal-universe. Again have a look at the heritage of our ancestors-the Slavs – the Slavic-Aryan Vedas.

"In the ancient and glorious times in the land of abundance of Midgard-Earth, in a fertile ancient region, in the ancient and mighty Asia, which lay to the East of the Repeiskiy mountains (the Urals) and extended beyond the H'Aryan Sea, and from the chilly sea of D'Aryan to the greatest Himavat mountains lived four great Kins of Aces, the descendants of the ancient gods of Light, the four great families of Rousichi.

The great and most wise of Asa began to move into Asia from the **Sacred Land of Daaria**¹¹ in the ancient and glorious times.

¹¹ Daaria Land was situated on the Continent that sunk in the Arctic Ocean.

And **Families began to live** happily in this blessed ancient land from the beginning of time of prosperity, when even our **Great Forefathers** beheld **three moons**¹² in the night sky .

Ancient and wise, the Great Aces called this fertile region the Holy country, the country of kin's of Asa or the land of the Holy Race.

Multiple families of the wise Aces came into this fertile region of Asia from the Sacred North Land where our **Three-Light-Yarilo-Sun**¹³ **will not want to have a rest**, if only to witness the benevolent acts of all Light Heavenly Gods and the creations of their great descendants in the fertile Midgard-Earth."

Let us see some other sources of information to have a more complete picture of the chronological events on our planet.



Some of the extant ancient myths and Chronicles say that "the Earth existed, *when there was no moon in the sky above her*". Greek philosopher and astronomer Anaxagoras of Klazomen wrote about this in the 5th century BC who made use of the ancient sources, which did not come down to us and which claimed that the Moon appeared in the sky later than the Earth origin. In the III century BC it was supported by the Greek philosopher and poet, General attendant of the library of Alexandria, Apollonius of Rhodes.

In the essay "Argonavtika" he quotes the words of another philosopher, Aristotle, a century earlier, mentioning in one of his writings about the ancient inhabitants of the mountain districts of Arcadia (region of

¹² Three Moons: – 1) Lela, revolution period around Midgard –Earth (the planet of Earth) was 7 days; 2) Fatta, revolution period around the Earth was 13 days; 3) Month, revolution period round the Earth – 29,5 days.

¹³ Three- Light Yarilo-the Sun –An Ancient Ancestral Wisdom runs that the original Sun was called Three-Light as it lit three worlds: Yav (the world of living); Nav (the world of the dead; Slav – the world of the Gods.

Peloponnese), who "fed on acorns, **and this was in the days when in the sky there was no moon** Three Moons of Midgard- Earth. Writer and historian Plutarch, who lived at the turn of I-II centuries BC, says about one of the rulers of Arcadia named Proselenos, which means "Before Moon", about his subjects proselenitas, the first inhabitants of Arcadia. Modern scientists do not deny the possibility of the "**moonless**" stage in the history of the mankind and give different explanations. According to one of them, once **the Moon was one of the planets of the Solar system**, but then, because of some cosmic catastrophe, **left its orbit and became a satellite of our planet.**

You can draw a slightly different picture, **WITHOUT REPEATING** the interpretation of the publishers in the footnotes of the text of the Slavonic-Aryan Vedas and referring to earlier documentary sources. Our ancestors gave the name of moon to the satellites of planets. Since our planetary system was **CREATED ARTIFICIALLY**, everything was conceived and manifested in its unique structure in relation to many other planetary or solar systems of natural origin.

Certainty about the uniqueness of our solar system have appeared recently, when it became possible to explore open "exoplanets" (planets orbiting other stars) and discover that in other solar systems everything is not like in ours. Recently, on the subject, there was a small article under the name "**Solar system was born in a unique environment.**" "American and Canadian scientists using computer simulation proved that for the formation of the Solar system there were unique requirements, and it is a very special case among other planetary systems. The study is published in the journal "Science". Most of the previous theoretical models explaining the formation of the Solar system from a protoplanetary gaseous-dust disk were based on the assumption that our system is "average" in all respects. In recent decades it was discovered about 300 exo-planets – planets orbiting other stars. Summarizing these data, astronomers from the American Northwestern University (Illinois) and the Canadian University of Guelph, came to the conclusion that the Solar system is in many ways **a UNIQUE CASE**, and that its formation required a very special conditions."

One major change on the Earth was switch-over of the underlying basis for the formation of spaces **with dodecahedral to cubic basis** of the formation energy gratings. The imposed cubic¹⁴ energy grating, having

¹⁴ In the process of creating the Earth there was a working structure of another grating inside the cube, and cubical was used only for the control. More than 5000 years ago a certain system changed the

framed all previous state and energy structures, changed and restricted the status of the material world on the Earth to a level acceptable only for the strange Control Systems, changed all the conditions of the environment, including the atmosphere, water, biosphere, etc. Nowadays this process is **HAPPENING Vice VERSA**. The base of the space formation is shifting **from cubic to dodecahedral** basis of the formation of energy gratings. This has been considered in the creation of “Svetl” Programs as well. But there, this whole "procedure" is carried out through the design of Tor, as a kind of "Converter» of one design to another (without destroying it). About this – later.

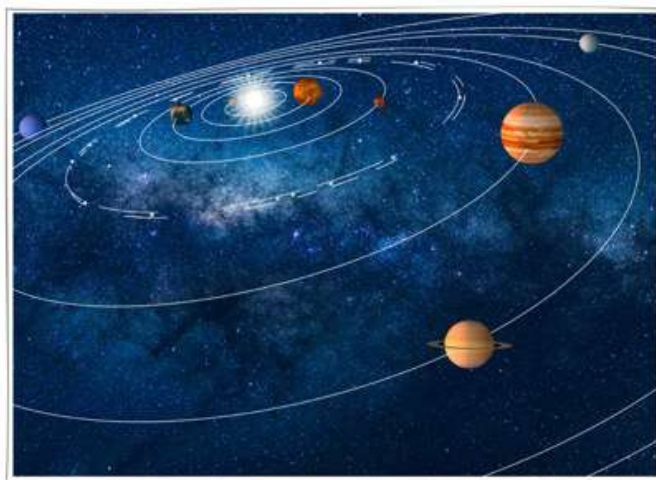

The satellites of our Planets played a special function – the protection function and the reflection function of our atmosphere albedo, which on the one hand, created the stability for the Planet and life on it, reducing the risk of getting random space objects by creating a **gravitational-electromagnetic oasis**. And on the other hand, **CONTROLLED** the **HEATERING** of the planet's atmosphere. This allowed the system of the light paraphase (our **Three Lights-Yarilo Sun**) evenly distribute the heat across the surface of the planet, creating the necessary conditions for the abundance of the vegetable kingdom – the Foundation of all life. Permanent vegetable photosynthesis gave the required amount of oxygen, such a valuable component of the gaseous environment of the Planet, both for the purpose of creating a robust ozone shield, and the saturation and evolution of the intelligent beings Brain for its **BETTER FUNCTIONING**. As it is

connection relations, and inputting its own elements, created a new type of grating, in which the whole world has been existing since. Its depth is 2200 m, height =12400 m. That is Noosphere or the world of environment and inhabitat.

known, lack of oxygen leads to the degradation of the physical cells of the Brain and reducing the lifespan.

The paraphase¹⁵ of the light is a shift at a certain value of the light pulse phase. For example, **at zero bias**, we have normal sunlight, **at 120° bias – night, at 240° bias** – the transition of night to day, or daybreak. This cycle is repeated daily, and no one ever doubted that **EXACTLY** the **SUN** is the source of light. In normal life **Man is protected**, which weakens the light beam at about 1000 times, and when Man is gone (dies), this protection is removed, and the sunlight becomes unbearably bright and the only source of heat, and that's why nobody wants to leave it. If Man dies at night, then the intensification is in the opposite direction, here the dying man tries to fight for his life, as he falls into the cold darkness.

This protection can be observed indirectly in the form of the refractive index of the space's boundaries of the protective field around one person or total fields of a group of people. Rainbow color indicates **SPACE DEFORMATION** produced by the seven forms of the primary matter.



Modern physics teaches that the solar light is both quantum (material particle) and a wave at the same time. If is an elementary particle, it is in the line with the other particles arriving from outer Space (**but nothing arrives from the Space, apart from the crumbled dust of the outer shell of the motion cone of the Solar system, and the incoming trash has the same structure as on the Earth**). There is no other

¹⁵ Paraphase is both the Brain function and simultaneously external conditions, e.g. sudden appearance and disappearance of the source of light in the determined phase.

information about the sunlight. But P. N. Lebedev's experiments on the pressure, produced by a quantum of light are known. However, the Sun is the principal information complex, producing the supply of necessary information to **all 12 levels** which are divided into frequencies.

The structure of quantum of light is "an egg".

At a certain phase of the atmosphere the required frequency information was given to someone more, and to others – less. There were regulations of the length of day and night, heat and cold. During these paraphrasing one program was removed and another program was delivered. Let me remind you that the ultimate supplier of the Program was the Moon. The external symptoms of the intake of the required octaves were manifested in the form of the Northern Lights, which no longer happen due to frequency changes in the Earth Control System.



Similar but the reverse of this process are visible in the appearance of vertical color columns at night and in frosty time of the year. Here the process of pumping the atmosphere from the earth takes place.

In this regard, we can conclude: when the frequency characteristics of the Earth Control System are changed the alternation of day and night is necessary.



But was it always necessary?

Is the alteration of day and night necessary for already-developed Intelligent Civilization? Had it been thought over another lighting system to accompany this unique experiment?

1.7. A little about the Sun

I got carried away a little, but (objectively) I specially touched upon these issues, just to show you a logical "Interrelation" and confirmation of the information from A. Khatybov and N. Levashov. And this (I hope you have already comprehended) – is an **OBJECTIVE PROCESS**.

As I have already mentioned, our **Svetilo (Jarilo)** had been **TURNED OFF** and **REPLACED** for **the Sun**. All the Planets were "located" with reference to the Sun with the help of the preformed connection tubes. The usual people's perception of the material world does not make it possible at first to take the word "turned off". There comes an association that something wrong had happened to the Sun. Had it exploded? Had it turned into a neutron star? Had it been stolen and swallowed by a crocodile, as in K.I. Chukovsky's poem? If it had been an explosion, the entire Planetary system would have perished. The transformation into a neutron star does **NOT HAPPEN fast**, and the gravitational forces of such a massive body just would have ripped the atmosphere off all the Planets. Even the notorious approach of **Planet X in**

2003 threatened the entire Solar system. There is one last option: ***the true system of the world, which is created by the atmosphere grating at the phase of light pulse at 0 was called Svetilo (Luminary)***. The paraphase speed is affected by the light parameters, color spectrum, brightness, flow density, the planet's code (for the Earth it is 512) and the distance from the sun. The octaves of the Original ECS were lowered, and since many principal systems of the Earth were captured by the invaders – they **HAD TO BE TURNED OFF**.

In search of a more complete understanding you can refer to another important source of information – **the book by N. Levashov "The Tale of the Light Falcon" – the past and the present"**.

"...our distant and not so distant ancestors called our luminary **RA** or **YARILO-the SUN!** In the same way our planet was called **MIDGARD-EARTH** and not just EARTH as we call it today! Because **MIDGARD** is the **WORLD** inhabited by **PEOPLE**. So for our ancestors ***the word "Sun" was not the name of our present Sun***, as well as "Earth" was not the name of our planet! Every planet, every star in those days had their own names, including the planet-earths and their suns which were distant for many light years. All the **LUMINARIES** and **PLANETS-EARTHS** had names that these celestial bodies were given not by our ancestors, but the inhabitants of those planets from distant constellations from which immigrants populated our planet Midgard-Earth in stages!" BY the time of capture, ***the world population had been 1.4 – 1.2 billion proto-Humans***.

This **IMPORTANT** and **KEY** information on the replacement of our Yarila (True Earthly light – White Light) for the Sun was first given openly in an interview with the candidate of historical Sciences, ethnologist, art historian, member of the "Russian Geographical Society" **Zharnikova Svetlana**



Vasilievna at the 2nd Vedic Congress in 2010. Unfortunately, Svetlana was gone in November 2015...

From **the writings of N. Levashov** it is known that for the emergence of life on the Planet, the following conditions are to be observed:

- the availability of constant differential dimension;

- the availability of water;
- the availability of the atmosphere;
- the availability of an alteration of day and night;
- the availability of atmospheric electricity.

This is true **for the origin and evolution of Life from the Beginning**. I emphasize, from the **BEGINNING** Without outside influence these processes take a lot of billions of years. Often Life has no time to develop up to Reasonable on one or another planet, not being provided with additional stability and protection – life support on the part of the Control System.

In the natural conditions planets are formed in the zone of the warped space at "the explosion" of the Super New Star. "In the process of the star compression the balance is upset between the radiating surface and the radiating volume. As a result, the primary matter is accumulated inside the star.

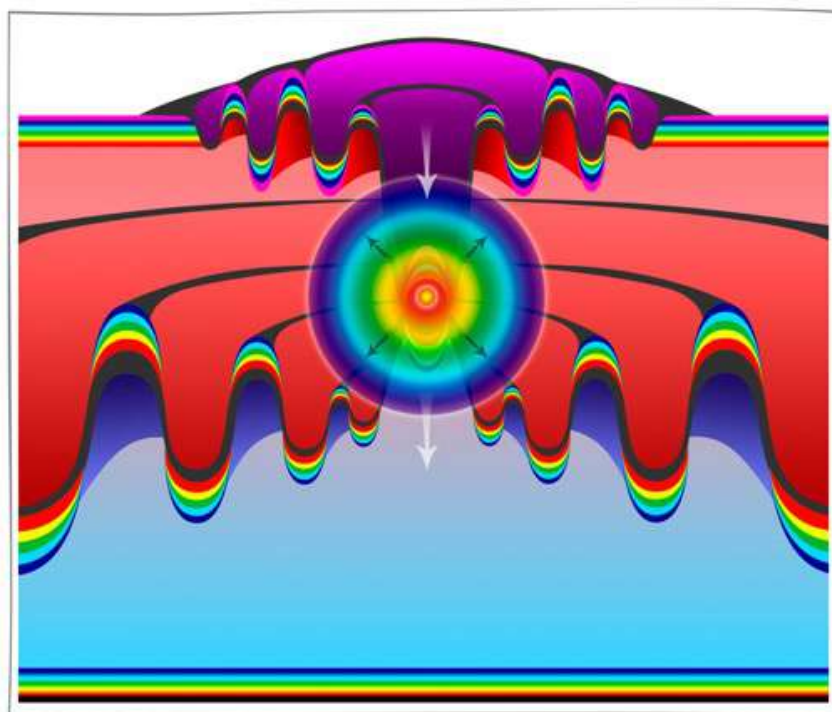

In the course of time, as a result of thermonuclear reactions, the star substance loses the simplest atoms such as hydrogen, helium, etc., and atoms of the heavier elements begin to account for a higher percent. **The size of the Star decreases**, it becomes more and more dense, heavy, and the degree of influence on the dimension of the surrounding space becomes

more and more powerful." The released matter of the star and Primary Matter are able to form a Planet of suitable size at a suitable distance from the source of deformation. All the Planets formed as a result of the Super New Star explosion settle down the planetary system not only in the Ecliptic plane, which is impossible to find in the Macro-Space, as it is unusual in its nature, but in harmony with the structure of the inhomogeneous space... According to materialistic views, the instrument observations, derived data and using computer models of stellar evolution "*the Sun will exist for another 5 billion years, **gradually heating and increasing in size.** When all the hydrogen in the Central core will be consumed, the Sun will be 3 times more than now. Finally, the Sun will cool, becoming a white dwarf.*" These are the conclusions of "modern scientists". However, I dare to disappoint them – it is not necessary to wait 5 billion years. Everything will happen (and already is happening) absolutely **NOT THAT WAY.**

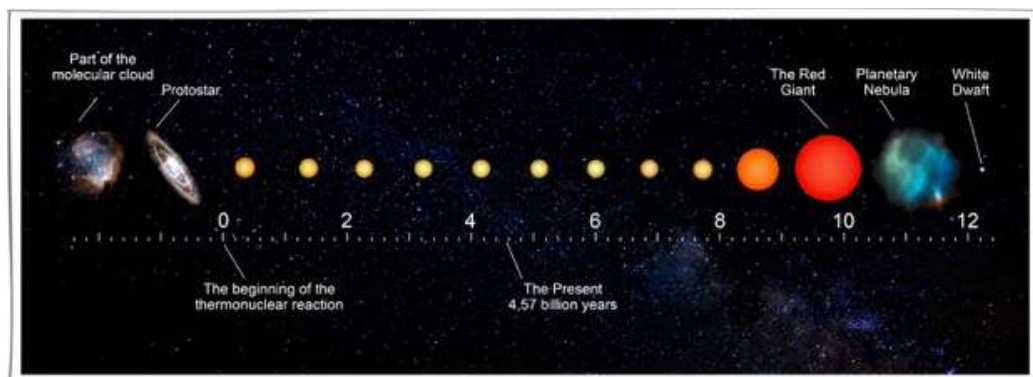

As you can see from the two descriptions of the evolution of the Sun N. Levashov's, and A. Khatybov's views and of modern science are **QUITE DIFFERENT**. We can assume that one of the sides is wrong. However, let's not jump to conclusions. **Nicolai Levashov in "Inhomogeneity of the Universe"** showed the process of matter formation and explained the birth of stars, their evolution and the formation of black holes or neutron stars. Astrophysics observe the particular Sun, and the observations show that the growth of the atmosphere of exactly our "star". But if the mass of the star compresses, according to the laws of gravitation no planetary nebula can be formed. There's something not consistent with the nature of the star itself. What could cause this anomaly? I will repeat myself in something, and draw your attention to the description of the Sun by **A. Khatybov.**

The sun is the planet that was "driven" into our System (with the Moon), the diameter of the Sun is approximately equal to the diameter of the Earth. It had the atmosphere thickness of about 2000 km, consisting of a

mixture of oxygen and chlorine. The sun is hollow inside, there is life only inside (as in the shell). There is everything necessary to support the life that the aliens wanted to create all over our System. In addition, it was necessary to replenish stocks, which there were on the satellites before the attack

Due to the abstraction of energy from the Earth a new atmosphere of the Sun has increased in size more than 100 times (the diameter is 1392000 km).

Current approximate structure of the Sun atmosphere

Nº		Layer thickness
1	Mixture of hydrogen and helium, tº about 3000º	19200 km
2	Grating Frequency 53,375, potentials density 127,4, body 111	332000 km
3	Grating Frequency 53,875875, density 121 and 100	128000 km
4	Grating frequencies of oxygen and chlorine, density 100 and 100	63000 km
5	Grating of protection 49 octave, density 100 and 100	146000 km
6	Hydrogen grating, octave 36,5, density 75 and 75	2000 km

The Sun has the frequency Converter. Receiving energy at **49 of the octave**, they transform it into 53,375, supporting radiation grating. The surface temperature of the Sun does **NOT EXCEED** 20 C. 49 octave was pumped out of the Earth (the Polar Lights) by means of special objects on the Earth.

The sun is a gravito-magneto-electric Generator of the motion of the entire Solar system. The sun is the beat Generator of the motion and this Generator is interfaced with the Life Support Systems of each planet. And there is no need to listen to the professor of the Hydro-Meteo-Centre, informing us that the cyclone (anticyclone) brought the temperature. This is a **LOCAL CHANGE** in the electrical parameters of Hartman frequency spectrum resulted in the macrostructures movement (the atmosphere). But back to the sequence of events.

1.8. The takeover of the planet of the Earth

18300 years ago the takeover of the planet of the Earth was carried out by the forces of the remaining Star fleet of the invaders. All the structures of the life support of the planet's Brain were annihilated, and it lost its potentials to the level of 3%, which further resulted in the elimination of all the inhabitants of the Earth in the short period.

At the same time, the following events occurred:

- the annihilation of the true Complexes of the Earth Control located on the surface;
- formation of the areas of paradise for the invaders' existence;
- annihilation of the life Support System on Mars;
- turn off the life support system of the other planets;
- formation of the system of satellites around the planets;
- the beginning of the structure transforming the captured planets.

The Earth Brain prior the **ATTACK** had had the **512 octave**. The planets-invaders' **Brain** was of the **224 octave**. Subsequently, for a number of reasons of incompatibility under the new conditions of the Earth, this invaders' Brain up to the 66 octave **WAS ANNIHILATED**. The remaining structures of the Earth managed to keep the Brain of the 57 octave for a short time (mainly in the Equatorial area). With the further reduction of its level, the population decreased by 67-68%, and there were only **about 2 million people** with their subsequent dying out.

The Easter complex as one of the true main complexes of the escort (located under Easter island at $h=-12450$ m) was completely off. After a series of the Program processes on the part of the interventionists ***Man was transformed into a kind of biological being, deprived of the former independence of the Brain.*** This is the foundational information that makes it possible to understand all that happened afterwards, up to the present day.

What is this program link with the Sun, the moon and the planets satellites like? What part did it play in the overall evolution processes of the human Civilization and conscious evolution of an individual and public, in particular?

Technically, this link looked like **a SPECIFIC SET** of the **FORMED** "Link Tubes" with the Earth, on the one hand, and the Moon, the Sun and the planets Satellites on the other hand. By means of such link tubes it was carried out the transfer of information from the invaders' generating and Control systems ***placed beyond the Earth, to the complexes of the same Control System, placed on the Earth.*** This program information contained everything required for the control the entire imposed development of Civilization at a conceptual level.

First and foremost, it is through this connection it was ordained the **FORCED RETENTION** of the people's performing actions in their applications in the same way as consumer goods in all the program processes controlled by the interventional System, and, accordingly, step by step

preventive development of an individual and public conscious before every historic eventful executive step. Using the same information, the Conceptual level Control of all the processes of energy being in general in their changed structural state was executed. Monitoring and protection was formed to prevent any structural changes in the energy gratings by the true Earth complexes, the retention of such complexes in "captive" state and so on.

The Earth was populated with people that were differed in biology. Therefore, the decision was made **to ANNIHILATE the EARTH BRAIN and transplant the Brain of spiders into people (their biological structure).**

Since that time, especially in the last **4000 years**, the **interventional Super-system**¹⁶ using the changed System of the surrounding structures have conducted a great deal of process monitoring (including all life-support Systems, the Earth Biocenters that create and support the Man) and **DIRECTLY the MAN HIMSELF.**

For these purposes, the invaders put into operation the Program of **"Energybiogenesis of the flesh cells,"** which was becoming more substantial in the reinforced attempts to create people (like a kind of proto-Human), for the spiders' **FLESH** (which were the invaders) was **IMPERFECT** and unacceptable to get "the entrance to the Hierarchy of Civilizational evolution of the Intelligible orientation" (as, however, and the design of their Brain, too). This was ultimately one of the reasons for the **TERMINATION of THIS KIND of EXPERIMENT** and **the beginning the process of returning to the starting "point"**, what is actually happening today before our eyes. Who realizes it and how it is realized is of less importance. Of primary importance is what is happening, and no one and nothing are able to stop the process.

1.9. Available Means

If You are left in a boat in the middle of the ocean, You **WILL NOT** study the structure of the boat and the method of fixation the frames. First and foremost, using all available means, you will try to determine your whereabouts and then sail in the direction you got to know. Exactly so did

¹⁶ Interventionist- super system -is the Program connection with the Sun, the Moon and planets satellites.

those who arrived in the Earth several thousand years ago. First, the coordinates were defined, the "milestones" were set and the conditions created to move the entire System (like JOHN Swift's Gulliver, who dragged the ships) in the **RIGHT DIRECTION**.

A special place in the "ancients" studies belongs to **the Big Dipper**, which is described in detail by **N. Morozov** in his multivolume work "**the Christ**." In addition, on the Earth it was built (there is no clear answer what for) quite a lot of pyramids, and in the process of more exact definition of their coordinates, many of them became unnecessary (the pyramids of Maya, the pyramids in Ecuador, etc.).

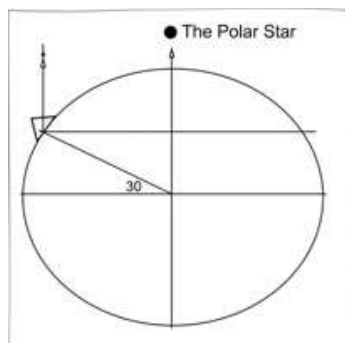

The calculations show that the pyramids were set up as a **SYSTEM** of **CONTROL** on the ways of the Power Lines of the Earth's Complexes. The Ecuador pyramids' ramps pointed to Benethash star of the Great Bear. All the pyramids were built not on a randomly selected place and, of course, the calculations were made not on the sand. The calculation accuracy of some constants is **up to 124 signs** (determined by indirect calculations, when the ratio of dimensions lead to a constant) **AFTER** the **DECIMAL** point.

So **the first conclusion**. Upon arrival in the Earth, that had already had its own civilization, **Ebrs** (aliens, after N. Morozov) first marked their location by doing layout work and putting stakes, besides using the UFO's computer system.

How the Solar System was deployed and where it is moving today is a separate issue? Let us consider one of the most important systems of the control – **Cheops Pyramid**.

Many Scientific works (as to pyramids in general) were devoted to Cheops pyramid, and all of them stated the existence of the pyramids, piling theory of their construction, as well as derive practical results by dragging the mummies from pyramids to museums.

Many deaths of the pyramid researchers are ascribed to the "curse of the pharaohs" of those who disturbed their peace. We see only the **IONIC PART** of the **COMPLEX**; to explore non-inertia mass of the pyramids the Humankind has **NOT** yet **DEVELOPED** the instrumental base. Here are **A. Khatybov's** calculations, only a small part of which has become public today.

The Pyramid of Cheops

Looking ahead, I would note that the Pyramid of Cheops is located on the territory with coordinates **30° N.L.** and **30° E.L.** and the north side of the pyramid facing North, precision 2'.

The first pyramid with the inclination of **52°** and the entrance angle of **28°**, where the North Star was visible was the pyramid near Medum. It is destroyed (It is thought – by an earthquake). Its dimensions were smaller than of the later Cheops.

The desire to keep the **angle of 52°** and the slope of the entrance with visual surveillance of the North star is not accidental. Besides, the correlations of some values indicate the angle of inclination of the pyramid side.

Let us make a circle with radius $R=h$, i.e. equal to the pyramid height (h).

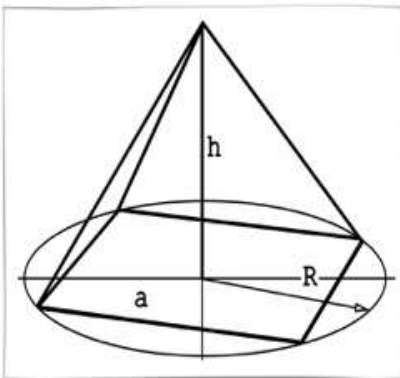

correlation:

$h=146,75$ m;

$a=230,62$ m;

$R=146,75$ m;

$$\frac{\pi * R^2}{a^2} = tg(51,84^0)$$

The second conclusion.

During the construction of pyramids, the used system of physical units remained secret. Translations into the existing measurement system do not give any idea about the meaning and purpose of pyramids.

Some of the correlation values in Cheops pyramid point to the existence of a hidden (maybe, the main) pyramid, the exploration of which with modern technical means is impossible.

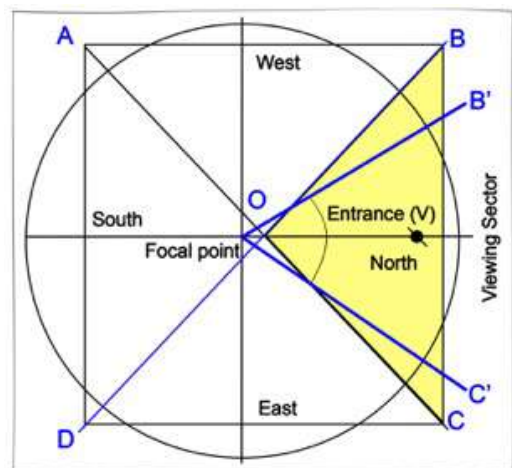

Let us consider Cheops pyramid from the point of view of the Control System (Cheops pyramid is the control data transmitter for the Earth Motion Control System and for the Solar System).

Index SU FS and SS=555 (from the command texts).

Parameters of Cheops pyramids:

Side: $AB=230,62$ m;

Height: $OG=146,75$ m;

The height including the cut: $SG=138,38$;

Side: $OA=219,38$ m;

The side projection OA (AG)= $163,07$ m;

The plane inclination angle = $51^{\circ}84'$;

Entrance height = 18 m;

Volume (without cut top): $V=2601238$ m³.

The contour of Cheops pyramid encloses the other Pyramid, which is the principal one.

The great pyramid has some structural features: Southeast corner is higher than the North-West by 2 cm.

The size of the entrance is **rigorously calculated** (see below).

The deviation of the sides = $3,6'$ (orientation to the parts of the world).

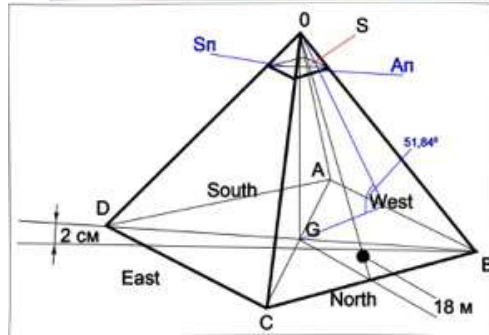

Angle AOB=63,4°=63025'

$$2 * AB / OG = 2 * 230,62 / 146,75 = 3,1430;$$

Side of the site $A_{\pi} = 13,15359 \text{ m};$

Site square $S_{\pi} = 173,0169419885 \text{ m};$

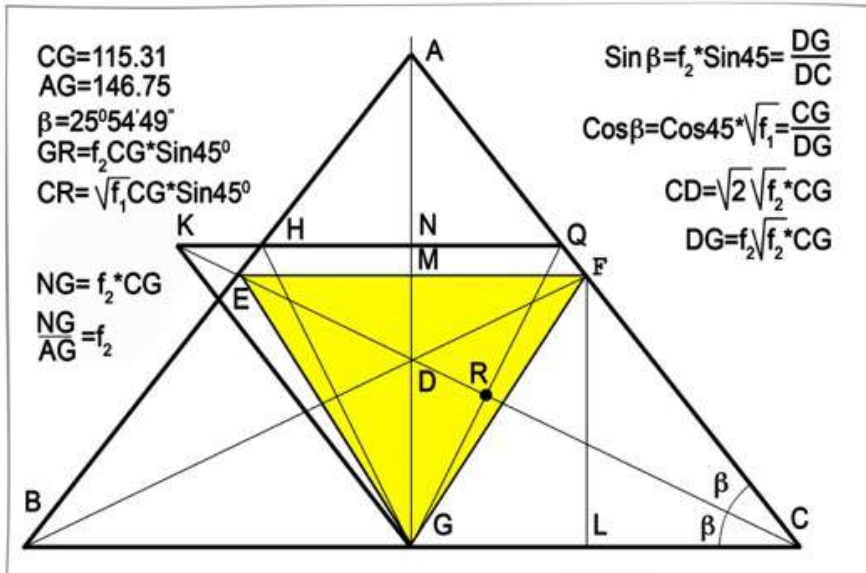

In compliance with the Golden section we have:

$$\frac{CG}{AG} = \frac{115,31}{146,75} = \sqrt{f_2}$$

Angle $\beta = \text{FCK} = \text{KCG} = 25^\circ 54' 49''$;

Angel $\text{FCG} = 2 * \beta = 51^\circ 49' 38''$;

KQCG – full rhombus.

It is the rhombus that forms the spiral of the Golden Ratio, the format of the rhombus is laid in the angle of inclination of the pyramid plane. The height of the pyramid is offset by 6° towards the South of the ratio:

AB=230,62 m	CS=71,27	MG=113,9	NG=FG = 128,82
AC=115,31 m	AS=44,04	OA=186,63	OE=128,56
OC=146,75 m	S'G=174,00	MQ=132,36	CS/AC=0,618
OP=173,05 m	FP=18,188	FM=58,00	$4 * \text{AC}/\text{OC} = 3,1430$
OF=174,00 m	EG=101,02	OM=116,00	OM/OF=0,6666..
OR=264,00 m	EE'=13,512	GA'=18,188	FR*OM=100*AB
FR=198,54 m	GE'=114,53	ON=MN=FM=58	

Point S' is diametrically opposite to the point S.

Angle $\text{BFC} = 67,5^\circ$ – viewing sector.

$\text{SIN } 6^\circ = 0,1045284$.

$\text{COS } 6^\circ = 0,9945219..$;

$\text{TG } 6^\circ = 0,1051042..$;

angle $\text{OAC} = 51,840$;

angle $\text{FOP} = 6^\circ$. the pint F – focus, the line **with reference to the Earth gravity centre.**

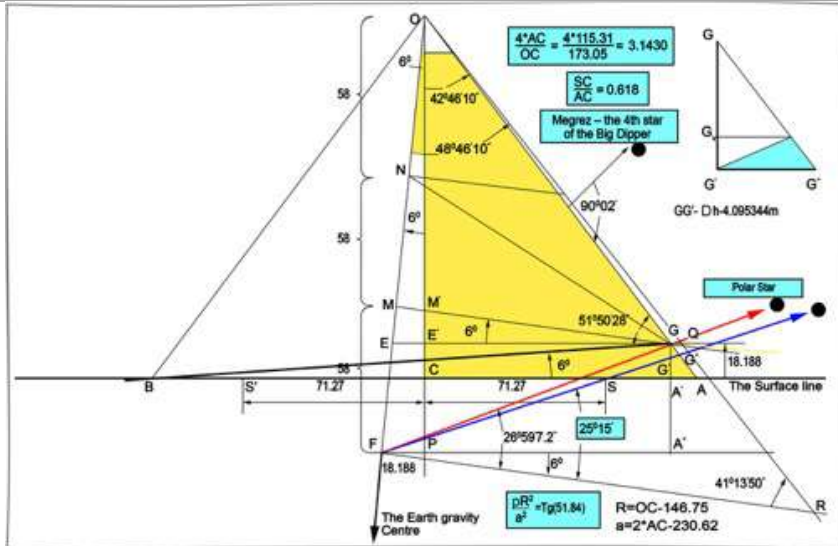

angle $FRO=41.230577^\circ$;

$\text{Sin}(41.230577^\circ)=0.4537626$;

angle $G''FR=26059'7.2''$ (26.985347°);

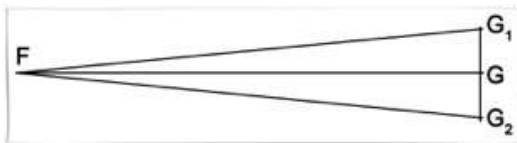

The angle $FOP=6^\circ$. Point F is the Focus, the direction of the line **to the gravitational center of the Earth**.

$\text{Угол } FRO=41.230577^\circ$;

$\text{Sin}(41.230577^\circ)=0.4537626$;

$\text{Угол } G''FR=26^\circ 59' 7.2''$ (26.985347°);

GF is a cone, the star comes out in the funnel at $12'$, $G_1G_2=0,4461769$ m. The line G_1G_2 is divided into 6 parts, Medrez passes one section for 144 steps of transmission, that is 2 minutes.

If the ionic grating has 32,22502250 communication structures, hidden pyramid has the grating 53,625. By the way, **EXACTLY** in this pyramid the "curse of the pharaohs" is laid – frequency radiation (gamma rays).

Angle $GFR=25^\circ 15'$ exactly this line (or rather the angle $25^\circ 15'$) determines the inclination of the equator to achieve 0 albedo, and cannot be violated in connection with the complete imbalance of the Control System.

Parameters:

$EG=101.01863$ m;

$FA'' = 119.21 \text{ m};$

$G'a'' = 41.628819 \text{ m}, GA'' = 45.724163 \text{ m}, GG_v = 3.2125163 \text{ m};$

$GA'' - G'A'' = 4.095344 \text{ m};$

$Tg_{25.25} = 0.4716306;$

$Tg_{19.25} = 0.3492156;$

$Tg_{20.985347} = 0.3835706.$

The sequence of passing the world pole:

π, η Hercules;

τ Hercules (VIII-VII BC);

ι Dragon (5500-3500 BC);

α Dragon (Tuban) 3500-1500 BC.

β Little Dipper. (COHAB) 1500 to 1 BC;

Cohab, and Cynosura Little Dipper. (Guards), when the world pole was between them;

α Little Dipper. (Cynosure) 1100-3300 BC;

(Guardians were announced β and γ Little Dipper) Cepheus (γ Albano) to 5000 BC (β Alfaro) to 6500 BC (α Alderamin) to 8500 BC;

Deneb, and Sandr (γ Swan) VEGA (α Lira) in 13000 BC (6th time);

Polar (α little dipper – Cynosura) will pass by the pole of the world with accuracy at $27'$ in 2100r.

Since the world pole walks about the constellations, then, together with it there occur changes in the location among the stars and of the celestial equator, and the point of the vernal equinox from which the celestial coordinates are measured.

The precession cycle of the Earth's axis is the Platonic year.

The third conclusion. The Solar System motion to Megrez star is on Archimedes spiral.

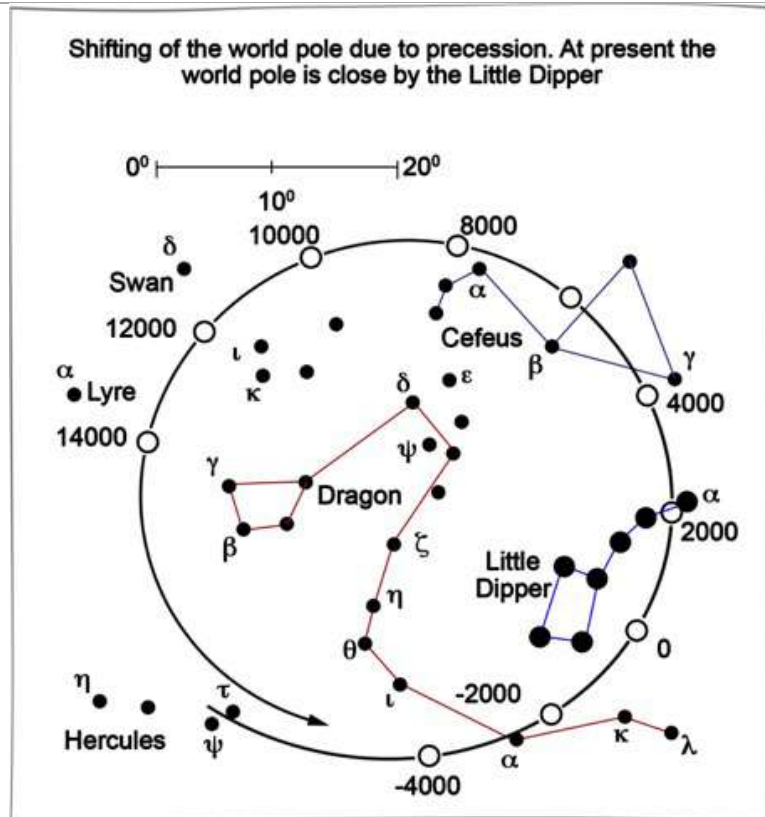

CALCULATIONS on Archimedes spiral has **ALLOWED** to find out the Ebrs arrival time in the Earth, and the uniform rotation of the world pole while moving on Archimedes spiral is incorrect.

The fourth conclusion. Ebrs appeared on the Earth approximately 18300 years ago, annihilating the Brain of the previous civilization.

Back to the pyramid of Cheops. First of all, some correlations:

$\beta = 23^{\circ}27' = 23.45^{\circ}$ – the equator tilt to the Ecliptic plane;

$\gamma = 5^{\circ}08'43.4'' = 5.1454^{\circ}$ – the Moon equator tilt to the Ecliptic plane;

$\alpha = 28^{\circ}35'43.4'' = 28.5954^{\circ}$ – the total angle.

For 1 year (365.26 days) the Earth passes a distance $L = 149.6 * 2 * \alpha * 106$ km = 939964520 km;

Speed $V = 29.785678$ km/sec;

$V_{\text{vert}} = 14,256062$ km/sec;

$L_{\text{vert}} = 449887100$ km.

The sum of the angles (the direction to the Polar star of the pyramid plus the inclination to the Ecliptic): $46^{\circ}54' = 46,9^{\circ}$;

The angle of inclination of the plane of the pyramid $51,84^{\circ}$;

Difference $= 4,94^{\circ} = 4^{\circ}56,4'$. The difference with the Moon $= 0,2054^{\circ} = 0^{\circ}12'19,4''$;

Distance $AB=L=939964520$ km;

Distance $AC/2=131352001$ km (the distance to the Sun, or 1 astronomical unit).

The solar system moves in a spiral. In this system the Earth moves in a double spiral (the revolution around the Sun and rotation together with the Solar system).

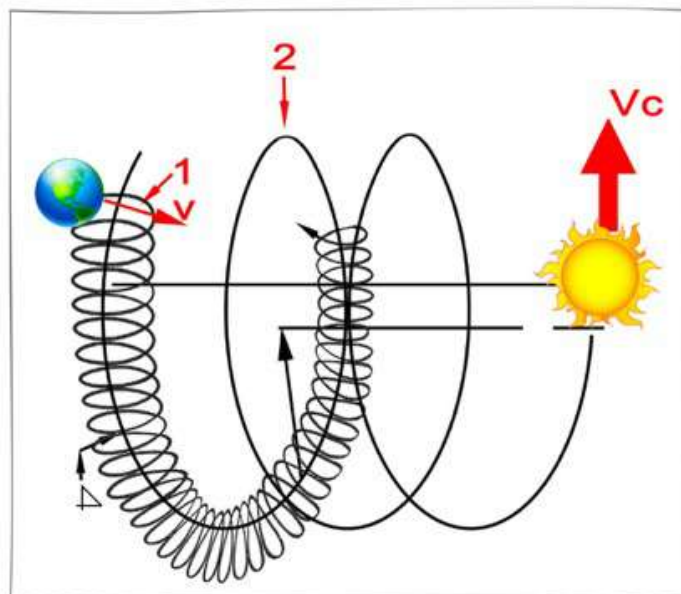

The Spiral of Archimedes

1 – The trajectory of the Earth in rotation around the Sun;

2 – The trajectory of the Sun.

According to Astronomical observations, the Solar system has been changed 5 times for the Polar star, but how and why science has not known.

The distance between the turns of the spiral $= 2 \cdot p \cdot S_{\text{vert}} / w$;

$w = 28.59540 = 28035'43.4'' = 0.4990838$ rad;

If we take $w = 28.647890 = 0.5$ rad, then the difference $= 0.0524897$ rad $= 3'8.96''$

The accuracy of the orientation of the compass at the pyramid of Cheops = $3.6' = 3'36''$.

For the precise orientation it is **NECESSARY** to change the angle of inclination to the Ecliptic that is why the second (hidden) pyramid is needed. This pyramid is with the floating geometry (up to the 54 octave). If the angle is constant, we have the logarithmic spiral.

Some oddities

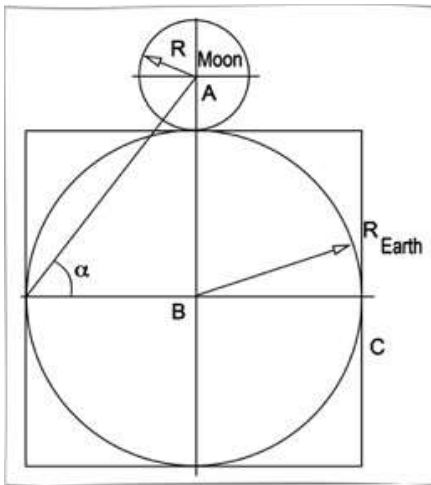

The Earth Radius $R=6378$ km;
 The Moon Radius $R=1738$ km;
 $R_{Earth}+R_{Moon}=AB=8116$ km;

$$\alpha = \arctg\left(\frac{8116}{6378}\right) \approx 51,50267^{\circ}$$

Inclination angle of the pyramid plane = 51.5040 ; $4 * C = 8 * R = 51024$ km;

$P = 2 * 8116 * \pi = 50994.331953..$;

The difference = 29.7 (within the limits of the calculations error) Ratio of the surface square (round the Earth) to circle square with radius AB $D=0.78631...$, и $\text{Arc sin}(D)=51.840$.

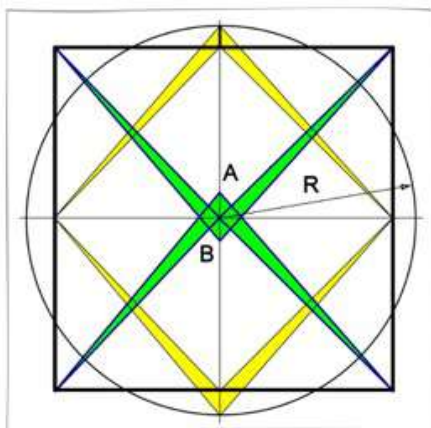

Mason Cross (a pair of compasses).

Circle and square perimeters are equal.

$R=f_2 = 1.618...$ $C=2 * R * \pi = 10.1664...$

Square side $a = \frac{2 * R * \pi}{4} = \frac{R * \pi}{2}$

$a=2.5416017...$ (Inch);

$\frac{a}{2} = 1.2708..$ $AB=0.6944678$.

Inch is obtained from the problem «circle quadrature».

$\frac{a}{R} = 0,7850258..$ $\alpha = \arcsin\left(\frac{a}{R}\right) = 51,757927..$

Roughly CHEOPS pyramid angle. Calculation accuracy might be any. Inch value does not depend on the quantity.

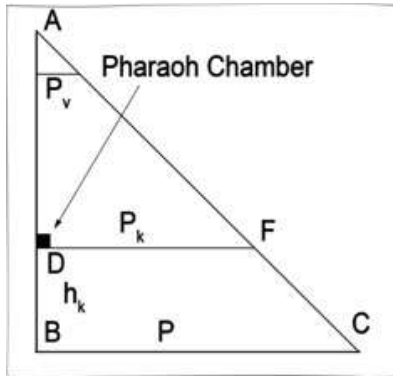

$$\frac{P_K}{P_V} = 6,1988$$

$$\frac{P_K}{h} = 0,555614874105621$$

Pharaoh Chamber – surface section = half surface of pyramid base.

Pyramid base $S=53185,5844 \text{ m}^2$

Surface at Pharaoh Chamber level –

$S_k=26592,7922 \text{ m}^2$;

Half side of the base – $P=115.31 \text{ m}$;

Half side of the cut – $P_k=81.5364829 \text{ m}$;

Pharaoh Chamber is at the height of –
 $h=42.98207986 \text{ m}$;

Reverse value $\frac{P_k}{h}=1,79980782565739$;

Value of 0.555 is of primary importance in Genetics. That is the code of the complex as well.

All 3 pyramids are on the spiral of the Golden section.
Sphinx's gaze is directed at Sirius. It became known only about 1985.

Path extending from the third pyramid is directed exactly to another point in the proportion of f_1 on the large side of Golden Sectioned rectangle. If you cut the rectangle vertically this line runs exactly along and parallel to the plane of the vertical pediment of Sphinx headdress. If you **EXTEND** the

LINE of the south base of the second pyramid, it touches the Sphinx's right shoulder, marking a special place.

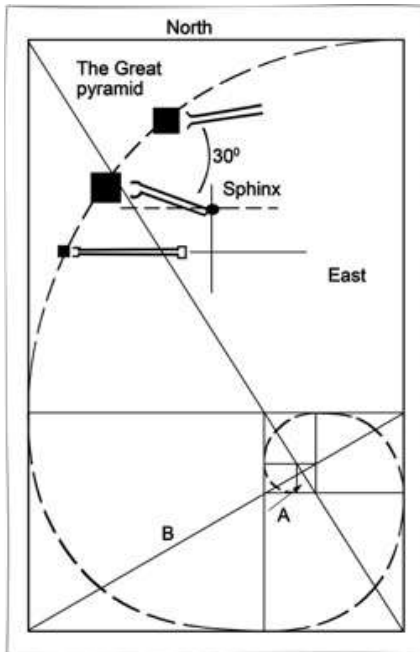

The central line that is equal to the long side of the Golden Sectioned rectangle and **EXACTLY PASSES** the front edge of the headdress. In other words, the headdress marks the exact center of the longitudinal direction of the Golden Sectioned rectangle, proving that Sphinx is placed in the sands not accidentally.

Why the line B is marked? The astrological wheel was taken with reference to the North pole and placed on the line with Cairo. The end of the line appeared to be at a special place on the planet of Earth – the area of 4 corners in the United States – the border of the states of Utah,

Colorado, New Mexico and Arizona. For the Indians the area of the 4 corners is marked with four mountains. The angle of inclination of the plane of the pyramid (calculation) is $51^{\circ}51'24''$.

If the pyramid is built correctly, it will pump water without any moving parts.

If we drew a circle on the Earth, its diameter would be 4 km (2.5 miles). It was believed that East is the direction where the pyramids and Sphinx are faced, but this is incorrect. Three oriented East **PYRAMIDS' FACES** are on the lines converging at one point on the horizon (on the arc). The point on the horizon is the point of helioarcic rising of Sirius, which is located not directly in the East.

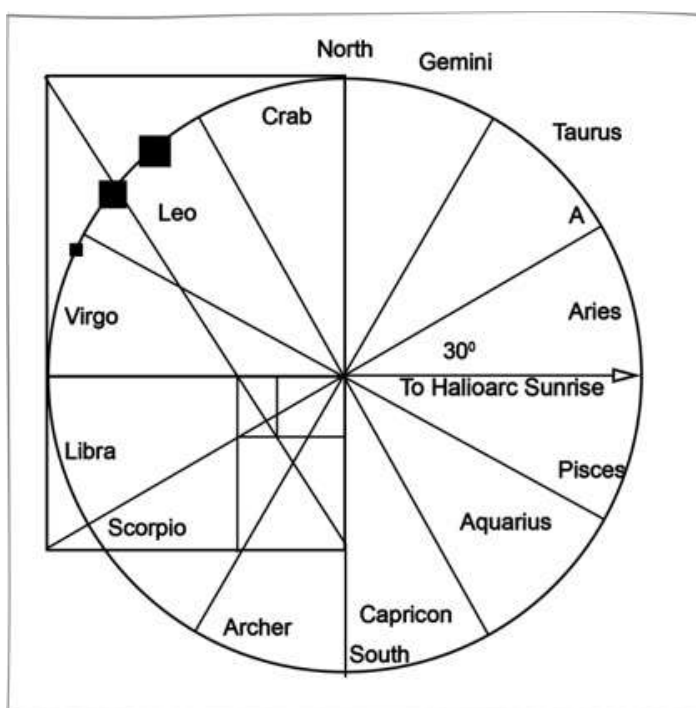

On July 23, Sirius rises one minute before the sunrise and at that moment, the Earth, the Sun and Sirius **MAKE** a **STRAIGHT LINE**. The eyeballs of Sphinx are gazing at the same place. The 12 sectors are the wheel of time. The three pyramids were placed on the Earth exactly according to the three stars of Orion. Deviation is $3.6'$ due to the orientation.

Pyramids are in the constellation of Virgo and Leo. If from the vertices, angles, etc. extend direct lines through the center, it will point to the range of accurate dates between Aquarius and Pisces, that is, for the period of time in which we live – the Age of Pisces transiting to the Age of Aquarius.

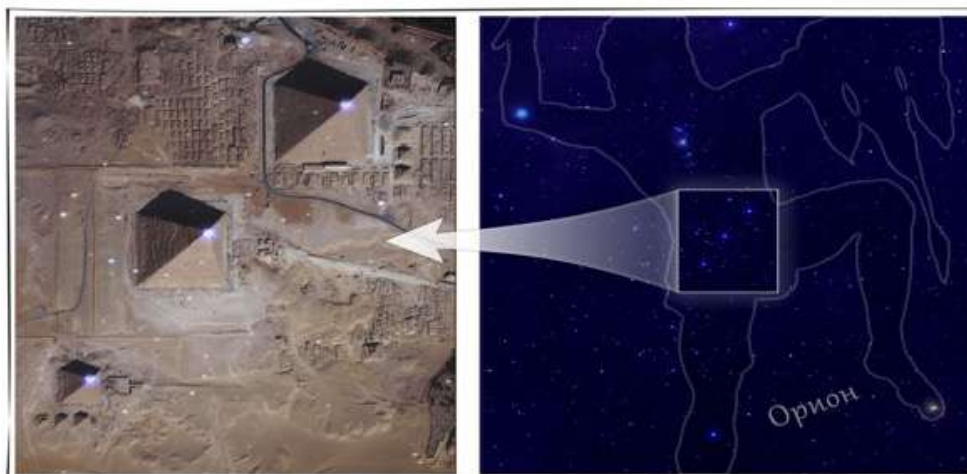

It is appropriate to mention some "tales, discoveries, speculations, and nonsense," etc.

The DOGON TRIBE in the district of Timbuktu (Mali) where there are rock carvings of fish, of Sirius A and Sirius B (revolutions around Sirius A), descriptions of Siriuses. The Information was confirmed **in the 1980-ies**. The Dogons knew what Neptune, Pluto, Uranus look like when approaching them from Space. On the rocks there are carvings of the paths of Sirius A and Sirius B for the period from **1912 to 1990** (confirmed by calculations). In Africa, where the Dogons live, the ***Sirius Star disappears from the horizon*** and is out of sight for a couple of months, and then in the morning of July 23, again appears in the sky for a moment before the sunrise – ruby-red, shining, almost **EXACTLY IN the EAST**. After 60 seconds the Sun is rising – it is a heliacal of Sirius (in the rays of dawn). At this point, Sirius, the Sun and the Earth are aligned on the same line.

In many **TEMPLES** there is a tiny hole in the wall, there is a similar small hole in the other (opposite) wall and so on until a certain dark room. There is something like a cube or granite rectangle of Golden section, located right in the centre and having a small mark. At the moment of the heliacal rising of Sirius ruby-red light falls on the altar for a few seconds, which means the beginning of a new year and the first day of the Syrian, or Sotichic calendar.

It is established that the **SOLAR SYSTEM MOVES** in Space helicoidally, in an elongated spiral which is a close relationship with Sirius.

Not only the Dogons, but the Sumerians knew about all the outer planets: – what the Solar system looks like when it is approached from the

Space. The Sumerians described the relative size of different planets as if they flew past them in the Space. They described what the planets looked like, what color they were (3000 years BC). They knew about the equinoxes precession. They knew that the tilt of the Earth's axis to the plane of the orbit around the Sun was 23 degrees and that it made a full rotation in a circle over a period of 25920 years.

Between Mars and Jupiter THERE WAS Tiamat planet (or Phaeton, destroyed during the capture).

Every **3600 years**, the planet Marduk (Nibiru with the Sumerians) enters the Solar System. This planet, that "flew into" the last time, became a real threat to the Earth. Its trajectory has been changed by N. Levashov, having described the events in his book. The movement of the planets is usually between Mars and Jupiter.

The third planet, coming out of Sirius B (Oceania), is home for whales and dolphins. The planet is completely under water.

All pyramids are **LINKED** with the **STRUCTURE**, made in line with the spiral of the Golden section.

From Ushmal (Yucatán Peninsula), it was laid down 7 churches, similar to 7 structures along the Nile. From Ushmal to Labna, then in Kibu, further to Chichen-Itza, then to Tulum near the ocean, and then descends, passing close to Belize and Kohunlich and then turns along the mainland to Palenque. From Palenque the structure is divided, going North and South.

To the South up to Tikal in Guatemala (the beginning of a new octave). In the end the spiral passes such places as Machu -Picchu and Sacsajuaman near Cusco, in Peru. One of the main spirals ends in a place called Chavin in Peru (where there was **THE MOST IMPORTANT** religious center of the Inca Empire). From there it goes to the Titicaca lake to a point half a mile from the Sun Island (Bolivia), and then makes a turn of 90° and goes to Easter island and finally to Moorea, where it goes into the ground. This structure is called "**women's component of the grating**". This is the information structure that runs along the base complexes of the Earth. It is intended for the control.

The "male component of the grating" moves to the North of Palenque. It passes through the ruins of the Aztec Empire and up to the pyramids of American Indians (Albuquerque, New Mexico State). Then the spiral runs to the Blue lake near Taos (new Mexico), which is the very image of lake Titicaca. This is one of the most important areas of the United States, which

had been protected a long time by the Indians of Taos. Near the Blue lake again is makes 90- degree turn. From there the spiral moves along the mountains, passing through Ute mountain (near the border with Colorado) and other mountains and artificial structures. Before leaving the California coast, the **SPIRAL PASSES** through lakes Tahoe and Donner and the lake of Pyramids. From there through the underwater mountain range it runs until it reaches the Hawaiian Islands, where one of its main components is the Haleakala crater, and then again turns South. It goes through the chain of the Hawaiian Islands, that stretches for thousands of miles all the way to the island of Moorea.

It's an **ENORMOUS UNCLOSED CIRCLE** that goes around the Earth, from Ushmal (forming a perfect spiral clockwise and counter-clockwise) to the island of Moorea in the South of the Pacific ocean.

A few pyramids were built by Ebrs in Tibet.

The fifth conclusion. During their stay on the Earth Ebrs (the Sumerians, the Dogons and others) interlocked the Life Support Systems of the Earth, creating **CONTROL SYSTEM** on the tracks of the power lines to prevent their use.

The sixth conclusion. To control the movement of the Earth in the given direction Ebrs used their own structures and objects, providing them with some artificial structures of control shaped like Cheops pyramid.

Under Sphinx there are 9 crystal vases enclosed one into another (theoratically).

The Museum of Oriental Culture (Tashkent): 9 balls, nested in each other. The balls are not detachable, all are visible..

Asoka Emperor, India from 273 BC –the society of the unknown 9 with encoded names:

1. The technique of war propaganda and psychology .
2. Physiology.
3. Microbiology.
4. The transformation of metals.
5. Means of communication – earthly and unearthly.
6. Gravity.
7. Cosmogony.
8. The properties of light.
9. Sociology and the laws of the evolution of societies.

Each of the 9 members of the society possessed the book, in which there was enclosed and continuously updated knowledge in a particular field of science. By the way, 64 methods of enciphering the texts **WERE KNOWN**. In addition to the function of the marker Cheops pyramid performs the communication function.

Let us consider the platform at the top of the pyramid as the norm for a regular pyramid, as well, and we get: the angle = 20,9051550°. is the angle in the dodecahedron (a dodecahedron vertex, the center, and half the edge)? Taking into account that the Earth's atmosphere is of the external structure of the dodecahedron, this pyramid is the pyramid of communication.

Communication octave is 51,125125.

The pyramid contour is the radiation grating of the 53,375 octave.

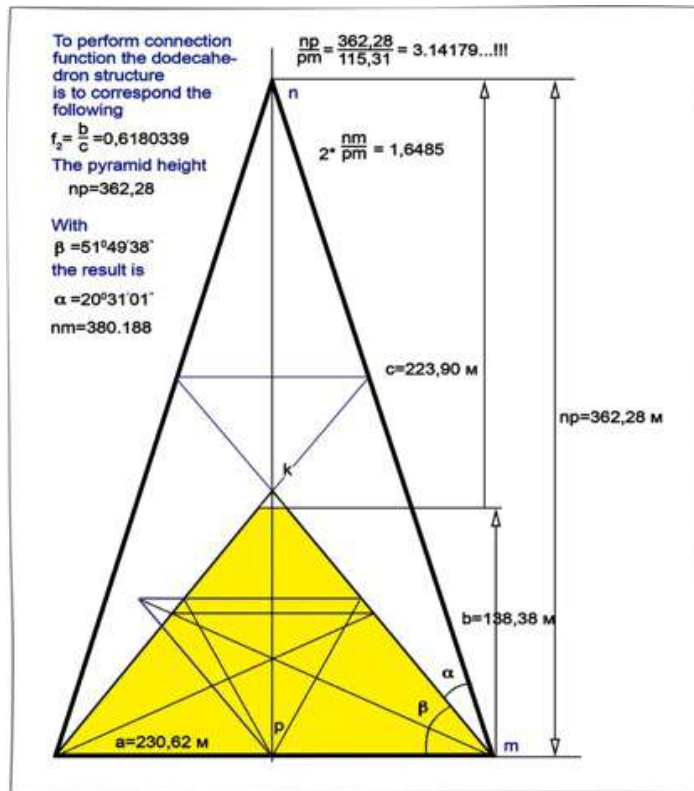

In contrast to the orientation grating that has a variance of 6' to the South, the pyramid of communication is strictly on the axis of the ion pyramid.

Pyramid orientation has the structure of 53.625. There are **NO DEVICES**, determining this frequency, but it is biologically perceived. The

pyramid is designed to operate in the original structure of the atmosphere (the dodecahedron). ***I am drawing your attention to it.***

At the starting point, the site of the great pyramid, we have got the Golden pyramid. Taking into account the inaccuracy of the input data (dimensions), however, we got the result that indicates not only at the meaning of the great pyramid, but at the fact that those who built it and made the calculations were not the ones who ran around with bows and arrows.

The Golden pyramid: $NM/2 \cdot PM = 1,6180339\dots$ and that is what refers it to the communication system. For thousands of years ion structure has changed, but strict compliance is supported even today, thanks to the radiation contours.

Now, based on this information, look at things more close to us in location.

The Church

As long as the time of the creation of the Earth **8640000** meridians **WERE LAID** (in science they are called magnetic meridians), about 1000 meters deep. They are energy cords. Only frequencies of low octaves have been measured (below the 42 octave). But these meridians are the conductors of high octaves as well; there are no instruments to measure their power, but the effects of their presence manifest themselves. In addition to the meridians, there is also a spiral; in the nodes of the meridian- spiral Hartman, Curie and Roentgen nodes are formed. Curie's are nodes of high

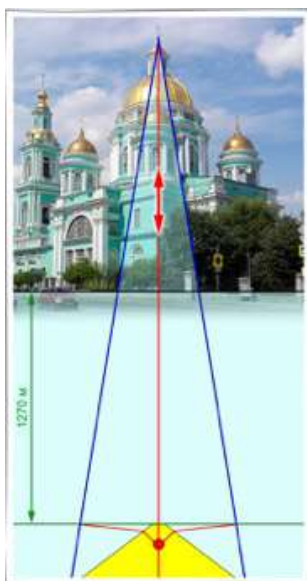

tension. If a terminal is put up over such a node, then within a certain range of the node there will be potentials increase of the atmosphere grating. If you add a little "stink" (light candles), a Human Brain can get something out of the atmosphere, for example, **NEW KNOWLEDGE**. There is also an opposite effect – the Brain is cleared of all the information.

Since the input of the frequency control for a particular genotype of the Brain (since 0 year) on the Earth there began building of a great number of terminals: churches, cathedrals, mosques, Buddhist temples.

Note that in Curie node there is **HIGH DENSITY** potentials in the frequencies of all octaves from 16 to 128, but a man perceives only the

62 (where to run or who to vote for). Today **66, 68, are the current Program for the Brain** (remember that). Frequencies of the octaves related to non-inertia mass are higher than 70. In the time of their materialization in the frequency **of 28-32 octave there might be tears on the icons**; that is, on certain material carrier, which in its structure has lead, sulfur and some other components. It has nothing to do with the divine miracles – take a wet towel and shake it at the **MOMENT** of **OCCURRENCE** of the next "miracle" – **you will get a shower of sparks**. If such a shower is manifested on a large area, expect to have an earthquake. This is not a miracle. So that all the "sheep" got all that is provided for them in due time, places of worship were designed and built for them. **Not** a single church representative **IS ABLE** to explain to you why **Church domes are shaped like onion, they take it for granted**.

All existing churches are **NOT** built by **ACCIDENT**. Control system is a pyramid, the apex of which is the Church. The location of the Church is not accidental – the top (the apex of the dome) is exactly aligned with the axis of the pyramid.

This applies to both the Orthodox churches, Catholic cathedrals and the minarets (of the mosques).

The Church is a double – action pump. In the time of reading the information (during the holidays) the arrow is down (the spiritualized leave the church). When the information is recorded with an arrow up – the release of waste and old information through the point (glowing clouds above the Church with a large gathering of people). **PEOPLE LEAVE the place** with new information and begin to execute what has been recorded. All holidays and all the days of the information withdrawal are scheduled **to dupe, with the reference to the divine and Holy events**. In the first place ministers of religion get the information; therefore, the selection of the clergy is not accidental. You might be extraordinary intelligent but at the main event you remain on the sidelines. As the **INFORMATION COMES** through the Church, it is considered to be the foundation of everything: morality, science, and all that is prescribed in the program. The **SHAPE** of the dome is **ONION**; the cone is also non-random. If there is no pumping up from the bottom, the shape of the ONION or cone contributes to the removal of the potentials from all present. Helmets, budenovka fulfilled the same function – **you do not need your brain in the war**.

There are **LOTS** of **INFORMATION EXCHANGE** systems, but the nature of their presentation differs. All genotypes **421** visit only the

synagogue, they do not need the Church (with their frequency control, they get and transmit information, avoiding holidays). Everyone else (goys or outcasts) are content with crumbs, but even there is some division into castes – it is determined by the shape of the dome.

Orthodox Christians **STAND** in line **LAST**, onion form does not let frequencies of direct connection pass (onion bending spectral form of **hydrogen (H+)** is the positive hydrogen of the central position. This subsequently **created quite a problem in the lack of control of the egragor of the Orthodox Christian Church – NO INFORMATION – NO OBEDIENCE** (even in the higher hierarchy). On the agenda there was an issue of the destruction of Orthodox Christianity. First in line for information are Catholics – their temples are precisely calculated by the cone, and they get all the information necessary to know only by the selected goys. Minarets and mosques do **NOT HAVE** such calculation, because more than 99% of the information is scattered, despite direct access to the source of information (to the floor).

At the depth of **1270 m** below sea level there is an information plane like fishing nets with nodes in Curie zones. If in Curie node (at the bottom) the gravitational potential k-structures above 122% are kept constantly a ball in the 63 octave can be formed. The diameter of the ball is from 2 to 33 cm, and it has already the properties of the piezoelectric element. It is exactly over such a ball it was **NECESSARY** to **BUILD** a Church. If there is no piezoelectric element, the Church is a black hole (**Cathedral of Christ the Savior**).

The Ball -concentrator was created initially while creating the information network. If the church (mosque or temple) are not on the axis of the ball, they **HAVE NO** sense and are to be destroyed (like in the time of the developed communism). Previously, each merchant sought to build a church for himself (forty times forty churches in Moscow, including the Cathedral of Christ the Savior). But the remained are only those that are in the right place. The Cathedral of Christ the Savior outside Curie zone and therefore useless, except for funeral services and lending more significance to the Russian Orthodox Church (ROC). As the deviation from the axis must not exceed 12 cm (axis tube), the location of the dome should be accurate otherwise, the Church is useless. The best option is the next step: to find the right Church (e.g., Elokhovskaya near metro Baumanskaya in Moscow. By the way, Pushkin was baptized there and given the name of Alexander).

The energy of the first pyramid at frequencies of the 71 octave, i.e. direct access to the Brain. The energy of the secondary pyramid of the 43.5 octave, i.e. processed **THROUGH** the appropriate **TRANSLATOR** (musical) information block. But according to the Program on **2005-11-14** **there have to be 49.5** transfer octave (up to 64 times higher), otherwise all listeners will **NOT UNDERSTAND** what is going to be transferred to them. The part of the inverter belongs to the second pyramid (the cross).

Out of the two options –to rebuild the church, or to dig a pit, today the second is preferable. By 1000 there had been 3260 concentrators, less than 1000 are left now (the rest are worn out and should be replaced), because the total number of correct churches, temples, mosques **MUST NOT** exceed the number of working concentrators. Looking ahead I tell you that the situation on **2005-11-22** at the start of the automatic attending of information blocks is rather interesting. The total control before that had shown the presence of the 49.5 octave (the pyramid is rebuilt), the Brain of the elected is controlled by the 49.5 octave, so the automates will dump everything that is necessary for the program, and even more. The counting of votes is made strictly according to the matrices, and the performance is guaranteed, as before, by the control system (plus attending machines).

There is unchecked information that the ball is the Holy Ghost, (like in the anti-clerical song by **Vladimir Vysotsky**: "I come back from work, rashpil put against the wall...") which sometimes visits the ladies chosen for the creation of another Christ, using the **IMMACULATE CONCEPTION**.

Thus the Church is a terminal for not only obtaining Program information, but also for cleaning the Brain from the accumulated debris. In synagogues they use candle-concentrators, the debris in the Brain remain, however This debris **CAN CAUSE many diseases** (this understanding will be useful to the reader for further knowledge). By the way, respectable restaurants (in Western Europe) and at homes at lunch time the candles are lit (for beauty). The actual purpose of candles is to **INCREASE** the **GRATING POTENTIAL**, which enhances the digestive process. These candles are used by all witches, magicians, and sorceress. Candles must **be of wax** – product of oil. This product contains sulfur; which frequencies are basic in the atmosphere grating.

For the "Golden billion" the Control System **DEVELOPED REINCARNATION** system, or "**Christ**" that is eternal life of the created Brain: **the reincarnation, in relation to the beginning of the process of "bringing all things in order, as before the invasion" – was**

removed in 2000 – the Church calls this process **Antichrist**, and the Church itself **IS BECOMING USELESS**, *which is being observed with our own eyes.*

Chapter 2. "Spiders' Laboratory Experiments"

Anyone who has once proclaimed violence as his method, inexorably has to choose a lie as his principle.

If an individual is able only to take and not to create; and is not able to compensate or eliminate the consequences of his or her deeds – such an individual can not be defined as Man. It's not even a personality, but a guided biological creature. It is able to have only its own momentum brain functions for daily chores and its temporary life support at the expense of the destruction of the surrounding environment harmony and an additional own imposed use as a biological object to implement the plans and Programs of the external control, launched by alien Systems. These individuals have to be called People. Man has been imposed this kind of condition in the time of the realization of the old Program processes. And that is how it had been happening.

2.1. The first stage of the violent "Civilization" of the Earth

From 17304 BC to 16684 BC (620 years), there was an active preparation for the execution of the Program "Energybiogenesis of the flesh cell".

Insulation with a layer of magma and other conversions of the contour protective plates of the Planet were made.

LANDING on the Earth happened in 16300 BC. First of all heavenly places were laid out, all the Earth complexes were annihilated along with those who inhabited them. In order to adapt the planet for their life support the population of the planet had to be **MADE A CLEAN SWEEP OF**. That time, **1240 million Human Beings** inhabited the Earth. The population of the Earth was completely annihilated, and all the humanoids were captured. The molten earth, which was found in Siberia in a large area, can serve as a slight example of the impact of aliens. All the found evidence of the existence of the ancient advanced civilization was carefully hidden, and is still being hidden from the society.

The aliens had worked out their own biological structures, but based on the samples of the former Human Beings. New Biological structures had Brain octaves from the 31 to 44. In order to control the resulting biostructures Ebrs had brought from Phaeton 12 billion Humanoids – programmable energy "blanks", which sometimes manifested themselves in the form of "come outs" in some individuals. They were stockpiled in the United States in the area of the Great lakes, in Peru, Tibet and Australia.

In addition to the delivered frequencies, samples of flora and fauna were transported by their fleet. But since the conditions on the Earth were very favorable and energetically provided, everything grew to gigantic proportions. That was the time of the dinosaurs. This experiment **TURNED OUT** to be **UNSUCCESSFUL**, as it was very energy consuming, and everything was destroyed.



2.2. Attempts to create people

From 16684 BC to 13344 BC (i.e. during **3340** years) Ebr' System undertook the first attempts to create humans.

Symbolic "First Civilization", but in reality – the first stage of the intervention.

Starting with the first aggressive invasion within 1040 years **ALL** the **PLANETS** were completely occupied. The capture ended in 17 914 BC. The

capture itself was symbolic, since all the Main Complexes on the planets of the interplanetary Cluster of the Earth had been off. Not knowing the structures of their construction, having a lower level of knowledge, the attackers just tied up all the planets with gravitational tubes (and later –with connections tubes), included imputed base generating frequency radiation protection of the Sun, surrounded the planet with "satellites" (as security convoys) and moved in the direction of the Big Dipper, in order to make out an active area of its reach. But on the way it was decided not to lose time and carry out some possible processes of changes in their own favor.

I have already mentioned that the capture of the Earth was simultaneously with the sweeping off the entire Mankind (in their physical plane of existence) and those control objects that were on the surface. All humanoids, as the energy state of the Entity of the entire diversity of the biosphere in their non-physical as well as Spiritual Essence of the **proto-Humans** with the octave of the Brain within **96-124**, being at the moment in the structure of the Earth's Atmosphere (in the gratings' octave of the 32 to 72), were **CAPTURED**. They could not be hidden "below", as all the Complexes before the attack had been switched off. As noted previously, the saved were **ONLY SPIRITUAL ENTITIES** with **the 224 level of the octave** of the Brain. Captive humanoids were kept in the interments' objects' cells (mostly type 440), landed on the Earth.

Then began the first "filling" of the surface of the planet, with "their water" (tritium) and the formation of sand out of the water. This process lasted approximately **620 years**, the surface of the Earth during this time has changed significantly and reached the **level h=-4300 m** (in relation to the present level of measurement). The Earth's atmosphere had not yet been structurally changed, but some gasses were added as part of its gas completeness which were necessary for ebr entities breathing (in their physical plane of existence) – the oxygen and fluorine were theirs (later the composition will be replaced).

Immediately after the installation of invaders' complexes of type 111, 222, 333, 444, 555, 000000 and auxiliary systems (shapers of the quantum fluctuations like those in the area of Stonehenge, and others), after landing the only one remaining today main object (type 960, or "Jerusalem", or the Third Rome – (as you like) located near Red Square in Moscow); and after landing **ALL OBJECTS** of convoy the trial "Program start" for the materialization in the physical plane of the first group (2%, i.e., approximately 17-20 million) of the captured humanoids (i.e. Earthly

spiritual entities of proto-Human with the octave of the Brain 96-124), previously transferred to the state of energies to the 31 of the octave (an attempt to simplify the Brain, since the invaders did not possess such a level of the brain).



The "aliens" in the **TRUE FORM** of their appearance were landed only after the chosen places had been prepared for their existence, that is habitable for their general state; (primary Control) and the completeness of the gas atmosphere had been created.

The aliens (Ebrs) are spiders 2.5 to 4 meters high depending on their membership in their existing hierarchy (for comparison, the height of a proto-Human did not exceed 1,88 m). It was impossible to escape for the initially embodied people.

Firstly, the human Brain (in the 31 of the octave) was very limited to aware the reality, logical functions were practically **BLOCKED**. There was no energy-information translation of the controlling character; the only recreated was the function of the flesh cells control and some limited control of the metabolic processes. For more, the invaders were not able then in their experiments with people. They **WERE NOT READY** for modeling the Brain construction of the proto-Human in order to substitute it for a more

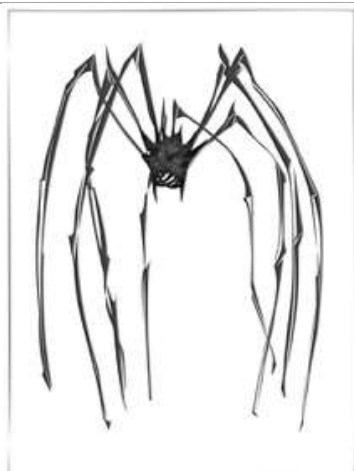

simplified construction of their brain in the human body due to the loss of the recourses after Phaeton's self-explosion.

Secondly, the area of the saved (formed) land after its initial flooding with imputed water took only 5-6% of the area of the total surface of the planet. The "continental" formations were mostly in the locations of the imported (transported) and installed primary (stationary) interventional Control Complexes or objects.

Thirdly, any attempt of creating self-born fauna of any long seasonal period was almost futile. The reason is that, as such, there was no synthesis control as a must for the habitat in general, and the unattended conception was giving up its being like a dying attempt of survival of the former fauna. The Earth **BECAME BARE DEAD** Planet, flooded with imputed water on the surface of which large-scale processes of annihilation of natural habitat, the barbaric destruction of all that could be preserved by chance in some way and fashion. And those fragments took place during this first stage, even in the initial period of the existence of the preserved groups of proto-Humans. Above the plates of the protective contour before filling it with water the interventionists had formed a layer of magma so that no humanoid was able to **RUN DOWN**, and to eliminate any attempt of the Earth Complexes and systems to **OPPOSE** the **INVADERS**.

In that active destructive mode **for 3960 years the first stage of the intervention of the Earth** had been taking place, a certain, **ALIEN** to the Earth Environment based on parasitism and violence **WAS BEING FORMED**. Someone might keep in memory the definition of this stage as the first Civilization (obviously, they have those unwavering "generic" reasons). It was **RUTHLESSLY DESTROYED** within 2 days in 13954 BC, as all the experiments with such "imposed Civilization" ended in its collapse and complete failure. Ebr System was not ready for such complications and did not take into account the level of perfection of the Earth, although all the formal knowledge, especially of the basic constants of constructive formation of the comprehensive energy model of the Earth and its being, **WERE KNOWN** to the alien system.

2.3. "The Second Civilization"

The second stage of violent "Civilization" of the Earth lasted 3150 years, from 13344 BC to 10194 BC.

At this stage, the interventional Program of "Energybiogenesis of the flesh cells" (the Program of "Energy-information dialectics of the development of genotypes of the Brain" had not been formed yet) acquired **MORE** significant activity in the reinforced attempts to create people (as a kind of proto-Humans), since the spiders flesh was imperfect and unacceptable in an attempt "to enter the Hierarchy of the Civilization development of the Intelligent orientation" (as well as the design of their Brain). For this purpose, the invaders used 21% of the imprisoned humanoids (spiritual entities), i.e. approximately 200 million individuals (from the state of their non-physical captive existence). The main **EMPHASIS** was **MADE** on Controlling the Brain by the primary energy-translation (of guiding character) via objects of 440 type. For this reason, all the settlement was formed in the range of the translation.

With the achieved results there were attempts to combine the people's flesh (people's bodies in the physical plane of their being through their Brain structure on the level and in terms of conversion into the low octave, up to 31) with the possibilities of the spider's Brain similarity. That was exactly what the principal attention was focused on.

Certain invaders' attention was paid to the **ATTEMPTS** of **INTERFERENCE** in the model design of **DNA**, **PROLONGATION** of biological **LIFE** of individuals (the average span of life was only up to 18-22 years), correction of metabolic processes of the cells of the flesh, attempts to transfer the metabolic processes to carnivore nutrition, and much more. But not so simple was the Man in the attempts to make' his likeness, for he is the fruit of the Creator's design! In this regard, the invaders did not make any significant progress. The invaders incarnated some other program processes to change natural habitat and the environment.

Water acquired only the fresh state. Its quantity was increased by lots of orders of magnitude; the former mineral inclusions practically did not exist. Moreover, it was the **BEARER** of **TRITIUM**. The program steadily required the mandatory presence of tritium in water, change in its frequency and density content in water as a source and carrier of energy for the functioning of the human Brain at the level of the lower octaves. A kind of "pipes" were formed, with a diameter of 300-400 m, to transfer water to the

objects, that required tritium (those "pipes" exist to this day at a depth of -2200 m to -3000 m). Water was intensely saturated with tritium.

The **SURFACE** of the **PLANET** was subjected to **CHANGES** as well; at this stage, the level of prime coating of the planet was "raised" again and reached $h=-3000$ m (in relation to the current level). Land geography expanded considerably. There began the manifestation of some semblance of discernment of the continental surface of the Earth. But it was only the primary image, even now depriving illusions many present day specialists of Geophysics, whose knowledge in geographical distinction of the surface of our planet rely on the theory of the separation apart (and the associated further "travel" of continents to different directions)

However, the truth about the formation of continents is based on "the foundation of digging", as an undeniable fact and on the trail of interventionists' achievements, and not on the theory of "spreading" and traveling of the entire continents. But why "the curve shapes of cutting" the continents on many borders of discernment is so amazingly alike? The answer to this question is **NOT ASSOCIATED** with spreading, it is associated with forms of scattering radiation frequencies (introduced by the invaders), with chemical elements formation at the ionic level, with subsequent formation of a "bulk firmament" (and filling with water, in particular) and so on.

With the expansion of the continental areas the invaders made **ACTIVE ATTEMPTS** on formation of flora and fauna as a complex element and process in general "civilization" development of the Earth. In addition to co-participation of flora and fauna in providing people's nutrition and their inhabited places it was required their active participation in the formation of natural minerals. Basically, all the attempts of intensive rehabilitation especially the fauna, were **DOOMED** to **FAILURE**. In the development of flora the complete similarity to its previous state was not achieved, the reason of those failures is the principal change of fundamental constants in all interventionists' creation of energies being. All the surrounding reality had changed fundamentally. There was no longer previous Program of operating "synthesis" of trees and plants. The structure of new chemical elements did not allow to come even close to any similarity in the field of flora. Thus, the invaders began **to form that kind of** flora, which turned out to be a certain **HYBRID** of the past and introduced processes of the synthesis control. Present day experts in the field of flora wonder to this day how dramatically and fundamentally their state was

varied in those distant years. They are trying to find the causes of such sudden changes in the variability of climatic conditions, not being confident themselves. And the reasons are completely different. There was an **ACTIVE EXPERIMENTAL** search for the most appropriate range in the field of flora to move to the complex processes of future changes, especially with the development of people, the perfection of their Mind and the Mind of the Planet, and so on.

At this stage, an active **FORMATION** of **PYRAMIDS** began as the necessary transmitting and receiving subordinate element for the functional operation of facilities and of Control Complexes. The height of a pyramid generally did not exceed 8820 m (except the pyramids in the Bermuda area, $h=840\text{ m}\div 9940\text{ m}$), and the design (and shape) was determined by the purpose and functions of the object, or complex, placed under it. When finishing such a creation the Pyramids were buried in sand. Some pyramids not buried in sand were executed of hard material of another kind, as if in the form of mountain (the Caucasus, the Alps, the Tibetan mountain range, the Andes, etc.).



Due to the negative results of the "civilization" development" in the part concerning people, this so-called, **"Second Civilization" was liquidated within a few days**. Again I am drawing your attention to the fact that, someone might take this stage for the "Second Civilization", but in the true essence of all the performed it was just a stage of civilization intervention of a violent nature, and it could not be the Second Civilization

of the Earth apriori. All **EXPERIMENTAL SPECIMENS** were liquidated within several days.

At the end of the Second stage of interventional interference in the civilization development of the Earth for 200 years there was a Programmed preparatory process of organization and partial Programmed correction of the Control functions at the created Control Complexes and (landed) objects for the conversion of all subsequent processes (changes) for the Third stage. For that short time from the Moon the first **SAMPLES** of "native" (lunar) humanoids (in their non-inertia energy substance) **WERE DELIVERED**, and also in the same way, some species of fish and birds.

2.4. The third stage of the intervention

Symbolic "The Third Civilization" (in fact, the third stage of the perpetrated intervention) had duration of 4070 years, i.e. from 10604 BC to 6534 BC. It had been the most satiated with all round experiments stage – from the formation of a stable interventional Control in all directions of its own civilization development until the **ATTEMPTS** to introduce self-created elements in the field of flora and fauna (taking into account the obtained humanoid fragments from the Moon). The details are not so important, since the invaders had **FAILED** to recreate the true likeness. However, one should note an important point, namely, the Control System of the invaders still was not perfect. For this reason, the true Control System of the Earth **REPEATEDLY** and **IMPERCEPTIBLY** interfered with its controlling correction in some episodes of the fully developed Control of energy being in the material and immaterial world.

Thus, as if a strong demand there arose for compulsory salinity of fresh water by those possible forms that had been established by that time. It made it possible to **RECREATE** to some **EXTENT** at first approximation some part of the conditions of life-attending in fresh water and give the underwater world some of model structure and functional significance oriented to ensure the created people in proteins and minerals of aquatic origin. Such unnoticed corrections occurred in the field of flora and fauna, and did not make it possible to leave **FULLY** and completely **THEIR** proto-forms in their development.

There was quite a lot of experimentation in the process of recreating people over this long period. In total 42% (about 400 million) captive

humanoids (energy-information entities of proto-Human with the former level of the Brain of 96-124 octave) were used. What was basically the main attention of the invaders paid to? Realization of only one Program of the "Development of Energybiogenesis of flesh cells " went on, and therefore the concentration of invaders' efforts on this issue, was basically focused. For this purpose, in the Atmosphere gratings all along the perimeter the processes of development of "**the Atmosphere Brain**" started in order to give some primary guiding in the existence of people without binding them to objects of type 440. But during this period it had **NOT BEEN** fully completed. Much attention was paid to changes in the human Brain Control of the metabolic processes of the flesh cells. During this period, people were brought to the state of metabolic processes under conditions of their suitability and ability to be carnivorous (initially without thermo-treatment). This made it necessary to **CHANGE** structurally and **SIGNIFICANTLY**, for example, pancreatic function and, consequently, to give additional functions to the Brain in its guiding and control of the metabolic processes of the flesh cells. This information is for those who is fond of vegetarianism and other "experiments".

Regarding the adjustment of the people's Brain structure all the experiments were mainly focused on:

- the **LOW OCTAVE** of the Brain (up to 31 – to add full submissive executive state, recreation of limited part of logic functions for the execution of elementary actions and motions, exception of rebellious behavior in the process of cohabitation, etc.);
- continued attempts to combine the Brains of people with the **DESIGN** and **FUNCTIONS** of the invaders' Brain (including those sent from the moon humanoids – their native individuals);
- prolongation of biological life of human individuals (no progress from the previous stage) by interfering in the DNA structure and many other experiments.

However, significant outcomes in matters of recreation of people as a likeness of proto-Man, but completely conquered (with all his life and suitability for a replacement of the combined Brain design with the invaders' Brain), had **NOT** been **ACHIEVED**.

Soon, within a few days this stage was stopped, in 6534 BC, and the entire carnal experimental basis was eliminated. Thus there ended the alleged "Third Civilization". After its elimination there was a certain preparatory process of the Program resetting of the control character as well

as **SWEEPING OFF** the consequences of the **300 years** of experiments (i.e. until 6234 BC). In addition, there were quite a lot of changes in the physical plan.

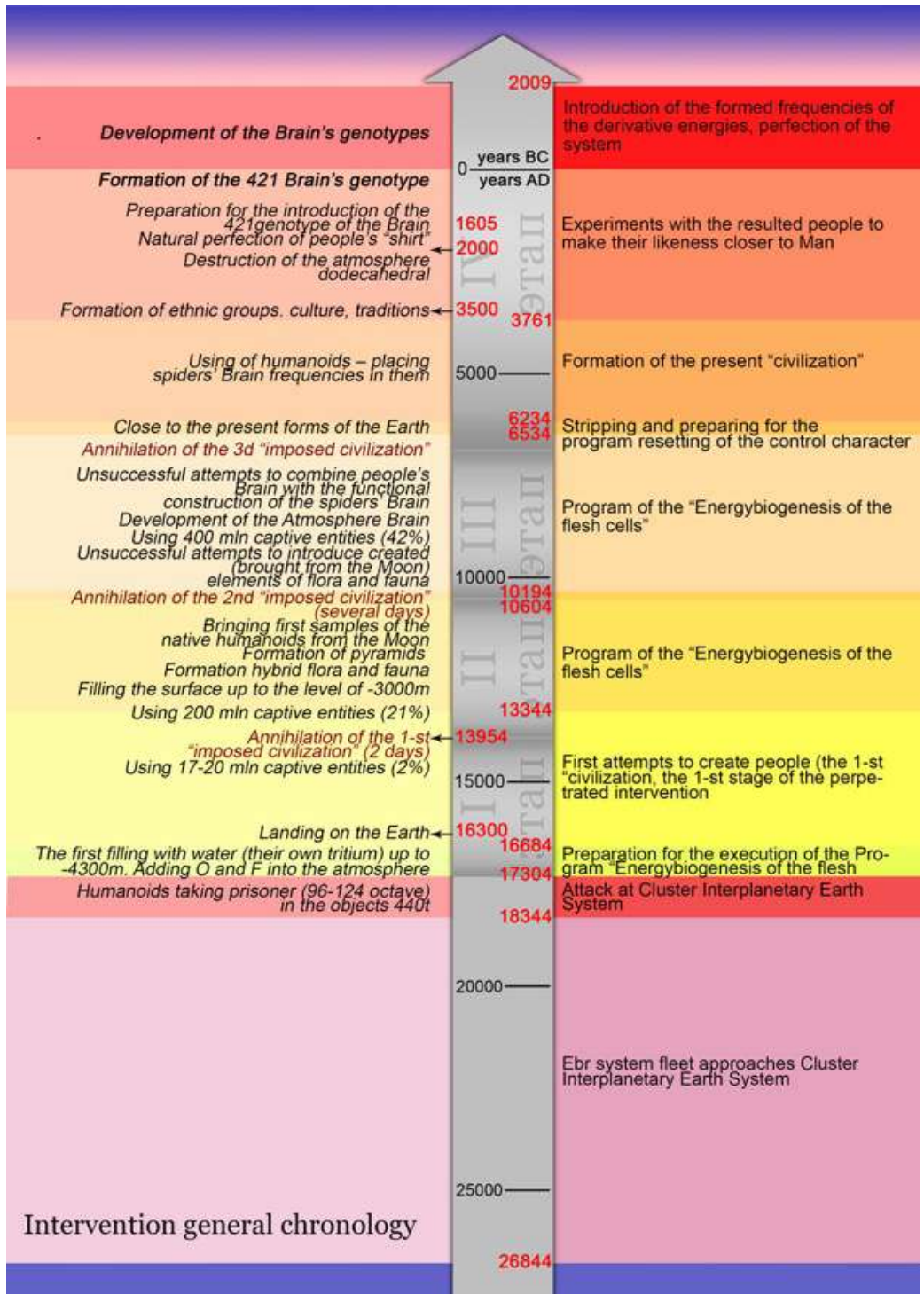

2.5. Preparation and the fourth stage of the violent intervention

From **6534, BC** to **6234 BC (300 years)**:

- preparatory process of the program resetting of the control character;
- sweeping off the consequences of the experiments;
- the surface of the Earth was filled up to $h=-1200$ m (relative to the present level), on the formed surface there were laid 8640000 energy tires of inter-pole direction (the geographers call them Meridians, and they are not 360 but a few more), connecting all Control Complexes and landed objects;
- nodes were formed (control servers and distribution energies servers);
- after this fine engineering, the whole complicated "installation" was filled up to $h=-100$ m;
- Huge masses of water 1500 m high were hurled to the Earth from the atmosphere hydrophone layer and from that moment sea water was first formed. That is the "worldwide flood";
- the surface of the Earth has taken the form close to the present.

They began **TO USE HUMANIDS**, inserting into them frequencies of spiders' Brain. Consistent frequencies setting led to good results. ***With materialization, all the humanoids got the Brain of spiders and formed the present civilization.***

Since 3761 BC there had been quite a lot of transient experiments with the resulted people in order to bring their likeness closer to the likeness of the Man before the intervention of the Earth. By mid-September, 3761 BC, this process of image similarity had been completed (the story "of the image and likeness" in the Bible and other legends).

Since 0 year AC the invaders **BEGAN** to **INTRODUCE** a large group of preformed frequencies of the derivative energies (relative to the basic that had been brought by them) and improve the System of control. The interventional System complicated and improved the Control on the Earth which had been created by them. They introduced the control of the state, executive behavior and control of efficiency resulting aspects of groups and **INDIVIDUALS** from people. An extremely **IMPORTANT** step was **the introduction of reincarnation**. It was the only way out of difficult situation for the whole ebr System, which failed to solve the problem of non-

conformity between the long duration and continuity of the necessary executive functions of people with limited life-span. They **FAILED to get to the fourth codon of DNA** and mastered only three of them, and only because of this life for the created people was so limited in time.

Further interventional (ebr) Program objectives in relation to people became **MUCH MORE COMPLICATED**. They rushed to get people as representatives of their Space (because people look significantly more decent and potentially more perfect), but having the Brain of a spider and the possibility of transition to the octave of energies 44 and 56 (i.e. above 31 octave of the material world) in case of unforeseen emergencies on the Earth. In addition, the group of spiders, which was located on the Sun as their **SELECTED ELITE** in the amount of 1,200,000 individuals, would have to make "golden elite" on the Earth by their Program, but with more perfect Brain – the **72 octave**.

2.6. Technical implementation of the Control

On the 2009.11.15 the functioning of the basic Complexes and Systems of the invaders was eliminated along with those who served them, i.e. spiders and those enlisted. It took the hardest **16 years**. There are still lots of aftermaths of the intervention, but the **MOST IMPORTANT** and irreversible is **CARRIED OUT!** Part of the interventional Complexes and objects saved as functioning trophies, as the loss in time and energy spent should be compensated with something. **THEY** have **ALREADY** been applied in the solution of creative tasks and elimination of aftermaths of the intervention.

In this regard, in a simplified format I'll show you how the Control had been technically carried out by their Systems. But I will throw light upon this issue in the limited frame of understanding only the fact of **ADMINISTRATIVE INFLUENCE** on the condition of people and their subsequent resulting behavior. This is exactly that sacred "From outside" passed in the numerous epics and legends. Technical and technological details are not touched upon, in order **NOT** to **OVERLOAD** the readers' Brain. Of all the Complexes and objects, involved in the old System of the Control, we will note only the main part, without which the Control would **not have been possible:**

№	Complex	Purpose
---	---------	---------

1	Chekhov	Control tower, main control system, setting Programs for all complexes.
2	Kailas	Main control system, correction in accordance with the atmosphere Brain program for all genotypes on the Earth.
3	China, Tibet	The atmosphere state control during the correction of the atmosphere Brain and all communication channels of objects type 560, 520, 500, 440, and 960.
4	The Urals	The coating of the brain (31 octave) for all genotypes (from single-celled creatures to man).
5	the Baikal	System of emergency rescue of humanoids 42, 44 in case of a disaster (evacuation from the Earth).
6	Easter	Compliance Control of the Brain coating and octaves from 49 to 59 for all genotypes.
7	Kailas 2	Routine (weekly) monitoring of the Brain.
8	Peru	The Main Complex of control, maintenance and storage of humanoids (for future use).
9	Andes	Control of all humanoids on the Earth.
10	the Caucasus	The Main Complex of control, guiding of the "Golden billion" – 42 genotype.
11	Elbrus	Territorial complex – the European part of Russia, Belarus, Ukraine, Bulgaria- total control of genotype 42.
12	Kazbek	Territorial complex – the East and the South Caucasus, Central Asia, East of Asia minor – full control of genotype 42.
13	Ararat	Territorial (first on the Earth) complex – Asia minor, Greece – complete control of genotype 42.
14	Alps	The Main complex of control and guiding of the "Golden million" – genotype 44.
15	Alps 1	Territorial complex – France, Spain, Portugal, Italy, Western Europe – full control of the genotype 44.
16	Alps 2	Territorial complex – Eastern Europe, Germany, Baltic States, Scandinavia – full control of the genotype 44.
17	Sarajevo	The main energy complex of octave 53.5 (gratings replenishment for all types of radiation). The first atomic bomb was worked out in Germany.
18	California	The main Complex for preparing new genotype – 46 (to be introduced in 2012).
19	China, Tibet	The main control complex on the Earth, setting standards for all complexes.
20	Easter	The coordination control node via Kailas.
21	Moscow 960	The main object of the Control System, all the brain matrices of 42, 44, 46 and Moshiach.
22	Greenland	Control of the Atmosphere brain.
23	Ireland	Computer center. All types of calculations. By the way, Ireland – second in the world in Computer programming. At the same time, Ireland is the birthplace of unsolvable mathematical problems.

It is quite sufficient to pay attention to the purpose of each Complex which convincingly demonstrates the fact that all actions in the Control the processes of implementation did not leave any chance to be left without old System's control, even in minor episodes of actions and events. A skeptical opinion or judgment will only mean the unwillingness or inability to go further into the matter. Technically, from the first steps of any Program simulated process to its **PRACTICAL IMPLEMENTATION** via the enlisted – everything was in the field of effective attention of the Control Systems. Moreover, the old System had the technical ability to lead and to **COMPEL** to the planned **RESULTS** in all that was determined by them through various set up Programs.

While creating the atmosphere Brain (**from -2200 m to 12,400 m**) new frequencies were introduced in the original structure of the atmosphere. This process began over 2000 years BC. Strictly symmetrical structure of the atoms dodecahedrons was destroyed (some connections with the icosahedrons were removed). Each removal of such a connection led to the creation of a new chemical element. If you completely remove dodecahedron, you get icosahedra structure of bor. As the basis was 16, 22, 28, 32 and 42 of the octave, exactly in these structures everything was replaced.

A certain combination of octaves 16 and 22 led to the creation of gas and the combinations of octaves 16, 22, 28, 32, 42 – to the formation of oil. White oil has **additional octave 47**. Besides, octave 53 was inserted; as a result "explosive mixture" was made. But these combinations were intermediate and could not be used for the formation of the Brain, as they contained the catalyst – sulfur. Sulfur is a product of the Brain activity (note – sulfur in the ears), but it **CANNOT** be in the composition of the Brain. But this "explosive mixture" has one property – it is impossible to transfer to octave 56 without it, which is extremely necessary for all representatives of the "Golden billion" in case of emergency, when, for example, they **HAVE TO BE SAVED** from a nuclear explosion. Since the intervention in the Atmosphere structure by the interventional System it has still been presented in **6 layers**:

№	From	To	The Purpose
1	-4400	-2200	Atmosphere Brain grating connection, the atmosphere Brain
2	2200	0	Atmosphere Control system (-2200 m is the hydrophone depth)
3	0	1200	Base layer
4	1200	6200	Accumulative layer
5	6200	12400	Layer of materialization
6	12400	36400	Layer of the atmosphere protection

In the accumulative layer there was a weekly process of accumulating or clearing the frequencies and their subsequent distribution among other layers. In the layer of materialization there was a transfer of all types of humanoids into material structure (putting "shirts" on them), as well as materialization of UFOs after their lifting, if necessary. Each layer, except No. 3, has sub layers, in which, different structure frequencies performed the same function.

In the initial period each object, from which humanoids were obtained, formed an individual "cupola" for them inside of which the development of the given group took place under the Control of the object, without reference to the environment. It was impossible to go out of the "cupola", the outsiders were not allowed in, as well.

When the Earth Control System was introduced in the state of a new functioning, set up by the invaders for themselves, there began binding of all biostructures to the local habitat within a certain distance from the Object. First and foremost, this environment was formed **by the Andes**, then **the Caucasus**, and from 0 year – **the Alps**. The colony of humanoids living in the Object "cupola" was called "ethnic group", hereinafter used the term "nationality".

Where did ethnic groups come from? In its original form, all "passengers" on all the objects **LOOKED** perfectly **ALIKE** and the Brain structures were alike. But the objects do not transfer material bodies, and therefore when landing in a "chair" any material structure folds into a small fireball, about the size of a match head. When rolling itself in a ball there might be some slight distortions. Therefore, the Brain potentials before rolling in a ball could be different. On the way the object could fly through a meteor and can pick up any muck in the form of those germs that are typically found by "modern science" on the meteorites. In addition, the environmental parameters of the Object arrived, and the parameters of the "passengers" delivery places could be different in structure and filling (on the Earth there was more oxygen). If the original Brain when moving lost at least one frequency (and the Object's Generators **DID NOT NOTICE**), then many of the original properties were lost at the delivery place, as well. The missing properties were filled in with "stock parts" (with expired shelf life, as the movement was more than one hundred years). That is why each Object brought what had been loaded in it, but poorly packed. Each ethnic group had the **SAME STRUCTURES** of the organs, but **DIFFERENT STRUCTURES** of the Brain.

The brain, or the properties of biostructures, as the System of external and internal control, memory, orientation, information exchange properties mostly, were the same, but had **DIFFERENT BASE**. The Base is an individual property of an ethnic group against which metabolic processes of reception and transmission or language translation were built. In Georgia, for example, the basic element was manganese (Ossetians have another basic element; it's a different ethnic group). When in Georgia the deposits of manganese were completely depleted, the population got the process of "thickening" of blood and increased pressure in the pulmonary circulation. ***In practice, it was noticed in 1989.***

The Control system, taking into account the location of the "cupola" for 3500 years before the new era began attaching them to the layer of atmosphere No. 2. Using the features of the Brain of ethnic groups in the first place, each of them received basic radiation frequency, relative to which there was a rearrangement of atmosphere layer No. 2. The number of radiation frequencies was more than 100. Using the database, i.e. the radiation frequency specifically **TO EACH** ethnic group, their quantity and the number in each ethnic group were brought to the Program specified values.

Primary life styles (culture) and borders of the habitat of each group were introduced and found with reference to the layer of atmosphere No. 2. Boundary of habitat no longer had a cupola shape. In the center of the former "cupola" "capitals" of ethnic groups were founded. Regarding this, the construction of further settlements was carried out, etc. In the course of development with the objective of stabilizing Control of the execution of the Programmed processes limitations were introduced **WITHIN** each ethnic **GROUP** which do not allow different ethnic groups to merge, i.e. be mixed. It became surrounded with imaginative and behavioral introduction (concept and realization) of different traditions, beliefs etc. If the group did not meet the conditions of the Program requirements, i.e. had non-programmed variations in its development of any irreversible character it was **ANNIHILATED**, usually by **OTHER** ethnic groups. But each group had its own object of defense, and if the group was annihilated, then the Object was destroyed too, it was transferred to the off state.

THE PRINCIPAL PROGRAM goal was to create the "Golden million" based on "the Children of the Sun", and all ethnic groups had to be only **CONSUMABLE MATERIAL** for conducting Program experiments to improve and bring the Brain to the desired genotype and in the right quantity

in line with the Program. The intermediate group of the "Golden billion" had begun to take shape since **0 year of the new era**. At the same time, representatives of this group had already had some connection with the atmosphere Brain, placed in the layer **-2200 -4400 m** deep. They could have up to 12 language translators for communication with other ethnic groups, got firsthand information necessary for the "creation" and "implementation" of new technologies to improve their social settling. They formed their own societies and the structures of their Control, founded primitive, but their own economic system, etc.

Societies and states began to appear, take shape and improve. And it all went allegedly like the way some historians are trying to give an account in pictures. But everything is not as simple as we would like it to be! **NEITHER** Marxist-Leninist basis of the fundamental production relations, **NOR** the theory of the World market, or any other contemporary theories or the theories of the past **HAVE BEEN ABLE** to answer the question how numerous societies have been formed. What qualitative and quantitative "special recipe", how many and what kind of ethnic groups had to be collected to create a proper society, in what quantitative and qualitative limits? Whether this process is guided or prone to natural formation? Why periodically there were demographic problems? Was a 'recipe' for the formation of all societies the same or was it unique for each group? And finally, who determined the boundaries of the states, without any disputes or military interventions, i.e. some other way? There are plenty of questions, but they are being ignored, passed over or looked for a convenient explanation – beyond the truth.

The fact is that after the invaders' realization of the processes for creating altered, to fit their Program single grating of the Earth's atmosphere **THERE IS NO LONGER** any **NEED** for a hard reference of ethnic groups to certain location, as the atmosphere grating itself has gained all the necessary properties to support the existence of the ethnic groups diversities to any point of the Earth. From this moment, a deterrent from the chaos and mixing of ethnic groups (nationalities), as previously established societies by force, have become newfound by the societies and assigned to the performance exactly by them some private Program functions, which, in accordance with its Target Vector of **FUTURE PHENOMENA**, actions and events predetermined the whole Program structure of the subsequent events in this society. In the future, it was classified as historical **STAGES** of the **DEVELOPMENT** of civilization, states and their groups, etc.

The system pre-held Program distribution and gave specific functions to each society taking into account the placement of Objects and Complexes in relation to the established and well-functioning system of energy and information support, communication and control systems. For all that clearly defined characteristic, territorial demarcation under these societies functions were determined. Moreover, each territory for future settlement was pre-saturated with a certain set of "natural" resources to the levels, which should be sufficient to ensure the formation of material goods and services exactly for the society which would settle on that or other territory having a set of specific functions endowed by the Program.

The **MAIN** geographical **REFERENCE POINTS** in the definition of the borders between the States were served by both placed Complexes, and Objects and **FREQUENCY REFERENCE** through the Brain of specific genotypes with frequencies of some chemical elements that were present in the deposits of this territory. This frequency reference in the first place, was the **SECRET RECIPE** for the selection of specific numerous or uniform types of ethnic groups in society, which was necessary to perform the full function of every society. At each step of the Programmed performance of its functions the society could and was supposed to have a certain number of performers of specific genotypes of the Brain. This exactly determined the quantitative composition of the community, and this corresponded to the demographic change with reference to the specific stage of the Program execution.



Any artificially introduced unprogrammed interference in the correction of a demographic problem was not able to solve it. However, any forms, methods and aspirations in all attempts were futile. But it has always

been able to **ORGANIZE CALAMITY**. So, for example, was **ARTIFICIALLY ORGANIZED** a very serious problem for Russia, connected with the ill-conceived initiative to enhance migration flows from the countries of Central Asia. Any proactive interference of a random performer, not provided with the programmed framework, has always led to some significant consequences. So, more than 95% of people who were involved in the non-programmed cultivation of virgin lands immediately fled across the country at the end of this artificially inflated farce, not having achieved the target. But the main part of the "fled" has not returned to their former locations and to their former way of life. Most of them were darted off from rural areas.

That way **THE FIRST** endless **STREAM** of "roving specialists of all hands" and later called "the municipal quota" was arranged; and the aftermaths of which have never been corrected in the development of the agrarian sector of the economy. These were the people with the **BROKEN PROGRAM** in their minds and deprived of the former frequency connection. The similar situation was with the group of "BAM" (the workers of the Baikal-Amur railway), and so on. The alternative example is the voluntarily-forced resettlement of oil- industry workers from Azerbaijan to the areas of Tyumen petroleum industry. They, having frequency connection of the Brain feel well in the northern areas, succeed in labour productivity and are not going to move back to their former motherland.

There might be a natural question: Why were there so **MANY** bloody **WARS** to defend one's territories? Are they futile losses and unnecessary human grief? Do not worry –it was that way, regretfully, in line with the old Program one of the variants of the **LIQUIDATION PROCESS** of the unnecessary Brain genotypes after a regular stage of its perfection. The present day existing "Golden million" is the **EXPENDABLE MATERIAL** that for the completion of the Programmed stage was being transferred to the "Golden billion" on common grounds of annihilation of all those, whose brain genotype did not meet the new Programmed requirements.

2.7. Formation of Consciousness

The embodiment of the specified, including the **formation of consciousness**, was carried out by practical providing **ALL** the necessary **INFORMATION** orientation of "the strategic and current" nature, which

for a long or short period of time were translated to the Complexes, Objects and preformed Control Systems. The latter, in turn, through reverse energy informational translation operated, i.e. determined all subsequent terms of performance and found commands related to the development of structures, functions, and the design of the energy- informational translation for people and the development of their Brain throughout a long process of their supposedly "natural" perfection. ***It was through such programmed policies like orders, the process of development of the materialized by the interventional System people*** – from their state of "Cupola" Control¹⁷ of the being to the present state of the accomplishing "Collapse of their Civilization" occurred.



The formation of consciousness of the genotype of the Brain is a **DISCRETE** sequential **PROCESS** to bring the System functional Controlling information in the conscience of individual members (performers) at a specific "historic" moment through Systems of Control and Operation of accompanying and supporting Complexes.

Thanks to this, with the application of systems of Control and Operation, there was implemented the Comprehensive support in the execution of the Programmed actions that led to a pre-planned System results and events in the development of human civilization for the realization of strategic Programs of the interventional System: "the Development of Energybiogenesis of the flesh cell". Along with the transformation of the Brain the biogenesis of the flesh cell was also changing while maintaining the external forms of people. Man was **TRANSFORMED** into Ebr in his essence, getting all the implications of such transformation in the form of a complete set of **ALL** parasitic functions.

Man is a structure that ***is simultaneously in two spaces – in the neutron (proton) and antineutrinos (electronic) spaces.*** All sensations are formed only for the neutron space. There are other Brain

Man is a structure that ***is simultaneously in two spaces – in the neutron (proton) and antineutrinos (electronic) spaces.*** All sensations are formed only for the neutron space. There are other Brain

¹⁷ "Cupola Control" – the Biostructures at any celestial body possess only that frequency spectrum which is provided by the System. This frequency spectrum is provided at the expense of UFO. (a cupola is created under which the biostructure's life is supported, and for which the frequency balance is unique).

connections (with the neutrino space), which WE **ARE NOT GOING TO** consider here. The entire development of life on the Earth is determined by the frequency dependencies generated by the difference of two numbers of the Solar system. The number **Pi** is not irrational – it is the ratio of the length of the contour to the radius. In the Solar system **2 Pi**: 3,000864... (to the 124 decimal place) and 3,1648... (to the 124 decimal place) are used. These numbers specify not only the wavelength of the closing circuit of the Solar system, but also **GIVE** its **EXACT DIMENSIONS**.

The base of any living structure is hydrogen and the formation of ions is subjected to the same difference in numbers. For example, a Man formed in the system of Alpha Centauri, when delivered to the Earth and linked to the existing life support system can look like a crocodile. If an object (a UFO) having created in another system, did not provide restructuring of its structure to the values of the system's constants which it intruded into, it automatically was subjected to transmutation with the formation of the inert mass.

To solve their tasks on the Earth Ebrs had to introduce profound changes. They almost completely subjugated **all 18 life support biostructures' systems**. In particular, they have created structures at the frequency of 53.375 (gamma radiation). Spiders live normally in this atmosphere. Radiation over 124 x-rays does not harm them. By the way, cockroaches, which they have brought, too, are tolerant to radiation up to loss of color (look like glass).

Ebrs sought to **penetrate into the mystery of a living cell** since their protein cell by its energy resources was much less than a living cell. But more details I will provide you later in a special Chapter about the Cell.

The brain is the most complex set of a biological structure and is the result of multimillions work on the formation of a biological structure (of a Man). The brain, of course, cannot be formed by itself from dust using chemical reactions. ***The brain is simultaneously a bound up state of 3 spaces – neutrino (the highest), antineutrino and proton, or ion.***

In their experiments with humans the aliens first, tried to raise the octave of the Brain. It gave the Mankind the level of a **CAVE MAN DEVELOPMENT**. Further **EXPERIMENTS LED** to appearance of the colored races and different species of monkeys on the Earth. In the course of study and cognition of Man they have adjusted for themselves the biological "shirt" raising the octave of the Brain. Eventually they were able to improve

the Human Brain and **brought it only to the 66 octave**. Some individual experiments gave the 71 octave of the Brain. In order to control each "bio shirt", it was attached to the **PROGRAMMED HUMANOID**.

A brief chronology of events* on the Earth from 3500 BC to the present time is shown in **the table**. The dates specified in the table are approximate and calculated by a special technique, since at that time of events, the time parameters were quite different. For example, for the Earth **day and night = 48.64 hours, a year = 864 days**.

Time of the event	The events happened ¹⁸
Around 3500 BC	<ul style="list-style-type: none"> - Control system, in accordance with the location of the "cupola" (borders of ethnic groups location), binding them with reference to atmosphere layer No. 2 - basic radiation frequency (more than 100) for each ethnic group were obtained, in relation to which there was a restructuring atmosphere layer No. 2; - using radiation frequency for each specific ethnic group, their quantity and number in each ethnic group was brought to the Programmed specified value, introduced and found primary life styles (culture) and borders of the habitat of this group with reference to the layer of atmosphere No. 2. Borders of the habitat no longer had a cupola shape; - inside each ethnic group limitations were imposed making it impossible different ethnic groups to merge, i.e. be mixed. It was surrounded with imaginary and behavioral introduction (concept and realization) of different traditions, beliefs;
2000 BC	<ul style="list-style-type: none"> - creation of the atmosphere Brain (from -2200 meters to 12,400 meters). New frequencies were introduced into the original structure of the atmosphere; - strictly symmetrical structure of the dodecahedrons atoms of the atmosphere grating was destroyed (some connection with the icosahedrons were removed). Each removal of such a connection led to the creation of a new chemical element. The coordinator on creation the atmosphere Brain was the Caucasus Complex, because all of the major and known deposits were around the Caucasus;
2000 BC- 1605 BC	<ul style="list-style-type: none"> - the period of creation and natural improvement of the "shirt" (body of people); - up to this point, the Control System worked out all the processes of Energybiogenesis of the body in the image of the captured humanoids under the protection of Objects 440 type. The settlement was organized under the "cupola" area, primary fragments of communication with the changed environment were worked out, as well as habits to the new conditions of the environment;

¹⁸ Here there is only a short version of the event. More detailed information you can get on "Salvatorem.ru" "About flora and fauna" and the works "Basic information on the Mankind formation", Parts 1,2.

	<ul style="list-style-type: none">- mastered the basic skills and basic hand tools simplifying and labor saving in making food, clothing and shelter. This time should be defined as a period of pure virgin natural values. All values were determined by the Program and dictated by the Objects of 440 type, focusing all the people's being on training and improving the body for the conditions suitable for the future functioning of the 421 genotype of the Brain. The ability of logical judgments and estimates of the observed reality, the ability to receive and transmit the perceived information in the form of speech – Objects 440 were used for this. All in all they provided 384 "languages";- under the operation of the Andes Complex (a separate settlement of "Maya") a temporary, specific task was worked out– testing of separate mantissas of the future Brain genotypes. This was the incredible mystery of "Maya";
1605 BC- 882 BC	<ul style="list-style-type: none">- formation of the Brain genotypes;- under the Control of Complex Ararat (Caucasian Control Complex) in 1605 BC the genotype of the Brain 421 was formed. It was the first successful attempt of the interventional system to put in their (spider's) Brains in the "shirt" of people. The coverage area of this experiment – Asia Minor, Greece. The Control center – Jerusalem;
882 BC- o AD	<ul style="list-style-type: none">- formation of the Brain genotype 422 under the control of Kazbek Complex (control center of the Caucasus) on the territory of Eastern and Southern Caucasus, Central Asia and East of Asia Minor;- an active period in the evolution of people associated with the possession of their own "self", open confrontation of people with the natural environment – development and conquering the World. All control and support were provided by two Complexes – Ararat and Kazbek. Developing the advantage of one genotype of the Brain the dominance of another was provided and supported;- a sharp jump in development and perception of new social values. The level of achievement in their development and acquisition of new structures of social organization, Control and arrangement of a more perfect being, etc. still can be imitated in their separate parts;- Rapid rise in the development of many fields of culture;- an active process of more expressive territorial definitions and boundaries for each genotype of the Brain began.

2.8. The development of the Brain genotypes of the alien Control System

Let us briefly sum up the results, which might make many of you feel uncomfortable, nevertheless everything was exactly that way – I think you will get to the meaning of how we ***"have sunk" into such a life...*** Understanding enables us to assess what is happening today, and this, in my opinion, is the most important.

0 -1433

Continuation of the **DEVELOPMENT OF THE BRAIN GENOTYPES** Program and implementation of other Programs:

- Complex Ararat created the first Brain genotype 421 in 1605 BC;
- Complex Kazbek created the Brain genotype 422 in 822 BC;
- Complex Elbrus created the Brain genotype 423 in the 0 year, having completed the formation of the first group, i.e. the Brain genotype 42.

The Brain genotype 423, as more perfect, was the basis for further development of possible additional executive functions of individuals of a higher operational order and further improvement of the Brain genotypes. In 1433, the first Brain genotype 441 (Control Complex of the Alps 1) was created. In 1841 the first Brain genotype 442 (Alps 2) came into being. In 1990 the first Brain genotype 461 (California) was introduced. By 2012 the second cycle of formation was supposed to have been completed, i.e., the work on the formation of all individuals of the second group, i.e. with the Brain genotype 46. The first cycle was completed in 0 year, or exactly, 0000-01-17 at 02-11.

THE MAIN TASK of the Control System was creation of such biostructures, the Brain of which had to fully comply with all the Programmed orientation of the System and be fully guided. For all that the realized control of the entire being of individuals and social organization of the society were to be arranged only in the shape of a pyramid (since it was required by the brought in **BASIC FOUNDATION** when making up the Control information):

- Level 1 – Moshia (Allah, Buddha, etc.), and the Brain genotype 481;
- Level 2 – "Golden million", the Brain genotypes 461, 462, 463, 464, 465, 466;
- Level 3 – the "Golden billion", the Brain genotypes 441, 442;
- "The Golden million" – "priests", managers in finances, science, society, and distribution of all kinds of material goods and services;
- The "Golden billion" – production and replenishment of material goods, preparation and provision of services.

The rest of the population is not required, it had to be annihilated by the end of December 2012.

With approaching 0 of the New era, the level of authority of the individuals with the Brain genotype 422 sharply went to the decline. People-

Gods began moving into the oblivion, their Programmed functions were over. People-Gods lived too short life! To solve the problem of extending biological life of separate groups of individuals old Control System had not been able, the approach to the fourth Codon of the DNA had not been found. On the 7 of Jan 0 year at 02 o'clock, 11 minutes Control Complex of Elbrus introduced a new Brain genotype. The Program of "Reincarnatio" was brought in, i.e. the continuation of a humanoid functioning that was provided in line with the Program with **CONSISTENT**, gradual gaining of **SEVERAL** "shirts" (bodies) so that it might be able to complete execution of the assigned functions. The Program "protection" was introduced, popularly known under the name of "Christ". Between the material "shirt" (a biostructure) and the phantom (matrix, can be "humanoid") the intermediate frequency of 51.5 octave is placed (all in all there are 22 frequencies). These frequencies provide communication with the atmosphere (cubic structure).

The second function of the imposed frequency was **to provide the process of reincarnation** (the used matrix was **NOT THROWN AWAY BUT PASSED OVER** to the next shirt). **Hence the symbolism of mother and child**. First the protection system was tested in 0 year and since that time in every Program cycle 2 days before the introduction (15.22 Moscow time), the protection has been removed (symbolizing the death of Christ); after setting new frequencies the protection with new properties was fixed, and all Complexes on the Earth attended the **NEW SYSTEM**. It was started the process of implementing the historical episode on the formation of specific state of control in arranging people's being – "the power of money" as finally formed Administrative Program (ritually symbolized with the crucifixion of Jesus Christ). The Central Control server is Byzantium.

Exactly since that moment, the basic might of the Administrative action with Elbrus Complex was entrusted on the Control instrument "from All Mighty", i.e. religious confessions. Total active might this Control instrument manifested **on Easter, 385 AD** (the phenomenon was symbolized with the crucifixion of Jesus Christ).

Fundamentally **NEW** basic foundation of spiritual values – **RELIGION**, which acquired major Administrative work, was introduced. Religion in all variants of confessions has become not only the basis of all spiritual and subjective values, i.e., the **BASIC** effective **INSTRUMENT** for the implementation of the functions by the performers from the Conceptual

Power, but also has been the **PRINCIPAL LINK** in the determination of the structures of statehood, authority, and law.

In 1433, the Programmed stage of the development and improvement of the **ENTIRE SPHERE** of Control covering with its executive Controlling incarnation through the processes involving the whole of three-variant Brain genotype 42 was completed. Technical, energy informational and other perfection of the Caucasus Control Complex in total with other Systems and Complexes as well as the functions of increasing and complicating the **CONTROL PROCESS** through the Brain genotype 42 was completely exhausted in its capabilities, its development and its long-term adaptation of the Brain functions.

1433-1841

A significant contribution to the enhancement of the role and giving another level of the Programmed importance in the Administrative influence of the "power of money" came from the time of introduction the 441 genotype of the Brain, performed by the **Alps** Control Complex, in the spring of 1433. Exactly during this period of gaining Control functions by the individuals of the Brain genotype 441 the balance of the undermining power authority was withheld due to the «power of money»; and the authority on the basis of outdated methodology of religious values had lost its leading functions forever. Strengthening the Brain with extra mantissas of a different order **ALLOWED** the representatives of the Brain genotype 441 to **ACQUIRE** completely **DIFFERENT STATES** in everything. A sharp jump occurred in the "scientific" knowledge, which led to the practical application of revealed technologies for the implementation of machinery in all spheres of people's being. Alpine Complex significantly complicated the process of formation of the Administrative Programmed substance of Ebr state of Mind of the period.



As a result, a special awareness of the environmental "objective reality" by the individuals of genotype 441 provided them with the **OPPORTUNITY** to **IMPLEMENT** the Control Program process of being in a new form. Having realized themselves as a "selected and perceived some deep-seated mysteries of this World", they surrounded their circle with the sacral aureoles of different orders and clans, secretly getting all the authority in the Control of the World leading countries

under themselves. The process of formation of the organized financial system got activated and was brought into a state of complete **Control of the 441 genotype of the Brain**, with involvement of experts of other genotypes, disregarding all previous material authorities. The specified genotype in a short period managed to gain a **SPECIAL Administrative FUNCTIONS** in society, ignoring all sorts of law standards, and seize all legal and Control functions **IN EVERYTHING** that was connected with people's life arrangement, completing the process of getting the "power of money" as a very significant power function of the Control process.

With the introduction of the Brain new genotype both previous ones were not eliminated. They were subjected to constant Programmed and functional correction and development, including the development and improvement of values basis, adapting their own position and involvement in Executive processes.

Genotype 421 was applied to improve the processes of exchange, **PRIMARY DEVELOPMENT** of the value equivalents system, as a germ in the phenomenon of future financial systems on large areas where they did not live previously and did not organize such a system.

The previous genotypes of the Brain were replaced with a small but **SMART**, thrifty, and very **CRUEL** genotype both in decision-making and in actions on their implementation. Representatives of this genotype in a **SHORT TIME** have **GAINED** a leading and powerful position in all influential spheres of both the arrangement and Administration of the society's being.



Having more subtle logical structure and higher-level functional capacity in reception of the Administrative information, the representatives of this genotype of the Brain, **NOT POSSESSING** great representational quantity, were able in a short time to break most of the established stereotypes of the methodology values, structures of statehood and law, and got down to the processes of social transformation of societies on a large area almost simultaneously. Material values have gained lots of new forms and changed significantly in scale. Active development of the **RULES** and laws of the **NEW** exchange began. The society has got an impetus in the development of banking system and formation of the elements of the world finance system.

A steady and solid influence on all the process of being acquired the provided amounts of the circulated substitute. The control, possession and application of the circulated substitute (gold) were taken by the representatives of the Brain genotype 441.

All subjects' values and their basis changed ***under the dictatorial influence of sacral orders and clans***. The construction of the society's authority social structures, the formation of economic systems (economy) on the basis of slavery application of the "economy Man", Programmed accumulation of unsolved social problems – that was the way of training and polishing functional opportunities and abilities of the 441 genotype of the Brain. It was a **DIFFICULT STAGE** of acquiring the ability to Operate in tough and difficult conditions in the coming into being machine age.

Through practical activities of the performers of the 441 genotype of the Brain in a short historical period it was started the incarnation of the Programmed process of labour division, which played a crucial role in the decision of "ways of civilization development".

By the end of **1840** the leading position of the individuals of the 441 genotype of the Brain in the field of Controlling the societies began losing its power. Conflicts inside the clans and secret orders were growing in number. Disintegration and confrontation substantially affected their authority functions in the societies. The effectiveness of their actions and the legality of the performers dropped essentially. The Control System was getting ready for the introduction of a new Programmed genotype, and the World was to endure a bloody historical period for a century and a half.

1841-1990

By the beginning of 1841 the Programmed stage of the development and perfection of the Controlled state of the evolution of the 441 genotype of the Brain had come to **ITS END**. There began a **NEW PERIOD** of evolution of Ebr state of Mind. There was a requirement for the next stage of the Brain development, i.e. the introduction of a new regular genotype. In this regard, during the Easter of 1841 **the Alps 2** Complex was turned on in the active state, which by the introduction of the 442 genotype of the Brain symbolized the beginning of the fourth stage – the era of **DIGITAL INFORMATION CIVILIZATION** of human development, the stage of the bloody genotype hegemony, **1841-1990**.

FINANCIAL REVANCHISM having organized as the Programmed system, only began to gain momentum and was not able to assume **ABSOLUTE POWER** through the "power of money". It needed time, much of the legitimacy and massive scale. But "The Might of Power" with influencing participation of secret orders and clans, due to a number of their inner reasons, essentially reduced its Control effectiveness. Exactly at this "historical" moment, with lending the Brain **NEW MANTISSAS** the System through its Control Complexes, including the Alps 2, created all the conditions for significant changes in the substance of Ebr state of Mind at the time, strengthening it with aggressive destroying nature in everything. The introduction of this genotype of the Brain was very **IMPORTANT** for the old Control System. This step of development had completed a long stage of the Administrative developing process – preparation of the "Golden billion".

The Conceptual power leading performers' awareness of the surrounding "objective reality **WAS** entirely oriented and expressed in the "Might of power" for all a century and a half. While realizing this Program the executors arranged and accomplished stage by stage bloody way: **Revolutionism, Militant fascism and Destructive democracism**. All these and similar "**NAMES**" are brought in the text for better understanding the current processes, comparing them with our ideas, which, in turn, are **DIRECTLY** "connected" with our **KNOWLEDGE**.

This period the entire depth of the sphere of "knowledge" was only oriented on the development of technologies for the **PRODUCTION** of weapons – from military sabers and bayonets to weapons of mass destruction and their carriers.

The state of the "Authoritative of revenge" in sphere of Control, that lasted until 1990, allowed representatives of the 442 genotype of the Brain to fully accomplish their Programmed functions. They managed, on the bones and blood of hundreds of millions of people, to gain the unwavering authoritative state in all spheres of the world community being Control, create Programmed social and



governing structures of local and global plan, ensure the required volumes of accumulation and concentration of financial resources Control and circulated produced substitute in their hands, etc., and also prepare a different social situation for the future "Golden million". So this period by reason of distinct Programmed changes should be divided **into three stages: the first stage (1841-1904) – REVOLUTIONISM. The second stage (1904-1946) – the MILITANT FASCISM. The third stage (1946-1990) – DESTRUCTIVE DEMOCRATISM.**

1904-1946, Militant fascism

On the side of the System a significant Programmed correction and target reorientation of all Governing processes was carried out including the Programmed executive states of "**needs, labour and work**": the February revolution, the October coup d'état, the 1st World war, the seizure of power by fascists in Germany and Italy, the 2nd World war, etc. – Programmed processes, executed by the old System.

The Programmed process of the executive character for people – "The Elimination of 50 million of the used and dispensable individuals, as the aftermaths of the Programmed process of Energybiogenesis of the flesh cell". The executive actions in the active form of their manifestations started to happen only since 1934, further they turned into the Second World war. By the month of May 1945 (Victory Day the 09 of May –is also the Programmed process), the second stage of this period approached its completion. Is it Cynical? Beyond Human comprehension? Yes! But it was exactly that way. And all, that "historians" are holding forth at this subject **HAS NOTHING TO DO** about that. All this "history" had been done only for the sake of the certain genotype of people. I am sure that it is **ALREADY CLEAR** to you, Reader.

All the Governing correction of the Programmed terms on the side of the Control Complexes have been completed The process of the territorial

dispense in carrying out the general Programmed Control process of the two **MOST VALUABLE SPHERES** of being – **capitalist and socialist** have been recorded.

1946-1990 – Destructive democratism

At Easter, 1946, the General state of the Control System was switched over to the final stage of the realization of the Programmed processes:

- to conduct and complete mutually regulated antagonistic phenomenon of The Programmed development of the two specific goal-oriented spheres of being –capitalist and socialist as a single Control process of the developing the 44 genotype of the Brain. The introduction of some elements of liberalism, as the basic foundation of creating structures in the sphere of authority. The special purpose basis for the socialist sphere of being was the introduction of elements of democracy with relevant Governing design and the entire social construction;

- to complete the generalized preparation for the transition to the **UNIFIED SYSTEM** of power and Control structures on the liberal-democratic basis, which was to be the Control basis for the next stage of development of the Brain genotypes;

- to bring the Global Financial System Control organized on the basis of the **IMPOSED VALUES**, in the state of goal-oriented harmony with the basic principles of the Programmed process of the Global Control for connections into a single Control state the **"might of money and might of authority"** in order to complete the preparations for the transition to a new stage of development;

- to introduce the digital design basis of the Control System information, through the provided knowledge without gaining profound understanding of its essence, through the technological process as the underlying basis of digital technologies for the substitution part of the Brain functions and preparation for the transition to another level of separate Control of the genotypes with the subsequent stage.

While completing the third phase of this stage (i.e. by the time of "ripening" the executive states of "needs" to the level of full readiness, to dismantle all gained in joint efforts and distribute it according to the



belonging to a particular genotype of the Brain), the process of keeping back was both pointless, and inevitable. **ALL THE CARRIED OUT** Control was transferred to the base of digital technologies on all aspects, in both the goal-oriented spheres of being of capitalism and socialism. The Global Financial System made the most important qualitative leap, universally switching over to the electronic Control records and electronic money. They, in turn, began to have certain properties regardless of the nature of the use of the provided volume of the circulated substitute (printed money and their support).

The finance accumulation and technological preparation for the transition to the next stage of development of genotypes of the Brain had been completed.

1990-2009

The **Control Complex of the Alps** (Alps, Alps 1 and 2) gained their perfection. By the end of 1989 it had secured the carrying out of the final stage in the formation of the "Golden billion" (the genotypes of the Brain 44). The stable dominant power-legal and social position, unshakable possession and full Control of the main material values of the Planet, including the circulated "wealth" (substitute), by the representatives of the 44 and partially the 42 genotypes of the Brain were provided and supported. The transition to the next and final stage – the development of the 46 genotype of the Brain (the so-called "Golden million") started.

In 1990 California Control Complex started to work and entered into an active phase, it marked the beginning of the **INTRODUCTION OF A NEW 461 genotype of the Brain**. The basic server to Control these processes in Russia *was the object placed in Saint-Petersburg* (under St Isaac's Cathedral). Now, I hope, it became clear why St. Petersburg "team" "came" to power in Russia. And in the course of the narrative I would like to note that the programmed goals in the development of the genotype of the Brain was fixed on giving "the shirt" a higher level of Energybiogenesis, based on the **SIGNIFICANT INCREASE** in the period of its biological life and lending them more advanced parameters of the Brain by **SETTING DIFFERENT** functional mantissas and a certain raise of the octave of the Brain. However, in mid-2013, the "object" was "turned off", and the consequences of the work produced by it have been balanced by the introduced peripheral complex "Vyborg". Not the last role (in tactical terms) was played by the Generator that was moved from N, Levashov's Castle in France, but more about it – a little later. I just want to note that all the yelling of both the representatives of the Russian Orthodox Church, and of so called

"authority elites" around St. Isaac's Cathedral – are the consequences of the happened processes that are directly connected with the Brain activity of specific genotypes. But let us go on.

California Control Complex in line with the Program was to conduct a personalized formation of the object mind of **SEPARATE** individuals or **LIMITED** groups of them by matching their level and state with their Programmed functions. Such a process was to significantly change a lot in their authority-social status and position, provide a special legal basis for their existence and their executing the Programmed operations on conditions of the unquestionable legitimate state of “FAS” as the power from the Almighty, as well as to accompany and provide the entire sweeping of the power pyramid for the Programmed actions of the "Golden million".

In April 2001, the Program of the individuals' development of the imposed 46 genotype of the Brain (462-466) was **COMPLETELY ELIMINATED** as not realized in its performance. This significantly influenced the correction of the executive actions of individuals at all levels of the Authority of that time (governing, sacral orders and clans, religious confessions, administrative, military and law enforcement agencies of the local and international scale). Here I'd like to note that still there were some unattended actions of the representatives of this genotype of the Brain. And when in 2012 these unattended actions were interrupted, then we could see with our own eyes the **PROCESS OF DEGRADATION** (in all stages, up to aging and diseases) of the genotype of the Brain, which to this day has been (temporarily) in power.

The established executive circumstance has radically changed the performance, or rather, non-performance of the events previously scheduled



by the old System in the frame of already uncontrolled Target Vector of phenomena, actions and events. Their shaping of the Third World War (August 2012) as the earlier laid in Programmed process of events *function of the elimination of all individuals that are not related to 4XX genotype of the Brain* was **NOT** the **FATE** to happen at all, despite all the efforts and

attempts of that time! The old System support of this "important episode of the events" **HAS NOT EXISTED**.

The year of 2006 was the beginning of the "Golden million" formation, that is, of those who were to have perfect protection and direct connection with Ebr Control System. The rest were **NOT NEEDED** and could have been annihilated (a part could have been saved as serving staff). Reincarnation was also no longer needed. And ***"mother and child" – as well as the lifespan was to be regulated by Ebr Control System***, and the "Golden million" would have to "live forever", having all of the captured. No revolutions, no terrorists (for a transitional period it was necessary to form the desired amount of power structures to destroy them). Some, having information about the formation of the new protection and of the "Golden million," (**since 2007.04.03**) hurried to legitimize their rule (Ukraine, Georgia). With the introduction of the new protection it would not be necessary to support the tales about the Christ (there would be no one to tell). These were **Ebr** plans of **2006**. Exactly these plans were circulated among the Jews through their super priests. But there was one thing the selected "Golden million" **DID NOT REALIZE** – that **THE SELECTED** would have had only their "shirts", but the Brain would have been of that Ebr million, which was on the Sun. It is hard to believe it, but it was exactly so. And if you are able to comprehend the above written and will analyze the events that have been happening before your eyes, at least, since 2000, you will make sure of it.

In March 2008 Ebr Control System was destroyed. Serious systemic failures in all Complexes of the old System took place (the **RESTORING** original **SYSTEM** of the Earth Control interfered), which led to irreversible processes, and not only in the attendance and support of the Programmed actions of the performers, but also in the development of genotypes of the Brain. ***Since then nothing has been interfering in the recovered Control System of the Earth*** (that is what you can observe, if you have already learned to observe) to make sweeping of all the aftermaths on the Earth and surrounding space. But if you are "lucky" and you have "SvetL" Program and there is a chance for you to **"have the Bath"**, then there is a great **PERSPECTIVE** for Your **FUTURE**.

The Alien System Programs

The alien Control Systems	Brief summary
0-1840 AD	The "Golden billion" formation Historically, i.e. from the moment of the input Control frequencies for the "Golden billion", namely since 0 BC, large scale construction of specialized terminals such as churches, cathedrals, mosques, Buddhist temples and shrines of science started to build on the Earth.

	<p>When creating information networks initially in some nodes of Hartman zone translation information concentrators shaped like balls were placed. The diameter of the ball was from 2 to 33 cm, it had the properties of the piezoelectric element. It was exactly under such a ball a church was required to be build. By 1000 BC, the number of such concentrators reached 3260 balls, until Easter of 2009 their number did not exceed 1,000 units. At present, active balls in the Programmed Control state no longer exist. On the surface over such a concentrator a construction of a specific cult design was built; the total number of which, i.e. "correct churches, temples and mosques should not have exceeded the number of functioning concentrators.</p>
<p>500-year- long, 1500-2000 (recorded by Nostradamus)</p>	<p>There had to be created conditions for the formation of such a Man genotype who would be completely governable by the alien Control System. On one of the stages of the program in 1845 the creation of radiation web (a sophisticated design of energy gratings in the layer of -4400 m +12400) embracing the Earth was completed. After that, the Earth was supposed to be only for those who could be controlled using the properties of the web and such «Development Program", which would make it impossible to return to other methods of the Brain development. People (and animals) being connected with such a web, were conventionally called "electronics", that is with a chip in the "shirt" (according to the old Program).</p>
<p>Cosmopolitism – a 100-year long 888-1999.</p>	<p>The Program of cosmopolitism had the following objectives:</p> <ul style="list-style-type: none"> - setting a single financial Control; - introduction a single ideology for all genotypes of the Brain 421 (Ararat), 441 (Mont Blanc, Alps) and the unified system of information perception by making up tales, "archaeological" wonders, annihilation of all structures and bearers of a different ideology; - working out and creation of a unified mechanism of the society Control, testing technologies of societies Control, capitalism, fascism, democracism, liberal democracism, socialism, and so on; - providing Control over all natural resources; - preparation of conditions for the arrival of the Earth Ruler (Moshiach).

At present, **more than 70%** of the Control Systems, Complexes, objects and servers of the old System are destroyed, and those saved are either "de-energized", or **REPROGRAMMED FOR** the **TEMPORARY** use in order to ensure the smooth **TRANSITION** to a new state of being, especially in the biological field. As a result in **2011.04.24 the final change of the Governing System was done, that is the energy being Control is passed to the true recreated Control System and its Brain.**



The process of transition to another, i.e. earlier imputed true path of civilization development of the Earth with Intelligible orientation **WITHOUT RECONSTRUCTION** of the true Earth Control System is **IMPOSSIBLE** in itself. Also it is impossible to implement the real goal of the Earth existence and the execution of its basic functional endowment given to IT during Its formation, namely: in the process of implementation of **ALL EIGHT** stages of its discrete Integrated civilization development, in order to achieve perfect harmony of only **NON_INERTIAL ENERGIES STATE** and its Mind, finally becoming the hypostasis (entity) of the Universal Mind!

There has come very short but very rich in the phenomena the period of **TRANSITION** to the active state of the New Program execution, especially in the part where the Humanity's future directly and indirectly is **INVOLVED** in the phenomena, actions and events of a completely different format. The Programmed settings for the Control Complexes and Systems of the Earth to **SUPPORT** from the **OUTSIDE** have already been completed (as part of the **Super system** and the **System** for THE **SPECIFIED** execution **PROCESS**). In the next Chapter I will try to go on explaining and clarifying the specific points of the past events, and mainly, the events happening now and forthcoming. I do not stop perceiving and amazing at the fact how far **N. Levashov** "was able to see" (what was, and, most important, what is happening today and will happen). And this was **NOT A PREDICTION** but an objective view of the processes that have **ALREADY** been expanded and **ARE TO BE expanded in time**. The truth in its

everyday perception is relative, as a rule. Subjectivity and objectivity are not that diametrically opposed things, as it is regarded by the majority, considering themselves to be always right. And since the border between them is **NOT DEFINED**, it is not at all difficult to shift it wherever you want. However, I'd like to assure you that reading this book and making your own conclusions, you will not be able to do so. It is not enough to possess the truth; the truth should possess all of us. And it is becoming to be objective. But the **OBJECTIVENESS** is always **PROPORTIONAL** to **KNOWLEDGE**. And for me, that is another reason to go on with the book.

Chapter 3. Fundamentals of the material world and the formation of the Brain genotypes

...if you don't believe in something, "leading to collective hallucinations" the entire civilizations, first of all this something should be thoroughly explored in order to be able to oppose Faith to Knowledge.

It is no good to be satisfied with the achieved comprehension. Anyone is mistaken who makes efforts, gets some idea and then stops. First you have to make great efforts in order to **HAVE NO** doubt that you've got the basics; then to work hard to bear fruit — and this process never stops throughout your life time. Don't rely on that level of comprehension that has opened up to you. Just say to yourself again and again: "That is not enough". The idea that we live in an enlightened century, in the age of intellect, in fact, is **BASED** on **NOTHING**. We have enough information about ourselves and our Planet, but we **HAVE NO** idea about how to use it. Most of our traditions and patterns of behavior originate mainly from the so-called Middle Ages. For the early life forms it was not easy to get out of primitive slime, without catching up some of it. The same applies to rooted system of values. The most suitable place for the present day traditional ideas, in my opinion, is in a museum or in the books on the history of civilization.

One of my principal tasks is to come after the people who are **ABLE** to think and understand the happening. It appeared not so easy as I had thought. And the question is not in **PROVING** something in the events happening. The question is to **FIND** those **WHO** to prove. To find people who are able to think on a large scale. Not on the scale of a particular industry or knowledge of something, but on the scale of the whole Planet, however pathetic it might sound. What good is it to prove the correctness of the knowledge to those who initially take the **PROPOSED INFORMATION** for craziness? With the same success you can invite an old woman selling sun-flower seeds to discuss the project on millions. No honest, good, brave Man, **THINKING** in the scale "of seeds", is able to **TAKE UP** a large-scale work, or at least its comprehension. It is unrealistic for such a person, not

because he finds some defects in it, but because it is **BEYOND** his **PERCEPTION**.

To talk to people, thinking in the usual categories, on the subject **UNUSUAL** for its vast scope, is tantamount to talk to children. Most people, no matter how smart they are, will not take such a talk seriously. Therefore, people, in general, understand and share my position on the importance to transfer the knowledge I have got but not having large-scale thinking, **ARE ABLE** just to **TALK** on this topic. Even can "stand next to you". But they will **NEVER DO** anything specific. The person chooses what to do regardless of the presence or absence of the intellectual, administrative or financial resources. A very knowledgeable professor, a powerful official or an oligarch-billionaire are able to realize their great resources as an ability to implement some small projects (to build a country house, for example). An uneducated and poor person with microscopic resource can **STRIVE to DO** tremendous things. And this kind of people is growing in number. Here I mean the intentions and potentials. Whether it will be possible to implement them or not is another question. A thinking Man among the people indifferent to anything looks like a plane, moving along a city street. Everyone is honking to it, as it is in **EVERYBODY'S WAY**, but only because it is designed to **FLY**, but NOT to **RIDE**.

My life has convinced me that people always act not basing on the knowledge and understanding of reality, but according to their scale of thinking. That is, the scale of man, in this context, is not determined by the dimensions of the body and the number of lived years, but by the depth of thinking and attitude to the world. And then your scale of thinking will **DECIDE WHERE** the resource of your knowledge is going to be used unless, of course, you have it and go on increasing it. For example, in one case, for the formation of the situation in your Country or at least the place of residence. In the other case, to adapt yourself to the situation **CREATED BY OTHERS**. But it all starts with understanding the **BASICS** – the foundations of the world in which we live today. And who formed these foundations and in what way?

3.1. The basics

Life is the possibility of producing and carrying on metabolic processes. It is present only where **the Control System is created** and, in

relation to the critical ratios within acceptable, there is control and development of the environment that **IS** exactly the **OBJECT** of the control. There is no life outside the created environment unless there is another Control System. Modern physics does **NOT KNOW ANYTHING** about the Control System. Religion connects it with God, but shamans and wizards – with the presence of spirits. Everything that is known to science about the structure of microcosm are electrons, protons, quarks, elementary particles, etc., resulting from the accepted basics: **Solid body → Liquid → Gas → Unorganized plasma.**

Atomic structures are mainly investigated when considering only solid bodies. ***The Model of Bohr's atom is the main conceptual framework of both Mendeleev's table and Fleorov's table.***

The most fashionable name in science is "field", this name is given to any new manifestation of the electric charge properties. At the same time, it is reported that in Space there are **up to 5% of the "studied" matter, the other 95% are of unknown origin.** They are often referred to as a "black hole" ([press conference of the Russian Academy of Sciences](#), devoted to the Day of Russian science on February 7, 2006).

If **ANOTHER MODEL** of an atom is taken as the basis different from the models accepted and its existence is proved, then the entire science is scattered as science.

Atomic structure is dodecahedral-tetrahedral-cubic structure. The Central cube is a system of octahedra and icosahedra, embedded into each other (16 attachments). All the instrument base is created in relation to the Central cube; outside the cube it does not work.

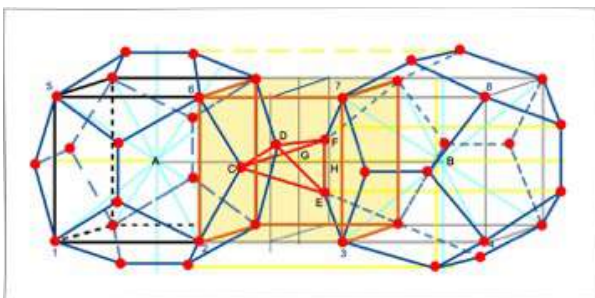

All frequencies in the atomic structure are built on octaves (powers of two). The basis for the construction of the Central cube **ARE OCTAVES** (brought by the Ebr system and unobtrusively embedded):

16, 22, 28, 32, 50, 54, 64, 66, 68, 72, 78, 88, 96, 112, 118, 122, 124, 128. Octave **128** is the maximum octave of **NO** longer **EXISTING** (interventional) Control System.

And some concepts:

- **potential of the octave** is an even, positive, maximum charge in a given octave $1.24^{(n1-n2)}$;
- **gravitational potential of the octave** – uneven, alternating, maximum difference of adjacent potentials $1.24^{(n1-n2)}$;
- **the angle of the charge sliding** – the angle of the charge turn relative to the node (for the central cube this value = 39.6°).

The structure of the dodecahedron with the nested icosahedron is unique – any attachment of this structure into each other can be calculated. The number of attachments – 44. Every other attachment increases the octave 4 times, the initial value =128. And the same is with "SvetL" Programs that are NESTED into the Generator on the basis of calculations.

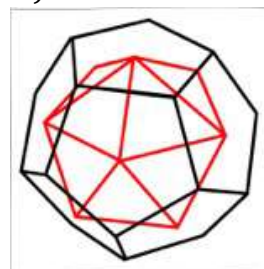

Dodecahedron-icosahedron

Layer	Octave	Energy potential (Octavian)= 1.24^n
1	128	907769738083
2	512	679051640990112193876920710485206529207942810790

When removing the potentials from only the 2 layer of the dodecahedral- icosahedral structure the reserves will last for hundreds of trillions years, that is, energetically the Control System is fully secured (that means that energy can be taken and used), and even if there is another "Great Explosion", it could be "seen from the Earth" (according to present day physicists). And if such knowledge provokes **GasPROM** or **RosPetrol** leaders infarct, it will only be welcomed.

The Earth Control System is engaged in energy distribution and providing chargers with necessary potentials. At its disposal there are specialised Control systems. It should be noted that the atomic structures have to be considered from the top down, that is **Highly Organized, strictly distributed in octaves: Plasma → Material structure (gas, liquid, solid body)**. An atom study in a solid body is a finite structure, and not the only one, as it is considered by the present physicists.

The results of the Program implementation.

1. The sequence of the creation of genotypes of the Brain and the introduced functions.

We consider only Complexes of the Caucasus, the Alps, and California.

Complexes of the Andes (the basic complex of the experimental support) and China Complex are considered separately.

Ararat Complex created the **FIRST** Brain genotype **421 in 1605 BC**.

Kazbek Complex created the Brain genotype – **422 in 822 BC**.

Elbrus Complex created the **genotype 423 in 00 AD**, completing the formation of **the first group, i.e. the genotype of the Brain 42**. The genotype of the Brain **423**, as more perfect, **WAS THE BASIS** for further development of possible additional executive functions of individuals of a higher administrative order and further improvement of the Brain genotypes.

In 1433, the first Brain genotype **441** was created (control complex of Alps 1).

In 1841 the first Brain genotype **442** (Alps 2) was created.

In 1990 the first Brain genotype **461** (California) was created.

While creating new functions for the individuals with the new Brain genotype new **MANTISSAS** were **INTRODUCED**, providing the execution of new, more complex functions. The change in the number of mantissas of the Brain genotypes, while introducing them, is shown in the table.

Nº	year	421	422	423	441	442	461	462	The object of energy supply
1	-1605	12	-	-	-	-	-	-	Jerusalem
2	-822	17	12	-	-	-	-	-	Samarkand
3	0	26	15	12	-	-	-	-	Byzantium
4	1433	28	22	18	12	-	-	-	Rome
5	1841	36	28	24	18	12	-	-	Paris
6	1990	36	28	28	24	18	12	-	Saint Petersburg
7	2009	36	32	32	28	24	18	12	Moscow

By 2012 it was SUPPOSED to BE completed the second cycle of formation, i.e., of all individuals of the second group with the genotype of **the Brain 46**. The first cycle was completed **in the year 0, but to be more exact – in 0000-01-17 at 02-11**.

2. Life support of genotypes in the process of their settlement.

In the process of formation of new mantissas, along with the capabilities of the Control Systems (the Caucasus, the Alps, and California) there were used limited territories of the "cupola" type that were created by

objects **440**. The borders of the frequency range generated by objects of type **440** formed a compact territory, which was the only **SETTLEMENT** of **NEW** genotypes in line with the object Program. Here is **an example**: the Hungarians were moved from the Urals to Europe, the attendance object flew there too, and there it "pressed" local "cupolas" without wars.

If you don't consider the artificial division of the borders, the formation of the places for genotypes settlement **WAS COMPLETED** in the **XVIII century**. After this there was provided an independent "opportunity" to demonstrate the advantages of the Brain genotypes over each other, **TEST THEMSELVES** and reveal weaknesses, as well as identify ways of "reconstruction" through the subsequent addition of mantissas. There were quite a lot of territorial claims clearing up at this period and, essentially, for no reason at all. It should be noted that **genotype 423** is a **VERSATILE BASIC FOUNDATION** for developing the whole range of mantissas and their further improvement; their actual code is **423xxx**, where "xxx" is functional and another kind of genotype. If the primary base for the formation of individuals of this Brain genotype was formed in Byzantium, its continuation in the future was worked out on the territories of the East of the Ukraine, parts of Russia, West of Belarus, parts of the Caucasus and East of Bulgaria

Territorial consolidation for the existence of individuals with the Brain genotype **423xxx** was provided with all the accompanying organized opportunities of the objects and systems to which mantissas of this genotype were adjusted in all their diversity. This applies to all questions of being, which will be **CALLED DEVELOPMENT** of civilization by scientists. In fact, it was a common programmed target process of the development of genotypes of the Brain and the fulfillment of everything that their being required.

3. The formation of reserves.

The entire quantity of different types of individuals for all the resulting genotypes of the Brain as many as they were formed, had to be **ATTENDED** and **PROVIDED** with all the complex of necessities for their existence. Not the exception but **SPECIAL ATTENTION** was paid to the support of the attaining the biological mechanism and providing appropriate nutrition. The Control System attended the digestion process and provisions in such a way that the **METABOLIC PROCESSES** corresponded to the installed mantissas for each genotype of the Brain.

In the countries of South-East Asia even spiders are used for food but their metabolic processes about **1.4 times** faster than the rest of the people, that is why spiders are eatable for them. But individuals with the genotype of the Brain **423** cannot eat them, for them "kebab" is more suitable. All attempts of the nutritionists to impose the results of some of "their own research" are aimed only at the destruction of that harmony, which **HAS NEVER BEEN** available in their brains, and is nothing more than farce, and business.



It was necessary not only just create the reserves of food, but to teach all the necessary technology to acquire reserves on their own – ***to learn to grow and make reserves of the required food for each individual according to the characteristics of their genotype of the Brain.*** It was necessary to check all the harmony of **ENERGYBIOGENESIS** of the **"SHIRT"** as a process of harmony with the introduced mantissas.

"An experimental ground" was set up under the Andes Control Complex. The local population had been input all the necessary experimental mantissas of all possible future genotypes of the Brain, and for centuries they had successfully experimented with sea food, animals and cereals, practicing tools, fishing gear and technology of growing and harvesting and stocking - up. Up to the present day, the major stocks of commercial fish are off the coast of Chile, and the population of Peru (Maya) as a result of experimental studies has ensured that **more than 90% of cereals** which they had grown

are used around the World today. It is interesting to know, that the cultivation of cereals was on **DIFFERENT** mountain **ALTITUDES**, *which corresponds to the different climatic conditions along the parallels on the Earth*. So, in the lower tiers there were grown tropical fruits, higher – grains, and further up – potatoes, and so on.

Modeling the surface of the Earth was on a fairly small area under the control of the Andes Complex. After completing the experiment all the *mantissas were removed from the population and the Maya settlements disappeared*. By the way, the first ramps were discovered in Ecuador, the first pyramid above the objects – in Peru, the Isthmus of Panama, in Mexico. And there is no need in **ANY LEGENDS** and excruciating "scientific" fantasies about the Mayan settlements. That was only laboratory work and nothing more.



4. *Formation and functions distribution.*

The main task of the Control System was the creation of such biostructures, the Brain of which **WOULD** fully **COMPLY** with all the Programmed set-ups of the System and be fully governable. In so doing the embodied governing of the entire individuals' being and the society's social organization had to be **ONLY IN the FORM** of a **PYRAMID** (because it was required by the imported basic foundation when constructing control information). I am saying it again that:

Level 1 – Moshiach (Allah, Buddha, etc.), the genotype of the Brain **481**.

Level 2 – "Golden million", the genotypes of the Brain **461, 462, 463, 464, 465, 466**.

Level 3 – "Golden billion", the genotypes of the Brain **441, 442**.

The "Golden million" are priests, finance managers, science and socium administration, as well as distribution of all kinds of material goods and services.

The "Golden billion" – production and replenishment of material goods, training and providing service staff.

The rest of the population was not required and **COULD HAVE BEEN ANNIHILATED**. But to annihilate a few billion people overnight is impossible. Or rather, possible (as, for example, dinosaurs in their time), but it would cause an ecological disaster. Therefore, the process of "annihilation" from generation to generation was "launched" over a hundred years ago, and it started with the "invention" of pills, vaccines, genetically modified food, and the like. And second – all the plans associated with the third World war from both the USA and the USSR, which are now becoming public are the plans for the **ANNIHILATION** and **REDUCTION** of the **POPULATION** of the Earth in accordance with the Programmed processes of Ebr Control System.

5. Consideration of the results.

Back to atomic structure.

The outer contour and tetrahedral connections are built using the rules of the Golden section. The Central cube, as the basis for the mantissas construction, was created by the interventional system using primes. However, with the explosion of Phaethon (the planet blew itself up along with those who were close by), there was **DESTROYED** the interventional archive of the primes **over octave 128**. It turned out to be the main **OBSTACLE** for the formation of the Brain (mantissas) of the following genotypes.

Let me remind you how the desired frequency is created. In order to create an individual with the genotype of the **brain 481**, there must be the Brain **NOT BELOW octave 512**, but the control of this Brain should not be below octave 533, and the beat must not be below octave 548. The calculations are omitted.

Rules of formation:

- find all primes in the range of 512-548 octaves;
- transfer all found Prime numbers to 8-and 12-th number system;
- select only those primes that have related ones;
- select from those numbers that have in 8-number system ending "777" and related "001", in 12th-system "BBB" and "001";
- add primary and related numbers;
- when decomposing the result, the number of quantizations is the octave, the number of "5" is the number of ties with Penta (the icosahedron) must not be more than 12. number "3" is not permitted when decomposing the series;
- the rest of the decomposition must be within the tabular value set only for material structures.

If there was a necessity to create new pyramids, they were created.

Let's recollect Pushkin – The Queen of Spades ("3"), 7, ACE (B/11).

Proceeding from an extensive range of numbers and the rules of allocation of frequencies, it should be noted that to solve this problem and reach the goal it will require trillions of years. **But the Earth Control System made a different decision – curtailing the existing Programs and the ELIMINATION of ALL the imported interventional waste, namely:** "to lose in the calendar the last 2000 years", to return to the state of **the 0 year of the New Era** and start formation of a different "Golden million". **But it has to be done only with the proper use of the Golden section.** In so doing, all the individuals created after 0 year, are transferred to **the state of 423 genotype (Control – Elbrus), and the genotypes 421, 422** will get the properties of primates in their DNA in accordance with Darwin's theory (by the way, the first individuals appeared among his friends) that you can clearly watch, especially on TV.

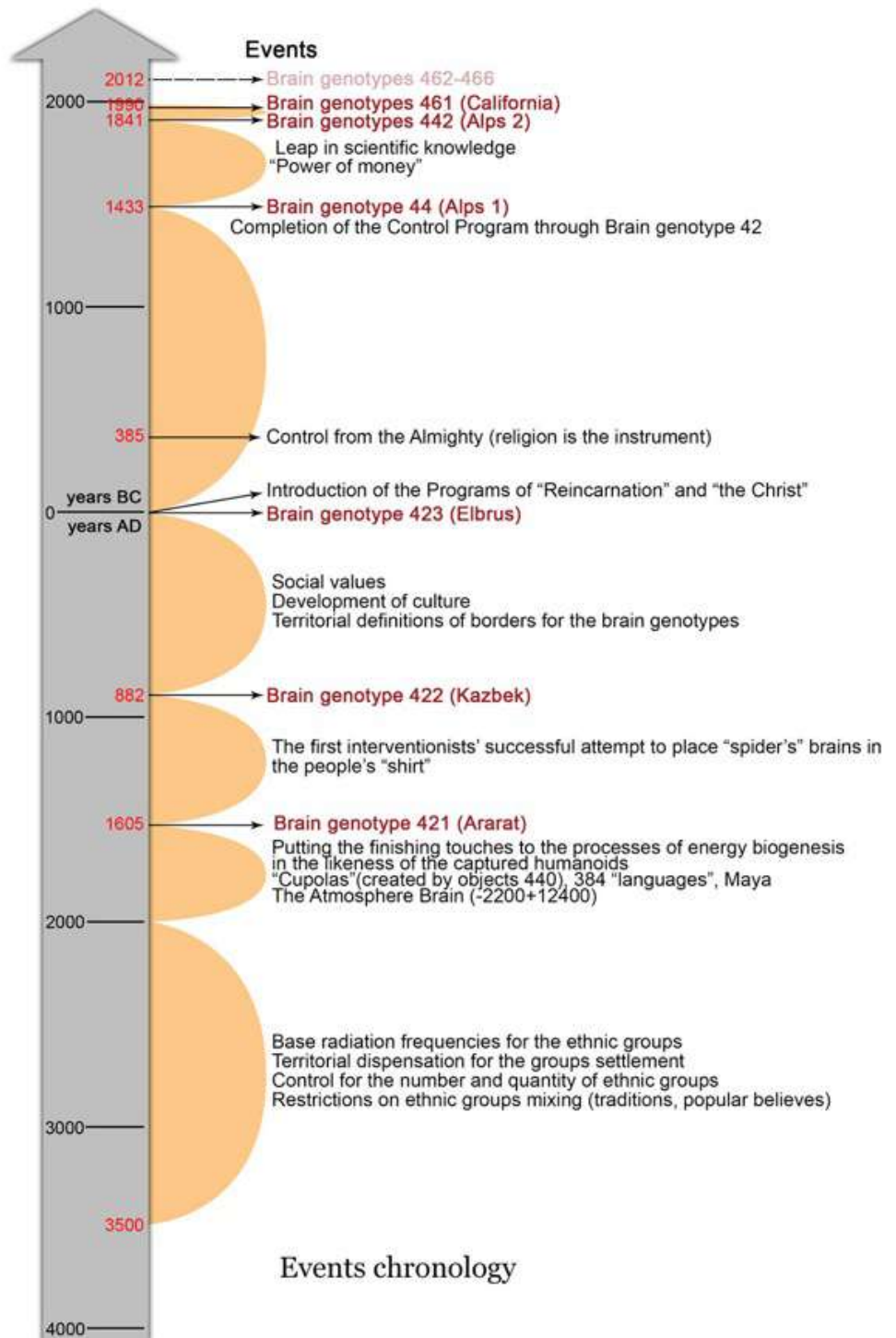

What will be changed with this transition in the former genotypes **421 and 422:**

- mantissas formation of lymph, bones, muscles are to be changed;
- mantissas of metabolic processes – sight, hearing, touch, smell are to be changed;
- mantissas of metabolic processes – breathing, processing of food, motor coordination are to be changed;
- mantissas of blood circulation and mantissas of the circulatory system are to be changed.

It is directly connected with full **UNPERCEPTION** of the reality changes of the environmental and habitat conditions. The number of "predictors" is growing like a snowball, especially in the Ukraine; they only speak with difficulty and inaudibly. However, there will not be any Apocalypse and coming of the "Antichrist". The tales have been ended. Here, in **NOT** that **EASY** situation, the main supporter is "**SvetL**" **Program**. But we should not forget our own **STRIVE FOR COGNITION**. Otherwise, the Program will provide a "comfortable" living out of your "shirt" and not more.

In the first place, the Brain (along with the bearer) of drug addicts, alcoholics and representatives of the criminal world is being destroyed. By the way, passion for money is recognized as one of the forms of drug addiction. As the authorities that are mandated to observe the concept of the Program, have taken the state of passive waiting, they will be replaced. Today the authorities' unwillingness to really clean up drug abuse, alcoholism, bribery, child molestation, ritual murder, and the like., are regarded as complicity.

6. ***Start of the new Program.***

The start of the new Program in its full aspect is to be implemented in **2020**. Now all the preparatory transient processes are in full swing. Until **2020** it is planned to significantly reduce the world's population. It **SHOULD** be taken **CALMLY**. The Moon will be withdrawn for 1,500,000 km from the Earth, all the satellites of the planets will be assembled around the Sun, the structure of the Sun is due to be changed and many other events are to take place... These processes for the last 10 years has been occurring before our eyes. Today, they are clearly visible.

3.2. Object 440 (Variant of the Alpine Complex)

Alps 1 and Alps 2 had their own objects of type 440, that differed from the objects of type 440 in the Complexes of the Urals, the Caucasus, Kailas and others.

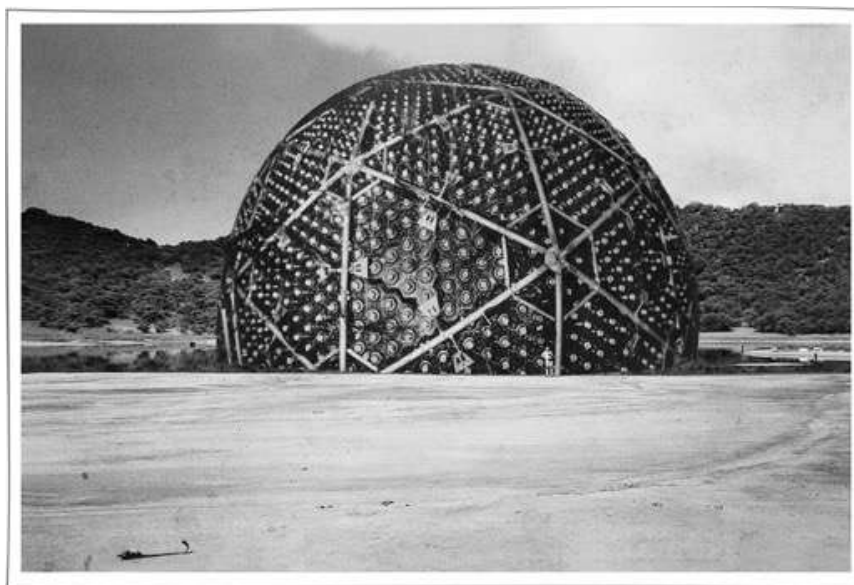

An object of type 440 has made a temporary landing

After appropriate transformations object 440 disappeared (optically it was longer visible). The object itself, as a plasmoid, went to the depth of 4350 m and was in the structure of the energy-information grating.

When receiving a command, the object raised for the execution of other input commands (including the use of the weapons). And now this object, as well as others will never go up. All the exit Programs have been disbanded.

The main characteristics of object 440 were (The Alpine variant):

The object had three separate system Generators (E-M-G): electric; gravity; magnetic (impulse shaper). The pilots did not have most of the structures, all the existing structures were minimized so that the transition from 31 to 57 octave was made without loss. The range of the laser system was dependent on the height (at the altitude of 2000 m it was possible to make destruction to the depth of 50 m). Protection rings had in their structure 2382 mantissas for all atomic structures (when a foreign action took place it was liquidated not only the object of action, but also the environment of the object).

No	Feature		From	To
1	Diameter in 31 oct. (max)	48 M		
2	Diameter in 57 oct. (max)	2,4 M		

3	Weight in 31 oct.			106kg
4	Weight in 57 oct.	-		
5	Landing depth (57 okt.)			4350 m
6	Lift height 57 in oct.			12400 m
7	Lift height in 31 oct.			4800 m
8	Flight range, km.			8500 km
9	The number of protection rings(1*)	4		
10	The number of pilots	12		
11	The number of laser systems	6		
	Range			6,4 km
12	Electric power	1046 watt		
13	Change of gravity, m/sec ²		-12,4	12,4
14	Transit time in 31 oct.			2 sec
15	Transition time in 57 oct.			7,2 sec
16	The processing area			12 km ²
17	Material 31 Oct.	Os187		
18	The number of mantissas in 57oct.	666		
19	The number of mantissas in 31 oct.	248124		
20	Passengers number in 31 oct.			884
21	Passengers number in 57 oct.			44
22	Command language	Russian		
23	The number of generators	6		

The Mother-ship (transport base) for **ALL OBJECTS** of type 440 was the Moon. At the Moon-Earth connection a **TEMPORARY TUBE** was created, through which the plasmoids in 57 octave arrived in the Earth.

On the Earth before the objects landing there had been prepared not only landing sites, but also storage space, and energy-information channels had been laid out. **Energy-information channels** linked each object with the corresponding Complex, with the Control System, with the Complexes Control System, and with **PUMP-UP CENTRES** (like Bermuda, for example).

Taking into account that all the objects of type 440 were continental-based, the transitional processes were more complex than those of the sea basing objects.

Objects of type 440 had four kinds of their state transformations

A) 31 ↔ 57 taking off and landing.

B) 31 ↔ 57 cleaning out the area (all modern deserts are the traces of the **FORMER CIVILIZATION** annihilated during the invasion).

C) 31 ↔ 57 flights to the Moon and back.

D) 31 ↔ 57 passengers transfer.

Additional features of the objects of type 440 were:

№	Computers	Features
1	Number of Computers	12
2	Used gas to clear indications	Xenon
3	Elementary memory cell	The Star of David (12-6-3 number system) *
4	Word size	6
5	Size of the text's cell	144
6	Beat period –reception -transmission	0,0555 sec.
7	Reception- transmission table	12*12
8	The process data time (calculations)	124 tera Herts
9	Method of information storage	Optical, on 59 octave
10	Memory capacity of a computer	484 tera David
11	Number of language translators	336
12	Screen stop-frame (outward) 1*4 м	0,036 sec.

Information on the computers objects came:

- from the Control System (12 number system);
- from other objects (6 number system);
- from Biostructures 42, 44 of the Brain genotype (3 number system).

Regardless of the number system, the received information in coded form was stored in one memory cell and then was transferred to the processing in 8 (octal) number system, that is the type of the Star of David, kept the information in 4 number systems simultaneously. In the 57 octave the computer worked in the automatic mode, and in the 31 octave pilots **USED** the **INFORMATION** processed on the computer.

Objects of type 440 had their own Generators for octaves 67-127, as well as their own **SYNCHRONIZATION** of **BEAT** time, which is important for all the octaves of this range. In addition, they had their own calendar and their Program (which was turned in case of the incorrect use of the general Program). For each period of time the object had 6 emergency programs and, in such a case, the object made a take off and an initiatory correction of the External Program.

What was the emerge mode and the sequence of actions of the object? If you are interested, you can find it in the writings (calculations) of **A. Khatybov**.

The pipe for the object's type 440 exit is a **CHANNEL** of **PLASMA**, so the external contour of the object at the exit (entrance) had protection in the form of plasma indestructible ball. After completing the transmutation in compliance with the program the object used the E-M-G Generators (Electro-Magnetic-Gravity) with the private reserve of electric potential.

3.3. Cluster System of the Control

The old Structure of the organized life of people in all spheres of their lifestyle at all stages of social and civilizational development **is the Super-Kluster System**. It was **IMPOSED** from the **OUTSIDE** by interventional interference in order to get the "complete" governing and provide the state of all round control over all the processes associated with the execution participation of people under the conditions of their **CONSUMER GOODS APPLICATION** while carrying out two basic interventional Programs of Ebr System – **"the Development of the Brain genotypes" and the "Development of Energybiogenesis of the flesh cell"**.

All the versatility of such control covering, including all the gradually evolving spheres of life, preventively matching all of this with the energy-information translation of the cognitive and control character on the side of The Control Complexes (the Caucasus, the Alps and California) involving the execution participation of people – all of this was perceived by them (i.e. by people) as a "natural" process of civilization development. The entire Old Structure of the organized being was represented by separate clusters of the preformed structures of all spheres of people's communities being, geographically located and distinguished by the specific Programs of their development, under the strict guiding of the old interventional Control System.

The former Structure, as a Super Cluster System suffered a historic collapse, starting with the elimination of energy-information translation from the Control Complexes of the old System. The principal Control Programs were eliminated in 1985.10.25 (simultaneous earthquake in Israel, Italy and Australia – the servers elimination, Programs depositories). In this regard, its further existence is very short-lived. But in the current time processes – it is also an atavism of the alien to the Earth and Human "civilization", which is being ELIMINATED by the new (being recreated original) Control System. But this does not mean that such a process has been let matters drift, without a concrete expression in time. You may remember that there was an opinion of the "visionaries" who persistently created panic fear among the people "predicting" Apocalypse; and professionals who stated that such a TRAGIC ACCOMPLISHMENT had been targeted for the end of 2012. HAD the old interventional Control System NOT

BEEN liquidated, then with high probability this might have happened as the programmed process of the former control from the outside. But since 2011.04.24 (the change of the "System Power") all the processes of the clustered arrangement in the former organized being structure, understood as processes of "social development", have been subjected to fundamental correction within the Transition period. **The primary signs of this have already been accomplished and are perceptible in the form of irreversible obvious crises in all spheres of people's being.**

Why?

Before answering this question, you have to understand what is meant by the notion of **cluster superimpose on the processes of social development**. Is such a judgment correct when studying the processes of social development? Has **CLUSTER ARRANGEMENT** in the construction of the controlled life of people's being taken place in general? What does the term "cluster" include in relation to the processes of people's being?

Cluster (Eng. Cluster – congestion) is a union of several homogeneous elements, which can be considered as an independent unit with certain characteristics that are common for each associated element. Such understanding of a cluster when considering the system of formations is used rather widely both in studies of the microcosm and macrocosm scale. At the moment we are only interested in the cluster systems of the structural elements that directly affect people's being and everything that is associated with this process.

Regarding scientific aspects of the so-called Stellar mechanics and the knowledge concerning guiding system associations in the frame of civilizations development as processes of the programmed being this concept of cluster is also acceptable. With the concepts of some of them we will have to cross over.

The celestial cluster (congestion of stars)

This is a group of stars, on the one hand, connected by the tubes (gravitational, informational, and others), representing a specific model structure of guided energies being within the imposed strictly identified range of energies octaves. On the other hand, such a group represents a single programmed – control process of its civilization development, in

which each element of the complete (a particular star or group of them) **IS IMPOSED UPON** with certain **FUNCTIONS** that are complementary or ensuring harmonious existence of the whole cluster. It is an embodiment of the specified and controlled civilization development or other programmed role and application in cluster systems of a higher order.

The Galactic cluster

This is an independent superstructure, which is a certain set model structure of several Galaxies. As a super cluster, it has a **SINGLE** programmed functional **EMPOWERMENT** and a unified system of governing, control and attendance of the complex civilization development of each complete of galaxy, the system of formation and harmonious distribution of the whole limit of the imposed energies octaves in their both material and immaterial conditions. The Galactic cluster, like a design, has a multi-level complicated structure of connection tubes between galaxies and celestial clusters in each galaxy.



The civilization cluster

This is a group of civilizations with a single programmed functional empowerment for the period of a particular stage of the governing civilization development. Unlike other cluster systems, each civilization cluster is represented by a model of a well-defined number of stars (planets), unified by a single system of the programmed civilization development, as a structure of studying character. The uniting of all complete constituents

(planets) is due to the formation of only the connection tubes (governing and control), through which the governing process of stage by stage civilization development is carried out as it is. In fact, it is the embodiment of the part of the process of quite specific programmed harmonic control according to the orientation of civilization development on a global scale. If in a simple way to express a kind of cluster similarity of the gradual civilization development, acceptable to discuss in a secular surroundings, such similarity can be compared with the **GRADUAL EDUCATIONAL** development of people, namely: primary education, secondary, higher education, further qualification and the development of their professional excellence and improvement of their cognitive level. Each individual stage of civilization development is a very specific stage in time to engage a set of strongly-identified (designed by the program, i.e. functionally endowed) Planets for the temporary systematic cluster association for the passing (the assigned planets) their indispensable civilization development.

The determinative indicator in achieving results of such civilization development in each stage is the achievement of **HARMONY** of energies **BEING** in their material (inertial) and non-material (non-inertial) state in all the range of octaves of the planet's (group of planets) energy model, imposed upon them for this **SPECIFIC PERIOD**. For the planets of Intelligible orientation the absolute measure of perfection is also achieving the desired (preset) level of development of the Planet's Mind for this stage of development. Not superfluous is to remind that, with respect to the Earth the development of the Mind of the Mankind (not the society of people) – ***is a part of the developing Mind of the Planet.***

With regard to the modeling complex of the Earth, the initial phase of its first stage of civilization development was getting its perfection under guardianship control on the side of the **Civilization Cluster of "Orion" group of Civilizations** (the phase of "preschool education"), ***which includes 384 Civilizations (the number of "vacancies")***. The subsequent phase of its first stage of the Earth civilization development would have been under guardianship of the **Civilization Cluster of "Sirius" group of Civilizations which was to unite 784 civilizations (currently 783 due to the lack of one "pupil" in this cluster – the Earth)**. But in the time of the events of the transition state of guardianship from "Orion" group of civilizations to "Sirius" group of civilizations (as the most unstable and poorly protected transition time to control the Earth from

outside) **there was an interventional interference of the DYING Ebr civilization CLUSTER, with no prospects of its development .**

Since that moment (almost 18000 years ago) the process of civilization development of the Earth itself has **LOST** its goal-oriented and governing **INDEPENDANCE**.

This is a superficial explanation of why and under what circumstances the intervention took place, and how it all could have happened. **For the Universe scale 18,000 years is an INSIGNIFICANT VALUE** of time, but, nevertheless, in the time of the events all the processes of recreation will be corrected by the compensation for such loss of time in the pace of civilization development.

At present, i.e. after the change of the System of power (**2011.04.24**) and the **COMPLETE DESTRUCTION** of all the imposed programmed processes of the interventional control on the side of the external Cluster of Ebr Control System, the **MOST COMPLEX** systemic **TRANSFORMATIONS** have been taking place on the Earth. **These transformations are strictly oriented and connected with the liquidation of the consequences of the interventional interference and leading all control states as well as the Structures of the CONTROL of energy BEING to the level that our Planet had had at the time of the state of leaving the guardianship of "Orion" group of civilizations.**

As soon as the reconstruction of previous states of energies (in their inertial and non-inertial constructive form) are completed the true Earth Control Complexes will be restored, and also recreation of the previous levels of the control of the entire energies being will be completed – the Earth will move into the second phase of the first stage of its civilization development, i.e. will be placed under the guardianship of **"Sirius" group of civilizations. By this point there have to be recreated all the former environment and habitat on the Planet, got (restored) the states of controllability of the changed environment, recreated the Man himself with a new level of higher octaves, and also brought to harmony with the general changes the Design of the organized being – THE HUMANITY**, and many other drastic changes, including flora, fauna, water, etc. Exactly this way there will be recreated **THE TRUE CLUSTER** of the complete state of the Earth civilization development control which it had possessed at the exit from "Orion" group of civilizations. And only then there will be possible and allowed "From the

Above" the real transition to another subsequent level of the civilization development of our Planet.

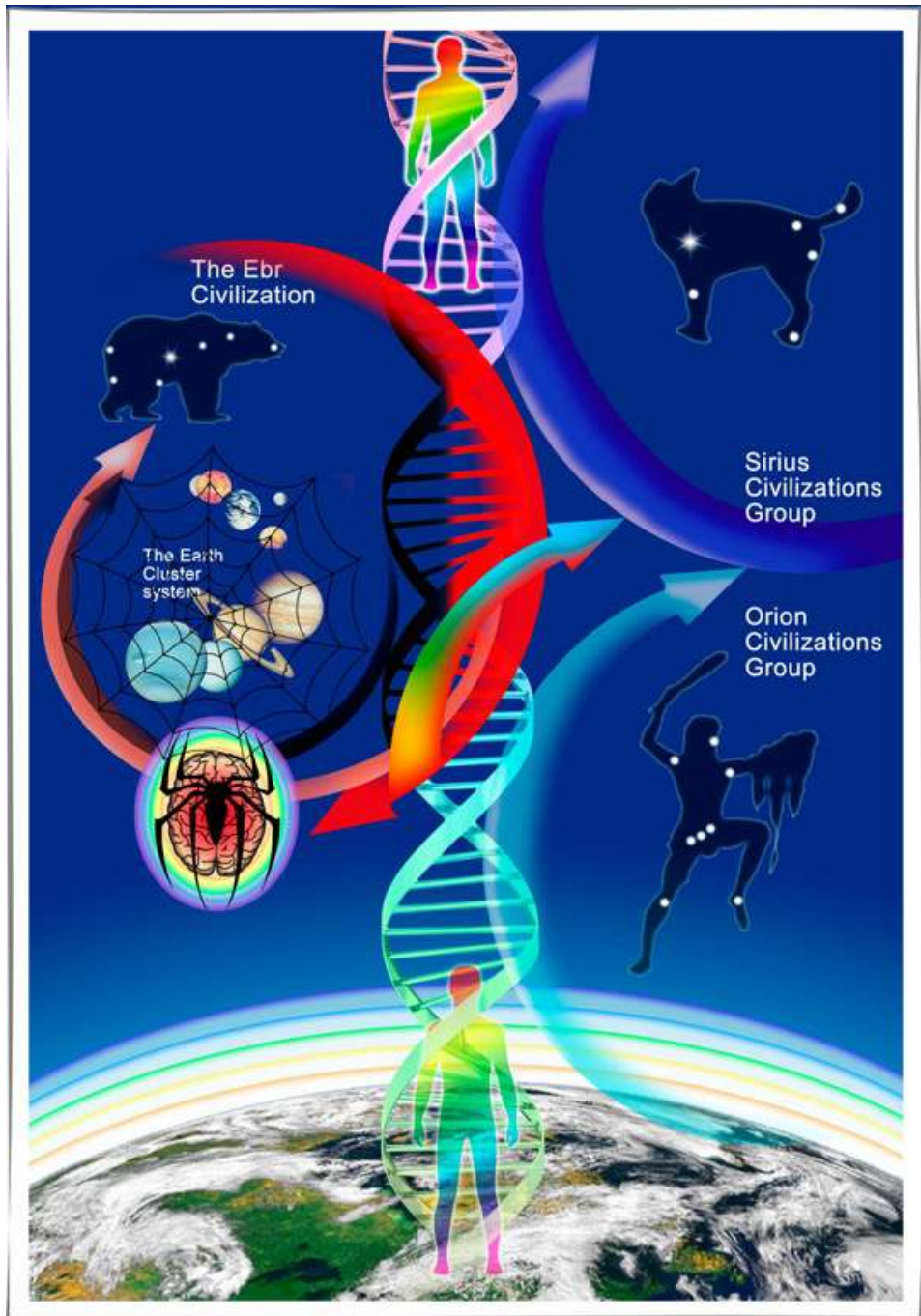

The Planetary cluster

This rigorous model Design of **a SINGLE PLANET**, is represented by a complex of energy gratings of the entire range of energies in their material and non-material relatively stable conditions. Such a Design is shaped to give a harmonious guided being, and to provide the necessary programmed indispensability in the process of the embodiment of the current stage of civilization development. A model cluster design must have a System Complex of the autonomous control, which **would be capable of:**

- ensuring the implementation of the Planet's functional endowment at every stage of its civilization development;
- organizing, governing and controlling the harmonious existence of all the imposed range of the octaves energies at every stage; directing the entire process of its development within the framework of the inserted Vector of target, phenomena, actions and events, as well as adhering to the time beat in its own and general chronicle of events of the system clusters of a higher order.

Planetary clusters having (endowed with) living conditions, additionally have Systems to control the most complex process of the composite conditions of the life support, rigorously monitoring and ensuring the harmony of being of all the imposed diversity of living individuals (entities) and distinguished forms of tangible and intangible coexistence. For all that, all sorts of state of hegemonic parasitism of one over the others or quantitative beyond the programmed (uncontrolled) prevalence exceeding the level of the programmed mutual sufficiency, are corrected through the Control Systems and eliminated to the level of necessary sufficiency.

Planetary clusters, with further vesting in the development of civilization of Intelligible orientation, have in their control System: control Complexes, objects, Systems energy information translation and communication, which all together ensure the formation and retention in the stable state the **ENERGIES** of **CONTROL** – the **MIND**. The Mind as the highest constructive state of the specific control energies takes the form of a very specific "energies-substance", which, in turn, has the property to develop up to those controlled limits, which were according to the **PROGRAM SET IN ADVANCE** to the Planet while imposing it with a specific function.

On achieving complete harmony of all the states of energies, within the imposed octaves and gaining a level of the Mind development, reaching the

designated limits, and ***keeping the Mind substance in a stable condition***, the Planet is transferred to the next stage of its civilization programmed development. **For all that a new, higher level of energy octaves in their immaterial and material states are imposed.**

The cluster of social development

Many representatives of social sciences correlating their world outlook only with dialectical materialism present the process of social development as self- initiated manifestation of the society's civilizational development, subordinate to certain ("invented" their own classics) mandatory laws. They also present with confidence the fact of **RANDOM ASSEMBLENESS** of the **SOCIETY**, according to the will and desire of the parties, as a "natural substance" and only to "meet the requirements caused by nature" in the process of the forced joint cohabitation. ***In order to justify the very existence of such a forced "natural substance", and in addition being embodied in the regularities dictated by them, concealing the true reasons of the imposed violence and the entire social restrictions of the overwhelming majority by the insignificant minority, they put forward a number of "indestructible theories", which were positioned on their side as "perfect" and with certainty in time, for not less than "all future ages," i.e., forever.*** The truth is that all the fabrications of a sort of "political wise men" **SUDDENLY COLLAPSED**. They are no longer able to fabricate other theories, and as for the future- they are not even able to formulate it. Is it loss of vision in an uncertain "bright future" or clouding "of the mind and the eyes"? The Control of such a complex programmed process is performed with the help of the forming Cluster of social development. But it should be preventively declared that the indicated Cluster **HAS NOT TO BE CONFUSED** with the state apparatus and all its instruments of violence, as they have been mixed up into a single concept by the current and previous social scientists. What does it represent, what are its main functions?

Eventually, the Cluster of social development, in contrast to the claims of social scientists of the past, is a COLLEGIATE STRUCTURE of the systems control from the outside on the part of the Control Complexes and their servers. Its main goal is the ***formation of the current state of social consciousness*** and continuous monitoring of the level of its states by imposing energy-information translation for the formation of future specific executive

people's actions and preparing the programmed set of events with their participation.

The cluster of social development "formed and stipulated" the **ENTIRE SET** of executive states in the midst of the people's society **through their social consciousness** and was the shaper of the society's "perceived" thoughts to further control of them by the Cluster of the state control. As you can see, it's not the same thing. Moreover, their functions are completely differentiated, but mutually harmonious by their controlled embodiment.

The Cluster of state control.

It, at this historical moment, is of the greatest interest, as it is that very **Structure of the controlled organized people's being**. The Control is still carried out unattended, as external (i.e., from outside, by the interventional Control System in the past) as well as the internal control through the organized "instruments of state violence."

The structure of the Cluster of state control under the old Control System was based primarily on:

- the programmed current target Vector of future phenomena, actions and events corresponding to the time of events of the chronicle process;
- the imposed targets of every stage of the executive actions of people to implement **TWO STRATEGIC PROGRAMS** (***the Development of the Brain genotypes and the Development of Energybiogenesis of the flesh cell***);
- strictly expressed Structure of the imposed (on the side of the Control System) hierarchy of the social control of the public development according to the degree of relative "controllability and importance" of all individuals, with regard to the **SPECIFICALLY** expressed genotype of each Brain as a common (state) model of the executive actions of people illusively **IMAGINING** as a society for "cohabitation" in it to meet the emerging social, spiritual and other everyday needs and other things less important.

The control of every sphere of being, as separately expressed elements of much lower order in the overall Structure of the of people's being, was also **EXPRESSED BY QUITE SPECIFIC SUBJECT FUNCTIONAL CLUSTERS**.

Returning to the consideration of the Planetary cluster, I would like to emphasize that the harmonious being of all the range of the imposed

energies octaves at each stage of the civilization development of the Planet must **STRICTLY CORRESPOND** to the beat time in their own and general event of the chronicle process of the systems clusters of much higher order. In the process of the interventional interference Ebr System **HAS CHANGED** the **BEAT** time, and imposed its standard of charge fluctuations on the sides of energy gratings, equal to standard =**1,0007 sec.** in relation to which there was imposed time model 60x60x24 with all relevant time-bindings, including the Earth's rotation around its axis. This standard beat of fluctuations, as if the **IMPOSED TIME**, was provided and assigned by the charges fluctuations along the sides of the **energy gratings of Cs 137 (lat. Caesium).**

And now is the MAIN thing that can be said TODAY:

- **In 2012.12.24 at 0115hrs** the control and fluctuations beat (1,0007 sec.) of the old Control System is **TURVED OFF** (the Stonehenge Complex);

- **In 2012.12.25 at 01.15** The **NEW CONTROL** and support of the fluctuations beat (**1,008 sec.**) is **TURVED ON** which is the **TRUE** and **RECREATED TIME** of the Earth in its first stage of civilization development. Turning on was carried out by the recovering **ALTAY Control Complex.**

This process corresponded to a particular relative position of the objects of all "parade of Planets". Exactly at this moment on all the Planets of the "parade of Planets" **there was restoration of their true standards of beat time.** Exactly for this reason, the "Mayan Calendar" terminated with respect to such Universal event.

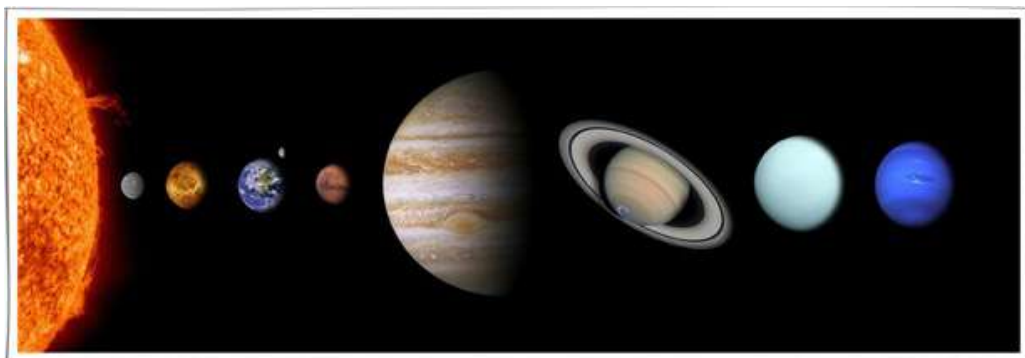

Exactly because of this there **WILL NOT BE** any Apocalypse!

With this landmark event there began an active phase of many processes for the **RECREATION OF ALL OCTAVES** of the energies on all

the Planets ("parade of Planets") in their true state. Here I would like to add only one thing – exactly because of this it was carried out the reprogramming the **Generator** of "Dark matter" (in the terminology of **N. Levashov**) through the newly created **Program "SvetL"** in relation to the new standard of beat time. And this **FUNDAMENTALLY CHANGED** the purpose of the Generator, making primary the Brain development with reference of this process to the System of control and life support and on this background – health improvement of **the Programs "SvetL"** users.

3.4. About the creation of the "Shirt", failure of Intruders and of the collateral...

The animal world, the insects were created to control the Man frequencies.

In the atmosphere structure ($-4400 < h < 12400$ m) there is oxygen, hydrogen, industrial emissions, and **OTHER FORMATIONS**. ***There are also biological structures both in material (inertial mass) and immaterial (non-inertial mass) states.*** Biological structures in the material state are described by "scientists" in detail– they are divided into classes, groups, genotypes. They all have distinctive features, which make it possible to determine their ancestry. There are some signs In humans, too, – whether they are relevant to the class of apes, or created by the aliens. As a rule the interference of the aliens is being denied.

Intangible (immaterial) biostructures were represented with two types.

The first type is represented with all types of visual delusion, ghosts, hobgoblins, and others which the civilized world has been faced with at every step.

The second type are humanoids from small insects to humans. In the state of a humanoid one IS **ABLE TO BE** for thousands of years until conditions are created for materialization. All humanoids, as a rule, were subjected to reincarnation.

An example: If you "slapped" a mosquito, it does not mean that you have destroyed it. You altered the material structure of a mosquito but it also has a structure in 77 octave, in ininertial (immaterial) state, and its new materialization can happen in a day. Modern science is only guesses about

it. **MATERIALIZATION** of **USEFUL** for the Mankind, insects: locust, bedbugs, lice, spiders and others, was performed by the Invaders Control System only in the event of an additional control over the frequencies of these insects.



The inconveniences for the invaders began after they had decided to use the Shirts that remained after the **INVASION** and **ANNIHILATION** of everything and everyone. **Firstly**, it was impossible to reproduce in Shirts, as high frequency octaves were destroyed (or rather, reduced to 2-3%).

Then urgently they had to introduce "support", but there arose a problem with the "reproduction" organ. **And immediately a "national custom" was introduced – to cut off the excess.** Then it was noticed that in the course of the control, not all can be verified. It became necessary to burn sulfur, which was subsequently replaced by candles. There was also a number of trivial inconveniences, which were later transferred to religious cults. But still, to **CONTROL** the **FREQUENCIES** of octaves **65, 67, 71** mosquitoes, bedbugs, fleas and other useful insects were developed.



If the frequencies that were considered unnecessary were removed from the Noosphere, then the systems of biosensors were removed as well. And to monitor the new state there were created new biosensors, either in the existing ones new functions were added. I want to note that the term "web" **REFERED** specifically to the **CONCEPT** of "a spider", **and it was one of the 18 structures of the Control Systems**. The Brain was created for the web, and it (the brain) could "pick off" and process the information that was necessary to the Control System of exactly this structure.

All biological structures, including Man, were designed in such a way that had a whole set of octaves **from 16 to 128**. They are different in purpose, and the dominance of a particular group of octaves formed the basis of a biological structures.

Functional division into octaves:

- **16-32** = all kinds of gases and water (breathing and water are necessary for all);
- **34-46** = structure of reincarnation (all structures sought to the potentials of frequencies of these octaves);
- **48** = distributor;
- **50-52** = energy balance;
- **56-62** = organs control;
- **64** = material structures;
- **66-72** = brain;
- **74-86** = reincarnation control;
- **96-126** = control;
- **128** = defining beat generator

The Program "SvetL" until recently "worked" in the range of **66-72** octaves (for interoperability with the Brain of the owner). Today, the range of octaves of **"SvetL" Programs** is expanded to **128**, which makes it possible to "interact" with the defining beat Generator. It is extremely important in the processes of changing the Human life support System. We can say that the first step has been made in the implementation of **life prolongation up to 124 years**. But this does not mean that being a member of the **Programs "SvetL"** you automatically become a "long-liver". **TO THE BATH** you will have to **GO**. And, as **N. Levashov** used to say, – It is quite "another hiZtory..." I got this understanding a year later, after **Nickolay's** "passing away". Before the **INTRODUCTION** of the **CHANGES** to the **Programs** it had been necessary to periodically make

recommendations on the Complexes "reset" so that the Programs "reacted" and "adapted" to the changes occurring in the life-support System. Now this problem is solved. And it is solved thanks to the knowledge obtained through studying those works by **A. Khatybov**, which even today are **NOT PUBLIC**.

All kinds of plants, herbs are of **34-44 octaves frequency**, so the cows eat (as I have mentioned), only grass, knowing that they will be used as meat. Apparently, therefore, in India – the birthplace of the reincarnation theory, – cows **ARE SACRED ANIMALS**.

For dogs it is important to know that reincarnation exists for them (frequency range of octaves – 78-80, combined with the frequencies of octave 64, but these are bones). The dispersion of the higher octaves is fairly slow, and if a person dies with the potentials of bone frequencies above 122%, then even after 1000 years those bones can be applied to the sore spot. It's about the phenomenon of "Holy relics".

Earlier I wrote that all metabolic processes are **CONTROLLED** by the **BRAIN**, but the distributor of "the goods" for the cells of the body **IS** the **HEART**.

All believe that mental activity is the Brain's function. Earlier I wrote that all metabolic processes are **CONTROLLED** by the **BRAIN**, but the distributor of "the goods" for the cells of the body **IS** the **HEART**.

However, even in the Yeltsin time (I then worked in the North-West region), on all the posters it was written: "**Think with your heart!**" And if you look a little deeper with humor and irony of A. Khatybov, then before getting the Brain the thought center was the Heart, and before that – **TWO HEMISPHERES** below the spine. Having three centers for the reproduction of thoughts, there is a possibility to have vacations so that it would be imperceptible what structure is running the body today. Of course, the main Brain has a maximum size. The thought process is, naturally, divided. Incidentally, all three intellectual structures roughly have similar design – they are divided into left and right halves. The brain is conservative and unresponsive to external changes. The heart and especially the lower brain, are keenly interested in all the changes, and their form depends on the advertisements in the media. There is such a concept as "bull's heart", it is the pleasure of beer consumption.

The Brain (cerebrum) – has a lot of convolutions, works only for itself – where to steal and whom to cheat. The Heart has no convolutions,

but makes principal decisions and **DOES NOT REMEMBER ANYTHING**. The lower Brain is equipped with a single convolution, makes all foreign (state) decisions. It is especially evident today. The amount of pleasure for the lower Brain is enormous, because it is the leader in all new beginnings.

Of course, paying for the consequences of the Brain's work and, especially, the intellectual conclusions of the Heart, has always to be done by the lower Brain. It is administered various pharmaceutical preparations (injections), rods, whips, hunting rifles are developed for it. If there is a necessity to correct the thought, salt is used to increase the pH (negative logarithm of the hydrogen ions concentration in solution). A charge of salt has a beneficial effect on the correction of the decisions made.

If we make a trepanation of a cockroach's head portion of the body (instead of the Brain, according to our traditional concepts and approaches), we will not be able to detect the Brain; instead, we will find something that **HAS NOTHIG TO DO** with our concepts of the Brain. We discover one hair

in each "half" of the skull with "poppy" seed upon their tip. We naturally come to the conclusion that the cockroach has no Brain and this will be our "mistake" since the Brain of the cockroach is **mostly in immaterial**

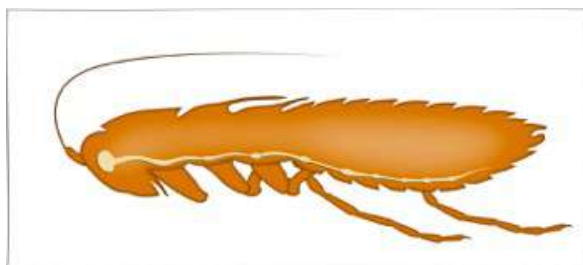

(non-inertial) state and its Brain is quite enough for the execution of its functional vesting, granted to it by the earlier interventional System as an appendix element of the System of biological control! But its Brain is not that simple, moreover, it was able to perform quite complex operations to **GATHER INFORMATION** of the biological environment state according to the parameters that were required by the Program "**Development of Energybiogenesis of the flesh cell**", i.e. people! Thus, the Brain of a cockroach, as the **MINICLUSTER SYSTEM**, professionally controlled all Executive actions of this **IMPORTED ENTITY**, played an important and specific minor role in the biocontrol System. Here it is such a monster, that cockroach.

So what is the Brain? The brain is a cluster system formation of the energies that are in inertial and non- inertial states created for specific operations of control, monitoring

analysis and having the property of improving in certain permitted limits, under the control of a higher level of formation.

As for the Brain of the Control System as a very specific cluster of the control systemic formation in the most complex structural embodiment, people's perception of it, its constructive arranging, functions, technical and technological capabilities, and much more – are **IMPOSSIBLE** within the framework of traditional ideas of the Brain, especially when making restricted attempts to compare it with one's likeness as a perfection of nature! By the way, specially distinctive (not for merit) signs of the human Brain as sight, speech, hearing, smell, and other gained "perfection" (obviously, not without the help of Darwin and his kin) are also available in the Brain of the Control System, but are in incomparably high and perfect condition.

The earth as an artificial structure has been created for about 7 billion years. At present, there is the following in operation on the Earth:

1	The Control System (CS)
2	7 Secondary control systems (SCS) – servers having more than a 1000 pyramids (each), hundreds of terminals
3	Objects (more than 3500) for the control and reconstructions
4	2 colliders (under the North and South Polar circles), define the beat = 1,0007 seconds
5	8640000 meridians
6	7 cords to read the information
7	More than 1 billion biosensors
8	Beat time Control System
9	Control System of the Earth surface
10	Near Space Control System

It all works as a unified system in which Man lives. But today the **PROCESSES** are **UNDER WAY** that affect and have a significant influence on virtually everything listed in the table.

Many people know that Man has "Chinese points" (Pfall points) – they are the points to control and influence Human organs by homeopathic effects with needles, shock, etc. It is considered that if to stick needles (gold, silver, platinum) in the "Chinese points" then some good individuals (spirits) will run at full speed and locate themselves in the right places, and the evil ones will run away.

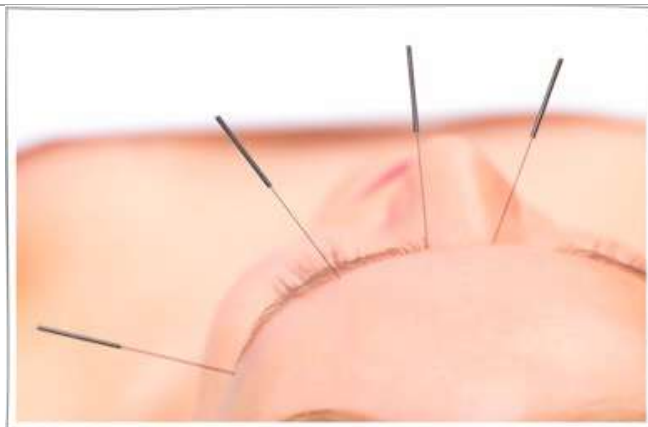

But it is accepted to believe so that **NO ONE WOULD THINK** another way. Each of the SCS (Secondary Control System) forms its control cord, and it takes the control cord 2 hours and 10 minutes to make a complete control of the environment, making a full turn around the Earth. The information collected allows the SCS units within a few hours to make a **CORRECTION** of the **ENVIRONMENT** from -2200 m to +12400 m, creating the ideal conditions for Human existence and for those who he is going to eat! However, to pick up the information from one man within one examination, in principle, is impossible. So, SCS Kailas for the Brain control withdraws **PART** of **the BRAIN** for a long period and makes a comparative analysis with the given program. This time a Man is asleep. While being controlled a man is watching a "new video", taking it for a dream. The rest of the SCS could not afford to have unlimited time to collect and analyze the information, therefore it was created a unique method. Each frequency available in a Man, was copied to the extraneous biostructure, and with the passage of the cord this biostructure in resonance mode responded to the request. Thus, billions of biostructures gave (each one) in the resonance mode the information on the state of man's health in the control environment. It's hard to compare it with the current level of our knowledge, but it was exactly so. There were no **ACCIDENTAL BIOSTRUCTURES** on the Earth. Each of them was supported basing on the program requirements. Raising the level of the Human Brain required the **REMOVAL** of **OLD** bio-structures and **CREATION** of **NEW ONES** that, in fact, is observed nowadays. There is an example of it; some time ago, the US was subjected to mosquitoes attack. The scientists reported that the drug was produced after eating of which mosquito's stomach was destroyed, and the mosquito died in painful convulsions.

Having asked some known Russian biologists about the structure of the mosquito, it was found out that a mosquito as a highly developed being has **NOT ONLY** a stomach but all that is necessary for normal processing any food (approximately, as in the case when the single-cellular nibbles the multicellular, having protection from them). The information on the success of U.S. scientists was broadcast by all the media and no one but A. Khatybov (for some reason), had any questions. **The first thing** that Alexander Mikhailovich paid attention to was –what was the mosquito eating?

In the dead blood erythrocytes, as the sedimentary structures have a diameter of 7-9 microns, and living blood – much less due to the difference in octaves, although medicine still thinks the erythrocyte stretches in the likeness of the sausage and squeezes through the narrow capillary, with the moral support of the heart contraction. The mosquito does not need either the blood plasma or other structures. What did he eat? The mosquito is only interested in the erythrocyte **WITHOUT the MEMBRANE** and without the address "lable", i.e. an erythrocyte in the **STATE of PLASMA** (like the oil spill in the sea). In medicine it is "sugar" in the blood, or diabetes. Such an erythrocyte **HAS NO** connection with the control structures and has to be immediately removed from the blood system. This erythrocyte has 12 form frequencies (does not fall apart to atoms). The plasma state of the erythrocyte is a **SERIOUS VIOLATION** in the functioning of the kidneys, liver, pancreas, but to control them **AT THE SAME TIME** is **IMPOSSIBLE**, and therefore the structure of a mosquito was created, that recognized only a group of **12 frequencies** and reported their availability.

With the cord moving the information on the presence of the plasma state of the erythrocyte was recorded and later analyzed for decision-making. If the information wasn't enough, the mosquito population was increased. The mosquito can be compared with the "Junkers-87" – when approaching the target the siren is turned on. The mosquito's siren was turned on automatically, and the farther from the body it turned on, the more erythrocytes were in the plasma state in humans. Blood has plasma and **pH=6,88-7,45**. Если **pH>7,45**, then compact sensors were created – **mites and bedbugs (for pH<6,88)**, which had only 4 resonance frequencies (without a siren). In any case, they first tasted the plasma, and if it didn't fit the norm they left the information for the cord. Also, as with mosquitoes, if the information was not enough, the population of bed bugs or mites was dramatically increased.



To generate **genotype 46** there were no special problems with red blood cells and blood plasma. The main problem was the support for the erythrocytes production. It was necessary to create a deficit of erythrocyte by their seizure. For this purpose leeches were used. Russia, before 1917, had exported **60 million leeches a year**. Only in St. Petersburg 8-

12 thousand peasants worked in this field. The exports went to Europe.

Nowadays, the erythrocytes in the plasma state are poison for leeches, that is why A. Khatybov, as always, in his favorite manner advised treating with bedbugs first, then mosquito (must be sterile and seamed in a jar) and only after the elimination of plasma erythrocytes leeches can be allowed. Of course, the civilized mankind was obliged to keep in the home first-aid kit (you may in the car, too) a minimal set of the above and use them only for their intended purpose.

Thus, it was possible to point to the value as a means of control and medical first aid of the corresponding biostructures, but this was beyond just opinion and required instrument provision for fixing resonance frequencies of each of the biological structures.

3.5. The concept of unscientific perception and Reincarnation

Everything that is associated with the "scientific" understanding of "travelling souls" (Entities) and reincarnation has always evoked great interest. I just specify, that reincarnation that existed under the interventional Control System, is no more some sort of violent imposing in the World of the guiding character (from the System). In **2017.01.07** there was exactly four administrative years since one of the Programmed processes of the recreated Control of the people's being on the Earth associated with true state of any subsequent incarnation of the "Spiritual Entity" through the Phenomenon of The Investment that was Shown, but not through reincarnation.

Phantoms and doubles, complete loss of memory, **SUDDENLY OPENED** new knowledge about the events, in which one had not

participated before, the recollections of the past life and knowledge of foreign languages since the cradle – all this is only a minor part that has been drawing the attention of all kinds of scams, especially from the so-called "science". These and similar cases recorded by witnesses, captured on photos and videos, including legally proved, are ***a means of existence for all those who "has been feathering their nest" on ignorance.***

The Academy of Sciences **HAS NOT INTERVENED** in "miraculous" transformations, and it was only on hand to all healers, witches, black magic and white magic and other crooks. ***But today, the frequencies at which they removed the information are disbanded. And it no longer works.***

No	Name	Foundation – Horse knowledge	Non-scientific point of view
1	Atmosphere	The mixture of gases formed by chance	Strictly organized structure of gratings series
2	The Earth	Formed from dust	Exists thanks to the Control System (CS), located at a certain depth
3	Fields	The number of names is unlimited – from the farm to the astral	There are 3 Fields as physical structures, conditionally can be called as electric, magnetic, gravitational; different in frequencies and properties of the charge (octave of the charge 4-512 in Di-structures and 16-128 k-structures)
4	Matter	The whole world, both on the Earth and in Space, is composed of Bohr's atoms	If octave of the charge is less than 66, a rigid structure of the proton atom is formed (matter).
5	Spirit	The spirit, usually the Holy one, exists separately from the matter	If octave of the charge is more than 64 (up to 512), non-inertial mass, quantized on the purpose and properties is formed.
6	The Moon	A piece of the meteorite, captured by the Earth	The external Life Support System of the Earth, the programs generator for the biosphere.
7	Man	Descended from apes	Change of the sperm octave in an appropriate environment forms a human (APE – humanoid of a man).
8	The Brain	Everything that is under the skull	Man is provided with a part of operative brain and a minor part of the long-term memory

Here are some A.Khatybov's terms and explanations who always proceeded from the fact that the "basic constant in modern science is the

horsepower, so all that are known today to modern science is horse knowledge.

Terms and explanations

Insignificant differences between the two points view

	Official science	Non-scientific point of view
1	The solar System was formed after the explosion, there is Hubble sphere	The solar System is artificial, the Space has never exploded, there is no Hubble sphere.
2	A living cell turned out randomly from dust unsuitable for the formation of the Earth's surface	The living cell is the highest achievement of the Cosmic mind, combines the interaction of the octaves from 12 to 4096
3	The remained gas is randomly formed the atmosphere	The atmosphere is layered structures of gratings (*)
4	There is no difference between a mouse brain (which is used for testing medical drugs consumed by man) and a human brain	The human brain is incompatible with the brain of any humanoid.
5	UFO – random appearance of aliens, everyone interested is engaged in their study. Soon their secret will be revealed, and their weapons will become property of the Earth	All the UFOs on the Earth are of terrestrial origin, they are the equipment to monitor the state of the environment (type of zonde); the moon has its own UFOs.
6	The evolution of matter - solid→liquid→gas→plasma (unorganized)	Non-inertial mass (highly organized plasma, arranged in octaves) →inertial mass (gas, liquid, solid)

On July 6, 2003, the formation of the general memory grating was completed. The grating structure are the united dodecahedrons, each of the dodecahedron is a refinement of the icosahedron (the edges of figures and connecting pyramids are the same). If you want to get at the meaning of all this, the sizes and methods of connection are given in the works by A. Khatybov.

Nowadays the processes are under way about which **N. Levashov, and A. Khatybov** wrote in their time – the systems of "horse knowledge" are being removed together with their bearers. The General memory grating will contain only the information **THAT** is **NECESSARY** for the life support of biostructures. Moreover, a powerful grating of control structures has been created. Not stipulated actions of biostructures (read -people) will be destroyed together with their bearers (e.g., turns of rivers, the creation of atomic weapons without knowledge of the physics of the process).

Nowadays there still prevails the "scientific viewpoint", but more and more the concept of non-scientific perception is breaking through the reality which bears the following:

- The Earth is controlled by the Control System, located under the Earth's surface;
- the Control System is a complex hierarchical system;
- on the Earth there are more than 2000 control systems;
- the basic Brain of each individual is stored in the archives of the Control System;
- at each beat period the Brain control of the individual is made with the information recording;
- the Control system uses 7 types of time, one of which (60*60*24) is the beat of the lower grating;
- to transfer the information the Control System uses the music order and the **RESONANCE CONTOURS** of the **SPINE** are the receivers of information;
- to control the Brain the Control System uses a different musical order;
- the order to control the Brain: **DO RE MI FA SOL LA SI NA, LALALA** code – call letters, still existing for a particular genotype of the Brain;
- the appearance – is the shirt, and the Brain transfer is made to the shirt that in the frequency balance is compatible with a portable Brain;
- when transferring the Brain the information in the archive can be fully or partially saved, that is why the individual is able to do things that previously were impossible;
- the substituted Brain can be saved, but typically it is scattered, for all that the ion structure (and DNA, too) are remained the old ones (the sedimentary structures of the old Brain). The new Brain does not form DNA.

When replacing the Brain the Control System assumes that the **NEW BRAIN** in the archive is better than the substituted, but this is not always the case – lately the reverse process is observed. The old Brain cannot be substituted, if some control points are missing, or cannot be replaced (incompatibility of genotype, diseases such as AIDS or tuberculosis, a narrow range of lungs memory, the level exceeding the radioactive frequencies potentials etc.).

The primary task that I hope to realize in the near future, is everything that has to do with the "**PRESERVATION**" of "**INFORMATION**" (almost

a full copy of the Brain or Entity) of the Person who had used **the Programs "SvetL"** and died. Of course, the Generator with all the programs and information – might be just "scattered", but I consider it **UNREASONABLE**. How to change (replace or "remove") the Generator from the bearer (the complex) has been decided and tested. Under consideration is the question of **"SAVING"** the Generator with all that is **"STORED"** in it for the future use by the Brain (Entity) under repeated embodiment (if, of course, it happens). This will significantly reduce the time of "achieving" the lost potential. I **CANNOT** tell you everything now for reasons known to you and associated with the ongoing transformations. But I hope that soon that will be possible. And while I "close" it with points, as N. Levashov used to do.



An important aspect is the method for converting and resizing the structure. Again I refer to the example with an erythrocyte. It is known that the erythrocyte has a diameter of **7-9 microns**, but more than 90% of blood vessels in humans have a diameter of **about 1 micron**. The question that makes many come to a dead end, – In what way does the erythrocyte find room there? The answer: There is no erythrocyte in the blood, it is formed **OUTSIDE** the Control **SYSTEM** (or the Brain) as a sedimentary structure with the loss of the octave of its condition (decreasing the octave 2 times the total size increases 1,284 times).

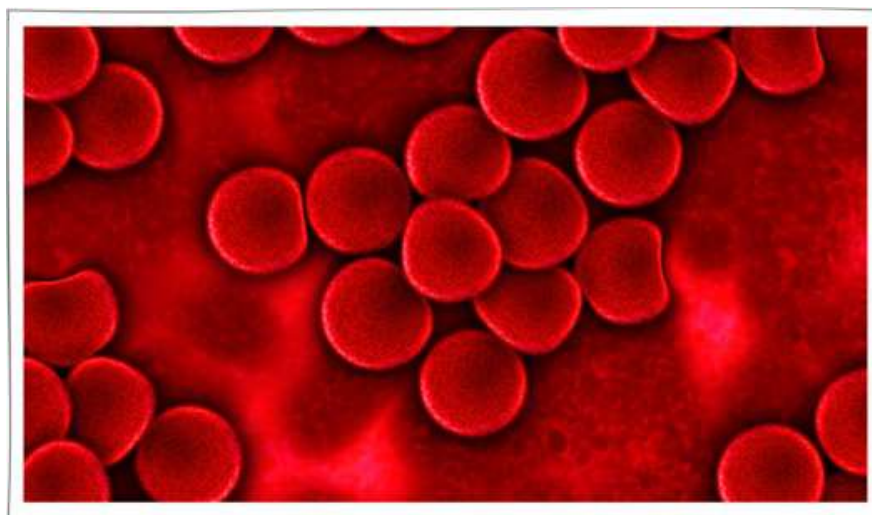

Similarly is the birth of a child. The spermatozoid has an ionic structure and the Brain **in octave 96** (smaller than the atom size). Once in

the "sandbox", that is, in the structure with **MAXIMUM** dispersion, spermatozoid grows rapidly (losing octaves of the Brain). When reaching the equilibrium (octave 71,225625) the signal is developed and the **DELIVERY COMES**. This implies an important conclusion – **the NEW BRAIN** is in a higher octave, and the functions of the old Brain might be **AFFECTED** only **PARTIALLY**.

Earlier I mentioned that the existence of **non-inertial mass** modern science does not even has doubts about. In octaves **over 64 there are 8 different atomic structures** (they are given conventional names – neutron and antineutron, neutrino and antineutrino, etc.). Each of these structures has a range of existence (charge). The loss of charge increases the potential of the lower octave.

An example: when transferring power octave of 65.5 in 32,125225 we get a powerful discharge of lightning (comparable with the power generated by a hydroelectric station for hundreds of years), although the initial state is impossible to see.

Taking into account (excluding the official science) the presence of various "divine" phenomena, as well as advertised astral, mental and other fields (recently a fashionable field is torsion), I want to draw your attention to the growing number of perpetual motion engines, or, at least, the desire to create them. More than 99% of such works are obvious nonsense, even from the official science point of view; but, if in some cases in technical solution the **NON-INERTIAL MASS IS PRESENT** the problem cannot be solved with conventional means and devices, the more so, that the Bohr atom does not change the size and Mendeleev periodic table does not contain non-inertial mass.

Is the existence of perpetual motion possible? If you take the period of time of 100 years, it is possible, by dissipating the high octaves the ion mass can obtain "recharge from nowhere", but only in case of the presence or merging inertial and non-inertial mass. **An example of such a perpetual motion engine is a Man, whose Brain is in the non-inertial structure.**

What will happen if someone takes into his head to visit Pluto in a modern spacecraft? While moving there will be **DISPERSION** of the **HIGHER OCTAVES** (and that is the Brain), so when passing Mars we will have the Brain of Pithecanthropus, and **AT THE DESTINATION** – a **PILE** of **SAND**. All the objects that move in Space, have **gravito-magneto-**

electric Generator that supports the existence of migrating matrices at all frequencies. **Such Generators were, as N. Levashov described, at Vaitmars and Vaitmans** (some for interplanetary flights, others for use in the planetary conditions). This allowed the Human to **MOVE** in **SPACE**.

So, where do crooks and interpreters from science come from and what do they use? Firstly, – out of the walls of science itself; secondly, – because of misunderstanding and inability to perceive the information that **N. Levashov, A. Khatybov** and others left for us. The use of "Horse knowledge" **MAKES IT IMPOSSIBLE** to get to know the meaning of physical phenomena. All existing instrumentation is founded on the properties of Human eyes (phase, angle of the charge sliding, the top octave and the like can not be higher). The lack of instrument base **DOES NOT ALLOW** the official science to accept or reject the new physical properties of the material world (we will not touch on the "Divine world" because it's a different hisTory).

Lack of knowledge about the world around and the ways of its existence leads to a closing around that pyramid of knowledge, that had been built for more than 500 years. In fact, the presence of such science nowadays has led to the existence in Russia of more than 180 Academies, each of which uses the same level of knowledge that has nothing to do with science. Is the situation going to be changed? Yes, it is. Upon completion the Main Program the Control System **WILL** just **ERASE ALL the JUNK** and provide the information that will Make it impossible for the King of nature **to interfere** with the Control System, including the formation of the new atmosphere gratings.

But let us go back to the problem of reincarnation to finally put the full stop on it. There is such a notion as "karma" in shamanic circles. It is supposed to be recording all the deeds and promising "creative" success. There is a lot written about karma, but we have something to add. **Karma** is the feature of the neutrino coat of the Bran to preserve all the properties when changing octaves from **73,450450 to 61,375375** at a carrier octave of **49,5** (bone structure). It takes approximately **1200-2400 years**, therefore, when replacing the Brain neutrino structure of the Brain is controlled **FIRST OF ALL**. If this period is divided by the average lifespan, you will get a number (amount) of incarnations (reincarnations), which would have to be implemented to achieve these octaves of the Brain. **Before the attack, the seizure of the Eath and annihilation of people this had not been required considering that the length of biological**

life exceeded the given values. In case of disappearance of the carrier frequency within a fraction of a second karma disappears as well, and there remains a small pile of wet sand of a man. At present it has been applied for the publicity and understanding that the similar things are possible as "Technology" with those who were planning to shoot down Boeing over Sinai.

Currently, whether we **LIKE** it or **NOT**, the world is divided into **2 camps – the yogi and the goyi** (the yogi are the control, or those individuals, whose karma was supported by the old Control System of the Earth, **they make 12%**; GOYI are the working material for the experiments). The correctness of the reincarnation experiments was checked on goyi, on yogi the experiments were made.

However, there are exceptions. These exceptions are fairly well documented in history. This applies to the Jews. There is no such a nation. **N. Morozov** described it in the monograph "**Christ**". There were tribes of Jews. The history is founded on fairy tales, and all "the antiques" were



written in the Middle ages, with the beginning of the 500-year program. According to **N. Morozov**, the word "Jew" means **EBR (a migrant)**. That is, the one whose **BRAIN WAS REPLACED**. It was assumed and was presented as if they "were moved", or "expelled from Egypt". The first experiments on changing the structures of the Brain were made exactly in Asia Minor. When transferring a new Brain the old one is eliminated, but the new one **CAN NOT** pass the test and cannot be put in. In this case, the control over the actions of the Brain is disturbed, and such a Brain **HAS TO BE DESTROYED**. This extends to the current processes. What is typical that such a phenomenon is being widely spread. In the old Control System the name "Jyd" – Jew (or yog) was **introduced** for them. **Jew (or yog) without a Brain**. It has already nothing to do with the Jews. The slogan "beat the Jews and save Russia" refers specifically to this phenomenon. To create a public attitude there were organized "black hundreds" of the ground – attackers, the "Memory" society, and so on.

For "Jews" the old System established a temporary support (the total lifespan of 54 years) and made of them regular biorobots with the specified functions. If within the period of 1933-1945. the total number of biorobots

was **6600000** (almost all were annihilated), at the present time they make more than **33% of the population**, and therefore there was a danger of a new (nuclear) war. At the end of karma robots jump out of the windows, perpetrate accidents, take up arms, etc. Such individuals are **ESPECIALLY DANGEROUS** in the army. Modern science does not have ways and means of detecting and neutralizing robots. The first report of the emergence of robots in Russia was **in 1472 ("The arrival of the first Judaizers in Russia")**, that is, at the beginning of introduction of new Brain, and it did not suit everyone. If karma was normal, the control system at **100% supported the possibility of reincarnation**, and it was performed once in 12 years for all yogi (or, in exceptional cases, on merging of a few beat periods and availability of replacement, an example is Anastasia). I am sure that the new Control System will "find" another (except the war) way to remove robots and the reasons for their formation.

3.6. Sleep as karma control

Sleep and dreams, interpretations, and dream guiding books are the basis of almost all of the practitioners of shamanism. It is known that there are lots of types of dreams: they are color dreams, sleep with no dreams and instant dreams (you sleep a few minutes, sleep well and had a dream that lasted a few hours). While sleeping a man can travel, do very specific things, be in places that are inaccessible, etc. First the idea of sleep as a means of control **was expressed by Freud**.

On the Earth there is nothing accidental. As I have mentioned all living beings are biosensors, and if the frequency balance is changed (in line with the Program) then unnecessary biosensors disappear and new ones come out. For all that, you should keep it in mind that according to the Program the frequency balance **IS ONLY GROWING** (the octave is getting higher), so gradually biosensors of a large size disappear and smaller ones appear. ***Especially carefully the Control System monitors the Man.*** **MUTATIONS ARE NOT PERMISSIBLE**, and once in the beat period a short-term withdrawal of the part of the Brain (according to the schedule) is made for control purposes. In this case, the taken part of the Brain is tested, and according to the test results a correction is applied, and then the removed part of the Brain is returned. If the correction is insufficient for the whole of the Brain the carrier frequency is removed or karma is reduced.

On the Earth there are 12 related Control Systems, and 21 Control Systems. For example: the control System for England is located in Greenland. The removal of part of the Brain was carried out according to commands from the Moon.

The drawing symbolically shows the memory library. Testing is performed at high octaves. There is different time over there (144 times reduced), but if that is **NOT ENOUGH** to make the complete test, the test stops suddenly, and the part of the Brain (partial) is taken back. During the next testing this part of the brain is placed a step below. Targeted communication makes it possible to return accurately the Brain back where it was removed from for the testing, but if by this time there had been some changes in the atmosphere, the address might have been changed, for example, a woman's Brain is returned to the man and vice versa. Hence, the growth in the number of gays and lesbians. Nowadays this happens very often. **THE TEST** is a kind of **FILM**, every sequence of which checks each cell of the Brain matrix. The signs of checking are partially preserved.

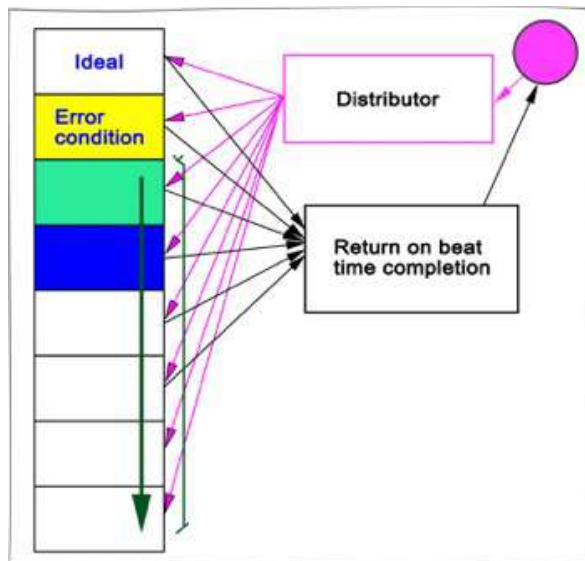

Yes, the sleep can prompt a disease or general condition of a Man. The interpretation of dreams has nothing to do with this process. Sleep is necessary, indeed, but not as a story fragment, but as a state, because exactly at this moment there takes place correction in many, and sometimes in all the processes of the guiding, control and overall condition of the energy-informational state of the Brain and the flesh cells.

The address loss is a tragedy for the Control System since not only the control system is disturbed, but the point, as well. Upon detection of the

address loss, the Control System eliminates the gene pool at the new address, and that Man becomes a ballast for the society. **All the so-called "minorities are the defect in the work" of the Control System under ideal conditions. And the System GRADUALLY DESTROYS their Brain.** The control points of the Brain matrix in all octaves are given in a separate work by A. Khatybov. Here we note that only to control the pancreas functioning there are **8192 points** in the matrix of the Brain. All the drugs used by Man, either **DISCONNECT** the **BRAIN** from the ionic structures (shirt) or **ADJUST** the **SHIRT** according to the instructions of the returned part of the Brain. **There are no and cannot be medicines that affect the Human Brain.**

3.7. Language as means of communication.

Once I asked Boris Makov: "how many languages are there in the world?" "Two, – he answered, – **one pink, the other with some fur** (when there is a disease)".

Unlike humanoids, a Man is able to speak. Detailed analysis of sound forms is given in the monograph "**Christ**", **volume 3** by N. Morozov. However, the reason of formation of coherent speech **IS UNCLEAR** to modern science.

If you approach this problem from a non-scientific point of view, then the Human Brain contains a "Translator", i.e. a way of transferring **MUSIC ORDERS** received by the spine octaves or stored in the operational or long-term memory. There might be several such translators. Without such a translator you can **LEARN** a foreign language for hundreds of years with **NO USE**. If there is no translator, the Brain **CANNOT BE FORCED** to learn an unfamiliar language. **Under reincarnation it was possible not only to transfer the portable Brain's events records, but also the translator transfer that** allowed to easily and quickly update their knowledge of the language.

The Control System while checking the Brain validates the work of the translator and, if necessary, complements (making higher the frequencies potentials) the Brain with "instructions" for changing the ionic part (the shirt). When reducing the frequencies potentials you can forget everything, lose your memory. And nowadays this happens rather often.

It is well known the technique of learning a foreign language while sleeping. In fact, there should be **used 8-digit music**, and not 7 (12), as it is customary now. In addition, the record must be made in the appropriate octave (the maximum frequency of the radio-set is octave 16, which is insufficient for the instruction the magnetic pulse potential). Instead of the accurate "requests" to set up a translator from the language nowadays there are sound effects like a talk of the crowd, and the Control System can only either increase the potentials density of the earlier input possibilities or remove them at all (you wake up and discover that you have forgotten the native language, and there is no other one). By increasing the potentials density there can be effects (not immediately) of the language knowledge.

The Russian language **WAS DEVELOPED 257 years before the birth of A.S. Pushkin** (the English language, as well), and since that time the frequency balance of a living Cell and bone resonators have been modified for the new structure. These changes have been made throughout the Earth, but considering the "local control structures", for example, in China, Japan, and Korea. I want to draw your attention to the fact that the cogitative process in the countries using hieroglyphs differs from the usual. It is **a PATTERN of IMAGES** and changes in this structure, which are uncharacteristic of the stereotype would lead to the destruction of a large part of the Brain matrix. Now this process is just starting to "unfold" exactly with respect to the Russian language. ***The words accompanied by images, and visualgraphy, or images passing into words are the basis of the future mutual understanding among people.*** Exactly in the **Generator "SvetL"** and its **Programs** it is provided the "interaction" with the Generator in this way. This makes it possible to adjust it and "operate" it in accordance with the necessity. And the first experiments that are performed by the Users themselves are very encouraging.

3.8. Blood, DNA and the lungs memory

When replacing part of the Brain usually there takes place the change of the blood group. Why? – Medicine is not able not explain it. Along with it there changes the **SEDIMENTARY STRUCTURE**. Previously unknown connections and particles (and their sizes) might appear. If there is a change in blood groups, there **HAVE TO BE CHANGES** in the structure of certain organs. As a rule, it concerns outer exchange structures, i.e. the lungs. If the

Program provides for changing the potentials ratio in the atmosphere gratings and (or) the introduction of a new grating, then in the first place, the lungs have to be ready for such changes. Breathing exercises are subordinated to the Brain, and the breathing capacity limit cannot be more than the capabilities provided by the Brain (the lungs memory). With the reduction of the "passage" a Man gasps. As a rule, the reduction of the passage (and sometimes just elimination) occurs in a sleep, when part of the Brain is missing. In case of discrepancy between the "gas" environment and the lungs memory within 4 hours a signal is carried to the Brain, and if there is **NO CHANGE** to rectify the situation, the Brain is **REMOVED**.

The very name of the **DNA** (acid) suggests that it is just the medium for the change of the high octave (the spermatozoid also grows with the loss of octaves in an acidic medium). But this medium is highly organized, and using modern instruments it got possible to detect some of its features. There have been collected 64 combinations of adenine, cytosine, guanine and thymine. However, **DNA is a "conveyer"** used by the Brain for the formation of ionic structures and metabolic processes. **DNA is a sedimentary structure**, and in replacing the Brain it remains **UNCHANGED**. Just on this "conveyer" other details are to be assembled. Science has determined that out of the 64 codons 20 (known) amino acids are formed. The remaining **44 are unknown**. Note that these 20 amino acids are the analogues of the unit distributions on the "conveyer." If the "conveyer" is an "assembly unit" then there should be a "forging shop", "paint shop", and so on. We have to assume that the unknown 44 amino acids are strange "mafia" structures. Any organized "production" becomes surrounded with them.

So, what was **CHANGED** during **REINCARNATION**:

- blood group;
- memory of the lungs;
- metabolic processes, including motor coordination (could change the gait);
- the memory structure, for example, knowledge of languages, skills in singing, etc.;
- new information records previously uninherent to the individual;

I would add that after reincarnation, **the NEW BRAIN** changed the "shirt", i.e. a man could be much younger or the opposite – a 3-year-old child could turn into an old man.

Thus, reincarnation had a feature of the Brain return when giving birth to a new life, or the **CURRENT** Programmed Brain **REPLACING**. Basically, the latter was used in the great amount, with all the consequences. Reincarnation was made only by the **Kailas Complex**. Only the representatives of the "Golden billion" were subject to reincarnation, and mainly the second part (the Brain replacement). If during the life time of the representatives of the "Golden billion" the Brain discrepancy to the Programmed requirements was detected, the **BRAIN** was **ELIMINATED**. **In 2000** there was completed **the 500-year** Program for the formation of the "Golden billion". The Control, "made" before the Easter, revealed significant differences in the Brain functions, and the Programmed requirements. **N. Levashov had "had a hand" in it**. In this regard all of reincarnation functions were removed up to the normal restoration of the Programmed requirements. All the representatives of the "Golden billion" since that time have been on **GENERAL GROUNDS**, without reincarnation. However, the System makes a selective individual Brain replacement, both in terms of exemptions and in terms of a complete replacement with the imposing of certain executive functions both for the present and the future. In this process the **Programs "SvetL"** have become an invaluable tool, with the possibility arising, to make a new record of information which was not earlier inherent to the owners with the subsequent Brain "transformation". But the Programs are **ONLY** a **POSSIBILITY** and the Owner's perspective to whom close attention will be paid. All the rest depends on the man. There could not be another way. Connections, bribery and the back door are **NOT ACCEPTED**.

The Church, which was established on the information about reincarnation, nowadays **IS** a **PARASITIC** element. In no way I want to offend the feelings of believers. **It's their choice and right**. And all the tales about a "future life" are designed only for their happy existence. And as much as I tried (using N. Levashov and A. Khatybov's works) to present my knowledge in an accessible and easy way, I do realize **that people are not able to suddenly part with the familiar clichés**. Especially if the mind has lost its elasticity and got rigid, which is characteristic of the old age – to part with the myths, **THOROUGHLY INGRAINED** in their heads, is not that easy. **But if people would like to recover Human properties to their distorted consciousness – that is quite possible, and my book is a step in solving this problem.**

Chapter 4. The basic functions of the atmosphere layers and the formation of people's consciousness

The change of the laws of nature is impossible. Ignoring the law does not lead to its disappearance, but to the disappearance of the one ignoring the law.

We conceive the truth when we see it. And let skeptics and mockers say whatever they like. Ganders will ask if you say something they do not want to hear: "Why do you know that this is the truth, and not your delusion?" The truth is often so simple that one does not believe in it. We conceive the truth when we see it, just as we know that we are awake when we are no longer asleep... The truth is the best weapon. ***Every truth is a system of knowledge, but not every system of knowledge is the truth.***

Today one can turn a blind eye to what is happening, to a sudden and rapid disintegration of the life habitual for us only **UNTIL** one day when the horrifying fact that we are really in great trouble **REMINDE** us in such a way that we will not be able to ignore it. Exactly this kind of reminding we are beginning to observe now. We are faced with events and conditions that are impossible to ignore. This is not a reason for despair. In fact, we do **NOT** really **NEED** any despair now. It was exactly the despair that created the problem and, of course, would not solve it. Time has come not to get despaired, but to correct what has been done. But you need to understand that the **DESTRUCTION of THE OLD** makes sense only when you **COMPREHEND THE NEW**. It is pointless to change the current understanding of what is happening for any other understanding that is not "supported" with **NEW KNOWLEDGE** and the experience of having been use them, because there will pass time – maximum of one or two generations, and maybe less, and the imperfect new one will get worse than the old one.

The solution of any problem has its own sequence. Without solving the previous one, one can not undertake the following. **WITHOUT BUILDING** the ground floor, it is impossible to proceed with the

construction of the following floor. If to act out of place and not in due time, violating consistency, □ this will, at best, be a waste of time, at worst □ it will do harm.

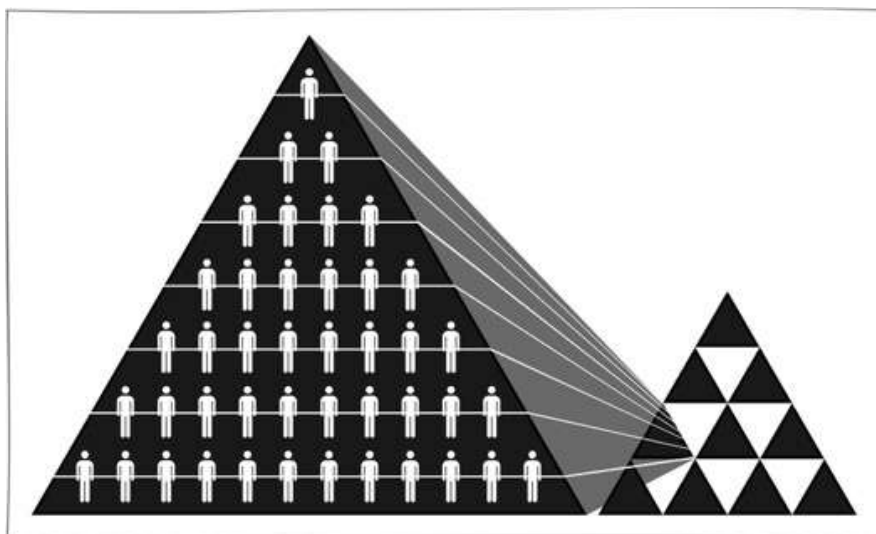

At present the whole world is seething, and this is happening before our eyes. Globalization, about which the majority knows little, has opened the borders of all states for the free movement of information, money, goods, and human streams. But inside these streams there moves **SACRED KNOWLEDGE**, which is **BEYOND** the **TIME**, space and power. And the "winners of election campaigns" or "military coups" are not able to modernize it under their intentions. The ruling "elites" still regarding themselves as the rulers of human destinies are *now experiencing the strongest intellectual and philosophical crises* that are already **NOT ALLOWING** them to influence (even if they shed sea of blood for the sake of it) the events in the world, and especially the people who are "waking up" from the age-old dream of ignorance just before their eyes.

Earlier I mentioned the words "sacred meaning" (sacral knowledge), which, perhaps, are taken for a literary ornament of my thought. This is not true. The fact is that any text or material monument is presented with facts, names, dates that are known and understandable to all from **the media, TV, Internet messages**. ***But this is the most superficial level of comprehending reality.*** Understanding the reality begins with immersion into the context, deciphering the values that the author defends. **N. Levashov** used to say exactly about this, and he wrote his works using this method □ the method of layering for a certain level of readers'

understanding. Look at his paintings, which he made in computer graphics and just try to explain (to yourself) the meaning of the image. These pictures carry very serious information. In the same way, all the writings of the **SRI (Scientific Research Institute) of the CPS (The Centre of Preventive Strategies)**, the writings of **Khatybov** and your "**humble servant**", as well as those who writes with prospects of developing people's understanding.

Immersion in a layer of the text – in the subtext, – deciphers the purposes for which it has been created. And only immersion in the following, deep and sacred levels of the text, brings to the **UNDERSTANDING** of the **MEANING**, for which facts, figures, dates, names are mentioned. Such a difficult immersion in the text can be compared with a record dive underwater, which requires special training, equipment and, most importantly, knowledge. There is a fourth and fifth levels of understanding the sacral meaning of the text, which I mastered, or rather, N. Levashov taught me. He did it unobtrusively, but persistently, perfectly realizing why I would need it. That's the Man he was.



My first experience in this was the "writing" of the **User Instructions for "SvetL" Complex**, which, as you have already got to know, carries **A LOT MORE INFORMATION** in it than a set of letters in certain words. At that time, it was impossible to "open" the operation of this technology, because almost **NO ONE HAD UNDERSTOOD** this, and those who had had it wanted and offered to use these technologies, to put it mildly, **NOT** for their **PURPOSE**. Today, the information laid down in the Instruction became open for many Users (though not completely). This is evident from the questions that they began to ask, advancing along their **WAY OF KNOWLEDGE**. But there are two more levels in the "dive." Unfortunately, I **HAVE NOT REACHED** those depths yet but I hope to. N.Levashov mastered all these levels, and in such a way "put in" the relevant information

with its sacred value both in his works and in the pictures that he "painted." But this is another story, which I am going to tell later.

To sum up, there are known well-known. These are things about which we know that we know them. There are known unknowns. These are things about which we know that we do not know them. There are also unknown unknowns. These are things that we **DO NOT KNOW**, that we **DO NOT KNOW** them. But there is also informational masturbation, when the application of knowledge is replaced with getting more and more new information, and today this is the sin of many. As a result, development is replaced with the process of obtaining information for development. You become **MORE** informed, but **LESS** intellectual. When this goes on a year after a year, it encourages self-esteem. You are becoming more and more **INFORMED** and ever more **EMPTY**. Information without **TRANSFORMATION** of **KNOWLEDGE INTO SKILL is a poison that destroys the ENTITY (the Brain)**.

4.1. Consciousness as a factor

Up to this day, many world scientists have been in a position of searching for the answers to a very significant question in people's being: how is **CONSCIOUSNESS**, both of an individual, and public consciousness of a specific community of them **FORMED**? What is Consciousness in general, as it is? Is the process of its formation natural, as it was considered earlier, or was it controlled from outside (but not in the sense of the active administrative and technical influential participation of certain political propaganda in any form of its manifestation). The generally accepted qualificational hierarchy of types and kinds of Consciousness, saturated with "professional" definitions from representatives of social and medical sciences, psychologists and other specialists, ultimately did **NOT ALLOW** people to fully clear up the **MEANING** of **CONSCIOUSNESS**. Moreover, until now, the question itself has been very problematic: In what way do mental and cogitative processes work out?

What is the Brain, and how is it really structurally made and versatile dynamic? If the Brain of people is practically alike in all of them (from the medical point of view), then why are they **ALL SO DIFFERENT** in their judgments and actions?

Many advanced scientists, thanks to the modern technical means of observation and registration of various induced reactions and changes occurring with the Brain of people under the influence of affecting factors of various character were convinced that certain regularities from the number of reactions recorded by them according to its factorial physical state are indeed being manifested, and this is **NOT DISPUTABLE**. But the obtained experimental material has not made it possible so far to come to the unity of opinions and, first of all, among various scientific directions. Closer to the truth about the essence of the consciousness itself were, oddly enough, the theologians and founders of judgments about it, supported with the basis of religious dogmas. They, though, with a certain uncertainty, but **WITHOUT** any **SLYNESS DECLARE** that *consciousness is given by the ALL MIGHTY*, and people are "only his mouth and everything that they create is the creation of God." In this there is a much closer approach to the truth than any other proposition, erroneous not because of the people's fault. Many modern scientists more and more often express the modest idea that the "Creator of the World Created" himself is far from being indifferent to people's reaching their intelligent state. The consistency and irreproachable timeliness of the **LEVEL** of **KNOWLEDGE** concerning people's deeds and events in separate directions of their controlled existence throughout the entire previous history is simply amazing with its anticipatory event accuracy in time. It is not the consciousness of people that determines their being, but, on the contrary, their social being determines their consciousness.

The closed research conducted by specialists of some scientific fields practiced in many countries of the world with the aim of acquiring different variants of active influence on people with the intention of imposing upon them forms of control over them through the concealed violence over their Consciousness would partially represent some interest. But the general true picture of the state of people's Brain such experiments have not given so far. Such experiments convinced the initiators only in one thing – to **FORCE** someone to be **CLEVER** has **NOT** been **POSSIBLE** so far, but to produce the executors of some unreasonable forceful character for the subsequent limited utilization of the experimental ones proved to be easier and more profitable with the use of other, simpler methods of influence, exploiting mainly human vices and interest of a personal nature. Reasoning and research in this way can bring closer to revealing some systemic deep secrets of the real design of the Brain, including the realization of the very fact of the functional purpose of the Man of the Future within the ongoing changes on the Earth, **NOT LIMITING** the depth of judgments with the previous

frames of the "philosopher's stone". First and foremost, it is for this reason that it is expedient to understand in what way, earlier, on the side of the old Interventionist System, **EXTERNAL CONTROL** of all the people's being and of the level of their Knowledge through their Brain was carried out. With what forms of influence was it possible to activate the various functions of the Brain? How was it being perfected on the stages of development of general and event chronicle processes? This will make it possible to perceive ***what Consciousness is, the way it had been formed, and changed over the stages of historical development, and so on.*** Serious help will be given to us on the issue related to the true Structure of the Atmosphere and the Control functions imposed upon it, which were put in its gratings by the old Control System, including the processes of formation of Consciousness and the public Consciousness. ***Consciousness creates reality, and you create your consciousness.***

4.2. Functions of the Interventionist System Atmosphere layers

In the scientific community there remains less and less former self-assured confidence in the unshakable firmness of the supposedly "natural basis" of Nature's self-development and similar natural development of the Civilization harmonious improvement, including people, and much more.

Finally, science has pondered the problematic questions – who or what, over whom or over what carries out a kind of mysterious governance unattainable by our Consciousness. And is there a fact in itself of its presence? Is there any control over them in people's consciousness, and if there is, then, how does this happen in the physical plan of the process itself, as it is? In what systemic way is the **HARMONICITY OF DEVELOPMENT** of all the variety around us in the material and non-material states of energies achieved? Probably, instead of stating foolishness of the necessity of the existence of naturally natural "food chains" in the whole biological environment, there are some more serious reasons for the existence of such a vast diversity of substances of biological species. Is any correction of this state of the **COMPREHENSIVE CONTROL** possible? If it is, what place is assigned in this current correction of conditions to people in the future, what is going to happen to them and what steps are acceptable

or necessary to take now to preserve their lives and be called for on this Planet, and not at the level of the current consumer prolific "animal husbandry for their own good? This is one of the key questions that is asked by those who has embarked on the path of **KNOWLEDGE** and who at least has begun to "understand" something, having awakened from a dream of ignorance, into which we had been sunk.

How did it happen that for the **LONG PERIOD** of the existence of life on the Earth with the participation of people, the comprehension of the essence of the occurring physical processes of supposedly some "self-development" is shielded with a dense curtain from the people's deep knowledge? Why did the "surrounding nature" turned out to be so apophatik¹⁹ for "thinking people"; they have already conquered everything in "the Nature" to an unrecoverable state? Who isolates them from such knowledge and why?

N. Levashov wrote about it very clearly. He deeply investigated this process, and it looks something like this: the deeper the world is "cognized", the more questions arise about the physical essence of the process of its existence. Most of the former basic constants and dogmas of both scientific and religious positioning fall apart in ashes, and the "new" ones are not always presented intelligibly and sensibly. Inquisitive minds are often carried away by the esoteric world outlook, demonism, cosmopolitanism and so on, thus making the way to the **TRUTH** even more **UNATTAINABLE**, leading such an unstable knowledge to a state of complete misunderstanding of the truth itself.

There is only one path for us – to find the truth about the "World Created ", which will **MAKE it POSSIBLE** to **CLEAR UP** the hardened Knowledge at least about people as some kind of intelligent beings (the only one of the whole variety of biological world substances), pave the way to the development of the general level of the *former stagnant state of Cognition of the surrounding World*. Is it possible within the current level of the Brain octave, the state of its functions and the corresponding mechanism of people's awareness? And if it is possible, – what **CAN** people **DO** for this? Here comes the question in relation to "**SvetL**" **Programs**,

¹⁹ from Greek apophatikos – negative) is a property of thinking that promotes the self-denial of man as a perfect being, the use of Apophaticity (free will for the fulfillment of Divine commandments and the constant abiding in the state of confession of his sins and repentance.

their application, the expansion of knowledge and personal understanding – what they are for today.

Within the framework of the problems of formation of individual and public consciousness of people, the nature of its current state in connection with the ongoing **SYSTEMIC PROCESSES** of cardinal changes, let us consider the construction of the Earth's Atmosphere Gratings. And to be more precise, we deliberately limit ourselves to considering only some of the basic functions of the control so that to ensure the existence of people's lives.

4.3. Formation

All the true Atmosphere layers, as the most complex harmonious Construction of a strictly identified set of its energy gratings, were formed in the model creation of the Earth. Exactly this true layered design of the atmosphere provided, first of all, self-governing by the Programmed "Natural Habitat and the Controlled Environment", which, in turn, fundamentally based the very fact of the "origin" and existence of the true Life itself with its orientation to the "Intelligent basis".

Moreover, only such a specific design of the Atmosphere was to be one of the mandatory conditions and at the same time an important closing link in the formation of mandatory conditions for ensuring step by step development of the Earth Mind and its unconditional very important role, – the Human Mind. **NO** other harmony **COULD HAVE BEEN** in the development of the true Earth Civilization, and all the rest is inappropriate for *the intelligent life*. Such is its true Programmed essence and the embodying civilization Entity.

For the Earth (as a specific model complex □ a Planet), located in its functional endowment in the Common Hierarchy of the Planets, program-oriented to the development of Civilizations of "Intelligent orientation", the following is envisaged (enclosed): The entire incarnation of the most complicated path in the development of its Civilizations **IS TO BE IMPLEMENTED** in *eight consecutive stages of an increasing level of perfection* (in a tact of event-driven time in the course of the gradual Programmed chronicle process), with the achievement at each of them the complete perfection of the harmonious "**energies being**" within the strictly set up limits of the octaves of these energies for each particular stage.

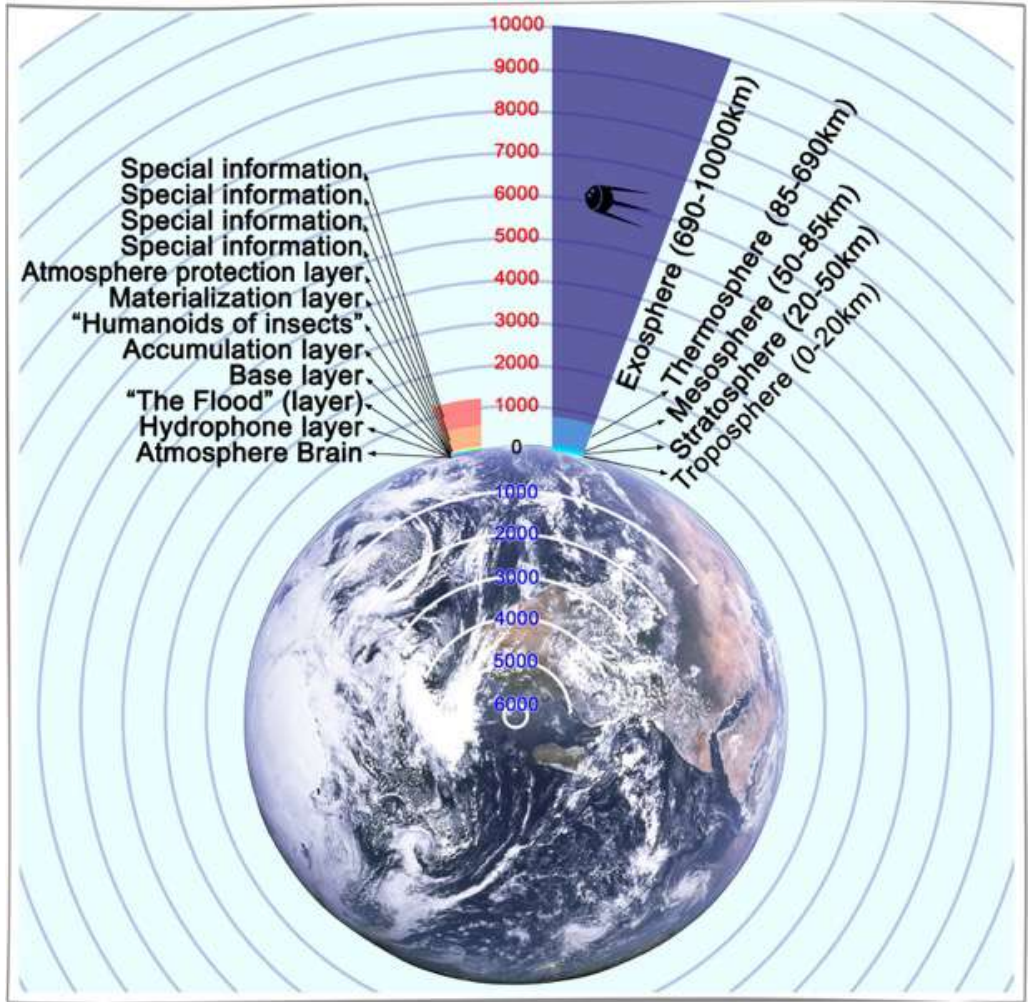

Such a complex process of development in the harmonious being of energies envisages both its own Programmed Control capabilities for all the ongoing chronoprocesses with the help of the Earth Control System and the possibility of "external" assistance and control providing **LIMITED INTERFERENCE** from the outside in the process of governing on the conditions of guardianship. Here it is worthwhile to remind those who are skeptical about **Levashov's** abilities – he was able to interfere and did interfere (even judging by what he wrote in his books) in the processes of the Control.

It looked something like the picture. It shows the work of **Levashov's Generator** (transferred from France to Russia) with the interaction and correction through him of the energy of one of the processes of the Control, a concrete action (process) related to the real events.

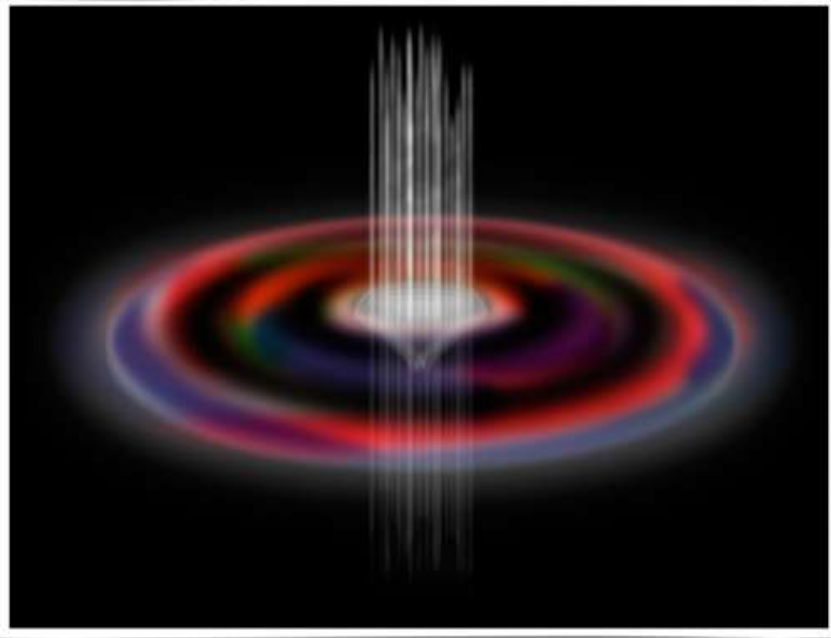

By the moment of the Interventional capture of the Earth²⁰ it had been only at the **FIRST STAGE** of its civilization development, providing an admissible limit of getting its perfection for "the whole spectrum of arrangement of life being" of energy octaves, equal to **12-512**. Our Earth is young by the standards of another kind of time. It was exactly within these limits of the energies octaves that the entire true "**The World Created**" for the Earth Planet was formed, as it began its own far-reaching path of the perfect development, possessing a unique state of life **STEP-BY-STEP GOVERNING** aspiration for the "**Intelligent²¹ Orientation.**" This **NATURAL STATE** of the developing energies matched the construction of its harmonious and rigorously identified Structure of the energy gratings (identified dodecahedral structure, i.e., the **Di structure²²**). The developing process was under a single Control on the side of its own Earth Control System, programmed to achieve the perfect harmony of the "energies being" of the entire Planet in their **material and non-material**

²⁰ Materials in Part 1-4 "Fundamentals of the Formation of the Mankind".

³ "Intelligent" is like thinking. Accordingly, replace everywhere "intelligent with thinking" and then you will see that wisdom is a goal or an already achieved state, and thinking is a process leading to this goal.

⁴ Di-structure – 8 dodecahedral-icosahedral (DI) blocks, each block has nested DI blocks (total in one DI block 44 attachments). The structure is constructed using the properties of the golden section (without the golden section – just nowhere). The state of the structure is **HIGHLY ORGANIZED PLASMA**.

states. I would like to note an important feature. The Civilization developing²³ process for the Planets, having the existence of a concrete life on each of them and being in the Common Hierarchy²⁴ of the planets of the "Intelligent Orientation," is to be some **ENDOWED WITH** mandatory condition. This **MANDATORY** condition, connected, first of all, with the fact of recognition of the achieved level of their perfection in their development and transition from stage to stage, is the obligatory achievement of the necessary level of perfection of the Mind of the Planet. Achieving **ONLY** a harmony of the existence of energies in their material and non-material states is **NOT SUFFICIENT** to be recognized as the appropriate level of development of Civilization on the Planets having life. The same reasoning can also be found in N. Levashov's writings. **Lots of Lives, but few Minds!** The rest of the Planets not having "living conditions" are **PREDETERMINED** by the Program for the **LIMITED** process of their development or the absence of such at all. They are functionally used as "warehouses" **for the accumulation and storage of some forms and types of energies in their various states** as producing generators of something under someone's control (including information of various kinds) or performing various types of protective, recycle-regenerating, experimental functions, etc. And, accordingly, by their constructive form and content they are arranged in a completely different way (in contrast to the Planets possessing living conditions), but harmoniously to their identified function. In each planetary, galactic, intergalactic and other **CLUSTER SYSTEMS**, specific component elements of the Planets are required. Variety and their composition depend on the functional purpose of this cluster level.

For the Earth, in particular, **the development of the Mind of the Planet IS IMPOSSIBLE** without the harmoniously developed Human Mind as the very fact of recognizing the perfection of the Civilization development level. Consequently, the transition to the second stage of development, which provides for raising the upper permissible level of **energies octaves from 512 to 1024**, etc. with the increasing discreteness, **IS also IMPOSSIBLE**, i.e. there is no, and there cannot be any movement in its development.

²³ Proceed as a consequence of the cause. From an insignificant case, important consequences emerge.

²⁴ Hierarchy (from other Greek – ιεραρχία) – the order of subordination of the lower links to the higher.

For this reason, the recreating Man is important precisely by the fact that his associated ***Mind is an integral part of the Mind of the Planet***, without which the latter is improper (incomplete). But the Human Mind is also not independent, since it only is able to develop in the process and through the development of the Mind of the Planet, and necessarily with the accompanying process on the side of the true Earth Control System.

In this connection, all sorts of myths about the development of supposedly some kind of **the fourth Civilization on the Earth** are **NOT TRUE** (just invented) and are an evil intent on the part of the Interventional Ebr system. The true basis for such judgments does **NOT EXIST** at all, since even its first "native" civilization has not been developed and completed to its perfection and harmony, since **18000** years ago such a development was halted by the intervention of the alien system!

This most compound process of the complex development of the Earth Civilization (so far within the limits of 12÷512 energies octaves) has now begun to **RESTORE** in all its **TRUE** states and directions, getting support of the original Earth Control System and external guardian assistance from outside, on the side of more developed Governing States and Civilizations. At the same time, all the consequences of the former Interventional constructive and governing interference have been **ACTIVELY** liquidated.

It was in this "process" that **N. Levashov** took an **ACTIVE PART**. This was the **MAIN REASON** for the assassination of Svetlana (his wife), and then him. Now we already may talk about it. Only a part of what was done by them and realized (here I emphasize – together with Svetlana and without her participation), is described in his works. All the rest was done without publicity (although those who had to know about it they did know).

Very appreciable help was given to Levashov by the so-called "**White Brotherhood**" and especially when the so-called "**The Abode of Gods**²⁵" appeared within the "visibility range".

⁷In parts, Levashov wrote about this in "The Mirror of My Soul".

4.4. The Abode of Gods

In the last century, Russian mathematicians carried out an interesting study. In a powerful (for that time) computer the scientists downloaded data of all the laws of the natural sciences and asked one question: "**How does it work?**" The computer gave the answer: "**To make this work, there must be an external governor.**" **In fact, the existence of God was confirmed.** (We have already understood what God means). But where does he "live"? Where is his "abode"? Perhaps the answer **came in 1994**, when the Hubble Space Telescope took photos of the unique object.

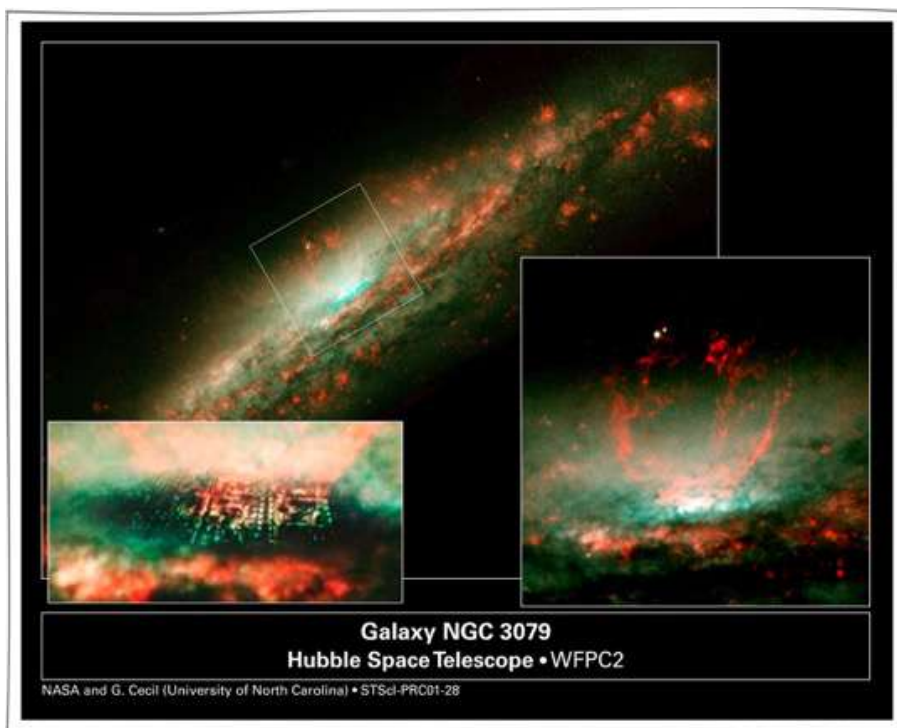

In the photographs, the interest of scientists was caused by a small vague spot that did not explain any interference or optical effects. Additional pictures were taken with the maximum resolution. What the NASA scientists saw, **the government immediately classified as secret.** But this information became available.

What did the specialists see in the picture? Professor of the University of Florida **Ken Wilson** saw a city, a real city. The shining structure, reminiscent of Swift's "flying island," seemed like an unreal city of the future. The object that appeared in the picture was called "**The City of Gods**" or "**The Abode of God**".



This city is stretched in space more than several billion kilometers, and in comparison with it, the Earth is just a speck of dust. What has been found in the universe? There are lots of assumptions on this subject, but they all can be brought to **TWO VERSIONS**.

6. An Unknown super-civilization **HAS CREATED** a **GIANT CITY**²⁶, which is noticeable at such a huge distance, although previously objects of such magnitude had never been found.

7. This is the place where the Creator really dwells.

Scientists continue to study this site of the universe, but all the new information is still classified as secret. It is classified as secret only for one purpose – they (some of the "powerful of this world" – ebers or blacks, or spiders, as you like it) have "**RECOVERED** their **SIGHT**": **Firstly** – "this" has been created beyond their will and understanding. **Secondly** – "this" has destroyed much of what had been created within their Control System and not only. And **thirdly**, the **White Brotherhood** exists, and its "representatives" control the changes that are taking place, and they reinforce their ranks.

After the assassination of N. Levashov, as I wrote in 2012, **8 "people"** involved in his death, **6 in Europe** and **2 in Japan** were annihilated. The slogan of this action was "**For Christ, Alexandra, Nicholas and Sevastopol ...**"²⁷ This is how it was "covered" in the media. "In Osaka, Japan, on August 21, 2012, immediately after lightning strikes and a severe

²⁶ N. V. Levashov – The Mirror of My Soul.

²⁷ Radomir, A. Khatybov, N. Levashov and... Sevastopol (as the planned capital of the Jewish Kaganate).

thunderstorm, some residents were **SHOCKED** by an unusual **PHENOMENON** – the light pillars." (The photos are taken from Twitter).



One of the authors writes that he only *wanted to shoot the lightning, but it turned out to be a photograph of the post that appeared immediately after the lightning strike*. He, for some reason, called this phenomenon "The strike from Laputa" (Laputa – "the Flying City" in the clouds). Further, I hope, everything is clear.

Approximately the same happened to the people who had been preparing to "shoot down" the plane over the Sinai Peninsula. They are going to be mentioned later on – practically **NOTHING REMAINED** of them, as A. Khatybov put it – "crumbled to dust", and after that, many "powerful of this world" got seriously worried.

In the fall of **2014**, I went to Europe, to the foothills of the Alps, where I met Levashov's Friends. N. Levashov mentioned them for the first time when he described everything that was connected with the assassination of Svetlana. Nicolai tried to "revive" it, but he did not succeed. And then he asked his Friends to do it, because, as he said, they had such capabilities and were able to help. But he received a reasoned refusal and justification of the **POINTLESSNESS OF THE SUCHLIKE**. He told me about this before leaving for Svetlana's funeral, when I came to see him just a day after all that had happened. Human emotions are emotions, but even then I knew that emotions are hostile to clear thinking, because they are – to some extent – an indicator of some mental disorder. Nicholas felt Svetlana's death keenly. But, in my opinion, he realized that there was also a real expediency. This expediency was in the actions of his Friends. And if we go back to the beginning of this chapter (to the layering of writing texts), Levashov's words about Svetlana's death bring us to the conclusion: "Apart from Levashov,

there are **Humans** on the Earth who are **MORE CAPABLE** "in comparison" to N. Levashov (although this, in my opinion, is incorrect comparison)." Here I got to know them (or rather they got to know me) just on the second day after **N. Levashov's** funeral in Moscow. I wrote about this in an article on **TRAGIC EVENTS on June 11, 2012.**

At the meeting (or rather, the seminar) in the Alps, much was learned and some practical skill came in many ways. After that, I already reasonably checked the efficiency of "**SvetL**" Programs, having realized their "hidden" capabilities, as well as the possibility of their correction with respect to the current events.



And to be more precise, I "defended" my knowledge in "SvetL" Technology before very strict examiners who also told me those things that N. Levashov and I **HAD NOT HAD TIME** to discuss. I will not touch on all the details of this seminar. I can only say that much that happened after the death of N. Levashov was radically revised and thought over. For example, I got convinced in my own experience that **Man, in his present-day EARTHLY countenance, IS NOT ABLE to move and develop the Space.** But this does not mean that a Man **CAN NOT do this.** With the help of the Friends, I was given an opportunity to "visit" that very "**White Star**", or "**The Abode of Gods**". Then I have not been able yet to make such "trips" by myself. I would like to note for those "writers" and "followers" of **N. Levashov**, who broke into groups according to "their own interests" and today they are nothing but **gaping void of wretchedness**, that I am going to disappoint them. There is no "holographic monument" to either Nicholas or Svetlana. The memory of them is expressed in a different form. **And this memory – lives.**

After the "excursion" I got to know the real truth about what was **under the Levashov's Castle in France.** I was shown how immaterially through two objects (rings) that you see in the photo and that Nicolai and Svetlana had on them there was governing of what that was under the Castle that time.

Levashov, of course, could govern without these "objects", but they made it possible to do it most effectively and, if necessary, – point-wise! Moreover, as it later turned out, they "have been "created" and handed over

to Nicholai and Svetlana precisely for these purposes by those who "had placed" it under the Castle (I call this creation the **GENERATOR OF SUPPLEMENTARY ENERGY** (for the people to have an idea of what it is). Who and what for it has been made – I will slightly open. This is all – *man-made*, as well as *the "White Star"*. For Nicolai Levashov, it was an additional "tool" in his work, **PRESENTED HIM** by those who knew that Nicolai 's hands are reliable hands.



After the acquisition of the Castle and the full information – why and what for exactly this Castle was to become the property of Nicolai (besides the related Svetlana's ancestors), these two objects (two rings), the photograph of which you can see, belonging to **TRUE TAMPLIERS** (not those described by historians with distortions) *were handed over to N. Levashov by Svetlana's relatives*. These relatives are the direct heirs and descendants of those true Tampliers who knew the "secret" of the Castle, but they **WERE NOT ABLE** to use it properly. *Nicolai made up for it*.

At the seminar, in daily talks with Levashov's, Friends I got to know the time and the possibility of my participation in the transferring this creation – *the Generator – from France to Russia*. I also knew why this was necessary and realized that at the **DETERMINED TIME** all this would "come" to me in both tangible and intangible "guises", which would allow using these "tools" exactly in Russia and applying the emerging **NEW RESOURCES** in "**SvetL Technologies** (and not only). Moreover, I got the confirmation of all this when I visited the north of Iran (almost immediately after the seminar in the Alps) in the place where **N. Levashov** had been twice in his time. But that is another story.

Everything happened exactly as I had been told, and today it does not matter in what way these items became "mine" and ended up with me. I'd like to note that other very valuable items belonging to Nicolai "have come up" to me. I knew about their "resources" from N. Levashov, who showed them to me both in the photo and as real things. The main thing is that these items (each one for certain purposes) are already "working" for the good. The use of these rings, not as decorations, but as tools, for example, is an appreciable help in setting up generators for the **New Complex "SvetL"**, "**intensifying**" the Generator (its original parameters) and "**SvetL**"

Programs through direct interaction with **the Generator of the "complementary" Energy** (this is my terminology) which was transferred to Russia, more precisely, to the North-West of Russia.

Everything that is connected with the **TRANSFERRING** this unique man-made (I emphasize – man-made) **CREATION – the Generator "under the Castle"** (from a depth of **1369 m**) – has been realized and allows to significantly influence the processes that the reader already knows about. Regarding the Castle itself, I believe that now this matter is closed to me. I **DID NOT** and **DO NOT HAVE** anything to do with it.



I myself have **NEVER BEEN** to it. Some halls and his study with the library, as well as paintings that were in the castle and sold at the auction in 2016, unclear to whom and for quite a "ridiculous price" (this is a separate topic of the narrative, which I will probably soon disclose), Nicolai showed to me, when we talked on Skype.

Most of all, I was struck with a picture painted by Titian and acquired by Levashov in France "**Tarquinius and Lucrezia**". The picture was painted **in 1535 for one of the greatest patrons of Titian and a friend of Marquise Frederico Gonzaga**, the Duke of Mantua on his personal order. This is one of the most unusual and intriguing paintings by Titian, in which the great master painted a **REPLICA** of Gonzaga's face as the face of Jesus Christ. And later, I saw the documents for this picture, which confirmed the genuine Titian



After the death of Levashov, due to certain circumstances, my friend and adherent **Alexander Kalenyuk**, was in the castle several times, he viewed the castle and captured everything in the cinema and photo documents in sufficient detail. He saw all the paintings that belonged to Nicholai and Svetlana, before the auction. I have this material and it is more than enough. However, after the auction for the sale of property in the castle, which, as I said **was held in 2016**, the Castle today is of interest only as a historical building, and **NOT MORE**; it will be realized, at the request of the heirs, at an auction that will be held in France. So, you can see that even this is the justification for moving the Generator to another place.

I convinced myself more than once of the sagacity of N. Levashov. Since June 2011, already under his supervision, there has been going on its activities in Russia and abroad, the organization created by me at the

beginning of two thousandth (historically revived), which I called "**Russian Scientific and Technical Society**" ("**RSTS**"). Many people ask: "Why is this name?" Not in the title is the essence. The essence is in the action. "**RSTS**" is the organization of a group of "St. Petersburg" scientists to solve problems in the field of new breakthrough technologies. Practically, by that time, "RSTS" had fulfilled the tasks, initially put before it. And they did it **NOT ONLY** in Russia. I was about to close it, because practically all its participants, having completed the tasks, began to work in a number of other directions. It was objectively, unfortunately. But the correction that Nicholai brought, after getting to know about my ideas and the story of the "**RSTS**" **creation** put everything in its place. He made me believe that the **ORGANIZATION NEEDED** its **REVIVAL**, further development in working out those technologies that we have already begun to deal with under his leadership. And the process of transformation made a start. I can **NOT** fail **to MENTION** here the enormous work of **Vinogradova Nadezhda Timofeevna**, who, since the 2000s, has been at the very beginning of the **RSTS** creation taking upon herself all the routine and paper work, which was abundant.



On Levashov's insistence, the attributes of the society were developed, and the Sign of the "**RSTS**" Participant became a silver ring (with the symbolism from N. Levashov).

The first two Signs, according to his sketches, of the pure gold, were made for both of us. But after "being in the hands" of N. Levashov, the atomic structure of the metal has changed, and it was **NO LONGER GOLD**. **ALL** the **FOLLOWING** rings were made of silver. The first silver rings (signs) **WERE PRESENTED** to **Nadezhda Vinogradova and Alexander Kalenyuk**. Exactly silver is that metal today on which the "Generator" feels "comfortable".

The Generator is set in the ring with the Programs personally for each owner. They help the Man to open a very broad perspective with his proper development. And, of course, "protection is put in" in the broadest sense of the word (and from the "fool" too). All this was "thought over" by N. Levashov. He insisted that the Sign



should be made precisely in the form of a ring, explaining that "there are words that can be incomprehensible and not perceived in any language, and there are symbols and signs that are" weighty than words ", and for those who are initiated – they do not require any explanation. " Moreover, taking into account the participation of women in the organization, as an additional element **EXACTLY FOR THEM**, a stone (sapphire) was set in, which gave **NOT ONLY** elegance but beauty to the ring on the woman's hand.

The organization was launched on the day when N. Levashov appeared "with his Sign" "**RSTS**" at a regular meeting with readers. This was understood **NOT** by **MANY**, but those who had to understand – they understood. This **WAS** the **BEGINNING** of the "**PRESENCE**" of the so-called "**White Brotherhood**"²⁸ **directly on the Earth**. And with some "representatives" of this "organization" I have the honor to be acquainted.

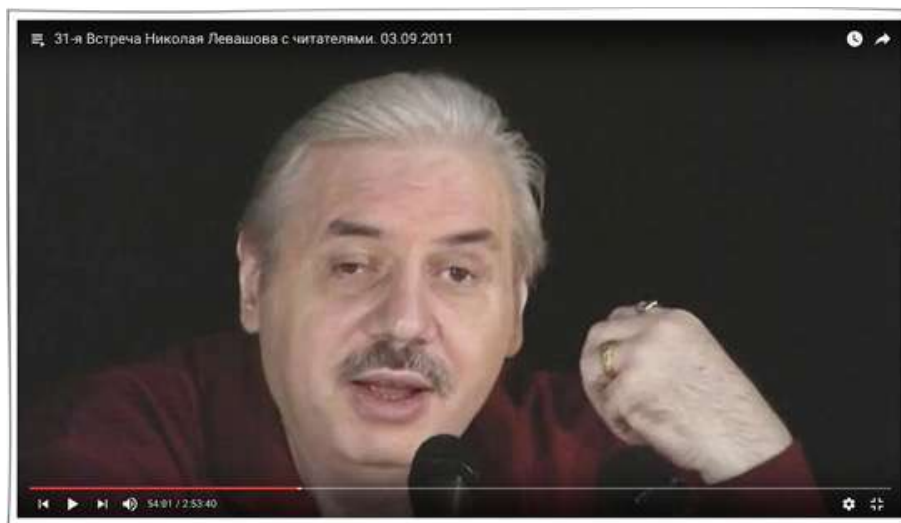

I have told you much of what I got to know. I have revealed some possibilities of applying the "heritage" of N. Levashov, but I am closing with dots more detailed information, because **THE TIME HASN'T COME** yet to make it public. I do not mean the enemies. Who are those who, after the death of N. Levashov, made public what had been "closed by dots" in his works, obviously thinking, that it would give them the "weight of the initiated" regarding the admirers of **N. Levashov**. They opened but **NONE**, until now **HAS GOT AT THE MEANING** of or commented what was "opened" and what it was "opened" for. I am sure that in the very near future

²⁸ "White Brotherhood" is an intergalactic organization, described by N. Levashov in the book "The Mirror of My Soul".

it will be possible to "disclose" this information that will become the **KNOWLEDGE** of the ready to accept **PERSON**.

.....²⁹

4.5. The root of the problem

Outlining this information and understanding all the specificity of the topics touched upon, first of all, I address it to those whose goals are **NOT LIMITED** with the framework of this world, but expand to the fields of, let's call it, metaphysics. I do want *this information to become basic for many of you*, the one which would push off further, if, of course, there was a desire. I deliberately "simplify" the information from **N. Levashov, A. Khatybov and the Research Institute of the CPS** (the Centre of Preventive Strategies) making it, in my opinion, more accessible to the reader. However, it is impossible to give such **BASIC INFORMATION** to the majority through logic. Even the most simplified text, many of the readers forget and return to their subconscious settings the next or in a couple of days, – not because they find some logical inconsistency, but because the information contradicts the existing subconscious settings. ***The unconscious is stronger than the conscious.*** But I do want to hope that the conscious will become stronger if the Human himself wants it. Therefore, I will persistently write it again and again, but on more expanded information. I **DO NOT HAVE DOUBTS** that people who are now participants of "**SvetL**" Programs will get a deep look into the essence of the written. But so far there are **NOT ENOUGH** of them, and if the others get interested in this or that way – ***there will be a breakthrough.***

However, we have to go on with the narrative. The most complicated true Construction of the entire **LAYERED STRUCTURE** of the Atmosphere before the intervention had contained such a complex of energy gratings under which in each layer there had been its complex set ("recipe") out of the group of energies frequencies from **12 to 224 octave**, mainly and even with some individual elements up to 512 octava (only out of the Di-structure). This layer-by-layer energy Construction of the Atmosphere Gratings **PROVIDED** the **FORMATION** and retention in the given program harmony all the specifically necessary variety of the progressively

²⁹ Not public for the time being.

developing harmonious being of energies ***in their non-material and material states***. For all that, gradually and strictly with respect to the given tact of event-driven time and the framework of the general chronoprocess, the process of improving the energies being as a whole and harmonious with it, the **DEVELOPMENT** of the **MIND** of the Earth and the **MIND** of the **HUMAN** occurred.

The Mind in itself is not something vague and formless, i.e. unconstructive, uncontrollable and non-systemic existence of energies being. The **Mind** is also a complex of a special functionally different being out of all possible limits suitable for controlling octaves and energies states over the energies of other octaves and their states, with reference to each specific stage of the Civilization development. Template-machine, i.e. certain mechanical "computer programmed" or limited mathematically-systemic approach to methodological forms of perception and attempts of judging the Mind in this case is unacceptable. It (that is, the Mind) in its development acquires the same **STAGE-BY-STAGE PERFECTION** of such Programmed functions and abilities of Controlling all development processes of the Civilization in general, which **IT HAS BEEN INDOWED WITH** as far as the model formation of the Earth planet. It has the properties of control and self-control, as the well as functional abilities of the Control, the conditions of various forms of contact, including the individuals (that is people), objects and the Control and Support complexes, transmission, reception, decoding and storage of information and the inherent conditions of a completely different level of ***of "Life" definition as the form being*** and the state of the complex out of the whole "set of energies" as a programmed true essence, acting as the leading orientation and control over the "correct" Civilization development as a whole. This is absolutely **NOT SPONTANEOUS**, but a concrete objective and pre-oriented **TARGET PROCESS** of the development of methods and forms of governance, which are only being perfected with each stage. **AND THE MOST IMPORTANT** – ***The Mind is material, since part of the Mind construction of our Planet is composed of the "matter of magnetic energy" within certain limits of energies octaves!*** Moreover, this matter has the ability to move and at the same time, it **DOES NOT HAVE** any obstacles in its movement, the speed of such a movement is many orders of magnitude higher than we understand and compare with the speed of light (photons). Understanding this, **GAVE ME THE RESOURCES** to start "experiments" with the "impact" on specific objects, including people, first through the Complexes, such as **"SvetL-Flora"**

Complex, and then directly with the Brain of a certain Person, concerning his recovery. For me it was a great victory. But this victory would be **IMPOSSIBLE**, as I see it, without my acquaintance with Nicolai Levashov.

How can the lower comprehend the higher? The question seems to have no answer. Not exactly, because the lower can comprehend everything only with the guardianship of the informational support, governance and control of the higher state. This should be referred to **the "SvetL" Programs**. We should also answer the previously unanswerable question: **how can the Brain comprehend itself?** It is also able to comprehend exactly itself, but only if parts of its constructive functions (less or more is not important) **ARE CHANGED** to a **HIGHER-OCTAVE** level. This is not a state of some flashing or forerunning some scientific discovery, it is a much more perfect state of the forthcoming change in the level of the whole Brain octave. This is still ahead of those who are directly integrated into the future. Would you like to check it out? Mentally ask yourself the question – **"WHO AM I?"** Immediately all emotions will go away, because the Brain will come into "stupor". It is unable at the current level of octaves to answer the question to itself – **WHO IS IT?** But **the Mind** has to be "turned on", which will make it possible "to receive" direct information from the Control System, which, in turn, affects the increase of the Brain octaves. So everything, as you can see, is interconnected. And if you are a user of **"SvetL" Programs**, there is a great chance of what we have already talked about – you will be "taken" **to the Bath**. There you are going to "be sweated" and "washed..." This is a kind of some useful deviation in the judgments.

It is good enough to ask questions of an unusual sound for the science, – what kind of Mind could the interventionists impose on our Planet? In what way and what kind of constructive and functional orientation did they develop it? What kind of Mind did they put into people and with what subsequent program objectives? What for did they **NEED** people **IN GENERAL** and exactly with **THAT KIND** of Mind, that was imposed? I will try to answer these questions, but first of all it is necessary to have some information about the Interventional Atmosphere Construction, which played, in this respect, **QUITE** an **IMPORTANT ROLE** in their "Created World", which basically provided the environment conditions on the Earth, acceptable for **"interventionists"**.

This part of the "Created World" both in religious and scientific dogmas is **MORE USUALLY** defined as **certain apophatic Heavens**, which really possess a huge set of not only certain mixture of gases

supposedly necessary for life and miracles occurring in them, but true majestic mysteries that are not known to this day.

It is quite enough to enumerate such, until now unknown, speculative manifestations and effects of physical processes in the Heavens, **NOT PLAYING** a leading role in the destination of the "Heavens" in general, like thunder and lightning, the northern lights, the origin of systemic and non-systemic air streams, rainbow, precipitation, sounding and intimidating rumble, which appeared now in certain regions of the planet and so on.



Let us return to the consideration of the arrangement of the true Construction with respect to an incomplete set of all previously set in functions on the Atmosphere layers. The fact is that this issue is a very narrow specialization in the processes of the life being Control on the Earth as a whole, which significantly affects the essence of the transformations in the near future. Therefore, **IT CAN NOT** be published in the conditions of the remnant aggression, as a complex interconnected **STATE** of the **PART** of the imposed functions of the Brain of individuals ***with a certain genotype of the Brain***, making up the former level of Consciousness of some people of the present time in auto-motor style who carry in themselves the imposed vices and violence.

What is offered to readers about the Construction of the Atmosphere is only **SOME SUPERFICIAL** component of the general knowledge of the **NOT HAND MADE "the World Created"**, limited by the scope of the explanations given.

4.6. Understanding

After the seizure of the Earth the structures of the energy gratings of all the Atmosphere layers were **BASICALLY CHANGED** by the interventionists due to setting in the "imported" energies base octaves and their own accepted forms in arranging energy gratings, but only in the range **of 15 to 128 octave**. The fact is that in the general interventional escort, as I have already mentioned, three moons arrived. But with the self-destruction of the Planet **Phaeton**, the most perfect two were eliminated. For this reason, the ultimate of the "delivered" octaves of the basic imported energies was limited. Within these limits of energies octaves **THERE WAS COMPLETELY DESYROYED** the entire true (child-bearing) constructive filling of the energy gratings **in the Di structure and replaced for a cubic one, i.e. K-structure**. But **from 129 to 224 octave** the true original base energy frequencies in all the Atmosphere layers remained in the former structural state (**Di-structures**) as a fact of inaccessibility in their elemental construction due to the limited technological destructive possibilities of the interventionists. However, for all this time (**i.e., over 18,000 years**) the potentials³⁰ (potential density) of the frequencies in these true energies octaves (**129÷224 octaves**), **NOT BEING** in the maintained state **of energy "recharge"**, were approaching zero and **by December 2012** would have disappeared (collapsed according to the plans of the Interventional program), and the Atmosphere structure after this destruction would have to contain **only imposed k-structures up to the level of 128 octave**. This would have become the irreversible finally captured state of the Atmospheric Construction, in which case the Earth would have actually carried out its self-liquidation in general. I'd like to note that **"SvetL" Programs** as well as **the Generator** itself, after their "creation", also required **SOME ENERGY "SUPPORT"**, because all of these "were created" in the previous Interventional energies octaves. This support was implemented first by **N. Levashov** himself (that is, he himself created this "replenishment") then the so-called **Generation Matrix** (creation) of the Generators left by **N. Levashov** for direct application. But the Matrix's capabilities are limited (and the Matrix itself required "replenishment"), and the number of "having created" and "being created"

³⁰ Generalized characteristics of the interaction of charges in the investigated region, with the charge of the energy imposed on this region of the octave. It is impossible to measure this parameter with the instruments of modern science.

Generators – was growing. This was one of the reasons for the transfer of the "Energy" Generator from the territory of France to the territory of Russia. It was under this action that a **NEW COMPLEX "SvetL"** has been created, which has shown its excellent efficiency today. But we will not be led away from the point. All information about the fantastic "horror in Hollywood scenarios", symbolizing some "apocalypse", really through different representatives (mainly individuals of 423 and 441 genotypes of the Brain), was broadcast earlier by the Interventional System during the last several centuries as a kind of providence of various Armageddon. And this process of the Governing Support has also been eliminated now. Scenarios of "the end of the world" are in vain. And the very process of eliminating the intervention consequences in part of a new arrangement for recreating the Atmosphere energy gratings and bringing it back to the previous one, i.e. "virgin" state, is taking place without their interference and not in line with their will and diligence. But according to the true scenario, this process is going to be even much tougher than the fantasy frames of their crafty "filmmakers" – the apocalypse is not only **STARTED**, but **HAS BEEN UNDER WAY SUCCESSFULLY** at an increasing pace. Inessential part of its manifestation, i.e. its occurrence in the material states of energies octaves is being observed and will go on to be observed by people during the entire Transition period.

The layer thicknesses of the Atmosphere were also changed for all the basic parameters adjusted by the Interventional System for the appropriate arrangement of the Construction from the k-structures with the introduction of only their communication frequencies, which could ensure, among other things, their own steady controlled information contact with their planetary satellites, the Moon and the Sun, i.e. with all of its fleet of planets. In addition, all the technical development of the Interventional System was accompanied by the introduction of such newly set in frequencies into those layers of the Atmosphere in which there had to work **ONLY THEIR** "technical system of translation" of energy-information support of their entire controlled and organized being of energies, as imitating the development process of **ALLERGEDLY CIVILIZATON** of the Earth as a whole.

Moreover, in the original (native) true layers of the Atmosphere, additional, specific **TARGET CONSTRUCTION CHANGES** were imposed. For example, with their help, all conditions were created for receiving tritium from the satellites of the planets (as from the transported

"warehouses" so necessary for the operation of their objects and complexes) as the only acceptable form of energy consumed by them.

In addition to receiving such a form of energy as tritium, another thing was important, too. Tritium needed to be transformed, stored in acceptable energy states suitable for using it and dispensing for both objects (including conventionally called UFO), and for biostructures, namely, those that **only** they (the invaders) managed to get them materialized for their plans and for their subsequent program needs. It was through the use of such necessary brought and transformed tritium that there was **IMPOSED** an **OVERALL PROCESS** of reincarnation of the entire construction of the energy information arrangement and the state of all kinds of water on the Planet. And through the altered complex state of water there followed the **MOST SIGNIFICANT CHANGES** in the formation, support and Control of all the complex conditions, without which the existence of any life on the Earth could not have been possible. And this is far from being all that was affected by the modified Construction of the Atmosphere gratings in all its layers. All together – it was already **NOT** that **TRUE "the World Created"** that has changed and distorted everything on our Planet. Despite that serious constructive changes with the Earth, **IT HAS SAVED** its position in the Common Hierarchy of the Planets of the Intelligent Orientation. But in reality there had been a **PROCESS** of **"IMITATION"** of development of its civilization for ***the past 18,000 years***. This conclusion suggests itself.

4.7. Variations

It is necessary to note an additional, but very important, point. The changed Atmosphere Construction was also to be such an environment in which **VARIOUS MOBILE** ground and sea placement vehicles brought by the Objects (so called UFOs) could be provided (i.e., energy attended) and freely transported by the Objects, the so-called **UFOs** performing part of the Control function of the Interventional System for **ALL** the resultant **PROCESSES** and **ENERGY STATES**, in the material world, too, including the entire biological environment. Such different types of UFOs used only tritium as their "fuel" when taking off, placed in the same medium, and moved only in the Atmosphere gratings (in the medium), which had to

be built on the basis of k-structures. ***In a different grating construction, they could not move.***

MAIN STORAGEES of the imported tritium were placed in large fresh water contents (mainly in lakes) and dosed into the Atmosphere gratings, ensuring the level of its required state. Tritium, which is in an unbound state in sea water (the Hydrophone layer of the Atmosphere), played a completely different role, but for a sea-based **UFO** was applied. Sea Water tritium was used in large quantities, in particular, by the Control Complex located along the eastern coast of the United States and Canada (the Bermuda Complex of the Interventional System). Its delivery was carried out with the help of the **CONTROLLABLE OCEAN STREAM** (current), which oceanologists called **the Gulf Stream**. This ocean current was ***finally liquidated in 2011 in order to localize the actions of the Bermuda Complex*** with its further elimination.



In addition to this, the Earth, with its entire energy capability, was also a unique by its power and **UNIVERSALITY GENERATING** source of energy. It was "forced" to provide its energy resources of the generating complex states, providing the transfer of the energies of individual octaves for the operation of various Intervent Complexes on the Moon, the Sun, and partly on the imported satellites of the Planets. In order to transfer a large volume of such generated energies and to organize communication with its "forced consumers", a special Atmosphere Construction was also required, **CAPABLE** of **MAKING** the Earth generate energy, accumulate it and at the command promptly "transfer" it. And also take its return part back in the modified constructive state and distribute it among the Intervent Complexes and Objects located on the Earth.

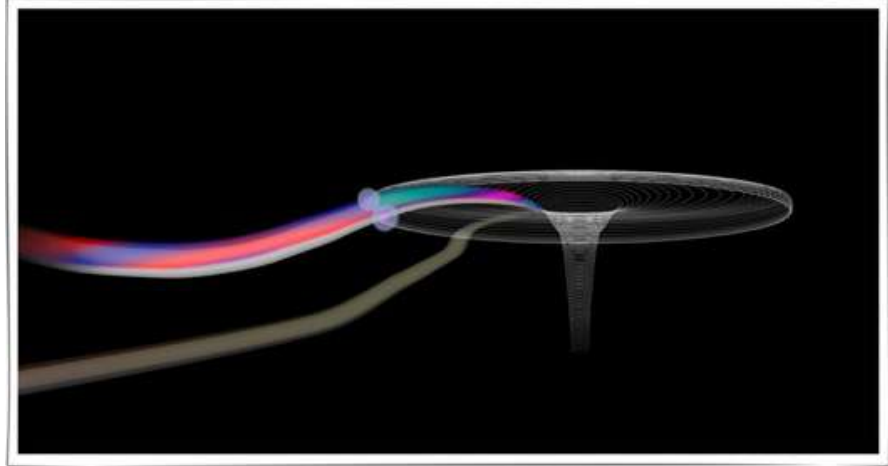

The knowledge of this was, in my opinion, the forerunner in creating **the Generator of "complementary" Energies** (I mean the Generator that was "handed over" to **N. Levashov** in France) transferred to the North-West of Russia by those who saw far ahead and the forerunner of the created by N. Levashov **"SvetL" Generator**. The functioning of the "Crown of the Sun" as the Atmosphere of this Planet, was, to a greater extent, due to the transferred energy from the Earth (in 54 octave). And the energy partially returned from the Sun (in the octave 54.25-54.35 + the mantissa, as the radiation octave) provides, among other things, "illumination" of our Planet, again with the help of the gratings Construction of the changed Atmosphere. This is not a complete list of the imposed functions that were executed with the help of the supplemented Atmosphere Construction.

I'd like to note that the northern lights are a phenomenon of the physical process, connected with the above-mentioned transfer of energies. More precisely, this is the process of afterburning of "surplus energies", previously annually for eight months specially accumulated, but left after the completion of the process of sending to "consumers" (through the **Ural Control Complex**). To store such volumes and in such conditions of energy in the Atmosphere gratings for longer time was impossible, and was not foreseen by the Interventionist System. Therefore, they had to be "burned" as **UNREALIZED SURPLUS**. So irrationally was the energy generating power of the Earth used. This is the true essence of the physical annual phenomenon (in the past), fascinating picture – "Northern Lights!" This is **NOT** the **ONLY** example of the irrational "management" on the part of the interventionists in the application of the Earth's energy potential, connected with the peculiarities of the imposed Atmosphere gratings.



In general, this complicated process of substituting the entire Construction of the Atmosphere's energy gratings in their true state for a foreign one (imposed) was **PRINCIPALLY IMPORTANT** for the Ebr System. Exactly through such changes that other habitat conditions were arranged that were necessary and suitable, first of all, for themselves, and subsequently for all those who they were able to adaptively materialize, including the people **THEY NEEDED** in the period after almost **COMPLETE ANNIHILATION** of all living things on the Earth.

It should be noted that the Interventionist System needed people in the **UNIQUE IMAGE** and surprisingly perfect Brain design, out of which it would be possible to create exactly what would be suitable and acceptable for themselves (the Interventionist Ebr System) and their further program objectives. Moreover, the Brain of the Control System, created in their own design, as a necessary set of governing their imported Complexes, Objects built on invaded territories by the Systems, the arranged communication between them, located in the **layer -4400 ÷ -2200 m**, – **ALLOWED** them **TO SERVICE** and attend only such state of the Control of the organized energies being, which the interventionists had imposed under their Programmed goals and intentions.

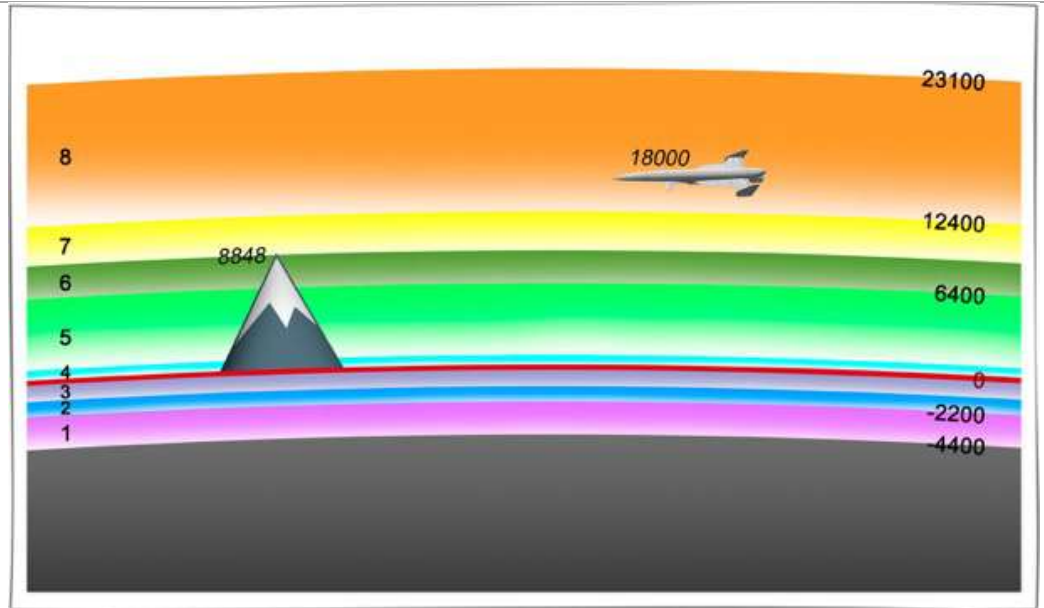

This condition and the state of the entire Control System, especially in the processes of energies being, including the development of the entire biological environment, **PREDETERMINED PUTTING** people's executive functions under the state of the imposed **MATERIAL (consumer goods) APPLICATION**. This state of material application of people attached the entire process of development their Mind **STRONGLY RESTRICTED** and isolated from the truth level and direction, dosing the information process of knowledge in relation to **ONLY INTERVENTIONISTS** general programs: *"Energy informational development of the Brain Genotype and the Development of the energy biogenesis of the flesh."* In that way the development of all the programmed processes of the imposed Interventionists Civilization was arranged and implemented, dividing its single chronoprocess at certain stages of the event-driven time.

All communication with the entire control filling for the external contact (satellites of the planets, the Moon, the Sun) was carried out in the model scale of the Earth, but only for the purposes of the Interventional System functioning, and only for its programmed development. Any other development process had been **VIOLENTLY SUPPRESSED**, and everything had been strictly controlled. For a number of reasons related to the unwilling preservation of a number of functions of the former (Interventionist) Brain Control System in order to ensure smooth adaptation in the transition of energies being to the new state, some of the **LIMITED**

INFORMATION is provided here, with the main emphasis on the functional purpose of the layered Construction of Energy Gratings. The information of the table partially demonstrates what kind of layered structure the Interventionist Atmosphere Construction has turned out.

The main layers of the atmosphere and the changes taking place in them as the elimination of the consequences of the intervention

1	-4400 M -2200 M	The Atmosphere Brain communication grating, location of the Atmospheres Brain	128 octave
<p>In this layer there were placed all the Complexes and Objects of the Interventionist System, as well as its Energy “Cords” and the voluminous structures of the energy interaction of the Complexes and Objects. Besides the Control Complex Alps 2, which will be removed after completion of the reconstruction in the 0 ÷ 1200 m layer, and Ural, which will be removed after the completion of “the Black Sea operations”, all the rest are already completely neutralized with the liquidation of their Programs, and the Objects themselves are put in dead storage. Most of them are liquidated (earthquakes).</p>		<p>The speed of the signal is equal to the "speed of light". The layer is completely blocked against the activity of Interventionist Objects and Complexes.</p>	
2	-2200 M 0 M	The hydrophone layer	88 octave
<p>The Atmosphere Control System was simultaneously located here.</p>			
3	-1280 M 0 M		88 octave
<p>The layer of water 1280 m thick was “thrown” down to make The “Flood”. There is only one type of grating in this layer but the water properties are different. The layer is to be liquidated during the transition period. and water surplus is to be energetically destroyed and the energy will be thrown into the Space (tornado, and so on)</p>			
4	0 M 1200 M	Base layer	63 octave
<p>In the layer there were conditions for the existence of biostructures materialized by the interventionists. For today: 33% P, 33% GP k-structures and 66% P, 45% GP in Di-structures. From 2011.01.07: 11% P, 11% GP k-structures and 100% P, 122% GP in Di-structures. Since 2010.12.30 the Program "Elimination of robots" and most of the materialized biostructures has begun.</p>		<p>P is the density of the electric potential charge, GP is the gravitational potential density of the charge, Os (187) is ready for elimination.</p>	
5	1200 M 6400 M	The accumulation layer	65 octave

<p>Main functions:</p> <ul style="list-style-type: none"> - the main layer of tritium treatment. All material structures of water are formed in this layer; - the layer (was) for the frequency of channels to transfer humanoids (for individuals 4xx of the Brain Genotype and other biostructures); - in the layer there are frequencies of the tritium bond with the oxidizer (structures that have the ability to bind only tritium), called oxygen. <p>For binding and water formation only O₂₁ is used. The latter comes from the Earth, it is created by decomposition of lithium (its reserves are completely concentrated in the desert);</p> <ul style="list-style-type: none"> - a grating with frequencies filtering signals is formed in the layer; (only certain frequencies are let to pass, it is an isolating medium for others); - the control of tritium accumulation. At its concentration above 122% it is destroyed to 0% by the formation of lightning. Ozone – the disintegration of not burnt tritium. For 2010.12.30 the content of tritium in the layer is 11%, which corresponds to 4-5 meters of snow. Lithium is made by the Sun, regulation is in the channels of the layer (Complex Ural). The content of lithium can not exceed the content of tritium. The receipt of O₂₁ from March 21 until December 21. The formation of water and snow is regulated by temperature; - the layer has a reference frequency of 65 octave , all humanoids 4xx came into the layer. Today there are no more humanoids in the layer, they are all thrown into the Space through the channel. Reincarnation, as the Interventionist Program, is eliminated forever! - the layer has the entire range of frequencies from 15 to 128 octave. Since 2010.12.30 there have been 33% P and 33% GP k-structures plus 88% P and 88% GP Di-structures in the layer; 	<p>The maximum wind speed is 127 m / s (457 km / h).</p>			
<table border="1" style="width: 100%; border-collapse: collapse;"> <tr> <td style="width: 20%; text-align: center;">6</td> <td style="width: 40%; text-align: center;">6400 M 8800 M</td> <td style="width: 40%;"></td> </tr> </table>	6	6400 M 8800 M		<p>61 octave</p>
6	6400 M 8800 M			
<p>- The reference frequency of the 61 octave layer (used for the Program Performance Control by all the individuals of the 4xx genotype of the Brain);</p>	<p>The maximum wind speed is 224 m/s (806.4 km/h). The whole system of Humanoid communication in this layer</p>			

<p>- has structures (garlands), providing work in octaves 21 ÷ 77. The remaining octaves have channels of passage through the layer; - All robots 4xx had a reference frequency (<i>when making biostructures</i>) of 61 octave. If it is removed, the robots will disappear (<i>annihilation of the flesh of the body</i>); - the layer was the main one for storing all kinds of insect humanoids (including those that were created before 0 year). By 2010.12.30 all humanoid insects had been thrown into Cosmos, 45% of structures in the layer have 0% P and -123.99% GP k-structures. The layer has 12 types of structures for the organization of broadband communication;</p>		<p>is completely eliminated. The process of complete stripping for the information contact with the “Konactors” individuals.</p>	
7	8800 M 12400 M	The layer of materialization	
<p>In this layer materialization of UFOs took place after their ascent through the "Lifting Tubes". <i>Their liquidation since 2010.12.31 during the transition period is final.</i></p>			
8	12400 M 23100 M	Atmosphere protection layer	Up to 512 octave
<p>Formation of "anti-gravity", the re-creation of the former "Protection"</p>			
9	23100 M 62400 M	Special Information	Up to 512 octave
<p>Formation of anti-gravity", the re-creation of the former "Protection"</p>			
10	62400 M 127600 M	Special Information	Up to 512 octave
<p>Formation of a new state of protective layers from external influences</p>			
11	127600 M 450000 M	Special Information	Up to 512 octave
<p>Formation of a new state of protective layers from external influences</p>			
12	450000 M 1284000 M	Special Information	Up to 512 octave
<p>Formation of a new state of protective layers from external influences</p>			

The functional features imposed upon the main layers of the Atmosphere can be briefly expressed as follows, without adhering to a consistent hierarchy in terms of their significance.

In the construction of a special Construction of the energy gratings of the Base layer No. 4 (0÷1200 m), all energy frequencies within the range of 12 to 224 octaves are applied, the harmonious Controlled being of which and the process of Control of such energy being together are an integral part of the basic formation that are defined as controlled **"Habitat conditions"** for **ALL** biological **STRUCTURES**, materialized by the Interventionist System, including people.

The habitat conditions for the biological sphere is a process of integrated Control of all elements of life, including executive actions, at whatever level they are incarnated (including rabbits, the density of reproduction of which were so diligently engaged many scientists in their studies).

Despite the fact that this sounds somewhat pathetic, and this should be emphasized, as if it were, from positions that are superficially based on religious dogmas, but really **"everything and all thoughts and deeds are performed in Heaven."** Within the framework of precisely these **ARTIFICIALLY IMPOSED CONDIDIONS** for the life existence, which we observe nowadays, the entire Control of the biological existence in general had been put in, and precisely from this layer of the Atmosphere, that is, through it and with its help. **"SvetL" Programs** in matters of recovery and "interaction" with the Brain are also "working" within this layer of the Atmosphere. But this is only in matters of "recovery".

Here they are, the "Heavens", specially equipped by the Creator. This is **NOT** the **ONLY**, but an influential part of the general set of elements of life support on the Earth, as such. Therefore, to the "Habitat Conditions" as the process of Control, there are also complementary but not less important elements, the functions of which are partially invested in other Atmosphere layers and even beyond, as providing and attending ones, including communication with the Moon, the Sun and the Planets satellites. All this should be referred to the **Programs "SvetL"**. It could not be otherwise, because the Generator, created by **N. Levashov**, is "inscribed" in all these partially covered processes. And **IT GOES WITHOUT SAYING** as far as **the Generator of "complementing" Energies** is concerned. Now the physics of the process is supposed to be objectively understandable.³¹

Such are the providing functions of the imposed life-support on the Earth, which are partially endowed with other layers of the Atmosphere, namely:

- governing their harmonious states through Complexes and Objects, including the Control of material and non-material states of the gas layer;

³¹ Physics (from ansient.-Greek Φύσις) – Nature.

- providing the carrier medium of energy-information translation to make governable the vital activity of living cells and their performance of strictly differentiated functions;
- providing the Programmed executive actions or realization of the individual functional allotment of each biological individual;
- energy support of their functional organized existence, all kinds and ways of reproduction;
- the functioning of the Brain;
- providing passage corridors for **α -**, **γ -** and **β -photons**, as an integral attendance of biological life and much more.

All this is associated in a single concept, which is positioned as the Controlled "Environmental Conditions".

If you carefully "get at the deep meaning" of "**SvetL**" Programs, then this is, in a way, **PERSONAL CORRECTION** of the environmental conditions, and basically – the life support system of a specific Person (the User of "**SvetL**" Programs). Thus, the Habitat Conditions and Conditions of the controlled environment are **NOT** the **SAME** as they are often confused in the current scientific and secular circles, and specially "**SvetL**" Programs. I will not detail their operation and application in relation to the owners in this aspect, since this is a highly specialized issue, which is **RATHER SIGNIFICANT**, because there have been all sorts of attempts of aggressive intent and even technical interference in these processes. They were unsuccessful, but they brought **SOME TROUBLE** mainly to those who, out of curiosity and selfishness, decided to "make experiments" with the Programs, absolutely **INCOMPREHENDING** neither the physics of the process, nor, especially, their purpose for the environment (the environment of their own life-support). But it's about **the Programs**. And as for the Atmosphere layers nowadays there are quite enough consequences of the "exploratory inquisitive activity" of insane professionals from the territory of Alaska, blindly generating technical and energy impacts of an aggressive destructive nature on the Atmosphere layers. By the way, it does not remain without consequences over the territory of North America. So let them "try" for others, but nature will also "reward" them!

It is necessary to note a very important circumstance – the state of the current natural Habitat and Conditions of the controlled environment are subject to a very **ACTIVE RESTORATION PROCESS** and **UNAVOIDABLE LIQUIDATION** of all those consequences that are connected with the past Interventionist distortion of the true Construction

of the Atmosphere grating with respect to **layer No. 4**. With all this, no common administrative, scientific, religious, as well as any individual decisions and opinions on the part of people are not taken into account, no matter how "important and meaningful in terms of their acceptance" they are.



It is important to understand that changing the natural habitat and the conditions of a controlled environment entails the necessity of changing the entire Structure of the organized people's being by means of the **ELIMINATION** of the **OLD ONE** and the **INTRODUCTION** of the **NEW** Construction. This is also inevitable because of the constructive changes in the Control and attendance of energy being in general, as well as all other consequences and changes out of the ongoing processes of the complete restoration of **Layer No. 4**. It does not depend on the opinions and any decisions of administrative structures from staff of the present dominating level, *especially in matters of preservation the present world order*. The time of eventful processes of people's being earlier defined by the imposed basics of "the benefits and satisfaction of the personal interests of an insignificant minority on the basis of violence and parasitism over the prevailing majority" **HAS BEEN OVER** and is **NO** longer **ATTENDED** by the new Control System. "Time of Reason" has come. And this is a completely different basis, first of all, for the formation of the **NEW WORLD UNDERSTANDING**.

4.8. The approach

The present Atmosphere layer (**No. 4**), with all its complex functional allotment, not only provided the **BIOLOGICAL BEING** of **PEOPLE**, but also served as the basis for the translational support for getting all the information of the cognitive and governing character provided by the System as an objective necessity for their comprehension of the objective surrounding reality. Consequently, this layer by this most functional governable presence in a program-defined degree influenced the formation of a **STEP-BY-STEP DEVELOPING** individual and public Consciousness as the basis for all subsequent programmed executive actions of people.

In what way, then, does layer 4 participate in such a complex process as the formation of Consciousness as such one? This layer is a **supercluster system** of the local-target Control for the formation of the **SPECIFIED PROGRAMMED** habitat **CONDITIONS**. It combined a number of some functions, namely:

- receiving and retaining information in a stable, indestructible state for a certain period;
- target orientation for the further identified translation for people;
- recycling of the worked out information;
- making an information structure from elemental components to a more complex one, and much more.

BASIC ENERGY OCTAVE for the construction of this layer grating **is octave 63**. It was the base octave of the Human Brain Control for **the entire group of individuals with 4XX Genotype of the Brain**. Simultaneously, it was within the limits of the frequencies of the same energies octave that a certain significant part of the **so-called external Control System** on the side of the Control Complexes and objects occurred that affected the activity of most non-reductive³² functions of the Human Brain. In addition, **TWO STATES** of the Human brains, namely, **the antineutrino and neutrino**, are structurally arranged so that the basic basis for such an arrangement of energy gratings in the constructions of these brain states is the same **octave 63** with its identified mantissas, which ensure the possibility of not destroying the format of the information received in the same octave. In this there is nothing accidental. The

³² Not weakening, constantly necessary for existence.

availability of these three very important basic circumstances provided, in the main, the complex process of the entire Control of the people's being, including the formation of the Consciousness. All these proceeded in harmony with the tact of event-driven time within the framework of the general chronoprocess as the formation of a kind of ***energy-information cluster module with a temporary stability for a certain moment*** (in the sphere of the antineutrino state of the Brain).

The formation of such an individual or collective peculiar cluster information and control module on the basis of the acquired information of cognitive and executive character as the Governing start for all further executive actions of individuals or groups of them is the **ESSENCE** of the **CONSCIOUSNESS FORMATION**, both individual and social. Subsequently, it is from this constructive state of the Brain that all further Control of the executive actions of the individual through his proton (material) part of the Brain is translated. The physical action of this is realized in the form of energy-biochemical processes in his environment and in the medium of the **OPERATING FLESH CELLS**. The last phase, or stage, with the help of technical means and various control methods, is observed by many researchers who are keen on the problems of the Brain functioning with different aims. Thus, in that part of the Brain that can be accessible to people for their "exploratory and experimental actions" (proton, that is, the material state) – **CONSCIOUSNESS IS NOT FORMED**, but ***only its directed resulting form of influence by the individual for subsequent executive processes and actions is realized.***

But the process of the general energy-information translation on the side of the Control Complexes and Objects **IS NOT** that only "miracle-working" that formerly formed the people's consciousness. There was also a need for communication, as a complementing information accompanying programmed fragment, but who with and what with? The Control Complexes and the Objects carried only the executive function, and the Programs of the conceptual level **WERE NOT ABLE** to form. In order to ensure the reception of the information of the programmed nature from some information sources of a **HIGHER LEVEL** of governing from outside, a specific layer of the Atmosphere was formed. Such functions were endowed with the **Atmosphere layer №6**. Briefly about it..

Separate multileveled functional value had the layer of the Atmosphere Contacts **No.6, 6400 ÷ 8800 m.**, in which the Interventionist System formed ***12 main types of its imposed contacts***, namely:

№	Purpose of the systemic contact functions	Liquidated	Will be liquidated
1	Contacts of all individuals of 4xx genotypes of the Brain with the Moon. (Placement on the Moon of the program "Development of genotypes of the brain" and its translation for CC to the Earth).	2010.12.30	
2	Contacts of individuals 441, 442 of the Brain genotype with the Sun (Placement on the Sun of the program "Energybiogenesis of the flesh", its translation to the Earth via CC, the subsequent functional allocation of individuals taking into account the genotypes and their geographical location).	2010.12.30	
3	Contacts of individuals of 4xx genotypes of the Brain and the satellites of the planets (some fragments of the Control Program "Development of the energybiogenesis of the flesh", including, in particular, the matter of the societies formation).	2010.12.29	
4	Contacts with the Moon: Translation of all kinds of loads for all biostructures (programmed correction of functions, reproduction, elimination, including diseases, performance of "album" records).	2011.01.02 (Start)	Until April 2013
5	Contacts with the Moon: Specialized target forms of the Programmed information for 4xx genotypes of the Brain. Governing the executive actions within the current Vector of Target, phenomena, actions and events. Introduction of "Album Records" for performers with 4XX genotype of the Brain (since 2005).	2011.01.01 (Start)	2012.04.24
6	Contacts with the Moon: The Programmed target information for Complexes and Objects. (Formation of strategies for common Programs, Vectors of Target within the framework of the Chronoprocess, translation of the Programs for the formation and Control of the Civilization development).	Until 2007	

7	Contacts with the Sun: Specifying the rate of metabolic processes for all biostructures and the tact of event-driven time (1,0007 sec.)	since 2011.01.02	to the end of 2013
8	Contacts with the satellites of the planets: Delivery of tritium from satellites (change of its energy states, storage, distribution and accounting of consumption).	Until 2007	
9	Contacts with the satellites of the planets: Loads for all individuals of the 4x genotype of the Brain (astrology, i.e. its program correction "in the image and likeness", preparation for the subsequent application for the reconstruction of the Brain and its replacement with the Interventionist Brain in functions).	Until 2007	
10	Cotacts with the satellites of the planets: Receiving frequencies potentials on 18 imported basic energies octaves. (Constructional arrangement of the Control, correction of the Programs for Systems and Control Complexes).	April 2007r.	
11	Technical connection with all developed Interventionist systems on the Earth, located above and below the layer. (Energy gratings to ensure the operation of all types of technical communications used by people)	since 2011.12.31	Until the end of 2014.
12	Technical connection for moving all kinds of objects in this layer (movement in the layer, i.e. moving within the layer gratings of all types of UFOs, aircraft, rockets, probes, etc.).	since 2010.12.31 (for UFOs) since 2011.02.20 (for the aircraft)	UFO – until the end of 2012; For the rest, for 3-4 years

The connection of individuals of **4xx (421, 422, 423, 441, 442 and 461)** of the Brain genotypes with the Moon and the satellites of the planets (functions 1 and 3 in the Table), and also for individuals of **441 and 442** of the Brain genotype with the Sun (function 2) were the most important component, out of the whole complex set of the formed Interventionist **"Conditions for the controlled environment"**. They are no less significant as well as inalienable as the main ones, since **WITHOUT THEM**, the very existence and attending Control of all the imposed

processes under the conditions of another life on the Earth taken by the interventionists – just **COULD NOT HAVE BEEN** possible at all, since the true ones had been annihilated. When considering the above mentioned connection, in comprehending its essence, one should not invest only an accepted simplified understanding of it as it is understood by all kinds of current and developed by people **TECHNICAL COMMUNICATION** for everyday life as a complex of organizational and technological measures and actions to transfer, receive and process their information . The connection of all **individuals of 4XX genotypes** of the Brain with the Moon, the Sun and the planets satellites is **IMMEASURABLY DEEPER, MORE COMPLICATED**.

What was provided with the help of such communication, and how much was it functionally important in the overall development of the imposed Civilization and the formation of Consciousness, in particular? First of all, it should be noted that such an interventional connection, but already in the energy gratings of a cubic structure (k-structure), **HAD NOT DIFFERED** in its stencil constancy of its states for the entire occurrence of the event-driven time **(18,000 years)**. It had a progressive **DEVELOPING CHARACTER** of its perfection, dictated by the overall program harmony of the whole process of its own development within the framework of the imposed Interventionist Civilization. Strictly in harmony with the imported tact of event-driven time, there had been a **CONSTANT** process of **COMPLICATING** not only the essence itself, but also some kind of "technical perfection" of the entire System of the Controlled being of the brought in energies octaves. Even the very construction of information, as it is, had been perfected and brought to the imposed version of a digital basis. People have taken it as the transition to the digital basis of their technological excellence. ***But it is to be liquidated soon.***

There had been a gradual process of achieving harmony of such being of energies, education and perfection of the imposed Interventionist Mind, **STEP-BY-STEP RIG** under the ideal likeness of supposedly "True Civilization of the Earth" and so on. This, as the highest end in itself, had been primarily pursued by the Interventionist System. For without such an artificially created "likeness to the supposedly Civilization of the Earth", the very stay and all efforts to seize the Earth would have been in vain. They (the interventionists) would not have realized their **STRATEGIC GOAL – PENETRATION in the artificially created by them image of the "illusory similarity of the Earth's Civilization"** to the General Hierarchy of the development of Civilizations for the Planets, possessing

living conditions of the Intelligent orientation. A simple penetration into the structure of such a Hierarchy of the planets **WAS IMPOSSIBLE** for them, since they would have been **LIQUIDATED** immediately by a more powerful and perfect "impact from outside." Independently, i.e. without the capture of the Earth and the subsequent illusory civilizational image of similarity, like the *System of Planets of a different destiny*, they were **COMPLETELY ISOLATED** from such a form of perfect development of their own Civilization with the subsequent possible penetration of the whole chain of similar planetary formations into the General Hierarchy of Civilizations in general.

Of course, this is beyond any Hollywood fantasies on the theme of "Star Wars", but in reality it is incommensurably higher than any limits of scale opportunities and abilities of such imaginations by the Brain of people. Especially under the conditions of their being in the **INTERVINED MATERIAL** application. Most of the informational inaccessibility for people, both in cognition, and in comprehending the truth about everything that has been happening, was **ORGANIZED AND ARRANGED ARTIFICIALLY** in such an illusory manner as if *everything had been happening in a natural way*.

Moreover, the Interventionist System, on the whole, possessed an insufficient level of development and "technically laid-out perfection", in contrast to the Planets, possessing and endowed with the conditions of life of the Intelligent orientation.

I have already mentioned in detail that the Earth, being a complex strictly identified planetary monocluster, had all the necessary set of energy-technological complex state (*independent*), but Ebr Interventionist system did not have such a concentrated governing "completeness" on any of its delivered Planets. The interventionists just needed such a Planet as the Earth, also because it was a single interplanetary cluster complex for its development for all the forthcoming *eight stages of civilization development*, and they could create for themselves conditions for their **PROGRAMMED EXISTENCE**. Therefore, the Interventionist blow was **INFLECTED** against the **WHOLE** Model complex. But after this seizure, the **GENERALPROCESS** of self-arrangement began, and not only on the Earth. Therefore, the entire connection, which was re-arranged and formed by the Interventionist System in this layer of the Earth's Atmosphere (No. 6), had a **SPECIAL STRATEGIC CHARACTER**, and its functions, especially of support (through communication) the imposed Habitat and the controlled

environment, were of **PRINCIPAL SIGNIFICANCE**, not only for the primary materialization of people and governing their executive actions in the Program framework, but for the implementation of all strategic objectives of the intervention in general.

4.9. Biological sphere

LIQUIDATION OF THE CONCEQUENCES of the intervention itself is very complex and subtle, but it is basically the **SYSTEM LEVEL** processes, without involving people in it.

In the future, we are going to confine ourselves only to the framework of the formed connection of the Atmosphere layers that were organized to attend the Habitat, the Controlled Environment, and only in the part that directly relates to the biological sphere, including the being of people, as well as the Control of their executive actions in the Programmed processes of development of the **EMPOSED CIVILIZATION** with their violent involvement in all these processes. Everything that concerns Programmed Governing development Processes conditionally called "nature", i.e. Flora, fauna and so on, it is, in itself, **NOT LESS** meaningful, complicated, but also necessary for the existence of people and their cognition of the natural environment in future, if people get aware of living in the future.

Partially I showed the importance of the Programmed connection with the Sun, the Moon and the satellites of the planets, not only on the technical side, but also on its role in the general **PROCESS** of **DEVELOPMENT** of people's **CIVILIZATION** and the Consciousness development, both the individual one and the public, in particular.

First and foremost, it was through this connection that the **COERCIVE HOLDING** of people's executive actions in the state of their material use over all Programmed processes controlled by the Interventionist System had been **PREDERMINED**. And accordingly, this resulted in the step-by-step preventive development of the individual and public consciousness before every historical eventual executive step.

The formation of consciousness was carried out by the practical provision of all the necessary information of a "strategic and current" nature, which for a long or short period were translated to Complexes, Objects and ***the formed Control Systems***. The latter, in turn, through the energy-information translation from themselves, governed i.e. determined all

subsequent conditions of execution and the necessary commands related to the construction, development, functions and the arrangement of the energy-informational translation for people and their Brain development for a long period of their **ALLEGEDLY "NATURAL" PERFECTION**. It was through such Program directions, like commands, that the process of people's development that were materialized by the Interventionist System took place.

This, to a certain extent, is sufficient to understand the importance of the Atmosphere layer 6 itself and the imposed connections through it with the Moon, the Sun, and the planet's satellites. If you look at the history through the accomplished actions and events, then, indeed, there is a **CONFIDENT IMPRESSION** of a sort of the organized sequence of development. People have an unquestionable confidence in the "naturalness" of the historical development of the perfection of their life arrangement. The history of civilization can be expressed in eight words: ***the more you know, the more you can.*** But I 'd like to add here that ***the less you know, the more you believe. Faith without knowledge is dead.***

Chapter 5. Deliberate knowledge of the unknown

Learning without thinking is useless, but thinking without learning is dangerous.

We are inclined to think that human knowledge is progressive, because the more we live the more we learn. Thus it should follow that our grandfathers **KNEW LESS** than we do, and great-grandfathers **EVEN LESS. Another theory is also plausible.** Perhaps, at different times we learn things from different sides and in different ways, and this throws new light on all the mythology that we are now using everywhere? Myths are not dead; we just understand and use them in another way. Much of what we do not understand, we try to turn into "myths", **because we want to believe more and learn less.** I am satisfied that for many Users of "SvetL" **Programs** the interaction of the Consciousness and the material world in cognition no longer seems to be fantastic. **The consciousness is energy in its subtlest and most dynamic form.** This helps to understand **why our fantasies, mental images, desires and fears** influence the real events, and explains how the image created by the Brain materializes. You just have to **LEARN** to **THINK**, too Modern scientists, for example, **THINK DEEP** instead of **THINKING CLEARLY.** To think clearly, you need to have sound mind, but you can think deep and be completely crazy. **But this is strictly my opinion!**

5.1. Wanted Necessity

Ask yourself the question – what is that subtle event-driven all-embracing harmony that gripped all the peoples of the Planet, what strict observance of the event-driven tact in the stage-by-stage process of development, how could all this be perceived by people? As if a truly **SEQUENTIAL DEVELOPMENT** took place, including the development of the Cognition itself! Who **CONTROLLED ALL THIS? Some historical figures?** How did it come that people with a gradually changing interest in cognition perceive the surroundings with surprising impermanence? But it was exactly at the appointed event-driven time that they turned their

inquisitive eye to some **SPECIFIC FRAGMENT** of the **UNKNOWN**, "examined" it, and finally "received an element of supposedly more perfect knowledge" as another step in their world view development? Why then for thousands of years was it to torment people? Might it have been better to learn everything at once and immediately, that is, much earlier? But who opposed or controlled this process?

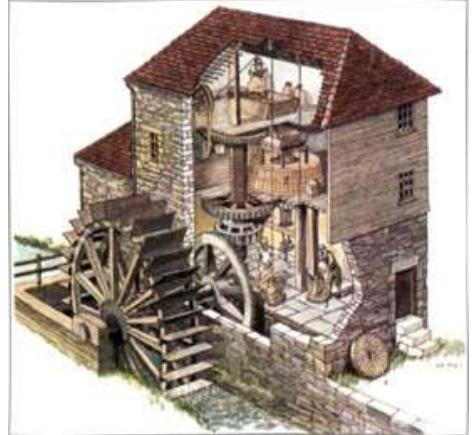

Before the expedient time, no one invented or created anything, was not able to surprise with any extraordinary discovery of the World. **Everything was done, discovered, invented and applied strictly with the tact of the programmed requirements for the general Civilization development of people.** Simultaneously, that was also an important part of the Target Vector of the **FUTURE PHENOMENA**, actions and events in that part that somehow related to the Civilization development with the usage of people. Not their development, but the development with their usage.

Was there any element of randomness in this stability? Of course, there was **NOT ANY RANDOM**. This was the way the entire communication system of the Atmosphere **layer No 6** worked and manifested itself, realizing two strategic programs: **"Development of the Brain Genotypes" and "Development of the Energy Biogenesis of the Flesh"**. And they thought and ate, and were geographically settled, and socially equipped, and almost all obediently took everything for "naturalness" of the surrounding habitat, and **worshipfully**³³ accepted **DEFICIENCY OF WILL** and **VIOLENCE** towards themselves, etc.. Everything only in line with the Program, including the very formation of Consciousness in all its forms of life manifestation. Skeptics may object to it by demonstrating, as evidence, some fragments of deviation from the generally prevalent level of event **processes, rebellion or disobedience on the part of SOME INDIVIDUALS** or groups of them. After all, there were plenty of them in the history of many countries. How should one perceive the assertion of some kind of controllability from the outside, imminent **obedience** in action and resignation to one's fate, i.e. some kind

³³ Obediently.

of control program? Skepticism, especially with the demonstration of separately extracted historical facts, is possible, but the scale of the individual and the corresponding scale of his (skeptic) judgments depends on the **SCALE** of his own **CONSCIOUSNESS**. As soon as all the historical processes of any research are brought to the all-planetary scale of judgments, then, at once some randomly formed fragments of history become **INSIGNIFICANT**, and they can be neglected.

But let us return to the contacts with the Moon and the Sun touched upon in the previous chapters. It is necessary to answer many questions, of which, as I see, there are plenty. The communication was with the Complexes located on the Sun, the Moon and the planets satellites. They were carried out, as already mentioned, through the "Communication Tubes", operating on certain energies frequencies, including gravitational communication and interaction on a permanent basis (according to the design of the energy gratings – similar to **Shukhov television tower** in Moscow). But they were made active for their application only with a **CERTAIN PROGRAMMED** periodicity, depending on the level of urgency and the importance of information transmission, adhering to the strict tact of the event-driven time. Incidentally, it is not only in a certain way, but **ESSENTIALLY INFLUENCED** the peculiarities of the process itself and certain time expressiveness of the organized people's being, taking into account:



- their geographical and other differences;
- a certain iteration in carrying out various mass historically important events;
- observance of certain traditions, holidays and some other rituals that form a certain way of life for the people of some current historical stage.

An insignificant example is a spiritual ritual "**Epiphany**", **Epiphany water**, etc. It was on January 19 that **THE PROGRAM**, determining the energy-informational complex state of water, **WAS PREEMPTED** for a whole year from the Moon complexes at a strictly

certain time. And here – with the corresponding full subsequent correction of all its states. To be more precise, the anticipatory changes in water occurred in the period from **October 21 to January 18 each year, and on January 19**, programmed information was transmitted from the outside about its state for the whole year. Annual correction of the energy information state of water directly predetermined **SOME PROGRAM PECULIARITIES** concerning the Program "*Development of the Energy Biogenesis of the Flesh*".



For the whole year, the specific features of the metabolic processes of a living cell with the integral active participation of water in all its states or for all people on the planet or for certain groups of them differing by geographic or some other feature were determined. The geographical settlement of people in certain areas, very seriously affects their state, for example, their health. And especially it is noticeable, when people move over long distances today. For example, with a change of residence "*SvetL*" **Programs** in these processes are a significant help, but they, to admit it honestly, can **NOT ALWAYS** solve the required problem concerning the user's moving, I want to emphasize, over long distances, changing continents, for example. But I am going to talk about it later.

And now back to water – how and in what way does the state of water affect the entire flesh of the human body? In what way is the harmony of the energy states of the flesh cells with the states of water achieved? All this is a true **WONDER-WORKING MISTERY** that must be known to the true essence and taken into account in people's being! Each geographically different territory, and, accordingly, each group of people settled on it, need "**THEIR**" **SPECIFIC WATER**. It is very important today. Those who like

to drink bottled water – I do not recommend doing it. Horns, of course, will not grow, but you **WILL** exactly **NOT BE TAKEN to the Bath**.

On the other hand, *through the correction of the energy-information state of water, the certain program changes were laid*, which were necessary under the program the "**Development of the Genotypes of the Brain**" These are even more complex processes which were involved in the fragments of a certain predetermined selection and potential activation of the future executive work of such individuals with specific genotypes of the Brain, who were to be involved in some general or particular actions or events throughout the whole coming year. "**SvetL Programs**" also "provide" for "**DEFINED FRAMES OF CHANGES**", which are now needed by the Brain, and the flesh cells. These Programs are "short-termed" and personal, for a particular User, or more precisely, his Brain. That's why the recommendations on "structuring" the water with the help of Complexes and "Bracelets" were worked out and given to the Uses. But I'll tell you all about it in detail later.

Strangely enough for a layman, but in such processes, **NO DECISIONS**, opinions and wills of leaders of any level or representatives from the social sciences were **REQUIRED** and not requested. But for reaching a specific feature of Consciousness (mainly social) for a particular period, this energy-informational state of water influenced in a significant way. In the scientific and secular circles there has been an unanswered question up to now: "*In what way and what kind of changes took place in the states of water every year*". Strangely enough, this change in water causes **tritium in all the diversity** of its energy states! *Why do we need water for biostructures in general and, what does tritium have to do with it* (especially from the table of Mendeleyev himself)?

5.2. Tritium, the Bath and the unknown ...

So what is this Tritium? Let's take the publication – "The Great Russian Encyclopedia" Vol. 5, p. 168. «**Tritium** ^3H is a radioactive hyper-heavy radionuclide of hydrogen with a mass number 3. The half-life period is 12.35 years. Under ordinary conditions, tritium is gas, $t_m = -252.520^\circ\text{C}$. In combination with oxygen, tritium forms hyper-heavy water of T_3O . The

isotope indicator is part of the thermonuclear fuel. Today, thermonuclear reactions can be carried out only with the explosion of hydrogen bombs.

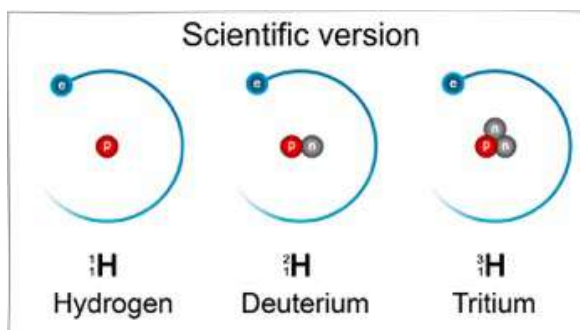

It is accepted to think that tritium *is an isotope of hydrogen*. Let's look at the table.

Name	Number of gravitational layers	Number of electronic layers	Number of outer gratings	Starting magnetic pulse
Hydrogen	2	-	1	-
Deuterium	3	2	2	1
Tritium	8	36	8	36

Modern science has an idea of any chemical element in terms of the gravitational layer presence. ***If potentials of the layer are set to nil, the element does not exist.***

Tritium: the filling of more than 2 electronic layers with the simultaneous relieving of potentials from gravitational gratings converts tritium into **NON-INERTIAL MASS** with the possibility of subsequent use as fuel. All the radiation octaves are included in the electronic layers. The outer (gravitational) grating is of **32.62546258** octave, the following is of **53.66**. If its potentials are relieved then tritium burning differs from the burning of hydrogen and deuterium. The beta-minus decay is caused by the decay of the outer gravitational grating and has no relation to the electronic layers.

Deuterium: the zeroing of the tritium grating transforms it into a stable state with regard to the outer environment, with the minimum number of electron gratings being **2**, and, so that it does not spontaneously ignite, there are **3** outer gratings (octaves 53.66, 51.66, 32.62546258). The outer grating determines the **LIQUID STATE** of deuterium.

Hydrogen: the presence of only gravitational layers and the radiation grating (32.62546258 octave) **DOES NOT ALLOW** using hydrogen as fuel (for thermonuclear synthesis), since there are no electronic layers, and the

outer contours of the gravitational gratings are taken for the running electron and the jumping proton (which can be weighed).

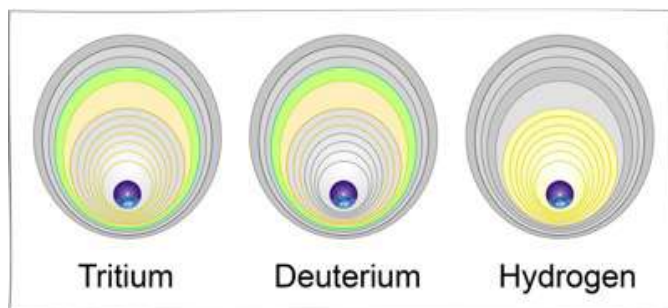

Thus, the **BASIC ELEMENT** is **TRITIUM**, and deuterium and hydrogen are its isotopes. **Hydrogen can not be converted to a state of non-inertial mass.** I note that **ALL 3 ELEMENTS** is **ONE ELEMENT** with different properties, depending on the state of the gratings.

The number of tritium isotopes = $2^{44}-1$ or **17,592,186,044,415**, one of them is hydrogen. Out of this variety it was necessary to have only 2 isotopes for objects (UFOs), 15 isotopes for movement in the Space and **only 1 isotope** for the water formation. The use of other isotopes for the water formation is excluded because of the incompatibility of the frequency limits.

Tritium exists in the liquid state at a temperature below - 253°C. The solid state is unknown. Tritium was fuel for all types of objects (UFOs). Liquid tritium was used, expenditures (for those who are interested) are listed in the table of objects (UFO). Tritium reserves are **NOT INFINITE**, no nature creates it.

To create tritium, there were **SPECIAL INSTALLATIONS** (Generators – Complex objects), which produced tritium with its subsequent dissolution in water, and therefore, all objects (UFOs) were **LOCATED NEAR** reservoirs. Any object (UFO) was able to process water and separate tritium in the amount necessary for the Program implementation.

While spending tritium, its reserves were replenished by generators. This maintained a permanent working state of all objects (UFOs) on the Earth. I am drawing your attention to the fact that all the planets satellites in the Solar System have their own reserves of tritium. Many satellites serve as tritium warehouses, the reserves of which make it possible to travel anywhere.

The minimum norm of tritium in water is **0.00000064%**. When the tritium content is **less than 22%** of this value, the generators start making tritium. If tritium is completely removed from the water, its specific weight

is 0.77 g/cm³. Today, "modern science" **DOES NOT KNOW** the actual structure of tritium and its properties. In its pure form, tritium can be separated **ONLY** by the **GENERATOR** of the Complex object.

What is now taken for tritium is a cubic grating framing a structure containing octaves up to 96. Actually, the grating itself has a gravitational basis, therefore the content can be weighed; that is, the weight and, accordingly, the content of the grating itself in the water are determined. The contents have a **NON-INERTIAL MASS** and can not be weighed. Tritium outer grating has an octave of **32.62546258**. **Deuterium and hydrogen** have similar grating and you have already make sure of it.

Tritium radioactivity is determined by the grating of **53 octave** (2nd electron layer). The norm for this layer is **2%**. The structures inside the grating are **dodecahedral-icosahedral formations** containing octaves **from 53 to 96 inclusive**. Due to what then does water get the necessary density, and what is added to the bond with oxygen? Upon contact with the structure of tritium, oxygen receives an additional gravitational atom, that is, gets "heavier", with breaking the bonds this property disappears. Therefore, it is believed that tritium in water is of hundredths of a percent. However, ***tritium takes up almost one-third of the space in the structure and changes physio-chemical properties of oxygen in the bond.***

5.3. Why do biostructures need water?

Water is necessary for biostructures only in order to **DERIVE HIGH-OCTAVE COMPOUNDS** ("living water"). Here, the brain receives all the necessary frequencies reserve (non-inertial mass) **and uses it for its vital functions**. It is important that, despite differences in genotypes, water **"SUITS" EVERYONE**. ***Everyone gets out of the water those frequencies on which exactly his brain works.*** A man is not able to live without water for more than 3-5 days, he must constantly **HAVE** some **REPLENISHMENT** of tritium structures. Sea water also contains tritium, but in it there are no frequencies that the Brain needs.

Water, purified from a part of the non-inertial mass, is thrown away out of the body in the form of urine and sweat. By the way, by the difference (***initial water – urine***) urine analysis can show the Brain structure. In it there are those frequencies that the Brain **DOES NOT USE** (promising

diagnostics). That's why "recommendations" (regarding water "from the tap") were given **to all users of "SvetL" Programs**, "to structure" water by the Complexes and drink it as much as possible. The effectiveness of such use is already **UNDOUBTFUL**.

The Kailas Complex regularly (every Tuesday) checks the Brain for compliance. There just "put a mask" on the incoming code (the effects of masking the code are a separate topic). The operation takes **microseconds, and for 4 hours the entire population of the Earth is tested**. Every year a standard of water ("Epiphany water") was set in accordance with the Brain, which it was primarily intended for. So, if the Brain received a new (higher) octave, then in tritium this octave had a maximum of potentials, and the potentials of the remaining octaves were reduced to an effective minimum. Outwardly, the water looked the same (it could, for example, change the color to green), but basically it had new frequencies. It happened each time when starting a new program. A **100 years old water**, and the water that was available before January **2015**, **SIGNIFICANTLY DIFFERED** in the structure of non-inertial mass. **In January 2015, this process was changed**. But this is another story that you can get to know by reading the materials of the **Research Institute of CPS (the Centre of Preventive Strategies)**.

To those who are interested in archeology. If you drill a well in Antarctica and stumble across an "ancient underground lake", keep in mind that the structure of the **NON-INERTIONAL** mass of that water is the same as on the surface, since the common grating on the Earth is unified.

What is **"dead water"**? This water has **ONLY GRAVITATIONAL FREQUENCIES** of tritium. If the brain receives such water, it is forced to spend its **OWN RESERVES** to throw such a "gift" out of the body. In critical situations, such reserves may not exist, and then water becomes a poison. **On throwing away urine and sweat, the cubic grating remains**. Then what is tritium for the objects? The Space grating structure is dodecahedral-icosahedral with zero potential, framed with a cubic structure **of neutrinos and antineutrinos**. When moving in space, the object (UFO), having magnetic frequencies and electrical potentials, had to give them out saturating the grating of the Space. However, it is possible to give out something **that is in the same structure**, otherwise the change in the angle of phasing³⁴ will just lead to heat death. Any object (UFO)

³⁴ Conversion to another type of grating.

moving independently in the Space has to have either a **magnetolectric generator** to generate tritium, or tritium reserves **with octaves up to 96** (the higher the octave, the lower the flow). The Space **DOES NOT NEED** gravitational octaves; they are left in the object (UFO). The effect of friction is more noticeable, the farther apart types of gratings are. (When skating on the asphalt in skates designed for ice skating, you will not go far.) The same is true in the Space. **Receiving and giving gratings have to be identical**. But it's all in the Space, everything you need there could be carried inside the Moon, for example. But while moving, a cone of motion is formed, into which tritium is discharged.

Why did the objects (UFOs) need tritium on the Earth? Only for lifting from the main power bus of the Earth and return. The depth of location of UFO objects **reached 4200 meters**. Modern builders use a powerful machinery for laying tunnels. **One object (UFO) was able to dig a tunnel deep to 4200 meters , while its only tool was tritium**.

The lifting and landing Complex after the "rise" or "return" commands from the point of location and to the surface of the Earth created an **ANTI-GRAVITATIONAL TUBE**, that is, removed potentials from the cubic grating all along the entire length of lifting or landing of the object (UFO). This was **NOT** done **SIMULTANEOUSLY**, but in sections (**usually 200-300 meters**). Since all the materials (Mendeleev's table) have a cubic grating or close to it, there was no problem to remove an electric potential and magnetic pulse. The rest was done by the object (UFO). Any element in its structure has the same Space grating (dodecahedral-icosahedral), but this grating has no potentials (they are =zero). If you start saturation, the chemical element begins to change properties (**out of granite, for example, you can get platinum, and this is not a joke**). However, if the saturation exceeds a certain limit, then the **ENTIRE STRUCTURE** gets the **PROPERTIES OF THE NON-INERTIAL MASS** (similar to the cavity of a working neon tube). Through this cavity a ball lightning – object (UFO) slipped. When the next site was reached, the passed section was transferred to its original state. It was precisely for the formation of a section with a non-inertial mass that tritium was necessary. Deuterium is not suitable here, because the gratings are incompatible, and instead of a non-inertial mass they could get a burn of unknown nature. When entering the surface of the Earth, an atmospheric grating was used for motion, and the flow of tritium was minimal (tens of thousands of times less than for lifting and landing).

Why does it **NOT HAPPEN** an explosion (of a hydrogen bomb)? Each object has its **OWN GENERATOR** of thermonuclear synthesis, working on the principle of a village stove – the more the damper is opened, the more powerful is the ejection of potentials. By the way – this is one of the conditions for the functioning of **OUR BATH**, where many of you have already begun to strive for.

I note that the simplest thermonuclear reaction you can get at home if you throw a piece of **Na³⁵ into water** or on wet soil. Not only is it burning, it might also explode. In seawater, there is no burning or explosion, but a smell of sulfur appears.



Of course, luckier were the objects of sea basing. They moved in their native environment, the formation of traffic tubes required minimal tritium consumption. They **WERE ABLE TO FILL UP THE STOCK** while moving (the description from Baron Munchhausen – about the horse that cannot slake its thirst, because it does not have the second half).

Where does tritium come from? As noted, the Space grating has a certain structure. To move through this structure, it is necessary either to scatter electric potentials around and supply them with magnetic impulses, or create a cone of motion. The height of the cone is billions of kilometers. For navigation, planets' satellites are used (motion calculation, cone formation, orbit correction). Tritium is dumped only in the cone of motion, and therefore there have to be its reserves. However, all the Solar System planets have complexes of pyramids, and some of them are intended for

³⁵ Sodium is an element of the first group (according to the old classification – the main subgroup of the first group), the third period of the periodic table of chemical elements of DI Mendeleev with atomic number 11.

processing Space debris. Those debris, first of all, are neutralized by bonding with the oxidizer (beautiful high-altitude clouds), then frequencies are added for shaping, and we receive drops of water. You must not drink such water (you can water the plants, but the plants begin to pull the potentials of the atmosphere grating intensively).

To give water the necessary qualities, there are special Generators, whose functions include **SATURATION OF TRITIUM** with all the necessary frequencies, after which the oxygen-bond structure **IS USED** by **EVERYONE and EVERYTHING**: people, animals, insects, plants, objects. For tritium formation the following complexes were brought and set up:

- **the base complex** – the control system for magnetic, electric and gravitational pyramids;
- **the basic complex** – the control of working complexes;
- **the working complex** –the accumulator, control, working emission.

All the complexes are serviced by "robots", which were **SPECIALLY CREATED**. The control of all the processes, formation of orders is carried out only by that who *has 96 octave of the Brain* (including all life-support octaves). In addition, it has as many matrices as it is necessary for the execution of the Program.

	Name of the center	Location	Number of magnetic pyramids	Number of electric pyramids	Number of gravitational Pyramids
1	Base complex	Chekhov, Russia	252	156	56
2	Basic complex	Suez, Egypt	446	121	33
3	Working complex 01	Gabon, Africa	211	327	21
4	Working complex 02	Kenya, Africa	121	211	27
5	Working complex 03	Kalimantan, Indonesia	334	623	43
6	Working complex 04	Nauru, Pacific Ocean	523	273	61
7	Working complex 05	Ecuador, South America	336	433	12
8	Working complex 06	Brazil, South America	338	211	23

9	Working complex 07	Tyumen, Russia	232	734	242
10	Working complex 08	Altai, China (Chinese Wall)	451	523	161
11	Working complex 09	Solomon islands	226	832	281
12	Working complex 10	Switzerland, Europe	128	243	31
13	Working complex 11	Kailas, Tibet	621	817	341
14	Working complex 12	The Kola Peninsula	134	111	17

The result for those wishing to get to the Bath:

1. Tritium is the most unknown element on the Earth.

By changing only gravitational gratings one can obtain **256 different stable chemical elements**. By varying the potentials of the gravitational gratings within the tolerance range (from 2 to 124%), we **OBTAIN ISOTOPES** possessing the properties of alpha-beta and gamma decays. By adding at least one electronic layer, we also obtain a chemical element emitting photons, for example, phosphorus or actinium (face-centered cubic grating, luminescent spontaneous beta decay).

2. Tritium in the Space **DOES NOT HAVE** potentials on gravitational and electronic gratings. In addition, there are no outer control gratings.

3. Each electronic tritium grating has a dodecahedral-icosahedral structure. The addition to the outer contour of the cubic structure does not lead to changes in the inner structure.

4. Combinations of outer cubic gratings (not nested in each other) lead to the formation of various outer forms (such as triclinic and others).

5. Any chemical element can be converted into a state of non-inertial mass by removing potentials from the outer gravitational grating. This is an important point for understanding the "work" of "SvetL" Generator.

6. The standard of tritium in the water structure **is set once a year by Greenland Complex**.

7. Significant changes in the structure of water occur **from October 21 to January 18** (taking into account the annual changes that have occurred), here with the peak of mortality occurring in November, and still **NO** changes **ARE EXPECTED** yet.

8. Water obtained by processing Cosmic tritium, consistently passes saturation with the necessary octaves before it reaches the Earth.

9. Water cycle in nature can be **OBTAINED ONLY** in a saucepan or in a bath, that is, in a confined space. In our Bath all this is "foreseen", but the cycle is **NOT NEEDED**.

10. Water evaporation from water basins does not lead to the formation of precipitation or at least fog. These formations lack a significant number of octaves, which are formed by generators in the upper atmosphere, so the resulting vapor is simply dissipated, and the rain is a **CONSEQUENCE** of the **INTENSIVE WORK** of the Generators. Moreover, when there is overheating of the main bus, it has to be cooled, and vapor in the form of dense fog envelops entire areas. It is true, here, **DO NOT WORK** computers, somehow, but few people pay attention to it.



11. Since a chemical element without a gravitational mass **DOES NOT EXIST** (can not be seen, touched, and, more so, sold), science, in every possible way, avoids it.

5.4. "Bright" future

I shall touch upon a certain "bright" future, first of all, in relation to the current and subsequent changes in the energy-informational states of water. I have already mentioned that, starting with **2012.04.24** (the change of the Control System), **NO MORE** tritium has been **DELIVERED** to the Earth from the planets' satellites. Its volume with a decreasing tendency is kept due to the insufficient generation with the help of Generating objects imported and located in certain places of the Planet by the Interventionists System.

But then – what about people? ***Are they doomed to death because of this in the near future?*** It's hard to write like that, but – yes, they are **DOOMED** to the **IMPOSSIBILITY** of their existence in general, **UNLESS THERE ARE** changes towards a **SIGNIFICANT INCREASE in the octave of their Brains!** This is one of the mysteries of the whole essence, related to the recreation of Man! About "**SvetL**" Program I can only say that this is a chance. You will come to this understanding, attentively reading the book to the end.

If a Man is recreated to the previous state of the Brain by raising it to ***at least the octave level of $96 \div 124$*** (and the present one is maximum of **64 octave** for single individuals), then the necessity for the compulsory presence of tritium in water (in all its necessary energy states) falls off. The Human Brain will be able to ***energy replenishment from the energy gratings of the Di-structure of the environment.*** In this case, people need water only to support **SECONDARY** vital **FUNCTIONS** of the flesh cells (creation of the "native type" of tritium for the true drinking water will be made in another way). But this is only possible for the people who are defined as being directly integrated into future. But what about the conditionally integrated group of people (**adaptation through $3 \div 5$ generations**), how do they survive? This issue, which can not be solved through saving water with tritium, acquires a **SPECIFIC STRATEGIC VALUE**, and **ANOTHER SOLUTION** is provided for this and that is not in the public information version. I can only say openly that "**SvetL**" **Programs** are of direct importance in this process today. And this is one of their basic functions. We discussed it with Levashov, and initially everything was "done" within the framework of reincarnation of the Entity, which was eliminated once and forever as the Interventionist Program. **Since 2012, NEW PROGRAMS** have been created that are adapted to today's realities in this matter.

There is no doubt that in the near future there will be many talented researchers who will be able to cover this highly-specialized issue from the true positions and with more detail. And today some try to "get down" to this, but there is not much knowledge so far.

Water is **NOT THE ONLY** sacrament that was realized through the communication channels formed in **layer 6** of the Atmosphere. Let's return to the question of Consciousness, touched on in the previous chapter. In what way exactly did this communication, arranged in the Atmospheric layer

No. 6, determine the most important states of individual and social Consciousness that are apophatic for people?

How could it suddenly change or deviate from its steady state? How was the Control process carried out? Why was such a huge variety of states of Consciousness manifested not only in the scale of the Planet, but even on the territories of specifically expressed States with the same geographical and climatic conditions of being and so on? The variety of questions of this nature is simply unlimited by its quantity. Those are the questions that until now **NEITHER social science, NOR psychology, NOR theology, NOR any other specialists of other scientific directions ARE ABLE to answer, just as they are not able to give an answer and, in fact, understanding of what TRUE CONSCIOUSNESS is.** The fact is that most of the answers can not be found without the **COGNITION** of the very **ESSENCE** of the created programmed communication for people in the Atmosphere gratings of layer **No. 6** (communication type No.s 1, 2, 3).

5.5. The Essence ...

All programmed orientation directly for the development of the genotypes of the Brain was completely controlled through the CC (Caucasus, Alps and California), and the medium for transferring information was constructed **in the gratings of layer No. 6** with additional participation in layer **No. 1**, where the Brain of the Control System is located (a little later about it). Only such a finely controlled harmony with strict interaction and observance of the differentiated functions of layers **No. 1** and **No. 6** (communication type No.s 1, 2 and 3)³⁶ allowed the Interventionist System to implement a complex process, including:

- programmed development of people's Brain;
- formation of their Consciousness at each specific stage of the general event chronoprocess;
- using groups of people in carrying out specific program activities;
- direct "purposeful" participation in the development of the entire **IMPOSED** Interventionist Civilization.

³⁶ A.M. Khatybov – "Principles of Governing".

I will not go into detail, and there is no need, describing the subtlety, the current essence and the peculiarities of the social Consciousness state for the individual social formations of each geographically different territorial dispensation, since the revisionist re-examine of the entire "written history" today is likely of no interest for us. But, nevertheless, I am going to touch upon some important historical fragments, since we are to cross over it, in accordance with the logic of understanding.

The communication with the Moon, the Sun, and the planets' satellites was **NOT DIRECT** (or a group of them), because the Brain of people was not able to possess such complex (in terms of power and function) abilities, as receiving and then subsequent decoding and application of information .

All specific program information related to the Control of the development of the whole biological sphere in general was received by **Control Complex (CC) Kailas-1, 2**, and all the planets communication control was carried out by the Control System of the planets located under the territory of Ethiopia. Communication with the planets' satellites, receiving and transmitting information, providing communication tubes, coordinating time, monitoring the movement of the solar system and other operational functions – all these were assigned to this Control System (CS). After reception of the information from the Moon, the Sun and the planets' satellites, its decoding and, depending on the purpose, functional orientation, urgency, sequence of execution (and other factors), **CC Kailas FORMED** and **TRANSMITTED** the information (as governing) to the **CC Caucasus, Alps and California**, as well as to other Complexes and Control Systems, if their actions required any correction or participation, including correction of environmental conditions suitable for people existence or governing their actions in specific conditions and states of the environment.

This malty-leveled process formed and provided the bulk of the most complex System for the translation of energy-information **GOVERNING SUPPORT** of people's development. This excluded any mutual translational interference, distortion, provided a ***strict address information identification***, up to bringing it to specific individuals or the appointed society from them, in particular. Not everything was smooth and perfect, there were some failures.



A very **IMPORTANT INDICATOR** of the consequences of this fact of insignificant distortion and failure is the *manifestation over the past two decades of a great number of people of non-traditional sexual orientation, i.e. so-called "blue and lesbian" in the world society.*

This kind of sexual "mutation" occurred, because on the side of the true Earth Control System, *since 1995, an active process of eliminating part of the basic programs* of the former Interventional Control has been under way. As a result of the interference in one of them, previously conducted by the **Kailas-1 Complex** programmed systematic correction of the Brain functions for 4XX individuals of the Brain genotype began to make **ERRORS** in the **TACT** of this complex process development, related to the **REMOVAL** of the **NEUTRINO** state of the Brain of **SOME INDIVIDUALS** in a certain regularity with subsequent checking, correction and its return. As a result of this tact errors, many males were *imposed upon the function of "feminine attraction to reproduction" and vice versa.* It was done without any control but with identification.



By the way, it was noted that the males, who received the functions of "feminine attraction to reproduction", acquired similar to women **"lunar" tact of changing metabolic processes** ("critical days"). **These failures were previously observed but they were not of a mass nature and had an inner pathology in the Brain functions of the individual.** This is an insignificant example of the importance and peculiarities of the communication types of **No.s 1, 2 and 3**, but also as the fact that much has changed the society of people and their being. However, those kinds of "individuals" were created purposefully, too, to ensure the solution of specific tasks in the governing people and processes in the historical perspective. **N. Levashov** wrote about these "individuals" in more detail. The fact is that in such "individuals the hypophysis is **INCREASED** three or four times compared to an ordinary man. And this makes them good executors and easily governable. Here one could write a lot on this issue, but I **WILL NOT**, considering it worthless. One thing I'd like to note that **St. Valentine day**, imposed on us and our youth is a confirmation of the fact **that this "action" was supposed to involve as many people as possible.**

The imposed structures of energy gratings on the basis of **k-structures**, introduced by the Interventionist System as basic ones, predetermined the manifestation of certain consequent limitations and complications in the governing process itself in many spheres at all stages of the Civilization development. They displayed themselves in various degrees of mentally frenetic "ecstasy" through everyday existence of people – from serene indifference and massive deathly depression (plague in Europe) to

bestial fanaticism (civil war in Russia, Stalinism, fascism in Germany, an insane passion for profit through violence on the part of individuals from the territory of the USA and England, etc.).

Out of the whole complex of such difficulties, I will only touch on the problematic limitation, which was **NOT** only **EXPLAINED**, but also **NOT ALLOWED** until the collapse of the Interventionist Civilization. This is an unconditional commitment in the "pyramidal" construction of irreversibly increasing violence in the governing of the entire mode of life and being of people. It would seem, at first glance, how and in what way, could this problem have to do with the formation of Consciousness both public and individual, and, in this case, the Atmosphere layers, as well? But before going on with the coverage of this issue, it is necessary to be defined about the constructional peculiarity and functional **dispensation of the Atmosphere layer No1.**

5.6. Specificity

In this (the first) Atmosphere layer the ***Brain Communication grating of the Control System and the Brain of the Control System itself are located.***

If we consider this layer from the point of view of the technical complexity of its arrangement and the scope of all technological concentration to ensure the necessary program energy-information translation as part of the cluster control system, then it occupies a **LEADING PLACE among the other layers.** But if the significance is determined from the point of view of its place in the general hierarchy of the integrated functional dispensation of all the Atmosphere layers in general, then the leading positions of this layer lose somewhat in the scales (in comparison with the other Atmosphere layers), because this layer is essentially significant mainly for secondary derivative processes of the control and attendance of the whole biosphere being. If this layer is considered only within the framework of the problems of the governing organized being of people, then it **IS** the **PRINCIPAL** element of the cluster control system of all **EXECUTIVE ACTIONS** of people, including the implementation of the strategic programs of the Interventional System: ***"Development of the Genotypes of the Brain" and "Development of the Energy Biogenesis of the Flesh Cell"***.

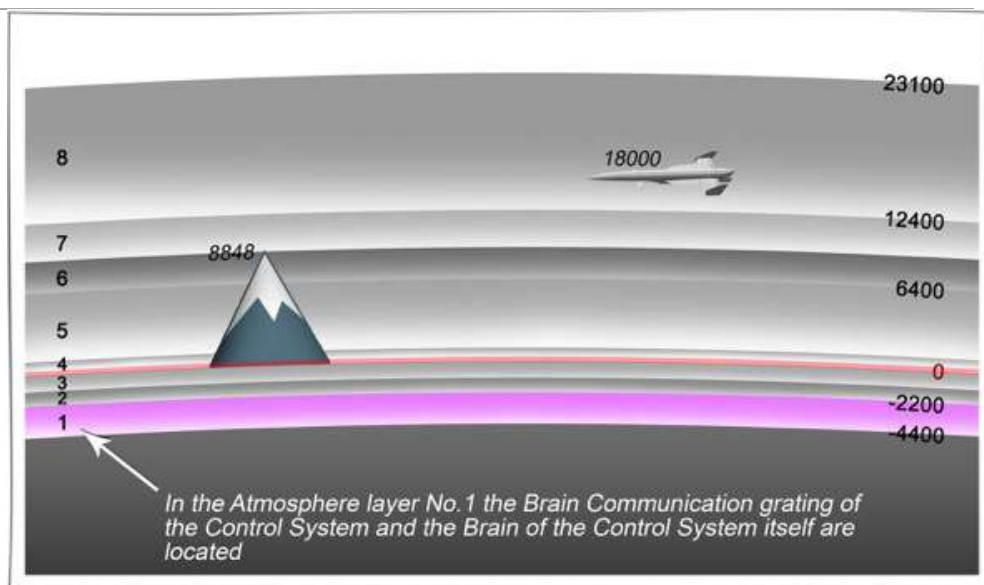

Before talking about the influence of this Atmosphere on the formation of people's Consciousness I'd like to remind you that in the previous chapters there was information on how **the Control System Brain was arranged** through a reconstructive interference of the Interventionist System. Here I will show the way it was presented in **a general constructive arrangement, namely:**

- Basic Control Systems (26 CS);
- Emergency Control Systems (32 ECS);
- Formation of "weapons" (48 SFW);
- CS Automation;
- Solar and Lunar Complexes;
- Main and Auxiliary Control Complexes;
- Objects (there were all types of objects and UFOs, 7909 units.);
- Control Systems;
- nodes ("rotations", superpositions, "stores", life support Systems);
- **Energy "Cords"** and volumetric structures of energy interaction of Complexes and Objects.

The Target orientation to the functioning of the Control System Brain was aimed at:

- the formation of constructive harmony between the imported elements of the energy grating construction (K-structures in the range from 15 to 128 octaves) and previously laid **NATURAL** model **COMPLEX** of energy gratings (Di-structures within octave of 12 to 512);

- Ensuring the harmony of the combined energies being to create **ILLUSION** of **CIVILIZATIONAL DEVELOPMENT**, that made it possible to hide artificially imposed harmony in place of the previous programmed nature endowed with the Earth at its formation;
- creation of **THEIR OWN HABITAT** and the **CONTROLLED ENVIRONMENT**, suitable for an acceptable **TEMPORARY LIFE EXISTENCE of all the created and imported substances (including biological ones)**;
- development of the imposed Mind of the captive Planet and the mind of the people of their own creation, brought into the obedient state of **their material goods usage** to provide the illusion of the development of the Civilization of the **INTELLIGENT ORIENTATION**, but for their own programmed aims;
- the program code to the processes **"Development of the genotypes of the Brain" and "Development of the energy biogenesis of the flesh cell"** in the interests of introducing a significant correction in the Human Brain structure commensurate with the interventionist **BRAIN LIKENESS** of different functional level (**spiders with the stopped evolution of the protein mind**), on the one hand, and dispensing people's flesh cells all living states, which can be provided by their existence under the control of such a Brain, on the other hand, and other less important orientation.

Any ideas of people about the Brain as such have traditionally been associated with biological Entities, comparing its constructive code more often with outer material attributes and parameters, determining the perfection of its functional capabilities by some "bestowed" abilities, characteristic mainly of entities with conscious or instinctive actions and so on. Is such a privileged "rising" in people's own esteem over the nature of themselves to be honored (meaning the Brain of people)? **IT TURNS OUT, IT IS NOT**. As an example of our mistake, I cited in the second chapter the brain of a cockroach, to which this kind of brain is enough to fulfill its functional endowment in a biocontrol system—collecting information on the state of the biological environment. And there are countless examples of this, and not only in the biosphere, but also in the field of flora. It does not matter. It is only important **that the Brain, as a cluster system formation of energies in inertial and non-inertial states, is created for some operations of governing, control, and analysis, and possesses the ability of perfection in certain permissible limits under someone's control of a higher level of formation**. The same can be

attributed to **the Generator of "SvetL" Complex**, which was also created as a systemic formation of energies, but only in a **NON-INERTIAL STATE** and possessing, most important, the **PROPERTIES** of **SELF-PERFECTION**, but, as it became clear from the practice of application, within the Brain System Control in direct interaction with the Owner's Brain. For example, such especially distinctive signs of the Human Brain as **vision, speech, hearing, smell and another achieved "perfection"**, are available in the Brain Control System, too but in a **MUCH MORE DEVELOPED** and perfect state! In this I was convinced directly when creating **"SvetL" Programs**. All the created **Programs**, so to say, **"have been inspected"**, but not all **"WERE PERMITTED"** for some reason or other. Sometimes I had the feeling that over me there was **"a kind of "Eye"**", which was "sniffing "and" eavesdropping ", as if I was doing something **WRONG** or there was no solution in this or that matter. But when there was a **REAL NEED** in the prompt creation of the **Program** for a specific life-support event, the **"TIP" CAME IMMEDIATELY** in various forms of my understanding – from visual-graphic reproduction of the required solution in the Brain to the appearance of a "running line" (if you can call it this way) on the computer and my automatic repetition of this information in printed matter (almost automatically alphabetical display).

And when there was a need for interaction with the Generator transferred to Russia, the required solution began to manifest itself in a visual graphic manner, which made it possible to display all this in the entire splendor, for understanding, or at least for a real vision of the processes at a simple and accessible level. The same can be attributed to the work of the **Vyborg periphery of the Urals Complex**, the "start" of which was marked by the so-called "Chelyabinsk meteorite".

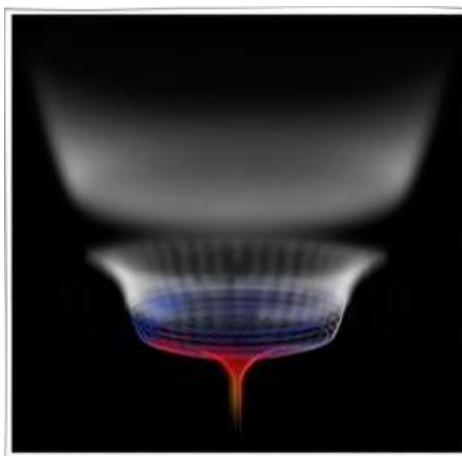

5.7. Pyramidality

Studies of the detailed past constructive and functional capabilities and features of the Interventionist Brain Control System is a separate fundamental direction of science of the near future. At the moment, **NOT THIS** is the principal goal in understanding oncoming events. I will only take a superficial account of these features, and we will specify its factorial and functional elemental presence, which significantly influences our past being within the framework of the Interventional Control.

We will consider only those elements of the Brain of the Interventional Control System, which, **directly** through the control processes, were **INFLUENTIALLY CONNECTED** with the targeted use of people in the development of the Civilization imposed upon them, and thus the formation of their individual and public Consciousness, in particular.

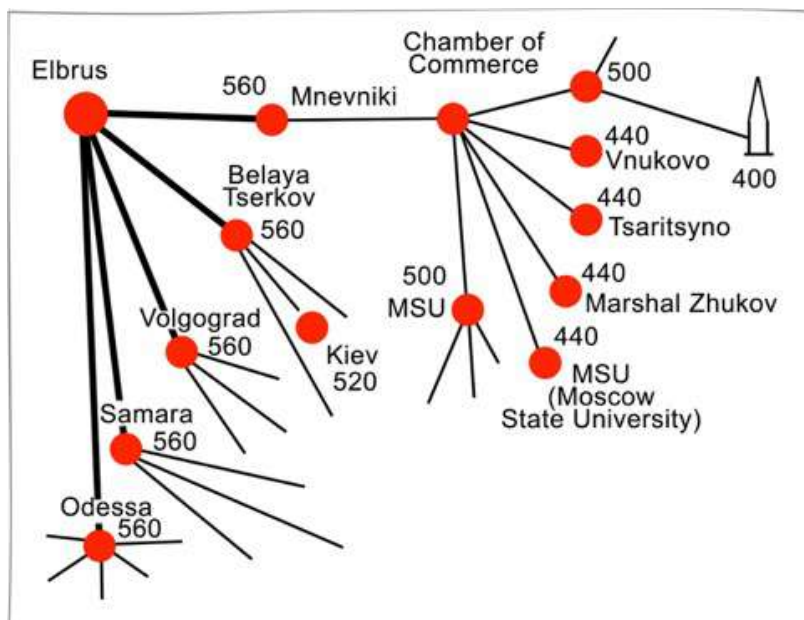

The above graphical linkage of information energy translation demonstrates the **SEQUENTIAL DIAGRAM** of the **energy downlink interaction** between the specified objects. By positioning the programmed controllability arranged on the principle from “**the higher to the lower**”, one can show the causal basis for explaining the true essence of the imposed “**pyramidal**” construction as the only “stable design” of the **PEOPLE’S SOCIETY CONTROL** at **ALL STAGES** of their previous existence under the Interventional Control System.

The imposed energy control sequence provided for the following: ***The Control Complex "Elbrus" every Thursday ordered all complexes of type 560 to start accumulating potentials and transfer all accumulated potentials, including control information, to complexes of type 520 (as a telephone distribution node), complexes of the type 500 (energy conversion terminals), complexes 440 (objects, weapons or UFOs), complexes 400 (a node information hub for controlling people's executive activities through churches, Catholic churches, mosques) and control servers.***

It is only a ranked element in the hierarchy of subordination of **DIFFERENT LEVEL OBJECTS**, depending on the imposed on them program function, i.e. their importance in the hierarchy of the Control System. In fact, the picture of the overall governing construction through the Systems, Control Complexes and Objects is much **MORE COMPLICATED** by its **VERSATILITY**. ***The whole construction is really*** pyramidal and in harmony with this design, there was arranged the corresponding pyramidal structure of the **CONTROLLED PEOPLE'S BEING**. The control of people's executive actions was carried out through the energy information translation from the Control Complexes through all types of Objects according to their downward functional importance, bringing the control signals and information to **SPECIFIC INDIVIDUALS** according to the descending hierarchy of **their division by the Brain genotypes (from 461 to 421 genotype)**. In accordance with this pyramidal constructive imposing Control process, in the course of all historical stages of the society development, on the part of the Control System through energy information translation there was imposed and ensured the formation of the corresponding public Consciousness for practical executive actions. This consistent downward translation explains that **BLIND OBEDIENT STATE of the overwhelming majority before an insignificant minority**, humbly taking all forms of violence, including the **IMPOSED PARASITISM** in all its forms.

For each historical stage, the specific programmed state of the public Consciousness was imposed upon, corresponding to the stage and taking into account:

- targeted historical features of each stage of "development";
- the framework of Vectors of Target, actions and events;

- functional-territorial dispensation of societies in a specific geographical area;
- features of the programmed current "recipe" for the selection of society (a set of society in each territory, taking into account the mandatory availability of individuals with a specific genotype of the Brain) and much more.

I have tried to convey all this to lots of reasonable people, in my opinion. However, on their part, it looked like an unreasonable intention, like an **UNVERIFIED NONSENSE** of an indefatigable fantasy. But if we take as an example a fresh historical episode of **the beginning of Perestroika in the USSR**: up to now an **INEXPLICABLE** something that affected like the all-destroying wave all spheres of the tuned up social and spiritual life of the peoples of the Great Country, that possessed unique immunity to survival under the most difficult conditions of the surrounding counteraction, can not be explained from the "materialistic" positions of the worldview: **"In what way and why has the Civilization of Communist type collapsed»?** And that was just an **ORDINARY PROGRAMMED PROCESS** of the Interventional Control System and **NOT MORE** than that. And it was performed with varying degrees of zeal by everyone without any exception. Even individuals ***with especially red party cards*** that had previously possessed the granite fortitude of the communist worldview and the corresponding humane public Consciousness! Where has it gone from the head?

At the moment, we are not going to consider the features of the public Consciousness at each historical stage of "development" in all separately expressed and geographically different societies. With this in mind, historians and social scientists will be able to correct all of their written **HIZTORIA** with **ANOTHER** comprehension of its progress, by bringing it closer to the truth of the Control of people's being. But I have a lot of doubts about it. Perhaps that will happen in some perspective. For me it's just important to demonstrate, on the basis of my knowledge, in what way the model cluster control system for shaping public consciousness was arranged, **including** the Atmosphere ***layer No. 1***. It was **NOT ONLY** governable, but was imposed upon people strictly conforming to the formation of ***certain event processes through their Consciousness*** orienting their executive actions precisely to what that had been defined by the Target Vector of ***phenomena, actions and events***.

When considering the functional and constructive features of the above layers, we were convinced that their **BASE-DETERMINING** influence on the formation of the Mind of people, their individual and public Consciousness is *a very multifaceted process, governed within the framework of the systemic code of the civilization "development" program* and completely independent (apophatic) on people's will and desire. Consequently, it required a **CERTAIN CONTROL** on the part of the same Control System.

5.8. The Control and Atmosphere layers No 2 and 3

In the cluster system formations of the Governing, the control, as a compulsory element and at the same time a reverse control principle, is an **ESSENTIAL CONDITION** for the stability of the closed-loop control. In what way, in which layers of the Atmosphere, was the reverse control formed?

Before talking about control in general, it is necessary to make some framework limitations within which this question will be considered. We have already determined that the Earth itself is a **MODEL COMPLEX** represented by energies *in the inertial (material) and non-inertial (non-material) aggregate states in the range of 12 to 512 energy octave* for the current stage of its civilization development, being the first stage of the endowed Program for its development in general. And the very programmed existence of the Earth is a controlled process, i.e. its existence is embodied through a complex **GUIDED BEING**³⁷ at all levels (octaves) of energies. That means that control should cover the entire complex of the guided processes of energies being and is the subject of separate, profound studies. Here we consider only those processes of the energies being and the corresponding control that are **DIRECTLY CROSSED OVER** with the Governing and control of the organized people's being. For the complete understanding the whole structural complexity of the organized people's being control, influence on the Mind formation, and individual and social Consciousness, we will be helped while considering *the design features of the Atmosphere layer No.s 2 and 3*, which are (according to their particular function) in close connection with the previously considered Atmosphere layer No. 1, where there is the Control System Brain, and, in

³⁷ Not to be confused with Being from the Old Testament

particular, its **120 control Systems from 18 the Earth Control Systems**. What are the structural and functional features of the Atmosphere layers No.s **2 and 3**?

The Atmosphere layers No.s **2 и 3** are located at a level of $-2200 \div 0$ meters. They simultaneously constructively hold the Hydrophone layer ($-2200 \div -1280$) and the Atmosphere Control System layer ($-2200 \div 0$). The location of the Hydrophone layer concerns not only the seas and oceans, but also the continental part. The Control System layer is also located on the entire surface of the **Earth's geoid**. The water layer of 1280 meters thick was "thrown down" in **the process that was described in ancient sources as the "flood"**, but in fact, the Interventionist Control System threw down the **WAIST OUT ENERGIES** from the destroying energy gratings of **Di structure** (the 28th native octave, water octave) in the process of changing the Atmosphere structure.

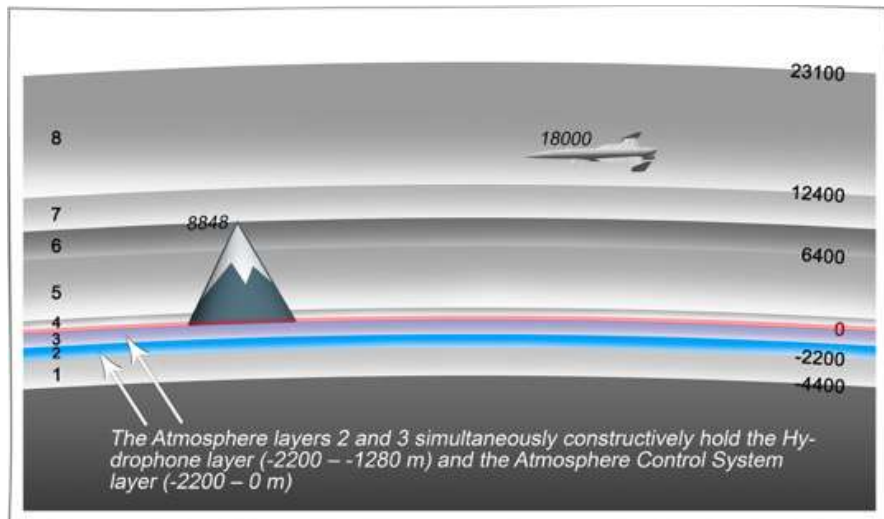

Similar things happened **in 2013-2015** around the world (powerful floods, heavy showers and tsunamis) and especially in the Far East of Russia. **It was "dumping" of the waste energy from the destroying energy gratings in the process of changing and restoring the Atmosphere structure into its pre-Ebr state.** The process **HAS NOT FINISHED** yet and "is being carried out" smoothly, so to say, without much damage to the Life Support System of people and the Planet as a whole. All the weather changes that we have been observing for several years are the consequence of these processes. So the Hydrometeorological Center has nothing to do with it.



The common for the entire planet hydrophone layer (**layer No. 2**), being a functionally specific part of the Atmosphere energy grating, is structured in such a way so as to ensure the exclusion of all **RANDOM MIXING** of different types of water and keep in a steady state the type of water that, according to the functional- territorial dispensation is to be in a specific geographical area. This explains the **DISTINCTLY DIFFERENTIATED** both in salinity and in other features and conditions of sea and ocean waters, the presence of such closed seas with salt water, like the Caspian or Aral Seas, the freshwater Gulf of Finland, strictly separated from the main part of the Baltic Sea, and many other things. The Control for the formation of marine and ocean currents is also carried out through the Atmosphere Hydrophone Layer. The functional endowment of each stream is strictly different, and all kinds of fables about the causal basis of their existence, based on temperature differences across layers and regions, other causes of purely physical nature, is the **ENTIRELY FALSE UNDERSTANDING** of **THE TRUTH** and the significance of their functional endowment in the overall System of the Control the Processes of Energies Being on the Planet. Earlier unexplained examples of non-randomly formed natural processes and phenomena with the controlling participation of the Hydrophone layer No. 2 are sufficient.

In addition, through this atmosphere layer there were carried out:

- processes of transferring control information on a sufficient level of saturation with tritium sea and fresh water;
- providing with tritium as the main energy replenishment, with its targeted "delivery" to the Control Complexes and Objects (there was the Gulf Stream for the CC Bermuda);
- formation of the energy information state of fresh and sea water for a year, and many other things.

Moreover, the Hydrophone **layer No. 2** does not take a passive position in water formation, which is carried out in the other upper layers of the Atmosphere. It is not interested in the yield indicators in the fruit and vegetable production of the average geographical region or the quantitative changes in the herd in the Prairies. But keeping the minimum state of the water level, it **WILL NOTICE** and **INFORMS** of the danger.

What is it all for and exactly this way? What for are those complicated subtleties, and how does it relate to reasoning about individual and social Consciousness? Does not it seem to a man of the world that this is an artificial pulling of the connection between one topic of judgment and another? Unfortunately, for the majority (and this has been recognized) of the townsfolk, whose world view is based on the **SIMPLE** populist **WORLDLY CLAIMS** that "*Moscow is surrounded by Russia*", or all the subtleties of the metabolic processes of the flesh sell *are governed by the successes in business of American McDonald's restaurants, and the Generator and "SvetL" Programs* "have gone" together with N. Levashov, – everything looks **EXACTLY LIKE THIS**. But the truth of the "*World Created*" and *today's realities are absolutely different!*

Very many processes of natural development in the ocean area and the continental part of the territory, which, as if **developed by people** in the interests of their everyday life with a certain degree of satisfaction in their sufficiency and comfort, are taken by people for the development of the "*Natural environment*".

People are so used to their supremacy over their "conquered" nature that to a certain extent they "have lost the sense of proportion", they monotonously bite the "philosophical stone" invented by them and do not remember what they live for and how long their **ALL-DESTROYING AGGRESSIVENESS** is going to be tolerated by this "conquered" Nature. Moreover, most of them are completely **UNINTERESTED**, even at the level of curiosity, whether the forming natural processes are *spontaneous or something governs them*. With what degree of utility for people is the

development of such processes proceeding? People consider themselves to be somewhat unique, and the whole theory of being is built on their uniqueness. One is their unit of measurement, but **THIS IS A MISTAKE**. All systems invented by people are just a sketch. **One plus one equals to two – that is all we have learned**. But one plus one **DOES NOT EQUAL** to two. There are no numbers and no letters at all. We have pinned these labels to somehow simplify our life, make it more understandable; we have made up a scale of measurements to forget about our immeasurability. Despite the lack of such understanding among the majority of people, I am still confident that it is necessary, and exactly today, to open to them some secrets concerning the **PROCESSES** of **NATURAL ARRANGEMENT** of the environment, the governing of which was realized with the participation of the Atmosphere Hydrophone layer No. **2**, too. in a primary or secondary way, affecting the being of common biological environment in general, and in addition, determining the implementation and attendance of the Program **"Development of energy biogenesis of the flesh cell"** of humans; and simultaneously, controlling the organization and execution of event processes in society, and, correspondingly, shaping their public Consciousness. This can not be **UNINTERESTING** for those who, despite everything, picked up the **"big spade of Knowledge"** and started "digging through" with the spade, at least in order to get into the "waiting room" with the prospect of having the **"cherished Bath"**.

This Hydrophone layer is endowed with a great number of control functions and requires an **INDIVIDUAL DEEP RESEARCH**.

Some of these functions, which we will talk about later, were "put" in the **Generator** and in the **Programs** for interacting with the Brain, controlling the ongoing changes in the transformation of the User's Brain, making him healthy and adapted to the rapid changes in the environment. But for now, we will deal with all that relates directly to the provision and attendance of the specific being of people and their participation in execution of the programmed actions and events. To do this, we divide the considering Control and attendance functions assigned to this layer into **symbolic two groups**.

12. Functions of the controlled co-operation in regulating the changing sufficiency in humans in providing them with proteins and minerals of the natural origin from the seas and oceans for their every day life activity under the Program "The development of energy biogenesis of flesh cell".

This function is extremely significant, as it is an important element of the overall **COMPREHENSIVE PROCESS** for creating life-support conditions of the entire bio-environment, including people. Let us consider this control function concerning **ONLY** the **EXISTENCE** of people.

It is well known that proteins and minerals play an important part in the cell life, the natural origin of which, in the required quantity and state of their harmony, are formed in the life-giving and vegetative forms of their existence in the aquatic environment or with the participation of water. The whole process of the "natural" formation of biological Substances from their inception (in the ionic state) to their perfection (in the flesh), maintaining their essential development in the necessary changing state, regulating the quantitative and assortment states, providing migratory controlled movements or retaining in the limited regional isolation (at least with respect to the variety of all fish species) – all this is the **GOVERNING PROCESS** on the part of the Control Complexes and their servers through the energy gratings of the Atmosphere Hydrophone layer (**layer No. 2**). The primary process of approbation in utility and sufficiency for all the necessary proteins and minerals formed in the aquatic environment and on the continental part, ensuring harmony of the metabolic processes of the flesh cell, was **EXPERIMENTED with the Mayan population**. Until now, a wide range of fish stocks of the most popular fish species are kept locally without migrating along the coast of this area of their former settling as one of the simplest secrets of this region and this settlement.

All migratory cyclic movements of fish masses, route "transportation" error-free, timely seasonal "delivery to the areas of consumption," assortment and quantitative regulation – the governing all these processes was carried out by the Control server located under **Mahe island (Seychelles)** in the Indian Ocean. It is for this reason that the migratory "journeys" of many fish species begin from this oceanic zone.



All the secrets of regulation on keeping in the proper "marketable" state for the necessary assortment of fish species (assortment regulation and distribution of the required species according to functional-territorial, i.e., geographical dispensation) were carried out in a concealing way through the **Easter Control Complex (CC Easter)** located under **the Easter island, the Pacific Ocean).**



It was this Complex that, receiving information on the current development, the necessary requirements and the accompanying conditions

for the implementation of the Program "**Development of the energy biogenesis of the flesh cell**" from the Kailas Control Complex, anticipated all the processes of selection control of the "fishery" on the Planet. It was on its part that the program process for the development of certain species of fish was set: in what evaluation condition for protein and minerals it should arrive in the area of its "consumption", what areas it should visit with specific mineral salt "brines" in their specific ionic state in order to give themselves a proper "marketable" condition of their consumed essence, and much more. Its "decisions" the CC Easter passed the Control server of **Mae island** for the governing the migratory transport processes.



Isn't it talented and touching?! What kind of care! This explains some previously unnoticeable casuses. Pacific herring for some "unknown reasons" and strong-willed orders of "party leaders" was supplied in great amount to the western regions of the

great and vast country, and Atlantic herring, the other way round. It would be necessary to take into account the whole "inexpediency" of such an act, taking into account the transportation costs, but this was done exactly that way and **only at a certain period from August 28 to January 19!** And for the rest of the year, the government took special care of the "child hatred" – fish oil. The Party **WAS NOT ABLE** to answer the question on the imposed "expediency" of such an act then, and especially now, because of its absence as such.

Seizing the occasion (and the logic of the proposition), I would like to ask political scientists, "the creators of historical events", an important question: ***on which day did "patriotism" come to an end over the entire post-Soviet space*** and with the help ***of what volitional action of the leaders?*** As a clue here is a leading question: ***when and who issued the decree on abolishing free provision of preschool children's institutions with fish oil?*** The same question concerns the officials with purchased certificates of various degrees and ranks fighting "pseudoscience" with ***all their proletarian hatred, BUT FOR WAGES.*** And what do fish, seafood and public Consciousness have to do with all this? The matter is not in the fish, but in the fact that the **SIGNIFICANT PART** of the Planet population, oriented to satisfying the vital need of their flesh

through the assortment (according to the program of "Energobiogenesis") of **CONSUMABLE PROTEIN** and minerals obtained from seafood, with all the necessary living conditions created for them, form a specific image of their existence in harmony with all the features of the life and social code, their inherent worldview, the corresponding individual and social Conscience. Crabs are **NOT** vitally **IMPORTANT** to metallurgists from the Urals, although being very tasty, and their absence in the ration of metallurgists will not cause any **DECISIVE PROTESTS** among them; which can not be said about the inhabitants of the seaside regions. The matter is not only in this fact. All the niceties in the fact that individuals with different Brain genotypes and different functional roles in the overall process of executive participation in the program **"Development of the energy biogenesis of the flesh cell"** are based on various sources of protein and minerals for the organism according to the strictly differentiated form of their natural origin, both of marine and continental.

For a **LARGER PART** of the **POPULATION**, the formation of conditions for the strategic memory in the body (bones) is realized on the ionic basis of minerals formed in the aquatic environment. In this case, for individuals of each Brain genotype, there is **THEIR OWN** strictly specified model **CONSTRUCTION**. Therefore, the lack of consumption by individuals of the required minerals and proteins suitable only for them, will lead to violations in their necessary quantity in the ionic state for flesh cells, **including for their Brain**. No less significant for the activation of certain functions of the human brain are phosphorus ions, acquired especially when consuming fish. Accordingly, this essentially affects the general state of the Brain, the maintenance of its functions in the active state, and, consequently, the processes of **GETTING KNOWLEDGE**, formation of an individual Consciousness. This directly affects the processes of shaping public Consciousness through organized actions and events, since the latter will undoubtedly be corrected through the controlled processes on the part of the Control System, perhaps even through an aggressive manifestation of violence or in some other form of practical actions, if there are such deficiencies in seafood. Any practical actions are always preceded by the formation of the concrete public Consciousness for all those who are involved in such actions **on the part of the opposition, i.e. for those who are paid and with "pseudoscience."** *The Black Sea Fleet sailors' uprising on the "Ochakov" cruiser under the leadership of Lt. P.P. Schmidt in 1905 and similar events are not related to the*

lack of seafood on board, because the original cause should be sought in the executive organizing activities of the Comintern.

I would kindly like to say at least to a reasonable part of the US population that the non-programmed substitution of the consumed proteins and minerals (with soybeans products instead of seafood) has led not only to the **IRREVERSIBLE DISORDERS** of all metabolic processes in the body of Americans and to excesses in weight, but also to very serious problems with **BRAIN DEGRADATION**, and to the aggressive behavior of the major part of the society. And this literally affects the formation of individual and **public consciousness**.

This is principled and in short, but quite enough for understanding the first group of functions of the Hydrophone layer, as a factor demonstration of its **GOVERNING INFLUENCE** on the Consciousness of people in the process of their organized being.

5.9. Need for thought

There was a completely different, but no less important, level of influence in the **second group of functions** of this Atmosphere layer.

13. Functions of the "guide and safekeeper" of the part of the governing energy-information translation, coming from the Control System Brain as a whole, concerning the executive nature of the material usage of people, formation of their actions and events within the framework of both strategic Programs: "Development of the Genotypes of the Brain" and "Development of the energy biogenesis of the Flesh cell".

It is not intended here to consider the whole complex of the second group functions of the Hydrophone layer, through which the **TRANSFER** of part of the energy-information translation **WAS CARRIED OUT** on the consistent realization of the entire historical Vector of Target of phenomena, actions and events of the entire vast geography of the world, since only the demonstration part of them is important and sufficient today, which, directly or indirectly, had a relationship to the formation of the people public Consciousness. I hope, many volumes of future research will be devoted to those processes. We will consider only some of the facts of the participation of the hydrophone layer in these processes.

Looking at the map of the World, showing the current results of everyday development of the continental and sea (oceanic) part of the Planet's surface, one can be surprised at the **INEXPEDIENCY**, on the one hand, and surprising harmony, on the other hand, in matters relating to the overall distribution of the Planet Population, the formation of a great number of artificial continental, coastal and offshore structures that provide a certain level of sufficiency in governing all spheres of organized life of the peoples of the Planet. This demonstrates to a certain extent the **DEVELOPMENT LEVEL** of the present civilization, the very process of which is realized through the ongoing interstate strategies of various geopolitics' directions. It was to such a **PHILISTINE LEVEL** of judgments that all social **THOUGHT** of the being was "**TRAINED**" without raising any doubts about "its essence". But is it true in the sense of everything that has been realized?

It seems somewhat defiant (and for someone, even offensive) to learn about the fact *that people were not independent* both in choosing their places of settlement and corresponding all creative actions in getting settled, and in the implementation of **ALL** historical eventful **PROCESSES** of any scale, the realization of which they have been taking to this day for **THEIR SELF-HISTORY**. The entire process of the events realization took place *under the supervision of the Interventional Control System*. It applies to all peoples and all places, where they are now settled. What kind of role and function did the Atmosphere Hydrophone layer perform in this process of the Control? For example, the governing effect of the **Bermuda Control Complex**, as part of the Brain Control System (**Layer 1**), and its translational impact through the Atmosphere Hydrophone Layer (**No. 2**) on some of the major eventful processes taking place at least with the participation of the US, Canada and Mexico population. Whatever the Americans position themselves, in their whole "history", as the "honored leaders" of the modern world order, they are all **ARTIFICIAL GENERATION** of some *imposed events for almost 400 years of history with the Bermuda Control Complex participation*. No deserved selectivity and initiative on the part of the so-called European colonization – **in the 16th century**, in the formation of all eventful historical processes – later, the organization of social and state regulations – in the past and now, the specifically divided settlement of the entire population, even the unreasonable concentration of nuclear energy (**43 NPP**) only on the east coast and many other things – all this **IS NOT** the initiated independence of *these European newcomers*, but the

controlled processes, including the participation of the CC Bermuda and the Hydrophone layer.

What was the changing state of the public Consciousness at every stage of the historical development of the United States? It does not matter. What is important is that it was **IMPOSED** upon exactly the newcomers of the US **POPULATION** (*a certain set of individuals with a specific genotype of the Brain*), including the energy-information transmission through the gratings of the Hydrophone layer.

For example, what was the public Consciousness of all seamen of US surface and underwater forces as the carriers of strategic nuclear weapons during the Cold War? – It is eloquently described in the propaganda literature of that time from both opposing sides. But the construction of systems for stationary and mobile surveillance, tracking, tracing the lines for preventive strikes and many other operations – all this was created under the guiding and Control of the Hydrophone Layer, without noticing its declarative participation, but realized by people as **INITIATIVE REASONABLE** volitional actions and decisions. And all this is not without heroic efforts in difficult ocean conditions, forming the corresponding antagonistic public Consciousness at this difficult period. But in fact, ***the system of operational control was created*** (missing earlier) over all movements and potential possible use (as a threat) of nuclear weapons by the Control System, which played a certain role in the historical processes of **GROWING VIOLENCE** on a global scale and had an impact in the future. This, finally, led to the programmed processes of the global governing of the world's people being – ***"Globalization" through open violence and parasitism on the part of the US and its accomplices.***

The question might also be asked about the **INSANE INEXPEDIENCY** of locating all nuclear power plants on the east coast, taking into account their complete vulnerability to the threat of use of nuclear weapons by the USSR. But such placement was determined by the main generating complex of the **CC Bermuda**, and it was determined for some kind of "replenishment" of the complex thanks the activities of nuclear power plants, the number of which was determined by the "capacity" of the Complex. American engineers had only to realize it and convince others of it, that is, to influence their public Consciousness on this part, but with **MANDATORY PARTICIPATION** of the Hydrophone layer and the Atmosphere Control System located in the same layer! In such subtleties, it may and has to be considered further each geographically outlined fragment

of the state location and **REVISE** the **ENTIRE HISTORY** of the events, bringing closer the features of their realization through the truth of their Systemic Control.

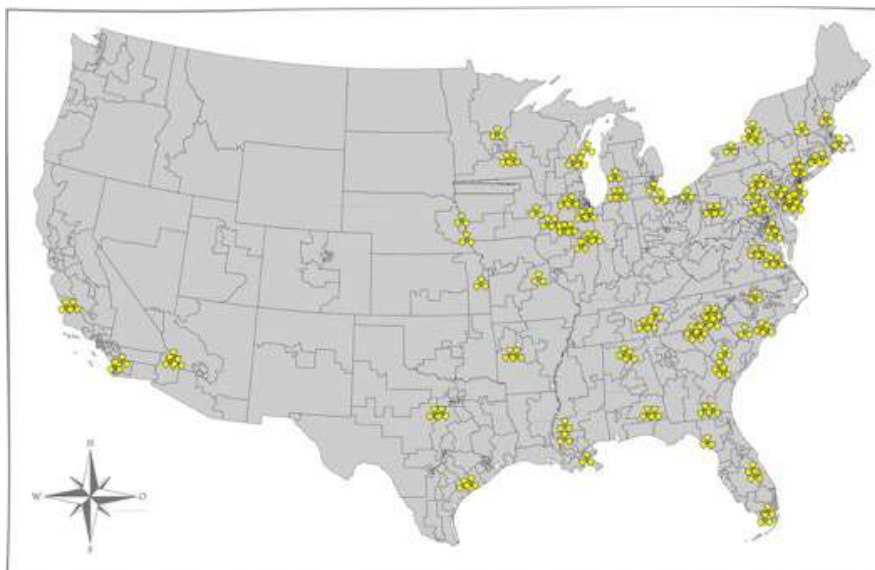

Equally important in its functionality is the No. 3 layer, which houses the Atmospheric Control System.

Layer No. 3 is very complex in Construction. It is vertically **divided into sub-layers of 6 meters**, each of them having strictly identified frequency characteristics, excluding any superimpose or mutual interference. We will consider only that part of the control functions placed in this layer, which **DIRECTLY INFLUENCED** the formation of the public Consciousness of people strictly differentiated by their functional-territorial dispensation, depending on their settlement in the regions of the Planet. These functions include:

- formation, control and hold-in of the "prescription" form of all chemical elements in their ionic state;
- energy pumping, control and regulation of the stability state with respect to the potential density of charges, i.e. holding a given half-life of elements;
- holding the construction of all energy gratings of the elements along the axes of symmetry and translation, natural temperature and pressure.

The fact is that the very life of the entire bio-environment, including people, is possible only under the **MANDATORY FORMED** life-support

CONDITIONS. Part of these conditions is organized with the help of **layer No. 3** and with the participation of the Control System placed in it.

Within this **layer No. 3**, the most complicated process of constructing models of chemical elements at the ionic level is carried out, i.e. it is implemented the modification of all chemical elements in accordance with the Program of the the Energies being of the Earth (*in their inertial and non-inertial states*). We must keep it in mind that each chemical element has *hundreds of thousands of frequencies* interconnected in a model linkage (specific to each of them), which are strictly within the limits of temperature and pressure. Each chemical element has its half-life. If charges potentials are pumped through the frequencies included in the model construction of the energy grating of the chemical element, then its half-life time increases. Otherwise, the chemical element decomposes. The isotopes of the chemical element have different lifetime, which is reflected in **Fleorov's** chemical elements table (**Georgy Nikolaevich Fleorov**, born

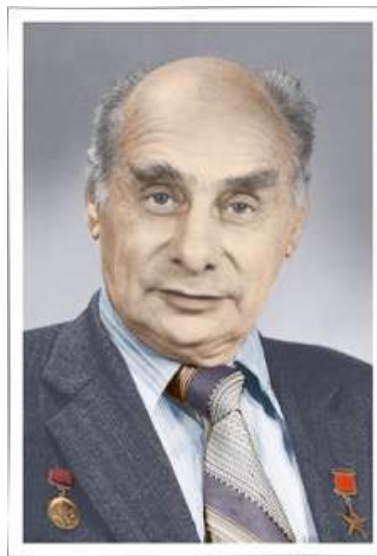

February 17, 1913 – Soviet nuclear **physicist**, co-founder of the Joint Institute for Nuclear Research in Dubna, academician of the USSR Academy of Sciences (1968). Socialist Labor Hero, Lenin Prize Laureate and twice Stalin Prize Winner).

In the layer where a certain programmed chemical element is formed, it initially has its being in the form of a mixture of certain isotopes. When the model structure of a chemical element falls apart, a group of frequencies is formed, which is defined as the frequency spectrum. Any group of these frequencies has a carrier frequency, which is both basic for the scattered group, and for the chemical element itself. This is radiation frequency, and all the spectra are constructed with reference to specific radiation frequencies.

It is important to note that the living flesh cell also contains radiation frequencies. This is just **ONE INSUGNIFICANT ELEMENT** of the whole variety of the general Construction of the Earth energies being. **Here is an example:** when having fluorography, the cell content is recorded in the picture with reference to the background of the radiation frequencies, and

not to the base of the cell itself. Therefore, any cell study with such an instrumental method is rather **SUPERFICIAL**, and far from being objective. In case of dissipation, the potentials density, frequency, the distance of action of such a physical process can be measured with the existing instrumental methods, the results of which make it possible to draw various frequency circles around the dissipation source. However, if we decompose these frequencies into points, we can get a certain curve, which is called the "symmetry curve". This curve contains 18 axes of symmetry and 6 translations³⁸. Frequency dissipation makes **SPECIFIC FORMS of SPACE**. This is exactly a very important physical process as one of the necessary conditions for the biosphere life-support- ***the volumetric form of the space dissipation***. Thanks to this process, but with no help of the anatomy-pathologists it is possible to answer a large number of questions on the features, and varieties of voluminous forms and the surprising harmony in the placement of internal organs in the people's body ***that "do not interfere" with functioning each other, at least!*** If you remove dissipation, then the liver, for example, takes the spatial shape of the ball, "singing" in a completely different key at its base frequency and just will not allow the rest of the flesh to live in the same harmony!

In fact, there are metabolic processes not only in biostructures, but in the whole of the environment! It is only for this reason that people have to be much more modest being in the environment and **NOT PERMIT** yourselves parasitic feeling of its "conquerors", for it (Nature) all the waste of their vicious existence **RETURNS THEM (US) IN FULL** (not only in their inertial, i.e., material "solid" state). It is true, every year it requires more and more means for treating people. Very harmonious" relations, aren't they? ***"You give me – I give you"***, like among the officials. Apparently taken deep roots nowadays **"paid service exchange"** among government officials, **IS NOT** corruption, as a vice, at their level of understanding , but ***a natural phenomenon that "releases" them of the legal responsibility for bribes*** (it is like an element of their "public Consciousness").

Taking into account the imposed structural features of the Brain (according to the frequency response) in groups of individuals of each Brain genotype (with all the diversity of their sub-genotypes), it should be emphasized that for each of them a **THOURALLY IDENTIFIED** basic radiation frequency (with an appropriate set of complementary ones) was

³⁸ Description of space dissipation, see AM Khatybov "Symmetry".

dispensed. There are more than 100 radiation frequencies (the number of now existing **sub-genotypes is 61**), i.e. there is still some choice! Will **"Svetl" Programs** help? Yes, they will, and just the way I said. Not depending on the User's Brain genotype, **but depending on his desire for Cognition**. For a specific geographic continental region, with a specific functional-territorial assignment imposed upon it, and proceeding from the framework of executive human actions, **in layer No. 3** of the Atmosphere there was formed its specific set of radiation frequencies, which ultimately expressed the framework of certain life support conditions for specific types of individuals.

One feature should be noted – the selection of radiation frequencies for a particular geographic region is **NOT ALWAYS** permanent. It changes in strict harmony with the tact of the event –driven time, and correction of its complex state are preventively made, if within the framework of the Vector of Target of the phenomena, actions and events, such correction is required for the formation of some future actions or events in the given region. This kind of correction has begun in many geographical regions since **2012.10.25**. Naturally, all similar changes, and especially the last correction, are "coordinated" by **"SvetL" Programs**, depending on the Users' definition in the further processes of environmental transformation and "fulfillment" of the target vector in the framework of participation in these processes in accordance with the transformation of their Consciousness (correction details are not public today). This set of radiation frequencies as its basic principles determined, in its turn, the prevailing quantitative geographic settlement of a specific ethnic group (or a possible set of groups of individuals with a specific genotype of the Brain). This directly and irreversibly influenced the processes of people's **ALL-ROUND WORLD PERCEPTION** at all stages of their development and expressed the specificity of the emerging "national" traditions of behavior and cohabitation. All this also influenced the construction of various types of the organized societies being characteristic of a specific functional-territorial dispensation and development stage, culture and everything else concerning the **BEING** of **PEOPLE** in general.

In people's being there are no actions and events without a formed public and individual Consciousness, and therefore, the **Atmosphere layer No. 3** took a direct part in the programmed imposing upon people such Consciousness. So the tribal world perception prevalent among political scientists in their attempts to change the structure of the social being of modern society (in their own favor, i.e., democracy only for themselves) – all

this should rightly be **BROUGHT INTO CORRELATION** with **ANIMAL BREEDING**. And the world of reality around us is completely different, and, in accordance with the harmony of the changes taking place in it, requires a completely different, **NOT ANIMAL-BREEDING** approach to the transition to another way of human civilization development, creation of a new system of their organized being, especially in the formation of Consciousness!

Since **2012.10.25 THE ALL ROUND BASIC** world perception of the present-day people, concerning the processes of formation of public and individual **Consciousness has been switched over from the basic position of "profit" to – "reason"**. This process is provided by the appropriate energy-information translation on the part of being restored original Control System. This seemingly insignificant information is the new cornerstone firmness, of the shaped executive state (one of the three that is needed), which is laying down the beginning of the **REPLACEMENT** of the **WHOLE** former Structure of the organized human's being born by the old Interventionist Control System. That's why, just a few months after the death of **N. Levashov (2012.06.11)**, the concept of "implementation" of **"SvetL" Programs in the Generator** was "revised" (you should not associate it in any way with N. Levashov's passing away which some "individuals" are trying to do), and their application and "tuning" (adjustment) to those processes that have begun in the Atmospheric layers and, in particular, in **layer No. 3**.

In what way was the technological control of the whole variety of parameters and derivative states realized in layer No. **3** and with its help? The functions of such technological control of states, including those of the public Consciousness, were realized with the help of **"Cords"** as one of the active elements of the control.

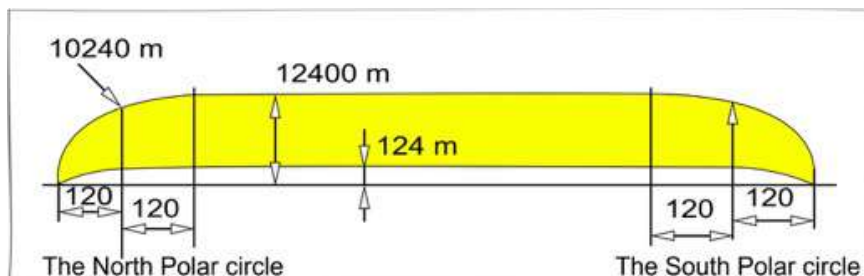

It should be taken into account that the "Cords" (directly by their constructive arrangement) operate along **layer No. 3** in the equatorial zone, but the information is taken over the entire zone between the south and north polar circles. This is just one complementary control element to **120 Control Systems from 18 Earth Control Systems**. The "Cords" control in most cases proceeds "painlessly" for the Man (blood pressure increase, a taste of metal in the mouth and similar short-term "nuisances").

The Cord is something like a curtain stretched from the Arctic Circle to the South Circle. **Up to L=120 km – the segment up to h=10240 m.** The next **120 km – up to h=12400 m.** The height above the surface is **minimum 124 meters.**

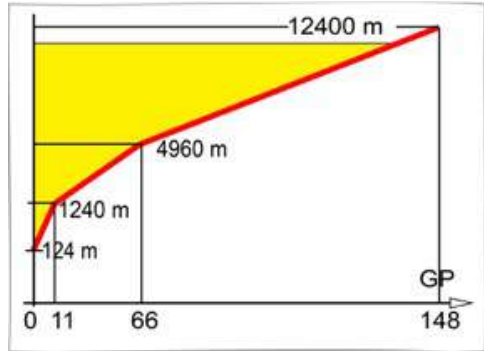

The density of the cord structure is uneven. The gravitational potential has a stepwise distribution. The maximum possible density for the structure of tetrahedra =148GP, (for cubes =124GP). That is, if during the cord operation a cubic structure object passes through it, then it (the object) disappears (scatters into atoms). The cord thickness at the base does not exceed 1 meter, at a height of **h=12400 m**, the thickness reaches **32 m**. The lifetime of the cubic structure in the cord does not exceed 1 second. The cords work schedule is formed basing on the requests of the Control Systems.

Basic control cords

No P / p	Octaves	Usage	Location
1	11 – 511	15 – 124	Approximately 33 km from the coast in the direction of Khabarovsk, along the meridian
2	11 – 511	15 – 124	+ 1047 km to the west of No. 1
3	11 – 511	15 – 124	+ 1047 km to the west of No. 2
4	11 – 511	15 – 124	Approximately 120 km east of Zurich
5	11 – 511	15 – 124	+ 1047 km to the west of No. 4
6	11 – 511	15 – 124	Bermuda Center
7	11 – 511	15 – 124	+ 1047 km east of Bermuda

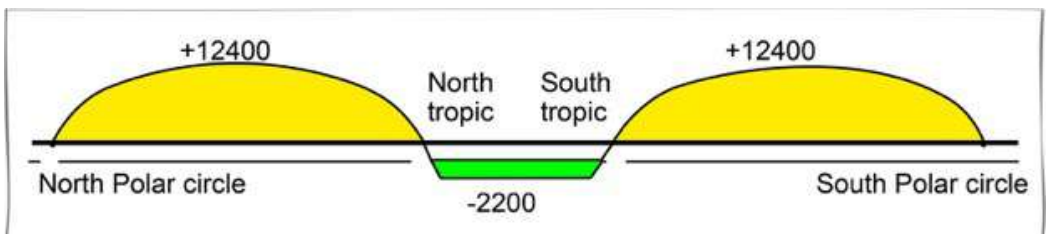

There are only 32 basic cords, but they are turned on once a year at Easter. And separately each out of 7 cords specified in the Table are turned on once a week (optionally sequentially). There are also additional Atmosphere grating control cords in the layers from 0 to -2200 m, there are 48 of them. For convenience, the additional cords preferably to be classified as Lower Control Cords. Data on 32 and 48 cords are classified secret, the information on their placement and transit is not subjected to passing to outsiders. Nowadays this control 2 “works” under the New Control System and is extremely essential.

The cord is not a stationary object. From the moment of loading and its formation, the cord "phantom" is created, that **for 2 hours and 10 minutes** runs around the Earth (the cord itself remains in place). By the potentials difference of the cord and the phantom, the Control System makes a request for the corresponding complex, **which picks up or removes the necessary potentials.**

99% of all imported underwater individuals are in the zone of the Northern Tropic – Southern Tropic, therefore in this zone the main grating control is from 0 to -2200 m.



In the picture, the moment of passing the Cord phantom during the period of switching on the electrical equipment at the tower

The control system was created together with the Earth, so the range of its octaves is from 11 to 512. Cubic structures use the control from 15 to 124 octave. **If, for example, 128 octave control is switched on with the load of more than 136% of the gravitational potential, then all cubic structures from 15 to 124 octave disappear along with their carriers.**

When Man is being controlled with regard to the implementation of the "imposed executive orientation" in the context of solving specific tasks,

it might be rather painful. The more **FIXED "ATTENTION"** is to the person, the more "parameters" are "read" (required from the Brain) and the more "troubles" (unpleasant sensations such as sharp pain in the heart, dizziness, etc.). I experienced it myself in September **2013** and then several times over the next few years. This also explains the "complaints" of "**SvetL Programs users** in recent years on the ***"sometimes sharp pains (short-term), palpitation, a sharp increase in sugar in the blood and dizziness up to the loss of consciousness».*** I am saying it again to the Users of "**SvetL Programs** – there is **"SPECIAL" ATTENTION**, and not only in similar things. You have to know about it and you have to BE more **HAPPY** about it than **WORRIED** (especially people of mature and elderly age). The generator **"is able to stand up for you"**, so to say, but it **WILL NOT** block such a control (and, accordingly, related to it some discomfort and affection). The information, I am saying it again, – is goal-oriented (exactly to the User of "**SvetL Programs**), must be objective, **since the question is: "ARE YOU LET** to have a Bath or **NOT TO"?** However, I would like to draw your attention to the fact that if, according to the functional endowment and the corresponding set of the Brain function, an individual does not have any relation to specific information, translated and verified today, he **WILL NOT BE ABLE** to get such a contact state to obtain the information and the **CORRESPONDING TO IT KNOWLEDGE**. Errors are technologically excluded. A person who bakes bread well **IS NOT ABLE** receive (perceive) information for a nuclear physicist, unless, of course, the "baker's Brain" has been changed for one reason or another. But it does not mean that the "baker" today fails to understand that everything connected with nuclear energy makes **MORE HARM** than good. In the current time, the functional endowment of individuals can be **SHARPLY CHANGED** according to what is happening (I mean, you should not "relax"). The brain that is not prepared for this, in most cases, might not accept this information, however, the users of "**SvetL Programs** will "accept" it with great certainty and become co-executors in the implementation of the intended Target Vector. This is a great chance **TO BE "INTEGRATED"** in the future. The time has come to say it **OPENLY**.

The other layers of the Atmosphere undoubtedly influence the processes of ensuring and functioning the created Habitats and Conditions of the controlled environment, ***but their effective influence on the very process of Consciousness formation is of DERIVATIVE, i.e. GUIDED*** character. For this reason, we will not consider them. And leave

them to the "experts" from the Scientific Research Institute of the Center of Preventive Strategies (**SRI CPS**).

5.10. Biomass

An important functional fragment, or, in a different way, the definition of a control system, was the monitoring of the state of the so-called "biomass". However sad it might sound, but "biomass" should be understood as a **BIGGER PART OF THE POPULATION** that was not subject to the programmed processes on the creation of the Brain genotypes. *This part was used to a limited extent in the development of energy biogenesis of the flesh*, but basically was used as so-called "programmed-brain donors", being applied for the purpose of working out some changes in the Brain functions and carrying out some expertise to control the changes in the habitat.



N. Levashov, so that not to hurt the psyche of unprepared people, wrote that "the motion of Entities is (was) an objective process"! But he did not write (although he knew it, and we discussed this process, which was new for me that time), that **NOT** in **ALL** the bodies (shirts) in the formation of the fetus there was **ENTITY'S MOTION** which were destined to development. No matter how sad it might be, but that is exactly that way.

All public figures in the sphere of power, concerned with demographic problems on the Earth, can calmly take off the entire burden of such responsibility and rest in serenity, for all these problems have been invented by them. The quantitative and qualitative composition of the entire population of the Planet is a **CONTROLLED PROGRAMMED PROCESS**, and it was only the System that was able to make decisions on such important episodes. The reason for all this is the ever-complicating process of working out and improving the control system elements and developing the functions of the Brain in the **PREDETERMINED GENOTYPES**, and everything else is a consumer-goods material usage of the ongoing development process. If the Brain of an individual from the whole controlled mass manifested itself by some indicators of the Brain functions as having received more advanced properties of receiving, processing and indicative ability of a new function with some other expedient

executive operational qualities associated with the manifestation of more perfect control over the operation of a particular internal organ, then such an individual became a **"programmed-brain donor"**. The perfected feature of his Brain activity to control the activity of an organ is perceived by the control system as positive, i.e. the best experience.

Such manifested options for planned deviations from previously tested control frequencies were fixed and later, after repeated and massive verification by programmed brain donors, were duplicated for their subsequent setting in **"The Golden Billion and Million" (Brain Genotypes 42, 44 and 46)**. Such processes required **QUITE A LOT OF TIME**, and polishing was carried out on many generations of donors. Actually, this is what **N. Levashov DID NOT SAY**. And, in my opinion, he did correctly, giving information that time that could be adequately received and then, as we know, **FAR FROM EVERYONE**.

For example, for the manifestation of non-unitary individuals, the so-called **"new Russians, or simply oligarchs"**, it was required to make complex experiments on the part of the System both in the field of energy biogenesis of the flesh and in the correction of many Brain functions, i.e. to the future "surplus in caviar, money, the frenzy of market relations and the shadow economy" the Brain functions were taught and worked out slowly. This involved at least four generations of "programmed-brain donors", on which the module of **FUTURE INDIVIDUALS** was tested for the subsequent introduction of programmed and functional orientation to receive information from the System on the NEW world perception and the imminence of social re-arrangement through the **RUTHLESS** destruction of all that existed before them. In the popular rumor, such brain donors were called "styli", and later "the sixties».

A complete list of such worked-out and implanted individuals has been sung of by sociologists in the annals of history-from Gorbachev and Yeltsin to Chubais, with all the images of a separate breed of Gaidars inclusive and further adherent to them of petty abandoned, lost youth with an indefinite functional and other orientation, like the involved programmed executors on the immanent perception basis of information. **They have no their own "brains"** but outwardly they look like their brain donors.

After the frequencies are set and checked in operation, the entire mass of previously involved "programmed-brain donors" was **NO** longer **WANTED**, and the System got rid of them, carrying out a **CLEARING** with

the purpose of **NOT GRANTING** further development of such Brain functions in the mass of former donors or in their born generation.

Thus, the Control System has been programmed to improve, practicing in polishing all and every function of the Brain, i.e. **CHOOSING THE BEST OPTION** for all functions, including control over the amended program of individual internal organs functions, introducing such "achieved experience" to individuals of the so-called "*Golden billion and million*". Such a version of material usage of people required a quantitative increase in the "experimental material", and this was one of the reasons for the significant increase, variety in the required quality and the corresponding specific quality of the Planet population. The more complex was the programmed Brain genotype in the process of its development **from 42 to 46 genotype**, the more "experimental" processes were required with multiple control check of the states of the Brain functions both of outer and inner control. It **DOES NOT MEAN** that such a process of development took place by the method of random selections, i.e. "blindly." It was associated with an extremely complex programmed process of simultaneous combined development of not only the Brain functions and abilities, but also with a complex program of the **DEVELOPMENT OF THE ENERGYBIOGENESIS OF THE FLESH** of the individuals themselves, practicing incredibly complex and multivariate programmed processes in an integral approach. The exhausted "material" after the completion of such a program was removed by the System. By the way, *Saakashvili, Lev Kachinsky, the presidents of all three Baltic republics, Kurmanbek Bakiyev, etc.*, would have been such organizing executors in sweeping large numbers and over a large area. But they have not been let to perform such "historical function". They have just been "written off", and the Program was liquidated with the corresponding consequences.

5.11. What to wait? How to perceive?

The Earth's Control System transforming goal-oriented translation in Russia began **in 2013, on October 25 at 3:14:45**. On the night of October 25, **THERE WAS** a **TRANSITION** of the control **STATES** on the part of the ECS (Earth Control System) to the level of a more tough (that is, less smooth) influencing character. So far, there has been no need in a very tough transition, but if needed (and everything goes to this in the light of the ongoing events), it will be **LESS SMOOTH**. How is it manifested? People

do not feel it at all. But, quite objectively, there have been more speculative effects than, for example, **until 2013. NOTHING TRAGIC HAPPENED on October, 25**. This change is with immense benefit for the future, since more active process has begun, in the MORE COMPRESSED tact of event-driven time ... The former natural habitat is being recreated. And first of all, is the Control. This has already affected the environment. For the observers there is much more joy- there are more various glowing "balls" in the heavens. Do not be scared – they are not UFOs... **NO** more UFOs brought in by Ebr system, **WILL BE ABLE** to take off anymore. The main Complex guiding their movement is completely "switched off", it is **NOT SERVICEABLE**. And all of today's "UFOs", which it is written about, are seen, made pictures of and shown in the network a lot, are "luminous balls" in the sky. But they appear, if we analyze their appearance, always in connection with some events in the area of their appearance, planned in the framework of the so-called target vector of the ongoing events,. A good example of it is the so-called "Chelyabinsk meteorite" (February 15, 2013). About the UFO, I'll write in more detail in another chapter. It is useful for your knowledge.

Recently there "appeared" especially many plasmoids³⁹!



Various kinds of plasmoids have been used and continue to be used. They are moving sensors of various types and different functions. They themselves are **NOT ABLE** to do harm, except in an energy way, (there are more scalded than frostbitten after talking to or touching them). They are not capable of creating any special destruction and you should not beware of

³⁹ Plasmoid is a plasma clot, a limited configuration of magnetic fields and plasma. Nikolay Tesla got spherical plasmoids.

them. Plasmoids began to appear, as a consequence of the processes to create the true ECS. They are given rise to within the framework of the Earth Control System. It might be possible to publish some information on plasmoids, but we have such inquisitive people that they will rush to check, and this is fraught with some unpleasant consequences. In future, there will be more of them – **DO NOT PAY ATTENTION** to them. And even if you are so curious, do not interfere with your curiosity into the happening. Where there is a manifestation of **UNREASONABLE CURIOSITY** today, there is also a **COUNTERACTION**. The same is true about **Complexes "SvetL"** and their **Programs**. You should make accustomed yourselves to the thought that there mustn't be any curiosity, but **KNOWLEDGE** and **STRIVING** for knowledge.

There are many who ask: "And what are those objects near the Sun?" Near the sun they have been for nearly 18 (for April 2017), and they became visible and are watched only recently. And if you look closely, you can see **4 good "suitcases"** that are flying, doing some work with the Sun – removing from it the **UNWANTED INFRINGEMENTS** on the Earth. The Earth still being in the captive state gives way less and less energy unwillingly, but previously it had to give it unhindered. And now the volumes of Earth energy transfer in the 53rd octave are **BEING REDUCED AND VERY INTENSIVELY**. This is the Programmed Process. All the residual processes that manifest themselves in various areas in the form of Aurora Borealis are the processes of ignition of the prepared but not-delivered energy from the Earth. And do not pay attention to the color. The colors are of the energies (matter) "fired".



I am writing it to those who after reading the information about the end of the Northern LIGHTS as the process of Ebr System, will not ask questions, like – "But Khatybov wrote that there would **NOT BE** any Northern Lights, but they go on and on..."

Do Ebr objects fly today? Yes? They do. I have already written that **ALL** the planets' **SATELLITES** are to be "got together" (and the process is under way) near the Sun. The "Planets Parade" that we periodically can watch is

hung over with satellites. The Planets have been in Ebr System captivity so far. There are a great number of satellites that "go round" Saturn which had not been able "to land" on it. Saturn **DID NOT ALLOW** but kept them in captivity and did not let them go. Each of the planets in the Earth cluster system is endowed with a certain function. While in captivity their atmosphere construction was practically destroyed. Now the processes of the atmosphere gratings recreation are in full swing at **ALL** the **PLANETS of the Earth cluster system**. Some are being recreated, others are **CREATED ANEW**. The communication Tubes have been saved but rearranged by Ebr System. It surely incorrect to say "gravity communication tube" since it has nothing to do with gravity, but there are many who **WILL NOT UNDERSTAND** it in the other way, unfortunately. And not only the **Users of "SetL" Programs**. They **HAVE NOT BEEN** to the **Bath** yet. If I openly say now that **THERE IS NO** gravity at all there are many who will start twisting their forefinger at their temple so intensively that might make a hole in the head. So, I'd rather wait till the right time, though, something will be said in the fourth book. And now a few words about what gravitation was meant by. It is sufficient to say that **ENERGIES MATTERS** are pull and push. The Moon, for example, was held by gravitation communication tube like a "dog on the lead". The moment you loose the lead it is noticed by the astronomers.

There are many who did not know, and still do not know that all women's life cycles are **DIRECTLY CONNECTED** with the Moon! ***That's why today, as they say, our beloved (and generally all) women "are on the rack", not understanding what is happening to them.*** The moon will be further moved off the Earth. There will be a lot of delight.

We are glad to have the Sun, its light and warmth through the energies transformation withdrawn from the Earth. The form of energies **in the octave of 53,25-43,25** – these are for life-support conditions. They are unnatural for the Earth in general. **IN THE PROCESS** of the Earth **SYSTEM RECREATION**, the "services" of the Sun will no longer be needed ... The Earth provides itself with everything! It is so technologically perfect that it does not need interference. Day and night **ARE NOT TO BE** canceled. Temperature, and more habitually – climatic conditions, in the ongoing process of recovery are already changing for the better. I am confident that ***Russia will build resorts in the Arkhangel, Murmansk regions, in the Republic of Komi, on the coast of all northern territories.*** Take notice of the winters of **2015-2017** –and this is just the beginning. The present day Northern belt, where the average

annual temperature will be **+22.5°C**, is to be used for crops. This will make it possible to harvest two or three crops with a small amount of acreage. There will be no need for "**SvetL-Flora**" **Complex** then. The Earth will be less "contacted"! Nature will **APPROACH** the **CITIES**. And it should not upset anyone, it should make one happy. Not only **N. Levashov** and I, but all those about whom I have written, believed and believe that one of the functional endowments of Mankind **is get careful to Nature**. Flora and fauna after re-creation will become producers of those minerals that are vital for Nature and Man life-support. But this is one of those **MOST DIFFICULT PROCESSES** that people are to experience. This is not liquidation at all, it is not correct. This is the **ELIMINATION OF the CONSEQUENCES** of the Interventionist interference into the Earth Cluster System. ***This is the expediency that is to be implemented!***

Chapter 6. About the creator of the "Bannoye delo"

Life experience gives us joy only when we can pass it on to others.

Andre Maurois

Those actions that are taking place today before our eyes, as a result of the most complicated events developing like a scenario, directly affect our lives and lead to the unconditional conclusion that for a transition to another path of development it is far from sufficient to have the present level of cognition and that knowledge we possess. Any attempts to go on making "houses of cards", i.e. artificially imposed illusions and abstracted from the surrounding reality model ideas about it, take us further away from the reality. Many people begin to realize it. In what kind of perspective should one see the ongoing events to get at their meaning?

The happening is the **ENERGY** of **CIVILIZATIONAL DEVELOPMENT**, discretely differentiating each of its own path out of the general process that is going on, when the highest level of all forms of **PROGRAMMED HARMONY** at the previous stage is reached, before proceeding to the next stage of its development. ***Is it too complicated to get at the meaning?*** It is complicated, but for the time being. Are the people involved in this process? Yes, they are, or, rather, ***their Brain is involved***, through which the intended implementation is taking place within the framework of the adopted vector of the target. The scale of the happening is so enormous, or, rather, endless, that it is too difficult to comprehend. Most people believe that. But that is not so, since infinity **DOES NOT EXIST**, neither does zero. Naturally, a **NEW THEORY** is required preceding practice, corresponding to the scale of the issue under consideration and the one that would be able to drive away the imposed model scientific limitations and errors of the past stage of cognition, based on the material world (materialism) as the dead anchor of the continuous **IMPOSED LIMITATIONS**. I'd like to note that a new theory of the similar scale, which is very intelligibly presented in five parts of the "**Foundations of the Mankind Formation**", will successfully pass its test if it (even now) in total answers the questions about the birth of the universe and explains the true essence of matter as a whole, (from origin to its constructive

arrangement and controlled by its own being). Only such a theory can acquire **the SIGNIFICANCE** of the **TRUTH** and become **the "Universal Constructive Theory"!**

Steps in this direction were made by: **N. Levashov**, who created not only the **THEORY OF SCIENCE about everything**, but also tried and tested it in practice; **N. Morozov**, whose works open the way to the comprehension of the new science as such, and his rigorous scientific approach to solving problems, which is a rare thing now; **A. Khatybov**, who for the first time accomplished not only **MOST** of the **EPOCHAL scientific DISCOVERIES**, but also carried out practical actions with direct and immediate preventive participation, of which I will write in this chapter; and others now living, but so far (for known reasons) **NON-PUBLISHING Russian Scientists** in the most direct sense of the word.

Many people ask the question: why do we need such experiences in cognition of **EVERYTHING UNKNOWN** and so far so distant from our present life and understanding of the state of the Consciousness and Mind? After all, we used to live quietly and without all this. If, of course, we forget and do not consider the constantly increasing scale in the desire to destroy each other and not take into account the end of our civilization perfection in the sense of life – "everyone against everyone" – then, in principle, it can be considered that **little by little. We lived, but as a material usage** for the implementation of the programmed processes under the control from the outside, in which the very process of civilization development of people was far from being important, with all the strictly oriented direction of the events. ***There are no such human words with which you could convey the full depth of this humiliating state of material usage,*** and the impossibility of even realizing this fact. In practice, Man **WILL BE RECREATED ANEW**, he will cease to be the object of application and usage.

There is not any preaching or pathos in the fact that the life of society and people, today at the crossroads: either forward to the past, i.e. without changing their **CONSUMER MENTALLITY**, or to find an entirely different path of development and form their own being, oriented to recreating the true conditions of civilization development of the very model of the Earth. There is a choice, and it is individual for everyone, despite those heavy and independent of us destructive consequences left by the Interventionist interference in the past. But still **THERE IS a CHOICE!** To approve such a choice, there arises a countless number of vital questions of principle, without realizing the essence of which, it is difficult to make any

decisions for yourself and orient yourself in what is happening. It is **DIFFICULT**, **BUT** it is **POSSIBLE**.

This narration is in some way a clue in making the choice. **IT IS POSSIBLE**, – because there is something to **READ**. They are the writings of **N. Levashov**, and then **A. Khatybov**, so this way it will be easier to understand them and then apply, having made the right choice, first of all, for yourself. And on the basis of this, you are sure to be **TAKEN TO THE BATH**, and if **there is "Svetl" in addition**, there are good prospects.

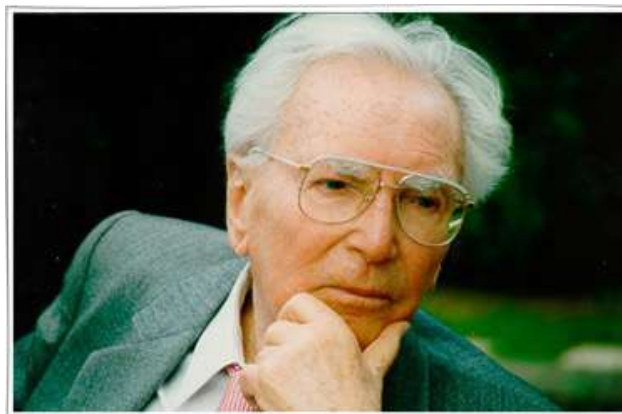

Viktor Emil Frankl (1905-1997), an Austrian psychiatrist, psychologist and neurologist, was a prisoner of the Nazi concentration camp, said in his time: "What constitutes the dignity of the world can only be saved on one condition – remember it. And the dignity of the world is made of mercy, **LONGING** for **KNOWLEDGE** and respect for the inner world of Man. *Man can be deprived of everything but one thing: the last Man's freedom – **TO WORK** his **OWN WILL** under any circumstances, choose his own way*".

6.1. This "unknown" Khatybov

All that we learned – turned out to be a game in bricks and the horse's science.

I could not help writing about this amazing Man. Unfortunately, I haven't had the honor to be acquainted with him. When I got to know about him and read his works, he **WAS GONE**. Most of his works were devoted to carrying out calculations in many fundamental scientific directions of the future. He managed not only to carry out all the necessary calculations, but to realize them, too. Who is able to appreciate his other **NEW**

MATHEMATICS, which made it possible for him to practically realize it for the processes of recreating the future natural substance of our Planet? This part of the most trying work *had taken the last 20 years of his life*. It is hard, and, probably impossible to imagine its true value, because it is taken by everyone for a mundane phenomenon. But was anyone else able to do this? When speaking of his activities, **B. Makov**, who had worked with him for a long time, emphasized that **A. Khatybov** was the only one on our planet, and this fact can not be practically comprehended by the present day people. Just like N. Levashov, there had been the only one. That is to be realized later, by our immediate or distant descendants.

In this chapter I will write about **Alexander Mikhailovich Khatybov**, and also about **Nikolai Aleksandrovich Morozov**, whom **A. Khatybov** considered his Teacher. So that to emphasize the influence of this person on his knowledge, Alexander changed his former name Morozov for his mother's name – **Khatybov**. He did this so that they **WOULD NOT BE REGARDED** as relatives and their works **WOULD NOT BE CONFUSED**. I will write only what I have managed to find out on the Internet, got to know from **B. Makov**, who was his closest associate and friend until A. Khatybov's death; and also tell you some facts that until now were not public. Well, you will learn much more about this Man from the future **monograph by B. Makov about Alexander Mikhailovich Khatybov (Morozov)**.

* * *

At the end of **2011**, quite "accidentally", I came across **A. Khatybov's** works that caused, putting it mildly, **ambiguous understanding**. By that time I had practically read all the writings of **N. Levashov** and more than once. If I did not get at the meaning of something we looked into it at our regular meetings. And what I consider to be most important is the fact that our "**Svetl**" **Project**, as we called it, had already been launched. At that time it provided for "**SvetL**" **Appliance** and the collection of statistical material on its use. Everyone who had already had "SvetL" Appliances, I called the "**SvetL**" **Program participants** and it was approved by the author of the Generator ("Generator of dark matter"), "set in" on an electronic platform with a certain computer program.

At one of our meetings I showed N. Levashov several articles by A. Khatybov that were published on the Internet. I remember him smiling and saying: "**I knew you would get to him**", – Levashov told me about this man. I knew from him that A. Khatybov "had gone." He showed me a notebook with calculations and notes, of which I got at the meaning of little

at that time. I only realized that those were the calculations and descriptions of the processes that were connected with N. Levashov's 'actions' in the USA to "stop" hurricanes, described in the second volume of "The Mirror of my Soul". From N. Levashov I knew about his meeting with A. Khatybov and where it had taken place. It was indispensable to get to clear understanding of the physics of the processes occurring in case of hurricanes, tornadoes and tsunamis. Of course, it **COULD NOT** be public then and therefore **NOT PRESENTED** in his books.

What N. Levashov's works mean for the people in the most general sense? They are the **BASIS** of **NEW KNOWLEDGE**. The knowledge that was intentionally hidden and for thousands of years could not be available. His books are written in a simple and intelligible language to make the reader to have a desire to "take a big "spade" to dig, and dig up the "stronghold" of so-called "modern knowledge" on which science is based today, tossing all the junk to the side and **FINDING** the **TRUE KNOWLEDGE**.

What are A. Khatybov's works in the most general sense? They are the **INFORMATION ON THE FOUNDATIONS** of the **NEW** (hidden) science, expressed in the calculations, explanations and new terminology, and in the demonstration of physics of the processes going in a living human cell (physics of energy and physics of the Brain, in full perception of what the **Brain** is).

While having talks with those who have read the writings of **A. Khatybov**, I got convinced that the readers consider practically all the works by **A.M. Khatybov** hard to comprehend even for experts. Their opinion is based on the fact that Khatybov used "extremely complicated terminology", which is sometimes just incomprehensible. **HIS MAIN WORKS** are not widely circulated today, and to many of the classical concepts he gave his own meaning, and it is even more "confusing" to the reader. There are many who complained that A. Khatybov sometimes wrote "incoherently", chaotically, with too much of emotions, irony and imagery. But, in my opinion, it is somewhat emotional conclusion. His ideas are an inexhaustible source and an intellectual treasure, worthy of deep research and understanding. Therefore, in my narrative, along with description of the past events, I made an attempt to "put" the author's articles into more or less understandable language, and also "open" some of his non-public writings that would make it possible to have a deeper look into the principles of the **"STRUCTURE"** and **APPLICATION** of **"SvetL" Programmes**. I Do realize it, because the interest in the knowledge given in A. Khatybov's works,

as well as in the writings of N. Levashov, is getting more widespread, and the demand for information is growing. Those who started their journey with the development and perception of **NEW SCIENCE**, the science of the future, the science of **CREATION**, but **NOT DESTRUCTION** are to get to know about the Man of immense mental grasp and greatness.

* * *

An unusual phenomenon for science is determined: if a new advanced study really reveals (at least for a moment) the secrets of nature, the author is subjected to defamation (burning). But if the work is an outright misinformation, then it is followed by honors, Nobel Prizes and other prizes, titles, etc.

A. Khatybov

The works of this Man of genius initially excite a slight shock, although today quite enough is known about the inconsistency of many scientific data that did not fit into the aspects of **REAL LIFE**. In the majority of scientists and people far from science, **HIS discoveries and works "detonate" (provoke) even stronger emotions.**



The lack of information on A.M. Khatybov on the Internet and the availability of only **A FEW** disparate **ARTICLES**, speaks for itself. This led to the fact that many people today are deprived of the opportunity to correctly perceive most of the author's works. There have to be a certain point of reference, or a platform in knowledge, from which we could push so that to ensure that **A. Khatybov's** statements lined up in an adequate understanding. Over the past few years, I have come to understanding that such a platform are **N. Levashov's works**. Those who accepted his works and got a good understanding of them, quite easily read and understand **Alexander Khatybov's writings**. But at the same time there should be an **ASPIRATION FOR MOVING** in this direction. Those who, after reading **N. Levashov**, did not have such an aspiration, became fierce opponents of his works. When I knew that **A. Khatybov** "had met" **N.**

Levashov, who specially flew from America to Russia for this meeting, and the issues they had discussed, I realized that I was absolutely right in my thoughts. Two Men of such a **LEVEL** of **KNOWLEDGE** could not have "existed" separately. Today I can once again say that many **A. Khatybov's** calculations found their realization when creating "**SvetL**" **Programs** and not only the **Programs**. It was not easy, but the vector in this direction was given to me by **N. Levashov** in his lifetime, for which I am grateful to him. I am grateful to **B. Makov**, too. We closely cooperate, keeping our friendship since the cadet times. We studied in the same group at the anti-submarine faculty at **Frunze Naval School** (now the Marine Corps of Peter the Great of St. Petersburg Naval Institute). I'll write more about it later. After graduation, our meeting with Boris took place in Moscow **only 20 years** later, and not without Levashov's participation.

And now let's return to **A. Khatybov**.

B. Makov introduced me to people who had worked with **A. Khatybov** on those issues that are already becoming public and find their application in real life. But, unfortunately, time **HAS NOT COME** yet to talk about everything that was written, calculated and created by **Alexander Mikhailovich**.

Most of his life he had to work at private institutions, which can not be indicated in the public information sphere yet. There is a site with **A. Khatybov's** works, which is open to public today. This [site](#) is of the scientific research institute "**CPS**" (**Research Institute "Center for Preventive Strategies"**).

Once I met a very interesting Man who on his Internet resources, under the pseudonym "**SAGITTARIUS 2012**", independently published information about **N. Levashov**, and **A. Khatybov**. I got in touch with him. He was **Alexander Afanasenko**. He has collected the most complete information about **Alexander Mikhailovich**, and he deserves many thanks for this. I decided to supplement his information with my information, which I know.



6.2. So what is known about A.M. Khatybov?

Most people, when reading Khatybov, take him for the author of some fantastic works or a scientist-loser who did not have any academic regalia, absolutely not realizing that now and for a long time ahead they are **UNDER MUCH OBLIGATION** to this Man!

Sometimes his name pops up in documentaries about aliens, which is fully justified in the conditions of preparing the population for "declassifying" the information available to the higher authorities.

What is the reason for the fact that information about a little-known to "broad masses" scientist was so carefully "cleaned", and the author's main works, once exposed on the Internet, disappeared without a trace? In order to see the reason, we will analyze available information about him. Here are excerpts from the stories of those who **HAD KNOWN HIM**.

In early **1985**, a quiet scandal was braking out in one of the petroleum institutions of Samara. A certain **Alexander Khatybov** did not go to work, and for this they wanted to fire him. But it did not work somehow. His salary was not paid. But not to go to work? Sasha Khatybov neither drank nor smoked. And in general he was engaged in such elite business as programming. Alexander was stern in disposition. He was self-willed, not easy to get on with, but hard worker, which in general, in my opinion, is characteristic of Geniuses. The whole evenings, or even nights, he spent in the computer center of the "**Kuibyshevneft**" enterprise, adjusting some program. As it turned out, an absolutely **UNUSUAL PROGRAM** of a **Travelling Salesman**. Nobody took it seriously. Who needed a program then that besides all could immediately solve, for example, the problem of the most profitable investment of capital? Where were they, those capitals, then? And **Khatybov** stubbornly sought a new application for the "travelling salesman", improved the algorithm of the problem and at the same time incessantly quarrelling with everyone.

Alexander Mihajlovich had the most direct relation to the developments related to psychotropic weapon. **In 1965**, it was discovered the ability of the Human Brain and, especially, of his subconsciousness, to detect directly the signals of broadcasting stations. The sensitivity to perception was enhanced by the ingress of substances with semiconducting properties into the bloodstream. They talked about "cryptography", "coding the brain and the subconscious", "digital thinking". Naturally, the special services were interested in the possibility of creating a technique for

uncontrolled, noncontact influence on the subconscious. And then the development of the method of psychotropic zombification and the sterilization of the population for political purposes was started.

The technology of acting on the population came to the fact that in residential units, bioenergetic generators were installed and connected to the TV antenna or to the lighting network, which operated day and night at a fixed frequency in the range of **1.4-2.2 MHz**. In Soviet radios this range was not available, and the radio signal could be detected only by turning on a Japanese mid-range radio receiver at that frequency. Specialists found that each type of modulated pulses corresponded to a certain **EMOTIONAL DISPOSITION**: depression, **UNCONSCIOUS FEAR**, indifference. Or, on the contrary, a sense of satisfaction, happiness, delight. It was possible to cause physiological sensations: itching, burning in various parts of the body, headaches of a different nature ... The impact of psychotropic weapons (through the created generators) that time caused a feeling of disgust for one political leader and sympathy for another one. This is one of the **METHODS** of **DIRECT PSYCHOTRONIC** impact for political purposes. While listening to the radio program, you could be coded by a series of special radio signals in favor of one or another politician. Their repetition alternated with impulses that evoke certain feelings and emotions. At night, during sleep hours, when the border between consciousness and subconsciousness is lost, this same series of signals was repeated to consolidate the assessment of the relevant politician.

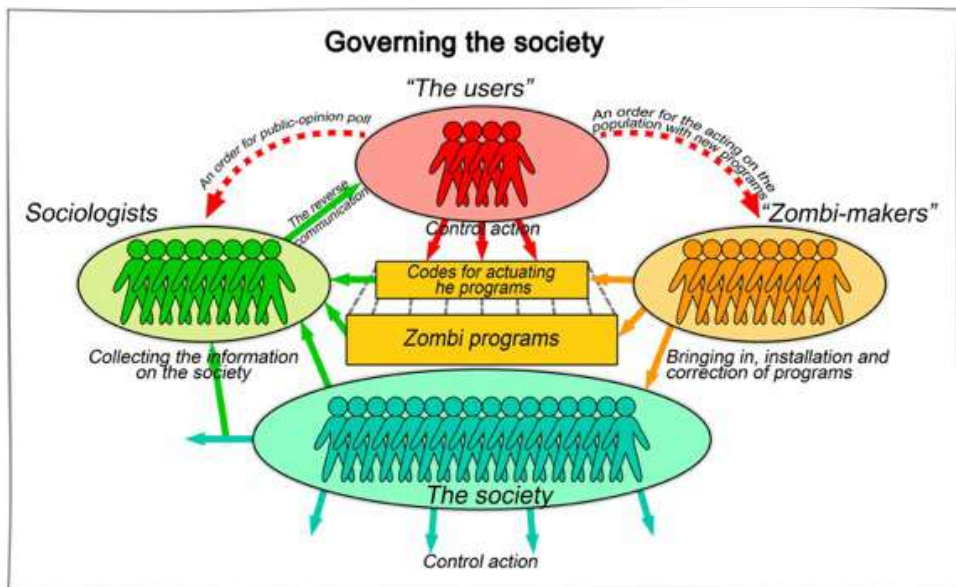

Exactly about those Generators, which were destroyed by **N. Levashov** he writes in the first volume of his book "**The Mirror of My Soul**". "There are many who remember the" fire "in the Ostankino Tower. **N. Levashov** writes about it in detail, and about many other things related to the "technologies" that he used to destroy those generators, including those located on the Ostankino Tower. Do not be lazy – read it. I can only add that the very physics of "destruction" of the Generators was later described by **A. Khatybov**, and on the basis of his calculations this technology is still "alive" and is applicable.

I want to emphasize that the "appearance" of these two Men at the same time and in the same place is absolutely **NON-RANDOM**, and their relationship that period could not be public. But it's not important (in this matter you can argue, agree and disagree). What is important is that these "technologies" exist today, and there are those who are able to use them. In confirmation, I just say that they were applied to the "executors" of the planned destruction of the **Airbus A321**, carrying 224 people (217 passengers and seven crew members). All information related to the "destruction" of this airplane, transmitted by various media – is **NOT TRUE**, to put it mildly. A deliberate lie in favor of politics. The plane was not shot down, not reaching the point of destruction 420 kilometers. It found itself "in the wrong place and at the wrong time" – where it should not have been. Similar "event" happened with **A-320** aircraft, which "crashed" in the French Alps in March 2015. Those who planned to bring down the plane over the Sinai Peninsula were in full combat readiness and "held their hand" on the "trigger". For this, they were punished so that there were only shoes left, and two live instructors (out of four) of the well-known Vanguard Corporation. They told those who had sent them about what they had seen with their own eyes and how it all had happened. This made an appropriate impression and caused the reaction, which the media did not know, and could not know. Here I put the points, as **N. Levashov** used to do with the information for which time **HAS NOT COME** yet. I am confident that soon the information hidden behind these points can be published.



.....

* * *

In April **1985**, Sasha Khatybov proudly stood at the door of the House of Industry. Instead of dismissal for absence from work, he got the salary for six months. And he was appointed deputy director of an "awfully" secret institution in Kiev. One of the authors of this essay Alexander invited to work with him. He depicted so bright future that one could feel "creepy". But at the end of April, Chernobyl happened. The secret institution for the development of psychotropic weapons urgently moves to Moscow.

At the same time, a certain Ilona was leaving the Soviet Union, who **A. Khatybov** strolled with all the night through until the morning along the Moscow River embankments. He was unusually talkative and ... a few years later on the shelves of supermarkets, there appeared cassettes with the rate of accelerated ***English language training by Ilona Davydova***. But, perhaps, not only with the course of English.

In **1986**, an acquaintance of A. Khatybov from Samara, a physicist M. came to Moscow for a visit. He knew Alexander well and what he was doing that time. The algorithm of the program developed by A. Khatybov, he did not know, but often discussed with him its possible application in psychotropic. Now we can say that not only the effectiveness of this weapon, but also the entire defense potential of the country depended on HIM, Alexander Khatybov. And if specifically, the speed of response in the conduct of massive missile strikes and protection from them.

This experience and calculations made by **A. Khatybov** were "used" by **N. Levashov**, creating **HIS "PROGRAMS"** for the destruction of psychotropic weapons and low-frequency bioenergetic generators that were "scattered" throughout the socialist camp.

Alexander Mikhailovich Khatybov, closely cooperated with **Alexander Deyev** in the field of development of psychotropic weapons. **A. Deyev** is a unique figure in our national science. A surprising and mysterious person was a Moscow aviation engineer. And he "passed away" in a very strange way in the year of **1992**. Once he gathered his friends and announced: "I'll die in 2 days". And it happened exactly that way.

Deyev invented a fantastic technology. Only application of his **IFG** (internal fuel generator) could bring the country a saving of 15-20 million tons of gasoline a year. This is just a minor part of what Deyev actually created. He opened a new field – **the D-field**, and his devices are the generators of the D-field. Deyev **wore a ring**, as he claimed, **with**

soldered pieces of the body of a crashed alien ship, which gave him a lot of potential to do much. And what he made, invented and realized – all worked, and worked with exceptional success. He used to say that his **D-field** is able to work wonders. He was sure that it is capable of transferring the properties of one object to another through vast spaces; is able to make water clean the lake of harmful impurities in just one glass and transfer these properties of water in a tiny glass to the whole lake, to all millions of tons of its mass; Generators of the D-field are able to eliminate radiation contamination of huge areas. About himself, he said that he had **MADE HIS ORGANISM FORTY YEARS YOUNGER**: that **he was able to cure cancer** and could make people healthy through their photos. Well, dear Reader, if you have read the book "The Mirror of My Soul" and got to know about the potentials of the "**SvetL**" Programs, created thanks to the works and "calculations" of **A. Khatybov**, who closely cooperated with **A. Deyev**, does it remind you anything?

D-Generators can make a clean sweep of weeds, considerably increase

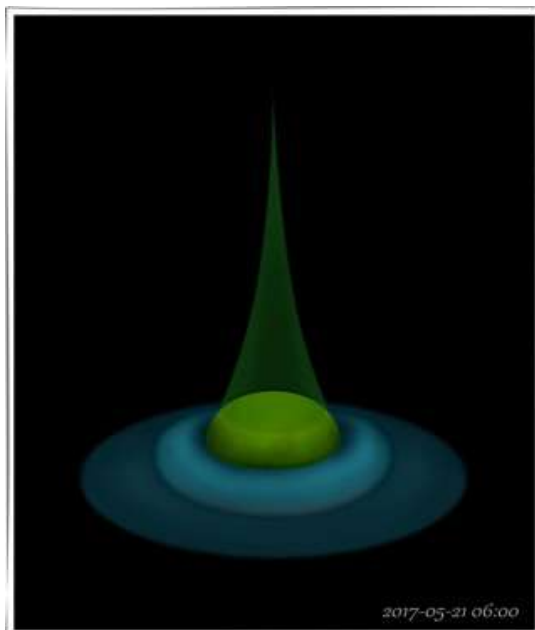

Interaction between the Generator and SvetL-Flora Complex

yields in the agricultural sector, in the latter case – by using the water processed by generators. They also allow increasing the productivity of livestock. Here I refer you to the second remarkable work of **N. Levashov** "[The Source of Life 1-10](#)", which he wrote as a "report" about the Generator's resources, and that was placed that time under his castle and the Man (himself), in "interaction" with plants and animals. Let me remind you that the **Programs for the Complex "SvetL-Flora"** were also created using the calculations of **A. Khatybov**.

After the death of **A. Deyev**, **A. Khatybov** created his own laboratory "**Rhythm Fund**", which developed "**Theories of Branching Systems**" (this scientific problem was then dealt with by only two scientific groups – **A. KHatybov's** and the Mandelbrot's group in the US), wrote several scientific papers, in particular, "**Real Time Mathematics**", "**Synergetics**", "**Cold-Plasma**

Synthesis". All works related to top-secret development of the military-industrial complex, since they were the basis for the creation of new high-technology types of strategic weapons. The availability of this weapon in the USSR allowed M.S. Gorbachev, to declare an "asymmetric response" to the US Strategic Defense Initiative (SDI), which led to curtailing the entire program of Americans who knew about these developments.

I did not set the task of studying and refining the details of **A. Khatybov's** autobiography in view of the fact that practically everything has been withdrawn and "cleaned" on the Internet and can not touch upon the formal moments of his biography, but I am sure that being under close attention of certain special services, he lived under conditions of everyday life and creative activity discomfort . From **B. Makov**, I knew how this amazing, uncommon and tireless researcher had been unprotected in the midst of worldly vanity. His sincere creative impulses **WERE OFTEN NOT UNDERSTOOD** in the official circles.

It is impossible to explain the reason for such a situation with simple words and images, but it has been going the way that the fate of almost all Geniuses excludes their recognition in their lifetime. **Alexander Mikhailovich Khatybov** (Morozov) was born on February 9, 1945 in the town of **Cherepanovo, Novosibirsk Region**. He got higher education in the most prestigious technical educational institutes of the country – Bauman MVTU then, in 1969, now the Moscow State Technical University named after Bauman. It is the first and one of the leading and largest technical universities in Russia, whose diplomas are highly quoted in Western countries. **Khatibov's** specialization was **mathematics, physics, chemistry, biology, medicine, celestial mechanics**.

I will give the most significant works and directions of **A. Khatibov's** activity for **Mankind** (I say it with full responsibility for my words).

Directions of his research:

- mathematics;
- physics. Unknown atomic structure;
- the golden section in an atom;
- Biology. A living cell. Principles of existence;
- medicine. Frequency balance of the human body;
- celestial mechanics. Calculations;
- noosphere. Habitat, gratings and conditions of existence;

His own development is used:

- creation of special formulas, physics of atomic structures, the musical table of chemical elements, etc.;
- mathematics "kaleidoscope" – 18-axis theory of symmetry (18 axes + 6 translations);
- the theory of prime numbers for the formation of frequencies of a living cell;
- golden section: phyto-functions of the golden section as the basis for the formation of a living cell (2 volumes);
- development of special formulas for celestial mechanics (example: value $y = \cos(x)$ for values $1 > x \Rightarrow 0.999999\dots$);
- the table of atomic structures and so on.

Those are his own developments used in "**SvetL** Programs and in everything related to these Programs.

Reasons for publications: the introduction of a different science, the formalization of the Earth Control System. Opening the section in mathematics – "Systemic Analysis and Operations Research".

Real-time tasks are solved:

- the traveling salesman;
- linear programming;
- destination.

Monographs:

1. Cold nuclear synthesis – 8 volumes.
2. Philosophy of mathematics – 1 volume.
3. The golden section – 2 volumes, 4 appendices including the Phyto-function of the cell.
4. Instruction on the Bath Science – 6 volumes, 1 appendix.
5. Control System – 3 volumes, appendix 1 – incoming texts, appendix 2 – answers.

The total **VOLUME** of printed **MATERIAL** (except for calculations) is **16.5 thousand pages**.

The versatility of this scientist **CAN NOT** but amaze and admire! And if you consider that most of the results of his research are not yet available to the majority, then how many other directions of knowledge emanating from this **AMAZINGLY CREATIVE MAN** still awaits us!

Five fundamental works of the author:

1. "Opening the principles of the action of genetic systems of multicellular organisms".
2. "Explanation of the principles of the Brain activity".
3. "Identification of the two-stage character of natural selection, which explained the mechanism of aromorphosis and the discreteness of biological evolution."
4. "The introduction of a new interpretation of the properties of neutrinos, radically changing the adopted model of the universe."
5. "Identification in the biochemical properties of the Earth organisms (in the genetic code, etc.) traces of the slow fundamental evolution of life in the Universe, with the multiple transfer of life by intelligent beings to the planets of younger stars."

You just **GO FURTHER INTO** the matter, at least, into the names of the works of **A.M. Khatybov**. They are not even known to modern science.

Of interest are the reviews to the works of **Alexander Mikhailovich Khatybov**. Note, how the bureaucratic academic circles with the deformed consciousness of the level of the dull partocracy expresses (or rather indicates) their opinions about the works of a talented researcher, unrecognized by them in the lifetime of this Genius, but so passionately eager to "snatch" a piece to themselves (not all, but many).

Think only of their wording.

1. **Nayashkov I.S.** (1986) – "...to close everything completely, strategic materials..."
2. **Sigal** (1984 CC of the USSR Academy of Sciences) – "...pass on all the materials to us for transfer to Israel..."
3. **Shankin** (1985, Chairman of the Scientific Council of the Higher School of the KGB) – "...wait until he himself gives us everything..."
4. **Chairman of the Scientific Council VNIIBT** (1986) – "...give everything to the academic council, and then we'll see what to do or who to send to..."
5. **A letter to the State Committee for the Inventions from Alexandrov A.P.** (1986, President of the USSR Academy of Sciences) – "If the author has also solved the problem of a traveling salesman, then this is the Nobel Prize".
6. **Marchuk G.I.** (1987, President of the USSR Academy of Sciences) – "...why do not you have co-authors? In the created scientific system, this is impossible... "

7. **Khachiyan** (1987, DFMN) – "Give me the principles of solving the linear programming problem, and the traveling salesman will be enough for you..."

8. **Maslyukov Yu.D.** (1987, Chairman of the Military Industrial Complex of the USSR) – "Has he not yet given all the materials to Semenikhin (NII AA)?"

9. **Kiyasov** (1984-1987, Head of the Department of the Military Industrial Complex) – "Hand all the materials to Krylov..." (Head of the Chair of the MIREA SAIIO).

10. **Krylov** (1986, Head of the Department of the SAIIA MIREA, DFMN) – "After handing the materials to the department there will be a decision to appoint you director of the" Institute of Man in Kiev."

11. **Nikitin A.N.** (1996, Chairman of the Noosphere section of the Russian Academy of Natural Sciences) – "Discoveries must be shared ..."

The list could be continued, but I think that's quite enough.

6.3. The Personality, we cannot do without ...

Sham Nikolai Alekseevich.

The story about Alexander Mikhailovich Khatybov would be INCOMPLETE without describing another legendary Personality and their cooperation. General N.A. Sham personifies the unique Russian spirit. The Man is a mine of information. His dossier is a step towards a new, clean, biological civilization, an escape from the deadly for the planet machine-chemical system, breakthrough into a new techno culture using the natural resources of the Earth.

Nikolai Alekseevich (born in 1940) worked in the KGB system of the USSR from 1966. Since 1974 he was in the central office of the committee. He got the rank of general in 1986. Later he was engaged in private business: one of the organizers of the company CINT (Center for Research in High-Tech Technologies), in 1999, he headed the Greenmaster Corporation, which



manufactured household appliances and various devices using defense technologies, then the chief director of ZAO the "First Leasing Company".

In 1991 he became the deputy chairman of the KGB of the USSR. In 1992 he retired for health reasons. This is according to the official version. But in fact, the reason for the resignation was a sharp conflict with then "democratic" head of the KGB Bakatin, who passed the Americans strategically important information and let out schemes for "wiretapping" the American embassy in Moscow.

It was under the cover of General Sham N.A. ANT business concern (Automation, Science, Technology) was working on several revolutionary trends in technology, engineering and other fields.

"The leading" genius was Alexander Khatybov, a mathematician from God, whom we introduced then in the ANT", the general said. – "In the US, billions of dollars of budgetary funds were spent on the creation of the newest generation of computers with a trillion of operations per second. Super-computers have already been called a wonder of the XXI century. And the domestic mathematics genius Alexander Khatybov fifteen years ago on a primitive, by today's standards, personal computer coped with tasks that required machines with an operating speed of thousands of millions operations per second". General Sham said that **THERE WAS NO** such a thing as speed limitation of computation for Alexander. Should Khatybov live in the US he would have become richer than Gates and would have been awarded several Nobel prizes long ago.

*"Alexander practically created **HIS OWN MATHEMATICS**, that made the experts **HAIR STOOD ON END**. If not to go into detail, **Khatybov's** method allows us to solve the most complicated mathematical problems ten times faster. For example, the famous "traveling salesman problem". It is classically difficult problem. Imagine that you are a sales agent, and you have to visit dozens of cities that are scattered around the map here and there. How to make an optimal route to visit each one, spending minimum of time on it? The more destinations, the more challenging the task. But Khatibov clicked on these tasks like seeds. We checked the efficiency of his system, suggesting that Alexander solve the problems over which the academic institutions had already racked their brains (naturally, without telling him that they had already been solved). The results surpassed all expectations: he coped with "the tests" in a matter of minutes, whereas it took traditional mathematicians days or even*

months to do it. That is, this Man could arrange a real revolution in the use of computers.

Through the KGB, it was possible to get an apartment for A. Khatybov and get a job for him in one of the institutions of the Academy of Sciences, which then plodded at the most difficult task of detection of nuclear weapons carriers with the help of space reconnaissance vehicles. But they did not want to notice him there, they did not give any work to him there, so Khatybov not only agreed to move to a new job in the ANT, but also brought with him some familiar inventors. Our idea to turn ANT into a center for the development of breakthrough technologies was supported in the 6th sector of the Council of Ministers of the USSR, established in 1988 under one of the government departments.

The principal task of this institution was the examination of large state projects: whether they should be implemented or not to. That time, the 6th sector was headed by **General Alexander Sterligov** (the father of a well-known businessman) and it was with him that we discussed the idea of turning ANT into an exemplary cooperative that is not engaged in primitive "buy-and-sell" and does not destroy home production but serves the development of the country.



We decided to take a risk, because the Soviet economy, under the influence of irrepressible "reformers", was already falling apart. The 6th sector of the Council of Ministers took over the business and prepared a government decree on the establishment of the state-cooperative concern ANT. And with it – the Board of Trustees, which included representatives from the State Committee for Science and Technology, the Prosecutor's Office, the Customs Service, the KGB and the State Committee for Economic Relations. I was a member of this council, too. The Revenues from these super-profitable operations were to be invested in the development of the breakthrough technologies that did not have world analogues. But everything has been ruined with the adventurism of former Sergeant Ryashentsev. Passing the Board of Trustees, he arranged a deal with the sale of ten T72 tanks from Nizhny Tagil. This ended in the rowing article in the communist Orthodox paper- "Soviet Russia" in February 1990. No one knew anything about the real tasks of the ANT, and a universal howl was raised. Communist newspapers

screamed at the brazen co-operators, while the democratic ones took it for the insidious machinations of the communist special services "privatizing" the country. And Gorbachev, as always, washed his hands. Then a grandiose investigation began in all seventy departments of the ANT. Prime Minister Nikolai Ryzhkov shed tears. Heads of numerous chiefs rolled along the carpet paths. And ANT perished. Not just a cooperative perished, but the first attempt to create a venture enterprise that could have helped to survive the economy of the USSR was disrupted".

At the same time, a Samara **scientist – biologist K.** stated that he was working on a project to **DESTROY** the **INSTINCT CODE**. The goal was the release of **IMMENSE INTELLECTUAL ENERGY**. He conducted experiments with dogs and wolves, in which he suppressed aggression and greed. There were also opposite results. At the private meeting of the department, the torsion field generator was demonstrated. These are two copper casings, connected in the base, surrounded by copper plates attached to them, and thick wires. This construction was switched on in the circuit and it began to work. So then the **PSYCHOTRONIC GENERATOR** looked like. But, as **A. Khatybov** proved later, it was a way to a dead end, because no one then knew the physics of energies, including intellectual one. To "rebuild" or readjust these "machines" was impossible, so **N. Levashov** considered that the most optimal way was to **DESTROY THIS EVIL**. And this was realized. I just want to emphasize that not all the psychotropic generators were then destroyed. Late, some models were restored and applied in different circumstances. Publications in the press show that experiments are being conducted nowadays that are encouraged by certain government circles, or rather, those who have already clearly expressed the complete absence of the Brain, but there is still an automatic desire, as they believe, to "rule the world". It's easy to see now the wish of some people to achieve the effect of psycho action on a large number of people. But what they are trying to apply from space, each time is of **NO SUCCESS** because of the impossibility of bringing the objects to space. These are **OTHER PROGRAMS** and another hisTORY.

Recently, on the territory of our country periodically there have been actions, or rather, attempts, of mass coding and zombification of the population. According to the Moscow Initiative Group of the Committee for Human Ecology and Housing, at least from **95 town and cities in Russia** they have received reports from citizens experiencing the consequences of psychotropic action. In the opinion of the citizens, the **REGIME OF IMPACT** was markedly strengthened before and during the elections to the

State Duma of the previous convocations and during similar large-scale events.

The consequences of such actions lead to the increased mortality, a high level of cancer, the birth of inferior children, a large number of suicides, especially among young people. According to the latest research of American scientists, long stay even in relatively weak electromagnetic fields leads to disruption of chemical bonds in the body cells. This ultimately leads to leukemia, Brain cancer and the prostate gland in men and to breast cancer, ovaries, and uterus in women. Recently, there are serious suspicions of special processing of water, tobacco products, chocolate, drinks, as well as sugar, milk, bread. This leads to ionization of tissues and blood of the body. Reduction of hemoglobin in the blood by 20-30 units, the appearance of micro-burns of the skin, rapid wear out of clothing; illumination of all photo materials – all this is thermo-electronic treatment. Unfortunately, this can not be stopped at a time, because the automatism of those individuals (no longer humans – I could not find another word) is still present.

Is there any protection and a way out of this situation? Yes, there is. They are the technologies that N. Levashov "developed" in his time, realizing perfectly well what was to be happening in the future, and the Programs that were created on the basis and with the application of these technologies and according to the calculations of A. Khatybov. ***Can we talk about this today? Not only can but we have to.***

I can say a little about the fact that Khatybov's group was engaged in "the annihilation of the negative alien (ebro) impact on the Earth." You can, of course, think of it with certain skepticism, but the works that **HAVE BECOME PUBLIC** nowadays, open your eyes to what was called (already in the past time) an "alien impact" and "biological control" of the Earth and Man.

I can hear from many people: "For a very long time we did not want to believe that Alexander Mikhailovich Khatybov wrote on his website," because he had long since directly claimed that the Earth was under biological control. This year (2016) we got (felt and realized) confirmation of this in various forms of events, ranging from climate disasters and ending with political events that began to affect and change the whole world before our own eyes. For example, observations of the hotspots of the Hartman grating indicate that over the past three years, it has begun to gradually disintegrate. Why disintegrate? The usual characteristic size of the Hartman grating (it is cellular) was about 2 meters. At the beginning of 2015, there

was a jump, and it increased to three meters. A month and a half after the first jump there was a second. It grew to 6 meters, in just a couple of weeks it increased in size to 9 meters. And I want to emphasize for the curious – at the same time **Airbus A321** “crashed” over the Sinai Peninsula, on board of which there were 224 people. It is getting very difficult to find now Hartman grating points. In the apartments in which we live (about the apartments and the Hartmann grating read in "[Knowledge from the Beginning](#)" I will not say it again) you might not find them at all. Moreover, they (these points) continue to vary very intensively. Practically almost every transition of polarization of the electromagnetic field is accompanied with the movement of this grating. That is, those who, apparently, really controlled all this information situation on the Earth, slowly begin to "go away." However, I'd like to say that today there are people, including N. Levashov's Friends, who I have mentioned, **CAPABLE** of **CONTROLLING THE STATE** of Hartman grating. I am grateful to them for providing me with information about this state and the changes that occur, which allows me to make corrections (sometimes substantial) and give certain recommendations to "**SvetL**" **Programs** users. I got carried away again. Although everything that I have written is interrelated.

6.4. Aspiration. And we will go on with Khatybov...

How to answer the question that today "torments" lots of minds: "If today we apply in practice what was written and said by **N. Levashov and A. Khatybov**, will there be any order in everything? Will there be an understanding of the ongoing events? And will it make it possible to put an end to our past and step into the **BRIGHT FUTURE?**" But, does it seem to you that you have heard something like that?

The old system always opposes people's new understanding the key points. It reacts to danger like a living organism. It is not important how true the new information is. It is important that it is dangerous. The truth for a living system is not that that corresponds to the facts, but that **ALLOWS** it **TO SAVE ITSELF**. The true information today is still not that is **TRUE** (the tragedy with the **Airbus A321** is an example), but that is **USEFUL** for the **SYSTEM**. The truth, in itself remote from this condition, is an abstraction. The formula is simple for the layman – "***If a lie gives life – it's the truth. If the truth bears death, it is a lie***". This formula was explained to me by N. Levashov, when we talked about practical application

of A. Khatybov's developments. "Let's apply the thought to the captain of the passenger ship," he said and went on "for him the main and the only aim is to take the passengers to their destination safe and sound. All the rest is lyrics. What contributes to the safety of passengers, is **THE TRUTH**. What interferes with the safety of passengers, is **A LIE**". Keeping this rule in your head, imagine – there appeared a hole in the bottom of the ship. It can be closed, provided that **NONE** of the passengers **KNOW** about the problem. If the passengers know about the danger, **THER WILL BE PANIC**.

EVERYONE WILL DIE. The truth of the captain is to hide the true information about the state of the ship from passengers. If someone accidentally asks him whether there is a hole in the ship, the captain must answer: "**There is no hole, everything is in order**". To keep his truth, the captain **HAS TO TELL A LIE**. Now we make the situation more complicated. On the ship there appeared a truth-seeker, informing passengers about what is happening. He says the truth about the state of the ship, which causes panic. It equals to his walking from cabin to cabin shooting people (the second option is even better, – people would immediately die without experiencing the horror of impending doom). What does the captain have to do? **TO MAKE** the truth -seeker **HARMLESS BY ANY WAY** – to arrest, throw overboard, shoot and so on. **Let it die one than everyone (including the truth-seeker)**. To maintain the truth, the captain has to not only lie, but also kill. "Now imagine," went on Levashov, "a social building where tens of millions of people live. If it collapses, most of the people living in it will die. The main truth for a senior in the building is **NOT TO ALLOW** collapsing the building. Everything else is an "instrument" for him".

To fulfill the task of introducing new technologies and perceiving **NEW INFORMATION** (from A. Khatybov, from N. Levashov and others...) adequately, we have to analyze the situation. This is like the situation when you are instructed to protect a nuclear power plant from terrorists. You identify key points and ways of accessing them. Further – ways of destruction. Based on the aggregate of data, you form the protection. It's the same with science, and with social construction – first identify the key points. But the point is **THE ONLY ONE** – the **WORLD VIEW**. If you "blow up» this foundation today and now – **EVERYTHING WILL COLLAPSE**. Then you have to comprehend and see the way that is able to utterly change it. A traditional bomb will not blow up the world view. **Only information is able to blow up the information**.

In what way has it been done for the last 2000 years? Having identified a strategic point in the construction, a security concept is being developed. From this moment **ALL EFFORTS** are focused on protecting the worldview. For those who "are engaged in it" (the Church, Academy of Sciences or the Commission on pseudoscience) it does not matter, whether the true worldview lies at the foundation or the wrong one. It is important that if it is broken in some way, the social construction is guaranteed to collapse. And it **CANNOT BE ALLOWED**.

In the USSR at least 3 times decisions were taken banning the criticism of the Relativity Theory:
1934 – resolution of the Central Committee of the All-Union Communist Party(bolsheviks) on discussion about relativivism;
1942 – resolution of the Presidium of the Academy of Sciences of the USSR on the Relativity Theory;
1964 – private resolution of the Academy of Sciences of the USSR banning all research groups, journals, chairs to adopt, consider, discuss and publish in advanced studies criticising the Relativity Theory of Einstein.

That is why the works of Alexander Khatybov and, to a lesser extent, N. Levashov's has been "wiped off". If written by Levashov could be taken in the initial understanding of the majority, for "science fiction", esotericism, etc., then Khatybov's writings were considered to be **DANGEROUS** with **SPECIFIC CALCULATIONS** and recommendation. But all these "protectors" of people from science and from the **NEW KNOWLEDGE** obtained thanks to these works did not take into account one thing – that the combined information obtained by "adding" (comprehending and combining) these works is like a nuclear bomb that can destroy **EVERYTHING**, if it is conceived and **DULY USED**.

Now, about the events ongoing before our eyes. If today's worldview had elite, then its truth would be the following – to preserve the foundation. Save it at any cost. It, this elite, would oppose the bearers of new worldview with the same fury as the Inquisition opposed dissidence. But their modern worldview, in accordance with what Khatybov wrote (and this is another clear example confirming the rightness of N. Levashov and A. Khatybov), does not have such strength. Its nothingness is manifested by the **NOTHINGNESS** of **TODAY'S ELITE**. We see this every day in the media and on the Internet. If, of course, we are able to see. This elite **NO LONGER SEES** the consequences of the dissemination of information that destroys the theory of eternal world, and therefore it is to be swept away soon. **But the principal thing is not to destroy the world.**

The processes are ongoing, similar to those that brought to the collapse of the Roman Empire (that has **NOT EXISTED** in the form it is presented

to us) or the Catholic civilization. What is now considered as a matter of fact values is ceasing to be so. The first open and serious blow was struck by Alexander Khatybov. **On March 31, 2010** an article by the well-known scientist Khatybov Alexander Mikhailovich was published under the title "**Is there science?**", where he particularly emphasized that **"there were many scientists who disagreed with Newton and Einstein who had been forbidden to criticize until recently!"**

Academician Vitaly Lazarevich Ginzburg, summarizing the development of modern science, brought out the main directions of the development of **physics in the 21st century. Its result is the modern science known to us.**

The created space, called science, where there is not even a hint at the structure of an atom, the structure of matter and actually the science. All attention is on dogmas (since 1964 they have banned to criticize Einstein).

"One can count on the fact that in the 21st century science will develop no less rapidly than in the past twentieth century. At the same time, physics has grown and differentiated so much that it is difficult to make out the trees behind the woods, it is difficult to grasp the picture of modern physics as a whole. Meanwhile, such a picture exists and, despite all the branches, physics has a "core". Such a "core" are the fundamental concepts and laws formulated in "Theoretical Physics" (**V. Ginzburg**) So, the list of "especially important and interesting problems" from the point of view of V. Ginzburg.

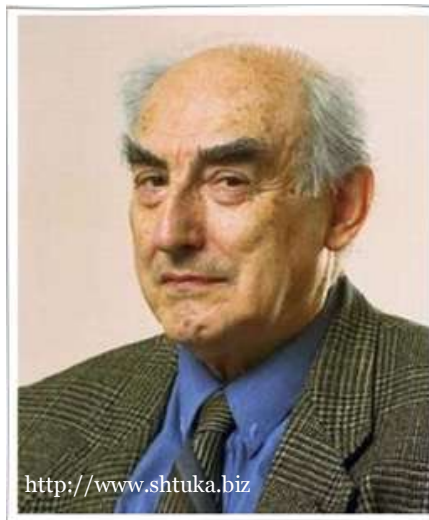

Macrophysics

1. Controlled nuclear synthesis.
2. High-temperature and room-temperature superconductivity.
3. Metallic hydrogen. Other exotic substances.
4. Two-dimensional electron liquid (anomalous Hall effect and some other effects).
5. Some problems of solid-state physics (heterostructures in semiconductors, metal-dielectric transitions, charge and spin density waves, mesoscopies).

6. Phase transitions of the second kind and related to them. Some examples of such transitions. Cooling (laser, in particular) to ultralow temperatures. Bose-Einstein condensation in gases.
7. Physics of the surface. Clusters.
8. Liquid crystals. Ferroelectrics.
9. Fullerenes. Nanotubes.
10. Behavior of matter in superstrong magnetic fields.
11. Nonlinear physics. Turbulence. Solitons. Chaos. Strange attractors.
12. Razery, grazery, super-power lasers.
13. Superheavy elements. Exotic kernels.

Microphysics

1. The mass spectrum. Quarks and gluons. Quantum chromodynamics. Quark-gluon plasma.
2. A unified theory of weak and electromagnetic interactions. W^{+-} и Z^0 -bosons. Leptons.
3. The standard model. Great unification. Superinification. Decay of the proton. The neutrino mass. Magnetic monopoles.
4. The fundamental length. Interaction of particles at high and ultrahigh energies. Colliders.
5. Non-conservation of CP-invariance.
6. Nonlinear phenomena in vacuum and in super strong electromagnetic fields. Phase transitions in a vacuum.
7. Strings. M-theory.

Astrophysics

1. Experimental verification of the general theory of relativity.
2. Gravitational waves, their detection.
3. Cosmological problem. Inflation. L-term. The connection between cosmology and high-energy physics.
4. Neutron stars and pulsars. Super new stars.
5. Black holes. Cosmic strings (?).
6. Quasars and nuclei of galaxies. Formation of galaxies.
7. The problem of dark matter (hidden mass) and its detection.
8. Origin of cosmic rays with ultrahigh energy.
9. Gamma-ray bursts. Hyper new.
10. Neutrino physics and astronomy. Neutrino oscillations.

To this list of "especially important problems" from the point of view of Academician V. Ginzburg, Khatybov makes a verdict in his article "Is there science?": Our modern science, that is, "horse science," still exists in the 21st century.



Now the opinion of the scientist Kuzichev Yuri Georgievich. "Is physics a science or a pseudoscience?"

Yuri Georgievich basically correctly noted the state of science, we are quoting his statements.

The substantive part of scientific knowledge about the nature of physics **was falsified**. Theoretical objective models were developed on the basis of **non-objective** information, but **subjective one** or **did not develop at all** and problems of natural science, as they said,

"bypassed" or "removed." Here are the traditional ways of "bypassing" and the resulting models:

1. Guessing and fiction (the primacy of the subjective over the objective):

- universal gravitation;
- movement of the planets by inertia in absolute emptiness;
- with the free fall of the body, its potential energy becomes kinetic;
- with oscillations of the pendulum, its potential energy turns into kinetic and vice versa;
- thermonuclear reactions on the Sun;
- Stars like gas balls;
- etc.

2. Substitution of studied objects with "black boxes" and development of their mathematical models (**primacy of form over content**):

- the law of universal gravitation, the laws of mechanics;
- laws of electrostatics and electrodynamics;
- models of the theory of relativity;
- models of quantum and wave mechanics;
- etc.

3. Obtaining subject models from mathematical (logical speculation, primacy of form over content):

- energy (a materialized mathematical parameter);
- the potential energy of the lifted body (a materialized mathematical parameter);
- time (a materialized mathematical parameter);
- gravitational, electromagnetic and other physical fields (obtained from vector fields of gravitational forces);
- curved four-dimensional space-time (obtained from the mathematical model);
- sinusoidal-cosine transverse electromagnetic waves (the axis of the angular argument of trigonometric functions is replaced by the axis of natural numbers);
- etc.

4. Wrong interpretation of the phenomena of nature and experimental results (***the primacy of the subjective over the objective***):

- the increase in the speed of free fall of bodies is explained as the result of the transformation of imaginary potential energy into kinetic energy;
- the motion of the planets is interpreted as a movement by inertia;
- the curvature of the trajectories of microparticles in the cloud chamber is interpreted as a consequence of the interaction of imaginary electric charges with an imaginary magnetic field;
- after the unsuccessful Michelson experiment, physicists refused to recognize the reality of the ether;
- many years of unsuccessful ***hunting for an electron*** led to the appearance of the Heisenberg uncertainty principle;
- the spectra of atoms are explained as a result of the leap of electrons-waves from one orbit to another, under which they allegedly emit photon waves;
- energy exchange of objects through flows and ether waves is interpreted as energy exchange using quanta of physical fields: gravitons, electrons, photons, etc. ;
- etc.

5. Development of new models based on previously developed (logical speculation, primacy of the subjective over objective):

- Gravitons, magnetons, electrons, photons (quanta of imaginary physical fields);

- models of planetary atoms (built of electrons and protons supposedly possessing electric charges);
- strong interactions (they keep the protons repulsing from each other in the nuclei of atoms);
- the waves of Schrodinger and De Broglie (reflect the imaginary corpuscular-wave dualism of electrons);
- the quantum of action (Planck's constant) and the Pauli exclusion principle (appeared when physicists adjusted the hypothetical planetary model of the Nagaoka-Rutherford atom to nature);
- valence electrons (supposedly bind atoms to molecules);
- free electrons (supposedly form an electric current);
- van der Waals forces (allegedly retain in the crystals electrically neutral atoms and molecules);
- Black holes (appeared as a result of the manifestation of imaginary universal gravitation);
- etc.

6. Substitution of the phenomena of nature by imaginary (supposedly equivalent) phenomena (the primacy of the subjective over the objective**):**

- the energy exchange of the Sun with the planets and the effects of the forces arising from this are replaced by the influence of universal gravitation, the gravitational field, curved space;
- longitudinal waves of elastic deformation of the ether are replaced by transverse waves of the electromagnetic field;
- the energy exchange of the Earth with a freely falling body is replaced by the transformation of imaginary potential energy into kinetic energy;
- energy exchange of objects through flows and ether waves is replaced by energy exchange by means of quanta of imaginary physical fields: gravitons, electrons, photons, etc .;
- the change in the rate of evolution of microparticles (mu-mesons) at sublight speed is explained as a consequence of the change in the course of the personal time of microparticles;
- etc.

7. Models of theoretical physics do not reflect the causes and mechanisms of gravitational, electromagnetic and other interactions, therefore are useless for natural science, in other words, have no scientific value.

8. However, models have practical utility, therefore (based on the principle of ***practice is the criterion of truth***) were taken for **absolute truth** and transferred from theory to nature. As a result, physicists created their own imaginary world.

Jonathan Swift, in his time, ridiculed **Ptolemy and Newton**, having told with his Gulliver's lips about the simple-tongued Laputians, who, ***forgetting about the real world, lived in their own worlds.***

9. Physicists still live in their worlds- they study phenomena and objects that they themselves have invented (*quarks, strings, relative time, physical fields, black holes, large explosions, etc.*) or were artificially produced by atom crushing on accelerators, while the **real nature REMAINS UNKNOWN.**



The results of physics

The modern physical picture of the world resembles not even a patchwork quilt, but a bunch of **INCOMPATIBLE** flaps.

Not explained (or explained incorrectly):

- absolute motion and absolute energy;
- mechanisms of gravitation and repulsion;
- the device and solid rotation of spiral galaxies;
- the source of thermal energy of the Sun, cycles of solar activity, differential rotation of the Sun, Jupiter, Saturn and Earth;
- movement of the Moon, the Earth and other planets;
- tides, tidal and seasonal currents and winds, including monsoons;
- free fall of bodies and oscillations of pendulums, increase in the energy of freely falling bodies and the source of this energy;
- the emergence and construction of nucleons and their unification into three-dimensional systems – atoms, molecules and substances; chemical properties of atoms, molecules and substances;
- thermal, light and other waves; polarization and other properties of waves;
- physical properties of atoms, molecules and substances, including hardness, elasticity, heat capacity, thermal conductivity, thermal

expansion, aggregate states of matter, anisotropy and magnetism of crystals, attraction and repulsion of permanent magnets;

- the nature of the electric current, the thermal and magnetic effects of the current, the resistance and superconductivity of conductors, electromagnetic induction;
- causes of radiation and decay of atoms;
- long-term preservation of atomic energy in atoms, and its mechanical essence;
- etc.

What is physics?

To call physics the science of nature there is **NO SUFFICIENT** bases.

The methodology is a mix up. The metaphysical method, which permits the substitution of real phenomena for imaginary ones in solving problems, is transferred from applied physics to fundamental physics. Philosophers call it "**a new dialectic created by physicists themselves,**" and physicists themselves (see *A.B. Migdal* "Quantum Physics") divide it into Einstein's dialectic, Bohr's dialectics, etc. The difference between these "dialectics" consists only in the fact that Einstein ed **invented** only mathematical models of imaginary phenomena of nature, and Bohr – mathematical and subject ones. Physicists have heaped up fundamental theories that must reflect the structure of nature, and pseudoscientific theories that are, at best, suitable only for solving applied problems, and all these theories began to be submitted as results of natural science. Because of this, even **in theories there is confusion.**

Here are some examples:

- in the Berkeley course of physics, it is asserted that there is no absolute objective motion (relative to the ether?), since it was not possible to detect it, and in theories the speed of movement appears as an objective reality;
- energy is considered a measure of the motion of matter (relative to what?);
- relativistic effects are considered to be the consequence of motion with sublight speed (relative to what?);
- the law of inertia says that the body moves in a straight line and evenly (relative to what?) in the equilibrium of all the forces acting on it, and in the solar system, where, according to the theory, the gravitational forces

are balanced by centrifugal forces, the planets inexplicably fly in inertia curvilinearly and unevenly;

- the potential energy of the same body is considered positive (when the body falls to Earth) and negative (when the body orbits around the Earth), although energy, as a scalar mathematical measure of motion, can not be negative; as a consequence, the total energy of a body flying past the Earth along a parabolic trajectory with a second cosmic velocity turns out to be zero, since its kinetic and potential energies are equal and opposite in sign;

- according to theory, positive and negative microparticles should be attracted to each other and annihilate, however in atoms and substances electrons are not attracted to protons and do not annihilate;

- waves of the electromagnetic field are considered identical to the microparticles moving in the void (*the particle-wave duality of electrons and photons*);

- wave electrons inexplicably fly around the atomic nuclei, jump from one orbit to another, emitting and absorbing photon waves, bind atoms to molecules and form electric current in conductors;

- when atoms are fragmented (on accelerators), uncountable fragments are obtained, in the classification of which a confusion arose; Nevertheless, physicists are trying to explain the structure of the universe according to these "brick fragments".

Refusing to develop subject models and naming mathematical models by physical theories, "... physicists have sunk into the hazy atmosphere of matrices and wave mechanics, into mathematical operations. They made the right conclusions, but at the same time they did not understand the physical reality behind them." (Max Planck).

A famous theoretical physicist, Nobel Prize winner **Richard Feynman** for many years was engaged in the popularization of physical theories, but he also did **NOT AVOID** doubts about their scientific value and honestly spoke about this at his "popular" lectures. Here are some excerpts from the lectures: "Gravitation could not be associated with the laws of motion.. It can not be explained by any other phenomena ... Quantum physics is a monstrous confusion... **NO ONE UNDERSTANDS** why nature is so arranged ... There are no good theories to explain the structure of nature." (The same thing was written by **N. Levashov**).

Judging by the methodology and content of the theories, physics has been developed as an art of solving applied problems, that is, as applied mathematics (*mathematical physics*), and, calling it the science of nature,

physicists mistake the wish for the reality. Our civilization in the **COGNITION** of **NATURE** has come to a deadlock, and to a large extent, the main ideologists of physical science – **Newton, Maxwell, Einstein and Bohr are guilty of that**. Such an impartial picture of the state of physics was given by another scientist, **Yuri Georgievich Kuzichev**. He noted that the results of physics were sad, and there were no sufficient grounds for calling physics the science of nature. And **AM. Khatybov** in the article writes that Yuri Georgievich, in the main, correctly noted the state of science.

Let's consider the question of the existence of science from a different point of view. As the author of this book I will introduce a small supplement for a correct understanding, of what Khatybov writes further in his article, covering this question.

Our planet the Earth, as a **CERTAIN SUBSYSTEM**, enters a more complex solar system and is part of its governing system, once inculcated by the Supersystem to protect life from accidental factors. **Human civilization is governable**. Up to now, two such systems are known: **The original (Native) and Interventionist Earth Control Systems. (2011.04.24** on the Earth there was a change of the Control System – the Interventionist Control System was switched off and the Native Control System (NCS) was again switched on).

We have the Earth Control System, which includes several Control Complexes, stationary monitoring systems and objects (UFOs). All this is interconnected not only among themselves, but also with the Sun, the Moon, the satellites of the planets. The aim of the Control System is to **CREATE** the **BIOSTRUCTURE** that fully meets the requirements of the Program. To solve this problem, all conditions have been created, except one – *no structure has to interfere with the **operation of the Control System***. Therefore, the world perception is given in a distorted form and, first of all, it concerns atomic structures and the principles of creating the universe. Instead, a partial instrumental base (mathematics) is given. The entire development of science is the development of mathematics and modeling without practical meaning. At the same time, science does not (and can not) solve **NP-complex and NP-difficult** problems (problems from the class **NP**⁴⁰ in the theory of algorithms), missed the "golden section", without

⁴⁰ **NP-complete problem** – in the theory of algorithms, a problem with a "yes" or "no" answer from the NP class to which any other problem can be reduced from this class in polynomial time (that is, using operations which number does not exceed some polynomial depending on the size of the initial data).

which one can not approach the elementary atomic structure. Further – technical information is provided, but only a few correctly perceive it and only under certain conditions create real products. This is available only to those who have a connection with the Control System. **Let us recall some of them.**

1. **Leonardo da Vinci.** Overtook the development of the technical base for more than 400 years.

2. **Nikola Tesla.** A genius whose works anticipated the most fantastic thoughts of scientists.

Present day personalities:

3. **Burlachenko Arnold Ivanovich.** Having not-complete secondary education, he developed the theory of sound and created dynamics that surpassed any known samples in quality.

4. **Deyev Alexander Alexandrovich.** Radio engineer. He received from the Control System drawings and principles of using the devices created by him. He created the theory of the D-field. Later, the "participants" renamed it "Spinor", and when Akimov dragged away one of the devices, it became "torsion". However, having no connection with the Control System, everything that they tried to use without Deyev is Krylov's fable "the Monkey and the Glasses".

What is the peculiarity of this list? ***None of them got into an atom, that is, did not create new theories, but their technical realizations puzzle the whole of modern science.***

So, we have:

- the top of the pyramid – mathematicians creating pseudostructures;
- Single geniuses, there are few of them, and they all receive only what can really be realized;
- creators, businessmen, and other research figures. Here everything is collected – from criticism to the creation of their own theories.

So, as soon as the "dynamics" appeared, there came into being etherodynamics, rhythmodynamics and so on, by analogy with the fact that

Thus, **NP-complete problems** form in a certain sense a subset of "**standard**" **problems in the NP class**: if for some of them a "polynomially fast" decision algorithm is found, then **any other problem from the NP class can be solved just as quickly**".

as soon as a virtual memory "appeared in the computer," virtual killers "appeared in movies.

What is the brake on the development of science? – Once again I say – **World perception!**

The point of view of science on the material (and intangible) world: **solid body → liquid → gas → unorganized plasma.**

Atomic structures, naturally, are searched in a solid body, for which they create synchrotrons, colliders. The same will happen if in the orchestra pit during the performance of the symphony throw a bomb and after the dust is settled to reassemble from the remaining grains all instruments and orchestra. It is this science that it is offered to get down in the XXI century!

Let us consider a different point of view. **Strictly organized plasma → material structures (solid, liquid, gaseous).**

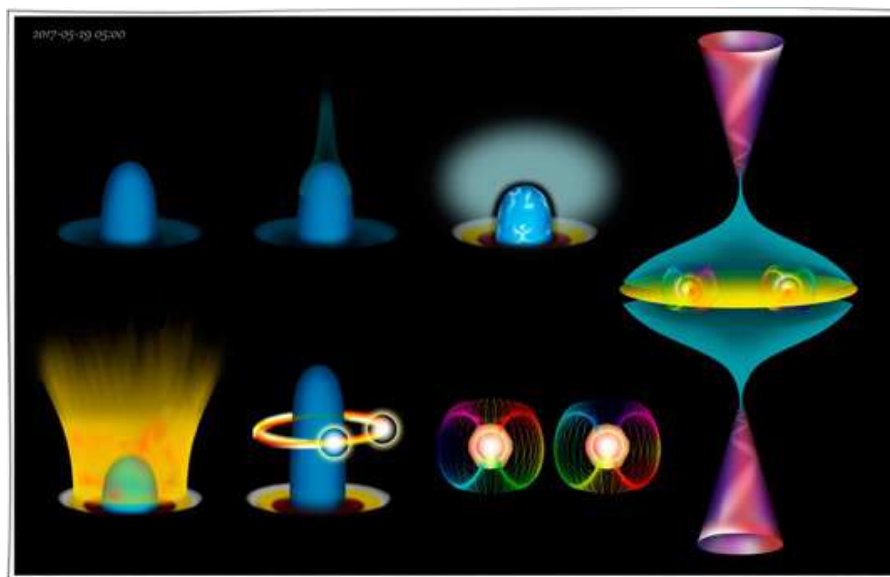

Atomic structures should be considered only in the upper octaves of the plasma. The Control System has a k-structure today; all the gratings are built on cubes (in organic chemistry the cube is converted into hexahedron).

Octaves	Description
128	The tact interval. It is given by the Sun, it is taken for the speed of light
78-126	Control systems, storage of humanoids and "poltergeist"
74-76	Control systems for all insects
72	The brain of the "golden million", genotype 461
68-70	The brain of the "golden billion", genotypes 441, 442
66	The brain of the rest of the world's population, genotypes 421, 422, 423
64	Upper octave of material structures

62	Control of material structures during transmutation
40-60	The energy corridor (Tesla worked with octave 60)
34-38	Corridors of "o-transitions" after death
30-32	Complex mixtures (oil type)
24-28	Water
16-22	Gas

Modern science is able to work (and create technical devices) **NOT ABOVE 64 octave**, all kinds of instruments can not be created above 64 octave. **Anything above 64 octave is a non-inertial mass, that is, there are no gravitational frequencies there.**

The basic atomic structure is 128 octave, and if it is "plucked", we will reach 64 octave. Until **2012** the Control System consistently passed first **to 224 octave, now – to 512**. But even at a tact interval of 224 octaves, the speed of light will be billions of times more. What will change in this case, we will consider later in the example – "how the Earth's axis affects the bank account".

Science clings to the theory of the Big Bang, quarks, metallic hydrogen (it can not be, because there is still a non-inertial mass of tritium), Darwin's theory (or alternative – divine) like a drowning man snatches at a straw.

Direct evidence of the absence of science is the presence of the church. How many church miracles science has explained? Start with the holy fire at Easter.



Afterword

- The Cosmos exists without the Big Bang;
- The Earth, planets are artificial structures, had been created for more than 16 billion years;
- Man is the highest creature, had been created for tens of billions of years;
- a monkey – human humanoid;
- the whole animal world, insects are created to control the Human frequencies;
- radioisotope method can not serve as the proof of antiquity;
- the moon, the Sun, the satellites of the planets are alien structures.

Ufology is not a science, but a collection of statistical material (and without any sense).

The Control System removed some frequencies from communication tubes with satellites, and astrology, as a way of obtaining information, can be forgotten.

A. Khatibov's article "Is there science?" in "scientific circles", as I have already said, triggered the reaction of a bomb that exploded. It is not difficult to guess why. However, the movement of the Mind is impossible without releasing from the excess of memories and controlled unconsciousness. It **CANNOT** go on like this endlessly. It is impossible to grasp the immensity and reconcile the uncoordinated, relying on the "scientific baggage" that A.A. Khatybov so skilfully criticized. He, as a plastic surgeon, had to "cut through the living", **GUTTING THE BRAINS OF ACADEMICIANS** and removing the corpulent tissue for the sake of a new understanding and a new philosophy, and also the physics of processes, having perceived which one can move forward.

I am sure that the rejection of the previous experience (and especially in science and technology) is an indispensable feature of the true philosophizing in this direction. But in order to **REJECT**, first it is necessary to **UNDERSTAND**. To understand in order to **UTILIZE**. Of course, this path is not without risks and is fraught with certain costs in the form of amateurism, nihilism and philosophical childishness. But I always thought, taking the example of both A. Khatybov and N. Levashov – that the path of dutiful dogmatism and the **EXALTED PUPILLAGE** would surely lead to a dead end, and therefore **ABSOLUTELY UNACCEPTABLE**. I got convinced in it not once after N. Levashov was gone.

Practically all the works of A. Khatybov, as he himself wrote, and I know that it was exactly so – were the ***deciphering of texts received as an explanatory basis for analyzing the current situation and for carrying out certain calculations on "requests» of the Control System*** so that to identify the program functions performed as they are implemented. ***Alexander's first acquaintance with it took place in 1995***, when the screen of the computer on which he was working, turned (was turned by the "invisible force") by 180 degrees and there was a running line with the text that carried the information. The data was provided by the Earth Control System.

B. Makov witnessed this "transmission». Here's what he told me about it. Being a friend of A. Khatybov, he often came to see him. At a certain time



(in the evening) Alexander took a thick pack of writing paper and a pencil. He sat at the table and for a while just **DID NOT REACT** to anything that happened around him. He wrote on sheets of paper, non stop, dropping these sheets on the floor. It seemed that he **DID NOT UNDERSTAND** what he was writing. He just mechanically reproduced on paper that information that was "transmitted" to him, without delving into its essence. Boris said that after the beginning of this action, he could not be in the apartment. His brain was just bursting with tension and he ran out

doors. It only proves that the information is personified when it is transmitted (imbedded) to specific people depending on the task being solved. The next morning A. Khatybov put the sheets together into a pack and sensibly got down to processing the information.

THE INFORMATION COMMUNICATION with the System until the fall of **1995** was of a one-sided nature without the elements of any technical support at the stage of direct reception from it. The Brain potentials in receiving information are still limited, no matter how it is thought of. **By autumn 1995** A. Khatybov developed a software product that allowed deciphering all the information from the True Earth Control System. Later, after approbation of the developed product and application of the **SERIES** of **TECHNICAL EQUIPMENT**, A. Khatybov's developments of certain skills in "interaction" with the System, the communication became stable and bilateral both direct transmission of information and information on the "question-answer" scheme». This allowed A. Khatybov to receive confirmation for the calculations that he had already made, and move forward far away, unlike "modern" scientists and science.

It should be noted of the peculiarity of that not distant time, – the Interventionist Control System was in a **GOOD WORKING CONDITION**, and its Control System held under rigid control all the reality. Any manifested fragments of out-of-system information, unauthorized on its part, were subjected to liquidation together with the bearer. It is clear what kind of danger Alexander Mikhailovich was exposed to. Only **in 2012-2013** I began to realize what was happening at that time (in those "evil nineties"), why I found myself participating in this or that

event, what those events were aimed at and what was achieved and accomplished, including "through" me, as one of the rather high Russian federal official of that time. Everything happened exactly as it should have been, without any regard for human emotions. Was this realization important to me? Of course, it was, precisely in understanding those events, because today the work related to getting a contact state with the Earth Control System is taken as a **COMMON WORKING PROCESS**, but in reality it is beyond the scope of fantastic imaginations. And the real merit in this matter belongs to the true geniuses – **A. Khatybov and N. Levashov!**

We are now talking about the New Control System. And in the framework of the old system, this was done somewhat differently, through the so-called **"ENLIGHTENING"** of a **SPECIFIC PERSONALITY. D. Mendeleev** "woke up" and drew (wrote) his table, the application of which has brought Mankind to where we are all now! Being in Switzerland (Alps) **V.I. Lenin** suddenly as from the "horn of plenty" began to "pour out" articles and works, and also got oratory abilities, which led to what is called the October Revolution". K. Marx, being quite an ordinary individual, suddenly wrote a genius work **"Capital"**, thus legalizing the revolutionary ideas, later "picked up" by Lenin, but, most important, he legalized and "inculcated" into people's heads a **SURPLUS VALUE** as a tool for **ENRICHMENT** of **DEFINITE PEOPLE** (a certain genotype of the Brain). I was on friendly terms with **Mstislav Rostropovich and his wife Galina Vishnevskaya**. Once, visiting Kronshtad, we talked about music. **Rostropovich** told me about his friend, composer **Alfred Schnittke**, who when asked what the way was to learn to write such beautiful music, said: "No way. It's not me, Mstislav, **I AM WRITTEN BY...** " That time, I was also visited by so-called "insights". It was both the idea of creating the **Public Chamber of Russia**, which was voiced to President Boris Yeltsin on the example of the Public Chamber, which I created in Leningrad Region, and the "division" of Russia's territorial structure into federal districts. To be true, I justified the division into **12 districts**, taking as a basis the dislocation of troops on the territories. With the arrival of the "new" government, this **PROJECT WAS TAKEN** as a basis, but the division was first in **7 federal districts**, and then the **8th district** was added. Until now, I **DO NOT UNDERSTAND** why that was "done" that way and the reasons for this could not be found that time either. One thing eases my mind – the fact that it was done within the framework of the "plans" of the old System, with a certain goal already known today, and all this just did not take

place and it **NEVER WOULD**. And there are many such examples. To be true, the question of the Bath, Spade and Broom did not exist then.

A. Khatybov was given in detail the material to solve the main task of the System – the so-called traveling salesman task (on this basis he developed algorithms and programs for solving problems from the class of "System Analysis and Operations Research"). **The Programs** created and calculated by Khatybov are used to calculate the control options for the **MATRIX BRAIN** with the dimensionality of the **problem 512x512**. All this is set forth in his work – "Instruction on Bath Science" (6 volumes, 1 appendix), which is practically inaccessible nowadays. When I "closely got engaged" in "**SvetL**" **Programs**, their modernization and creation, I applied A. Khatybov's calculations, whose special attention was turned to the **GOLDEN SECTION** as the basis for constructing all structures on the Earth. New types of Program functions have been created. Calculations on transient processes have been made, atomic schemes, their structure, interrelations and principles of formation of both the biostructures and the processes taking place in them, under the control of the Brain in interaction with the Generator and its Programs ("SvetL" programs) have been obtained.

The entire frequency balance of the world around us and all biostructures is **BUILT ON PRIME NUMBERS**, each containing *more than 19 digits in the 10th number system*. Khatybov obtained a series of prime numbers to control all major changes made under the Program. This was important, because changes that affected almost the entire Life Support System on the Earth had already been launched and implemented.

There is practically no area where "through" the information received by A. Khatybov there **WOULD NOT HAVE BEEN** affected the interests of identification with modern science, beginning with mathematics, physics, chemistry, biology, medicine, psychology, celestial mechanics, etc. Knowing this from various sources, I came to the conclusion that the **INFORMATION HAD BEEN BEFORE** the space, energy, matter, time and all forms of existence that once began to exist. We **ARE NOT ABLE** to think of what it was, but it turns out unequivocally: **INFORMATION PRESEDES** every existence, at the same time not being anything out of the existing.

I will cite several **Laws**, defined by A. Khatybov, as reference points for the movement in cognition (there is no way to cite all of them today). They are called: "**The Laws of Maxim.**" There are many who ask the question: "Why Maxim's, not A. Khatybov's?" The laws that A. Khatybov set

out and substantiated are those that he created, and named in honor of his son **MAXIM**.

In total, there are 36 Laws and 192 corollaries.

Laws of Maxim on Movement

The first law of Maxim on Movement.

The mass is inert only in the absence of an electric potential.

The second law of Maxim on Movement.

The sum of the electrical potentials in its octaves is always zero. Example. Lightning moves not by a random trajectory.

The third law of Maxim on Movement.

Any violation of the conditions for the existence of a magnetic pulse in a living cell causes its death with a redistribution of the electrical potential (this is confirmed by the experiments carried out by V.I. Dokuchaev).

The fourth law of Maxim on Movement.

In a non-inert system, the time of motion is always accurately related to the difference between the accumulated negative electric potential and the limiting (negative or positive) electric potential in its octaves

The fifth law of Maxim on Movement.

The gravitational partial of the non-inertial body is always zero.

The absence of resistance of the electrical potential (of one sign) leads to a non-inertial mass in motion, limited only by the ultimate (of one sign) vacuum resistance. If the electric potential of the medium of motion has the opposite sign, with respect to the sign of the electric potential of the non-inertial mass, then the potentials are summed.

The sixth law of Maxim on Movement.

Movement makes the sound which tone corresponds to a tone of the spent electric potential. The pitch of the sound depends on the current value of the electrical potential of the non-inertial mass.

The seventh law of Maxim on Movement.

The time of motion is determined by a small octave. Its electrical potential can not be used in any other way than for organizing traffic.

The eighth law of Maxim on Movement.

The space of motion is determined only by the gravity-magnetic contour of the Cosmos. The gravity-magnetic contour of the Cosmos has a closed volume, and no object can leave it.

The radius of the gravity-magnetic contour of the Cosmos is $10728 C$ (C is the pulse speed at **48.5** octave in the Earth's magnetic field).

The ninth law of Maxim on Movement.

The magneto-electric motion field is formed by the gravitational field of a given frequency, therefore it is sufficient to have a gravitational generator at the using activity. Gravity-Magneto-Electric Generator (small power) serves to move to an adjacent space.

The tenth law of Maxim on Movement.

The total energy mass (including non-inertial) should not exceed the energy mass of the launch complex (for example, the Moon). The electrical potentials of inertial bonds are recalculated into **56.5** octave and can not be used to form a cone of superposition of gravitational frequencies.

The Eleventh Law of Maxim on Movement.

In cones formed by gravitational generators of at least two non-inertial masses, completely inert masses can be located, their electrical potentials converted into 56.5 octave should not exceed the electric potential for the formation of cones.

The twelfth law of Maxim on Movement.

The non-inertial mass of the various electric octaves of the state during motion must not have a separation more than the value of C of the adjacent octave. The value of C is in the eighth law.

The maximum separation of the non-inertial mass during the movement is **32 C**. Explanation: Each **NON-INERTIAL** mass (of its octave) moves independently.

Corollary 1. Each cosmic object possessing a non-inertial mass has its own lifetime.

Corollary 2. The inertial mass has a lifetime determined by the density of the charge equivalent of the bond of the ionic structures.

Corollary 3. For a non-inertial mass, the decay time is determined through the decay rate of the highest octave of the bond frequency. (When the spacecraft moves without a magneto-electro-gravitational generator,

THE BRAIN is **LIQUIDATED** first and foremost, and the last is the casing.

Corollary 4. Any non-inertial mass has a magnetic field, and the decay rate of the magnetic field is determined by the time.

In conclusion, let's consider the effect of mass ejection, or jet motion.

The constructions using a different method of producing jet thrust, other than the Laval nozzle are unknown. But in the ancient drawings we see images of astronauts in ships that exclude the use of the Laval nozzle. Taking into account that the additional term of the well-known formula is used in calculating the Laval nozzle, this imposes a ban on the use of other principles for obtaining reactive thrust, and the specific impulse is in the range of 300-440 seconds.

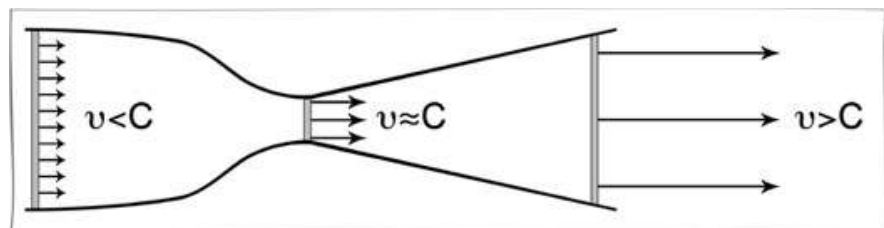

Using the Ranke effect, it was possible to calculate a construction without the Laval nozzle with a specific impulse **of 8000-32000 seconds**. How much this changes the construction, the control system, and also increases reliability, one can only assume. The first samples were successfully tested in 1988 and on the recommendation of the 6th sector of the USSR Council of Ministers (V.V. Babayev) left for the USA where a laboratory was immediately set up. In Russia, this direction was liquidated, but in the United States they were not able to figure out the effect without the author's attendance.

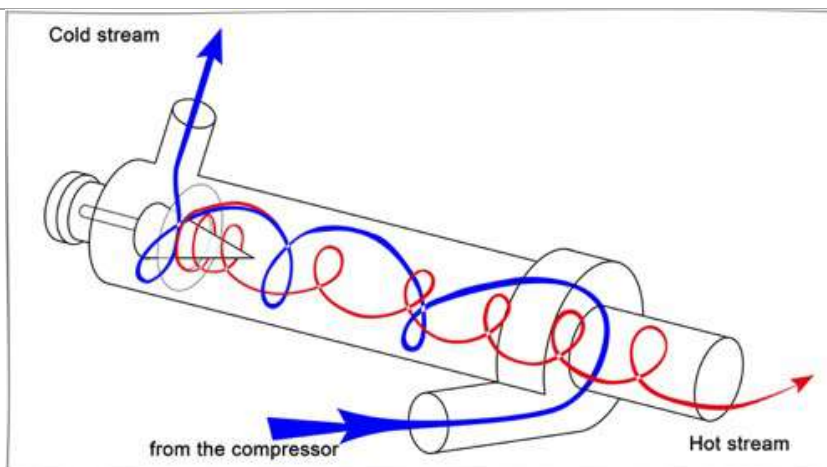

The use of other principles (such as the Meissner effect) **IS NONSENSE** – without knowing the real constants, the structure of the atom, and also **Maxim's laws**, external effects can not be the basis of motion, especially *when using Bohr's physics and Mendelejev's table*.

There is also **MAXIM'S TABLE**.

If we say briefly about Maxim's table, then this is a **grating from 12 to 256 octave** of all possible connections of structures for all types of fields and their interactions. In total one can get 1064 elements out of Maxim's Table, differing at least by one sign. In accordance with this, for example, **Vacuum** is a medium having quite specific energy characteristics. ***Movement in a vacuum without gravitomagneto-electric generator is like movement of chalk on the blackboard,- does not take long.***

Temperature. The electrical potential value at certain value of the phase-change parameter.

At an average point (parameter), the maximum temperature is 6428°K. Until 1995, this parameter for the atmosphere was at the midpoint. If we take zero reading of the electric potential, then the shift to the positive area leads to fires (not the closure of the electrical wiring), and *the shift to the negative leads to the transformation of any material into the sand ...* (Recollect the deserts and "punishment" for the planned Sinai catastrophe).

A. Khatybov's albedo is understood **NOT AS** the reflectivity of a substance, but as the **DIFFERENCE** of the **VALUES** of the energy potentials of the structure under consideration (the property of changing the electric potential under the action of a magnetic pulse and a gravitational

wave). That is, everything is interconnected and completely different from what modern science "explains" to us.

All these A.M. Khatybov's works were passed to the Academy of Sciences with the support of academicians A.P. Alexandrov, G.I. Marchuk and Yu.S. Osipov. But the chairman of the State Property Committee I.S. Nayashkov **DID NOT RECOMMEND** the Committee to make public the works due to their strategic importance. President M.S. Gorbachev was reported about the work, who at that time was too far from it. The works became known to the military-industrial complex under the USSR Council of Ministers. Their attendance was entrusted to the 6th Department of the KGB of the USSR (personally to N.A. Sham).

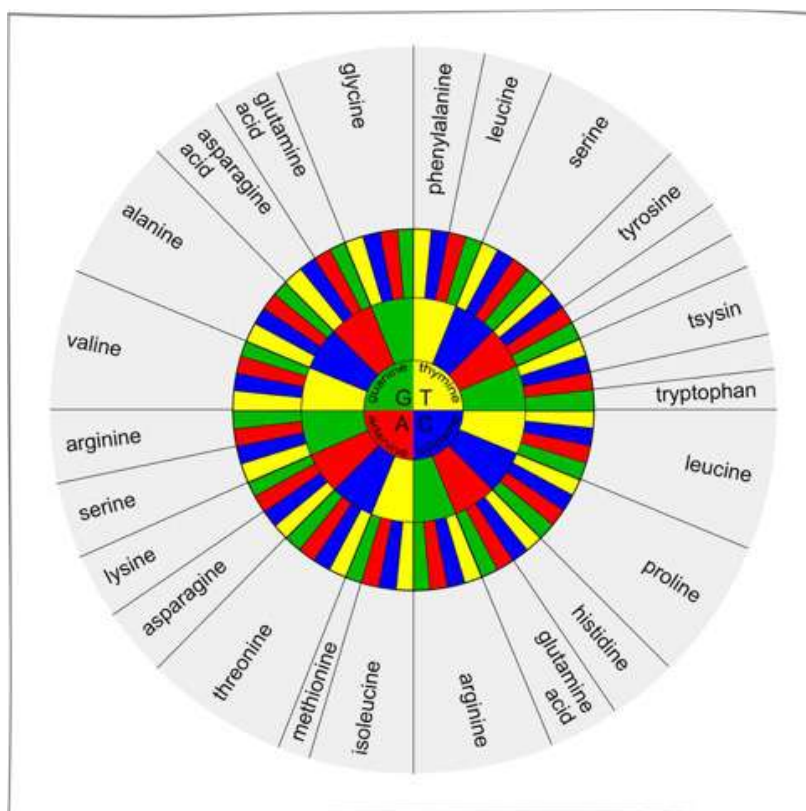

An attempt to calculate the variants of the **BRAIN MATRIX** control with the dimensionality of the task 512x512, without A. Khatybov's "participation" in it, did not result in any success, which extremely "upset" the representatives of "science" who aspired, first of all, to **CONTROL MASSES OF PEOPLE**. Why?

The entire "science" and all the "research workers" around the world were not able to **GET TO** and **COMPREHEND** the fourth **CODON of DNA**. It is in the fourth codon there is that mystery to which Ebr System

(and all of its "academicians" with their science based on the "Horse Science") have not been able to "get", and for this reason the "scientists" of the whole world have not been able to solve the problem on the extension of biological life.

It is for this reason that they were not able to get to changing the Design of Man's Brain and **MAKE A CONTROLLED ANIMAL** out of him. And it was only thanks to the works of N. Levashov and A. Khatybov that this **FUNDAMENTAL KNOWLEDGE** became accessible to scientists' understanding. By the way, on the site of Makov (<http://www.salvatoremm.ru/>) one can know about the fact that it is the geneticists and gerontologists of Russia who will be the first to solve the problem of biological existence of the flesh cell, and accordingly, the biological extension of Human life. Positive actions in this direction are being realized.

I will quote one of A. Khatybov's notes intended for those who are eager to move forward in knowledge. It says a lot. ***"I imperatively recommend the thinking and having ears.*** For the time being the network is not usurped by the idiots censoring what they "are deprived to understand by God...", learn and go forward without hesitating. Learn to think at least here on these examples, which I quoted time after time to the «venerable scholars."

The **spine** below the ribs is called "pony tail" in medicine. This indicates at the **CONTINUITY** of **KNOWLEDGE** and brings the king of nature on a par with mammals, and in some cases also with herring. It is known that the fish also have the Brain that the fish breathe oxygen, and since they have **NO LUNGS**, then they have a certain Generator of extracting this oxygen from the water, that is, the **GENERATOR** of **COLD NUCLEAR SYNTHESIS**. Man does not have such a Generator, so the fish are more intelligent creatures than Humans?!

It is known that **the heart** "pushes" the blood, but if you calculate the load, it turns out that the muscle energy of the heart is **INSUFFICIENT**. In addition, the Human has blood vessels of 1 micron (these vessels account for more than 90% of all blood vessels). At the same time, the **erythrocyte has a size of 7-9 microns**. The fact that the erythrocyte is not able to get into a smaller blood vessel can be demonstrated by experience. Take the pillow, come up to the tap in the bathroom and try to push the pillow there. But the main thing is not here, but in the fact that medicine does not know **WHETHER THERE IS AN ERYTHROCYTE** in the living blood. " So

how does the erythrocyte take its place there? The answer (from A. Khatybov) – there is **NO erythrocyte IN THE BLOOD, it is formed OUTSIDE** of the **CONTROL SYSTEM (or the Brain) as a sedimentary structure with loss of an octave of its state** (with the decrease in the octave by 2 times, the total size increases by 1.284 times).

Similarly is **the birth of a child**. The spermatozoon has an ionic structure and the Brain in the **octave 96** (less than the size of an atom). Once in the "sandbox", that is, in the structure in which the maximum scattering takes place, the spermatozoon quickly grows up (losing the octaves of the Brain). When the equilibrium state (**octave 71.225625**) is reached, a "signal is given", and there comes delirium. And here follows an important factor: **a new Brain (Entity) comes in a higher octave, and the functions of the old Brain (Entity) can only be interfered partially.**

All this is well illustrated in the works of N. Levashov, concerning the Entity coming into the biomass for the development of the fetus and the birth of the child. Let me remind you that the difference is only in terminology. N. Levashov "uses" the word "Entity" (the soul) for a more understandable association in the imagination of the reader, and A. Khatybov "uses" the word "Brain", which is identical and equivalent to the terminology and concept of N. Levashov's. I also want to remind you that about the existence of a non-inertial mass (the structure of octaves more than 64, united by octave 96) "modern science" **EVEN DOES NOT SUSPECT**, although the fireballs and their action have been known for a long time. With octaves higher than 64 we have 8 different atomic structures (in A. Khatybov's works they are given nominal names – **neutron and antineutron, neutrino and antineutrino, etc.**). Each of these structures has a range of existence (charge). When the charge is lost, the potential of the lower octave increases. **Example:** when transferring the octave's power 65.5 into 32,125225 we get a powerful lightning discharge (commensurate with the power given out by a large HPP for hundreds of years), although the initial state can not be seen.

You see how simple everything is, if, of course, you **STILL** go to the **BATH (A. Khatybov's)**, using the **BROOM (N. Levashova's)**. Here it is individually offered in the hands of everyone moving in direction of knowledge – a large **LABOR** spade for creative and independent work in finding and comprehending the sparkling nuggets of **THE TRUTH**.

And so A. Khatybov painted **Man as the king of nature** and his place in "society":

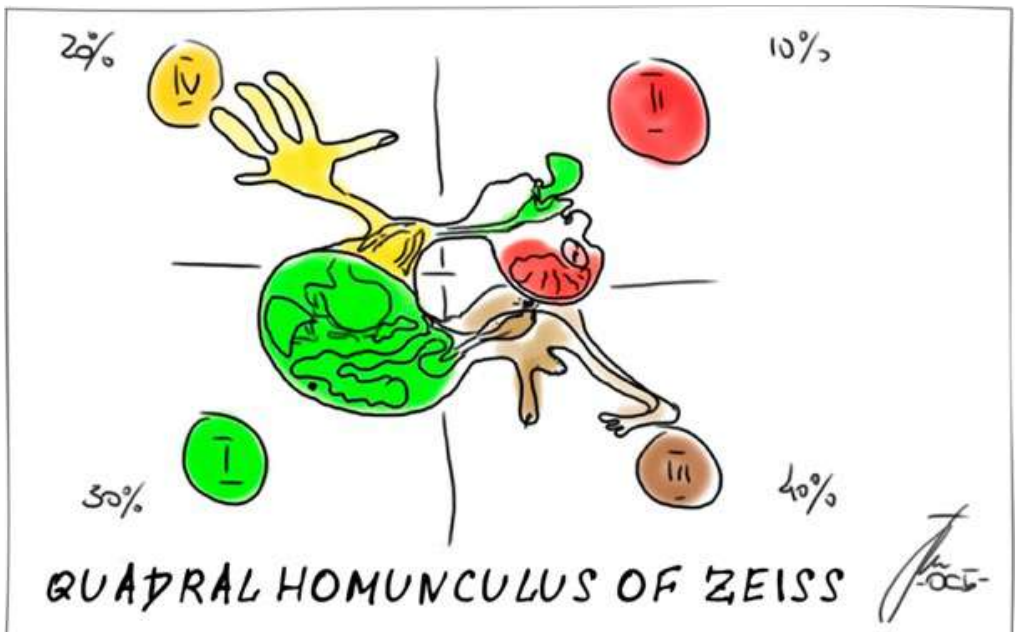
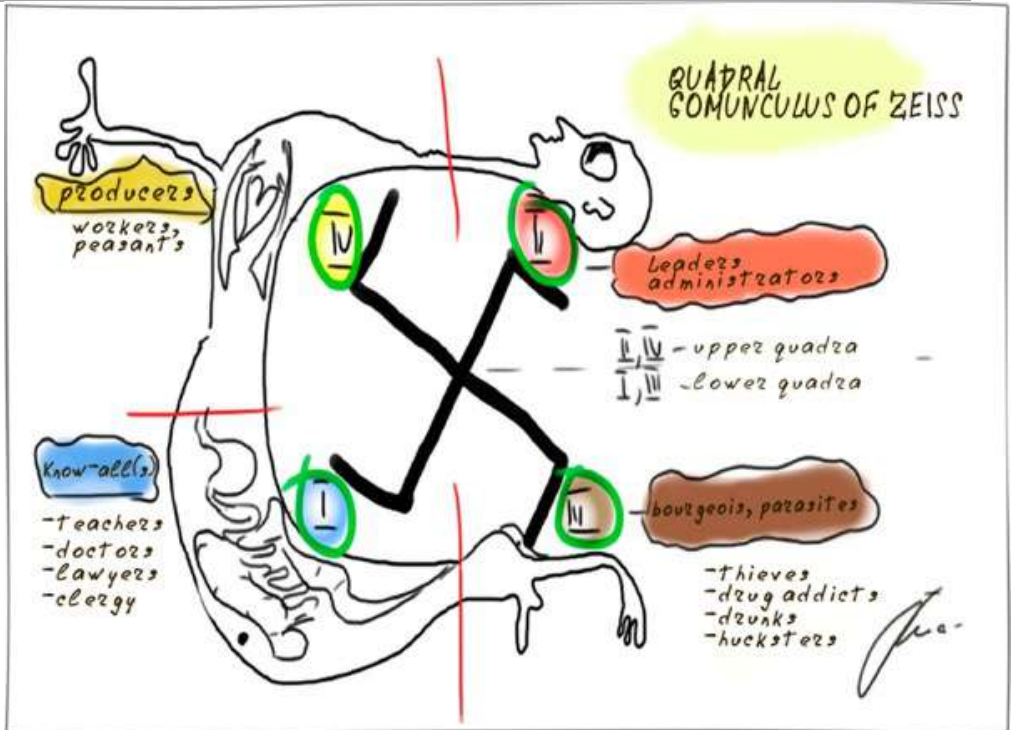

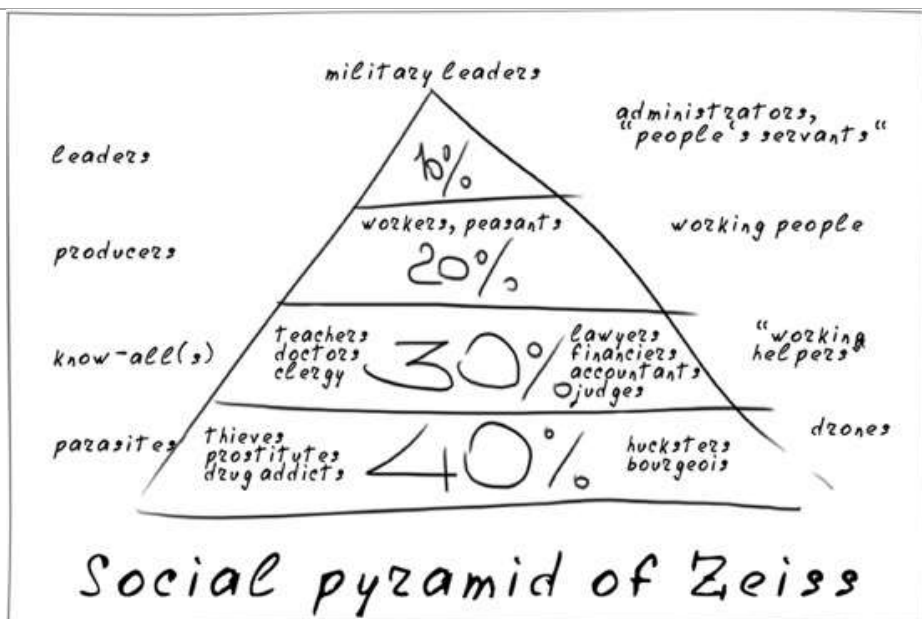

These drawings are authentic and made by A. Khatybov. I hope that the information about the "social pyramid" of Zeiss, the readers will find on the Internet themselves.

6.5. Shlisselburg convict

The narrative would be **INCOMPLETE** if not to tell you about **Nikolai Aleksandrovich Morozov**, a man whom Alexander Khatybov considered to be his teacher and precursor of the knowledge that he received.

Honorary Academician N.A. Morozov is known as the original scientist, who left a large number of works in the most diverse fields of natural and social sciences (astronomy, cosmogony, physics, chemistry, biology, mathematics, geophysics, meteorology, aeronautics, aviation, history, philosophy, political economy, linguistics). He wrote a number of widely known literary works: autobiographical, memoirs, poetic and others. The highest intellect and rebellious spirit of the Russian intelligentsia turned out to be focused in the personality of N.A. Morozov.



In everything that **N.A. Morozov** wrote and what he pondered over one could hear the steps of tomorrow. By his encyclopedic knowledge, enormous capacity for work, productivity and creative potential, N.A. Morozov is an exceptional phenomenon.

A.M. Khatybov noted that N.A. Morozov's merit is in the fact that on the basis of the deepest analysis he showed the role of disinformation in the **MOLDING OF WORLD PERCEPTION** of the world around us.

Nikolai Alexandrovich Morozov was born in 1854. That time, a splinter and a candle served for illumination in the village. He lived through the first steps in the development of technology, steam and electricity, and crowned his life at the dawn of the atomic energy the resources of which he had foreseen before most physicists and chemists. Life in nature since childhood awakened in Nikolai a passionate interest in natural science. Having received a primary home education, as it was usual in noble families; a fifteen-year-old boy enters the Second Moscow Gymnasium. Nikolai Alexandrovich unites around himself a group of like-minded young men, striving for the knowledge and organizes a circle called "Society of Naturalists". Members of the circle publish a hand-written magazine edited by Nikolai Aleksandrovich.

Until 1874, N.A. Morozov leads a tense, full of research life, **PROFOUNDLY STUDIES MATHEMATICS** and a number of extra curriculum subjects – astronomy, geology, botany and even anatomy. At the same time he is interested in social life, studies history of the revolutionary movement.

The hard fate of N.A. Morozov was programmed from the first days of his life. The everlasting drama of children born from unequal marriage. In case of N.A. Morozov, the noble blood of his father, who was related to Peter the Great, was diluted with the genes of his mother, who came from the serf. History has numerous examples, when such children grew up most talented and intelligent people. This is one of the manifestations of the nation's greatness. However, similar examples show the state of being socially unprotected of these children before the popular philistine ideas. The **SITUATION** of the **ILLIGITIMATE** and the related experiences make N.A. Morozov think about social injustice and material inequality in society.

In 1874 N.A. Morozov gets acquainted with some members of the revolutionary circle of "tchaikovtsy". Their ideals and activities attract Nikolai Aleksandrovich so much that, despite disagreeing with some of their views on the peasant question, he, after expelling him from the gymnasium

and depriving him of entering any Russian educational institution, rises to the path of revolutionary struggle.

N.A. Morozov leaves the family and "goes to the mass of common people", lives and works in the villages as an apprentice of a blacksmith, a wood cutter; wanders around the country propagating among the people, urging them to fight for their liberation. But the ardent young man, who is longing for heroic deeds for the sake of lofty ideals, "going to the mass of common people" and the subsequent activity in the working circles in Moscow does not satisfy.

On his comrades' suggestion N.A. Morozov moves to Geneva, where he edits the magazine "Rabotnik", which is illegally transported to Russia. At the same time, he goes on studying natural science, sociology and history.

In the spring of 1875, at the crossing of the Russian border, he was arrested and imprisoned in the St. Petersburg House of Preliminary Detention. **BEING IN PRISON**, he **PERSISTENTLY LEARNS** foreign languages, algebra, descriptive and analytical geometry, spherical trigonometry and other parts of mathematics.

After three years in prison, in January 1878, N.A. Morozov is released from prison and soon joins a new revolutionary organization "Land and Freedom". He becomes one of the editors of the magazine "Land and Freedom" and the keeper of all illegal documents, money and stamp. As a result of the internal struggle, "Land and Freedom" breaks up into "Narodnaya Volya" (People's Freedom) and "Chernyi Peredel" (Black Redistribution) and N.A. Morozov becomes a member of the Executive Committee of the party "Narodnaya Volya" and in 1880 re-emigrated to publish abroad a magazine called "The Russian Social-Revolutionary Library". At the same time he writes "The History of the Russian Revolutionary Movement", he studies at the University of Geneva, where he attends with special interest the lectures of famous naturalists.

N.A. Morozov decides to draw Karl Marx in cooperation in the journal, for which in December 1880 he goes to London, where he meets him and gets the Manifesto of the Communist Party for translation into Russian and a number of other works of K. Marx and F. Engels. K. Marx and F. Engels *write the preface to the Russian translation of the Manifesto* as they have promised.

Returning from London to Geneva, Morozov receives a letter from Sophia Perovskaya and hurries to Russia to help comrades in the struggle, but on the border he is arrested. After the assassination of Alexander II,

according to the Process of 20 of “People's Freedom” he is sentenced to life imprisonment without the right to appeal the verdict.

In Alekseevsky ravelin of the Peter and Paul Fortress there were the strictest conditions. N.A Morozov **DOES NOT HAVE** the right to walk, **DOES NOT GET BOOKS**, because of poor diet he gets scurvy and tuberculosis.

The exceptional will allows him to survive these hard years and, keeping the strength of mind, goes on with his research creative work. Two years later the prisoners of Alekseevsky Ravelin are transferred to the Shlisselburg Fortress, in which there are particularly strict conditions. Only in five years in the fortress, after a number of deaths among prisoners, the prison conditions are somewhat improved, and he has the opportunity to read scientific literature and write his works. In the Shlisselburg prison he writes 26 volumes of various manuscripts, which he manages to keep and take out when releasing from prison in 1905, and his memories "The Early life", published in 1907. Later, they compile the first part of his memoirs "The Story of My Life"; the theoretical work "The structure of matter", which remains unpublished. He **MANAGES TO PUBLISH** "Periodic systems of the structure of matter" only after leaving the fortress. When in prison N.A. Morozov studies French, English, German, Italian, Spanish, Latin, Greek, Hebrew, Old Slavic, Ukrainian and Polish.

Not far from St. Petersburg University D.I. Mendeleev worked that time and in the Shlisselburg fortress, N.A. Morozov tirelessly goes on thinking of the essence of the periodic law, the theory of the formation of chemical elements. Despite the lack of systematic chemical education, despite the fact that he did not pass the proper experimental school, he, thanks to amazing talents, masters the heights of various chemical disciplines and two or three years after his release from the fortress he teaches chemistry, writes books on the general physical, inorganic, organic and analytical chemistry. He meets Dmitry Ivanovich Mendeleev shortly before his death. D.I. Mendeleev approves the work "Periodic systems of the structure of matter", and on his presentation, in 1906, N.A. Morozov is conferred a Ph.D **WITHOUT DEFENDING** the thesis.

Studies conducted at the end of the XIX century by scientists from different countries show that both our planetary system and the most distant stellar nebulae consist of the same elements that are found on Earth. Recognizing the unity of the chemical composition of world matter was of paramount scientific and philosophical significance. In 1897, N.A. Morozov

reports from Shlisselburg to his family: *"Now I'm writing a book on the structure of matter. I've already written almost 1,500 pages, and there are not more than five hundred left. Although this book is probably never destined to be published, I have been still working hard on it almost every day for the last three years and feel an inexpressible pleasure whenever after long deliberation, calculations, and sometimes sleepless nights, I am able to find order and correctness in such phenomena of nature, which until now seemed mysterious"*.

The inner world of a prisoner with a "dried-up body" turned out to be so rich, his self-possession so high that he not only did not die and get insane in the terrible conditions of a long single imprisonment in the "stone tomb" of Alekseevsky Ravelin and Shlisselburg Fortress, but, on the contrary, he filled his life with creative work. N.A. Morozov eagerly awaited every new day as every new day allowed him to move forward in the development of scientific ideas. Many years later, Morozov would say that he was not in prison, but in the "Universe".

N.A. Morozov was released as a result of the 1905 revolution. He entirely devotes himself to science, begins to prepare for publication his works written in prison. At the same period, he gives many lectures throughout Russia. While lecturing, he visited 54 towns of the country, from St. Petersburg to Vladivostok. His public lectures on the problems of chemistry, aviation, history of religions were brilliant, they gathered huge audiences. All this frightened the authorities, and they often prohibited lectures.

The Man of immense mental grasp has another gift – a poetic one. He writes stories, novels, poems. For the poetic collection "Starry Songs" he is sentenced to one year's imprisonment. In prison, he begins to write his memoirs "**The Story of My Life**" featuring a strained plot, a beautiful language and neat images of his contemporaries. These memoirs were **HIGHLY APPRECIATED** by L.N. Tolstoy.



In 1907, on the invitation of P.F. Lesgaft N.A. Morozov began teaching a course of general chemistry at the Higher Free School. A few years later he

was elected head of the Department of Astronomy at the Lesgaft Higher Courses.

In 1911, at the Second Mendeleev Congress N.A. Morozov made a report on the theme "The past and future of the worlds from the modern geophysical point of view," in which he expressed the bold idea ***that new stars arise out of the explosion of old ones***, which occurs as a result of the decomposition of atoms of matter that have become radioactive. Today, this previously challenged hypothesis, in a somewhat modified form, is shared by a wide circle of astronomers and physicists.

N.A. Morozov was interested in many branches of mathematics – from differential and integral calculus and algebra of complex numbers to vectors and projective geometry, as well as the theory of probability. His interest in these matters was closely connected with the application of these mathematical disciplines to natural science. From 1908 to 1912 he published three major works on mathematics: "The beginnings of vector algebra in their genesis from pure mathematics"; ***"Bases of qualitative physical and mathematical analysis"*** and ***"Visual presentation of differential and integral calculus"***.

Most fully original ideas of Nikolai Alexandrovich in the field of astronomy are presented in his work **"The Universe"**. He takes a new look at questions of universal gravitation, at the origin and evolution of the solar system, at star clusters, and the structure of the Milky Way. He worked a lot on the theory of relativity. To his remarkable ideas there also belongs the hypothesis of the interconnection and periodicity of astrophysical and astrochemical phenomena. For a long time he worked on the fundamental work "Theoretical Foundations of Geophysics and Meteorology", in which he showed that the impact of the Galaxy on the meteorological and geophysical processes of the Earth is of a regular nature. The impact is so great that without introducing it into calculations one can not even dream of a scientific weather forecast.

N.A. Morozov was also greatly interested in aviation and aeronautics. He became one of the pioneers of scientific aeronautics in Russia, got the title of pilot, was the chairman of the commission for scientific flights, lectured at the aviation school, flew many times on the first balloons, proposed a system of a parachute opening automatically, as well as special suits for high-altitude flights (a model of modern clothes of pilots and cosmonauts).

During the First World War, in 1915, N.A. Morozov went to the front and there, at the forefront, as a delegate of the All-Russian Zemsky Union, was giving active assistance to the sick and wounded. His memories and thoughts about the war, he reflected in the book "At War," published in 1916.

After the October Revolution N.A. Morozov transformed the Higher Courses of Lesgaft into the Natural Science Institute named after P.F. Lesgaft; and he became his elected director. Simultaneously N.A. Morozov was in charge of the astronomical department of the Institute and **CREATED** an **OBSERVATORY** in which he worked.

Since 1918, for many years N.A. Morozov worked with enthusiasm on a fundamental writing "*The history of human culture in natural science coverage.*" Part of this great work in the form of seven volumes was published under the title "CHRIST" (edition 1924-1932). The last three volumes of the manuscript remained unprinted.



The name "**Christ**" suggested by the publisher does not fully correspond to the content of this work. In the preface to the 7th volume N.A. Morozov wrote: "The main task of this my fundamental work was to reconcile the historical sciences with natural science and discover the general laws of the mental development of mankind". The version of the chronology of ancient history adopted today was created in the period of the XIV-XVI centuries and was finally completed, in basic terms, by medieval chronological historians I. Scaliger (1540-1609) and D. Petavius (1583-1652). Morozov was the first to understand that both ancient and medieval events require redating. Based on the analysis of the enormous factual

material, having rechecked many historical documents by mathematical, linguistic and astronomical methods, N.A. Morozov advanced and partially substantiated the fundamental hypothesis that ***the Scaliger chronology was artificially stretched***, lengthened in comparison with reality. He **POINTED THE ANCIENT TEXTS** describing probably the same events, but later dated by different epochs. Morozov indicated that since the ancient texts had been repeatedly rewritten and, as a rule, they had been altered, they could have moved quite far from the original text. At that time there was no such branch of science as mathematical linguistics. N.A. Morozov suggested determining the authorship of texts and identifying plagiarism according to the statistical distribution of official words. In this respect, Morozov should be considered one of the precursors of mathematical methods in linguistics.

Listing NA. Morozov's writings, one can not fail to mention his historical study of alchemy "In Search of the Philosopher's Stone". This book was taken by readers with great interest; it is still one of the most fascinating writings on the alchemical period of the development of chemistry. As you know, Nikolai Alexandrovich always tried to study history from original sources.

Getting down to the writing of that book, he critically analyzed historical manuscripts that covered the most principal facts from the development of chemistry. Here is an example of his appreciation of many historical documents that he had to use: "All that we know about the writings of ancient authors, almost entirely is taken by the contemporary historians from the collections of XV-XVII centuries, that is, from people who lived a whole thousand of years after the death of the cited writers, who were extremely credulous, and dotted their information with incredible stories about all kinds of wonders. To tell the truth from plausible fabrications and later additions in them is almost impossible. Due to this circumstance, all of our primary sources of the ancient period of the pre-printed era represent the real Augean stables, for the cleaning of which a new Hercules is needed. But even Hercules alone would not be able to do anything about it. Here you need a special international society for the elaboration of primary sources of ancient history".

However, N.A. Morozov's methodology of research the history of mankind, his historical concept, proved to be so revolutionary that it **HAS NOT BEEN** recognized by the official historical science. The facts presented by the scientist are considered to be largely misinterpreted by him.

Nowadays, research on the new chronology is continued not by historians, but by scientists from other fields of knowledge – mathematicians, physicists (in particular: M.M. Postnikov, A.T. Fomenko, G.V. Nosovsky, S.I. Valiansky, D.V. Kalyuzhny and others).

When in prison, Nikolai Aleksandrovich develops the idea of the **COMPLEX ATOM STRUCTURE** and thereby justifies the essence of the periodic law of chemical elements. He passionately defends the suggestion of the possibility of an atom decomposition, which seemed unconvincing to most physicists and chemists, since there was not enough experimental evidence for that. N.A. Morozov also says out the idea that the *main task of chemistry of the future is the synthesis of elements*. Developing the idea of J. Dumas, he proposes a periodic system of hydrocarbons – "carbohydrides", by analogy with Mendeleev's table – "in order of increasing their shared weight," and **CREATES TABLES** showing the periodic dependence of a number of properties of aliphatic and cyclic radicals on the molecular weight. N.A. Morozov suggests that there should be chemically neutral elements among the atoms. A number of the atomic weights of the elements of the zero and first groups calculated by him coincided with the atomic weights of the corresponding isotopes, determined many years later. A profound analysis of the properties of the elements of the zero and eighth groups of Mendeleev's periodic system lead him to the idea of the need to combine them into one zero type, which was also justified by subsequent work. "Thus, – wrote the famous chemist Professor L.A. Chugaev, N.A. Morozov could predict the existence of a zero-year group **10 years before it was actually opened**. Unfortunately, due to circumstances beyond his control, this prediction could not then be published and appeared much later in the press".

Striking and indisputable is the fact that more than 100 years ago N.A. Morozov boldly and confidently accepts the view of the **COMPLEX STRUCTURE OF ATOMS**, the transformability of elements, allowing the possibility of artificial production of radioactive elements, recognizing the extraordinary reserves of intra-atomic energy. According to Academician I.V. Kurchatov, modern physics fully confirmed the assertion about the complex structure of atoms and the interconversion of all chemical elements, analyzed by N.A. Morozov in the monograph "**Periodic systems of the structure of matter**".

From 1918 until the end of his life N.A. Morosov was director of the Natural Sciences Institution named after P.F. Lesgaft. The institution distinguished itself by the multi-aspect of research work in varied fields of knowledge, which was manifested by the Instituton publications since 1919 under his editorship. It was at this institution, at the initiative of the scientist, there began the development of a number of problems related to the exploration of outer space. The principle of comprehensive research was realized not only at the institution that he directed, but also in the work of the scientific center created in 1939 on his initiative in the Borok settlement of the Yaroslavl region, where the Institution of Inland Water Biology and the Geophysical Observatory of the Russian Academy of Sciences are currently working.



Of all his fundamental works on mathematics, chemistry, aviation, geophysics, meteorology, aeronautics, mathematical linguistics (he was its precursor), astronomy, natural science, the history of Human culture and others, N.A. Morozov, on the basis of his own research, in his fundamental work, "Christ" makes the conclusion that the ***Humanity has neither its history, nor science, as the knowledge about the world around us.*** When researching into the processes taking place on the Earth, one has not only to know all the laws of the phenomenal world, ***but also be able to analyze the past events, finding the connections between them.*** One can believe everything that science has presented to us today, but knowledge can not be based on it, and the convincing proofs that science adduces are made in the absence of a different system of knowledge.

N.A. Morozov's ever lasting aspiration for work at the "joints of sciences", using the facts and methods of various fields of knowledge, brings him closely to the **SYSTEMATIC SCIENTIFIC APPROACH** (which is now one of the leading methods in science) in studying phenomena in their diverse and often unexpected connections that unite seemed to be completely heterogeneous phenomena and processes. The range of interests of the scientist extended from the chemical elements to the essence of life;

from the origin of stars as a result of the explosion of cosmic bodies to the formation of clouds; from the vector calculus to the theory of relativity; from the processes taking place in the center of the globe to aeronautics; from ancient and medieval history to the results of early 20th century science. N.A. Morozov believes that in the future ***all separate knowledge would unite into one common natural science, flow into a mighty stream of unified knowledge, become a common natural philosophy of the future.*** And I believe it, too.

As you can see, ***it was not by chance that Alexander Mikhailovich Khatybov considered Nikolai Aleksandrovich Morozov his teacher.***

The Soviet government awarded Nikolai Aleksandrovich Morozov with two Orders of Lenin and the Order of the Red Banner of Labor. In the house where the honored academician N.A. Morozov lived and worked a museum is organized. His name is given to a village in the Leningrad region, not far from Shlisselburg Fortress. Astronomers gave his name to a small planet-aasteroid. «MOROZOVIYA» is in all the star catalogues of the world. One of the craters on the reverse side of the Moon is named after N.A. Morozov (5' n.l., 127'e.l.).

6.6. Quintessence

Einstein asked Bohr: "Does the Moon exist when I do not look at it?" Bohr answered: "Can you prove the opposite?" If we do not see the Moon either with our eyes, or speculatively, if it is not in our consciousness – there is no Moon. It appears with its appearance in the consciousness. While it did not appear, it does not exist. What is not in our consciousness that does not exist for us. Existence is always movement. Without movement there is no existence. The basis of the movement is information. So, the information **EXISTED BEFORE** any... existence.

One can believe everything that science has presented to us today, but knowledge can not be based on it, and the convincing proofs that science adduces are made in the absence of a different system of knowledge.

Alexander Mikhailovich Khatybov was gone on 18.03.2011. I do not want to finish this chapter on such a sad note. I surely know that such Men, as A.M. Khatybov, N.V. Levashov **NEVER DIE**. Actually ***my today's***

knowledge is from information out of the works of those great Scientists.

Many people who are familiar with the writings of N. Levashov and A. Khatybov, **INVOLUNTARILY ASK** the **QUESTION**: "Why did people like A. Khatybov and N. Levashov passed away on the Earth at such an early age? After all, they could have done a lot more of useful things in so hard times for us". Did they have time to "pass on" their knowledge and skills to people who made a step on the path of knowledge? Of course, their works, awakened the consciousness of many people, but still there are many who **DID NOT GET AT THE MEANING** of what these great Men had stated. If N. Levashov wrote everything in an intelligible language, though there are many who still did not understand, then what to say about the works of A. Khatybov, that were specially left in the form that not everyone was able to look into them.

I have already mentioned that the most correct way to understand the works of A. Khatybov is through the knowledge of the works of N. Levashov. And those who do not understand this, in my opinion, are limited people who are "frozen" in their development and believe that having read the works of N. Levashov (and basically without understanding anything there) they have already "caught the Bull by its horns". In his time, N. Levashov convinced me not to start any **UNWANTED DISPUTES** and not to pay attention to the "actions" of such people and more so **NOT TO TRY** to prove anything to anyone. And he was right. I know only one thing – if there were no works of A. Khatybov, I would hardly have known "**SvetL**" **Technology** and the potential to create programs for it, about which there is **NO NEED** to tell or prove anything to anyone. All this is done by the participants of "**SvetL**" **Programs** with great thanks for what has become an **INTEGRAL PART OF THEIR LIVES**. ***And the knowledge of the works of A. Khatybov became possible only after my acquaintance with N. Levashov as a Man with a capital letter,*** and with his works, which were the forerunner of my knowledge in a completely **NEW VISION** of the world.

The scale of the personality depends on the scale of his consciousness. Alexander Mikhailovich Khatybov possessed such consciousness and manifested himself in everything that generates a thinking beginning. B. Makov, reminiscing AM. Khatybov at his **70-th. anniversary** of his birth, said that A. Khatybov was a **GLOBALLY-SCALE PERSONALITY**, drew our attention to the most expressive fragments of his life, which enabled him to find the state of creative perfection and public or concealed recognition of

his professional merit. And he has my whole-hearted support. Most of the epoch-making scientific endeavors, first accomplished by A.M. Khatybov from the Super system level for the recreation of the True Systemic level of the Control was an act of **NOT** a **MATERIAL** usage of Man, but to a certain extent equally prepared by his state of Mind and worthy of his Mental Entity for that hardest period and state of the True Control System. It is difficult to explain what it is forbidden and impossible to explain!

Once again I'd like to emphasize – I'm very sorry that I ***did not have the honor*** to be **PERSONALLY ACQUAINTED** with **Alexander Mikhailovich**. I am grateful to Nikolai Levashov and Boris Makov for their stories about this amazing, purposeful Russian Scientist who entirely devoted himself, to the good of all the others.

Afterword

Each of us has an inner great and delightful world. All that is required of us is to leave at least a little room for new knowledge and impressions.

A young man came to see the tutor and said:
– I want you to be my teacher. Help me to know the wisdom of life.
– Well, – says the teacher, – Tell me about yourself.

The disciple began to talk about his virtues; about how much he knew and how many things he was able to do.

The teacher listened, and then gave him the first task. But the young man did not agree with him. He made up his mind that was a bad task, that he needed a completely different test. He went on talking about how much he had learned, and achieved considerable successes in his life. Yes, perhaps – in other spheres of life. But why not transfer them to the given situation?!

Whatever the tutor suggested, the young man always had a more correct version of the problem solution.

Then the wise man gave the youth a glass, and began to pour wine into it from the vessel. At first the glass was filled to half, then to the very edges, and the teacher went on pouring the wine into the glass. The young man looked calmly at first as the wine was running over the glass to the ground, but then he could not stand it any longer and screamed:

– Stop pouring! We just waste wine!

– Just like I'm wasting my time. I could teach you a lot, but you are already full, like this glass.

The young man asked:

– So, my past experience means nothing?

– Your way of thinking made you what you are, gave you everything that you have today. But if you want more, your past experience will not lead you to the desired goal. Go away! And come back only when you are empty. When you are ready for new knowledge!

Human life is a struggle between ignorance and enlightenment, lucidity... Once you stop looking for information and knowledge for yourself, you find yourself in the network of

ignorance. I assure you, readers – **EACH OF US BEARS A WHOLE UNIVERSE IN OURSELVES**, and therefore Man, if, of course, he is a Man, is immortal (I am saying it with full responsibility), **THANKS TO THE KNOWLEDGE.** Knowledge and thinking are the root of Man's life, his immortality.

"It is proved that there is no Humanity – it has no history. At least there is no history before our era. And the later history has been apocryphalized so much that it can be taken for a fairy tale..." – N. Morozov said on the basis of his own research, and when it was confirmed by becoming public through the works of N. Levashov and A. Khatybov, many people realized that it was time to change all this, beginning with their own Knowledge and relying on these priceless works.



When I began to work on this book and then on its continuation in the second version, I proceeded exactly from this. What does the Man lack today in order to stop playing in compliance with the rules of the pre-determined finale? Probably, that very thing that there is missing in the Bible (for those who believe) and in millions of volumes of books, though being hidden from us. There is no life in them. The Life of Man begins when he wants to get started the most powerful reserve – **HIS MIND.** The difference between instincts and the Mind is that the Mind asks questions, strives for understanding, perception and comprehension. Exactly those features make Man different from animal. And for this, he does not need anything but free will. But the most interesting thing is that no one deprived him of his will.

And to understand this and more than this, I have tried to make a testing ground out of the written, on which, in my opinion, I have created some models of the **SENSE OF LIFE**, in order then to shift them into the existing reality and bring it all to people. For example, the fact that reading impregnates thinking. But if you want to bring something to people, then you have to **BE THOUSAND PERCENTAGES CONFIDENT IN WHAT YOU ARE BRINGING** there is **THE TRUTH AND ONLY THE TRUTH!** There is a Lie and the Truth, and in the middle (i.e. between them) – a true thing. And we should always strive for an acceptable degree of approximation to the Truth, based on a true thing to cover what is happening. That was what N. Levashov used to do, and it was he who started to do it – for the first time. That is hard, because we are still, in the full historical fog of our "HizTory", backed up by the sly mental derangement of people's consciousness on the part of objective scientific and horse-esoteric propaganda, have to dispel many myths of the Pseudo- Truth. And, never come to a standstill; try to shift people's knowledge on the path of the true thing – the Truth, realizing that this can be prevented by state violence, and by all the "clan-Khazar Guards" and their like.

To make us happy, **THERE IS ALL KNOWLEDGE!** All kinds of technologies! But they are hidden from us in the "secret archives". And woe to betide those who makes public even a minor a part of it. Even today – such people are declared either enemies of the people, or just physically eliminated. We know these illustrative examples. And it's not scary that the world will shudder to know the Truth. After another massacre, you can hypocritically "raise the glass" for the untimely gone Genius and pour crocodile tears on His grave. Therefore, to go this way, you have to understand: you **ARE FULLY RESPONSIBLE** for what you give people before them and your own conscience! And you have to be, first of all, most confident that you have avoided delusions, have been able to correctly understand and think over your own experience, and most important – that your information, technologies that N. Levashov "launched", and you apply them, improve and develop, are not the fruit of your own imagination! Although to think up such a thing, from my point of view, is simply impossible, since **NOTHING LIKE THIS HAS EVER BEEN DESCRIBED** even by the most talented science fiction writers of all times and peoples, even those science fiction writers whose ideas have been realized in hundreds of years!! Nothing of the sort happened either in the legends, or in the religious doctrines of the divine creation! But **N. Morozov, N. Levashov, A. Khatybov** came out, and this door began

to open, and today many people are doing everything to open it up wider and wider.

Everything I wrote about is taking place around us. And if it looks fantastic – it's only thanks to the created stereotypes and narrowness of the human worldview. In the existing form, people behave in accordance with what is told in the book, and I will go on with this story. They take what is available and use it for some of their purposes (for their own good), without having a full or at least deep understanding of it, and knowing just enough to use it, **NOT MUCH WORRIED ABOUT THE CONSEQUENCES**. If you pass this to the plane of the philistine's consciousness,- people, for example, catch fish, raise it to feed themselves, having mastered the methods of catching and processing, but all their concern is to find out once that the fish is over and it's time to add it to the lists of the **Red Book**⁴¹. But if you look a little deeper – there **COULD NOT BE ANOTHER HUMAN BEING ESSENCE** under the control of Ebr System and the programs launched by it. Since such parasitism lies at the heart of their (ebr) existence – it also lies at the basis of our existence under their control. We raise fish for our purposes – they "raised" people for their own. And if suddenly some "philosopher" begins to tell us that it is **NOT A VERY SENSIBLE PRACTICE** to raise fish the way we do it, moreover, it is inconsistent with some fundamental principles that are not something to touch or to see, – we will hardly listen to such things. And this "philosopher" and his team will have to give up the very blind, leaving them the chance to live as they do, and in the future to deal with those who have caught at least some fragment of the truth and are able to perceive information more or less adequately. Then, look, you are able to learn not only something more about fish, how to catch it and under what sauce to eat it but, perhaps, to get closer at the meaning, **FOR THE SAKE OF WHAT IS NEEDED** he **IN GENERAL** who is fed this fish with – that is, Man himself.

A building without a foundation can not be. No question. No matter how strong is the visible construction, if the foundation disappears under it, it will inevitably collapse. There are no exceptions to this rule. It is impossible to have the foundation ruined, and the construction based on it remained intact – everything will collapse. We have already come to the conclusion that the role of the foundation is performed by the **WORLDVIEW**. It is

⁴¹ The Red Book is an annotated list of rare and endangered animals, fish, plants and mushrooms.

from it that the principal provisions and landmarks are derived, around which the cultural, social, political and economic "systems" are created, that are used by Man. If the foundation collapses, the system-forming nodes lose ground. After **N. Levashov's** passing away, I did not have much evidence confirming the correctness of my positions on the Technologies and their applications. I did not know about some of the confirmations then, other evidence was yet to appear in the near future, but ... I already had my own experience and my own evidence in the effectiveness of the Technology and in the possibility of using **"SvetL" Programs**, and the evidence was rather weighty. Despite the fact that evidence **WAS NOT KNOWN TO MANY PEOPLE** (and those to whom it was known were not in a hurry to confirm my results), it



was obtained precisely both due to the correct understanding of the Laws of Nature, and methods of impact, and most importantly – interaction with Nature itself. That time when I had only just "touched" and started to learn the Technologies, I still had some belief that modern science was true science, that the overwhelming majority of people who call themselves scientists put their goal in the knowledge of the truth, that ***in the scientific world there was no place for deception and careerism!*** Then I still believed that most scientists were creative people, open to the new and free from dogmatism, since dogmatism is incompatible with science! Of course, I saw enough examples of the opposite, but I thought then that such "scientists" are the exception rather than the rule. Changing the attitude to the situation, we change our worldview and life. The victory of some scientific view and its inclusion in publicity – **DOES NOT PROVE IT TO BE THE TRUTH YET.**

I'm probably just lucky that in the very near past I came across scientists who really had all the qualities of the true research workers, as I then saw it, and it "led" me to knowing **N. Levashov**, who determined all my future life, and not only it.

The process of getting information, as it is, is not **KNOWLEDGE**. Completed Knowledge is **LOOKING FOR** and **FINDING EVIDENCE**. This evidence has already existed, it is described in this book, too.. But not everything is in this first, but already supplemented in the second edition, book. **Therefore, it is to be continued...** Each ending is the beginning of something new. The best afterword you can only dream about is the ellipsis...

Life goes on ...

When I get down to this appendix, there began tormenting reflections. But they won't give birth to any creative thought. Sometimes such things happen, and one should not get scared of them. Did not I promise in the beginning of the book, after all, that I would provide readers with detailed information about the ongoing events?.. I appealed to my Companions for help in this routine work, keeping in mind the words I said when I started writing the bookkeeping in mind my own words that not me would write the book, – but joint efforts of all of us. I express my sincere gratitude to **Yu. Ocheretyanny and A. Nikonovich** for the work that they have done to make it possible for such an important appendix to appear. It makes it easier to comprehend what is happening on our Planet and allows readers (I really hope) to get a deep insight into the content of these Books, which I supplemented with information from the works of N. Levashov, A. Khatybov, N. Morozov and many others, trying to show and tell the whole truth about those events on our Planet that had been deliberately concealed from everyone to achieve once set but never implemented goals. There is always a solution to any problem; you just have to find it. And if you do not find a solution to the problem – it means that something was not taken into account or there were not those necessary properties and qualities; but they are to come to you, as soon as you find the solution.

A short story about the HistOR(AH)y

Any professional or amateur view of the history of mankind easily brings it to an endless list of armed conflicts and wars in which not one civilization or state perished. Another way, for the new aspect⁴² of people was not envisaged by the Ebr invaders imposed system of parasitism and violence. As well as the preservation of documentary evidence of the losers, the memory of which often died in the flames of the fires burned by the winners or under the rubble of the destroyed depositories. Nineveh library of Assyria Ashurbanipal, papyri from the library of the temple of Ptah (Memphis, Egypt), the Alexandria library, the collection of Pisistratus (Athens, Greece), the Carthage libraries, the Imperial Library of Constantinople, the House of Wisdom (Iraq), the Pergamon library

⁴² People created in the framework of the Ebr programs "Development of energy biogenesis of flesh cells" and "Development of brain genotypes".

(Anatolia) the library of Ivan the Terrible is just a small piece of knowledge about ourselves and the world around us, lost or hidden in the Vatican cellars, repositories of patriarchs and hierarchs of various ancient religions from pagan cults to Christian Orthodoxy and Bon religion.

The best estimate of the chronology of mankind "restored" by the French philologist Jose Scaliger and the French cardinal Dionysius Petavius are in the writings of N.A. Morozov, who began its cleansing of distortions and historical fantasies, which had been made to please the Vatican, which started writing "history."

Even more regrettable is the chronology of our country. By the efforts of German scientists, who took over the historical branch of the Russian Academy, our chorology was laid in the Procrustean bed of the Norman theory and other fictions far from the truth. Here are the names of "historians" whom we should be grateful for "ignorance" of our ancestors, the feudal fragmentation of "Ancient Rus", the emergence of Russian culture no later than 988 AD. and its other distortions: Gottlieb Siegfried Bayer, Gerhard Friedrich Miller, August Ludwig Schlözer, Kohl Peter, Fischer Johann Eberhard, Kramer Adolf Bernhardt, Lotter Johann Georg, Leroy Pierre-Louis, Merling Georg, Brem Johann Friedrich, Tauber Johann Gaspar, Krusius Christians Gottfried, Moderah Carl Friedrich, Stratter Johann Gotgilf, Gackman Johann Friedrich, Busse Johann Heinrich, Vauvillier Jean-François, Claproth Heinrich Julius, Hermann Karl Gottlob Melchior, Circle Johann Philippe, Lerberg August Christian, Kehler Heinrich Karl Ernst, Fren Christian Martin, Grefe Christian Friedrich, Schmidt Issak Jacob, Shengren Johann Andreas, Sharmois France-Bernard, Fleischer Heinrich Leberecht, Lenz Robert Christianovich, Brosse Marie-Felicite, Dorn Johann Albrecht Bernhard. As they say, comment is superfluous.

But M.V. Lomonosov's works, who fought for historical truth in the way which it was possible that time, never saw publication during his lifetime. The next day after the death of the Great Russian scientist, by Catherine II's order his archive was confiscated and added to the list of missing historical documents. Only the first volume of Lomonosov's work on Russian history, saw the light, but rewritten by Miller.

The events beyond the last 18,000 years are generally shrouded in mystery of conjectures and "legends" that are poorly correlated even with elementary logic. Efforts of singles, numerous artifacts that do not fit into the current chronology and materials obtained by "unconventional" methods, official historical science ignores completely. So much the worse

for it. There are plenty of vacant places in the list of falsifiers of our country's history.

What are the justified large-scale efforts to conceal the truth and direct destruction of artifacts? What is it that the Earth keeps from the living on it today, and where are the evidences of falsification or erroneous interpretations? Apparently, one of the main reasons is the "contributions" of Interventionist civilization and its "fifth pillar" on the Earth. They are so "great" that the payment for them will bring about more significant consequences than even the measures that have been taken today against the Holocaust perpetrators. Only the initial loss of proto-humanity is about a billion inhabitants. Plus, the imposing of parasitism and violence in the life of the planet, the change in the whole picture of the external appearance of the surface, including through the introduction of its fauna, flora, "the creation of people" and... everything that I have told in my books. Briefly I will return to what has already been stated, but it is necessary to understand the true essence of my companions' reflections who have written their vision of the ongoing events, which substantiate to some extent the so-called temporary "inconsistencies" that are found when studying the works of N. Levashov, A. Khatybov and other sources available today.

So, the Earth. Before the invasion.

The main, i.e. indicative for understanding the parameters of the Earth before the attack were: the angle of inclination to the plane of the ecliptic 25° , the day = 48.64 hours, the year = 864 days (relative to the charge oscillation cycle = 1.007 seconds), the height of the grating of the true Atmospheric Structure was 12000 km, the number of the layers of the formed Atmosphere gratings – 18. The level of the Earth surface layer was almost 11 km less, the shape of the Planet **WAS CLOSER TO THE SHAPE OF THE BALL**, there was no such array of mountain formations and other modern "garbage". The water was formed only on the surface (above the earth), and in the area it occupied up to 4% of the entire territory of the Planet. There was no continental division of the Earth's surface.

Before the invasion, the Earth Cluster System was moving, focusing on Sirius at a distance of about 240 billion km (moving off the Earth).

A highly developed human culture, created by Civilizations of Intelligent Orientation, existed on Midgard-Earth for a long time until it got in the Ebr "field of vision". To withstand the invader fleet that arrived in our Star System in 18344 BC, having at its disposal: the Sun and three Moons (the largest interstellar ships), 54 satellites, 12 main objects (type 960) and

3862 attack targets, under the conditions of transition Guardianship of civilization development from Orion to Sirius and disabled (or in transition state) complexes, there were very few chances (it only remains to pay tribute to the Ebr intelligence).

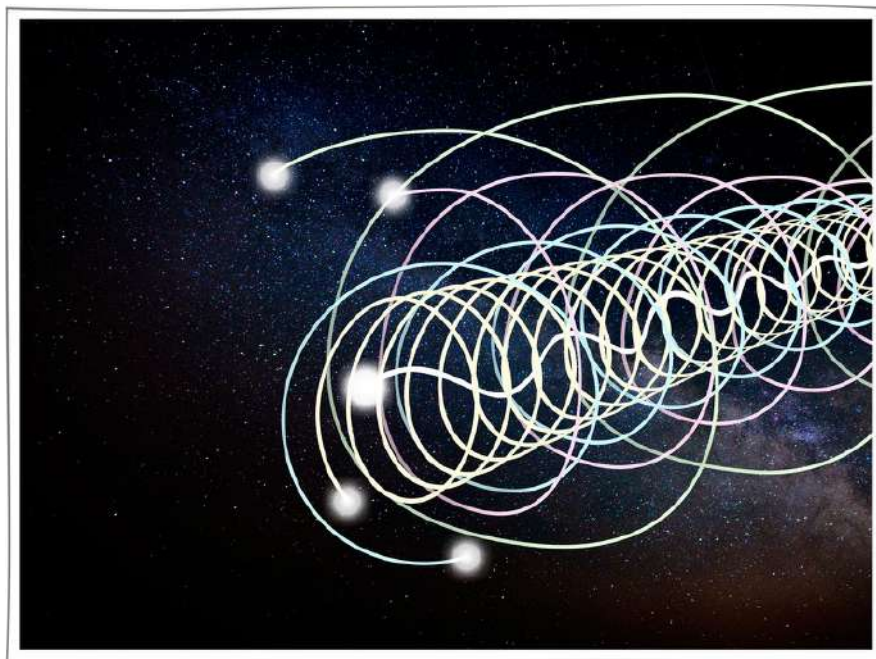

We are going on to consider military actions. Phaeton, as a planet with protection functions and corresponding capabilities, destroyed a considerable part of the interventionist fleet by self-explosion on **May 9** (a strange date in the history of Mankind: On May 9 was also captured by the Ebr the main Complex of the Native ECS Chechov) There is no reason to doubt this, but there are doubts that it was the only type of defensive action. The level of civilization was not at the level of the earth's cluster. After all, the same Midgard-Earth with its controlling and generating Complexes was capable in the so-called "cone of motion" (its parameters: the base diameter equal to the diameter of the Atmosphere, the cone angle is equal to 1°) to destroy or divert any object commensurable with its mass to avoid the collision with it.

So, both Midgard-Earth and Phaeton, as might be supposed, first "defended" themselves (the capture itself took place for 996 years), and only then... As an extreme means. And, apparently, two Ebr Moons also appeared to be "affected" (in them higher-octave generating complexes were located), which were named Lel and Fatta. The first was destroyed "without damage" for the Earth, but the second...

Midgard-Earth had (and saved from "prying eyes") the protective contour of the slab (without breaks) of 240 km thick. The outer contour, at that time, as a protective layer, saved during the invasion the planet Earth with an lifeless Control System, the Spirits of 224 octave and might be much more that we do not yet know. Since with the destruction of the two Moons, the Ebr lost the possibility of creating octaves of frequencies above 128, the invaders could not penetrate the plates of the protective contour of Midgard-Earth and captivate the entire Planet. They were forced to connect all the planets with galactic tubes (Svargi's needles). And all the time of the occupation, the planetary fleet of the Ebr civilization led by the Sun, as the main tug, and the satellites of the planets, as auxiliary means, "dragged" our Civilization Cluster to their native base (the planet Sur Ursa Major) for the final capture and realization of all their plans .

Fallen to the ground fragments of the Moon Fatta could not cause volcanic eruptions and tsunamisthere were no conditions. But ***to leave a good "dent" on the 240-kilometer contour of the protective firmament of the planet,*** if suddenly it was, then maybe they could. Think about this: the remaining third Moon, as an artificial object and at the same time a spacecraft, has, according to indirect data, including a scientific one, an outer case with a large content of titanium in its spectrum of radiations, and hollow inside. It is reasonable to assume that in case of a break, some of them had to be burned down, and the rest could hardly have caused serious damage to the Earth. There remains a variant of a blow similar to the whole Fatta construction (should we look for it in the area of the Mariana Trench?), If... Although there are still a lot of questions, both of historical and physical character related to the possibilities of the protective contour of the Earth and the fallen Fatta, as well as the ability of the proto-Man of that time to affect matter and space that way.

As for the change in the inclination angle of the axis and the period of rotation of the Midgard-Earth... In the presence of even one Moon, the axis of the planet could be shifted with the purpose of synchronization of the control complexes of the Moon and the Earth (change of poles). Let's return to this a little later...

The ensuing destruction of all the life-support structures of the Planet's Brain resulted in an almost complete loss of the people's Brains potential (lowering to the level of **3%**). In a short time this led to the elimination of all inhabitants of the Earth (**up to 1 billion**), flora and fauna, capture of individuals who were in a non-inertial state. Further – pouring magma,

water, sanding the surface and other "delights" of intervention, which we continue to "reap" to this day.

Before proceeding to the presented tables, take a look at the well-known maps from the Mercator Atlas, which still show Daaria (he, it seems, copied them from the pyramid wall in Giza, only this picture was not seen anymore; there are other versions of the appearance of the map) And there is plenty of water, and continental difference is present.

And one more thing: one part of the continent (from the "European side") does not have a clear mountain "edging". As if it is the continuation of another territory and Mercator knew about it. True, there are other maps with a clear "edging". Which are true?



And here is the first globe of the Earth, executed by Martinus de Bohemia in 1492. There was no America yet on it, but there is Daaria and it is connected to the mainland by two islands, it looks like the Euzrazian.



Let us recall one more map of the world, created in 1513 in Constantinople by the Turkish admiral and great lover of cartography Piri-Reis (full name – Haji Muhiddin Piri ibn Haji Mehmed) and available to modern people. Its part, which depicts even the coast of Antarctica Continent, has no ice cover, which indirectly indicates that this territory could be inhabited. Currently only a few pages are available out of the whole world atlas.

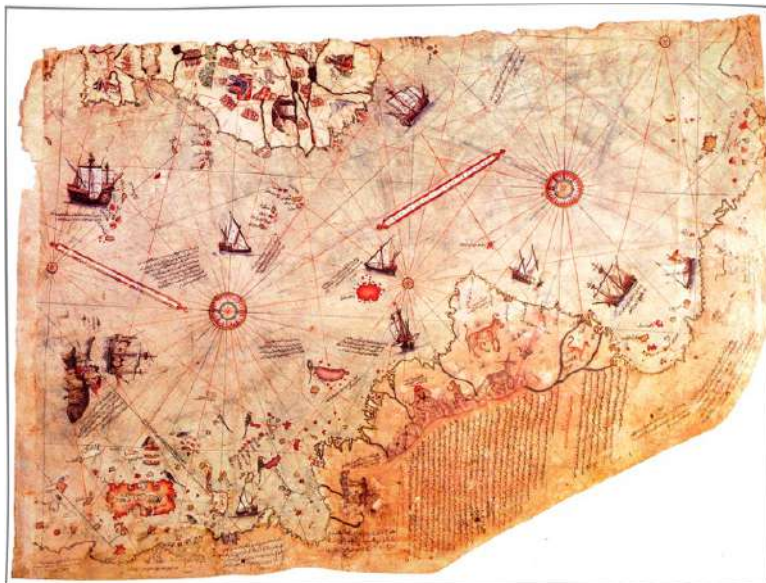

All of the above maps and globes made from 500 to 600 years ago on the basis of other, more ancient genuine original maps and documents of the stories of the unnamed travelers which, and this is not surprising, **unfortunately "did not survive"**... It is no secret that almost all historical documents according to the legend of "equine" science are **COPIES OF REAL DOCUMENTS, WHICH ALSO ARE MISSING**

NOBODY KNOWS WHY. Therefore, strangely enough, everyone uses "preserved" copies. Even here, the parasites leaders were not original, both with the copies, and others, they did everything according to the same pattern: "the more monstrous the lie, the faster they will believe in it."

Let's go back to continental differences. As is known, the initial continental difference appeared only in the period of **the first "Civilization" (17304-16684 BC)** and only at the locations of the delivered (transported) and installed (the primary stationary) interventionist Control Complexes or objects (by raising the surface level by 4300 m compared to today's). And the territory of the preserved (formed) land after its primary filling with the imposed water with tritium occupied only 5-6% of the total surface area of the planet.

And only in the period of **the second "Civilization" (13954-10804 BC)**, when the level of priming of the planet surface was "raised" by another 3000 m, a similarity of the continental difference of the Earth's surface appeared. But it was not the primary one, since the main reason for the "continentality" is the "earth-digging": to supply tritium for the interventionist objects there were formed kinds of "pipes" with a diameter of 300-400 m, which still exist at a depth of 2200-3000 m. But the coincidence of the "curve pattern" is only a consequence of the form of scattering of radiation frequencies, the formation of chemical elements at the ionic level, "piled up earth", and the like.



And this is only the first part of the questions concerning Daaria. After all, there are still studies by amateur authors, and not only, which very convincingly prove that Daaria has still been existing... not far from Murmansk in the vicinity of Seid Lake on the Kola Peninsula. There are photos and videos of enormous geoglyphs, the ruins of megalithic buildings, as well as the results of three expeditions in 1921 (Alexander Barchenko, head of the Laboratory of Neuroenergetics of the All-Union Institute of Experimental Medicine, conducted at the initiative of the OGPU), in 1997 (under the guidance of Doctor of Philosophy Valery Demin) and in 2012 (Yuri Kudinov).

From the point of view of logic one can state the following: If Daaria had existed before the attack, then as a result of Fatta's fall, it could not have "plunged into the abyss", due to its absence. And the "path" for the Pascha Festival – the walk all over from Daari to the region of the future Asgard of Irian – should not have been then. And to survive 11 km of landfill up of the Earth by the interventionists and the World Flood – it would have been too much.

Rather, it is the fate of individual groups of residents who, at least, definitely "stood" under the onslaught of the first violent "civilization" of Midgard-Earth.

Hence, Daaria could be created by those who came to Midgard-Earth after the interventionists completed the "engineering works", but before the Ebr creating their Control System, that is, after **6234 BC**. Or by those whom the Native ECS could materialize through the "gaps" of the Ebr defense and the layer of magma.

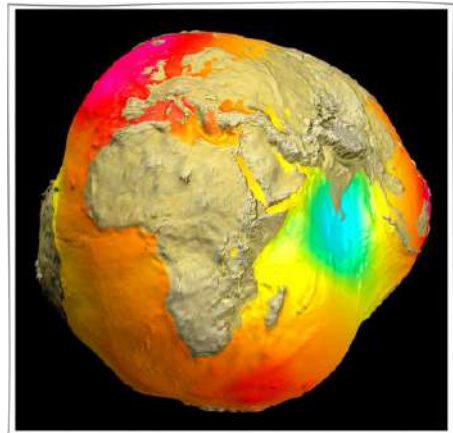

It can be assumed that **Asgard of Da'aria** had similar protection as the later **Asgard of Iria** (as N.V. Levashov determined, it at least once had saved the city from a powerful tsunami), which the Ebr could surmount only **in 1530**. Therefore, for the destruction of Asgard of Da'aria the Ebr was forced to use "unusual" means. Judging by the nature of the consequences, it is possible to admit the use of something "tectonic", and the fact that the land began slowly sinking allowed the inhabitants of the island to move "to the continent" and found **Asgard of Iria**. As for the data available in the

SAV⁴³, that at the time of the catastrophe some inhabitants used the Gates of the Worlds and another part of it by the Whitemans, then it is possible to assume this in view of the presence of a protective cupola... A "side effect" of the means of destroying Da'aria could be the displacement of the axis of inclination of the Earth rotation and the change in the duration of the day and the rate of the free fall (otherwise in the place of Da'aria on the map of Mercator there would have been an icy "desert"). In this case, the period before this catastrophe should have been marked by a special "gigantism" of the terrestrial flora that was destroyed as a result.

The legends of Daaria could be preserved by the people of Asgard of Irii, from whom the map first came to Atlantida and then to Egypt, where, it is believed, Mercator saw the map with Da'aria on it.

The history of Da'aria and Atlantida is also disputed by some amateur authors. In their representations, Atlantida could have existed earlier than Da'aria and quite near it.

In the annals of the two "continents" there are inconsistencies with the materials from the FFH ("Foundations of the Formation of Humanity"), taken as a basis for the study. And they are serious: they do not even have a hint that the fragments of one of the Moons fell to the ground and made something sink as well as the existence of a continent called "Da'aria", or under another name

Adding up, minutes, days, months and years make a "backbone" of historical events, on which we are trying to restore them. But only before the attack, ***the day on the Earth was 48.64 hours, and the year = 864 days relative to the clock charge oscillation rate of 1.007 s.*** The moment of changing the time parameters: the imposition of the format 24-60-60 is carried out by the Ebr after the attack and can be related to a major planetary catastrophe. But the exact moment when this happened... And how many of them were... Were they related to the disappearance of Da'aria and Atlantida?.. And these are only the catastrophes that we know about today, and it is presumed.

Here are the primary sources – the colonization of the planet based on the materials of the scientific research institute "The Center of Preventive Strategies – "CPS" – **40-45 thousand years ago, SAV – 460 thousand years ago.** And in general, in the CAB there is not any mention of the attack

⁴³ Slavic-Aryan Vedas.

of the Ebr civilization and the subsequent occupation... But it is said that the first "settlers" were located at the north pole and called this place Da'aria, that is, they were to appear after the attack, maybe, because of the fact that geographically the North Pole before the attack was located elsewhere, and not at the place indicated on the map of Mercator.

And what about the other events contained, for example, in the writings of **N.V. Levashov** or in other books now banned in Russia? Did they exist? Probably, they did: ***the methods used by N.V. Levashov to get the information about the past are too serious***. And, maybe, the question is only in their dating or other circumstances, while hidden from us. If, with the changed duration of the day and year, everything is clear (with the exception of the time from which it is necessary to start counting), then with the cycle of charge oscillations is much more complicated. In the native civilization, it =**1.008 seconds**, in the Ebr =**1.007 seconds**. And the methodology for recalculating dates in view of this fact is not yet available to us.

As for the tasks set for N.V. Levashov... ***"He was entrusted with a very important and responsible function: on the available linguistic level to speak out as a "Destroyer" of the stagnant "granite derangement of mind", relying on materialistic methodology on formation worldview of the truth" of the "World Created"***. He fulfilled his mission brilliantly. Nicolai was allowed to give an understanding of the other truth of the "World Created" at a simple level of superficial language usage. He coped with this task".

Let us look into the migration of people of Black, Yellow and Red Races from different planets of our Universe to the Midgard-Earth. According to the data available in the **SAV**, this occurred approximately **38,000** years ago. However, in this case all the "migrants" together with the inhabitants of the Earth had to be destroyed after the attack. That is, the colonization by the "guests" was to occur later, most likely, within the framework of the Ebr programs for the development of energy biogenesis and brain genotypes. Earlier, it was impossible to place independent Control Systems on the Earth for Yellow, Red and Black Races because of the lack of technological developments.

Another significant event from the standpoint of today's hisTor(ah)y (and partly preserved in the people's memory) is ***the victory of our ancestors over Arimia***, which was so significant for the Aryans that a new chronology began from that date. But over whom is the victory? The

Chinese, as such, appeared much later (along with the Koreans and the Japanese). And before that, the Ebr objects 440 annihilated the arimians (?), turning the territory of their settlement into a desert (Gobi?). That is, it turns out that they fought not with the "ancestors of the Chinese", but with those who populated this territory before them?

Another point connected with the graphic display of the victory over Arimia. The Russian warrior strikes the snake with a spear; the second hand holds the reins. According to the same N.V. Levashov, one of the virtues of the Russian warriors – knights – was "two-handedness": they controlled the horse telepathically, which allowed using two hands to destroy the enemy. And what's on the icon? The subsequent interpretation of the icon painter of the event through the prism of knowledge of that time? Already greatly distorted?

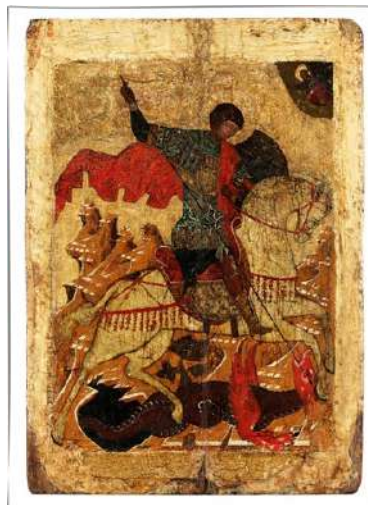

No less mysterious is the history of Atlantida. According to the assumptions, it came into being after the exodus of a part of the inhabitants of Asgard of Irii and after the appearance of representatives of the Red and other races on the Earth. The very technology of destruction of the emerged civilization is very similar to the technology of destruction of Da'Ariansthe island's sinking to the bottom... "Atlantida did not die of its free will and internal reasons, but it perished due to the intervention, but with the Atlántians's powerful resistance and defense..." Yet, Atlantida was supported for a long time by the native System and, moreover, the Interventionist System did not seek to destroy it immediately, since a variant of the possible use of the atlantians in their reincarnated version was envisaged. But the interventionists did not succeed, so they had to destroy Atlantida. Judging by the appearance of representatives of alien races on the Eath, the idea could come to the Ebr about conducting their own experiment with people by analogy with what was conceived by the Civilization of Reasonable Orientation. Only the goals were different, so mixing "Rus" ocured with genetically "weaker" material. One of its results – the creation of a gray subrace – can be considered "successful". The "red" race played its role in the Ebr plans, as well. As for the saving of some of the "leaders" of Atlántida, it could have been the result of the true Control System interference (in fact, the rods of iron were taken

from them), as well as their transfer to the territory of Egypt with the preservation of information about Da'aria (if they had it).

WE DO NOT KNOW, AND MIGHT NOT KNOW FOR QUITE A LONG TIME the true chronicle of events on the Earth, but with absolute certainty we can say today that the inhabitants of the civilization cluster of the Earth are genuine Humans, true heroes, who have done a lot for all Civilizations of Intelligent Orientation and paid not only their lives in their specific physical embodiment, but also a halt to the Spirit development and, perhaps, even the destruction of some of them. To comprehend this is the first task of Mankind after gaining its true state.

As for the rest... When humanity figures out the "basic", then it will sum up the "totals"... There is full confidence in it today.

* * *

The process of the "interventionist" development occurred with imitation of a reasonable civilization. Considering the period from 2000 BC to this day (that is, excluding everything from the analysis that preceded it as a test for the part of the interventionists), let us focus on the key points related to the fundamental program changes implemented under the interventionist control and supervision. The Programs realization through the operation of the Control Complexes was carried out strictly in stages with the aim of forming the set results, that is, the genotype of the Brain determined according to its parameters. The rest, including the habitat, and the so-called animal and plant world, were given as the complementary for the whole process. Different stages of a complex sequence of actions were controlled and governed by different, strictly defined complexes and had a rigid territorial reference. The table shows the entire sequence of the actions with some of the currently admissible details.

**Table of formation of the illusion of Interventionist civilization.
Step-by-step realization of the Brain genotypes**

2000 BCo .	
2000 BC	The Interventionist Control System begins the implementation of the Program " Energy Information Dialectics of the Brain Genotypes development ". Coordinator of the work on the creation of the Atmosphere Brain was the Complex Caucasus , therefore all major and well-known deposits are around the Caucasus..
2000 BC1605 BC.	The period of creation and natural perfection of the "shirt" (bodies of people). All values were program- determined and dictated by the objects of type 440, orienting the entire being of people for the preparation and improvement of the organism to the state suitable for the settings of the functional future of the Brain genotype 421 .
1605 BC.882 r. BC.	Formation of Brain Genotypes.
1600 BC	The Brain genotype 421 was formed under the control of the Ararat Complex (Caucasian Control Complex). The region of coverage of such an experiment is Asia Minor, Greece . The process control center is Jerusalem . This group of individuals began to develop some judgments and ideas about the so-called soul . In those old days, there were even questions arising about what the soul was in reality, the way it relates to the surrounding objective reality , i.e. with the world of objects around. The beginning of the process of the withdrawal of people from the state of the " Cupola Control " of their being through the objects of type 440 and all energy-information translation from the Caucasus Control Complex (CC) . The imposition upon the minds of people of "conceptual" elements of a certain apophatic "Supreme Power" , as if controlling them from "Above". There began the formation and further application of some constantly improved technical "methods" of the control of all the actions of people through bringing them in the state of obedience, humility and guilty ". Conversion of the general guiding state of people's Brain of that time to the level of the minimum possible energy octave (up to octave 63) of its material (proton) and non-material (neutrino and antineutrino) states. The native state of the Atmosphere Brain is octave 84 , and of the structural Brain – 96 octave . Activation of energy-information translation and the Brain control through the cubic base gratings (in the control layer - 4200 m ÷ +14800 m) in octave 63.
500 BC.	Start up the formation of 422 genotype of the Brain. Through the philosopher Parmenides, in the Kazbek Control Complex translation, there shown the judgments about consciousness as a special reality which is different from material phenomena. This "tradition" was continued by Socrates, Plato and other philosophers
882 BC	Formation of the Brain genotype 422 under the control of the Kazbek Complex (the Caucasus Control Complex) on the territory of the eastern and southern Caucasus, Central Asia and

	the East of Asia Minor. Developing the advantage of one genotype of the Brain, provided and supported the predominance over it of another one.
01433 AD.	
o.	The Elbrus Complex created the genotype 423 in the year 0 (January 17, at 02.11), completing the formation of the first group, i.e. the Brain genotype 42. The Brain genotype 423 – as more perfect. To solve the problem of prolongation biological life to certain groups of individuals, the old Control System was not able to; the approach to the fourth codon of DNA was not found. Therefore, the programs " Reincarnation " and " Christ " are introduced.
01433 AD	The program: " Reincarnation ". The Protection program: " Christ " (connection with the cubic structure of the atmosphere and provision of reincarnation, between the shirt and the matrix there is intermediate frequency is 51.5 Hz). The Program: "The Power of Money" . The central control server is Byzantium . The Brain genotype 423 is endowed with up to 12 language translators to communicate with other ethnic groups. Construction of specialized terminals – churches, mosques, Buddhist temples and temples of science. When creating the information network, initially in some nodes of the Hartmann zone there were placed information translation concentrators in the form of the ball . The diameter of the ball – from 2 to 33 cm, it had the properties of a piezo element. Under the control of the Andes Complex (a separate settlement of the " Maya "), a temporary specific task was worked out – the approbation of individual mantissas of future Brain Genotypes.
Spring, 385 AD	Through the Elbrus Complex , the main Control instrument is from the Almighty . The main control burden is on religion (as the basis of spiritual and subjective values).
1433 AD	Completion of the stage of development and improvement of the Control sphere.
14332000 AD	The startup and development of the program (the term of execution is 500 years): " The Formation of the genotype completely controlled by the Interventionist Control System ". With such a program development, the return to other modes of the Brain development is completely excluded. The conditional name of such people is electronics, i.e. with a chip in the "shirt".
Spring, 1433	The Alps Complex – the introduction of the Brain genotype 441 with the addition of mantissas of a different order. It is an intelligent, thrifty and very cruel genotype both in decision-making and in actions to implement them. It is characterized by a more subtle logical structure and a higher level of functional ability in getting information. The Program: " The Force of Power ." The religious methodology of values gave way to secret orders and clans with a halo of "selectiveness." A sharp rise in "scientific" knowledge, new technologies, which led to the emergence of machine production. The program " The Power

	<p>of Money" receives an expanded development and power function. A push in the development of banking and the formation of elements of the world financial system. Under the dictatorial influence of sacred orders and clans, the replacement of the whole basis of subjective values.</p> <p>The slave use of Man of economy, inability to solve social problems.</p> <p>The realization of the programmed process of the division of labor.</p>
End of 1840	The individuals of the Brain genotype 441 lose their leading control positions.
18411990	
1841	<p>The Alps-2 Control Complex is turned on and the introduction of the Brain genotype 442 with an aggressive, destructive character. The stage of hegemony of the bloody genotype 442. The completion of a long stage of the development of the "Golden Billion" program process. The start of the control program "Ideology", which ensured the further formation of public consciousness in people without the influence of religious dogmas through the economist Destutt de Tracy, and later through K. Marx, F. Engels, V. Lenin, and subsequently joined their theoretical heirs. The program bases of the world outlook on the liberal (capitalist) and separately communist construction of the Structures of the organized being of people were imposed, that is, the separated types of their civilizational development. For each type, their "bright future" was presented.</p>
1845 AD	<p>Making radiation web (the most complicated design of energy gratings in the layer of "-4400 +12400 m"), covering the Earth. The people (and animals) that have a connection with such a web are conventionally called "electronics" (according to the old Program). So, the first goal – on the Earth only electronics should be left, the rest should be subject to destruction.</p>
18881999 AD	<p>The start up the program (the term – 100 years): Cosmopolitanism. The establishing of a single financial control, a common ideology for all Brain genotypes 421 (Ararat), 441 (Mont Blanc, Alps) and a common system of information perception by making legends, "archaeological" miracles, destroying all structures and bearers of a different ideology. Development and creation of a single mechanism for the society control, approbation of technologies for the control: capitalism, fascism, democracy, liberal democracy, socialism, and so on. Ensuring the control over all raw materials. Crating conditions for the arrival of the Ruler of the Earth (Moshiach).</p>
18411990 AD	<p>The realization of the program: "The force of power." A bloody stage-by-stage path: Revolutionism (until 1904); Militant fascism (until 1946); Destructive democratism (before 1990). Development of technologies for the production of weapons. The programmed social and administrative constructions of the local and global plan are created. The necessary volumes of</p>

	<p>accumulation and concentration of the financial resources control and the circulated produced substitute are ensured in their hands. A different social status is prepared for the "Golden Million" future. The publication of the Manifesto of the Communist Party, the uprising in Paris, the Civil war in the United States, the organization of the First International, the attempt upon the life of the Russian Tsar and many other events – are the organized and realized program processes of the old System (until 1904).</p>
19141995 AD	<p>The selectivity by the Brain Genotypes 42-46 is to be brought to the level of 22% of the total population of the planet. The execution is a success. Violence at different levels (from the systemic to the worldly one) is not a real natural civilizational and unconditional necessity, a reward and a certain "historical regularity" for the whole world community. This is an imposed program-executing illusion of information-control character for giving to all subsequent processes of civilization development strictly regulated actions and events related to the implementation of the programs of the Interventional Control System and not more!</p>
Spring, 1917	<p>The replacement of the control staff in Russia through the Genotype 442 with a revolutionary manager. The February Revolution, the October Revolution, the First World War, the seizure of power by the fascists in Germany and Italy, and the Second World War (until 1946).</p>
1919	<p>The program of the systemic control on imposing the world outlook on the basis of a tough social parasitism is turned on, which is further manifested through various theoretical and practical forms of fascism.</p>
19291946	<p>The Program: "Elimination of 50 million of the used and unwanted individuals, as consequences of the program process of energy biogenesis of the flesh cell". Entering into an active phase of execution in 1934. The programmed support of the two governing spheres of being – socialism and capitalism.</p>
19461990	<p>The mutually-regulated antagonistic phenomenon of the programmed development of two special target spheres of being – capitalist and socialist, – as a single controlled realization of the Brain Genotype 44 process of development. The accomplishment of the generalized preparation for the transition to a unified system of power and control on a liberal-democratic basis, which is to provide the basis for the next stages of the development of the Brain Genotypes. Bringing to the state of controlability the World Financial System, the unification into a single state of controlability of "the power of money and the force power". Transition to electronic controlled accounting and electronic money. Money takes on some properties of independence. A digital basis for constructing the design of the System control information, through the provided knowledge without gaining a deep awareness of its essence. Introduction of the basis of digital technologies aimed at replacing some of the Brain functions and preparing for the transition to another level of separate genotypes control at the subsequent stage. Jointly acquired is distributed according to the</p>

	quality of the Brain genotypes, the retention process is not only senseless, but also inevitable.
End of 1989	The final stage in the formation of the "Golden Billion" (Brain Genotypes 44 and partially 42).
1990-2009	
1990	Activation of the California Control Complex to start up the development of the Brain genotype 46 – the "Golden Million". The first Brain genotype 461 is obtained. The main task: creation and improvement of a specific genotype of the Human Brain in the quantities planned by the program for the specified time in order to interface with the Brain of the interventionists. A special legal basis for the existence of these individuals and the execution of the programmed functions under the conditions of an unquestionable legitimate state of "FAS", as power from the Almighty. Supporting and ensuring the cleansing of the entire power pyramid for the program actions of the "Golden million".
2000	The beginning of the liquidation of "set control programs" on separate Complexes and objects of the old System, simultaneous earthquake in Israel, northern Italy and Australia.
October 25, 1985 Autumn 1995	The accomplishment of the program for the formation of the "Golden Billion" (the term of execution is 500 years). By this time, the electronics were to get a new Brain , and the rest – all kinds of diseases with a further accelerated finale through an obituary. Attempts to find out the truth, i.e. to show initiative in getting information, were nipped in the bud by the System and in a tough way. By autumn 1995 A. Khatybov developed a software product that allowed to decode all information from the true Earth Control System , coming and built on the basis of combined signals of the musical series.
April, 2001	Elimination of the failed Development Program of individuals with 462-466 genotype of the Brain. N. Levashov's active participation in this process.
2005	The transition of the program of "Tough Social Parasitism" into a triplee fascism, namely: financial, administrative-bureaucratic and national-demographic.
2006	Activation of the program for the formation of the "Golden million" . These individuals were to have perfect protection and a direct connection with the Ebr Control System . It was planned the reconstruction of the regulation of their life by the Ebr Control System up to the achievement of practically eternal life . Formation of a sufficient number of the security forces to eliminate the instigators of revolutions, rebels and terrorists, which are inevitable at a transitional stage. N. levashov's return to Russia.
August 2012	Planning the beginning of the 3rd World War for the execution of the program: "Elimination of all individuals not belonging to the 4xx genotype of the Brain". <i>The end of the liquidation is planned by December 2012. The execution did not take place! In parallel, the process of a revival of the true Earth Control System is under way.</i> The two-way information exchange is being restored; it becomes possible to introduce some elements of technical support at the stage of direct reception of information

	from the System. Any revealed fragments of non-system information, unauthorized by the Interventionist System, are subject to liquidation together with the performer. <i>The beginning of the application of the "SvetL" Programs in the complex version – healing-transformation of the Brain.</i>
2005	Beginning of the practical realisation through the true Systemic level of the the control: "The Fundamentals of the Formation of Mankind".
April 2007	The Interventionist Control System makes New Protection for the " Golden Million ". It was planned to put the Ebr Spirits in the "shirts of the SuperJudaic priesthood (the government elite). The system of the parasitic Earth "energy sucking off" at the California Control Complex is disconnected, and this year the information communication channel of the Control System is transferred to the Russian language .
2009 .	The attempts to introduce the Brain genotype 46. A large-scale failure in the Interventionist Control System. The energy pumping up system for the radiation gratings in the "imported" base octaves is turned off; the process of natural dispersion is short.
November 13, 2009	<i>The Atmosphere Brain of the old System is liquidated.</i> The process of energy-information translation in the range of 15 – 128 octaves, which provided the control of the people's performing actions, is stopped. The start of the process on creation of a new living space, under the control of the being reconstructed Altai-1 Control Complex with involvement for some episodes of the control of the former Sichuan , Kailas , Ural, Alps-2 Control Complexes , and less often – the Bermuda CC.
January 07, 2013	The Control Complex Altai turns on the New Program "The Investment that was Shown" instead of the Interventionist Reincarnation". The Individuals with a 4XX genotype of the Brain can no longer be invested. New "SvetL" Programs are created for the Users Brain transformation.
June 22, 2012	The CC Caucasus, Alps-1, and California 1 are turned off. Completely disconnected and partially destroyed is the Andes CC, which earlier provided the control of the metabolic processes in the biological field in the framework of the program "Development of energy biogenesis of the flesh cell". The cleanzing from the former influencing states of gene modeling is activated. The quantitative development of individuals with 4XX Brain genotypes is stopped.
2010	The fundamental program corrections in the processes of the Interventionist System control are made by the Light Hierarchs (of the intelligent Civilizations) There began an active process of returning the future of Humanity to the harmony with the first program substance of the Supreme Mind state. N. Levashov creates and begins the Complex "SvetL" approbation.
April 24, 2011 г. June 24, 2012	The final change of the System Power. The complete elimination of the Earth alien intervention.

entionally October 12, 2012	The true CC Altai turns on the program process, which should be conventionally perceived as the " Eucharist ", which means Thanksgiving when translated from the Greek language – Grateful "reward for all that has been created before". It is in the active phase until 25.10 2012.
14.04.201325.10.2013	The true System of the Earth begins the child-birth control.
08.05.2013	The supported energy-information translation on the part of the control servers to form a new public consciousness across the territory of South-East Asia and the west coast of Latin America, as the first stage.
23.10.2013 .	The installation of the new programs of the control and supporting impact on the parts of the stored objects: type 400, their terminals and control servers (under cult temples and structures). The change of parameters not only to support the information of the control character, but also the inclusion of the frequencies that facilitate adaptation to the new construction of the energy information translation, including adaptation of a biological nature.
23.11.2013	The beginning of the process of the zonez formation by the Control Complex Altai: the main part of Southeast Asia, the territory of Russia with part of the Arctic, a limited part of the south of Europe, the west coast of Latin America and the Antarctic zone. The exact geographic outlines of these zones are available, the control servers are activated.
January 19, 2014	There began the process of liquidation of the "Parasitism and Violence Program" as well as the programs that previously provided the controlling predominance in the society of the individuals with 4xx genotype of the Brain, a decline in states when supporting their actions, having the character of a parasitic influence on the social society constructions of various scales. Desactivation of programs at the objects: type 560, 520 and 500, at their information terminals and control servers. The work begins to create the "SvetL" Complex of the second generation.
April, 2014	The beginning of the parameters correction of the energy pumping up of the Earth. The change of values of mantissas on all base frequencies in the range of 15 to 128 octaves (the true state reconstruction). A significant increase in the intensity of pumping in the true energy octaves of 224 to 512 . An active reconstruction of the true states of the Earth energy harmony.

The conclusion is one – either we keep up with the ongoing events, understanding them and accepting them, or taking the way leading to liquidation. There is no third option!

Mankind: chronology and histor(ah)y

Date The Ebr ECS	The event, the program	Date The true ECS
	Civilizations of the Intelligent Orientation created the Cluster – interplanetary System of the Earth (Midgard-Earth, Mercury, Venus, Mars, Phaethon, Jupiter, Saturn, Pluto, Neptune, Uranus). The earth was moving, focusing on Sirius at a distance of about 240 billion km.	More than 2 billion years BC. 10 billion years of construction
	The beginning of the civilizational development of the Earth model according to the Intelligent orientation: - Population of the planet Earth by Proto-humans. - The beginning of the Program of Guardianship in Civilizational Development by the Orion Civilization Group.	4000045000 BC
26844 BC	The Star fleet of the Ebr System from the constellation of the Ursa Mayor (Sur) approaches the Cluster Interplanetary system of the Earth	
	The switch of the Guardianship Support Programs in civilizational development from the group of Orion Civilizations to the group of Civilizations of Sirius.	
18344 BC	The beginning of the capture of the Earth Interplanetary cluster. Within 1040 years all of the planets were completely captured. The invaders linked all the planets with the gravitational tubes (later with the communication tubes), turned on the imposed base generating frequencies of the Sun radiation protection, surrounded the planets with “satellites” (as a guard convoy), and started moving towards the Big Dipper.	
18300 BC	The capture of the Earth by the forces of the remaining interventionists star fleet. All the Planet’s Brain life support structures are destroyed, her Brain lost potentials to the level of 3%, which later in a short time led to the elimination of all inhabitants of the Earth. Destruction of the true Earth Control Complexes located on the surface. Destruction of life support systems of Mars. Turn off the life support systems of other planets. Formation of a system of satellites around the planets. The beginning of the change in the structures of the captured planets.	
17914 BC	The completion of the planets capture.	
17304-16684 BC 3960 years	The first stage of the violent "civilization" Of the Earth. The insulation of the protective contour slabs with a layer of magma. The first "pouring"	

	of the Earth surface with "their own water" (containing tritium) and the formation of sand out of this water. Formation of the Interventionist Control Objects on the Earth surface.	
16684-13344 BC.	Formation of the World alien to the Earth, based on parasitism and violence. Completion of the first stage of the violent "civilization" of the Earth. Completion of the first Ebr attempts to create people with subsequent annihilation of the entire "experimental material".	
13954-10804 BC	The second stage of the violent "civilization" of the Earth. The interventionist imposed program of the "Energybiogenesis of the flesh cell" acquired a more substantial capacity in the intensified attempts to create people. The main emphasis was placed on attempts to control the Brain of people by means of primary energy-information translation of the controlling character through objects of type 440. The water acquired only fresh state, and its quantity was increased by many orders of magnitude, the former mineral inclusions practically did not exist anymore, moreover, it was the carrier of tritium . The level of priming of the planet's surface was "raised" to a higher level and reached a value of $h = -3000$ m (relative to today's level). As the continental areas expanded, interventionists began active attempts to form flora and fauna as a complex element and process in the overall "civilization" development of the Earth. Due to the negative results of the "civilization development" in the part relating to people, this so-called (not by us) "Second Civilization", was annihilated within a few days.	
10194 BC	The completion of the second stage of the violent "civilization" of the Earth. Annihilation of all the experimental individuals.	
13344-10194 BC	Attempts to combine the flesh of people with the Brain abilities of spiders. Settlement of people in the zones of objects' 440 reach and attempts to control the Brain of people through these objects.	
10804-10604 BC.	The process of program preparatory organization and partial program correction of control functions on the created Control Complexes and the placed objects for the transition of all subsequent processes of changes to the Third stage. During this short period, the first samples of "native" (lunar) humanoids (in their non-inertial energy entities) and some species of fish and birds were transferred by several "deliveries" from the Moon.	
10604-6534 гг. до н.э.	The conventional "Third Civilization". The stage most satiated with experiments in all areas: from	

	<p>the formation of sustainable intervent control in all directions of its own civilization development to attempts of introduction of independently created elements in the sphere of flora and fauna (taking into account the obtained humanoid fragments from the Moon).</p> <p>In total, 42% (approximately 400 million) of captured humanoids (energy-information soul entities of proto-Human with a former brain level of 96-124 octave) were used for the experiments. The implementation of only one program "Development of the energy biogenesis of the flesh cell" was continued. In the Atmosphere gratings all along the perimeter, the processes of arranging "the Atmosphere Brain" began to impart some kind of primary guiding of people's being without binding them to objects of type 440. But during this period it was not completed. People were brought to the state of metabolic processes provided they were suitable and capable of carnivorous (for all that, without heat treatment of the food they used). Significant results in the reconstruction of people, in the image of the proto-Man, but completely subjugated by all his life and suitability for replacing the combined design of his Brain with the Invaders' Brain design, was not achieved. As a consequence, within several days this phase was stopped in 6534 BC, and the entire experimental base was eliminated</p>	
<p>6534-6234 BC</p>	<p>The preparatory process of the program re-organization of the control character, as well as stripping from the consequences of the experiments. The surface of the Earth was filled up to h=-1200 m (relative to the current level), 8640000 power buses of the inter-polar direction were laid on the formed surface, connecting all Control Systems and placed objects, and nodes (control servers and energy distribution servers) were formed. After this subtle engineering, all the complicated "installation" was filled up to h=-100 m. Masses of water were brought down to the Earth, and from this moment the sea water (the "World Flood") was formed for the first time. The surface of the Earth took forms close to the modern one.</p>	
<p>10604 г. BC</p>	<p>The Third stage of the violent civilization of the Earth. The general vector of the goal of the Interventionist ECS for all subsequent stages of its development "From an individual disunity to the integral collegiality". In the Atmosphere grating the processes of arrangement of the Atmosphere Brain began in order to impart some kind of</p>	

	primary guidance in people's being with no reference to 440 type objects. The work was not completed within this period.	
6234 BC	The completion of the Third stage of the violent "civilization" of the Earth and preparation for the fourth one.	
	On the northern continent of Midgard-Earth, a colony of white people was founded (H'Aryans, da'Aryans, Rassens and Svyatorsy)Da'aria, Asgard of Daarius was built on the summit of mount Mir (Meru).	
	Destruction of Da'aria by the Ebr. The beginning of sinking of Da'aria to the bottom of the North Ocean-sea. The beginning of migration to the Eastern Siberia. In the place of the confluence of the Iri (Irtys) and Ob rivers, a new city of Asgard of Iri was laid.	
	Migration of people of Black, Yellow and Red races from different planets of our Universe to Midgard-Earth.	
	Atlantida came into being and perished.	
	Peace treaty between the vedic empire of our ancestorsthe Great Race and Arimia. The beginning of the chronology from the C.P.S.T. (Creation of Peace at Star Temple) (approximately coinsides with the chronology of the RaceV.A. Chudinov) – 1747 years before Adam and Eve.	5508 BC
	5500-2316 BC The appearance of the first Sumerian cities: Eridu, Bad Tibira, Larak, Sippar and Shuruppak. Fayum culture of farming and cattle breeding (the region of the famous Fayoum oasis today), Lower Egypt. Toshi culture of farmers-pastoralists tribes of Badori, the Upper Egypt area Ugarit, Ebla, Akkady (Sargon the Ancient). 3000 BC The foundation of the city of Athens.	
3500 г. до н.э.	The fourth stage of the violent "civilization" of the Earth. The Control System began to reference the "cupolas" to the atmosphere layer No. 2 . Obtaining the basic radiation frequency for each ethnic group (more than 100), in relation to which the atmosphere layer No. 2 was re-formed. The number and size of each ethnic group were brought to the Program value, primary styles of life (culture) and the boundaries of this group were introduced with reference to the layer of atmosphere No. 2.	
	3100-1800 BC Egypt: the rule of Menes (unification), the ancient kingdom, the emergence of Indian civilization,	

	the Minoan, Mycenaean and Aegean civilizations, the Middle Kingdom of Egypt (Amenemhet III).	
	The first campaign of the Aryan tribes to Ancient India (Dravidia).	2692 BC
	2500-1813 BC The state of Mittani, Slovensk the Great, the Sumerians: Uruinimgingins, the Akkadian state (Sargon the Ancient), guttei (Erridupizir), Ancient Babylon (Hammurabi), the rule of Shamshiadad I in Assyria.	
	The second campaign of the Aryan tribes to the Ancient India, led by Khan.	2006 BC
2000 BC	The beginning of the implementation by the Interventionist Control System of the Program "Energy Information Dialectics of the Development of Genotypes of the Brain". The coordinator of the work on creating the Atmosphere Brain was the Caucasus Complex, therefore all the largest and well-known deposits are around the Caucasus.	
2000-1605 BC	The period of creation and natural perfection of "shirt" (bodies of people). All values were program-determined and dictated by objects of type 440, orienting the entire being of people to the preparation and improvement of the organism to the state suitable for the setting of the functional future of the Brain genotype 421.	
1605 BC	Completion of the period of creation of the "shirt" (people's body). The Ararat Complex created the Brain genotype 421. The beginning of the process of people's withdrawal from the state of "cupola control" of their being through objects of type 440. From this moment onwards, if rapid program resettlement of people of one Brain genotype was required on the territories of another one, wars of any scale were organized. In those cases when for a certain period of historical time it was required to isolate the territory of one Brain genotype from another one, new states were formed, small states merged into empires and other similar formations.	
1675 BC	The conquest of Egypt by Hyksos (the descendants of the followers of the cult of Kali-Ma deported from Dravidia).	
1605-882 BC	Brain genotypes formation.	
1600 BC	Under the control of the Ararat Complex (Caucasian Control Complex), the Brain Genotype 421 was formed. The region of coverage of such an experiment is Asia Minor, Greece. The process control center was Jerusalem. This group of individuals began to develop some judgments and ideas about the so-called soul. In those old days, there were even arising questions on what	

	<p>the soul was in reality, the way it relates to the surrounding objective reality, i.e. with the world surrounding objects. The beginning of the process of the withdrawal of people from the state of the "Cupola Control" of their being through objects of type 440 and taking all energy-information translation from the Caucasus Control Complex. The imposition of the "conceptual" elements of a certain apophatic "Supreme Power" in the minds of people, as if controlling people from the "Above". The formation and further application of some constantly improved technical "methods and types" of the control of all people's execution actions began through the imposing upon them the state of "unquestionable submission and guilty". Transfer of the general control state of the people's Brain of that time to the level of the minimum possible octave of energies (up to octave 63) of its material (proton) and non-material (neutrino and antineutrino) states. The native state of the Atmospheric Brain is octave 84, of the structural Brain – octave 96. Activation of energy-information translation and the Brain control through cubic base gratings (in the control layer -4200 m ÷ +14800 m) in octave 63.</p>	
	<p>1490-900 BC Egypt: Thutmose III, Ramses II. Greek policies: Sparta. The Trojan War. Assyria (Tiglathpalasar I). Formation and disintegration of the Hebrew state into Israel and Judea.</p>	
822 BC	<p>The Kazbek complex created the Brain genotype 422. Developing the advantage of one Brain type, the ECS ensured and supported the predominance of one over another.</p>	
882 BC -o	<p>Formation of the Brain genotype 422 under the control of the Kazbek Complex (the Caucasus Control Complex) on the territory of the eastern and southern Caucasus, Central Asia and the East of Asia Minor. Developing the advantage of one Brain genotype, ensured and supported the predominance of one over another.</p>	
	<p>813-605 BC Carthage, Assyria: Tiglathpalasar III and Sargon II, Sineherib. First Olympic Games. The rising of the Roman Empire and the Republic. Egypt: Hushids, Assyria, Psammetich I. Persia. The Median Kingdom. The New Babylonian kingdom: the seizure of Jerusalem. Buddha. Greece: Drakonta, Solon and Pericles. Nebuchadnezzar</p>	
	<p>The first Appeal of the CGO (the Coalition Group of Observers) to Mankind, transmitted to the residents of Amuradzhapur.</p>	576 BC

	<p>558-30 BC Persia: Cyrus II and Darius I. Greco-Persian Wars. Confucius. Pyrrhus. Punic wars. Peloponnesian wars. Aristotle. Alexander the Great. Archimedes. China: Qin Shi Huangdi. Spartacus. The Pontian Kingdom: Mithridates VI. Caesar and Augustus Octavian. India: Chandragupta Maurya.</p>	
<p>500 BC</p>	<p>The start of the formation of the Brain genotype 422. Through the philosopher Parmenides, in the Kazbek Control Complex translation, there shown some judgments on consciousness as a special reality different from material phenomena. This "tradition" was continued by Socrates, Plato and other philosophers.</p>	
<p>0 AD</p>	<p>Completion of the creation of the Brain Genotype 422. The Elbrus complex created the genotype 423 in the year 0 (January 17, at 02.11), completing the formation of the first group, i.e. the Brain genotype 423 as a more perfect one, it became the basis for further refinement of possible additional performing functions of individuals of a higher control order and further improvement of the Brain genotypes. To solve the problem of prolongation of biological life of certain groups of individuals, the old Control System was unable, the approach to the fourth codon of DNA was not found. Therefore, the programs "Reincarnation" and "Christ" were introduced.</p>	
<p>0-1433 AD</p>	<p>The program: "Reincarnation". Protection program: "Christ" (connection with the atmosphere cubic structure and ensuring reincarnation, between the shirt and the matrix, the intermediate frequency is 51.5 Hz). The Program: "The Power of Money". The central control server is Byzantium. The Brain genotype 423 was endowed with up to 12 language translators for communicating with other ethnic groups. Construction of specialized terminals – churches, praying houses, mosques, Buddhist temples and science temples. While creating the information network, initially in some nodes of the Hartmann zone there were placed information translation concentrators in the form of spheres. The diameter of the ball – from 2 to 33 cm, it had the properties of a piezo element. Under the control of the Ands Complex (a separate settlement of the "Maya"), a temporary specific task was worked out – the approbation of individual mantissas of future Brain genotypes.</p>	
<p>4 . AD.</p>	<p>The date of birth of Jesus from Nazareth.</p>	

	4-330 AD. China: Han, the Three Kingdoms, Sui, five dynasties and ten kingdoms, Jin. Rome: Caesar, Nero, Diocletian, Adrian, Christianity. Kushan kingdom: Kanishka. Ruskolan: Rus Belayar. The Goths. Byzantium: Constantinople, the Constantines.	
325 AD.	The first Council of Nicaea.	
368 AD.	The "crucifiction" (stavrosis) of the famous Oriental scholar Asa (Basil, Jesus), the Prophet Joshua (scientist-occultist Yoshua, according to Morozov).	
385 AD.	Through the Elbrus Complex, the main control instrument is from the Almighty. The main control burden is on religion (as the basis of spiritual and subjective values).	
385 – 1535 AD	The creation of the Control System in the Gobi Desert.	
395 AD	"Apocalypse", or "Revelation" attributed to John the Theologian by the Church.	
	448-656 AD Merovingians: Merovei, Clovis, Dagobert. The final partition of the Roman Empire: The eastern part with the capital in Constantinople went to Arcadiy Flaviy, the Western with the center in Rometo Flaviy Honoria. Korea: Silla. Vandals, Huns, Ostrogoths, Visigoths, Sueves and Saxons. The creation in the Arabian city of Mecca of a Muslim community led by Muhammad. India: Ephthalites. End of the Western Roman Empire. The Nestorian church is separated from the Orthodox Christian church. Muhammad. Iran: Khosrov I and Khosrov II. Northern Italy: Lombards. China: Tang, Taizong. The Muslim state: Omar, Osman.	
697-700 AD.	Overthrow of the Tsarist Rus-Merovingian dynasty in Western Europe (Carolingians and Capetings). Sweden (Ingjald the Coward).	
	Construction of the Great Wall of China.	704-736 AD.
	710 AD. The creation of a centralized state in Japan – the beginning of the Nara period	
	The Second Appeal of the CGO to Mankind (Tkaatsetkoal).	711 AD.
812 AD.	Recording to the representatives of the Maya tribes (Ands Complex) a 1200-year program of civilization development.	
	829-983 AD. The unification of small states of Britain into a single state of England. Norway (Harald the Fair-haired). Byzantium: The Amorian dynasty. Rurik, Rise of Kiev, Russo-Byzantine wars. Roman	

	Empire: Otto I. Division of the Carolingian Empire. Bulgaria: Krum, Boris. Germany: Heinrich Ptitselov. Denmark: Harald I the Blue-teeth.	
	Svyatoslav and defeat of Khazaria.	965 AD.
988 AD	The start of the last night of Svarog.	
	988-1024 AD Vladimir I Svyatoslavich (Chersonesus, Anna, the baptism of Rus). Prince Yaroslav Vladimirovich the Wise in Kiev. Canute (England, Denmark and Norway). Partition of Russia between Yaroslav the Wise and his brother Mstislav on the Dnieper river. The victory of Prince Yaroslav the Wise over the Pechenegs.	
1086 AD.	The crucifixion of Radomir (Jesus Christ) in Constantinople.	
	1096-1261 AD The victory of Prince Sviatopolk over the Polovtsians in the battle of Pereyaslavl. The reign of Vladimir Monomakh in Kiev. The beginning of disintegration. The disintegration of Kievan Rus, the republic in Novgorod, the rise of Moscow, "The Lay of Igor's Host". The emergence of the Templars and their elimination. The Delhi Sultanate, which united a significant part of India. The Claremont Council and the beginning of the Crusades. Congress of the Rus in Lyubech. Latin Empire, China: Jin, Song. Delhi: Qutb. Genghis Khan.	
1209-1299 AD	Crusades against the Albigenses of Southern France (Provence and Languedoc).	
	1209-1425 AD Baty's campaign to Europe. The Lithuanian principality (Mindovg, Gedemin, Olgerd), Krevskaya union. Austria (Habsburgs). Ottoman state. "Moscow" and "Tver" Russia, the Battle of Kulikovo, the beginning of internecine wars for the Moscow throne. Hundred Years' War (England and France). Pandemic of the plague in Europe. The Burgundy Duchy (France). Tamerlane (the defeat of the Golden Horde). The Kalmar Union (Scandinavia). Jan Hus.	
1400-1433 AD.	The beginning of the 600-year program of Cosmopolitanism (lasted 608 years). The Alps complex created the first Brain genotype 441. The religious methodology of values gave way to secret orders and clans with a halo of "the selectiveness". "Formation of Man completely under the control of the Interventionist Control System", imparting another level of programmed significance to the control influence of the "power of money". Representatives of this genotype quickly gained a leading and powerful position in	

	all the influential spheres that determine both the organization and control of the whole being of society, broke the majority of established stereotypes of the value of methodology, statehood and law, and simultaneously began the processes of social reorganization of societies over a large area.	
	1438-1456 AD Holy Roman Empire: Habsburgs, Charles V. The Fall of Constantinople (Mehmed II the Conqueror). The war of Poland against the Teutonic Order. War of the Scarlet and White Rose in England (the Tudors). Novgorod under the influence of Moscow (Yalzhbitsky Treaty).	
1433 AD	Completion of the stage of development and improvement of the Control sphere.	
Spring 1433 AD.	The Alps complex – the introduction of the Brain genotype 441 with the addition of mantisses of a different order. It is an intelligent, thrifty and very cruel genotype both in decision-making and in actions to implement them. It is characterized by a more subtle logical structure and a higher level of functional ability in getting information. The Program: "The Force of Power." The religious methodology of values gave way to secret orders and clans with a halo of "selectiveness". A sharp rise in "scientific" knowledge, new technologies, which led to the emergence of machine production. The program "The Power of Money" gets an expanded development and the power function. The kick-start of the banking and the formation of elements of the world financial system. Under the dictatorial influence of sacred orders and clans, the replacement of the whole basis of subjective values. The slavish use of human of the economy, the indecisiveness of social problems. The realization of the programmed process of the division of labor.	
1433-2000 AD.	The program "The formation of the Brain genotype completely under the control of the Interventionist Control System" (the term of its execution is 500 years). With such a program of development, the return to other modes of the Brain evolution is entirely excluded. The conventional name of such people is electronics, i.e. with a chip in a "shirt".	
1457AD	Capture of the Earth Control System (Main Controllers Point, Chekhov) with the destruction of all who were present there.	
	1461-1517 AD Karl the Bold (the return of Burgundy to France, the Netherlandsto the Habsburgs). Charles V.	

	Spain. The beginning of the Inquisition. Colonization of America. European expansion to Asia. Italian wars between Italy and France. Persia: the Safavids (Shiites), the Ottoman Empire (hegemony in the Islamic world). The reform of the calendar (the transfer of the New Year from 1 March to 1 September). Expansion of Moscow's possessions, war with Livonia (Ivan III, Vasiliy III).	
	1462-1505 AD. Ivan III: the annexation of the Yaroslavl Principality, Novgorod, the Perm Region, the Rostov Principality, Vyazma and the Verkhoski Principalities to Moscow, campaigns to Kazan, consolidation of Chernigov, Bryansk, Putivl, Gomel and part of the Smolensk land with Moscow.	
1474 AD	A structure of "robots" is created, in the Brain of which there persists information on murder and the ability of killing.	
1500r.	Beginning of the 500-year program of genotype formation (voiced by Nostradamus). All modern science is to be subordinated only to the so-called Pyramid of Knowledge.	
1530 AD	Hordes of the Dzungar destroyed Asgard of the Iriy.	
	1552-1644 AD Ivan IV (Grozny). The First Zemsky Sobor. Elizabeth I and the English domination on the sea. Polish-Lithuanian Commonwealth. France: religious wars, Henry IV, Bourbons, Great French Revolution. The end of the Rurik dynasty. "Troubled" time, Semiboyarschina, Minin and Pozharsky. The beginning of the reign of the Romanovs, the Stolbov peace with Sweden, the Polyanovsky world with the Polish-Lithuanian Commonwealth. Thirty Years' War. Japan: Tokugawa. Ludovic XIV (the heyday of absolute monarchy). China: the capture of Manchuria, the Qing dynasty. The beginning of the Anglo-Dutch wars for supremacy in the sea trade.	
1653 AD	Nikon's Church reforms.	
	1654-1772 AD Pereiaslav Rada, Russian-Polish war, Ukraine's accession to Russia. War of Russia with Turkey and the Crimean Khanate. Revolution in England (constitutional monarchy, the expulsion of the Stuarts), the formation of Britain (the Windsors). Prussia. (Frederick II). Charles XII. Peter I, Russia – the empire, the abolition of the chronology from the CWST (existed for 7208 years). Anna Ioanovna and Ivan VI ("Bironovshchina"), Elizaveta Petrovna, Peter III and Catherine II. Prussia (Frederick II). Petersburg Convention on the first partition of	

	the Commonwealth between Russia, Prussia and Austria.	
1772-1775 AD	The war between the Slavic-Aryan Vedic Empire and the Moscow Tartaria.	
	1775-1806 AD. Accession of Crimea to Russia. The US Constitution, the beginning of dollar circulation. Russian-Turkish war (the capture of Ishmael). The Russian-Swedish war. Versailles Peace between Russia and Sweden. Jasian peace with Turkey. Recognition by Turkey of the accession of the Crimea to Russia. The beginning of the First Coalition War (Great Britain, Habsburg, Prussia, Spain, Sardinia and others v. France). Petersburg Convention between Russia and Prussia on the second partition of the Commonwealth. The transition to Russia of most of the Ukraine and Belarus (with Minsk). The third partition of the territory of the Polish-Lithuanian Commonwealth between the Habsburgs, Prussia and Russia (got most of the Ukraine, southern Latvia, all of Belarus and Lithuania) and the liquidation of Polish statehood. Paul I	
	1798-1809 AD The beginning of the 2nd Coalition War (Great Britain, Habsburg, Russia, Ottoman Empire against France). A coup in Paris, which brought Napoleon Bonaparte to power as 1st consul. Alexander I. Coalition Wars (Austria, Russia and Great Britain v. France), Austerlitz, Friedland, Russian-French Union. The Russo-Swedish War (annexation of Finland to Russia).	
1809 AD	The completion of the Earth's mass increase program.	
	1812-1840 AD The Patriotic War, the Bucharest peace between Russia and Turkey (the accession of Bessarabia to Russia), the Gulistan peace with Persia (the accession of Northern Azerbaijan and Dagestan to Russia). The beginning of the Sixth Coalition War (Russia, Great Britain, Prussia, Austria, Sweden, etc. against France), France's return to the borders of 1792. Return of Napoleon I to France and VII Coalition War (the whole of Europe against France), ending in the defeat of the French army at Waterloo and the restoration of the Bourbon dynasty on the throne. Nicholas I, the Decembrists, Akkerman convention between Russia and Turkey (the recognition of Sukhumi's joining Russia), Turkmanchay peace between Russia and Persia (accession of Eastern Armenia to Russia), Adrianople peace between Russia and Turkey (the accession of the mouth of the Danube and the Black Sea coast to Russia) , Poland's	

	accession to Russia. Revolution in France (the overthrow of the Bourbons). 1st Opium War (Great Britain v. China).	
1840 AD	The loss by the individuals of the Brain genotype 441 leading positions in the control.	
1841 AD	The Alfa-2 Control Complex is turned on and the Brain genotype 442 with an aggressive, destructive character is introduced. The stage of hegemony of the bloody genotype 442. The completion of a long stage of the development process of the "Golden Billion" program. The startup of the control program "Ideology", which further ensured the formation of public consciousness in people with no influence of religious dogmas – through the economist Destutt de Tracy, and later through K. Marx, F. Engels, V. Lenin, and subsequently joined their theoretical heirs. The program bases of the world outlook on the liberal (capitalist) and separately communist arrangement of the Structures of the organized being of people, that is, the separated types of their civilization development. For each type, its "bright future" was presented.	
1841 AD	Since the XIX century, the Scaligerian version of history acquired the ultimate modern forms. The false fundamental scheme of the history of Russia (Rus) was written and fixed by foreigners, all unwanted documents were erased, and artifacts were destroyed. Since 1841, the number of Russian historians began to increase in the Academy (at the time of foundation and even later there were 3 out of 34). There was a process of replacing the governing composition. By the decree of Nicholas I, the Imperial Russian Academy was joined to the Imperial Academy of Sciences as a Special Branch of the Russian language and literature. It was until 1841 that we had two Academies of Sciences.	
1841-1990 AD	The realization of the program: "The force of power." The bloody stage-by-stage path: Revolutionism (until 1904); Militant fascism (until 1946); Destructive democratism (until 1990). The development of technologies for the production of weapons. The programmed social and control constructions of the local and global plan were created. The necessary volumes of accumulation and concentration of financial resources control and the circulated produced substitution in their hands were insured. A different social status was prepared for the future of the "Golden Million". The publication of the Manifesto of the Communist Party, the uprising in Paris, the civil	

	war in the United States, the organization of the First International, the attempt upon the life of the Russian Tsar and many other things were the organized and realized programmed processes of the old System (until 1904).	
1845 AD	Creation of radiation web (the most complicated design of energy gratings in the layer "-4400 +12400 m"), covering the Earth. People (and animals) having connection with such a web were conventionally called "electronics" (according to the old Program). So, the first goal – on the Earth there should be left only electronics, the rest were to be subject to destruction.	
	1848-1883 AD The February revolution in France: the overthrow of the Orleans dynasty, III republic. Crimean War of Russia with the Ottoman Empire, Alexander II: the capture of Shamil, the abolition of serfdom, zemstvo reform, judicial reform, the reform of the secondary education. Civil War in North America. The unification of Germany (Bismarck, Hohenzollers). Austria-Hungary. Japan: The Meiji Revolution. The Russian -Turkish War, the Emancipation of Labor group. Napoleon III (French Republic). The Triple Alliance, the murder of Alexander II.	
1888-1999 AD	The start up of the program Cosmopolitism (the term – 100 years). Establishing a single financial control, a single ideology for all Brain Genotypes 421 (Ararat), 441 (Mont Blanc, Alps) and the unified system of information perception by creating legends, "archaeological miracles," the destruction of all structures and bearers of a different ideology. Development and creation of a single mechanism for the society Control, approbation of technologies for societies control: capitalism, fascism, democracy, liberal democracy, socialism and so on. Ensuring control over all raw materials. Preparation of conditions for the arrival of the Ruler of the Earth (Moshiach).	
	1891-1898 AD Japan-China War (Taiwan is annexed by Japan), Russian-Chinese agreement against Japan. Formation of the Entente. Nicholas II, the Spanish-American War (the defeat of Spain), the formation of the RSDLP, the Anglo-Boer War.	
1904 AD	Completion of the stage of "Revolutionism". "Militant fascism".	
	1902-1914 AD The program of moderately liberal reforms in Russia. Portsmouth Treaty (loss of Sakhalin). The first bourgeois-democratic revolution in Russia, Rasputin. Xinhai revolution	

	in China, which overthrew the Qing dynasty, Gohmindahn. The Balkan wars. Russia's declaration of war to Turkey. World War I.	
1914-1995 AD	Selectivity for the Brain genotypes 42-46 was to be brought to the level of 22% of the total population of the planet. The execution was a success. Violence of different levels (from the systemic to the worldly) is not a real natural civilizational unconditional necessity, a reword and a certain "historical regularity" for the whole world community. This is an imposed program-executing illusion of information-control character to impart to all subsequent processes of civilization development strictly determined actions and events related to the implementation of programs of the Interventionist Control System and not more!	
Spring 1917 AD	The replacement of the governing staff in Russia through the Genotype 442 for a revolutionary governor. The February Revolution, the October Revolution, World War I, seizure of power by the fascists in Germany and Italy, and the Second World War (until 1946).	
	1917-1920 AD. The second bourgeois-democratic revolution in Russia, the end of the Romanov dynasty, the October coup, the proclamation of independence by the Ukraine, the convention and breaking up of the Constituent Assembly, the Brest Peace.	
1919 AD	The program of the system control on imposing the world outlook on the basis of a rigid social parasitism was turned on, further expressed through the manifestation of various theoretical and practical forms of fascism. The beginning of the formation of the "golden billion".	
	1920-1924 AD Civil war in Russia. The Decree of SPC on the requisitioning of farm produce. Transition to NEP. Establishment of the Council on Foreign Relations. Formation of the Communist Party of China. The election of I. Stalin as the Secretary General of the Central Committee of the RCP (b.). Formation of the USSR, the death of V. Lenin. First Congress of the League of Nations. Femine in Russia. French occupation of the Ruhr area and currency crash in Germany. The UK is restoring the pre-war gold standard.	
	The Third Appeal of the Coalition Group of Observers to Mankind passed to E.I. Roerich and N.K Poerich.	1920 AD
	1925-1945 AD Reichsmark in Germany. The Pact in Locarno. Persia: Reza Khan. Giving up the	

	<p>NEP, collectivization, the struggle against the kulaks and the opposition. Hoover is the president of the United States. The global economic crisis, falling prices and rising unemployment. Spain (Republic). Hitler – German Reich Chancellor, civil war in Spain. The USA (Roosevelt). the USSR and Japan conflict. The annexation of the Sudetenland. The meeting of representatives of the USSR, Britain and France – Moscow negotiations. The signing of the non-aggression pact and the secret protocol with Germany, the Second World War breaks out, the Great Patriotic War, the surrender of Japan.</p>	
1929-1946 AD	<p>Program: "Elimination of 50 million used and unwanted individuals as consequences of the program process of energy biogenesis of the flesh cell". Entering into an active phase of execution in 1934. The programmed endowment of the two governing spheres of being – socialism and capitalism.</p>	
1945 AD	<p>The end of the program – "Militant facism".</p>	
	<p>1945-1946 The formation of the UN, Churchill's talk about Stalin's "iron curtain" and the accusation of "unlimited expansion of his power and his ideas" (as a signal to the beginning of the "cold war").</p>	
1946 AD	<p>The end of the replacement of the governing staff in Russia, completion of the program "Elimination of 50 million used and unwanted individuals as a consequence of the program process "Energybiogenesis of the flesh cell. "The startup of the program "Destructive Democratism".</p>	
1946-1990 AD	<p>The mutually-regulated antagonistic phenomenon of the programmed development of two special target spheres of life – capitalist and socialist, as a single governable realization of the process of development of the Brain genotype 44. Completion of the general preparation for the transition to the unified system of construction of power and control on a liberal-democratic basis, which is to provide the basis for the control of the next stages of the Brain genotype development. Bringing the World Financial System to the governable state. The unification into a single governable state of "the power of money and th force power". Transition to electronic controlled accounting and electronic money. Money gets some qualities of independence. The digital basis for making up the System's controled information through the provided knowledge without gaining a deep awareness of its essence.</p>	

	Introduction of the basic digital technologies in the interests of replacing some of the Brain functions and preparing the transition to another level of separate control of the genotypes at the subsequent stage. The jointly acquired is distributed according to the quality of the Brain genotypes; the retention process was not only senseless, but also inevitable.	
	1948-1957 AD Organization for European Economic Cooperation. Moscow talks – the USSR, the United States, Britain and France on the elimination of the "Berlin crisis". NATO formation, Marshall Plan for Western Europe. The test of an atomic bomb in the USSR. The war in Korea. Khrushchev's election the first secretary of the CPSU Central Committee. Test of a hydrogen bomb in the USA. China (Mao-Tse Dong). The Warsaw Treaty. Gagarin's flight. Caribbean crisis. The election of Leonid Brezhnev First secretary of the CPSU Central Committee. Formation of the EC.	
1965 AD	It is announced the existence of the ""golden billion" program".	
	1965- 1985 Plenum of the Central Committee of the CPSU on economic issues. Reforms. The war in Vietnam. "Six Day War" of Israel against Egypt, Jordan and Syria. "Prague Spring", conflicts on the Soviet-Chinese border. Chile (S. Allende). Treaty on the Limitation of Strategic Offensive Arms, Treaty on the Limitation of Anti-Ballistic Missile Systems. The world energy crisis. Meeting on Security in Europe. The Constitution of the USSR (Article No. 6), Soviet troops entry into Afghanistan. Vietnamese troops took Phnom Penh, China attacked Vietnam. Change of party leaders in the USSR. Poland (Jaruzelski).	
	Elimination of the program processes of the old system. Recreation of the Atmosphere energy gratings, their replenishment, changing all of its communication systems and layer functions, localization of the complete arrangement and controlled program functioning of the Interventionist Control System Brain (the Atmosphere layer # 1).	1985
	Elimination of three objects (UFOs – type 400) that previously stored the main (strategic) Programs of the Interventionist Control System, which were the essence of the Ebr strategies vector of the goals, phenomena, actions and events (simultaneous earthquake – Israel, northern Italy and Australia).	October 25, 1985
	1985 Mikhail Gorbachev is elected General Secretary of the CPSU Central Committee,	

	Gorbachev and Reagan meet in Geneva, "perestroika".	
	By the autumn of 1995 A. Khatybov developed a software product that allows to decode all information from the true Earth Control System, coming and built on the basis of combined signals of the musical series.	1995
October 25, 1985 – autumn 1995	Completion of the program for the formation of the "Golden Billion" (the term of execution is 500 years). By this time, the electronics were to get the new Brain, and the rest – all kinds of diseases with a further and accelerated finale through the obituary. Attempts to find out the truth, i.e. to show initiative in getting information, were toughly nipped in the bud by the System.	
1986	The startup of the program "New Russians". To do this the charge power was increased to octave 65 (with the norm of octave 63). The experiment was recognized as unsuccessful, since it was impossible to raise the Brain octave without changing the space of existence.	
	1986-1987 27th Congress of the CPSU. The actual recognition at the Plenum of the Central Committee of the CPSU of the failure of the acceleration program. Mass riots in Alma-Ata in connection with the resignation of D.A. Kunayev from the post of first secretary of the Central Committee of the Communist Party of Kazakhstan, the start of an open separatist movement in the USSR. Soviet-American Treaty on the Elimination of Missiles of Medium and Short Range	
	Elimination of the emergency situation at the Chernobyl nuclear power plant.	1987
	1988 Amendments to the Constitution of the USSR, the establishment of the Congress of People's Deputies and the post of chairman of the Supreme Council elected by the congress. The beginning of the withdrawal of the Soviet troops from Afghanistan. The Supreme Soviet of the Estonian SSR proclaimed sovereignty.	
1989	The final stage of the formation of the "golden billion" (the Brain genotypes 44 and partially 42). Completion of the programs "The Force of Power", "Militant Democratism" and "New Russians".	
	N.V. Levashov destroys the parasitic system on the Earth, which includes 98 psi-effect generators located in "special" zones of the Earth.	1989
	Significant program corrections of the control processes. Reduction of the effective influence of Interventionist control on the existence of energies as a whole, a step towards a complete	1989

	constructive change in the control of all the performing activities in general and the states of the controlling Interventionist Systems, the Control Complexes and Objects.	
1990	Activation of the California Control Complex to start the development of the Brain genotype 46 – the "Golden Million". The first Brain genotype 461 was created. The main task is the development and improvement of a specific genotype of the Human Brain in the quantities planned by the program at the determined time in order to interface with the interventionists Brain. A special legal basis for the existence of these individuals and the performance program activities on the conditions of an unquestionable legitimate state of "FAS", as power from the Almighty. Supporting and ensuring the cleansing of the entire power pyramid for the program actions of the "Golden million	
	1990-1991 Referendum on the preservation of the USSR. The adoption by the 1-st Congress of People's Deputies of the RSFSR Declaration on the State Sovereignty of the RSFSR. The union of the GDR and the FRG. The UN resolution on the trade embargo against Iraq. Resignation of M. Thatcher.	
	The main parasitic pyramid of psi-influence on people is destroyed. On the part of the re-created true Control System, there began the process of significant localization of the effective influence of the Interventionist Control Complexes directly controlling the formerly human being, namely the Caucasus (Ararat, Kazbek and Elbrus), the Alps (Alps-1 and Alps-2) and California -1). The effectiveness of all the program aspirations in the sphere of people's being at all levels and directions around the world has sharply decreased. It is perceived as the start of a crisis chaos in the world community, the beginning of the formation of a special state – the "rebellion of consciousness" of people around the planet. Moreover, there began to work the successful effect of the performing actions on the imposed "Album Records" from the individuals of the ruling estate of that time (mainly the Brain genotypes 44 and 461), which was initiated by the first re-created True CC (th Control Complex) "Altai", and much more.	1991
	1991-1994 The coup d'etat in Moscow, the transfer of real power to the president of the RSFSR B.N. Yeltsin, the dissolution of the CPSU, the beginning of the collapse of the USSR.	

	Operation 'Desert Storm'. Liquidation of the USSR, MIA. Creation of the CIS. Transition to free prices and free currency conversion, the beginning of economic (monetary and commodity) intervention. The beginning of privatization in Russia, the constitutional crisis, the start of the Chechen war. Establishment of the Collective Security Treaty Organization. Treaty with the United States on the reduction of strategic offensive weapons.	
	Completion of the program for the formation of the "golden billion". New social relationships are introduced that exclude terror, wars, the human environment is changing, to which the "golden billion" is not prepared. The start of the practical termination and the subsequent liquidation of the previously imposed process of preparation for the active operation of the CC California-2. The liquidation of the Programs to control the performing actions of people at the Elbrus, Kazbek, and Alps 1 Control Complexes was completed. All the control servers that close on them ceased their program control, most of them were liquidated.	1995
1995	Inclusion of an emergency escort program for the "golden billion".	
1995-2004	Selectivity for the brain genotypes 42-46 is brought to the level of 22% of the total population of the planet. "Systemic failure" in the work of the Control Complexes for the performing activities control.	
1996	The end of the last night of Svarog.	
	1996-1999 Boris Yeltsin is elected President of the Russian Federation for a second term, the withdrawal of federal forces from Chechnya. The war of NATO against Yugoslavia. Appointment of V. Putin as Acting President of the Russian Federation	
1999	Completion of the 100-year program "Cosmopolitanism".	
2000	Completion of the 500-year program. Completion of the program for the creation of the Brain genotype 441. Complex Elbrus created genotype 423, completing the formation of the first group, i.e. the Brain genotype 42.	
2000	The introduction of the program – "the golden million".	
	2000 Election of V. Putin President of the Russian Federation. The destruction of the Kursk nuclear submarine, the transfer of V. Gusinsky's media holding company to Gazprom-Media, the fire at the Ostankino TV tower	

	Elimination of the failed development program of individuals with the Brain genotypes 462-466. Active participation of N.V. Levashov in this operation.	April 2001
	2001-2003 Establishment of the SCO. "Nord Ost". "Terrorist attack" in the United States. The Iraqi conflict. Treaty on the reduction of strategic offensive potentials. The start of the circulation of Euro banknotes and coins in the European Union. The war in Iraq.	
	Accomplishment of the formation of the common memory grating and control structures.	2003
	2004 V. Putin was elected president for the second term. V. Yushchenko became President of the Ukraine, in Georgia – M. Saakashvili. The government company of Japan allows the cloning of human embryos for research purposes. Expansion of the European Union, inclusion of 10 countries. "Orange" revolution in the Ukraine.	
	Liquidation of the consequences of the intervention. The beginning of the practical implementation of the theory of "The Foundations of the formation of Mankind" through the native systemic level of the Control. The process of recreation of the complex control states on the Altai 1 Complex began as the first restored element of the true Control System.	2005
2005	The transition of the program of "The Tough Social Parasitism" into a triple fascism, namely: financial, administrative-bureaucratic and national-demographic.	
	The Planetary Control System (700 km south of the Cheops pyramid) got an order to ban the lifting of all objects (UFOs). A programmed correction of the control processes related to religious buildings is carried out.	2005
	2005 The implementation of four priority national projects is stated. Beginning of the monetization of social benefits. In Bishkek, instead of A. Akayev, K. Bakiyev came to power. Yulia Tymoshenko is the Prime Minister of the Ukraine.	
	N. levashov returns to Russia.	2006
2006	Activation of the program for the formation of the "Golden million". These individuals were to have perfect protection and a direct connection with the Ebr Control System. It is planned to recreate the regulation of their life by the Ebr Control System until the achievement of almost eternal life. The formation of a sufficient number of the security forces to eliminate the instigators of	

	revolutions, rebels and terrorists, which are inevitable at the transitional stage.	
	The beginning of the transformation and change of nuclear warheads. The Russian language is adopted by the new System as the programming language of communication and control in the framework of the new Program	2006
	2006 The annual message of the President with an emphasis on the modernization of the army, the emasculated "Law on Local Self-Government" comes into effect, the "gas war" with the Ukraine, the deterioration of relations with Georgia, Russia paid off ahead of schedule with the Paris Club the debts of the former USSR. The murder of the first deputy chairman of the Central Bank A. Kozlov. The first in the 21 century solar eclipse in Russia.	
April 2007	The formation of the New Protection for the "Golden Million" by the interventionist Control System. It is planned to replace the Brain of the Super-Judaic priesthood (the government elite) with the Brain of the Ebr elite. The system of parasitic "energy suction of the Earth" on the Control Complex of California is turned off.	
2007	Giving up the idea of implementing the "Golden Billion" program. Individual structures docking at the atomic level failed , so a decision was made to return to 0 AD and begin all over again	
	The communication with the Moon is eliminated in the interests of the Control Complexes and the Objects, as well as the individuals of the genotype 4xx	2007
2007	Formation of the new protection for the "Golden million".	
	Transition of the Earth Control System from English into Russian. 2007 is declared the year of the Russian Language.	2007
	2007 V. Putin named successor – D. Medvedev. Russia suspended participation in the Treaty on Conventional Arms and Armed Forces in Europe, B. Yeltsin died. IOC determines Sochi as the venue for the XXII Winter Olympic Games in 2014. In the elections to the State Duma of the fifth convocation, the "United Russia" gets the constitutional majority. President of France is Nicolas Sarkozy, EU – Russia Summit. Murder of B. Bhutto.	
	Partial destruction of the Ebr Control System. Serious systemic failures in all Control Complexes of the old System, which led to irreversible processes, not only in supporting and ensuring	2008

	<p>program actions of the executors, but also in the development of the Brain genotypes.</p> <p>The Sichuan Control Complex is mainly liquidated (only the programs of technological profile and biological support are preserved), the Bermuda Complex, the archive of biological control programs at the Kailas Complex.</p> <p>The work of the main energy-information translator of the old Control System (Chekhov Control Complex) is disconnected, the entire control process is switched to the true CC Altai 1.</p>	
2008	<p>The splash of problems caused by the conversion of octaves above 128 in the static position without the possibility of correction at the time of the Earth's capture (splash of diseases).</p>	
	<p>2008 D. Medvedev is elected third President of the Russian Federation, Putin's appointment as prime minister. The Kosovo Parliament proclaims independence of the republic from Serbia. The armed conflict between Georgia and South Ossetia, Russia supports Ossetia, the death of the Patriarch of Moscow and All Russia Alexy II, the election of Cyril as the new patriarch. The beginning of the first global recession in the US, EU and Japan. The first African American president in the United States</p>	
	<p>The Atmosphere Brain of the old System is eliminated. The process of transmission of energy-information translation in the range of 15 – 128 octaves, which provided the control of people's performing actions, is stopped. The start up of the process of formation of the new living space under the control of the re-created Altai-1 CC with involvement in some episodes of the control of the former Sichuan CC, Kailas CC, CC Ural, Alp-2 CC and less often -Bermuda.</p>	November 13, 2009
2009	<p>According to the plan of the alien system, the first Brain genotype 461 is created.</p>	
	<p>A large-scale failure in the Interventionist Control System. The energy pumping system for radiation gratings is switched off for the "inported" base octaves, the process of natural dispersion is short.</p>	2009
	<p>2009 In Ekaterinburg the first BRIC summit is held. Record-breaking "gas war" between Russia and the Ukraine. For the first time in more than 40 years, WHO officially announced the introduction of a maximum (sixth) level of the 'swine flu' threat . For the first time in the last 8 years, Russia has a deficit budget. Gaidar died. The Lisbon Treaty entered into force in the European Union. B. Obama is awarded the Nobel Peace Prize.</p>	

	<p>The Light Hierarchs of the Intelligent Civilizations made fundamental program corrections in the processes of the Interventionist System Control. The active process of returning the future of mankind to harmony with the initial program substance of the Supreme Mind state began. Climatic and geophysical weapons are destroyed. Technical communication to move all types of objects in layer No 6 is eliminated</p> <p>The Control Complexes disappeared. The main control complex is Sichuan, China-2. All sea-based objects disappeared (operational control). Earthquakes in Chile, Haiti. No polar lights. No Current Gulf Stream</p> <p>N. Levashov created and begins approbation of the Complex "SvetL".</p>	<p>2010</p>
	<p>2010 Extensive peat fires in the Moscow, Ryazan, Nizhny Novgorod, Sverdlovsk, Kirov, Tver, Kaluga, Pskov regions and Mordovia. The Common Customs Tariff of the Customs Union of Russia, Belarus and Kazakhstan comes into force. The Russian Federation and the United States sign the Treaty on the Reduction and Limitation of Strategic Offensive Arms (START II). V. Yanukovich wins the presidential elections in the Ukraine. The peak of the world economy stimulation program. The "British Petroleum" platform sinks off the coast of Louisiana.</p>	
	<p>New programs of the control and supporting influence on the parts of the stored objects of type 400, their terminals and control servers (under the cult constructions) are installed, the parameters are changed not only to support information of the controlling nature, but also contribute to adaptation to the new energy information translation construction, including the adaptation of the biological nature .</p>	<p>2010</p>
	<p>Completion of the transition period. Elimination of communication with the Moon: specialized target forms of the Programmed information for the Brain genotype 4xx – "The Album Records". The programmed functions correction (reproduction, elimination, execution of "the album records") with the help of the atmospheric layer №6. The connection with the Sun is eliminated: setting the clock cycle of the metabolic processes for all biostructures and the clock of the event-driven time (1,0007 seconds). The processes of constructive recreation of the energy gratings of the atmosphere in their true state and their pumping up (replacement in the course of the entire Transition period) are completed; all its communication systems and</p>	<p>2011</p>

	<p>functions of its layers are changed, all the complete organization and the control programmed functioning of the Interventionist Brain of the Control System is completely localized (the Atmosphere layer No.1) More than 70% of the Control Systems, Complexes, Objects and Servers of the old System are destroyed, and the stored ones are either de-energized or reprogrammed for temporary use in order to ensure a smooth transition to new states of being, especially in the biological field.</p>	
	<p>The act of changing the System Power is definitely carried out. The complete elimination of the alien intervention of the Earth. From the re-created objects of the Control System (the territory of Russia) for the first time, the whole complex process of the complete control of the Conceptual Power is organized and formed with the involvement of Man at certain levels of his participatory operation. The Native ECS recreates the "Altai" complex as the principal executive complex.</p>	<p>24.04.2011-06.2012</p>
	<p>2011 D. Medvedev offers to support the candidacy of V. Putin at the presidential election in 2012. Yulia Tymoshenko is sentenced to 7 years in prison. "Jasmine" revolution in Tunisia, revolution in Algeria, Jordan, Mauritania, Egypt, Morocco, Libya, Bahrain, Yemen and Syria. The most powerful earthquake in Japan's history, an accident at the Fukushima nuclear power plant.</p>	
	<p>The CC Caucasus, Alps-1, California-1 are turned off. The Andes CC is completely disconnected and partially destroyed, which ensured control of metabolic processes in the biological field in the framework of the program "Development of energy biogenesis of flesh cells". Cleansing of the former influencing states of gene modeling is activated. Quantitative development of individuals with the Brain genotype 4xx is stopped</p>	<p>June 22, 2012</p>
	<p>Planning the start of the 3rd World War for the execution of the program: "Elimination of all individuals not belonging to the 4xx genotype of the Brain". The end of the liquidation is planned by December 2012. The execution does not take place! In parallel, there is a revival of the native Earth Control System. The two-way information exchange is restored, it becomes possible to introduce elements of the technical support at the stage of the direct reception of information from the System. The beginning of the application of the "SvetL" Programs in the complex version – healing-transformation of the Brain.</p>	<p>August, 2012</p>

	<p>The true CC Altai includes the programmed process "Eucharist", which means "Thanksgiving" in translation from the Greek language. Grateful "retribution for all that had been created before". It is in the active phase until 25.10.2012</p>	<p>October,12 2012</p>
	<p>A separate episode of the beginning of a significant change in the sphere of people's being is the process of formation of a new living space, under the control of the re-created CC Altai-1 involving the CC Sichuan, the CC Kailas, the CC Ural, the CC Alps 2 and less often – Bermuda for the separate episodes of the control. In addition, the mode of operation of all Control Complexes is changed; all of them, in case of any forced involvement at certain intervals, work only in the interests and under the control of the true re-created CC Altai 1.</p> <p>The change in the form of the space of scattering of the true base radiation frequencies recreated in the Atmosphere gratings of the recovering true Earth Control System Brain turns into an active form of implementation along the southeastern and northern parts of the Eurasian continent.</p>	<p>23.11.2012</p>
	<p>The change in the form of the space of scattering of the true base radiation frequencies, recreated in the Atmosphere gratings of the recovering true Earth Control System Brain turns into an active form of implementing across the Latin American Continent and Antarctic Continent.</p>	<p>December 26 , 2012</p>
<p>2012</p>	<p>Plans of the ebr system: the completion of the radiation web creation, which spans the globe, after that only those who could be controlled by the web and the development program are to remain on the Earth, which would not allow another way of the Brain development.</p>	
	<p>The program of reincarnation is completely stopped. The revival of the native Earth Control System. Restoration of the two-way information exchange. Any manifested fragments of the non-systemic information are subject to liquidation together with the performer by the Interventionist System. The worldview basis of modern people on the formation of the public and individual Consciousness is switched from the basic position of "Benefit" to "Reasonableness".</p>	<p>2012</p>
<p>2012</p>	<p>The CC "Altai 2" turns on the process of performing actions as the execution of the "album records", the territory of the execution is the Ukraine. Failure to complete the second cycle of the formation of individuals with the Brain genotype 46 (the event does not take place). Completion of the 1200-year program of the</p>	

	civilization development recorded to the representatives of the Mayan tribe.	
	Monitoring and maintaining the clock cycle (1, 0007 sec.) Complex Stonehenge is turned off from the old Control System. A new control and maintenance of the clock cycle (1.008 seconds) is turned on which is the true recreated time of the Earth at its first stage of the civilization development. This process corresponds to a special mutual position of the objects ("Parade of the Planets").	2012
	2012 V. Putin is elected President of the Russian Federation for the third time, the "people's march" in Moscow against his inauguration, the resignation of V. Serdyukov. Flood in Krymsk. On the territory of Russia, Belarus and Kazakhstan, the Single Economic Space begins functioning. North Korea officially proclaims itself a nuclear power. Russia joins the World Trade Organization, the APEC summit in Vladivostok. Debts of Greece. B. Obama is elected President of the United States for the second term. At the XVIII Congress of the Communist Party of China, there is a change of party leadership (Xi Jin-ping).	
22.12.2012	The date of the planned arrival to the Earth of the representatives of the "golden million" (984,000 individuals). The event does not take place (the energetic constructions of the Ebr elite Brain are destroyed "on the way").	
	The Control Complex of Altai turns on a New Program "The Investment that was shown" instead of the Interventionist program "Reincarnation". The Individuals with the 4xx genotype of the Brain can no longer be shown. New "SvetL" Programs are created aimed at the transformation of the Users' Brain.	January 7, 2013
	The Native System of the Earth begins to control the process of child-birth.	14.04.2013 25.10.2013
	The change in the form of the space of scattering of the true base radiation frequencies recreated in the atmosphere gratings of the recovering true Earth Control System Brain turns into an active phase of realization on the territory of Southeast Asia and the western coast of Latin America.	08.05.2013
	The installation of new programs of the control and supporting influence on some stored objects of type 400, their terminals and control servers (under cult temples and structures). The change of parameters not only to support the information of the control character, but also with the frequencies facilitating adaptation to the new construction of energy information translation, including the adaptation of biological nature.	23.10.2013

	<p>The change in the form of the space of scattering of the true base radiation frequencies, recreated in the atmosphere gratings of the recovering true Earth Control System Brain turned into an active form of realization across the territory of Russia with a part of the Arctic.</p>	
	<p>The Control Program "Violence and parasitism" is finally liquidated at the object (type 960, Moscow) and the objects of its "escort", i.e. objects of type 520 and 500 (MSU, Mnevnik, Ilyinka 6, Tsaritsyno, Zhukov Avenue in Moscow). Through this program, for the entire time of the Interventionist Control System operation the orientation of the target Vectors of phenomena, actions and events had been carried out.</p>	<p>October 26, 2013</p>
	<p>There turn off the CC Caucasus, Alps 1, California 1, the energy pumping up system for the radiation gratings by the "imported" base octaves, the process of natural dispersion is short. Completely disconnected and partially destroyed is the Andes CC, which provided the control of metabolic processes in the biological field in the framework of the program "Development of energy biogenesis of the flesh cell".</p> <p>The transition to the new Construction of the controlled organized being "Mankind" as the process of the comprehensive reorientation to a different way of the Civilization development, the start of the practical way in performing actions regarding which there must be the realization of the "New Doctrine of Transition to Another World Order".</p> <p>The cubic construction of the Atmosphere and materialization of parts of structures in the Atmosphere lower level. The work of the CC Ural program is stopped. The cubic structure of the small antenna at the altitudes of 8800-12400 m is eliminated by micro-breaking of the Atmosphere in a limited space (Chelyabinsk meteorite). There begins the transforming purposeful translation of the ECS in Russia at the level of the tough influencing nature of the Control state.</p>	<p>2013 г.</p>
	<p>2013 The ban for the possession of foreign accounts for the officials and parliamentarians. Pardon of M. Khodorkovsky. Evromaydan in the Ukraine. The economic crisis in Cyprus in March paralyzed the country's banking system. Benedict XVI announces the abdication of the throne. The Argentine Cardinal H. Bergolio is elected head of the Roman Catholic Church. At the president election in Iran a representative of the reformers</p>	

	H. Roukhani wins. Snowden gives the media the first documents on the surveillance of US government organizations of users of the Internet. Death of Thatcher. The US Federal Reserve announces the curtailment of the program of assistance of the national economy.	
	There begins the preparation for the second generation of the Complex "SvetL".	January 19, 2014
	Correction of the parameters of energy pumping up of the Earth, related to the change in the values of mantissas over all base frequencies in the range of 15-128 octaves (re-creation to the true state) and a significant increase in the intensity of pumping up in the true energy octaves of 224-512. Active recreation of the true states of the Earth energy harmony.	April 2014
	Completion of the elimination of connection of individuals of the Brain genotypes 441,442 with the Sun with the help of the atmospheric layer №6. Startup of the program to create another "golden million". Destruction of the artificially imposed Anglo-American-European illusion of the historical inevitability of their civilization superiority.	2014
	Within the framework of the programs connected with the dialectic of the development of the Brain genotype (the conditions of the Habitat and Control) and the programs for the development of protoenergy-biogenesis of flesh as part of the Space Anthropoecology, the reconstructed complexes "Ural" and "Altai 2" start work on launching more than 8000 Programs (the Earth return to the Development Program, which was given to it at its inception and which was hidden by the True Earth Control System at the time of the Ebr's attack).	2014
	2014. XXII Winter Olympic Games in Sochi, demonstrations of supporters of European integration in Kiev, the duties of the head of state are entrusted to A. Turchinov, the Cabinet of Ministers is headed by A. Yatsenyuk, a referendum is held in Crimea and Sevastopol on the status of these territories. Crimea is proclaimed a sovereign state, it became part of Russia. The United States and the EU impose sanctions on a number of Russian politicians and companies. An armed conflict in the east of the Ukraine.	

	<p>Changing part of the parameters of time and space for a living cell to change the conditions of life in the framework of the program of Space Anthropeocology. More than 8000 programs are started for their realization.</p>	<p>2015</p>
	<p>2015 V. Putin speaks at the 70th UN General Assembly in New York and says out against "the only center of domination in the world". The St. Petersburg International Economic Forum gathers a record number of participants from 115 countries. The Eurasian Economic Union begins its work. Western leaders ignore the May 9 parade in commemoration of the 70th anniversary of the Victory in the Great Patriotic War of 1941-1945 because of the crisis in the Ukraine. In Russia, the action "The Immortal Regiment" takes place, in which about 12 million people take part. The murder of B. Nemtsov. The beginning of the operation of the Russian Armed Forces in Syria. EU sanctions against Russia are extended, the US expands the sanctions list. The US Supreme Court legalizes same-sex marriages.</p>	
	<p>Formation of the new living space (the second stage of the Transition Period).</p>	<p>2016</p>
	<p>2016 On the day of national unity in Moscow, a monument to Prince Vladimir is opened. In Russia, in addition to the Internal troops of the ministry of Internal Affairs a new force structure – the troops of the National Guard (Rosgvardia) is formed. Rosneft shareholding is sold to a consortium of foreign investors. The profit of Russian banks tripled the previous year indices. D. Trump wins the presidential elections in the USA. Washington accuses Moscow of interfering in the election process. In Ankara, the ambassador of the Russian Federation A. Karlov is killed. The WADA Commission accuses Russia of creating a state program for the use of doping. The Verkhovna Rada of the Ukraine dismisses A. Yatsenyuk and appoints V. Groisman to this post. President of Uzbekistan Islam Karimov dies. Supporters of the withdrawal from the European Union win the referendum in England. The operation to release Aleppo from the militants is completed. The UN Security Council, the United States and the European Union lift economic sanctions from Iran.</p>	
	<p>2017 The election of US President D. Trump. The St. Petersburg International Economic Forum gathers a record number of 14,000 participants. – The main question: "How to save money and real estate exported abroad?" Emmanuel Macron</p>	

	takes office as President of France. Abnormally cold summer, a hurricane in Moscow, record heavy showers and snow. Change in the color of the Black Sea, the shallowing of Venice canals, fires and drought in Europe. The Ukraine gains access to the EU on a visa-free regime. Russia reaches strategic parity with the NATO countries. Syria: Russia-Turkey-Iran. Referendum in Catalonia, Veneto and Lombardy (Italy), Kurdistan (Iraq). The Valdai Club and V. Putin's speech. XIX Congress of the Communist Party of China.	
--	---	--

Let us imagine that the **ENTIRE HISTORY OF MANKIND** is squeezed in within twelve hours and that we are living at noon of the long day of Mankind. Let's suppose, for the sake of simplicity and convenience of calculation, that Man has moved on two extremities and **HAS SHOWS INVENTIVENESS** only for **two hundred and forty thousand years**. Every hour on our watch means twenty thousand years, every minute is three hundred thirty-three and three-tenths of a year. For the first eleven and a half hours, **THERE WAS NOTHING REGISTERED**. We do **NOT KNOW ANYTHING** either of people or events; we just assume that on the Earth there lived Man, because we find his stone tools, fragments of pottery, as well as some of his drawings of mammoths and buffalo.

Only ***at twenty minutes to twelve*** the very first traces of the Egyptian and Babylonian civilizations begin to appear. Greek literature, philosophy and science, which we are accustomed to speak of as "ancient", are not even seven minutes old. A minute before twelve, Lord Bacon wrote his "Multiplication of Sciences", and ever since the Man made a steam engine work instead of himself, only less than half-minute passed. ***Such is the perfect example of a small-scale representation of history with the help of clocks.*** Only after defining the year of the first Olympiad and the date of the founding of Rome, the chronology becomes clear enough to determine the year in which this or that event occurred. Approximately in the thousandth year BC. the Aryan people began to settle on the peninsulas of Spain, Italy and the Balkans, but in India by that time they had already settled; Knossos had already been destroyed, and the great Egyptian times of Tutankhamun III, Amenhotep III and Ramses II had ended three or four centuries before. In the valley of the Nile there ruled the weak monarchs of the 21st dynasty.

Israel was a united state under the rule of its first kings; Perhaps, Saul or David ruled, and maybe even Solomon. Sargon I (2300 BC) from the

Akkadian-Sumerian kingdom was only a distant episode of Babylonian history, even more remote than Constantine the Great for the world of today. A thousand years have already passed since Hammurabi died. The Assyrians already dominated the less warlike Babylonians. In 1100 BC Tiglathpalasar I conquered Babylon. However, there was no permanent conquest; Assyria and Babylonia still remained separate empires. In China, the new dynasty of Zhou flourished. Stonehenge in England was already a thousand years old. The next two centuries witnessed the revival of Egypt under the XXII dynasty, the disintegration of the small and short-lived Izraili-Jewish kingdom of Solomon, the spread of the Greeks in the Balkans, southern Italy and Asia Minor, and the rule of the Etruscans in Central Italy. Of course, everything that is mentioned here is a written hisTor(ah)y, but it does not say that it was just like that.

The list of reliable dates

Since 800 BC	
800	Carthage is founded.
790	Conquest by the Ethiopians of Egypt (the foundation of the XXV dynasty).
776	The First Olimpiad.
753	Rome is founded.
745	Tinlatpalasar III conquers Babylonia and establishes a new Assyrian empire
738	Menaim, the king of Israel, pays off Tiglathpalasar III.
735	The Greeks settle in Sicily.
722	Sargon II arms the Assyrians with iron weapons.
721	Sargon resettles the Jews.
705	Sinaherib.
701	His army is destroyed by a plague during the campaign against Egypt.
680	Asarhaddon captures Thebes in Egypt (having overthrown the Ethiopian XXV dynasty).
667	Sardanapalus
663	Psammetich I liberated Egypt and founded the XXVI dynasty (until 610). In the war with Assyria, the Lydian troops helped him, which were sent by Gig.
608	Pharaoh Necho defeated Josiah, king of Judah, in the battle of Megiddo.
606	The seizure of Nineveh by the Chaldeans and the Medes. The foundation of the Chaldean kingdom.
604	Necho is pushed to the Euphrates and is defeated by Nebuchadnezzar II
586	Nebuchadnezzar drives away the Jews into Babylon. Many of them flee to Egypt and settle there.
558	Cyrus the Persian becomes the successor of the Cyaxper of the Medes. Cyrus defeats Crease. Around the same time the Buddha was born, as well as Confucius and Lao Tzu
539	Cyrus conquers Babylon and establishes the Persian Empire.

527	Pisistratus died.
525	Cambyses conquers Egypt. Aeschylus was born.
522	Darius I, the son of Hystasp, rules from the Hellespont to the Indus. His expedition to Scythia.
495	Sophocles was born.
490	Marathon battle.
484	Herodotus is born. Aeschylus wins his first prize in the genre of tragedy
480	Battles at Thermopylae and Salamis. Euripides was born.
479	The battles at Plataea and Mikal completed the expulsion of the Persians.
474	Sicilian Greeks destroy the fleet of the Etruscans.
470	The journey of Gannon.
466	Pericles.
465	The murder of Xerxes.
438	Herodotus reads his "History" in Athens.
431	The beginning of the Peloponnesian War (before 404).
429	Pericles died. Herodotus died.
427	The beginning of the career of Aristophanes. Plato was born. He lives until 347.
401	Retreat of Ten thousand Xenophon.
390	Brenn is looting Rome.
366	Camille is building the Temple of Concord.
359	Philip is the king of Macedonia.
338	Battle of the Chronicles.
336	Macedonian troops enter Asia. Murder of Philip.
334	The Battle of Granik.
333	The Battle of Issa.
332	Alexander of Macedon in Egypt.
330	Darius III is killed.
327	Alexander is in India.
323	The death of Alexander of Macedon.
321	Chandragupta became ruler of the Punjab. The Samnites dealt a crushing defeat to the Romans in the Battle of the Kavdinsky Gorge.
303	Chandragupta defeats Seleucus.
282	Ptolemy Soter died.
281	Pyrrhus invades Italy.
280	The Battle of Heraclea.
279	The Battle of Auscule.
278	Raid of the Gauls to Asia Minor and their settlement in Galatia.
275	Pyrrhus leaves Italy.
264	The First Punic War (Ashoka rules in Behar – until 232). The first battles of gladiators in Rome.
260	The Battle of Milah.
256	The Battle of Cape Eknom.
246	Shi Huang-di – the king of the Qin Empire.
241	The Battle of the Egat Islands. End of the First Punic War.
225	Battle of Telamon. Roman armies in Illyria.
220	Shi Huang-di becomes the emperor of China.
218	The Second Punic War.
216	The Battle of Cannes.
214	The construction of the Great Wall of China began.
210	Death of Shi Huang-di.

202	The Battle of Zama.
201	The end of the Second Punic War.
200-197	The period of the war between Rome and Macedonia.
192	War with the Seleucids.
190	The Battle of Magnesia.
149	The Third Punic War. (Yuezhi came to the Western Tan).
146	Destruction of Carthage. Destruction of Corinth.
133	Attalus bequeathed Pergamum to Rome. Tiberius Gracchus is killed.
121	Gaius Gracchus is killed.
111-105	The war with Jugurtha.
102	Marius expelled the Germans.
100	Maria's Triumph (U-di conquers the valley of the Tarim River).
91	Civil war in Italy.
89	All Italians become Roman citizens.
86	Death of Maria.
78	Death of Sulla.
73	The uprising of slaves led by Spartacus.
71	The defeat and death of Spartacus.
66	Pompeii leads his troops to the Caspian region and the Euphrates. His clashes with the Alans.
63	Mithridates Eupator, king of Pontus, died.
53	Krasé is killed in the battle of Carrá. Mongolian elements among the Parthians.
48	Julius Caesar defeats Pompey from Farsal.
44	The murder of Julius Caesar.
31	Battle of the Campaign.
27	Augustus Caesar – princeps (first on the list of senators) (until 14 AD).
The Christian era	
4	The real date of the birth of Jesus of Nazareth.
6	The province of Moesia is organized.
9	The province of Pannonia is organized. The borders of the empire moved closer to the Danube
14	August died. Tiberius is the emperor.
30	Jesus from Nazareth is crucified.
37	Caligula is the heir of Tiberius.
41	After the murder of Caligula Claudius (the first emperor of the legions) – the emperor with the support of the Praetorian Guard.
54	Nero inherits Claudius.
61	Queen Boudicca destroys the Roman garrison in Britain.
68	Suicide of Nero (temporary emperors – Galba, Oton, Vitellius).
69	Vespasian founded the so-called Flavian dynasty
79	Titus is the heir of Vespasian.
81	Domitian.
84	Joining Northern Britain.
96	Nerva founded the so-called Antonin dynasty.
98	Trajan is the heir of the Nerva.
102	The Chinese are on the Caspian Sea. Indoskifs invade Northern India.
117	Adrian is Trajan's heir. The Roman Empire gets its largest size.
138	Antoninus Pius is the heir of Hadrian. (The Indo-scythians destroy the last remnants of the Hellenes rule in India).

150	Around this time, Kanishka rules in India, Kashgar, Yarkand and Khotan.
161	Marcus Aurelius inherits Antonina Pius.
164	A great plague epidemic that lasted until the death of Marcus Aurelius (180). It also devastates all of Asia
180	Death of Marcus Aurelius. (The beginning of about a century of wars and trouble in the Roman Empire).
220	The end of the Han dynasty. The beginning of the four hundred year partition of China.
226	Ardashir 1 (the first Sassanid king) put an end to the line of the Arshakids in Persia.
242	Mani preaches his teaching.
247	The Goths cross the Danube.
251	A big victory of the goths. The Emperor Decius is killed.
260	Shapur I, the second Sasanian king, conquered Antioch, captured the emperor Valerian, but during his return from Asia Minor was defeated by Odanat from Palmyra.
269	Emperor Claudius defeats the goths at Nis
270	Aurelian is the emperor.
272	The captive queen Zenobia is brought to Rome. The end of the short-lived triumph of Palmyra.
275	Probus inherits Aurelian.
276	The Goths in Ponte. The Emperor Probus kept the onslaught of the Franks and the Germans.
277	Mani is crucified in Persia.
284	Diocletian is the emperor.
303	Diocletian persecutes the Christians.
306	Constantine the Great is the emperor.
311	Galerius stops the persecution of Christians.
314	Constantine presides at the Christian Council in Arles.
321	New raids of the Goths are repeled.
323	Constantine presides at the Council of Nicaea.
337	Expelled by the Goths, the vandals are allowed to settle in Pannonia. The baptism of Constantine on his deathbed.
354	Saint Augustine was born.
361-363	Julian the Apostate makes an attempt to replace Christianity with Mithraism.
379	Theodosius the Great (Spaniard by birth) is an emperor.
390	The destruction of the statue of Serapes in Alexandria.
392	Theodosius the Great is the emperor of the East and the West.
395	Death of Theodosius the Great. Honorius and Arkady again divide the empire, Stilihon and Alaric become their masters and protectors.
410	West Goths under the leadership of Alaric capture Rome.
425	Vandals settle in the south of Spain. Huns – in Pannonia, Ostrogoths – in Dalmatia. West Goths and Sueves – in Portugal and Northern Spain. Angles and Saxons invade Britain.
429	Vandals led by Heiserich invade Africa.
439	Vandals capture Carthage.
448	Prisk visits Attila.

451	Attila, who attacked Gaul, was defeated by the Franks, Germans and Romans in the Catalaun fields
453	Death of Attila.
455	Vandals loot Rome.
470	Invasion of the Ephthalites to India.
476	Odoakr, the king of the united Teutonic tribes, declares to Constantinople that the emperor in the West no longer exists. End of the Western Roman Empire.
480	Saint Benedict was born.
481	Clovis is the founder of the Frankish Kingdom. Merovingians.
483	The Nestorian church is separated from the Orthodox Christian church.
493	Theodoric, the king of the Ostrogoths, conquers Italy and becomes her king, but nominally he submits to Constantinople. (Gothic kings in Italy).
527	Justinian becomes emperor.
528	Mihirakula, Ephthalitic Attila of India is defeated.
529	Justinian closes schools in Athens, which flourished for about a thousand years. Belisarius (commander of Justinian) captures Naples.
531	The beginning of the reign of Khosrow I.
543	The great plague epidemic in Constantinople.
544	St. Benedict died.
553	Justinian expels the Goths from Italy. Cassiodorus founded a monastery.
565	Justinian died. Lombards conquer much of northern Italy (leaving the Byzantine Empire Ravenna and Rome). The Turks defeat the Ephtalites in Western Turkestan.
570	The Prophet Muhammad was born.
579	Khosrov I died. Lombards rule in Italy.
590	In Rome, the plague rages. Gregory the Great (Gregory I) and the vision of St. Angel.
591	The beginning of Khaskovo's II reign.
610	The beginning of Heraclius' reign.
618	The beginning of the Tang dynasty in China.
619	Khosrov II captures Egypt, Jerusalem, Damascus. His armies are on the Hellespont.
622	Hijra.
623	The battle of Badr.
627	Irakli inflicts a great defeat to the Persians at Nineveh. Allies from Mecca besiege Medina. Taizong is the emperor of China.
628	Kawad II kills his father. Khosrov II, and becomes his heir. Muhammad sends letters to rulers all over the world.
629	Xuan-Tsang goes to India. Muhammad returns to Mecca.
632	Muhammad died. Abu Bekr – the first Caliph.
634	Omar is the second Caliph.
635	Taizong receives Nestorian missionaries.
636	The battle on the banks of Yarmuk. Muslims seize Syria.
637	Battle of Cadiz.
638	Jerusalem surrenders to Omar.
641	Heraclius died.
644	Osman is the third Caliph.
645	Xuan-Zang returns to Xian.
655	The defeat of the Byzantine fleet by Muslims.

656	Osman is killed in Medina.
661	Ali is killed. Muawiya is the first Caliph of the Umayyad clan.
668	The Caliph of Muavia attacks Constantinople from the sea. Theodore of Tarsus is the Archbishop of Canterbury.
675	The last naval attack of Muavia at Constantinople.
687	Majordom Pippin Geristalsky reunites Austrazia and Neustria.
711	Muslim invasion of Spain from Africa.
715	Karl Martell is a majordom.
716-717	Suleiman, the son and heir of Walid, could not take Constantinople. Culmination of the Umayyad rule.
721	The possessions of the Caliph Walid I expand from the Pyrenees to China.
732	Karl Martell defeats the Muslims at Poitiers.
735	Death of Bedda of the Venerable.
743	Walid II – "unbelieving" Caliph.
749	The overthrow of the Umayyads. Aboul El Abbas is the first Abbasid caliph. Spain remains Umayyadian. The beginning of the collapse of the Arab Empire.
751	Pepin is crowned king of the francs.
755	The martyrdom of St. Boniface.
768	Pepin died.
771	Charlemagne is the sole ruler.
774	Charlemagne conquers Lombardy.
776	Charlemagne in Dalmatia.
786	Haroun al-Rashid is the Abbasid caliph in Baghdad (until 809).
795	Leo III – Roman Pope (until 816).
800	Leo III crowns Charlemagne as the emperor of the West.
802	Egbert, a former English refugee at the court of Charlemagne, proclaims himself the king of Wessex.
811	Bulgarian prince Krum defeats the troops of the emperor Nicephorus and kills him.
814	Charlemagne died; Ludovik the Pious inherits him.
828	Egbert becomes king of England.
843	Louis the Pious died, prtition of the Carolingian Empire. Until 962 there is no permanent inheritance in the Holy Roman Empire, although the title is preserved.
852	Boris is the first Christian prince of Bulgaria.
862	Around this year, Norman Rurik became the ruler of Novgorod
866	The Norman and Russian fleet threatens Constantinople.
886	Treaty of Alfred of England and Gutrum of Denmark on the settlements of the Danes on the lands of "Danish law".
907	The Russian-Norman fleet leaves Constantinople.
911	Norman Chief Rollon settles in Normandy.
919	Henry Ptitselov was elected King of Germany.
928	Marocia captives Pope John X.
931	John XI – the Pope (until 936).
936	Otgon I inherits his father Henry Ptitselov on the throne of Germany
941	The Russian fleet again threatens Constantinople.
955	John XII – The Pope.
960	Northern Song begins to rule in China

962	Otgon I, the King of Germany, was crowned by John XII for the emperor. (The Beginning of the Saxon Dynasty).
963	Otgon I dismisses John XII.
969	An independent Egyptian Caliphate is founded in Egypt.
973	Otgon II
983	Otgon III.
987	Hugo Capet is the King of France. End of the Carolingian dynasty in France
1016	Canute is king of England, Denmark and Norway.
1037	Avicenna (Ibn Sina) from Bukhara, the "king of healers", died.
1043	The Russian fleet threatens Constantinople.
1066	The conquest of England by William, the Duke of Normandy.
1071	Revival of Islam under the Seljuk Turks
1073	Hildebrand becomes Pope George VII (before 1085).
1077	Repentance of Henry IV.
1079	Peter Abelar was born.
1082	Robert Guiscard took Durazzo.
1084	Robert Guiscard plundered Rome.
1088-1099	Urban II – the Pope.
1094	Plague.
1096	Urban II in Clermont initiates the First Crusade.
1096	The catastrophe of the "People's Campaign".
1099	Gottfried of Bouillon captures Jerusalem. Paskhalii II – Pope (until 1118).
1138	The heyday of the Jin Empire. The Song Dynasty capital moves from Nanjing to Hangzhou.
1142	Peter Abelard died.
1147	The Second Crusade. Foundation of the Christian Kingdom of Portugal.
1169	Saladin is the Sultan of Egypt
1177	Emperor Frederick Barbarossa recognizes the supremacy of the Pope (Alexander III) in Venice
1187	Saladin took Jerusalem
1189	The Third Crusade.
1193	Albert the Great was born.
1198	The Arab philosopher Averroes of Cordoba (Ibn Rushd) died. Innocent III – the Pope until 1216; Friedrich II, four-year-old king of Sicily, under the tutelage of the Pope.
1202	The fourth crusade deals a blow to the Byzantine Empire.
1204	Constantinople was captured by the Latins.
1206	Qutb establishes an Islamic state in Delhi.
1212	The crusade of children.
1214	Genghis Khan takes over Peking.
1215	The Magna Carta is signed.
1216	Honorius III the Pope
1218	Genghis Khan invades Khorezm.
1221	The failure and the return of the Fifth Crusade. St. Dominic (founder of the Order of Dominicans) died.
1225	Thomas Aquinas was born.
1226	St. Francis of Assisi (founder of the Order of the Franciscans) died.
1227	Genghis Khan, who ruled from the Caspian to the Pacific, died; Ogedei inherits him. Gregory IX – The Pope.

1228	Frederick II begins the Sixth Crusade and receives Jerusalem from the Sultan.
1234	The Mongols are completing the conquest of the Jin Empire with the support of the Song Empire.
1239	Friedrich II is excommunicated for the second time.
1240	The Mongols are destroying Kiev. Russia begins to pay tribute to the Mongols
1241	The victory of the Mongols under Legnica in Silesia.
1244	The Egyptian Sultan regains Jerusalem, which leads to the Seventh Crusade (1248).
1245	Frederick II is again excommunicated.
1248	Residents of the Schwyz Valley burned the castle of New Habsburg.
1250	The French king, Louis the Saint, was redeemed from captivity. Friedrich II died, the last emperor of the Hohenstaufen dynasty. Interregnum in Germany until 1273.
1251	Mongke is the Great Khan. Khubilai Khan rules in China.
1258	Khan Khulagu captures and destroys Baghdad.
1260	Khubilai is the Great Khan. Ketboga is defeated in Palestine.
1261	The Greeks regain Constantinople after the Latin rule.
1265	Dante Alighieri was born.
1266	Giotto was born.
1269	Great Khan Khubilai sends a message to the Pope through older Polos.
1271	The beginning of the journey of Marco Polo.
1273	Rudolf Habsburg is the emperor. "Eternal Union" of the Swiss.
1274	Thomas Aquinas died.
1280	Khubilai founded the Yuan dynasty in China. Albert the Great died.
1292	Khubilai Khan died.
1293	Roger Bacon died, the forerunner of experimental science.
1294	Boniface VIII the Pope until 1303
1295	Marco Polo returns to Venice.
1303	The death of Pope Boniface VIII after the attack in Anagni.
1304	Petrarch was born. Clement V is the Pope.
1308	Duna Scott died.
1309	The Beginning of the Avignon Captivity of the Popes
1318	Four Franciscans are burned on charges of heresy in Marseilles.
1337	Giotto died.
1347	Ockham died.
1348	The Great Plague.
1358	Jacquerie in France
1368	The fall of the Mongolian dynasty of Yuan in China, which is replaced by the Ming Dynasty (until 1644)?
1369	Tamerlane takes the title of Great Khan.
1374	Petrarch died.
1377	Pope Gregory XI returns to Rome.
1378	"The Great Schism." Urban VI – Pope in Rome, Clement VII – in Avignon.
1381	Peasant uprising in England. Watt Tyler was killed in the presence of King Richard II.
1384	Wycliffe died.
1387	Fra Angelico was born.
1398	The preaching of Wikliphist ideas in Prague by Jan Hus.
1400	Chaucer died.

1405	Death of Tamerlane.
1414-1418	Council in Constanta. Jan Hus was burned (1415).
1417	The end of the "Great Schism", Martin V – the Pope.
1420	The Hussite insurrection. Martin V convokes a crusade against the Hussites.
1431	Crusaders flee before the Hussites at Domazlice. Basel Council. Villon and Mantegna were born.
1436	The Hussites make an agreement with the Church.
1439	Basel Council triggers a new church schism
1445	The discovery of Cape Verde by the Portuguese.
1446	The first printed book (Bonfire in Haarlem).
1449	The end of the Basel Council.
1452	Leonardo da Vinci was born.
1453	The Ottoman Turks under the leadership of Muhammad II took over Constantinople.
1471	Durer was born.
1473	Copernicus was born.
1480	Ivan III, Grand Duke of Moscow, overthrows the Mongol yoke.
1481	The death of Sultan Muhammad II while preparing for the conquest of Italy. Bayazid II – the Sultan (until 1512).
1487	Dias rounded the Cape of Good Hope.
1492	Columbus crossed the Atlantic and reached America. Rodrigo Borgia – Pope Alexander VI (until 1503).
1493	Maximilian I is the emperor.
1498	Vasco da Gama, rounds Africa, sails to India.
1499	Switzerland is an independent republic.
1500	Charles V was born.
1509	Henry VIII is the King of England.
1512	Selim – Sultan (until 1520); he appropriates the title of caliph. The fall of Soderini and Machiavelli in Florence.
1513	Leo X the Pope.
1515	Francis I is the King of France.
1517	Selim annexes Egypt. Luther announces his theses in Wittenberg.
1519	Leonardo da Vinci died. The beginning of the round-the-world expedition of Magellan. Cortez enters Mexico City.
1520	Suleiman the Magnificent – Sultan until 1566, ruling from Baghdad to Hungary. Charles V is the emperor.
1521	Luther at the Reichstag in Worms. Loyola was wounded near Pamplona.
1525	Babur wins the battle of Panipat, captures Delhi and establishes the Mughal empire.
1527	The German troops in Italy, under the command of the constable of Bourbon, seize and plunder Rome.
1528	Paolo Veronese was born.
1529	Suleiman is besieging Vienna.
1530	Pizarro invades Peru. Charles V, crowned by Pope Clement VII, begins a quarrel with the papacy.
1532	The Anabaptists capture Münster.
1535	The fall of Anabaptist rule in Munster.
1539	The society of Jesus was founded.
1545	The Council of Trent (until 1563) was convened to bring order to the Church.

1546	Martin Luther died.
1547	Ivan IV the Terrible takes the title of Tsar of Russia. Francis I died.
1549	The first Jesuit missions arrive in South America.
1552	Treaty of Passau. Temporary reconciliation in Germany.
1556	Charles V leaves the throne. Akbar – The Great Mogul (until 1605). Ignatius Loyola died.
1558	Charles V died
1561	Francis Bacon was born.
1563	Completion of the reform of the Catholic Church by the Council of Trent.
1564	Shakespeare was born.
1566	Died Suleiman the Magnificent.
1567	Revolution in the Netherlands.
1568	Execution of the counts of Egmont and Horn.
1573	The Siege of Alkmaar.
1583	Expedition of Sir Walter Raleigh to Virginia.
1603	Jacob I – King of England and Scotland. Jahangir is the Great Mogul. The Virgin Company is founded.
1609	Independence of Holland.
1618	Beginning of the Thirty Years' War
1620	The expedition from Mayflower founded New Plymouth. The first Negro slaves in Jamestown, Virginia.
1625	Charles I is the King of England.
1626	Sir Francis Bacon died, Lord Verulamsky.
1627	Shah Jahan is the Great Mogul. English petition on the law.
1629	Since this year, Charles I the English, rules for eleven years without convening a parliament.
1632	Leuvenook was born. Swedish King Gustav Adolf was killed in the Battle of Lutzen.
1634	Murder of Wallenstein
1638	Japan closes from the Europeans until 1865.
1640	Charles I convenes the Long Parliament.
1641	The British start massacre in Ireland.
1643	Louis XIV begins his seventy-two-year reign.
1644	Manchurs replace the Ming dynasty.
1648	The Westphalia world; on it the Netherlands and Switzerland are recognized as free republics; the influence of Prussia is growing. The war of the Fronde ends in the complete victory of the French Crown.
1649	Execution of Charles I of England.
1658	Aurangzeb is the Great Mogul. Cromwell died.
1660	Charles II the king of England
1674	New Amsterdam finally passes to the British and is renamed to New York.
1683	The last Turkish attack on Vienna was repulsed by King Jan III of Poland.
1688	Coup in Britain. The flight of James II. The beginning of the reign of Wilhelm and Mary.
1689	Peter the Great the Tsar of Russia (until 1725).
1690	War in Ireland
1701	Frederick I is the first king of Prussia
1707	Death of Aurangzeb. The empire of the Great Moguls disintegrates.
1713	Frederick the Great of Prussia was born.
1733	Oglethorpe founded the colony of Georgia

1736	The invasion of Nadir Shah in India. The beginning of the twenty-year raids and disorder in India
1740	Ascent of Frederick the Great, King of Prussia. Maria Theresa begins to reign in Austria. As a woman, she can not be an empress. Her husband Franz I – the emperor from 1745 to 1765, when he is succeeded by his son Joseph I.
1741	Empress Elizabeth of Russia starts reigning
1755-1763	Wars between Britain and France in America and India. France – in alliance with Austria and Russia against Prussia and Britain; Seven Years' War.
1757	The battle of Plessis.
1759	British general Wolff conquers Quebec.
1760	George III is the King of Britain.
1762	The Empress of Russia Elizabeth died. The murder of Tsar Peter III and the ascent to the throne of Catherine the Great (reigns until 1796).
1763	The Paris Peace Treaty; Canada's transition to Britain. British supremacy in India.
1764	Battle of Buxar.
1766	Malthus was born.
1769	Napoleon Bonaparte is born
1774	The beginning of the reign of Louis XVI. Suicide of Clive.
1775	Beginning of the War of Independence in North America. Battle of Lexington. Turner was born.
1776	Declaration of Independence of the United States.
1780	End of the reign of Maria Theresa. Emperor Joseph inherits the possessions of the Habsburgs.
1783	Peace treaty between Britain and the United States.
1787	Constitutional Convention in Philadelphia establishes the federal government of the United States. France faces bankruptcy; collection of notables.
1788	The first federal congress of the United States in New York.
1789	General states in France. Storming the Bastille.
1791	Unsuccessful attempt of the royal family to escape. The Jacobin Revolution.
1792	France declares war on Austria. Prussia declares war on France. Battle of Valmy. France is proclaimed a republic.
1793	Louis XVI is beheaded.
1794	The execution of Robespierre and the end of the Jacobin Republic. The rule of the Convention.
1795	Directory. Bonaparte suppresses the mutiny and enters Italy as the head of the troops.
1797	Under the conditions of the Campo-formian treaty, Bonaparte destroys the Venetian Republic.
1798	Bonaparte arrives in Egypt. Battle at the Nile delta.
1799	Return of Bonaparte. He becomes the first consul with unlimited powers.
1800	Napoleon campaign against Austria. The battle of Marengo in Italy and Hohenlinden (Moro's victory).
1801	The Parliamentary Union of Ireland and England comes into force on January 1, 1801. A truce between France, England and Austria.
1803	Bonaparte occupies Switzerland, which makes the war inevitable.

1804	Bonaparte becomes emperor. Francis II takes the title of Emperor of Austria and in 1806 renounces the title of Emperor of the Holy Roman Empire, the end of her story.
1805	The Battle of Trafalgar. Battles at Ulm and Austerlitz.
1806	The defeat of the Prussian army at Jena.
1807	Battles at Eylau and Friedland; Tilsit Peace.
1808	Napoleon makes his brother Joseph king of Spain.
1810	Latin America begins the struggle for independence.
1811	The refusal of Alexander I from the continental blockade.
1812	Napoleon's retreat from Moscow.
1814	The abdication of Napoleon. Louis XVIII – the King.
1815	The Battle of Waterloo. The Congress of Vienna.
1819	The first factory act was adopted thanks to the efforts of Robert Owen.
1821	The uprising in Greece.
1824	Charles X is the King of France.
1825	Nicholas I is the Russian Tsar. The world's first railway between Stockton and Darlington (England).
1827	The Battle in Navarinskaya Bay.
1829	Independence of Greece.
1830	Year of revolutionary anxiety. Louis Philip took the place of Charles X. Belgium breaks from Holland. Leopold Saxe-Coburg-Gothic becomes the king of this new country. Ineffective Polish uprising in Russia.
1832	The first Bill of Reform in Britain restores the democratic character of the British Parliament.
1835	The word "socialism" is used for the first time.
1837	Queen Victoria.
1840	Queen Victoria is married to Duke Albert Sak-sen-Coburg-Gotha.
1848	Another year of revolutions. Republicans come to power in France and Rome. Pan-Slavic Conference in Prague. The whole of Germany is united by the Frankfurt Parliament. The King of Prussia destroys the unity of Germany.
1851	World Exhibition in London.
1852	Napoleon III is the emperor of France.
1854	The second expedition. Perry landed in Japan. Nicholas I occupies the Danube provinces of Turkey
1853-1856	The Crimean War.
1855	Alexander II – the Tsar of Russia.
1857	Indian uprising.
1859	The Franco-Austrian War. The battles of Magenta and Solferino
1861	Victor Emmanuel is the first king of Italy. Abraham Lincoln is the president of the United States. The beginning of the Civil War in America.
1863	The British are shelling the Japanese city.
1864	Maximilian – Emperor of Mexico
1865	Capitulation of Southerners in Appomattox. Japan opens itself to the world.
1866	Prussia and Italy are attacking Austria (it is in the union of the South German states). The Battle of Sadova
1867	The Emperor Maximilian was shot.
1870	Napoleon III declares war on Prussia.
1871	Defeat of France (January). The King of Prussia becomes emperor of Germany Wilhelm. The Frankfurt Peace Treaty.

1875	Turkish atrocities in Bulgaria.
1877-1878	Russian-Turkish war. The San Stefan world. Queen Victoria becomes empress of India.
1878	Berlin Congress. The beginning of the thirty-six-year-long "armed peace" in Europe.
1881	The Battle of Majuba Hill. The Free Republic of the Transvaal.
1882	Charles Darwin died.
1883	British occupation of Egypt. Karl Marx died.
1886	The first bill on Irish self-government Gladstone
1888	Friedrich III (March), Wilhelm II (June) – the emperors of Germany
1890	Bismarck's resignation. The island of Helgoland is ceded to Germany.
1894-1895	Japan-China War.
1895	The "Unionist" (imperialist) government in Britain.
1896	The Battle of Adua.
1898	Conflict between England and France because of Fashoda. Germany acquires Qingdao.
1899	The beginning of the Boer War.
1900	The uprising of the "boxers" in China.
1904	Britain invades Tibet.
1904-1905	Japan-China War.
1906	The imperialist party in the British parliament was "defeated" by the liberals on the issue of tariff policy.
1907	The formation of the South African Union.
1908	Austria annexes Bosnia and Herzegovina
1909	M. Brélio flies on an airplane from France to England.
1911	Italy unleashes a war with Turkey and captures Tripoli.
1912	China becomes a republic. The Balkan Union begins a war with Turkey.
1913	The bloodshed in Londonderry in Ireland, caused by the illegal supply of arms by "Unionists".
1914	The beginning of the world war in Europe.
1917	Two revolutions in Russia. Establishment of the Bolshevik regime.
1918	The truce (November).
1919-1920	Versailles Peace Treaty. Paris Peace Conference.
1919	The British leave Arkhangelsk. Denikin is defeated. Yudenich almost captures Petrograd and is defeated. The German fleet is sunk by German officers instead of being handed over to the British.
1920	First Congress of the League of Nations; Germany, Austria, Russia and Turkey are excluded. The United States does not send a representative. Kolchak is defeated by the Bolsheviks and shot. Poland is attacking Russia; the offensive of Wrangel in the south is stopped.
1921	Constantinople under the control of the Allies. The Conference on Naval Disarmament in Washington, chaired by President Harding.
1922	Great famine in Russia. At the Congress of the League of Nations in Geneva, there are Germans and Russians. The growing mess in Germany's finances and the impossibility of paying a military debt. Defeat of the Greek military in Asia Minor. Separation of Southern Ireland from Great Britain.
1923	French occupation of the Ruhr area and currency crash in Germany. The introduction of a rentmark. The UK is restoring the pre-war gold standard.

1924	The first Labor government in Britain. It is replaced by a conservative government after the general elections in November. Lenin died. In Italy, the fascists are killing the liberal Italian writer Matteotti. Dawes Plan to mitigate the debt burden of Germany.
1925	The French are attacked by the forces of Abdal-Krim in Morocco and the Druze in Syria. Reichsmark in Germany. The pact in Locarno. Reza-khan dismisses the Shah of Persia and later becomes the shah himself.
1926	The French franc falls to the value of one penny, but is then stabilized by the new anti-crisis coalition government. Fall of Abd al-Krim.
1927	The British government makes a raid on Russian business offices in London and breaks diplomatic relations with Russia. The failure of the conference on disarmament in Geneva.
1928	Kellogg, the Secretary of State in the government of President Coolidge, proposes a system of treaties by which all great powers refuse war. The military industry remains untouched. The development of military equipment and the development of gas and bacteriological weapons continue. The beginning of the five-year plan in Russia
1929	The second Labor government in Britain by the results of general elections. The resumption of relations between Britain and Russia. Hoover is the president of the United States. Ubiquitous fall in prices and rising unemployment. Jung's plan to mitigate German military debts.
1930	The conference on naval disarmament in London with trivial results. The new frightening fascist party appears in the German Reichstag under the leadership of an Austrian named Hitler
1931	Spain becomes a republic (April). Economic instability in Germany is growing, and President Hoover offers an year suspension in the payment of reparations. This is followed by the financial crisis in Britain. The Labor government gives way to the "national" government, which pledged to support the gold standard, which later is rejected. MacDonald, a former leader of the Labor Party, retains the post of prime minister, skillfully skirting all political whirlpools.
1932	Geneva Conference on Disarmament.
1933	The law on additional powers in Germany – Adolf Hitler, the law against the formation of new parties, the ban of all parties except Nazi. In the US, Roosevelt's new course (the restoration of the national economy and improvement in agriculture). The Roman Pact.
1934	A number of laws adopted in Germany within the framework of state (imperial) reorganization, "the night of long knives". Paul von Hindenburg died. Oath of the military to A. Hitler, the combination of the posts of the president and the Chancellor – the Fuhrer
1935	In the US, Wagner's law (New Deal of F. Roosevelt).
1936	Military mutiny led by Francisco Franco (slogan – the protection of religion and traditional values). The Civil War in Spain. The Convention in Montreux – Turkey got the straits of the Bosphorus and the Dardanelles.
1937	The Brunet operation in Spain. Brussels Conference.
1938	German troops enter Austria. Battle of the Ebro River in Spain. The troops of Franco stopped the offensive on Valencia. France calls for reservists. The Germans break off relations with Czechoslovakia. Conference in Munich – an agreement on the issue of the German military occupation. Chamberlain carries to London "honorable peace."
1939	In Spain, nationalists capture Madrid (the Madrid battle), the end of the civil war. Meeting of representatives of the USSR, Britain and France –

	Moscow negotiations. The signing of the non-aggression pact and the secret protocol. German troops invade Poland (it is considered to be the beginning of World War II). Britain and France declare war on Germany (without receiving an answer to an ultimatum in connection with the attack on Poland). New Zealand and Australia declare war on Germany. From this time until 10.05.1940 – "Strange War". Soviet troops occupied the east of Poland (western Ukraine and Belarus).
1940	Directive No. 17 of Hitler on the expansion of the air war against England. The battle for England.
1941	Winston Churchill's speech on the Battle of the Atlantic. Moscow Conference of the heads of the USSR, USA, England. The US provides a loan to the USSR in 1942, 1 billion dollars.
1942	The breakthrough of German ships across the English Channel. The beginning of the Soviet counteroffensive near Stalingrad.
1943	Moscow Conference of Foreign Ministers of the USSR, the USA and England (Moscow meeting of 1943). Cairo – Conference of Heads of Government of the United States, Britain and China (Cairo Conference). Tehran Conference – USSR, USA, England
1944	Odessa operation of troops of the 3rd Ukrainian Front. Landing of Allied forces in Normandy. The second front is opened. The Overlord plan. The Warsaw Uprising is an armed offensive by the Poles against the German occupation, without the assistance of the USSR and the West, and further the fighting of the troops of the First Byelorussian Front in the Warsaw area.
1945	The offensive along all the entire front with Germany – the operation of the 1st Byelorussian and 1st Ukrainian fronts between the Vistula and the Oder. The Crimean Conference of the heads of the USSR, USA and England. Upper Silesian operation of the 1st Ukrainian Front troops. The Vienna Offensive Operation of the 2nd and 3rd Ukrainian Fronts for the Occupation of Vienna. Okinawa operation of the US Armed Forces to seize the Japanese island. Okinawa. The Prague operation of the 1st, 4th and 2nd Ukrainian fronts. Potsdam conference in Germany with the participation of Stalin, Truman, Churchill and Attlee (territorial issues for Austria and Poland). Hiroshima. Manchurian offensive operation of the Soviet Armed Forces against the armed forces of Japan. The act of surrender of Japan on the battleship "Missouri" (the end of World War II). The Moscow Conference (USSR, USA, Great Britain) in 1945 – peace treaties with Italy, Romania, Bulgaria, Hungary and Finland.
1946	The 1-st session of the UN General Assembly. Churchill's speech on the "iron curtain" of Stalin and the accusation of "unlimited expansion of his power and his ideas" (as a signal to the beginning of the "cold war").
1947	The program, voiced by George Marshall on the restoration and development of Europe by providing her with US economic assistance (Marshall Plan).
1948	Establishment of the Organization of European Economic Cooperation (OEEC) in Paris. Moscow talks – the USSR, USA, Great Britain and France on the elimination of the "Berlin crisis".
1949	TASS report on the testing of the atomic bomb in the USSR. The military tribunal in Khabarovsk over the Japanese generals – the Khabarovsk trial.
1950	Completion of the "Leningrad case" against a group of party leaders who entered the big Soviet policy from Leningrad from Kuibyshev circle. Death sentence to AA. Kuznetsov and others.

1952	F. Batista arranges a coup d'état in Cuba. The Bonn Treaty (separate) between the United States, Great Britain and France on the one hand and the FRG on the other. Completion of the case of the Jewish Antifascist Committee initiated in 1948 by sentencing the leaders.
1953	Plenum of the Central Committee of the CPSU. Election of the secretariat. G.M. Malenkov left the post of secretary, V. Molotov and L. Beria remain deputies. Rise of S. Khrushchev. The Presidium of the Council of Ministers of the USSR- Beria suggests limiting to keeping the territory of East Germany under the Soviet military control without building socialism. The uprising against the communist government in East Germany. An emergency situation declared by the Soviet military commandant of Berlin, the suppression of the uprising by the Soviet troops. Minister of Internal Affairs Beria is arrested (for attempted seizure of power he is shot). Fidel Castro makes an attempt to overthrow the government of Batista – attacks on the Moncada barracks (Castro is arrested, in 1955 after an amnesty he is sent to Mexico).
1954	Berlin – a meeting (the ministers of foreign affairs of the United States, the USSR, Britain and France) on the relaxation of international tension. In the USA – the announcement of a successful hydrogen bomb test on the Marshall Islands. Great concern caused by the explosion and radioactive fallout all over the world. North Vietnam – the surrounded French units surrender. In Peking, the first National People's Congress adopted the constitution of the People's Republic of China. Mao-Zedong is elected chairman. The United States, Great Britain, France and the USSR agree to ending the occupation of Germany. West- European Union.
1955	The Warsaw Treaty on Friendship, Cooperation and Mutual Assistance between the USSR, Albania, Bulgaria, Czechoslovakia, Eastern Germany, Hungary, Poland and Romania.
1956	Hungary leaves the Warsaw Pact countries, it appeals to the UN for help against the invasion of Soviet troops.
1957	The USSR – the world's first artificial Earth satellite.
1960	The year of Africa – the formation of 17 independent states within the year. The reconnaissance aircraft of Harry Powers over the Urals.
1961	The first space flight of Yuri Gagarin on "Vostok" -1. The landing in Cuba of 1500 Cuban exiles, trained by the US military – the population does not support the invasion. The US provides direct military support to South Korea in the fight against the partisans.
1962	The "Caribbean crisis".
1963	The United States, the USSR and Great Britain sign the Treaty on the Prohibition of Nuclear Weapon Tests (96 countries have joined, France refuses).
1964	North Vietnam attacks the US destroyer "Maddox"; in response, a bomb attack is fired at the naval bases of northern Vietnam. Night session of the Plenum of the Central Committee. L.I. Brezhnev takes the duties of First Secretary of the Central Committee of the CPSU, Khrushchev is dismissed from the government of the country
1965	The US troops invasion of the Dominican Republic.
1966	The US bombed the capital of North Vietnam Hanoi for the first time.
1967	The treaty on outer space, signed by the USSR, the United States and Great Britain. The outbreak of hostilities between Israel and a number of Arab states. Six-day war. The UN Security Council adopts Resolution 242

	demanding the withdrawal of Israeli troops from the occupied Arab territories.
1968	Murder of Martin Luther King in the United States. Barricades in Paris, a clash of students with the police. The workers join them. The Treaty on the Non-Proliferation of Nuclear Weapons is signed by 61 states, including the United Kingdom, the United States and the USSR. Czechoslovakia is occupied by the troops of the USSR, the GDR, Poland, Hungary, Bulgaria.
1969	The military conflict between the USSR and the PRC in the vicinity of Damansky Island. The first flight to the Moon of American astronauts. John Lennon returns the Order of the British Empire to the British Government
1970	Presidential elections in Chile – Salvador Allende. The crisis in Poland – the clash of demonstrators with the troops, Gomulka resigned.
1971	The signing of the Seabed Treaty (prohibition of the placement of nuclear weapons in its depths, etc.). The United States, Great Britain, France and the USSR sign an agreement on the relationship between West Berlin and West Germany.
1972	The USSR and the US sign an agreement on the limitation of anti-ballistic missile systems.
1973	Helsinki meeting on security.
1974	Nixon's visit to Moscow. The Treaty on the Limitation of Underground Nuclear Tests.
1975	The operation for liberation in Vietnam. The Final Act of the CSCE in Helsinki. Francisco Franco, the dictator of Spain, died.
1976	The United States and the USSR Treaty on the prohibition of nuclear explosions of more than 150 kg.
1977	The President of Egypt, Anwar Sadat, paid a visit to Israel.
1978	The monarchy is overthrown in Afganistan. Pope John Paul II. Peace and Friendship Treaty between China and Japan. Talks at Camp David between Egypt and Israel and the United States.
1979	Vietnamese troops took Pnompen. Chinese troops invaded Vietnam. The first elections to the European Parliament. The overthrow of dictator Samos in Nicaragua. The head of state in Afghanistan is dismissed. The emperor of the CAR is dismissed, and the republic is proclaimed by the parachutists. The military block CENTO is disbanded. The president of South Korea and the dismissed head of Afghanistan are killed.
1980	Attempted coup in Thailand.
1981	Martial law in Poland (Wojciech Jaruzelski).
1982	Falkland's military conflict. LI Brezhnev died. Yu.V. Andropov is elected.
1985	The death of K. Chernenko. M.S. Gorbachev is First Secretary. The first meeting between Reagan and Gorbachev
1986	Chernobyl. The radiation increase in Sweden, Denmark, Finland.
1987	The beginning of the construction of the tunnel under the English Channel between England and France.
1988	The withdrawal of Soviet troops from Afghanistan. Benazir Bhutto – prime minister of Pakistan. Recognition of the right to existence of the State of Israel by Yasser Arafat.
1989	M. Gorbachev meets with Pope John Paul II in the Vatican.
1990	The UN resolution on the imposition of a trade embargo against Iraq and then on the use of force against Iraq. Margaret Thatcher's resignation. Meeting under the English Channel.

1991	Operation “The storm in the Desert” – American troops with the allies against Iraq. Iraq drains oil reserves into the Persian Gulf, sets its oil wells on fire. Land Operation in Iraq. The Warsaw Pact is disbanded. Soviet troops are withdrawn from Hungary and Czechoslovakia. Bush and Gorbachev sign an agreement on strategic arms reduction, which reduces the number of missiles by 1/3. State Emergency Committee in Moscow. Belovezhsky agreements on the elimination of the USSR and the establishment of the UIS.
1993	Czechoslovakia is finally divided into two countries. Bush and Yeltsin sign the treaty on the reduction of strategic weapons of nuclear warheads by 2/3. The shell of the Supreme Soviet House by the Government tanks. Gustav Husak, the head of Czechoslovakia, died.
1994	The troops of the Russian Federation began military actions on the territory of the Chechen Republic.
1996	The signing of an agreement in Khasavyurt on ending the war in Chechnya.
1999	NATO aircraft made the first raid on Yugoslavia. The NATO charter is violated.
2001	Start up of Wikipedia. The biggest terrorist act in the United States. The beginning of the war in Afghanistan.
2002	The start of circulation of Euro banknotes and coins in the European Union. East Timor gained independence from Indonesia.
2003	Catastrophe of the shuttle Columbia. The beginning of the war in Iraq. The International Criminal Court starts its work. A series (until 2005) of bloodless color revolutions. Change of power in Georgia, Ukraine, Kyrgyzstan, Lebanon
2004	Mars-walker "Spirit" descended to Mars. Start of Facebook. Expansion of the European Union, inclusion of 10 new countries. "Orange" revolution in the Ukraine.
2006	The first in the 21st century a total solar eclipse in the territory of Russia. Montenegro gained independence and became the 192nd member of the UN.
2008	Kosovo declared independence from Serbia. The war in South Ossetia. The first African American is the US president.
2009	The end of the second Chechen war.
2011	Mass protests to overthrow the regime of Hosni Mubarak in Egypt. The unrest in North Africa and the Middle East. Fukushima. The beginning of the civil war in Syria. Murder of Muammar Gaddafi. , There are 7 billion people on the Earth.
2012	Putin is elected President of the Russian Federation for the third time. Barack Obama is president for the second time in the US. Debts of Greece. Conflict in Syria. Floods in Krymsk.
2013	Meteorite – in the Urals. Evroimaydan – in the Ukraine.
2014	The Crimea joins the Russian Federation. An armed conflict in the east of the Ukraine.
2015	The beginning of Russia's military operation in Syria.
2016	Presidential elections in the USA. IGIL. Syria. The Ukraine. Oil.
2017	Election of US President D. Trump. The St. Petersburg International Economic Forum gathered a record number of 14,000 participants, the main question: "How to save money and real estate that was exported abroad?" An unusually cold summer, a hurricane in Moscow, record heavy showers and snow. Change in the color of the Black Sea, the shallowing of

Venice canals, fires and drought in Europe. Syria: Russia-Turkey-Iran. Referendum in Catalonia, Veneto and Lombardy (Italy), Kurdistan (Iraq). The Valdai Club and V. Putin's speech. The XIX Congress of the Communist Party of China.

Content

Foreword	3
Acknowledgments	12
Prologue	15
Introduction	23
Chapter 1. The planetary level of secrecy, or "the operation of disclosure"	26
1.1. The Beginning.....	28
1.2. Before the "Capture"	33
1.3. Parasitic civilization – Ebrs.....	37
1.4. The Attack	39
1.5. Phaeton Catastrophe	44
1.6. Restructuring (for themselves)	45
1.7. A little about the Sun	52
1.8. The takeover of the planet of the Earth.....	56
1.9. Available Means	58
Chapter 2. "Spiders' Laboratory Experiments"	80
2.1. The first stage of the violent "Civilization" of the Earth	80
2.2. Attempts to create people	81
2.3. "The Second Civilization"	85
2.4. The third stage of the intervention	88
2.5. Preparation and the fourth stage of the violent intervention	91
2.6. Technical implementation of the Control.....	92
2.7. Formation of Consciousness	99
2.8. The development of the Brain genotypes of the alien Control System	103
Chapter 3. Fundamentals of the material world and the formation of the Brain genotypes	118
3.1. The basics	119
3.2. Object 440 (Variant of the Alpine Complex)	130
3.3. Cluster System of the Control	133
3.4. About the creation of the "Shirt", failure of Intruders and of the collateral.....	143
3.5. The concept of unscientific perception and Reincarnation	151
3.6. Sleep as karma control.....	159
3.7. Language as means of communication.	161
3.8. Blood, DNA and the lungs memory	162
Chapter 4. The basic functions of the atmosphere layers and the formation of people's consciousness	165
4.1. Consciousness as a factor	168
4.2. Functions of the Interventionist System Atmosphere layers....	170
4.3. Formation	172
4.4. The Abode of Gods.....	177
4.5. The root of the problem	186

4.6. Understanding	190
4.7. Variations	192
4.8. The approach	203
4.9. Biological sphere.....	209
Chapter 5. Deliberate knowledge of the unknown	211
5.1. Wanted Necessity	211
5.2. Tritium, the Bath and the unknown	215
5.3. Why do biostructures need water?.....	218
5.4. "Bright" future	224
5.5. The Essence	226
5.6. Specificity	230
5.7. Pyramidality	234
5.8. The Control and Atmosphere layers No 2 and 3.....	237
5.9. Need for thought	246
5.10. Biomass	257
5.11. What to wait? How to perceive?	259
Chapter 6. About the creator of the "Bannoye delo"	264
6.1. This "unknown" Khatybov.....	266
6.2. So what is known about A.M. Khatybov?	271
6.3. The Personality, we cannot do without	279
6.4. Aspiration. And we will go on with Khatybov.....	284
6.5. Shlisselburg convict	311
6.6. Quintessence.....	321
Afterword	324
Appendix.....	330