



FIRE AND RESCUE DEPARTMENTS
OF NORTHERN VIRGINIA
FIREFIGHTING AND
EMERGENCY OPERATIONS
MANUAL

**FIRES IN STRIP
SHOPPING
CENTERS**

Fourth Edition

Issued: April 2003
Revised: April 2022

ACKNOWLEDGEMENTS

The *Fires in Strip Shopping Centers, Fourth Edition*, manual was developed through a cooperative effort of the following Northern Virginia fire departments:

- City of Alexandria
- Arlington County
- City of Fairfax
- Fairfax County
- Fauquier County
- Fort Belvoir
- Fort Myer
- Loudon County
- City of Manassas
- City of Manassas Park
- Marine Corps Base Quantico
- Metropolitan Washington Airports Authority
- Prince William County
- Stafford County

The NOVA Fire Operations Board and a group of subject-matter experts developed the first edition of this manual (released in June 2003). The Technical Writing Group revised the manual in March 2009 and 2013, and the NOVA Fire Operations Board approved and published second and third editions. The NOVA Fire Operations Board oversaw this fourth edition with content developed by the Technical Writing Group.

PREFACE

A strip shopping center fire can occur in buildings with various dimensions and construction features. The strip shopping center design dates from post-World War II to the present. During this time, construction type has ranged from ordinary to lightweight. The majority of these structures are noncombustible.

Firefighters must understand these structures may not have fire protection systems in place, and construction features may contribute to the rapid horizontal spread of fire.

Firefighters face a high potential for experiencing life hazards in these occupancies. Potential hazards include:

- collapsing roofs, floors, and walls;
- heavy fire loading;
- maze-like conditions;
- limited access and egress;
- complicated security measures;
- undetected fires in the plenum space;
- hazardous materials;
- difficult rooftop ventilation;
- falling facades; and
- high entanglement potential.

The key change made to the fourth edition of *Fires in Strip Shopping Centers* involve an expanded discussion of aerial master stream operations and significant content reorganization to improve document structure.

INTRODUCTION

The purpose of this manual is to describe the type of buildings found in strip shopping centers. These structures comprise a large portion of the commercial occupancies in Northern Virginia.

This manual identifies:

- construction features,
- inherent firefighting problems,
- operational priorities, and
- known risks and hazards.

The manual also establishes a standard operation method for fighting fires in these types of structures.

GLOSSARY

The following key terms and definitions were used in this manual:

- *Cockloft* – This term refers to a void space created between the top floor ceiling and the building’s roof decking.
- *Plenum space* – Plenum space provides pathways for heating and air conditioning system return airflow, facilitating a building’s air circulation. The space between the structural ceiling and the drop-ceiling or under a raised floor typically qualifies as plenum. However, some drop-ceiling designs create a tight seal that impedes airflow. These designs may not be considered plenum air-handling space.
- *Taxpayer* – This term refers to a small 1- or 2-story building constructed to cover the annual property tax assessed for owning a parcel of land.

TABLE OF CONTENTS

ACKNOWLEDGEMENTS 2

PREFACE iii

INTRODUCTION iv

GLOSSARY v

LIST OF FIGURES viii

DESCRIPTION..... 1

 General Characteristics 1

 Rear Delivery Areas..... 4

 Auxiliary Fire Protection Systems 5

 Construction..... 5

 Cocklofts 5

 Roofs 7

 Walls 8

 Facades..... 10

 Floor Assemblies 10

 Basement Areas 10

 Roll-Down Security Doors and Gates..... 12

 Entry and Exit Doors 13

HAZARDS..... 15

 Life Hazards..... 15

 Collapse..... 16

 Basements 17

 Hazardous Materials 18

Backdrafts and Flashover.....	18
FIRE OPERATIONS	19
Command Considerations.....	19
Operational Communications	21
Hoseline Selection and Advancement	22
Aerial Master Streams.....	23
Roof, Attic, and Cockloft Fires.....	25
Basement Fires.....	26
Operations in the Rear	26
RESOURCES FOR FIRES IN STRIP SHOPPING CENTERS	28
First Due Engine	28
Second Due Engine.....	28
Third Due Engine.....	29
Fourth Due Engine.....	29
First Due Truck.....	29
Second Due Truck.....	30
Rescue.....	31
EMS Units.....	31
OTHER CONSIDERATIONS.....	32
Forcible Entry	32
Plenum Space.....	32
Ladder Deployment	32
Search and Rescue	33

Ventilation.....	33
Vertical Ventilation.....	33
Fire Extension.....	34
Hood Systems	35

LIST OF FIGURES

Figure 1. Rear windows secured with metal bars.	2
Figure 2. Example of a basement in a strip shopping center.	2
Figure 3. Horizontal fire extension in absence of firewalls.	3
Figure 4. Difficult-to-identifying individual occupancies in the rear.	4
Figure 5. Back-to-back stores with no rear addresses.....	4
Figure 6. Difficult access in rear of buildings.....	5
Figure 7. Strip shopping center cockloft.	6
Figure 8. Lack of fire stopping between occupancies.....	6
Figure 9. Non-fire-rated draft stops	7
Figure 10. Roof assembly supported by steel bar joists.....	7
Figure 11. Roof assembly with precast T and double-T beams.....	8
Figure 12. New roof assembly over the existing roof.....	8
Figure 13. Tilt-up construction design.....	9
Figure 14. Parapet walls on roof edge.....	10
Figure 15. A basement spanning multiple addresses.	11
Figure 16. Basement access.	11
Figure 17. Basement entrance in sidewalk.....	12

Figure 18. Roll-down gates.....	12
Figure 19. Drop-in static bar.....	13
Figure 20. Maverick Bars.....	14
Figure 21. Varying store depths.....	15
Figure 22. Steel bar joists.....	16
Figure 23. Fire spread to facade with collapse.....	17
Figure 24. Fire extension via the front wall facade.....	20
Figure 25. Exposure numbering with one unit involved.....	20
Figure 26. Exposure numbering with three units involved.....	21
Figure 27. Tower ladder master stream operation.	24
Figure 28. Inspection holes.....	25
Figure 29. Basement stairway.....	26
Figure 30. Crew removing ceiling tiles as they advance.	32

DESCRIPTION

The term *strip shopping center* refers to commercial occupancies that are

- joined by party walls or firewalls,
- covered by a common roof,
- occupied by a variety of businesses, and
- accessed by individual exterior entrances on the first floor.

General Characteristics

Strip shopping centers are long commercial structures that house a variety of occupancies under one roof. They are typically constructed on large open lots with parking areas located on the building's front and sides and rear parking reserved for delivery access. Although some small strip shopping centers contain only specialty shops, the typical installation incorporates a large anchor store (e.g., a supermarket, department store, or appliance store) with several smaller stores attached to either side.

In more congested urban settings, strip shopping centers may comprise entire city blocks, with limited parking along the roadway. Delivery vehicles may have narrow rear alley access or may only have access through the front entrances.

Strip shopping centers in Northern Virginia are typically 1-story buildings of lightweight and noncombustible construction. Occasionally, personnel may encounter 2-story structures. Most walls are masonry or tilt-up concrete, with steel bar joists supporting a metal deck roof. In older sections of Northern Virginia, ordinary construction may be found. The presence of basements is more likely in these older strip shopping centers.

Personnel may encounter residential or office spaces above some strip shopping centers. Apartments in these settings are often referred to as "taxpayers." Most taxpayers have a separate entrance not connected to the store below. They exist in older structures but can also be found in newer, town center occupancies.

Store dimensions in strip shopping centers are typically narrow and deep and can vary greatly. Smaller stores may have dimensions of 30 ft by 75 ft. Anchor stores (e.g., supermarkets) have similar depth as smaller occupancies but have much wider footprints. The width of these large stores can easily exceed 150 ft.

Adjacent occupancies may share a cockloft. Old anchor stores may have been subdivided into several smaller businesses, resulting in a common cockloft.

Storefronts have large plate glass or tempered glass windows and tempered glass doors in a metal frame.

Rear entry doors are typically metal and heavily secured with drop bars and additional locks. Rear windows usually are secured with metal bars or heavy mesh (see Figure 1).



Figure 1. Rear windows secured with metal bars.

Basements are usually accessed from the rear via an interior or exterior stair. Basements can extend beyond the occupancy from which they are accessed (see Figure 2).

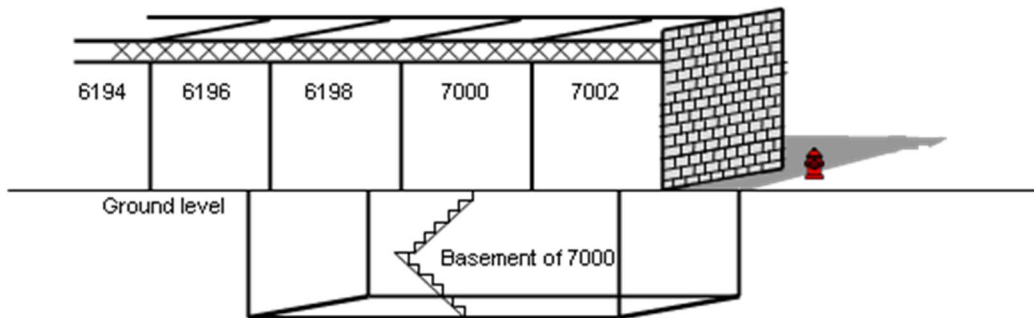

Figure 2. Example of a basement in a strip shopping center.

Firewalls may not exist between occupancies. The fire shown in Figure 3 entered the plenum area above the ceiling and quickly traveled horizontally causing extension into multiple adjacent units.



Figure 3. Horizontal fire extension in absence of firewalls.

Fire loading in the strip shopping center may be moderate to heavy. Initial fire flow estimates should be based on 20 gpm per 100 sqft of involved area. Engine companies should prepare to utilize a variety of tools and tactics to achieve the required fire flow:

- multiple 1.88-in. handlines,
- a combination of 1.88- and 2.5-in. handlines,
- a portable monitor such as the Akron Brass Mercury monitor,
- apparatus mounted monitors, and
- at-grade aerial master streams.

Addresses may only appear on the front of each store, impeding efforts to identify the individual occupancies in the rear (see Figure 4).



Figure 4. Difficult-to-identifying individual occupancies in the rear.

Some shopping centers have back-to-back stores with addresses on both sides and no rear access (see Figure 5). Most often, these configurations include a large parking lot out front and along the sides. The rear is normally accessed by a narrow driveway used for deliveries. This allows for staging of incoming apparatus on four sides unless other vehicles or obstacles have congested the rear.

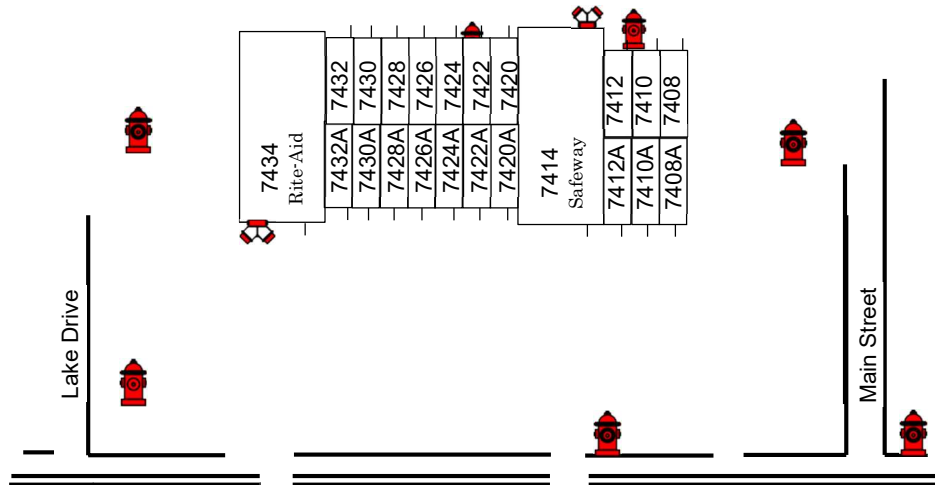

Figure 5. Back-to-back stores with no rear addresses.

Rear Delivery Areas

The rear sides of buildings are sometimes difficult to access (see Figure 6) because dumpsters, compactors, delivery trucks, trailers, pallets, or cardboard storage may block them. Personnel may also encounter hazards such as low overhanging electric wires, gas meters, fuel oil tanks, liquified petroleum gas tanks, large potholes, and inadequate lighting.



Figure 6. Difficult access in rear of buildings.

Auxiliary Fire Protection Systems

Strip shopping centers have inconsistent auxiliary fire protection systems. Some centers have full or partial automatic sprinkler systems that may be wet or dry, and others have no sprinkler protection at all.

Personnel may encounter a bank of fire department connections (FDCs) feeding various sections of a building. Oftentimes, these connections are not clearly marked to show which section they serve, so they require preplanning to help firefighters identify methods for proper system charging.

Construction

Most strip shopping centers in Northern Virginia are of noncombustible materials. Buildings erected prior to 1970 are typically of ordinary construction, and more recent structures utilized lightweight construction methods.

Cocklofts

The cockloft is located above the ceiling and below the roof deck (see Figure 7). It is not unusual to find the cockloft exposed in the rear storage area.

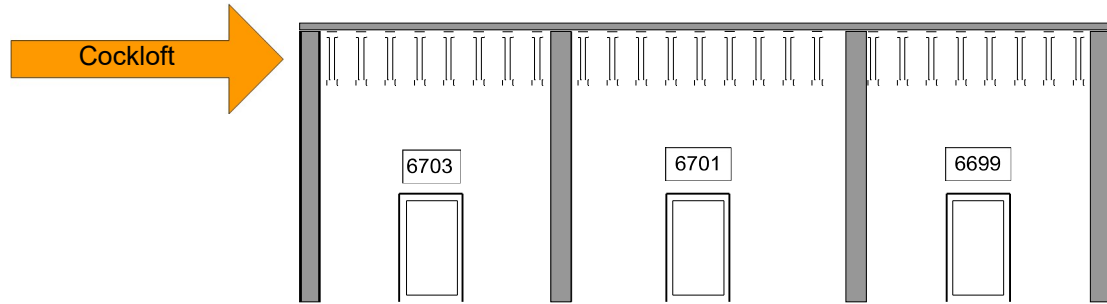

Figure 7. Strip shopping center cockloft.

Modern codes require firewalls or party walls between occupancies, but older structures may not include any fire stopping. Figure 8 shows lightweight steel bar joists between several occupancies and a lack of fire stopping.



Figure 8. Lack of fire stopping between occupancies.

Non-fire-rated draft stops made of gypsum or plywood slow the horizontal movement of fire. They may be found in large cockloft areas (see Figure 9) and usually have penetrations allowing for wiring, ductwork, and pipes. They may also have large access holes for use by maintenance personnel.

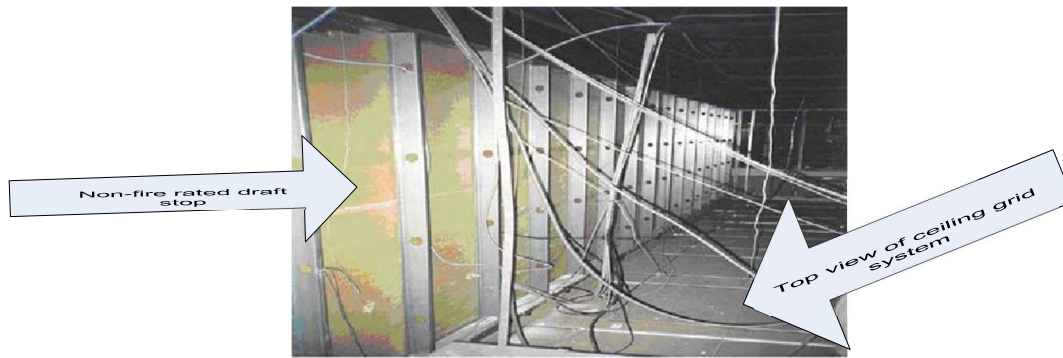

Figure 9. Non-fire-rated draft stops made of gypsum or plywood impede horizontal fire movement.

Roofs

Strip shopping centers built of ordinary construction have a wood roof assembly. The roof deck includes tongue-and-groove boards or plywood sheeting.

Laminated wooden arches that span a wide area and support the roof may be present. These are common in old Safeway stores. The roof covering is typically built up where an asphalt-containing (i.e., bituminous) material is laid directly over the wood and covered with roofing felt. It is then sealed with hot tar and covered with gravel.

Strip shopping centers of noncombustible construction have roof assemblies supported by steel bar joists. The roof deck may be corrugated metal with a layer of insulation covered by tar paper and roofing tar or a rubber membrane (see Figure 10). A fire-rated drop-ceiling is located below the bar joist in the retail area. Typically, the storage area roof assembly is not protected.

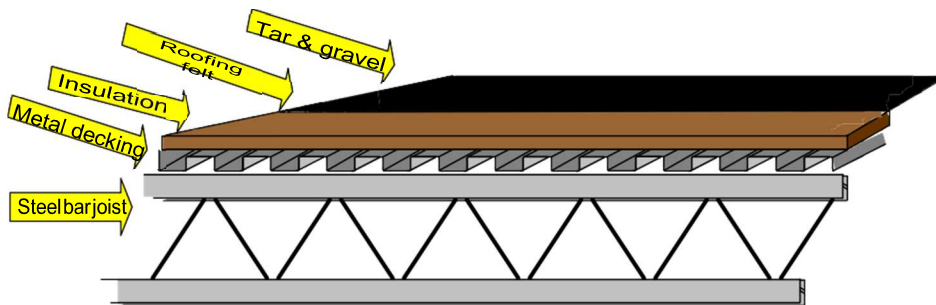

Figure 10. Roof assembly supported by steel bar joists.

Lightweight concrete roofs often appear in strip shopping centers. The roof assembly consists of bar joist, metal decking, and concrete that is poured over the decking. Another type of concrete roof is the precast T and double-T beams found in tilt-up construction (see Figure 11).

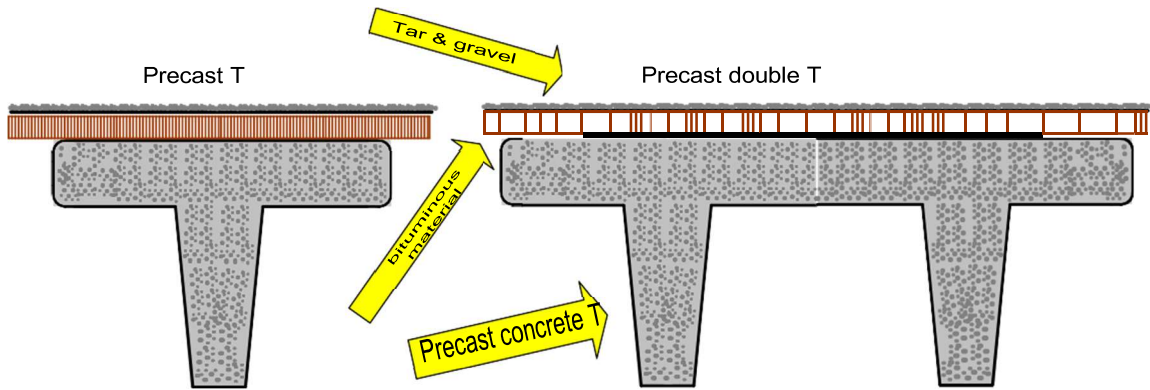

Figure 11. Roof assembly with precast T and double-T beams.

Renovated strip shopping centers may have a new roof assembly over the existing roof. This creates an additional undivided void space that is difficult to access (see Figure 12). These roofs are also called “rain roofs” because they cover existing roofs. In these cases, the original roof was not designed to carry the new roof’s extra weight, making it more vulnerable to early collapse. Penetrations found in roofs may include skylights, scuttles, ventilators, and exhaust ducts.

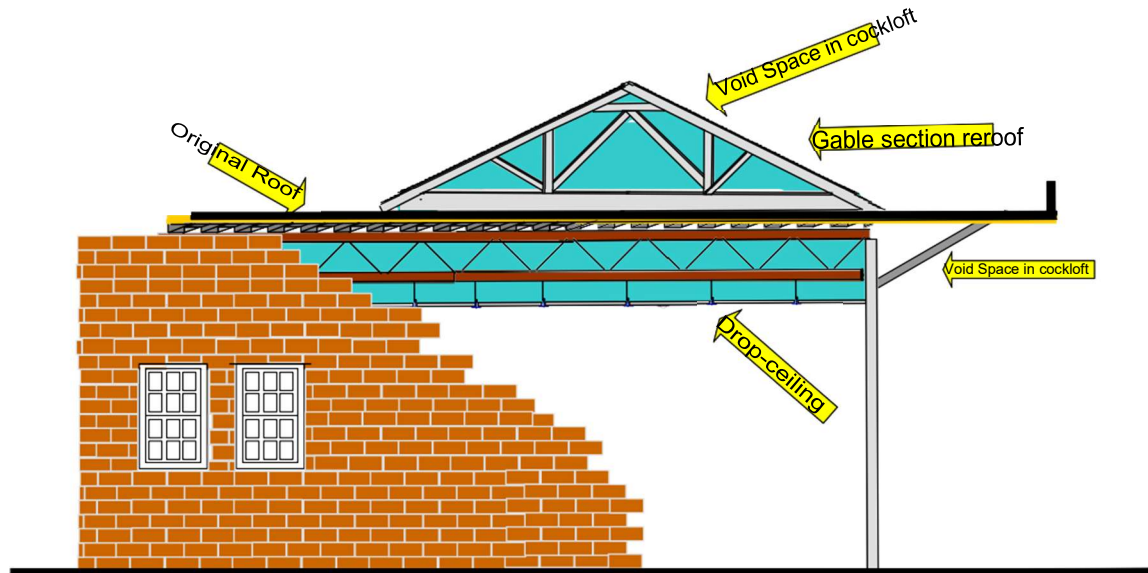

Figure 12. New roof assembly over the existing roof.

Walls

The following types of walls occur in strip shopping centers:

- Load-bearing walls. These walls hold the structure’s weight and all forces applied.
- Non-load-bearing walls. These walls hold only their own weight (e.g., veneer, curtain, partition).
- Firewalls. Firewalls prevent or slow the horizontal progression of fire from occupancies spanning from the floor through the roof structure.

- Veneer. Veneer is a single thickness of a masonry material (e.g., stone, brick, or block) added to the structure for aesthetic purposes.
- Party. Party refers to a wall separating occupancies that extends beyond the ceiling but not to the roofline.
- Partition. A partition divides an area within an occupancy without extending above the ceiling.

The type of construction and occupancy dictates the need for a firewall or fire separation. Wall construction methods can be precast tilt-up, masonry, and wood or metal frame. Automatic sprinklers can reduce the wall assembly's required fire rating. Often, groups of stores of the same occupancy type have no rated separation between them.

Some firewalls terminate below the roofline, but the most effective firewalls run from the foundation through the roofline. These are usually masonry and more substantial than occupancy fire separation walls.

The stability of walls in tilt-up construction depends upon the roof assembly tying the building together. A typical tilt-up construction design appears in Figure 13; should the roof assembly collapse into the structure, the walls are expected to fall outward.

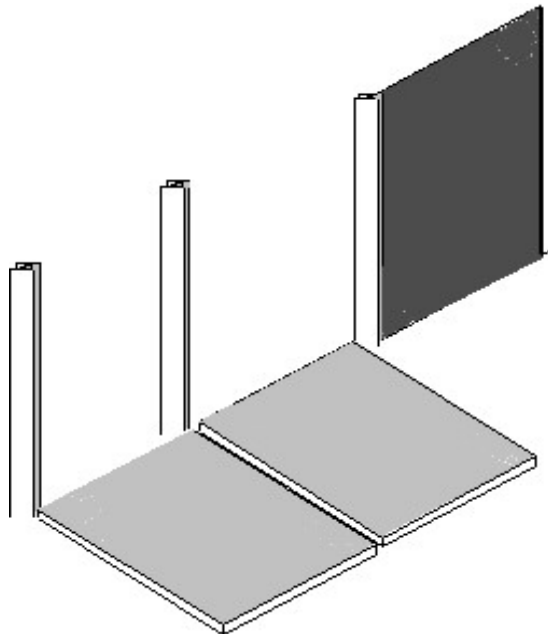

Figure 13. Tilt-up construction design.

Typically, the load-bearing walls in strip shopping centers run from front to back. The roof assembly and, occasionally, the second floor can expand and push out on the wall during fire situations.

Parapet walls extend upward above the edge of the roof (see Figure 14). The parapet creates a drop that may require a ladder to descend to the roof. Parapets occur on the front and sometimes sides of a building; they are not typically found in the rear.



Figure 14. Parapet walls on roof edge.

Facades

A facade is an architectural projection that provides weather protection, occupancy identity, and decoration. Facades are supported by the building to which they are attached. Draft stopping may be found at intervals in the concealed areas.

Floor Assemblies

The following types of floor assemblies occur in strip shopping centers:

- reinforced concrete,
- dimensional lumber,
- lightweight wood, and
- steel bar joist.

In newer construction, personnel should expect fire separations between taxpayer residencies and commercial occupancies. In older construction, fire separations may not exist between the commercial and residential units.

Basement Areas

The basement in strip shopping centers can be used for storage, offices, or other functions. A common basement may span multiple addresses (see Figure 15).

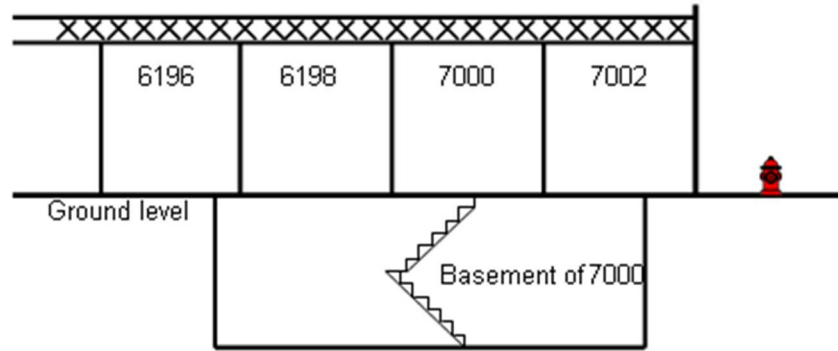

Figure 15. A basement spanning multiple addresses.

Access to basement areas typically opens to the interior. When present, exterior basement entrances typically open at the rear of the store (see Figure 16).



Figure 16. Basement access.

Exterior basement entrances may also open in the sidewalk at the storefront or on one side of the building (see Figure 17). These entrances are usually located under steel doors or grates. They may involve a simple set of steps but can also contain conveyors, slides, or chutes for supply deliveries into the basement. Conveyors, slides, or chutes provide very good ventilation, but they should not be used to enter the basement.



Figure 17. Basement entrance in sidewalk.

Strip shopping center basements contain many different materials. Firefighters should expect to find items not necessarily related to the associated business. Stock may be piled from floor-to-ceiling, making sprinkler systems less effective. Depending on the structure's age, sprinklers may not be present.

Roll-Down Security Doors and Gates

To prevent crime after hours, some store owners use steel roll-down security doors or gates (see Figure 18). These roll-down devices cover large glass openings on storefronts and are secured by guide rails that travel from the top to the bottom of the door on each side of the device. These doors can cover a single entrance or a complete storefront. When they cover the storefront, they can delay fire discovery. Some of these doors have a spring-loaded ratchet system to facilitate opening and closing the gate. The locking mechanism usually involves a slide bolt with several locks.



Figure 18. Roll-down gates.

Entry and Exit Doors

Public access and egress occur at storefronts, but some occupancies have emergency exits in the rear. Check-out counters, shopping carts, and merchandise displays can obstruct these areas, especially during the major holiday seasons.

Many strip shopping centers have two stories with separate occupancies on both levels. Access to the second story is generally located in a common public area at the ends or middle of the building. Individual occupancies lead off a common hallway.

Large anchor stores may have a second mercantile floor with interior stairs, elevators, or escalators connecting the two levels.

The security device found at rear doors is normally a drop-in static bar (see Figure 19). Welded or bolted brackets attached to the door and frame hold the bar in place.



Figure 19. Drop-in static bar. Interior view (top) and exterior view (bottom).

Maverick Bars present another type of security used by major electronics retail stores and other retailers in high-crime areas (see Figure 20). The bars fit into brackets positioned on the door frame and the door. When in place, the bars secure the door to the door frame, making it much more difficult and time-consuming to gain access from the exterior. Outside evidence of attachments at the door's top and bottom will indicate the presence of Maverick Bars.



Figure 20. Maverick Bars. Without bars in place (left) and with bars in place (right).

HAZARDS

This section describes hazards that may occur in strip shopping centers.

Life Hazards

A building's structure and content influence the life hazards associated with emergency operations. To determine the hazards associated with a building's construction, design, and layout, personnel should conduct preincident planning during the construction phase. To determine the hazards posed by the building's contents, personnel should conduct annual postconstruction walk-throughs.

Life hazards in strip shopping centers may be more likely during nighttime hours than during the day. Occupants present during normal business hours will likely self-evacuate during an emergency. After business hours, however, cleaning crews sometimes lock themselves inside occupancies for security, and owners of small or family-owned businesses sometimes sleep on the premises.

Two-story strip shopping centers can present more significant life hazards. Occupancies, such as apartments (i.e., taxpayers), offices, and social halls, can exist in areas above and below street level. Consequently, these areas present a potential life hazard at all times of the day and night.

Firefighters on the roof should note varying individual store depths along the rear of the shopping center. For example, one store may extend 90 ft from front to back, and the adjoining store may extend only 75 ft from front to back (see Figure 21).

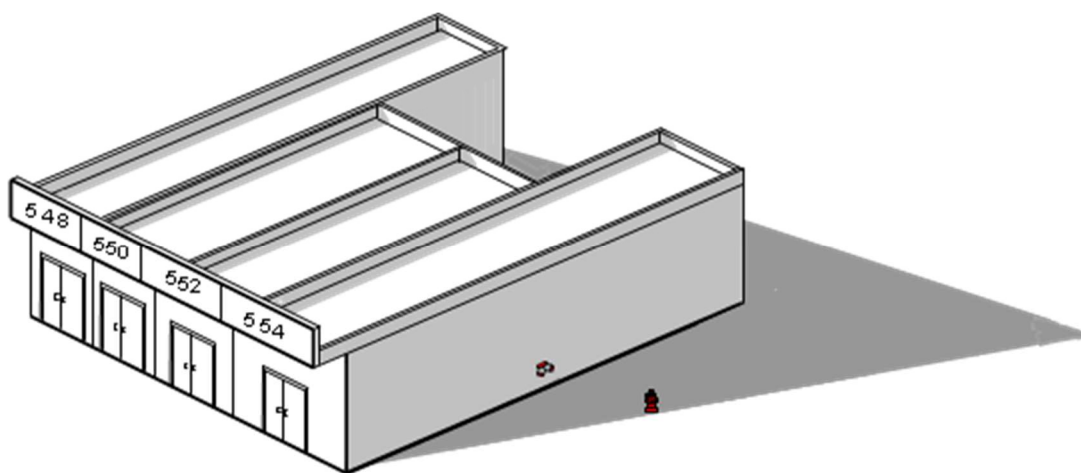

Figure 21. Varying store depths.

Parapets running front to rear often separate occupancies. Personnel must understand that the building depth from front to rear can differ on either side of these parapets.

Collapse

Bulges, cracks, and seeping smoke all indicate possible wall collapse. When observed, personnel must maintain a collapse zone of at least 1.5 times the wall height.

The potential for structural collapse at a strip shopping center depends on several variables. The type of construction, along with the size, intensity, and duration of a fire, can all contribute to collapse. Collapses generally involve roof structures and cantilever facades or marquees.

The front walls of most buildings are considered veneer, with the facade connected. Facades can be free-standing or supported and can include a parapet, marquee, canopy, or cornice. When steel trusses heat and expand, they may push the facade and cause a collapse.

Given the use of trusses in strip shopping center construction, personnel should anticipate partial roof collapse in advanced fires. The roofs and floors may have metal or masonry systems, including metal deck and steel bar joists. The walls may be constructed of metal or masonry. Large fires can compromise the roof structures and damage the unprotected steel, destroying the building's integrity. At 1,000 °F, steel twists and expands, causing failure or pushing out the exterior walls. Figure 22 shows bar joists beginning to fail and frozen in place once cooled. Heavy loading on roof systems can add a tremendous amount of weight, adding to collapse potential.



Figure 22. Steel bar joists. Beginning to fail in high temperatures (left) and frozen in place once cooled (right).

Fires in the plenum space above the suspended ceiling may burn undetected and weaken the roof supports. This can lead to collapse and trap personnel below. In 1996, the U.S. Fire Administration investigated a Virginia ceiling collapse that killed two firefighters. To learn more about this event, see the administration's [technical report](#).

The mass of grid members comprising a roof or ceiling assembly is almost impossible to escape once it falls onto a person. Although illegal, some merchants place combustibles above the drop-ceiling for storage. This adds weight to the ceiling system and may cause an early collapse under fire conditions.

Warning signs of imminent collapse include the following:

- fire burning for more than 20 min in ordinary construction or 10 min in lightweight truss construction,
- smoke or water coming through mortar joints in walls,
- walls that sag or bulge,
- new cracks showing in exterior walls,
- heavy floor or roof loads under fire conditions, and
- spongy roof surface due to fire below.

When a building has been renovated, personnel must consider the potential for early collapse. When a second roof or rain roof has been placed over an existing roof (see Figure 12), numerous void spaces are created where fires can burn undetected for long periods of time and cause considerable damage. Additionally, the original roof was not designed to carry the extra weight of the new roof, making it more vulnerable to early collapse.

Incident Commanders (ICs) and personnel under or around facades should remain cognizant that facades can weaken and collapse or fall off the structure (see Figure 23).



Figure 23. Fire spread to facade with collapse in a strip shopping center fire in Northborough, Massachusetts.

Basements

Operations in strip shopping center basements can pose hazards due to stock arrangement, stairwell location, limited ventilation, and limited means of ingress and egress. These factors increase fire load and hinder hose advancement and search operations in these areas. Personnel should also remain aware that falling stock may block hoseline advancement or impede escape.

Hazardous Materials

Personnel may encounter hazardous materials in quantities that do not require placards in all types of strip shopping center occupancies.

Backdrafts and Flashover

Backdrafts can occur in any type of closed structure, but when they occur in strip shopping centers, they tend to be catastrophic. Ventilating a built-up roof is time-consuming and difficult. In well-advanced fires with large amounts of storefront glass, delayed ventilation makes it more difficult and treacherous to reduce the potential for backdrafts. In these situations, companies should remove the glass, allow the fire to show itself, and relieve some of the heat and smoke before entering.

The potential for backdraft also exists in the plenum spaces above the ceiling and in remodeled roofs where dead areas have been created between the new and original roof.

These circumstances can also result in flashover. Ways to address this phenomenon appear in the tactics section.

FIRE OPERATIONS

Command Considerations

The first command officer to arrive on-scene should establish Command. Fires in strip shopping centers can require more resources than similar fires in other structures. After confirming a fire within a strip shopping center, ICs should evaluate the need for additional resources and make requests for additional alarms and rapid intervention team (RIT) resources commensurate with the situation's severity.

Additional command officers may be used in tactical positions. ICs should assign these positions early in an incident to establish and build an effective and efficient command structure. Strategic positions for additional command officers include the following:

- division supervisors,
- group supervisors,
- branch directors, and
- logistics and planning.

If a fire scenario involves a taxpayer occupancy, personnel must adjust typical strip shopping center tactics, prioritizing the life hazards from both the commercial and residential occupancies.

Horizontal Fire Spread

Horizontal fire extension represents a significant concern in strip shopping centers. Fire can rapidly spread horizontally through cocklofts, suspended ceilings, air handling ductwork, and utility poke-throughs. Fire separations are not required between each occupancy. Therefore, early in the event, personnel must examine exposures to each side of the involved store to check extension resulting from rapid mushrooming of heat and combustible gases under the roof.

Ultimately, each exposure should be checked until no extension is found. It may require multiple companies to accomplish this.

Personnel should consider the time needed to access the occupancies adjacent to the involved unit. ICs and unit officers should anticipate where the fire may have traveled during efforts to gain access. Hoselines should be tactically positioned to prevent the fire from flanking units, causing suppression operations to chase a rapidly extending fire.

Fire can also extend via the facades. Facades can be part of the original construction of a strip shopping center; however, they are often added to the structure's front wall during a renovation. Fire can burn through a front wall and extend into the façade where it can then extend horizontally. Fire that has spread horizontally within a façade can then extend vertically to additional floors. Figure 24 shows fire rolling out of show windows and extending up into the facade, where it moves across the front of the shopping center.



Figure 24. Fire extension via the front wall facade.

Vertical Fire Spread

Vertical fire spread poses a lesser concern than horizontal spread but should still be considered, particularly in multistory strip shopping centers. Vertical spread can occur via ductwork, pipe chases, stairways, stud and column spaces behind walls, elevator shafts, stock conveyor openings, and other vertical arteries.

Exposure Designation

Exposure designation starts with Delta or Bravo 1 and continues as shown in Figure 25.

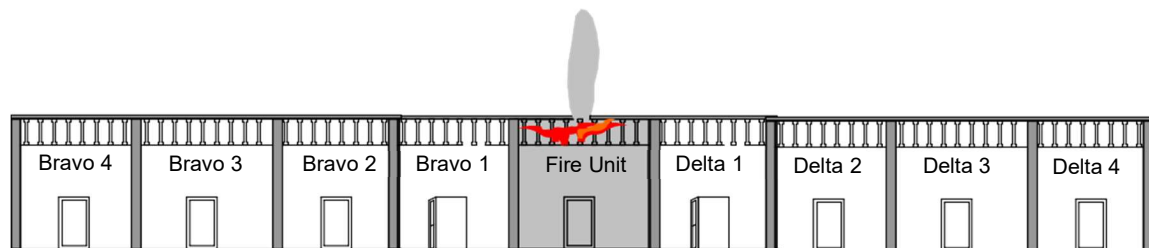

Figure 25. Exposure numbering with one unit involved.

Typically, the exposures are easy to differentiate. However, when fire conditions exist in more than one unit, ICs must decide where to begin exposure identification. They must communicate this to all units working the incident. Once the IC makes the exposure designation, the numbering does not change, even if the fire later extends to other exposures. Figure 26 shows three units involved with fire and the exposure numbering beginning on either side of the fire units.

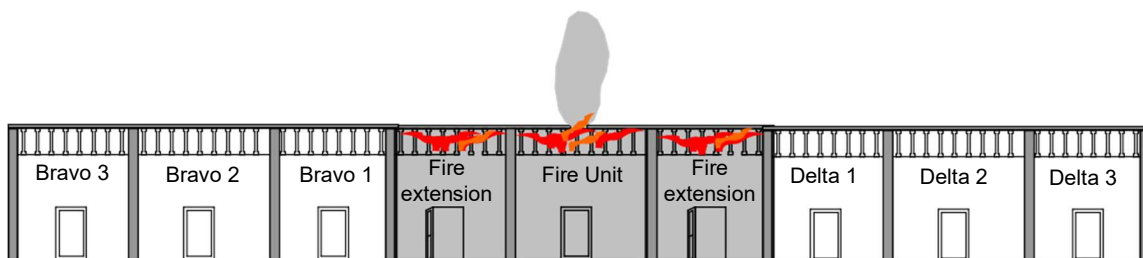

Figure 26. Exposure numbering with three units involved.

Operational Communications

Personnel should reference the NOVA *Field Communications* manual for information about operational communications. Related information specific to fires in strip shopping centers is provided in this section.

Water Supply Report

The unit officer of the first-arriving engine company should communicate a water supply report to the second due engine company, identifying the location and method of the hose lay. When possible, the unit officer should also identify the location of a secondary, side-Alpha hydrant as a potential water supply for aerial master streams.

A forward (i.e., straight) hose lay should be utilized, when possible, with care given to maintaining unimpeded access to subsequently arriving truck companies.

On-Scene Report

The first-arriving unit officer, typically that of the first due engine company, should provide the first due command-level officer the following information in the on-scene report:

- unit identification and side of structure where the apparatus is positioned;
- building height (i.e., number of stories above ground);
- occupancy type; and
- a detailed report of evident conditions, including a description, the side of the structure, and quadrant.

On-scene reports should resemble the following: “Battalion 403 from Engine 434, Engine 434, on-scene, side Alpha of a 1-story, strip shopping center, fire showing from the front door of a middle unit restaurant.”

Size-Up and Situation Report

The type of occupancies within a strip shopping center determine the potential fire load and affect the rate of fire growth. The strategy and tactics employed by first-arriving unit officers should vary with incident location and conditions.

As unit officers conduct their incident size-ups, they should remember that strip shopping centers are commercial structures, so residential fire tactics are not appropriate.

During the size-up, unit officers should assess the location and extent of smoke and fire as well as rescues, access points, number of floors, utilities, and exposures. Due to the typical size and layout of strip shopping centers, conducting a 360° lap is often impractical. For this reason, first-arriving unit officers must communicate and coordinate with units assigned to the rear of the structure. They must do so before finalizing their size-up and determining a mode of operation and tactics. Unit officers must especially coordinate suppression operations with units operating on side Charlie to ensure a fire attack is not made through both sides of the building at the same time.

Unit officers should communicate the size-up results through a situation report to the first due command officer.

Progress reports will follow and should include the following: a thorough analysis of the involved area, including a check of the associated plenum space, the potential life hazards, the need for additional resources, and how environmental factors (e.g., high winds) may impact the firefighting operation. The IC must communicate clear and concise information about the operational mode, strategy, and tactics to all companies operating on the emergency incident.

Hoseline Selection and Advancement

Initial Hoseline

A fire's intensity, size, and location, together with available staffing, should be considered when determining the initial hoseline. Although fire loads vary, a typical strip shopping center has a medium fire load requiring 20 gpm per 100 sqft. A 25 ft by 50 ft store has an area of 1,250 sqft and would require a 250 gpm flow rate.

This gpm can be produced by one 2 ½" handline or two 1 ¾" handlines equipped with 15/16-inch tips. However, stream penetration, and thus extinguishment potential, vary greatly in relation to nozzle configuration and the associated volume of water delivered to the seat of a fire. One 2 ½" handline may deliver more water to the seat of a fire than two 1 ¾" handlines.

Conversely, personnel should consider the manpower required to efficiently maneuver 2 ½" hoselines. These large-caliber hoselines require two companies to advance efficiently inside a structure.

When personnel confront well-advanced fires in strip shopping centers, they should consider using large-caliber handlines and smooth-bore nozzles. Extinguishing these fires requires delivering enough water to the seat of the fire to cool and stop pyrolysis. Large, well-advanced fires in strip shopping centers preclude the use of fog streams for this task; the thermal energy of large fires evaporates the fog stream before its water reaches the burning material.

Personnel should also consider cooling the ceiling as the initial hoseline is advanced to prevent or control fire extension along the ceiling. They should remove the ceiling tiles to check the plenum space for advancing fire. This can be accomplished with long pike poles or hose streams. An additional hoseline should be assigned to another crew to protect the rear of the advancing crew.

When fires have reached advanced stages, and no life hazard exists, personnel should strongly consider using master streams. Personnel should reference the *NOVA Engine Company Operations* manual for more information about fire behavior and fire stream application.

Second Line

The second line for most fires within these types of structures must be able to deliver quantities of water equal to or greater than the attack line. The line should be long enough to reach the initial attack line location or beyond, if required.

Hoseline Advancement

Advancing hoselines into strip shopping center occupancies can be difficult due to overcrowded aisles and other occupancy-related characteristics. Flashover and rollover conditions across elevated ceilings can occur at the point of entry, far from the seat of a well-advanced fire. The ability to deploy hose efficiently and quickly is operationally imperative in these situations. When utilizing large-caliber handlines (e.g., 2 1/2"), personnel should consider pairing units to achieve the needed manpower to advance these heavy tools.

Aerial Master Streams

Aerial master streams provide significantly greater extinguishment potential than smaller caliber hoselines. When personnel encounter large-volume fires in strip shopping center occupancies, they should consider utilizing aerial master streams.

Building characteristics, incident scene geography (e.g., parking lot layout, building set-back), and the IC's operational strategy all influence aerial master stream placement and positioning. Aerial master stream nozzle positioning and hose stream direction may differ with offensive or defensive strategies.

When ICs utilize aerial master streams, the most advantageous position is often at sidewalk level in front of the fire unit, with the hose stream directed toward the occupancy ceiling (see Figure 27). The advantages of this positioning may not change, even when fire has self-vented and burned through the roof.

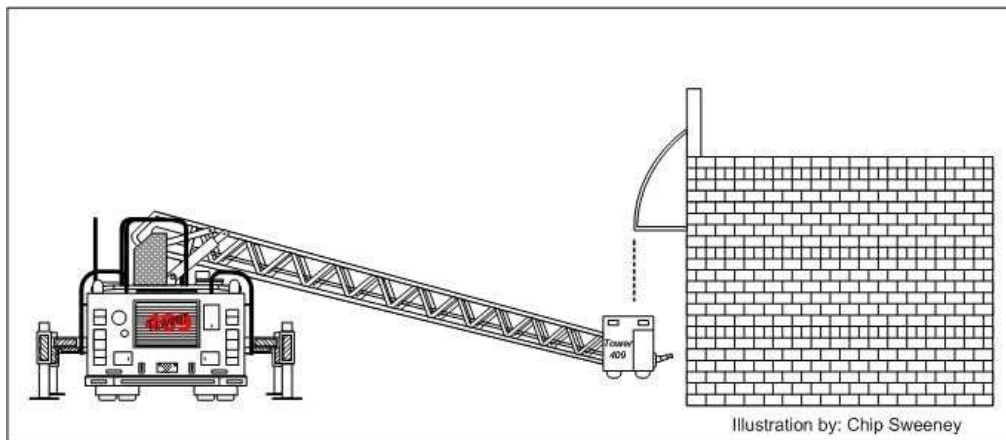

Figure 27. Tower ladder master stream operation.

During offensive fire attacks, personnel generally should not place aerial master streams any higher than necessary to knock down a fire or wet an exposed building. Personnel should use solid stream nozzles during fire attacks for their reach and penetration. They should use fog nozzles for exposure protection.

When incident tactics require mobile, ground-level, heavy-caliber streams, aerial ladders equipped with articulating tower baskets should be used because they can more efficiently achieve the desired dynamic nozzle positioning than straight aerial ladders. If personnel encounter heavy fire conditions requiring either an offensive exterior attack or defensive operations, ICs should prioritize the use of one or more tower ladders on side Alpha. Access to side Alpha should be maintained for tower ladder positioning if a tower ladder was included in the original assignment or if one was ordered on a special call or greater alarm.

During aerial master stream operations, personnel should note the amount of water runoff flowing out of the building. As personnel direct large volumes of water into the structure, the weight of the water remaining in the structure may add stress to fire-compromised structural components, increasing the potential for collapse.

During offensive operations, personnel assigned to operate aerial master streams should pay close attention to hose stream direction and prioritize delivering water to the structure's interior. The impact of these large-caliber hose streams directed against building components (e.g., walls, roofs, facades) can cause structural damage.

The use of aerial master streams for fire attack does not preclude the later interior deployment of smaller caliber handlines to complete extinguishment operations. However, given the potential structural damage caused by large-volume fires and the impact of the water delivered by aerial master streams, personnel should assess structural stability before initiating interior operations.

Roof, Attic, and Cockloft Fires

Personnel operating on strip shopping center roofs should watch for and avoid hot spots and sagging areas. Crews should check roofs for stability as they step onto them and move across them. All members must continually monitor the roof for stability. The unit officer should provide a brief description of the roof conditions and report any unsafe areas to the IC.

Inspection holes help crews assess fire extension (see Figure 28). Kerf cuts are not recommended because the tar melted by the saw can reseal the cut and make it difficult to evaluate the conditions below the roof. Once a roof crew has completed their assigned task, all members should vacate the roof. Crews should have an alternate escape route from the roof, preferably on the side opposite their initial access point.

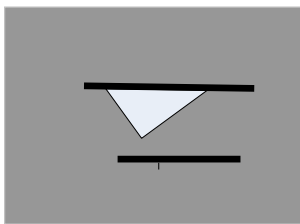

Figure 28. Inspection holes.

It is not uncommon for renovated structures to have more than one roof assembly built on top of older roofs, creating difficult-to-access spaces where fire can enter between the new and original roof. Operating in a tower ladder bucket independently from the roof provides the best means of opening the roof.

Fires in the areas above the ceilings are difficult to access due to the ceiling height and hidden spaces. As crews advance inside a structure, they should check the plenum space above their position for fire extension by removing drop-ceiling tiles with a hose stream or long pike pole.

Personnel should use a thermal imaging camera to check the plenum space. Crews should continue this procedure as they advance into a structure. By doing so, personnel limit the chance of operating in an area with fire above or behind them, avoiding entrapment by a failed ceiling tile support grid.

Personnel should consider heavy-caliber streams for attacking advanced fires under roofs of truss construction. This is particularly true for metal deck roof fires. Directing water upward not only extinguishes the running fire but cools the steel, stopping expansion and significantly reducing the chance of collapse.

Basement Fires

When high heat and smoke exist at the floor level, firefighters should suspect a basement fire. Fires in basements expose the entire structure and complicate the successful application of water to the seat of the fire.

Basement areas are confined and offer little or no ventilation, so firefighters can expect heat conditions to be severe. Heat and gases have difficulty escaping, so personnel should not use fog in basement fire situations unless they are operating from a protected area outside the basement with no one operating inside.

If they exist, outside basement entrances are preferred over interior stairwells. If the basement entrance is located in the structure's rear, personnel should advance the handline from the engine company in the rear.

Personnel should consider using exterior streams and cellar nozzles if the fire is in the advanced stages.

In older buildings with taxpayers above the stores, the basement entrance is usually found in the structure's rear, directly below the stairway leading to upper floors (see Figure 29).

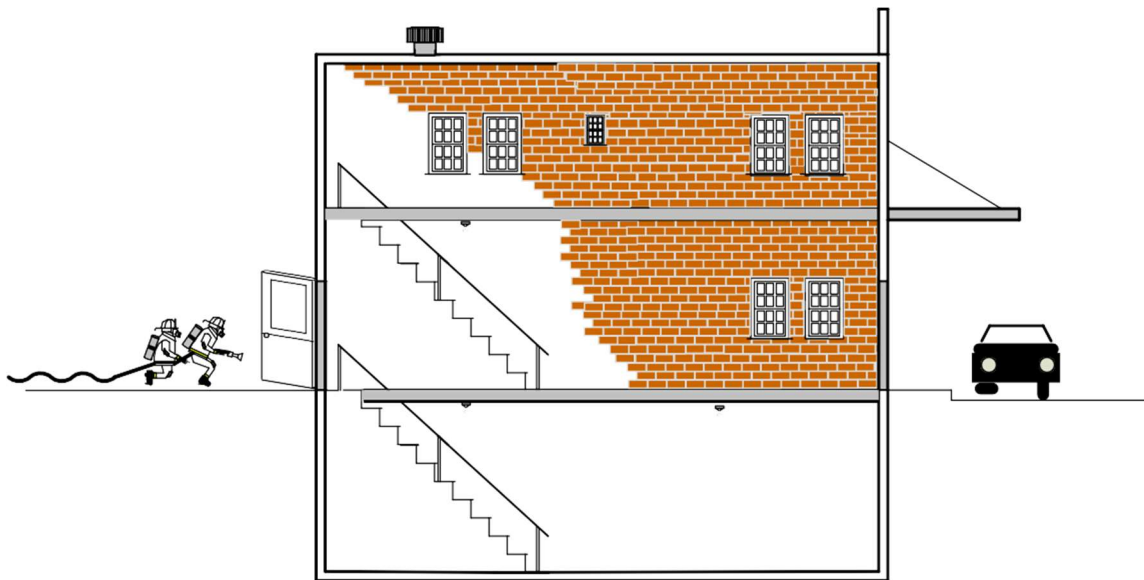

Figure 29. Basement stairway. Located below stairway leading to upper floors.

Operations in the Rear

Personnel should determine the number and size of deployed handlines by the flow required and mode of operation (i.e., offensive or defensive). Hoselines in the rear are typically used for rear attack, exposure protection, and roof operations.

As with any type of structure, an ongoing size-up should include a risk–benefit analysis that addresses structural stability, life hazards, and exposure protection.

If a fire scenario involves a taxpayer occupancy, personnel should adjust the normal strip shopping center tactics to prioritize the life hazards associated with commercial and residential occupancies.

RESOURCES FOR FIRES IN STRIP SHOPPING CENTERS

The minimum initial alarm assignment for a strip shopping center fire consists of the following:

- four engines,
- two trucks,
- one rescue,
- one emergency medical services (EMS) unit,
- two battalion chiefs,
- one command aide, and
- one EMS supervisor.

The unit assignments outlined in this document are based on common tasks performed in a logical order. Officers may need to adjust assignments according to an incident's specific challenges.

Unless otherwise directed by the IC, companies should position and report according to the following sections.

First Due Engine

The first due engine company's responsibilities are as follows:

- View as much of the structure as possible during approach.
- Communicate primary water supply report to the second due engine.
- Position to allow for rapid hoseline advancement while maintaining priority positioning for truck companies.
- Communicate an on-scene report to the first due command-level officer.
- Deploy initial hoseline and begin fire suppression operations in coordination with Command.

The first due engine officer must identify and verify the fire unit. If smoke conditions exist in multiple units, the officer must determine if fire is present in those units. The officer should also note if the structure has an odd configuration. Taking time to quickly gather this pertinent information will save time in the long run.

The first engine and all other engine companies should bring forcible entry tools if they arrive significantly before the first-arriving truck or rescue companies.

Second Due Engine

The second due engine company's responsibilities are as follows:

- Establish primary water supply to the first due engine.
- Identify and supply the building's FDC, if present. If multiple FDCs exist, charge all connections.
- Assist the first engine with initial hoseline, if needed.

- Prepare to deploy a second hoseline. This hoseline can be advanced into the fire unit as a second hoseline or directed to an exposure unit, depending on fire conditions.

Upon arrival, the second due engine driver should establish a water supply and stretch the supply hoseline to the FDC. The driver should charge the FDC when a company reports fire or visible smoke or if deemed appropriate by other considerations. All connections except test connections at the in-use FDC should be supplied. If FDCs exist at other locations on the building, Command must ensure they are also supplied.

Third Due Engine

The third due engine company's responsibilities are as follows:

- Establish side-Charlie water supply, and coordinate with the fourth due engine, if needed.
- Position at the rear of the structure, if possible.
- Report to Command via radio:
 - evident conditions on side Charlie;
 - the location, volume, and characteristics of any fire or smoke;
 - the presence of any persons in distress; and
 - the presence of a side-Charlie FDC.
- Supply the side-Charlie FDC.
- Deploy a side-Charlie hoseline.
- Coordinate suppression operations and hoseline advancement through rear entrances to the involved unit or into exposures with units operating on side Alpha.
- Support rescue and truck company operations as needed.
- Provide a roof-top hoseline as needed.

Fourth Due Engine

The fourth due engine company's responsibilities are as follows:

- Help the third due engine establish a side-Charlie water supply, if needed.
- Establish an initial RIT.

Large strip shopping centers may have limited exterior access points, if so, after a RIT group has been established, RIT group supervisors should consider positioning RIT resources at multiple remote locations on several sides of the structure.

First Due Truck

The first due truck company's responsibilities are as follows:

- Position in front of the involved stores to maximize aerial's scrub area for roof access and master stream deployment.
- Ground ladder deployment on side Alpha.
- Gain access or force entry to the involved unit and exposure units on side Alpha.
- Assist with advancing large-caliber hoseline, if needed.

- Search for victims prioritized by incident dynamics on side Alpha.
- Locate the fire, if needed.
- Control utilities.
- Perform ventilation operations.
- Establish scene lighting on side Alpha.

The first due truck officer should help the first due engine officer develop the initial size-up, determining a mode of operation and appropriate tactics. Truck company personnel should provide access to the involved occupancies for engine company hoseline advancement, utilizing forcible entry techniques, if necessary.

If the fire location is not readily apparent, the truck company should search for it while the engine crew stands by, ready to advance. At this point, the engine crew operates as the rescue team for the truck, if needed. Truck crews should strongly consider using a search rope in commercial occupancies with large open areas.

The truck crew should open the ceiling to expose the plenum area, if present, and check for fire before advancing their search. Crews should not advance under fire in the plenum area. It must be knocked down as the attack commences. Once the truck crew has located the fire and the engine company has advanced the hoseline, the truck crew should begin searching the rest of the area for victims.

Second Due Truck

The second due truck company's responsibilities are as follows:

- Position in the rear to maximize aerial's scrub area for roof access and master stream deployment.
- Ground ladder deployment on side Charlie with the primary goal of accessing the roof.
- Light the roof and rear area early.
- Provide roof conditions report to Command communicating:
 - location and characteristics of any fire or smoke,
 - roof status (i.e., intact, sagging, or failed),
 - roof loading (i.e., heating, ventilation, and air conditioning),
 - roof construction hazards (e.g., parapets, changes in rooflines, false fronts, firewalls),
 - thermal imaging heat signatures,
 - firewall locations, and
 - exposure concerns.
- Establish a roof-top hoseline as needed.

Due to the common presence of overhead electrical utilities behind strip shopping centers, personnel assigned to truck company operations in these areas should take great care to "clear overhead" and ensure that aerial and ground ladders do not contact electrical lines.

Rescue

The rescue company's responsibilities are as follows:

- Position in the rear, allowing access for the second due truck company.
- Gain access or force entry to the involved unit and exposure units on side Charlie.
- Assist with advancing large-caliber hoseline, if needed.
- Search for victims prioritized by incident dynamics on side Charlie.
- Locate the fire, if needed.
- Control utilities.
- Perform ventilation operations.

Depending on the number and type of handlines deployed, rescue personnel may assist in hoseline movement and operation. Specifically, the 2 ½" hoseline requires additional personnel to successfully deploy.

EMS Units

Transport personnel should not routinely be assigned suppression duties or non-EMS functions such as RIT. Transport units should park as close as possible to the incident, allowing for rapid care of any injured persons, emergent departures, and equipment access while providing a sheltered environment, if needed.

Transport personnel should not routinely don personal protective equipment (PPE) and self-contained breathing apparatus (SCBA) unless the IC deems them necessary for a suppression task. When a Mayday has occurred or people have been reported trapped or injured, EMS personnel should leave their PPE and SCBA on the unit and rapidly report to the incident scene with their EMS equipment.

OTHER CONSIDERATIONS

Forcible Entry

Personnel should reference the *NOVA Truck Company Book 2 – Forcible Entry* manual for information about various forcible entry techniques appropriate for strip shopping centers. Related information specific to fires in strip shopping centers appears in this section.

In strip shopping centers, the type of doors and locking mechanisms typically encountered on side Alpha differ from those encountered on side Charlie. Personnel should anticipate forcible entry operations to be more difficult and time-consuming on side Charlie due to heavily fortified doors and windows.

Plenum Space

Fires within plenum spaces can result in backdrafts. As crews advance inside a structure, they should remove drop-ceiling tiles with a hose stream or long pike pole to check the plenum space above their position for fire extension (see Figure 30). Personnel should use a thermal imaging camera to check the plenum space. Crews should continue this procedure as they advance into a structure. By doing so, personnel limit the chance of operating in an area with fire above or behind them, avoiding entrapment by a failed ceiling tile support grid.

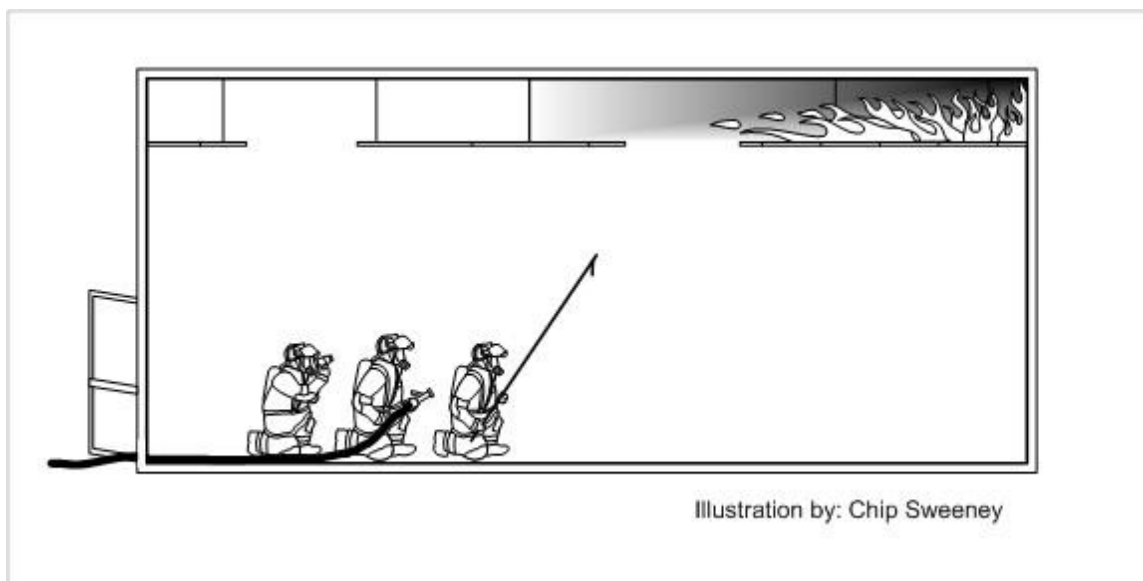

Figure 30. Crew removing ceiling tiles as they advance.

Ladder Deployment

Personnel should reference the *NOVA Truck Company Book 3 – Ladders* manual for information about various techniques appropriate for strip shopping centers. Related information specific to fires in strip shopping centers appears in this section.

Personnel should ladder the roof early to provide a ready route for crews to assess conditions

above the fire and carry out other assigned rooftop duties. Once crews are assigned to the roof, at least one additional means of escape must be provided. The ability to access a haven on the opposite side of a firewall is considered a secondary egress. Personnel should not use interior roof access from the fire unit before the fire is under control.

Fire conditions often limit egress from the second story and above. Personnel must ladder these areas to accomplish second-floor rescues and provide escape routes for crews operating above ground level.

Search and Rescue

Personnel should reference the *NOVA Truck Company Book 4 – Search and Rescue* manual for information about various techniques appropriate for strip shopping centers. Related information specific to fires in strip shopping centers appears in this section.

As in all occupancies, life safety poses the primary concern at strip shopping centers. Search ropes should be used by crews operating without a hoseline.

Personnel assigned to search operations should anticipate the possibility of encountering basements and second stories. If present, unit officers assigned to search operations should incorporate these areas in the search.

Units advancing into the structure must remain attuned to the stability of floor and roof or ceiling assemblies. Constant evaluation of these structural members, sometimes by another crew, is necessary to ensure a safe operation. This is particularly important as crews advance deeper into the structure.

Ventilation

Fire department personnel should manage the openings (i.e., doors, windows) to the structure to limit fire growth and spread and to control the flow path of inlet air and fire gases during tactical operations.

Members must coordinate all ventilation with suppression activities because uncontrolled ventilation allows additional oxygen into the structure. This can rapidly elevate heat release rates, expand the fire, and increase the hazards associated with it. A variety of actions (e.g., forcible entry) can facilitate ventilation, even when not intended. Personnel must force entry to access the seat of the fire, but without the proper water application, this form of ventilation can negatively affect life safety, incident stability, and property conservation.

Vertical Ventilation

Backdrafts can develop in any enclosed area, but when they occur in strip shopping centers, they tend to be catastrophic. If a tightly closed strip shopping center has a significant amount of dense smoke in its interior, ICs should consider vertically ventilating the roof to control a possible backdraft or flashover. Prior to initiating vertical ventilation through the rooftop, personnel should confirm the roof's stability.

When present on the involved structure's roof, skylights, scuttles, ventilators, and exhaust vents provide fast and efficient means of initiating vertical ventilation. By opening hatches, cutting through relatively thin duct material, or forcing entry, personnel can utilize these building features to create productive ventilation openings.

Once these features are opened, members should breach the interior sidewall area to access and ventilate the cockloft.

Vertical ventilation achieved by cutting and removing roof material takes more time. Personnel should identify the presence of a rain roof or built-up roofing material before initiating roof cuts as this information will influence the tactics used to ventilate the structure. Rooftop ventilation cuts on commercial structures typically require more than one unit to complete.

Built-up roofs are time-consuming and difficult to cut. Delayed ventilation of well-advanced fires with large amounts of storefront glass makes it more difficult and treacherous to reduce the potential for backdrafts. Before rooftop ventilation in well-advanced fires, advancing companies should delay entry, allow the fire to show itself, and relieve some of the heat and smoke.

When ICs order rooftop ventilation cuts, personnel assigned to perform this task should cut the roof as close as safely possible to the area above the seat of the fire. It is best to start with a small hole, about 2 ft by 2 ft, and then expand it. The weight of the roofing materials can make a larger hole difficult to open.

When ventilating a flat built-up roof, members should remove the roofing material in an area wider than the desired hole size. By clearing roofing material in a 5 ft by 5 ft area, personnel allow enough space to identify structural components and create a 4 ft by 4ft ventilation opening. Personnel should remember that roof decking is usually tack welded to the bar joists, so they may need a forcible entry bar to break the welds and remove the decking.

Personnel assigned to roof operations should be equipped to perform a trench cut. Factors such as available resources, building configuration, and fire volume can indicate the need for this tactic. Companies must remember that performing a trench cut in a timely and effective manner will require the services of several companies.

Poured concrete roofs are difficult to ventilate and require tools such as a circular saw with a masonry blade. The saw's cutting depth must be properly set to be effective. In some instances, personnel may need a jackhammer. Precast concrete over 4 in. thick is almost impossible to penetrate.

Fire Extension

In 1-level structures, horizontal fire extension represents the most significant concern after life hazard. Fire separations are not required between all occupancies, so fire may spread through unprotected areas such as ceiling spaces, facades, or breaches in walls.

Hood Systems

Occupancies with restaurants will include fans and ducts associated with food preparation. Personnel should secure cooking appliances and utilities, shut down ventilation fans, and open ductwork to check for fire extension. They should expect hot grease and oil in the restaurant.

Restaurant hood systems pose several unique problems related to fire extension. When the fire has entered a restaurant hood or duct system, personnel should take the following actions:

- Check for extension above the drop-ceiling.
- Remove power from the grease pit.
- Move the grease pit away from the area.
- Activate the hood system dry chemical extinguisher.

Personnel should not place hose stream into an overhead duct with hot grease under it because water can run down into the hot grease and create a violent steam boil over. The least damaging method of extinguishment involves the application of multiple CO₂ extinguishers into the duct. Personnel should not remove the rooftop ventilator until after completing this extinguishment method.

Alternatively, personnel can discharge several Class A, B, and C dry chemical extinguishers into the ductwork.

If the CO₂ or ABC dry chemical extinguishers fail to extinguish the fire, personnel should consider applying a hose stream directly into the duct from the roof after removing the vent. This method can cause significant water damage but has proved effective. Members must move the grease pit away from the ductwork before using this tactic.