

ROOF-AM



Torrino assiale ad anello - motore "UNEL-MEC" Ring axial roof fans - "IEC" motor

APPLICAZIONI

I torrini serie ROOF-AM sono destinati ad impieghi in cui necessitano grandi portate d'aria, in applicazioni a tetto, senza lunghe canalizzazioni. Ad esempio: ventilazione di edifici industriali (stabilimenti, magazzini), allevamenti, sala macchine, ecc.

GAMMA

La serie è costituita da 8 grandezze con diametro girante da 450 a 1000 mm.

PECULIARITÀ

La serie ROOF-AM è caratterizzata dalla presenza di imbrocchi ad ampio raggio di curvatura, sia all'ingresso che all'uscita dell'aria, i quali garantiscono massima silenziosità ed elevati rendimenti aerodinamici, inoltre essi consentono l'efficace utilizzo del torrino come estrattore o come immissore. Il motore è facilmente raggiungibile sia per effettuare il primo collegamento elettrico sia per esigenze di manutenzione. Il motore è costruito seguendo standard internazionali garantendo così affidabilità ed a lungo termine un economico recupero del ventilatore semplicemente riparando o sostituendo il motore stesso.

COSTRUZIONE

- Convogliatore ad anello con doppio bordo ad ampio raggio di curvatura e base d'ancoraggio in lamiera d'acciaio, protetta contro gli agenti atmosferici.
- Cappello in tecnopolimero resistente agli agenti atmosferici.
- Rete antivoltale ed antinfortunistica esterna, realizzata a norme UNI EN ISO 12499 in filo d'acciaio e protetta contro gli agenti atmosferici.
- Girante ad alto rendimento con pale a profilo alare, ad angolo di calettamento variabile da fermo in tecnopolimero e mozzo in fusione d'alluminio. Equilibratura secondo norme UNI ISO 1940.
- Motore elettrico asincrono a corrente alternata, protezione IP55, isolamento CI F, servizio S1, costruzione conforme alle specifiche norme IEC/EEC (UNEL-MEC).
- Esecuzione 5 o 4 (accoppiamento diretto con girante a sbalzo).

SPECIFICHE TECNICHE

ROOF-AM standard

- Aria convogliata: pulita o leggermente polverosa, non abrasiva.
- Temperatura aria convogliata: -20°C / +50°C
- Tensione d'alimentazione: versione trifase (T) 400V-3Ph
versione monofase (M) 230V-1Ph
- Frequenza: 50Hz.
- Funzionamento in estrazione.

ACCESSORI

- Serranda a gravità, solo in estrazione (GS-RO).
- Interruttore di servizio.
- Morsettiere esterna (OTB).
- Basi d'appoggio su coperture ondulate (SB).
- Silenziatore (SIL-RO).
- Controbase a murare (CB).
- Rete lato girante (PG) obbligatoria nell'utilizzo a bocca libera.
- Interruttore di servizio (SW).

A RICHIESTA

- Versioni senza rete porta motore.
- Versioni per funzionamento in immissione.
- Versioni con flusso dell'aria "effettivamente" reversibile (ROOF-REV).
- Versioni con motore elettrico a doppia polarità.
- Versioni con convogliatore e base in acciaio inossidabile o alluminio.
- Versioni ATEX (Roof-AM ATEX).
- Versioni con cappello in metallo.
- Versioni senza cappello.

APPLICATIONS

ROOF-AM line is designed to extract large volumes of air in roof installations, without long ducts. For instance: ventilation of industrial buildings (factories, warehouses etc.), stock farms and electrical equipments etc.

RANGE

This line consists of 8 sizes with impeller from 450 up to 1000 mm.

ADVANTAGES

This line is characterized by the wide round shaped nozzles in both inlet and outlet, warranty of reduced noise level and high efficiency. Besides these fans allow the effective operation either in exhaust or supply duty. Electric motor is easily accessible for wiring and maintenance operations, manufactured according to international standards assuring reliability and the long-term economic recovery of the unit simply repairing or replacing the motor itself.

CONSTRUCTION

- Ring casing with double wide round shaped nozzle, and base resistant to the atmospheric agents.
- Upper cover in techno-polymer resistant to the atmospheric agents.
- Protection grid on outlet side in steel rod, manufactured according to UNI EN ISO 12499.
- Impeller with high efficiency airfoil blades in plastic material and hub in die cast aluminum alloy. Variable pitch angle in still position. Balancing according to UNI ISO 1940
- Asynchronous electric motor, protection IP55, Class F insulated, service S1, construction according to IEC/EEC (UNEL-MEC) standard.
- Arrangement 5 or 4 (impeller directly coupled to motor shaft).

TECHNICAL SPECIFICATIONS

ROOF-AM standard

- Conveyed air: clean, not abrasive.
- Temperature of conveyed air: -20°C / +50°C.
- Voltage: three phase version (T) 400V-3Ph.
Single phase version (M) 230V-1Ph.
- Frequency: 50Hz.
- Working as exhaust fan.

ACCESSORIES

- Inlet gravity shutter, only for exhaust fans (GS-RO).
- Service switch.
- Outer terminal box (OTB).
- Support base for corrugate roof covering (SB).
- Silencer (SIL-RO).
- Counter base (CB).
- Inlet grid (PG) mandatory for use in free air.
- Service switch (SW).

ON REQUEST

- Versions without motor side grid.
- Intake versions.
- Versions with air flow 100% reversible (ROOF-REV).
- Versions with three phase double polarity electric motor.
- Versions with casing and base in stainless steel or aluminum.
- Explosion proof versions (Roof-AM ATEX)
- Versions with metal sheet cover.
- Versions without cap.

Le prestazioni indicate nei diagrammi si riferiscono ad aria alla temperatura di 15°C ed all'altitudine di 0 mt s.l.m., e sono state ottenute in installazioni di tipo "C" in assenza di reti e accessori. Performance shown in the selection diagrams refer to air at 15°C temperature and 0 mt a.s.l. altitude, and they were obtained in installation type "C" with no grid nor accessories.

4 poli/poles (1500 rpm) - monofase/mono-phase (1Ph-230V 50Hz)

Modello Model	Portata - Flow rate (m ³ /h)	Pm (kW)	In max (A)	Mot. (H)	Lp dB(A)
454 M	6.000	0,25	1,8	71	59
504 M	7.000	0,37	3,3	71	63

4 poli/poles (1500 rpm) - trifase/three-phase (3Ph-400V 50Hz)

Modello Model	Portata - Flow rate (m ³ /h)	Pm (kW)	In max (A)	Mot. (H)	Lp dB(A)
454 T	6.000	0,25	0,8	71	59
504 T	7.500	0,55	1,6	80	63
564 T	10.500	0,75	2	80	66
634 T	13.000	1,1	2,8	90S	70

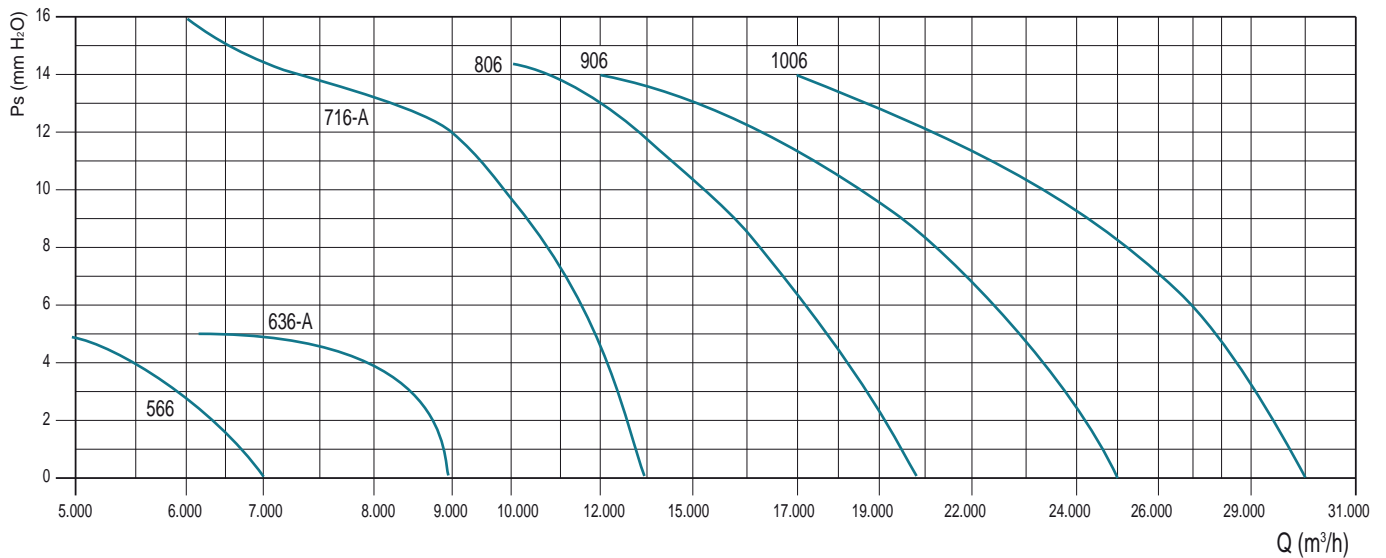
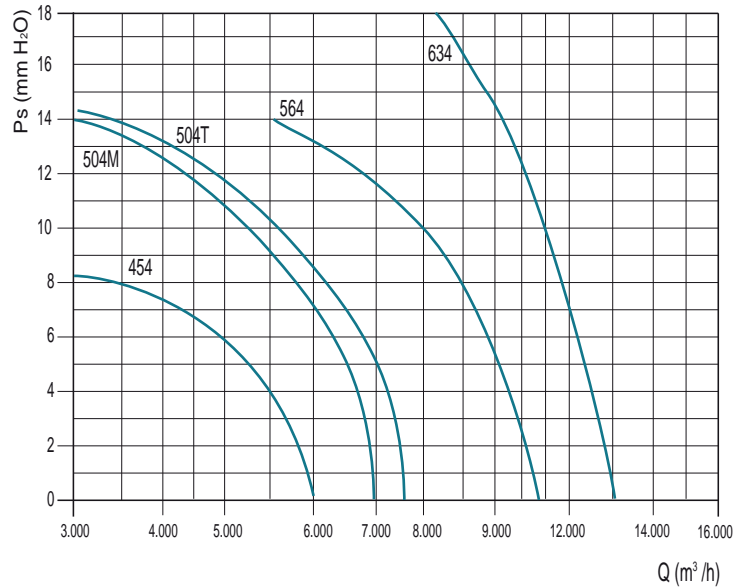

6 poli/poles (1000 rpm) - trifase/three-phase (3Ph-400V 50Hz)

Modello Model	Portata - Flow rate (m ³ /h)	Pm (kW)	In max (A)	Mot. (H)	Lp dB(A)
566 T	6.900	0,25	1	71	56
636A T	9.000	0,37	1,3	80	60
716A T	13.500	0,75	2,2	90	61
806 T	20.000	1,5	4	100	62
906 T	25.000	1,5	4	100	69
1006 T	30.000	2,2	5	112	72

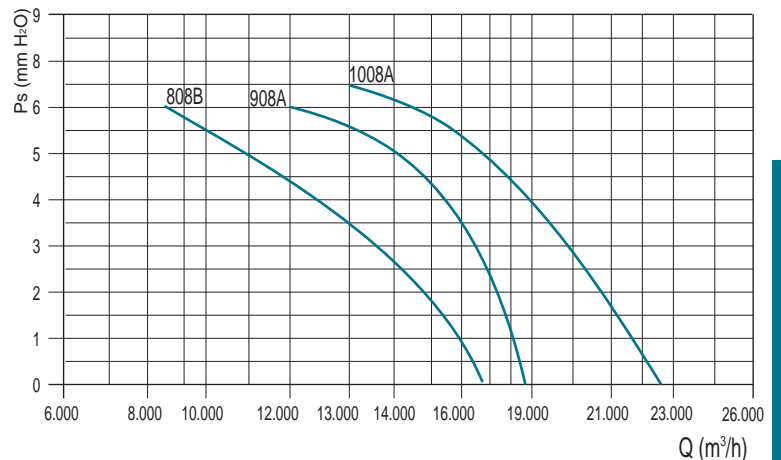

8 poli/poles (750 rpm) - trifase/three-phase (3Ph-400V 50Hz)

Modello Model	Portata - Flow rate (m ³ /h)	Pm (kW)	In max (A)	Mot. (H)	Lp dB(A)
808B T*	16.500	0,75	2,3	100	57
908A T	18.800	0,75	2,3	100	63
1008A T	22.500	1,1	3,4	100	68

In caso di installazione in UE utilizzare solo per estrazioni in ambienti NON occupati esclusivamente da persone (ad es.: cucine professionali, applicazioni industriali ed agricole, macchinari, data center, ecc.)

In case of EU installation use only for air changes in environments NOT solely occupied by persons (for example: professional kitchens, industrial and agricultural applications, machinery ventilation, OEM, data centers,...)

* Solo per installazione extra U.E. - * Only for non-Europeans market

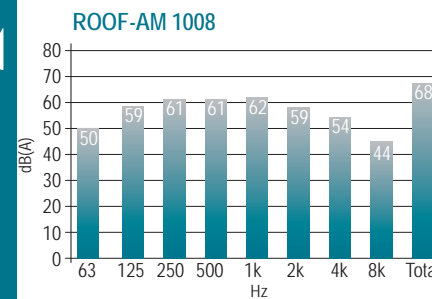
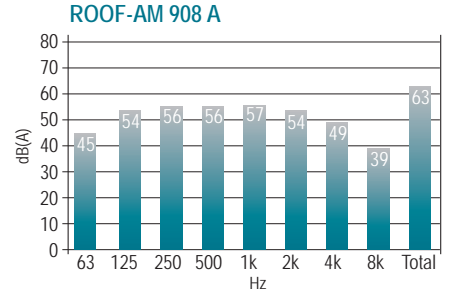
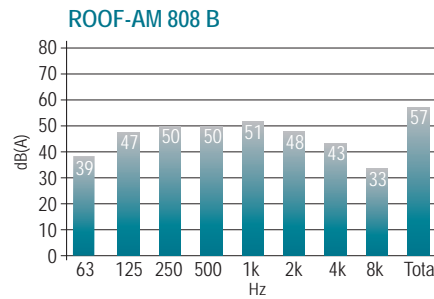
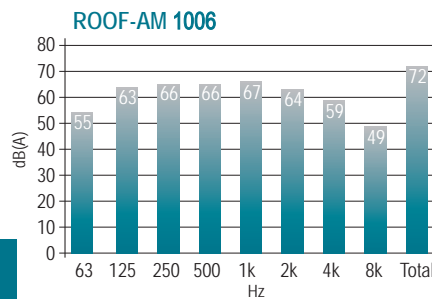
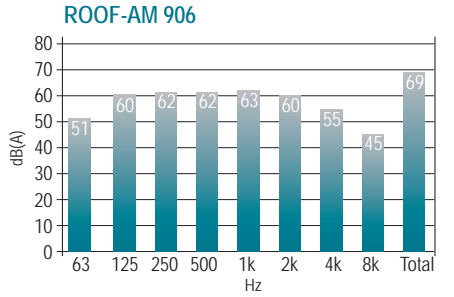
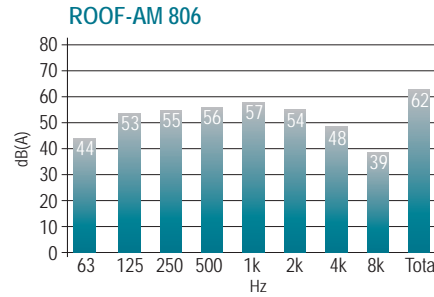
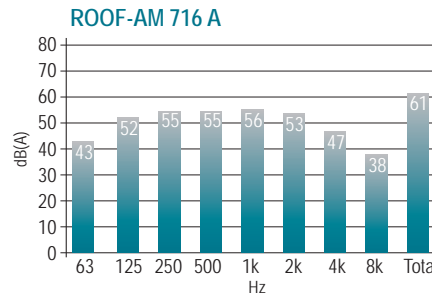
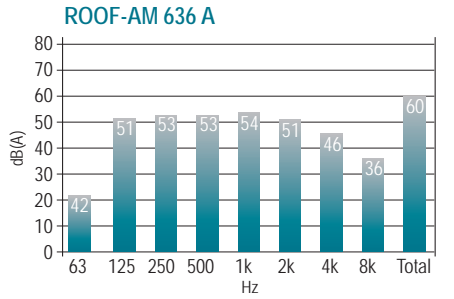
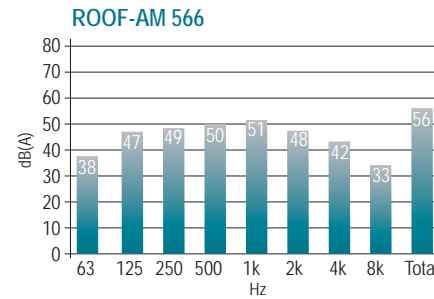
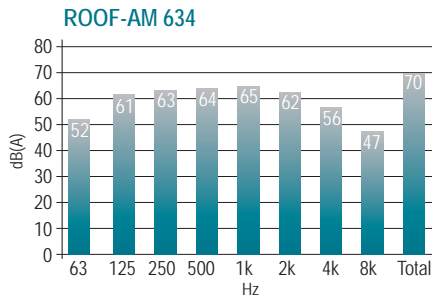
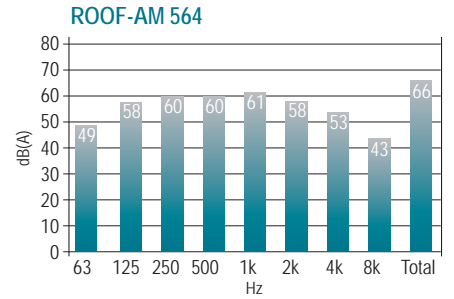
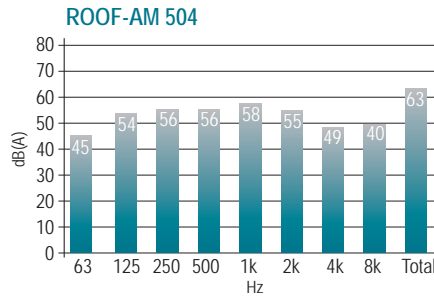
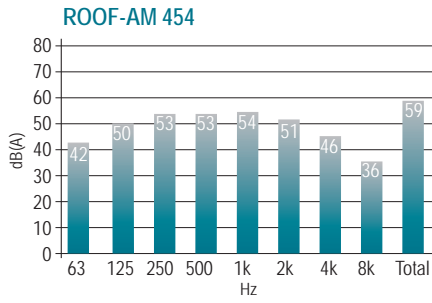

Queste unità di ventilazione, secondo il Regolamento UE 1253/2014, devono essere azionate tramite inverter.

All this ventilation units, according to EU Rule 1253/14, must be equipped with inverter.

Attenzione: il livello di pressione sonora è riferito ad una misurazione onnidirezionale in campo libero a 6 m dal ventilatore con aspirazione canalizzata e mandata libera.

Attention: sound pressure level is measured in free field at 6 m from the fan, in any direction, with ducted inlet and free outlet.

Model	ØA	BxB	CxC	ØD	E	ØF	kg*
45	460	650	600	1000	450	10	30
50	510	760	710	1000	450	10	38
56	570	760	710	1000	450	10	42
63	640	930	870	1200	500	10	58
71	710	930	870	1200	500	10	67
80	815	1150	1050	1600	650	12	85
90	915	1300	1200	1600	650	12	110
100	1015	1300	1200	1600	700	12	140

Dimensioni in mm/Dimensions in mm
(* Indicativo/Indicative)

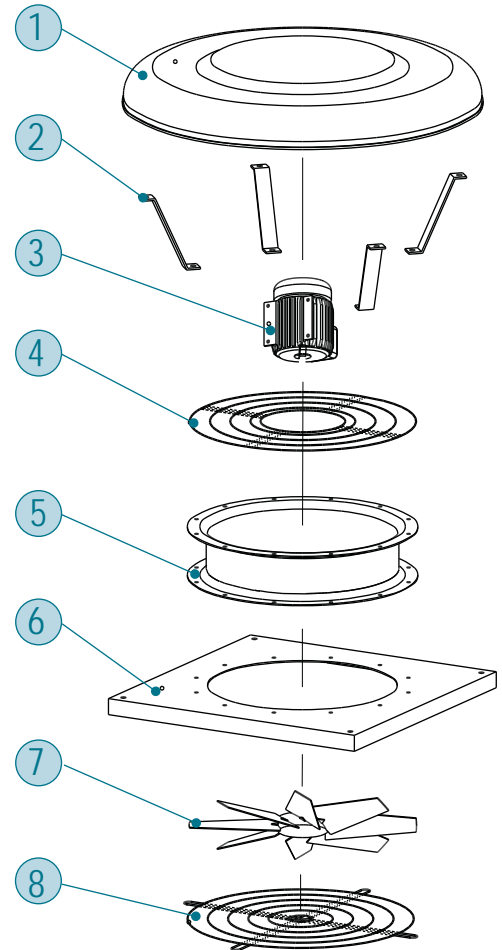
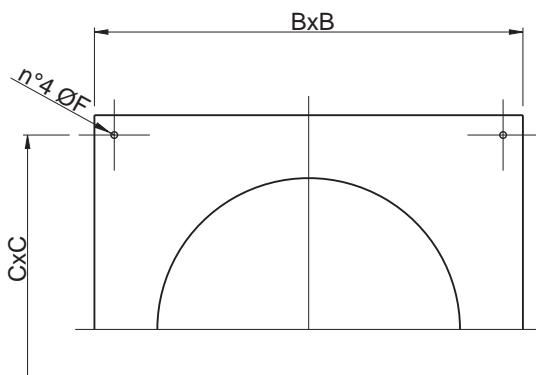
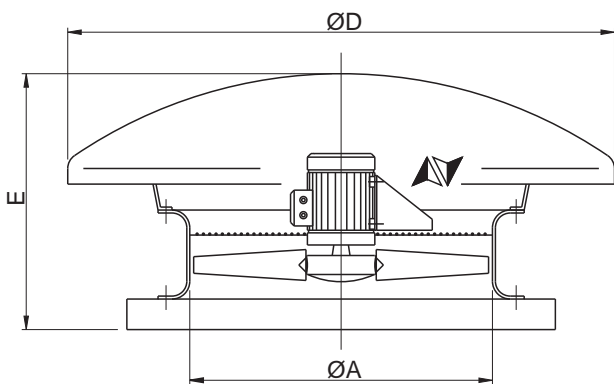

- 1 - Cappello/Cover
- 2 - Staffe/Brackets
- 3 - Motore/Motor
- 4 - Rete/Grid
- 5 - Convogliatore/Ring casing
- 6 - Base/Base frame
- 7 - Girante/Impeller
- 8 - Rete (accessorio) obbligatorio per l'utilizzo a bocca libera
Grid (accessory) mandatory for free air

SERRANDE A GRAVITÀ (GS-RO)

Le alette della serranda di gravità si aprono con il movimento dell'aria a ventilatore acceso e si richiudono per gravità al suo spegnimento evitando dispersioni di calore.

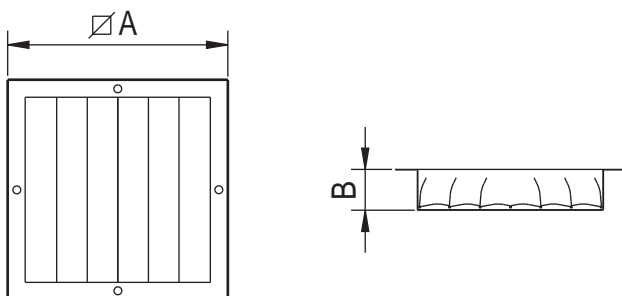

GRAVITY SHUTTERS (GS-RO)

Blades of the shutter are opened by the airflow when the fan is operating and they shut by gravity when the fan stops, thus avoiding heat waste.

Model	A	B	kg*
GS-RO 45	580	150	6
GS-RO 50-56	690	150	9
GS-RO 63-71	825	150	10
GS-RO 80	990	150	13
GS-RO 90-100	1160	150	15

Dimensioni in mm/Dimensions in mm
(* Indicativo/Indicative)

ROOF-AM

Accessori

Accessories

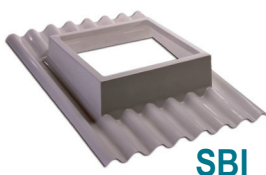

SBI



SBc

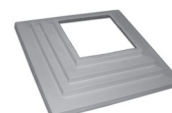

SBr

SB

Basi d'appoggio ondulate per torrini/Support bases for roof fans

APPLICAZIONI

Le basi d'appoggio ondulate **SB** (converse) realizzate in robusta vetroresina, sono adatte per l'installazione dei nostri torrini su coperture costruite in lastre ondulate, evitando dannosi ristagni d'acqua attorno al ventilatore e costose opere murarie o di carpenteria.

APPLICATIONS

The support bases **SB** (valleys), manufactured in sturdy glass-resin, are suitable for the installation of our roof fans on overlays built in corrugated slabs, avoiding detrimental stagnations of water nearby the fan and costly masonry or carpentry works.

VERSIONI

SBI e SBc: utilizzabile con torrini aventi basamento 930x930 mm (Modelli 63 e 71).

VERSIONS

SBI e SBc: to be used with roof fans having bases 930x930 mm (Models 63 and 71)

SBr: riduzione da accoppiare con basi **SBI** e **SBc** per installazioni torrini aventi basamento 760x760 mm (Modelli 50 e 56).

SBr: Adaptor to be coupled with soaker bases SBI and SBc for installation of roof fans having base 760x760 (Models 50, 56).

Le versioni **SB** possono essere accoppiate a lastre ondulate con pendenza falda tipo:

- **SBI/1 10x146**: internazionale (passo 146 mm altezza 48 mm)
- **SBI/2 10x177**: "Euro" (passo 177 mm altezza 51 mm mod.)
- **SBc**: "Euro" (passo 177 mm altezza 51 mm e raggio di curvatura lastra pari a 3 metri).

Both versions **SBI** and **SBc** are suitable to be coupled to corrugated slabs with pitch slope type:

- **SBI/1 10x146**: International type (pitch 146 mm height 48 mm)
- **SBI/2 10x177**: "Euro" type (pitch 177 mm height 51 mm)
- **SBc**: "Euro" type (pitch 177 mm height 51 mm) and radius of curvature of the sheet of 3 meters.

INSTALLAZIONE

Sovrapporre la conversa alla lastra a valle e sottoposizionarla a monte. Sovrapporsi di almeno un'onda e un quarto con le lastre laterali attigue. Verificare di non avere sovraccaricato eccessivamente la conversa.

INSTALLATION

Overlap the valley to the slab downstream and under-place it upstream. Overlap not less than one and fourth wave with the lateral adjacent slabs. Verify not to have excessively overloaded the valley

SBI

SBc

SBr

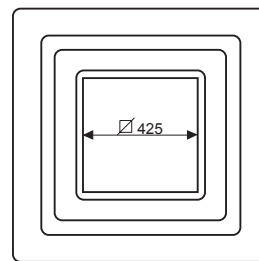
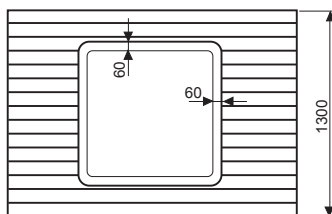
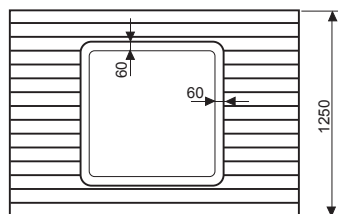
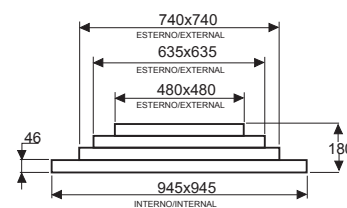
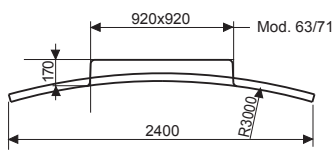
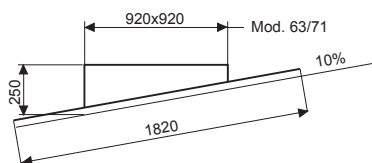

SBI/1 10x146

SBI/2 10x177

SBc

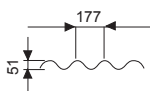
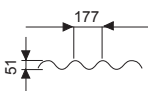
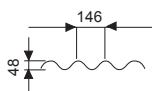

SBI - SBc per/for mod. 63-71

SBI - SBc con/with SBr per/for mod. 50-56

