

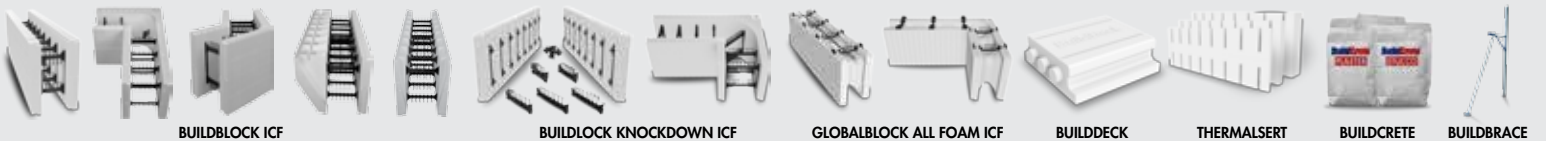

BUILDBLOCK BUILDING SYSTEMS ICF INSTALLATION & TECHNICAL MANUAL REVISED FALL 2015



BUILDBLOCK TECHNICAL & INSTALLATION MANUAL

Table of Contents

BUILDBLOCK BUILDING SYSTEMS INSTALLATION MANUAL	I
Introduction	I
<i>Product Warnings</i>	<i>I</i>
<i>Trademarks</i>	<i>I</i>
<i>Acknowledgments</i>	<i>I</i>
Limited Product Warranty	II
Manufacturer Construction and Engineering Statement	III
SECTION 1: BUILDBLOCK ICF PRODUCTS	1
1.1 BuildBlock Insulating Concrete Forms	1
1.2 BuildLock Knockdown Insulating Concrete Forms	4
<i>Knockdown Block Overview</i>	<i>4</i>
<i>Knockdown Block Assembly</i>	<i>4</i>
<i>BuildLock Knockdown Components</i>	<i>8</i>
1.3 Product Specifications (Imperial)	9
1.4 Product Specifications (Metric)	13
1.5 Product Technical Details	17
<i>ASTM Standards Product Testing</i>	<i>17</i>
1.6 Transportation, Handling, and Storage of BuildBlock ICF Forms and Products	18
<i>Transporting BuildBlock ICFs</i>	<i>18</i>
<i>Unloading ICF forms</i>	<i>18</i>
<i>Handling BuildBlock Forms</i>	<i>18</i>
<i>Storing ICF Forms</i>	<i>19</i>
SECTION 2: TOOLS AND ACCESSORIES	21
2.1 Recommended Tools & Accessories	21
<i>7" or 10" Folding Pruning Saw</i>	<i>21</i>
<i>Bracing / Wall Alignment Systems</i>	<i>21</i>
<i>Foam Guns, Foam Adhesive, and Cleaner</i>	<i>21</i>
<i>Carpenters 12"-18" Sharktooth Saw</i>	<i>21</i>
<i>Hot Knives and Accessories</i>	<i>22</i>
<i>Super Groover Kit</i>	<i>22</i>
<i>BN Products BNCE-20 Rebar Cutter</i>	<i>22</i>
<i>Form A Drain</i>	<i>22</i>
<i>Duplex Screws</i>	<i>22</i>
<i>Waterproofing</i>	<i>23</i>
<i>Fast Foot</i>	<i>23</i>
<i>Door and Window Bucking</i>	<i>23</i>
<i>Radiant Flooring Panels</i>	<i>24</i>
<i>RAZ Panel™ from EZ Floor</i>	<i>24</i>
<i>CREATHERM Radiant Floor Panels</i>	<i>24</i>

BUILDBLOCK TECHNICAL & INSTALLATION MANUAL

SECTION 3: ESTIMATING	25
3.1 How to Estimate Blocks for Your Project.....	25
<i>Square Foot Method</i>	<i>25</i>
<i>Square Foot Method (alternate)</i>	<i>25</i>
<i>Linear Foot Method.....</i>	<i>25</i>
<i>BuildBlock Estimating Tool</i>	<i>26</i>
3.2 Estimating Bucking Materials	26
3.3 Estimating Concrete Volume.....	26
<i>Rebar Grade.....</i>	<i>27</i>
<i>Imperial Rebar Sizes.....</i>	<i>27</i>
<i>Metric Rebar Sizes.....</i>	<i>28</i>
3.5 Estimating Rebar	28
<i>Lap Splices.....</i>	<i>28</i>
<i>Basic Rebar Estimation Formula</i>	<i>28</i>
<i>Horizontal Rebar Formula</i>	<i>28</i>
<i>Vertical Rebar Formula.....</i>	<i>29</i>
<i>Lintel Formula.....</i>	<i>29</i>
SECTION 4: FOOTINGS	31
4.1 Footing Layout	31
<i>Pythagorean Theorem (3-4-5 Method).....</i>	<i>31</i>
<i>Diagonal Squaring</i>	<i>32</i>
4.2 Excavation & Footings	33
<i>Building Footings To Applicable Codes.....</i>	<i>33</i>
<i>Concrete Footing considerations for ICF Walls</i>	<i>34</i>
<i>BuildBlock Suggested Minimum Concrete Footings for ICF Walls.....</i>	<i>34</i>
<i>Prescriptive Code Minimum Concrete Footings for ICF Walls</i>	<i>35</i>
<i>Step Footings</i>	<i>36</i>
4.3 First Course Placement.....	37
<i>Dry-Set or "Glue Down" Method</i>	<i>37</i>
<i>Wet-Set Method</i>	<i>37</i>
<i>Stem Reinforcing Rebar.....</i>	<i>38</i>
<i>Rebar Footing Dowel/Pin Placement</i>	<i>38</i>
4.4 Pouring Footings	39
4.5 Dry-Set Step By Step	39
<i>Dry-Set Tips</i>	<i>41</i>
<i>Bracing and Alignment System Setup</i>	<i>41</i>
4.6 Wet-Set Prep.....	42
<i>Wet-Set — Step by Step.....</i>	<i>42</i>
<i>Wet-Set Tips.....</i>	<i>43</i>
SECTION 5: ABOVE-GRADE WALL PLACEMENT	45
5.1 Placing BuildBlock Walls.....	45
<i>Interlocking Blocks</i>	<i>45</i>
<i>Stack Joints</i>	<i>45</i>
<i>How To Begin.....</i>	<i>45</i>
<i>Minimizing Waste</i>	<i>45</i>
<i>Cutting Blocks.....</i>	<i>45</i>
<i>Maintaining Level, Plumb, and Square</i>	<i>45</i>
<i>Placing Rebar.....</i>	<i>46</i>
<i>Gaps & Openings</i>	<i>46</i>

BUILDBLOCK TECHNICAL & INSTALLATION MANUAL

<i>Additional Courses</i>	46
<i>Distributing Block</i>	46
<i>The Top Course</i>	46
5.2 Concrete Reinforcement	46
5.3 Rebar Reinforcement	47
5.4 Rebar Placement	48
5.5 Intersecting Walls	48
<i>Intersecting Wall Notes</i>	49
5.6 Radius Walls	51
<i>Method 1: Radius Jig</i>	51
<i>Method 2: Compass</i>	51
<i>Highlights</i>	51
5.7 Radius Wall Chart	52
5.8 Second Story Walls And Above	54
<i>Second Story Construction Examples</i>	54
5.9 Transitioning Block sizes	55
5.10 second Floor/Joist Hanger Options	56
<i>About Joist Hangers</i>	56
<i>Joist Hanger Options</i>	56
5.11 Beam Pockets	57
<i>Creating Beam Pockets</i>	57
5.12 End Walls, Bulkheads And Retaining Walls	57
<i>Overview & Considerations</i>	57
5.13 Gable Walls	58
<i>Gable Construction Option 1</i>	58
<i>Gable Construction Option 2</i>	58
5.14 Anchor Bolts	59
<i>Tips for placing anchor bolts:</i>	59
<i>Bearing Points in ICF walls</i>	59
SECTION 6: BASEMENT WALL PLACEMENT	61
6.1 Foundation Drainage	61
<i>Form-a-Drain</i>	61
6.2 Stacking Basement Walls	62
6.3 Basement Wall Brick Ledges	63
<i>Brick Ledge Installation</i>	63
<i>Mechanical Brick tie Options</i>	64
<i>Brick Ledge Using Steel Angle</i>	64
6.4 Basement Wall Waterproofing	65
<i>Waterproofing Options:</i>	65
<i>Other Pier Options</i>	67
6.5 Termite Protection for Below-Grade Applications	68
<i>Termite Prevention Strategies</i>	68
SECTION 7: SERVICE & UTILITY PENETRATIONS	69
7.1 Installing Utility Access	69
<i>Common Penetration Types</i>	69
<i>Service Sleeves</i>	69
<i>Creating ICF Wall Penetrations:</i>	69

BUILDBLOCK TECHNICAL & INSTALLATION MANUAL

SECTION 8: WINDOWS AND DOORS	71
8.1 Window And Door Bucking Options	71
<i>Treated Wood</i>	71
<i>Metal Bucking Systems</i>	71
<i>Vinyl Bucking Systems</i>	72
<i>ICF Foam Bucking</i>	72
8.2 Buck Construction	72
<i>Door Buck Construction</i>	72
<i>Window Buck Construction</i>	73
8.3 Door Placement	73
8.4 Window Placement	74
8.5 Arched Windows And Bucks	75
<i>Vbuck</i>	75
<i>Treated WOOD Bucking</i>	75
<i>Bucking Construction Highlights</i>	75
SECTION 9: BRACING & ALIGNMENT SYSTEMS	77
9.1 Bracing Options	77
<i>Safety</i>	77
<i>Improvised Bracing</i>	77
<i>Professional Bracing Systems</i>	77
<i>Build1 All-in-One Folding ICF Bracing System</i>	78
<i>Build3 3-Piece ICF Bracing System</i>	78
<i>24 Foot Adaptor Kit</i>	78
9.2 Bracing Methods	79
<i>Inside Bracing</i>	79
<i>Outside Bracing</i>	79
9.3 Bracing Techniques	79
9.4 Below Grade Bracing	79
9.5 Bracing recommendations	81
9.6 Bracing Examples	81
9.7 Problems during the pour	82
<i>About Concrete Pressure</i>	82
SECTION 10: CONCRETE PLACEMENT	83
10.1 Pre-Pour Checklist	83
10.2 About Concrete Mixes	85
<i>Typical 3000 PSI 3/8" Chip Mix Design</i>	85
10.2 Pouring	85
<i>Concrete Slump</i>	85
<i>Concrete Consolidation</i>	86
<i>Pouring notes</i>	86
10.3 Concrete Delivery Systems	87
<i>Boom Pumps</i>	87
<i>Hose Type</i>	87
<i>Trailer Pumps</i>	87
<i>Truck Chute</i>	87
<i>Bucket System</i>	87
<i>The Importance of a Reducer System</i>	88
10.4 Placing Concrete	88
10.5 Consolidating Concrete	88
10.6 Topping Off Your Project	89

BUILDBLOCK TECHNICAL & INSTALLATION MANUAL

SECTION 11: FINISHING ICF WALLS	91
11.1 About Interior Walls	91
<i>Creating Utility Chases.....</i>	<i>92</i>
<i>Electrical.....</i>	<i>92</i>
<i>Plumbing</i>	<i>93</i>
11.2 Above Grade Exterior Finish Mechanical Attachment.....	93
11.3 Veneers And Coatings	94
<i>Finishing Products.....</i>	<i>94</i>
<i>BuildCrete Stucco.....</i>	<i>94</i>
<i>BuildCrete Plaster</i>	<i>95</i>
<i>Other Finishing Products</i>	<i>95</i>
11.4 Interior Finish Mechanical Attachments.....	96
11.5 Attic and Crawl Space Installations	96
11.6 Vapor Barriers (Retarders) and Air Barriers	96
<i>Vapor Barriers and Water Resistive Barriers on Above-Grade Applications.....</i>	<i>97</i>
RECOMMENDED PRODUCTS	99
Bracing / Support Systems	99
Bucking (Window and Door Openings)	99
Decking & Roofing System.....	99
Footings.....	99
ICF Connectors	99
Radiant Flooring	99
Tools & Accessories	100
Waterproofing	100
Finishes - Interior & Exterior Walls	100
Floor Systems.....	100
Footings.....	100
Home Plans & Design Services.....	101
Insulation.....	101
Moulding.....	101
Termite Protection.....	101
Windows and Doors	101
Waterproofing & Vapor Barriers	101

BUILDBLOCK TECHNICAL & INSTALLATION MANUAL

This page left intentionally blank.

BUILDBLOCK TECHNICAL & INSTALLATION MANUAL

BUILDBLOCK BUILDING SYSTEMS INSTALLATION MANUAL

INTRODUCTION

This version of the installation manual was published on June 30, 2015. Changes to this document, however, may occur without notice and users should contact BuildBlock Building Systems LLC, for the most current printed or downloadable version at www.buildblock.com. It is the purchaser's and/or contractor's responsibility to always use the most current and up-to-date version of the installation manual when installing BuildBlock forms and/or products.

This manual was designed to be used as a reference guide only. This manual is not intended to be used as a replacement or substitute for the actual training by an experienced and properly trained BuildBlock building professional. Before starting any project BuildBlock recommends that you receive proper training. BuildBlock also recommends that you consult with design professionals familiar with the type and scope of project to be built. Training is available by contacting BuildBlock Building Systems LLC at www.buildblock.com or 866-222-2575.

BuildBlock Building Systems, LLC, believes the information contained herein to be accurate at the time of writing and preparation. The information has been compiled using sources believed to be reliable. Neither BuildBlock Building Systems, LLC, nor its employees or representatives make any representation or warranty, either expressed or implied, whether arising by statute, operation of law, custom of trade or otherwise, with respect to the accuracy or completeness of information contained in this document or its fitness for any particular purpose, nor do they assume any liability for damages or injury resulting from the application of such information.

BuildBlock Building Systems, LLC, assumes no responsibility regarding the use of its products or any other third party products referred to in this document. It is the full responsibility of the user to comply with all applicable regulations and building code requirements concerning the use of these products and any other products outlined in this product manual. It is further the responsibility of the user to research and understand safe methods of use and handling of these products. To properly comply with the building codes in your area, contact your local distributor, dealer, or building code inspector.

PRODUCT WARNINGS

Many new types of treated wood products using ACQ (alkaline copper quaternary) are highly corrosive to metal components. BuildBlock Building Systems LLC recommends that any metal products or components should not be used in contact with these treated lumber products unless you ensure the compatibility of your treated lumber with the metal components. Please consult with your project engineer to specify the type and sizing of all corrosion resistant metal connectors, anchor bolts, fasteners

or other metal components. Please note that metal connectors, anchor bolts, fasteners or other metal components will corrode and lose their load carrying capacity, if installed in corrosive environments.

TRADEMARKS

BuildBlock or BB BuildBlock, BuildLock, GlobalBlock, ThermalSert, BuildClip, BuildBrace, BuildDeck, BuildBlock Hardwall, and any other drawings, symbols, or marks identifying products and/or services of BuildBlock Building Systems LLC are registered trademarks of BuildBlock Building Systems LLC. All other trademarks drawings, symbols or marks are the property of their respective owners.

ACKNOWLEDGMENTS

The original BuildBlock Installation Manual was created by Mike Garrett, Michael Summers, RepPro Services, for BuildBlock Building Systems LLC.

Technical Writers: Michael Summers, Mike Garrett, Brian Corder, Mark Kerfoot, Dennis Micoff.

Technical Drawings: Brian Corder, Mark Kerfoot, Dennis Micoff.

BUILDBLOCK TECHNICAL & INSTALLATION MANUAL**LIMITED PRODUCT WARRANTY**

BuildBlock Insulating Concrete Forms are warranted for 180 days from the invoice shipping date only to the original purchaser and or the purchaser of forms from a BuildBlock approved Distributor or Dealer. All forms are warranted to be free from defects in material and workmanship which may cause the BuildBlock Forms to be unusable or not perform as the manufacturer's design intention for use as a form for poured concrete walls.

This warranty is effective and enforceable only if the BuildBlock Forms are handled, stored, transported and installed in accordance with the BuildBlock Installation Manual, or any other installation instructions or guidelines published by BuildBlock Building Systems, LLC, and local building codes. Furthermore this warranty is effective only if BuildBlock Building Systems, LLC has received written notice of the defects along with proof of purchase from a warranted source (as stated above) within 30 days of the first discovery of a defect but in any event no later than within 180 days of the date of shipment of said forms by BuildBlock Building Systems, LLC. NOTE: After 180 days from invoice shipping date, all forms are out of the warranty period.

THIS WARRANTY EXPRESSLY EXCLUDES AND IS IN LIEU OF ALL OTHER WARRANTIES WHETHER WRITTEN OR ORAL. EXCEPT AS EXPRESSLY SET FORTH ABOVE, BUILDBLOCK BUILDING SYSTEMS, LLC MAKES NO REPRESENTATIONS OR WARRANTIES OF ANY KIND, EXPRESS OR IMPLIED, IN FACT OR IN LAW, INCLUDING, WITHOUT LIMITATION, THE WARRANTY OF MERCHANTABILITY OR WARRANTY OF FITNESS FOR A PARTICULAR PURPOSE.

BuildBlock Building Systems, LLC's liability and the purchaser's sole and exclusive remedy from alleged defects in the materials or manufacturing of the BuildBlock Forms shall be limited to the replacement of an equivalent amount of the defective product or a refund of the invoice charged for the defective product less shipping and handling charges (as BuildBlock Building Systems, LLC may elect) if full payment has been made. In no event shall BuildBlock Building Systems, LLC be liable for any consequential or incidental damages, losses, costs, or expenses of any person of any kind (including without limitation, loss of profits or injury to credit, reputation, or goodwill) directly or indirectly resulting from any alleged breach of warranty contained in this Manufacturer's Limited Warranty.

No other entity, person, Corporation, Company, or firm has any authorization or authority to bind or assume on behalf of BuildBlock Building Systems, LLC any other liability affirmation, representation, or warranty regarding or in connection with the sale of BuildBlock's Insulating Concrete Forms except as stated in this Manufacturer's Limited Warranty.

No further warranty is expressed or implied that is not mentioned in the above text. This is the complete and full warranty of BuildBlock Building Systems LLC for its Insulating Concrete Forms for Concrete.

Dated: January 21, 2007

BUILDBLOCK TECHNICAL & INSTALLATION MANUAL

MANUFACTURER CONSTRUCTION AND ENGINEERING STATEMENT

BuildBlock Building Systems is a manufacturer of Insulating Concrete Forms, (ICFs) and related products. BuildBlock Building Systems provides engineering for informational purposes only. The BuildBlock Installation Manual and other technical documents are based on the following resources:

1. Prescriptive Design of Exterior Concrete Walls for One- and Two-Family Dwellings, PCA-100, Portland Cement Association. The PCA 100 is a consensus standard that was developed by the PCA's National Standards Development Committee which operates under PCA's American National Standards Institute (ANSI) approved "Procedures for the Development and Maintenance of Portland Cement Association Standards". The consensus process of PCA for promulgating standards is accredited by American National Standards Institute (ANSI).
 - a. The PCA 100 was adopted by the International Code Council 2009 & 2012 International Residential Code (IRC) in Sections R403, R404, and R611.
2. Prescriptive method for Insulating Concrete Forms in Residential Construction, US Department of Housing and Urban Development

The Prescriptive Method and PCA-100 are based on engineering calculations from:

1. ACI-318 Slender Wall Design, American Concrete Institute

These are the primary engineering documents that we recommend for use in residential construction design. All site specific engineering must be performed by a licensed engineer in the state where the project will be constructed. Site specific engineering supersedes the engineering found in the previous documents, as it relates directly to the specific project. The BuildBlock Installation Manual, technical resources, Prescriptive Code, PCA-100, and ACI-318 are a general set of guidelines for a range of applications.

BuildBlock Building Systems provides the Prescriptive method for Insulating Concrete Forms in Residential Construction, US Department of Housing and Urban Development document as a reference, subject to the limitations therein. BuildBlock forms are simply concrete forms and only affect the engineering of a wall by adjusting the concrete core width and spacing of reinforcement within the wall. The installation manual and the tables provided within that document are for reference only and do not reflect a minimum requirement, but rather a recommendation based on experience.

The tables shown in the Prescriptive Manuals also illustrate a safe design to cover many different situations and allow for homes to be built without consulting a structural engineer each time. These design guidelines have limitations. Home designs that exceed these limitations must have an engineering stamp. Retaining the services of a structural engineer for a specific project provides the most accurate information as it is based on the local conditions at the site. A structural engineer's

guidelines will always be the final specification for any construction project.

Commercial projects should always have site specific engineering completed. There is no Prescriptive Method that covers commercial work under the International Code Council (ICC) International Building Code (IBC). BuildBlock Building Systems can provide insights into the layouts to assist engineers in their design, but cannot provide actual calculations.

The BuildBlock Install Manual is provided to explain the installation of ICFs. Due to variance among soil types in different locations the suggestions and charts in the manual are for general information only. They will result in a well-built home in most instances. Due to the wide range of areas that can be covered with the information contained in the BuildBlock Installation Manual, some homes may be over-built depending on the stability of the local soils. Adjustments have not been made for seismic or high wind load areas and homebuilders, engineers and architects should refer to the Prescriptive Method or actual calculations to design for these areas.

BUILDBLOCK TECHNICAL & INSTALLATION MANUAL

This page left intentionally blank.

BUILDBLOCK TECHNICAL & INSTALLATION MANUAL



SECTION 1: BUILDBLOCK ICF PRODUCTS

1.1 BUILDBLOCK INSULATING CONCRETE FORMS

BuildBlock ICF forms combine the standard features you've come to expect in a quality ICF. BuildBlock is built for speed with the least waste and many unique benefits you'll find in no other block.

READY TO STACK. No on-site assembly required; start installing right off the truck.

FULLY REVERSIBLE. All forms are fully reversible; no top, bottom, left or right. Longer corner design provides automatic offset for each course.

INDUSTRY STANDARD SIZE. Industry-standard 16-inch (406mm) high forms produce less waste when cutting around doors and windows.

TIGHT INTERLOCKING BLOCKS. Blocks easily stack and securely lock into place resulting in greater strength over the competition. The form's interlock provides extreme locking and significant shear strength because of the 100% surface-to-surface connection. No foam or clips are required between courses.

2.5-INCH (63MM) FOAM PANELS. Allows easy accommodation of electrical and plumbing installation in the foam. EPS foam provides 4.2 R's per inch of insulation.

HIGH-DENSITY PLASTIC WEBS. Eight 1.5-inch (38mm) wide webs are spaced on 6-inch (152mm) centers for a stronger form and more attachment points than the 8-inch spacing found in many other ICFs. Greater strength, more value. Straight, flat, and smoother walls.

REBAR SUPPORT. Deep, snap-in rebar fingers hold two 5/8-inch (16mm) rebar in any slot with no need for tying overlapping steel. Alternating horizontal rebar one slot each course creates a pocket for vertical rebar eliminating additional vertical steel tying.

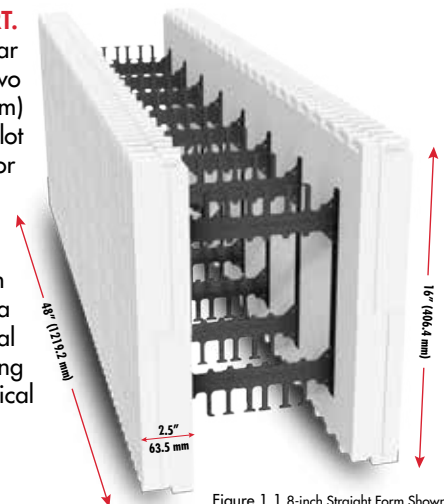

Figure 1.1 8-inch Straight Form Shown

BUILDBLOCK TECHNICAL & INSTALLATION MANUAL

EASY MECHANICAL CHASES. BuildBlock forms provide 1-inch of foam between forms and webs which can be removed after pouring for electrical, plumbing, and other cabling without cutting through vertical webs.

EXTRA HEAVY-DUTY ATTACHMENT POINTS (450+LBS). Located every 8-inches vertically, and 6-inches horizontally, they allow for super-secure attachment of heavy cabinetry or bracing directly to the ICF. The entire face of the web, 1.5"x15" (38mm x 381mm) is a standard attachment point designed for attaching bracing and other finishing materials.

OPEN WEB DESIGN. Interior rebar saddles provide rebar support even when cutting half height blocks without compromising concrete flow.

MOLDED-IN TAPE MEASURE AND HORIZONTAL CUT LINES. Numbered, vertical cut lines are molded every 1-inch and often eliminate the need for using a tape measure. Horizontal cut lines are located every 2-inches (51mm) providing cutting references for straighter cuts.

1-INCH REPEATING CUT PATTERN ON BLOCK CONNECTION. More layout options; no mismatched connections. One of the lowest waste factors of any ICF on the market today compared to all other blocks.

ATTACHMENT POINT MARKINGS. Molded-in markings identify web attachment points. Heavy-duty attachment points are marked with a BB.

BUILT-IN HALF HEIGHT BLOCKS. Easily cut blocks in half and create two identical half-height blocks as needed. No special half-height blocks required.

LONGER STRONGER CORNERS. BuildBlock corner forms are longer and stronger without requiring special accessories. The embedded corner web provides superior attachment surfaces and eliminates the need for additional strapping during installation and pouring.

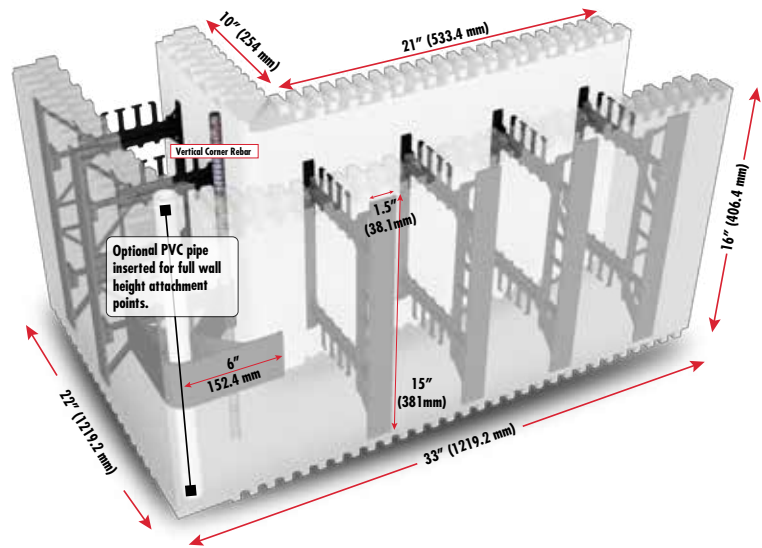

LONGER. Extra length in both directions eliminates the need for additional strapping during installation and the concrete pour, saving time and labor.

STRONGER. The 2.5-inch (63.5mm) wide, 6-inch (152.4 mm) long high-density plastic corner web holds rebar in place, adds strength during concrete pouring, and provides superior attachment points for exterior finishes.

Optionally you can place 3/4 inch (19mm) schedule 40 PVC vertically in the corner for additional attachment points for siding or trim boards. Vertical rebar can be placed in the vertical rebar holder built into the corner web.

Tight Fully-Reversible Interlocking Connections

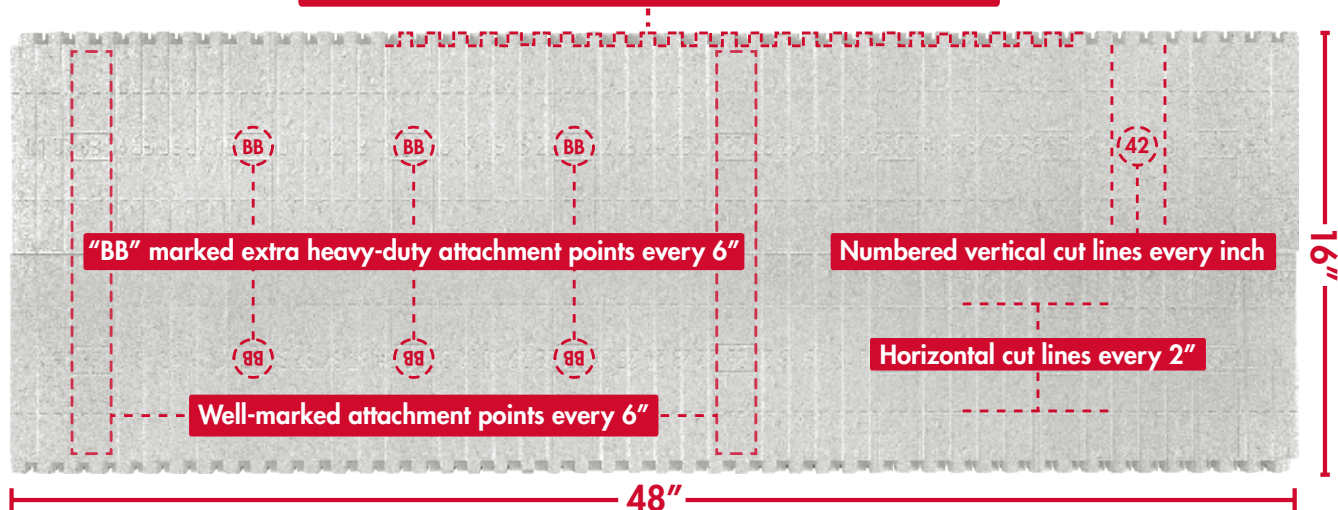

BUILDBLOCK TECHNICAL & INSTALLATION MANUAL

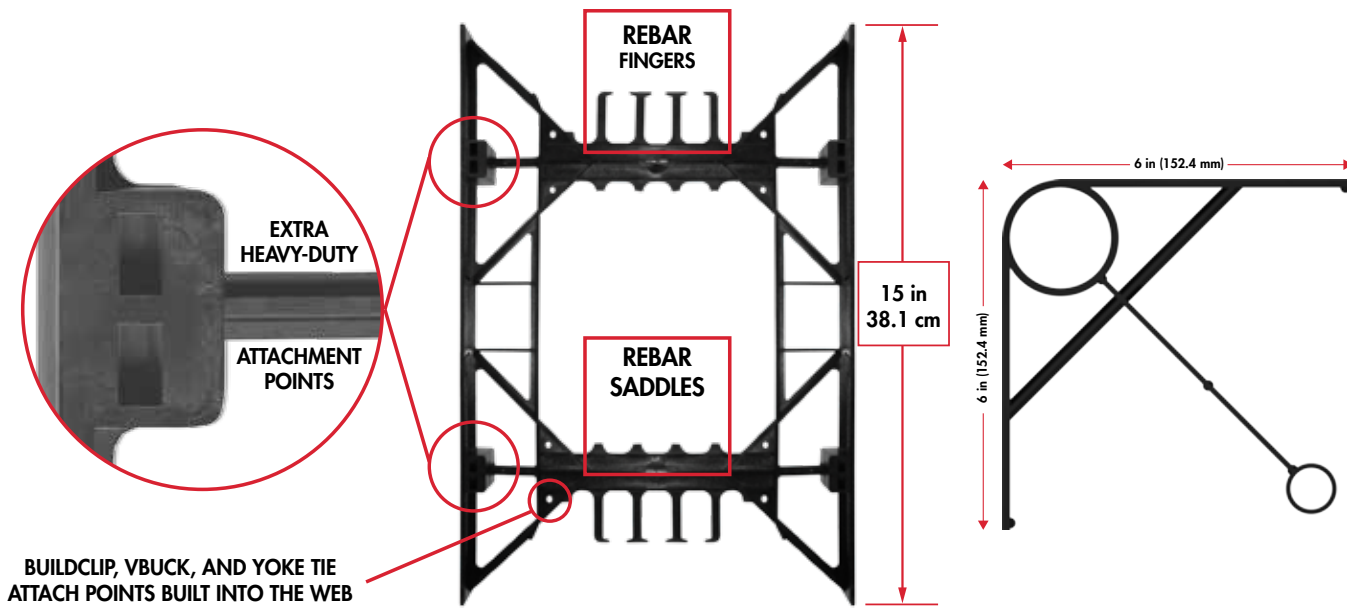

Figure 1. BuildBlock ICF wall section cutaway shows horizontal and vertical steel placement, alternating rebar placement to hold vertical rebar, J-bolts mounted in the concrete and a wooden top plate.

Figure 2. Rebar stirrups as required by local building codes, tying the horizontal rebar together above window and door lintels. The horizontal rebar runs continuously as required by building codes and additional reinforcement as required by engineer of record or local codes.

Figure 3. Attachment of standard floor joists to an ICF using traditional lumber. The Simpson Strong-Tie ICFVL is embedded into the poured concrete and provides mounting for wood or steel ledgers.

Figure 4. Integrate BuildDeck or other ICF flooring system directly into the ICF wall by cutting blocks at the correct height and joining the floor and wall systems during a continuous pour.

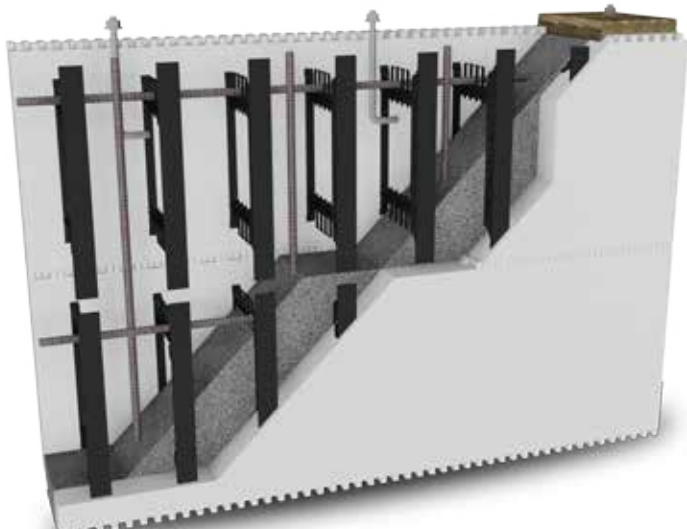

Figure 1

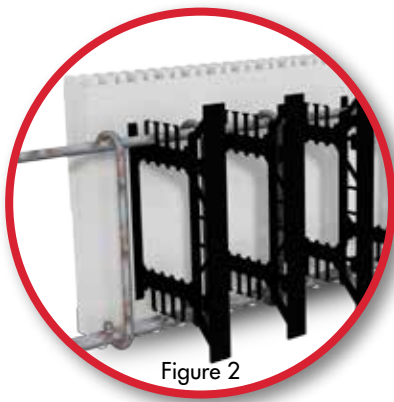

Figure 2

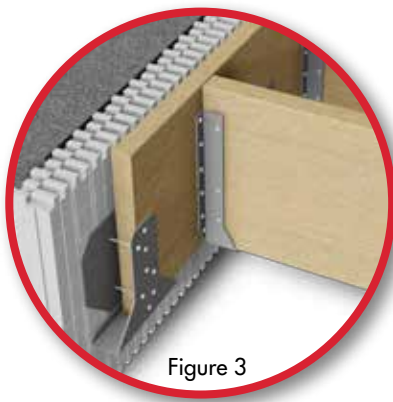

Figure 3

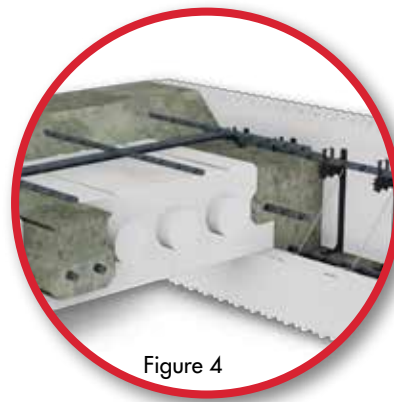
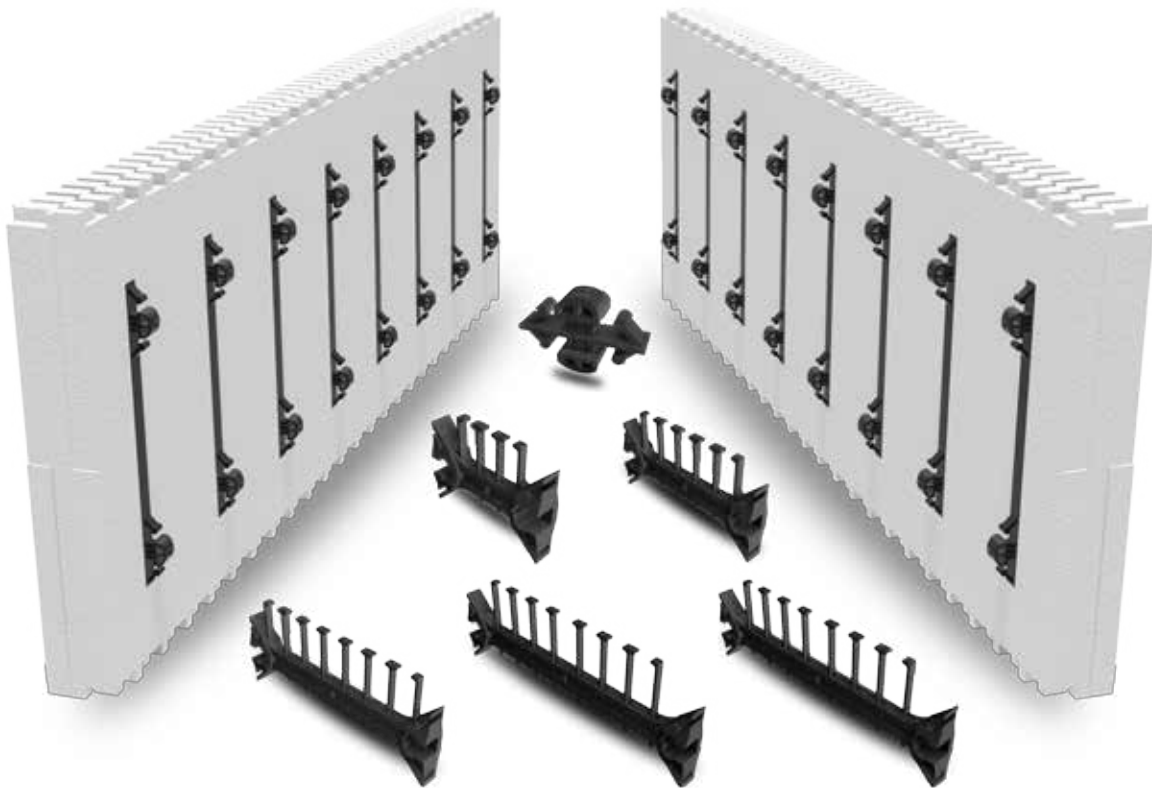

Figure 4

BUILDBLOCK TECHNICAL & INSTALLATION MANUAL



1.2 BUILDBLOCK KNOCKDOWN INSULATING CONCRETE FORMS

KNOCKDOWN BLOCK OVERVIEW

BuildLock Knockdown Insulating Concrete Forms is a robust knockdown block system manufactured by BuildBlock Building Systems. It has the same dimensions, interlocks and configurations as standard BuildBlock forms, and can be used interchangeably with any forms in the BuildBlock system. BuildLock Knockdown Blocks are available in 4-inch (BL-400), 6-inch (BL-600), 8-inch (BL-800), 10-inch (BL-1000), and 12-inch (BL-1200) sizes. BuildLock can accommodate footing widths of 2 feet or greater using the optional Bridge Connector (BLW-BC).

BuildLock uses the standard BuildBlock corners for the 4-inch, 6-inch, and 8-inch forms. BuildBlock also provides cut sheets for fabricating corners on site from straight forms for the 4-inch, 6-inch and 8-inch widths.

The 10-inch and 12-inch forms have dedicated knockdown corners and use the same Web Bridges as the BuildLock straight forms.

KNOCKDOWN BLOCK ASSEMBLY

BuildLock forms are assembled on site from three main components. A BuildLock form consists of 2 BuildLock panels (BLP) manufactured with 8 webs each embedded in EPS. The panels are joined together by 16 web bridges. These web bridges are manufactured in 2-inch increments from 4-inches to 12 inches. The optional Bridge Connector (BLW-BC) allows

2 Bridges to be connected, to further widen the panels. This is useful in situations where one needs a pilaster, or custom shaped footing or wall.

BuildLock forms are assembled by snapping the Web Bridge into the nub projecting from the panels. These are a very tight fit and are very secure once locked. Assembling the web bridges onto the panels will require striking the web bridge to force it on. There will be a “pop” when the web is fully seated. There is a retaining ridge that will make removal of the web difficult, so make sure that the rebar fingers are in the correct orientation.

The rebar fingers are generally placed opposite each other so that the block is fully reversible when stacking. Some instances will require tighter rebar spacing than 16”, and BuildLock makes this possible. You can stack the block with only the bottom webs in place in order to place rebar every 8 inches. Then insert the top bridges continuing in this manner setting horizontal rebar every 8 inches.

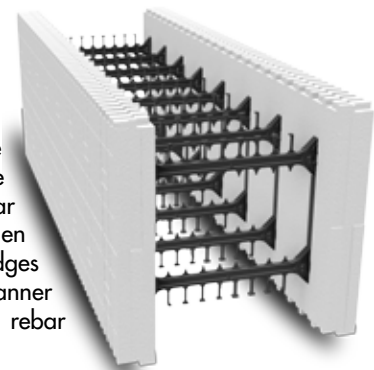

BUILDBLOCK TECHNICAL & INSTALLATION MANUAL

The rebar fingers should be placed so that the rebar can rest between them. The rebar fingers are tall enough to stack 2 rebar vertically, eliminating the need to tie them when splicing. The top bridges can then be placed and the rebar stacked as usual.

When assembling BuildLock forms, it is advisable to stand the form up on its end, and starting at the bottom, snap in both webs. This allows you to be able to strike the webs to set them without the webs above getting in the way as you work your way up. When assembling the corners, work your way around the form from the long side to the short side.

BuildLock forms are stacked and poured to the same specifications as all other BuildBlock forms. They have the same core dimensions and specifications once assembled and are completely interchangeable within a wall system. Please refer to the BuildBlock Installation manual for more information relating to the stacking, reinforcement, and pouring of BuildLock walls.

Each bundle of BuildLock panels contains enough panels to make 16 blocks. There will also be a box of 256 web bridges required to assemble the blocks. The 10-inch and 12-inch corners ship in bundles of 8, and will require 1/2 of a box of webs per bundle. The 4-inch, 6-inch, and 8-inch forms use the standard corners, and ship in bundles of 12.

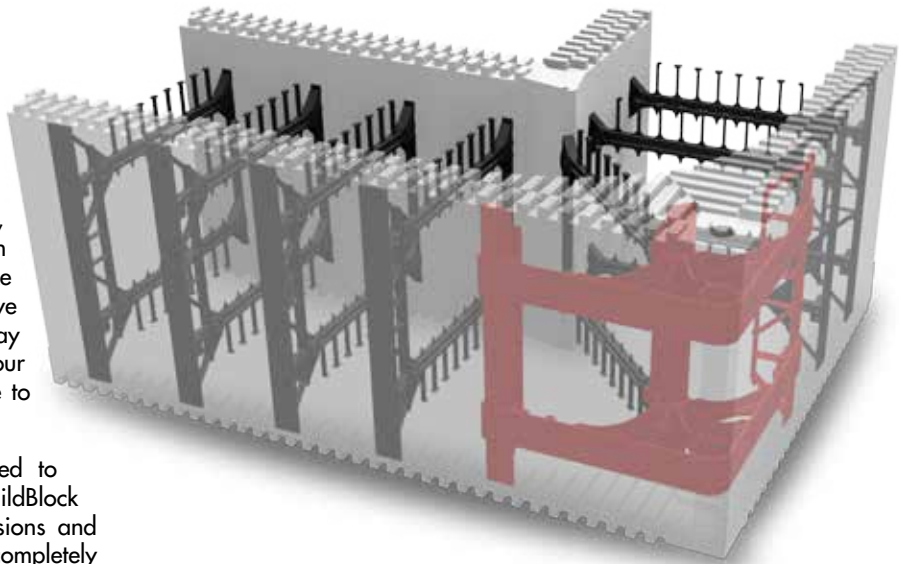

BUILDBLOCK CORNER BLOCK WITH BUILDBLOCK CORNER WEB HIGHLIGHTED

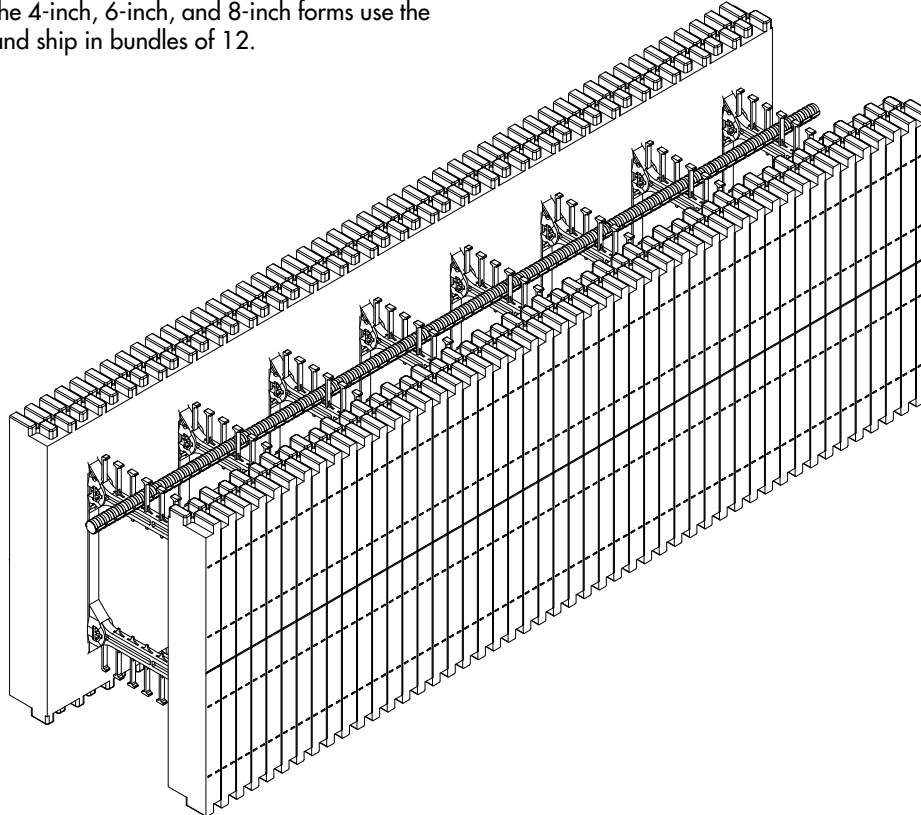

Figure 1.2.1 BuildLock BL-800 Assembled Straight Block. This block fully integrates with all other BuildBlock products. The web bridges are fully reversible inside the block for additional rebar placement options.

BUILDBLOCK TECHNICAL & INSTALLATION MANUAL

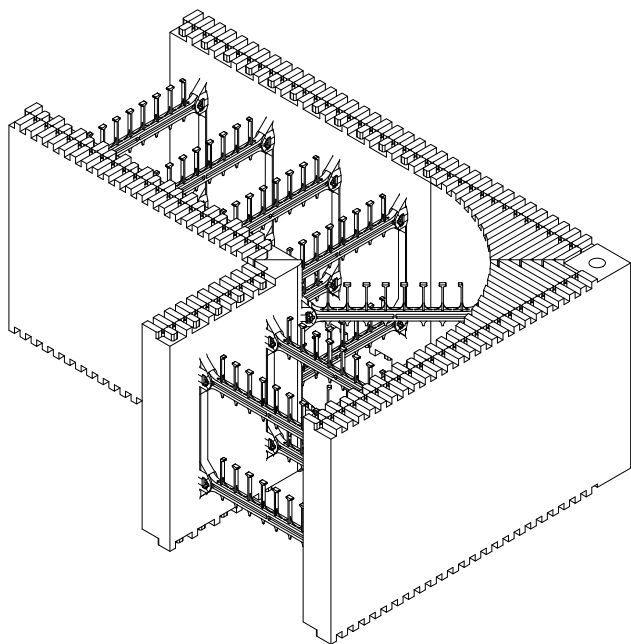

Figure 1.2.2 BuildLock BL-1290 Assembled Block. This block fully integrates with all other BuildBlock products. The longer corner on one end automatically creates the necessary offset. The block is fully reversible. Note the 3/4" hole in the corner block for additional attachment points.

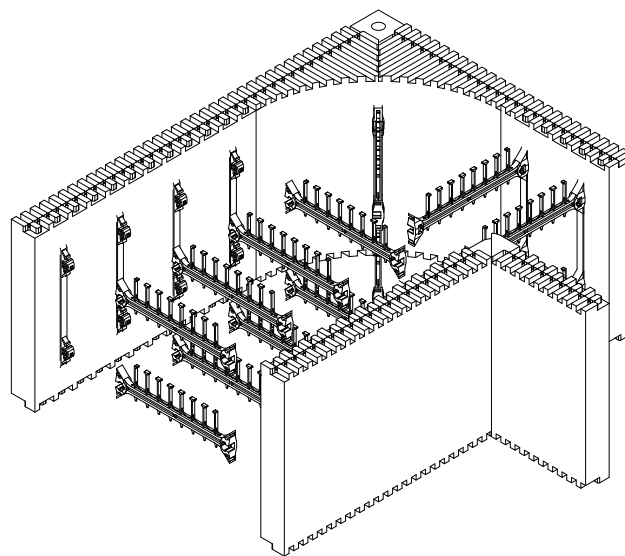

Figure 1.2.4 BuildLock BL-1290 Component Assembly. Note the placement and orientation of webs. Ensure all rebar fingers are oriented correctly before assembling.

Note: Bridges may be installed with all fingers facing the same direction for tighter horizontal rebar spacing as required in some instances. Care must be taken to maintain proper orientation for this application because the block becomes directional. Once assembled, the bridges are nearly impossible to remove.

To maintain a fully reversible form, position the bridges so the fingers face outward toward the closest interlock (top or bottom of form).

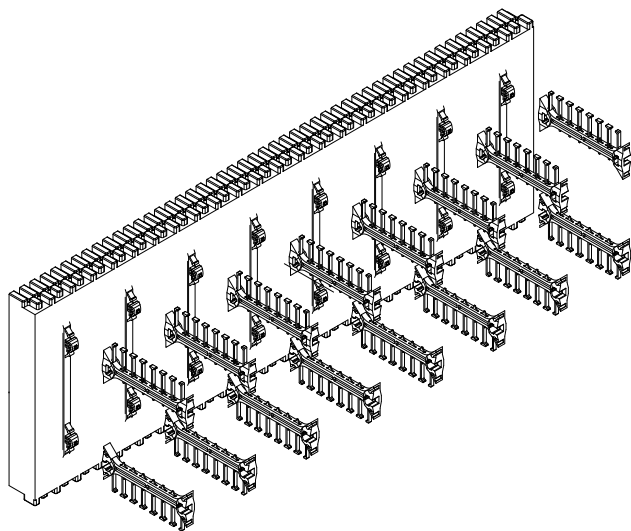

Figure 1.2.3 BuildLock BLW-800 Bridge and BLP BuildLock Panel Assembly. The Bridge connects to the panel on each side and snaps into place. Stand the block on end and start at the bottom snapping the connectors in place. Connect the two panels with the first bottom bridge working to the top point.

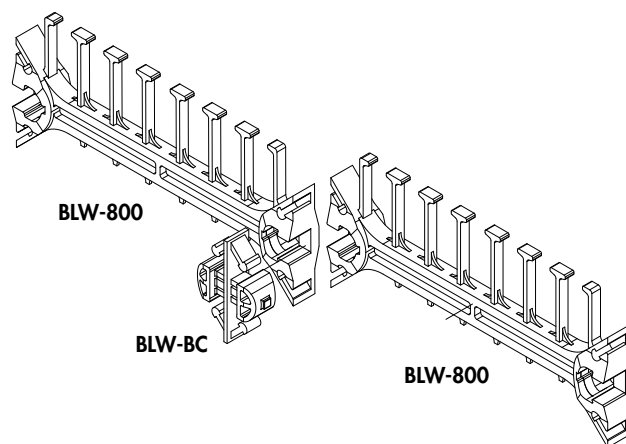
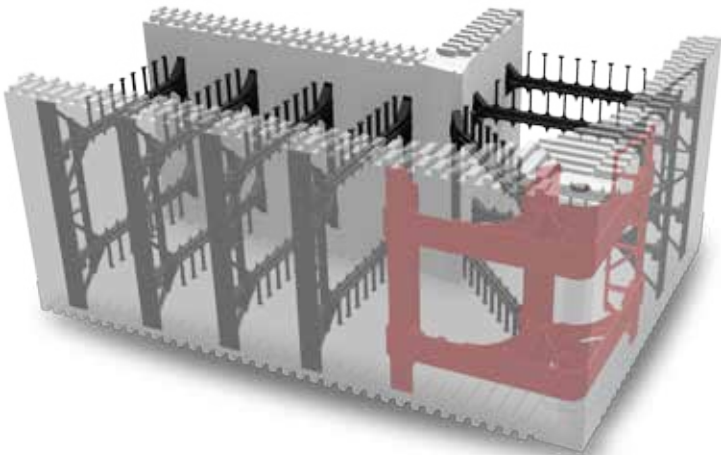
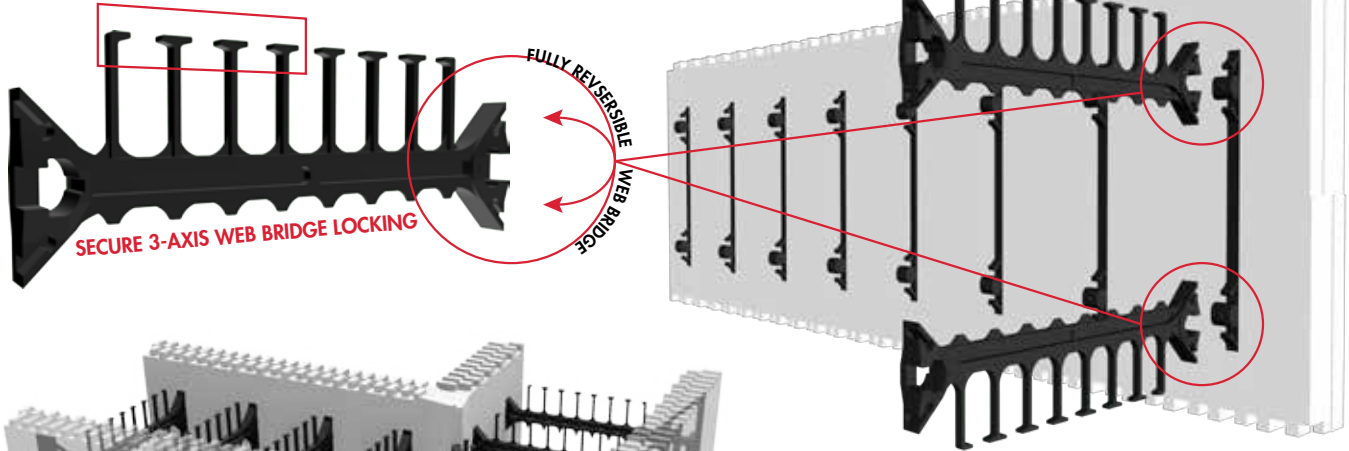

Figure 1.2.5 BuildLock BLW-800 Bridge and BLW-BC Bridge Connector Assembly. The Bridge Connector is placed between two webs to create a wider block which can be used in pilasters or custom wall configurations.

BUILDBLOCK TECHNICAL & INSTALLATION MANUAL

POSITIVE LOCKING REBAR FINGERS

The molded-in rebar fingers securely lock in place two #8 rebar or one #9 rebar virtually eliminating the time-consuming process of tying steel. Webs are fully reversible for multiple rebar locations and placing rebar on 8" horizontal spacing if required.



BUILDBLOCK CORNER BLOCK WITH BUILDBLOCK CORNER WEB HIGHLIGHTED

BUILDBLOCK KNOCKDOWN ICF CORNER IS THE BEST CORNER ON THE MARKET

The BuildLock Knockdown ICF Corner is the strongest on the market to ensure worry free pours on thick walls and commercial projects. Fully reversible and longer; the extra length in both directions eliminates the need for additional strapping during installation and concrete pours saving time and labor. The corner web also contains two full vertical webs on 6" spacing with additional horizontal attachment points.

BUILDBLOCK 3-AXIS WEB BRIDGE LOCKING

Prevents racking and provides superior stability and the strongest ICF block on the market.

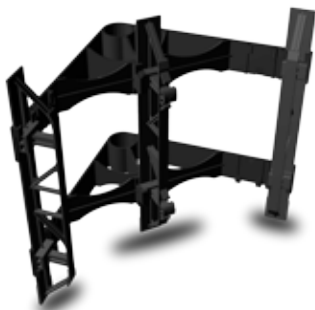

REBAR FINGERS

Massive web bridges eliminate form racking.

REBAR SADDLES

Increased rebar saddles for larger rebar sizes.

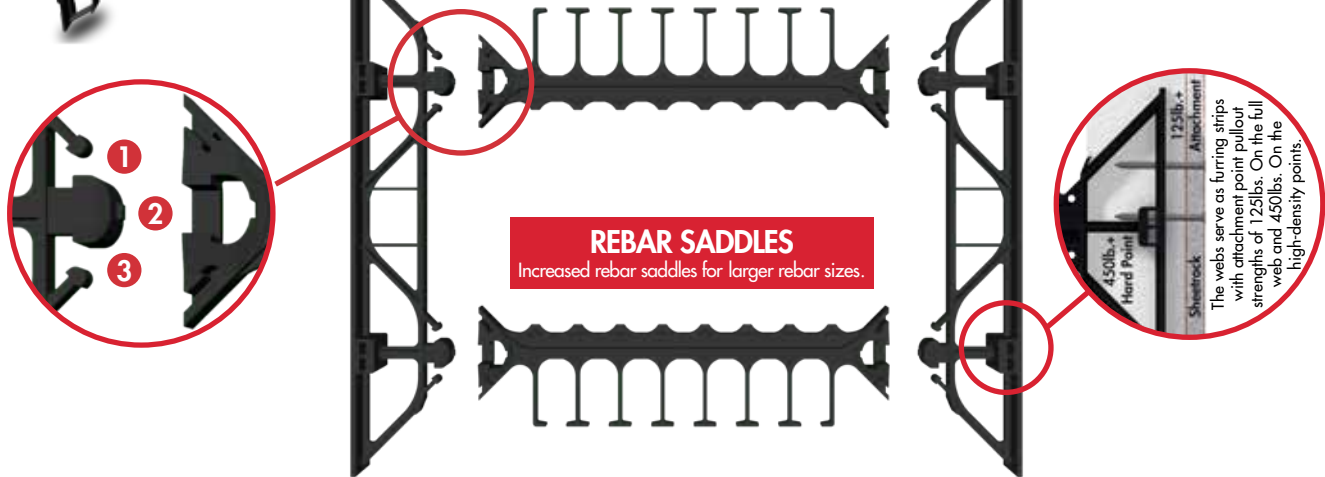

BUILDBLOCK TECHNICAL & INSTALLATION MANUAL

BUILDBLOCK KNOCKDOWN COMPONENTS

BuildBlock Knockdown Blocks are assembled from the components below. Combining components below provide great flexibility in form size, fulfilling special construction needs such as integrating pilasters into ICF walls, and reduced shipping through compact packaging.

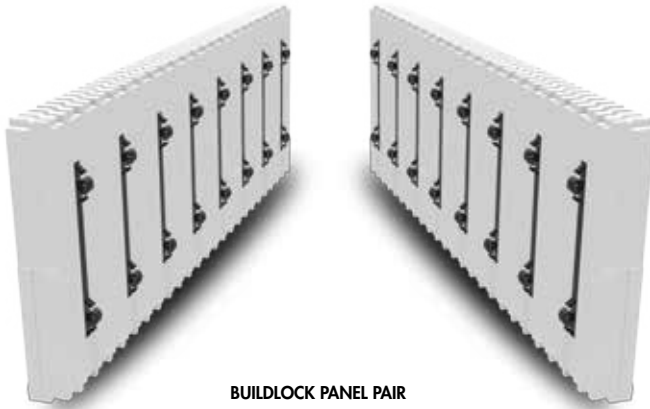
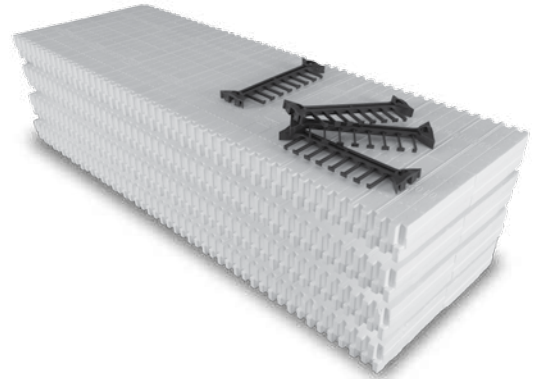

BUILDBLOCK PANEL PAIR



BUILDBLOCK BRIDGE CONNECTOR
BLW-BC



BUILDBLOCK 4-INCH BRIDGE
BLW-400



BUILDBLOCK 6-INCH BRIDGE
BLW-600



BUILDBLOCK 8-INCH BRIDGE
BLW-800



BUILDBLOCK 10-INCH BRIDGE
BLW-1000



BUILDBLOCK 12-INCH BRIDGE
BLW-1200

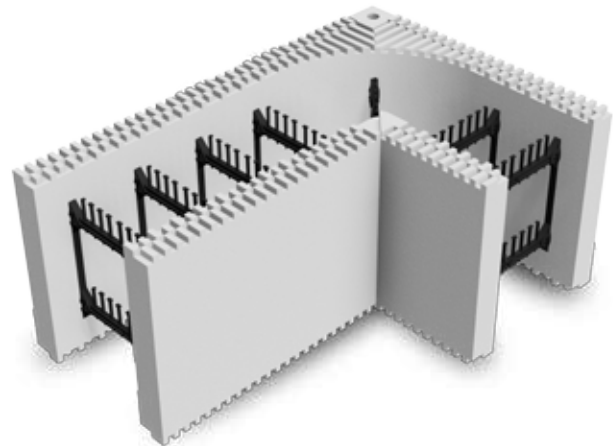
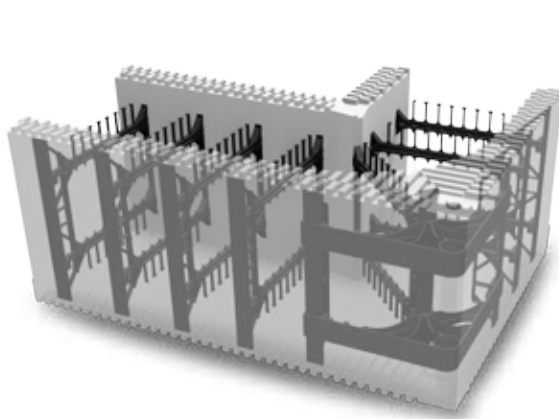

BUILDBLOCK KNOCKDOWN 12" CORNER BLOCK
BL-1200

BUILDBLOCK TECHNICAL & INSTALLATION MANUAL

1.3 PRODUCT SPECIFICATIONS (IMPERIAL)

BuildBlock Straight	SPECIFICATIONS	4" STRAIGHT*	6" STRAIGHT	8" STRAIGHT
	LENGTH	48"	48"	48"
	WIDTH	9" (4" Core)	11" (6" Core)	13" (8" Core)
	HEIGHT	16"	16"	16"
	RETURN	NA	NA	NA
	CONCRETE VOLUME	.065844 yd ³	.098765 yd ³	.131687 yd ³
	SURFACE AREA	5.33 ft ²	5.33 ft ²	5.33 ft ²
	EPS DIMENSION	2½" each panel	2½" each panel	2½" each panel
	QTY PER BUNDLE	15	12	12
	PRODUCT ID	BB-400	BB-600	BB-800

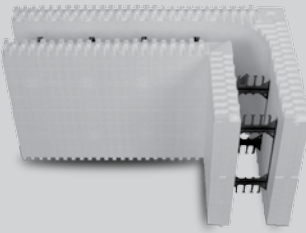
90 Degree Corner	SPECIFICATIONS	4" 90 ° CORNER	6" 90 ° CORNER	8" 90° CORNER
	LENGTH	31" (ext.) / 22" (int.)	33" (ext.) / 22" (int.)	35" (ext.) / 22" (int.)
	WIDTH	9" (4" Core)	11" (6" Core)	13" (8" Core)
	HEIGHT	16"	16"	16"
	RETURN	19" (ext.) / 10" (int.)	21" (ext.) / 10" (int.)	23" (ext.) / 10" (int.)
	CONCRETE VOLUME	.054574 yd ³	.086528 yd ³	.121517 yd ³
	SURFACE AREA	5.56 ft ²	6.00 ft ²	6.44 ft ²
	EPS DIMENSION	2½" each panel	2½" each panel	2½" each panel
	QTY PER BUNDLE	12	12	12
	PRODUCT ID	BB-490	BB-690	BB-890

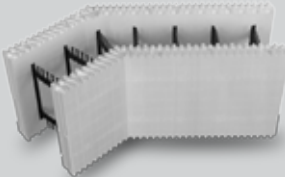
45-Degree Corner	SPECIFICATIONS	4" 45-DEGREE CORNER	6" 45-DEGREE CORNER	8" 45-DEGREE CORNER
	LENGTH	28" (ext.) / 24.272" (int.)	28" (ext.) / 23.444" (int.)	28" (ext.) / 22.615" (int.)
	WIDTH	9" (4" Core)	11" (6" Core)	13" (8" Core)
	HEIGHT	16"	16"	16"
	RETURN	16" (ext.) / 12.272" (int.)	16" (ext.) / 11.444" (int.)	16" (ext.) / 10.615" (int.)
	CONCRETE VOLUME	.054985 yd ³	.080841 yd ³	.105425 yd ³
	SURFACE AREA	4.89 ft ²	4.89 ft ²	4.89 ft ²
	EPS DIMENSION	2½" each panel	2½" each panel	2½" each panel
	QTY PER BUNDLE	12	12	12
	PRODUCT ID	BB-445	BB-645	BB-845

BRICKLEDGE	SPECIFICATIONS	6" BRICKLEDGE	8" BRICKLEDGE
	LENGTH		48"
	BOTTOM WIDTH		11" (6" Core)
	TOP WIDTH		16"
	HEIGHT		16"
	RETURN		NA
	CONCRETE VOLUME		Entire block: .134148 Corbels only: .035556
	SURFACE AREA		5.33 ft ²
	EPS DIMENSION		2½" inside panel; 1" min. outside panel
	QTY PER BUNDLE		6
	PRODUCT ID		BB-6BL

BUILDBLOCK TECHNICAL & INSTALLATION MANUAL

1.3 PRODUCT SPECIFICATIONS (IMPERIAL)

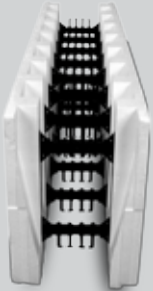
DOUBLE TAPER TOP	SPECIFICATIONS	6" BRICKLEDGE	8" BRICKLEDGE
	LENGTH	48"	48"
	WIDTH	11" (6" Core)	13" (8" Core)
	HEIGHT	16"	16"
	RETURN	NA	NA
	CONCRETE VOLUME	.130128 yd ³ Corbels only: .031363	.16305 yd ³ Corbels only: .031363
	SURFACE AREA	5.33 ft ²	5.33 ft ²
	EPS DIMENSION	2½" each panel	2½" each panel
	QTY PER BUNDLE	12	12
	PRODUCT ID		BB-6DT

BUILDBLOCK KNOCKDOWN	SPECIFICATIONS	4" KD	6" KD	8" KD
	LENGTH	48"	48"	48"
	WIDTH	9" (4" Core)	11" (6" Core)	13" (8" Core)
	HEIGHT	16"	16"	16"
	RETURN	NA	NA	NA
	CONCRETE VOLUME	.065844 yd ³	.098765 yd ³	.131687 yd ³
	SURFACE AREA	5.33 ft ²	5.33 ft ²	5.33 ft ²
	EPS DIMENSION	2½" each panel	2½" each panel	2½" each panel
	QTY PER BUNDLE	12	12	12
	PRODUCT ID		BL-400	BL-600

BUILDBLOCK KNOCKDOWN	SPECIFICATIONS	10" KD	12" KD	
	LENGTH	48"	48"	Larger sizes may be created using the BuildLock Bridge Clip Connector.
	WIDTH	15" (10" Core)	17" (12" Core)	
	HEIGHT	16"	16"	
	RETURN	NA	NA	
	CONCRETE VOLUME	.164609 yd ³	0.197529 yd ³	
	SURFACE AREA	5.33 ft ²	5.33 ft ²	
	EPS DIMENSION	2½" each panel	2½" each panel	
	QTY PER BUNDLE	16 blocks/32 panels	16 blocks/32 panels	
	PRODUCT ID		BL-1000	

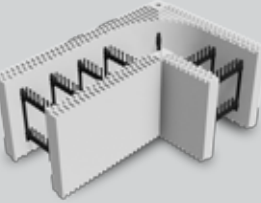
BUILDBLOCK KNOCKDOWN 90-DEGREE	SPECIFICATIONS	10" KD 90-DEGREE	12" KD 90-DEGREE	
	LENGTH	37" (ext) / 22" (int.)	39" (ext) / 22" (int.)	BuildLock 4", 6", and 8" use regular BuildBlock Dedicated Corner Forms
	WIDTH	15" (10" Core)	17" (12" Core)	
	HEIGHT	16"	16"	
	RETURN	25" (ext) / 10" (int.)	27" (ext) / 10" (int.)	
	CONCRETE VOLUME	0.151444 yd ³	0.191408 yd ³	
	SURFACE AREA	6.88 sq.ft.	7.33 sq.ft.	
	EPS DIMENSION	2½" each panel	2½" each panel	
	QTY PER BUNDLE	8 blocks/16 panels	8 blocks/16 panels	
	PRODUCT ID		BL-1090	

BUILDBLOCK TECHNICAL & INSTALLATION MANUAL

1.3 PRODUCT SPECIFICATIONS (IMPERIAL)

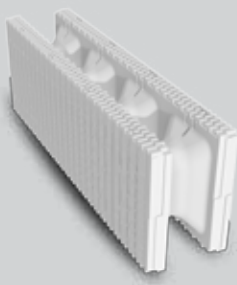
GLOBALBLOCK ALL FOAM ICF	SPECIFICATIONS	4"	6"	8"
	LENGTH	48"	48"	48"
	WIDTH	9" (4" Core)	11" (6" Core)	13" (8" Core)
	HEIGHT	16"	16"	16"
	RETURN	NA	NA	NA
	CONCRETE VOLUME	.043906 yd ³	.062947 yd ³	.088959 yd ³
	SURFACE AREA	5.33 ft ²	5.33 ft ²	5.33 ft ²
	EPS DIMENSION	2½" each panel	2½" each panel	2½" each panel
	QTY PER BUNDLE	15	12	12
	R-VALUE	26.23	29.76	31.57
	PRODUCT ID	GB-400	GB-600	GB-800

GlobalBlock forms are fully compatible with all BuildBlock & BuildLock forms of the same size.

GLOBALBLOCK ALL FOAM 90-DEGREE	SPECIFICATIONS	4"	6"	8"
	LENGTH	40" (ext.) / 31" (int.)	42" (ext.) / 31" (int.)	44" (ext.) / 31" (int.)
	WIDTH	9" (4" Core)	11" (6" Core)	13" (8" Core)
	HEIGHT	16"	16"	16"
	RETURN	28" (ext.) / 19" (int.)	30" (ext.) / 19" (int.)	32" (ext.) / 19" (int.)
	CONCRETE VOLUME	.040423 yd ³	.086528 yd ³	.121517 yd ³
	SURFACE AREA	7.55 ft ²	8.00 ft ²	8.44 ft ²
	EPS DIMENSION	2½" each panel	2½" each panel	2½" each panel
	QTY PER BUNDLE	12	12	12
	R-VALUE	26.23	29.76	31.57
	PRODUCT ID	GB-490	GB-690	GB-890

GlobalBlock forms are fully compatible with all BuildBlock & BuildLock forms of the same size.

BUILDDECK	SPECIFICATIONS	8"	10"	12"
	LENGTH	24"	24"	24"
	WIDTH	24"	24"	24"
	HEIGHT	8"	10"	12"
	RETURN	NA	NA	NA
	CONCRETE VOLUME	.051111*	.055854*	.060432*
	SURFACE AREA	4 ft ²	4 ft ²	4 ft ²
	EPS DIMENSION	8"	10"	12"
	QTY PER BUNDLE	24	20	16
	PRODUCT ID	BD-800	BD-1000	BD-1200

Additional foam may be added to the BuildDeck panels increasing the beam depth, span length, and insulation value. See BuildDeck Design Manual for additional information.

BUILDBLOCK HARD WALL	SPECIFICATIONS	4"	6"	8"
	LENGTH	48"	48"	48"
	WIDTH	8½"	10½"	12½"
	HEIGHT	16"	16"	16"
	CONCRETE CORE	6"	8"	10"
	CONCRETE VOLUME	.098765 yd ³	.131687 yd ³	.164609 yd ³
	SURFACE AREA	5.33 ft ²	5.33 ft ²	5.33 ft ²
	EPS DIMENSION	2½" each panel	2½" each panel	2½" each panel
	QTY PER BUNDLE	32	32	32
	PRODUCT ID	HW-400	HW-600	HW-800

BUILDBLOCK TECHNICAL & INSTALLATION MANUAL

1.3 PRODUCT SPECIFICATIONS (IMPERIAL)

BUILDBLOCK HARD WALL	SPECIFICATIONS	10"	12"
	LENGTH	48"	48"
	WIDTH	14½"	16½"
	HEIGHT	16"	16"
	CONCRETE CORE	12"	14"
	CONCRETE VOLUME	0.197529 yd ³	.230449 yd ³
	SURFACE AREA	5.33 ft ³	5.33 ft ³
	EPS DIMENSION	2½" each panel	2½" each panel
	QTY PER BUNDLE	32	32
	PRODUCT ID	HW-1000	HW-1200

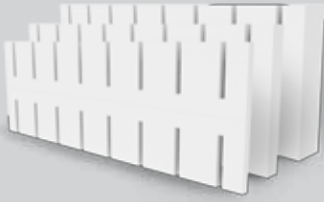
BUILDBLOCK THERMALERT	SPECIFICATIONS	1"	2"	4"
	LENGTH	48"	48"	48"
	WIDTH	1"	2"	4"
	HEIGHT	16"	16"	16"
	R-VALUE	+4.2	+8.4	+16.8
	CONCRETE DISPLACEMENT	.014999421 yd ³	.030002851 yd ³	.060009709 yd ³
	APPLICABLE FORMS	BB-400, BB-600, BB-800		
	SURFACE AREA	5.33 ft ³	5.33 ft ³	5.33 ft ³
	EPS DIMENSION			
	QTY PER BUNDLE	150	75	36
	PRODUCT ID	BTS-100	BTS-200	BTS-400

Caution: Changing final concrete core dimensions outside of prescriptive or BuildBlock Engineering will require project specific engineering and appropriate reinforcement as well as compliance with local codes. BuildBlock does not assume any liability for misuse of its products.

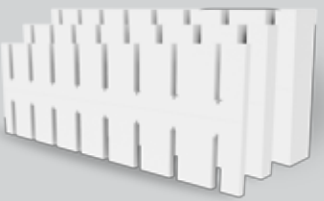
BUILDBLOCK THERMALERT KNOCKDOWN	SPECIFICATIONS	1"	2"	4"
	LENGTH	48"	24"	
	WIDTH	1"	2"	
	HEIGHT	16"	12"	
	R-VALUE	+4.2	+8.4	+16.8
	CONCRETE DISPLACEMENT	.01405099 yd ³	.028105989 yd ³	.056215985 yd ³
	APPLICABLE FORMS	BL-400, BL-600, BL-800, BL-1000, BL-1200+		
	SURFACE AREA	5.33 ft ³	5.33 ft ³	5.33 ft ³
	EPS DIMENSION			
	QTY PER BUNDLE	150	75	36
	PRODUCT ID	BLTS-100	BLTS-200	BLTS-400

Caution: Changing final concrete core dimensions outside of prescriptive or BuildBlock Engineering will require project specific engineering and appropriate reinforcement as well as compliance with local codes. BuildBlock does not assume any liability for misuse of its products.

BUILDBLOCK TECHNICAL & INSTALLATION MANUAL

1.4 PRODUCT SPECIFICATIONS (METRIC)

BuildBlock Straight	SPECIFICATIONS	4" STRAIGHT*	6" STRAIGHT	8" STRAIGHT
	LENGTH	1219mm	1219mm	1219mm
	WIDTH	228mm (101mm Core)	279mm (152mm Core)	330mm (203mm Core)
	HEIGHT	406mm	406mm	406mm
	RETURN	NA	NA	NA
	CONCRETE VOLUME	.050341 m ³	.075511 m ³	.100682 m ³
	SURFACE AREA	.4951 m ²	.4951 m ²	.4951 m ²
	EPS DIMENSION	63mm each panel	63mm each panel	63mm each panel
	QTY PER BUNDLE	15	12	12
	PRODUCT ID	BB-400	BB-600	BB-800

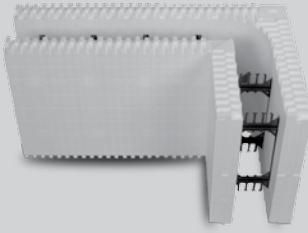
90 Degree Corner	SPECIFICATIONS	4" 90 ° CORNER	6" 90 ° CORNER	8" 90° CORNER
	LENGTH	787mm (ext.) / 558mm (int.)	787mm (ext.) / 558mm (int.)	787mm (ext.) / 558mm (int.)
	WIDTH	228mm (101mm Core)	279mm (152mm Core)	330mm (203mm Core)
	HEIGHT	406mm	406mm	406mm
	RETURN	482mm (ext.) / 254mm (int.)	533mm (ext.) / 254mm (int.)	584mm (ext.) / 254mm (int.)
	CONCRETE VOLUME	.041725 m ³	.066155 m ³	.092906 m ³
	SURFACE AREA	.5165 m ²	.5574 m ²	.5983 m ²
	EPS DIMENSION	63mm each panel	63mm each panel	63mm each panel
	QTY PER BUNDLE	12	12	12
	PRODUCT ID	BB-490	BB-690	BB-890

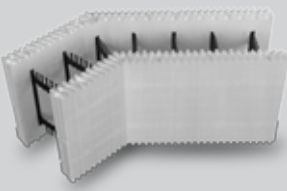
45-Degree Corner	SPECIFICATIONS	4" 45-DEGREE CORNER	6" 45-DEGREE CORNER	8" 45-DEGREE CORNER
	LENGTH	711.2mm (ext.) / 558mm (int.)	711.2mm (ext.) / 595mm (int.)	711.2mm (ext.) / 574mm (int.)
	WIDTH	228mm (101mm Core)	279mm (152mm Core)	330mm (330mm Core)
	HEIGHT	406mm	406mm	406mm
	RETURN	406mm (ext.) / 311mm (int.)	406mm (ext.) / 290mm (int.)	406mm (ext.) / 269mm (int.)
	CONCRETE VOLUME	.042039 m ³	.061807 m ³	.08060 m ³
	SURFACE AREA	.4542 m ²	.4542 m ²	.4542 m ²
	EPS DIMENSION	63mm each panel	63mm each panel	63mm each panel
	QTY PER BUNDLE	12	12	12
	PRODUCT ID	BB-445	BB-645	BB-845

BRICKLEDGE	SPECIFICATIONS	6" BRICKLEDGE	8" BRICKLEDGE
	LENGTH	1219mm	1219mm
	BOTTOM WIDTH	279mm (152mm Core)	330mm (203mm Core)
	TOP WIDTH	406mm	457mm
	HEIGHT	406mm	406mm
	RETURN	NA	NA
	CONCRETE VOLUME	Entire block: .134148 Corbels only: .035556	Entire block: .167074 Corbels only: .035556
	SURFACE AREA	.3716 m ²	.3716 m ²
	EPS DIMENSION	63.5mm inside; 254mm min. outside	63.5mm inside; 254mm min. outside
	QTY PER BUNDLE	6	6
	PRODUCT ID	BB-6BL	BB-8BL

BUILDBLOCK TECHNICAL & INSTALLATION MANUAL

1.4 PRODUCT SPECIFICATIONS (METRIC)

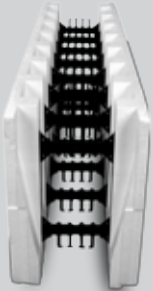
DOUBLE TAPER TOP	SPECIFICATIONS	6" BRICKLEDGE	8" BRICKLEDGE
	LENGTH	1219mm	1219mm
	WIDTH	279mm (152mm Core)	330mm (203mm Core)
	HEIGHT	406mm	406mm
	RETURN	NA	NA
	CONCRETE VOLUME	.099489 m ³ Corbels only: .031363	.124660 m ³ Corbels only: .031363
	SURFACE AREA	.4951 m ²	.4951 m ²
	EPS DIMENSION	63mm each panel	63mm each panel
	QTY PER BUNDLE	12	12
	PRODUCT ID		BB-6DT

BUILDBLOCK KNOCKDOWN	SPECIFICATIONS	4" KD	6" KD	8" KD
	LENGTH	1219mm	1219mm	1219mm
	WIDTH	228mm (101mm Core)	279mm (152mm Core)	330 (203 Core)
	HEIGHT	406mm	406mm	406mm
	RETURN	NA	NA	NA
	CONCRETE VOLUME	.050341 m ³	.07551 m ³	.100682 m ³
	SURFACE AREA	.4951 m ²	.4951 m ²	.4951 m ²
	EPS DIMENSION	63mm each panel	63mm each panel	63mm each panel
	QTY PER BUNDLE	12	12	12
	PRODUCT ID		BL-400	BL-600

BUILDBLOCK KNOCKDOWN	SPECIFICATIONS	10" KD	12" KD	
	LENGTH	1219mm	1219mm	Larger sizes may be created using the BuildLock Bridge Clip Connector.
	WIDTH	381mm (254mm Core)	431mm (304mm Core)	
	HEIGHT	406mm	406mm	
	RETURN	NA	NA	
	CONCRETE VOLUME	.125852 m ³	.151022 m ³	
	SURFACE AREA	.4951 m ²	.4951 m ²	
	EPS DIMENSION	63mm each panel	63mm each panel	
	QTY PER BUNDLE	16 blocks/32 panels	16 blocks/32 panels	
	PRODUCT ID		BL-1000	

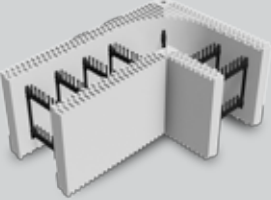
BUILDBLOCK KNOCKDOWN 90-DEGREE	SPECIFICATIONS	10" KD 90-DEGREE	12" KD 90-DEGREE	
	LENGTH	939mm (ext) / 558mm (int.)	990mm (ext) / 558mm (int.)	BuildLock 4", 6", and 8" use regular BuildBlock Dedicated Corner Forms
	WIDTH	381mm (254mm Core)	431mm (304mm Core)	
	HEIGHT	406mm	406mm	
	RETURN	635mm (ext) / 254mm (int.)	685mm (ext) / 254mm (int.)	
	CONCRETE VOLUME	.115787 m ³	.146341 m ³	
	SURFACE AREA	.6391 m ²	.6809 m ²	
	EPS DIMENSION	63mm each panel	63mm each panel	
	QTY PER BUNDLE	8 blocks/16 panels	8 blocks/16 panels	
	PRODUCT ID		BL-1090	

BUILDBLOCK TECHNICAL & INSTALLATION MANUAL

1.4 PRODUCT SPECIFICATIONS (METRIC)

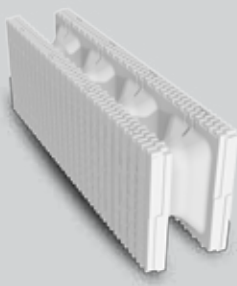
GLOBALBLOCK ALL FOAM ICF	SPECIFICATIONS	4"	6"	8"
	LENGTH	1219mm	1219mm	1219mm
	WIDTH	228mm (101mm Core)	279mm (152mm Core)	330mm (203mm Core)
	HEIGHT	406mm	406mm	406mm
	RETURN	NA	NA	NA
	CONCRETE VOLUME	.033569 m ³	.048126 m ³	.068014 m ³
	SURFACE AREA	.4951 m ²	.4951 m ²	.4951 m ²
	EPS DIMENSION	63mm each panel	63mm each panel	63mm each panel
	QTY PER BUNDLE	15	12	12
	R-VALUE	26.23	29.76	31.57
	PRODUCT ID	GB-400	GB-600	GB-800

GlobalBlock forms are fully compatible with all BuildBlock & BuildLock forms of the same size.

GLOBALBLOCK ALL FOAM 90-DEGREE	SPECIFICATIONS	4"	6"	8"
	LENGTH	1016mm (ext.) / 787mm (int.)	1066mm(ext.) / 787mm(int.)	1117mm (ext.) / 787mm (int.)
	WIDTH	228mm (101mm Core)	279mm (152mm Core)	330mm (203mm Core)
	HEIGHT	406mm	406mm	406mm
	RETURN	711mm (ext.) / 482mm (int.)	762mm (ext.) / 482mm (int.)	812mm (ext.) / 482mm (int.)
	CONCRETE VOLUME	.038863 m ³	.064701 m ³	.097978 m ³
	SURFACE AREA	.7023 m ²	.7432 m ²	.7841 m ²
	EPS DIMENSION	63mm each panel	63mm each panel	63mm each panel
	QTY PER BUNDLE	12	12	12
	R-VALUE	26.23	29.76	31.57
	PRODUCT ID	GB-490	GB-690	GB-890

GlobalBlock forms are fully compatible with all BuildBlock & BuildLock forms of the same size.

BUILDDECK	SPECIFICATIONS	8"	10"	12"
	LENGTH	609mm	609mm	609mm
	WIDTH	609mm	609mm	609mm
	HEIGHT	203mm	254mm	304mm
	RETURN	NA	NA	NA
	CONCRETE VOLUME	.051111 m ³	.055854 m ³	.060432 m ³
	SURFACE AREA	.3716 m ²	.3716 m ²	.3716 m ²
	EPS DIMENSION	203mm	254mm	304mm
	QTY PER BUNDLE	24	20	16
	PRODUCT ID	BD-800	BD-1000	BD-1200

Additional foam may be added to the BuildDeck panels increasing the beam depth, span length, and insulation value. See BuildDeck Design Manual for additional information.

BUILDBLOCK TECHNICAL & INSTALLATION MANUAL

BUILDBLOCK HARD WALL	SPECIFICATIONS	4"	6"	8"
	LENGTH	1219mm	1219mm	1219mm
	WIDTH	216mm	266mm	317mm
	HEIGHT	406mm	406mm	406mm
	CONCRETE CORE	152mm	203mm	254mm
	CONCRETE VOLUME	0.075511m ³	0.100682m ³	0.125853m ³
	SURFACE AREA	0.495m ²	0.495m ²	0.495m ²
	EPS DIMENSION	63.5mm each panel	63.5mm each panel	63.5mm each panel
	QTY PER BUNDLE	32	32	32
	PRODUCT ID	HW-400	HW-600	HW-800

1.4 PRODUCT SPECIFICATIONS (METRIC)

BUILDBLOCK HARD WALL	SPECIFICATIONS	10"	12"
	LENGTH	1219mm	1219mm
	WIDTH	368mm	419mm
	HEIGHT	406mm	406mm
	CONCRETE CORE	304mm	355mm
	CONCRETE VOLUME	0.151022m ³	0.176191m ³
	SURFACE AREA	0.495m ²	0.495m ²
	EPS DIMENSION	63.5mm each panel	63.5mm each panel
	QTY PER BUNDLE	32	32
	PRODUCT ID	HW-1000	HW-1200

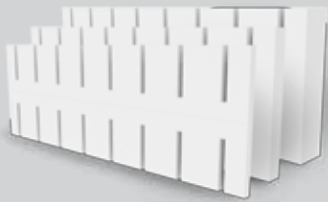
BUILDBLOCK THERMALERT	SPECIFICATIONS	1"	2"	4"
	LENGTH	48"	48"	48"
	WIDTH	1"	2"	4"
	HEIGHT	16"	16"	16"
	R-VALUE	+4.2	+8.4	+16.8
	CONCRETE DISPLACEMENT	.014999421 yd ³	.030002851 yd ³	.060009709 yd ³
	APPLICABLE FORMS	BB-400, BB-600, BB-800		
	SURFACE AREA	5.33 ft ³	5.33 ft ³	5.33 ft ³
	EPS DIMENSION			
	QTY PER BUNDLE	150	75	36
	PRODUCT ID	BTS-100	BTS-200	BTS-400

Caution: Changing final concrete core dimensions outside of prescriptive or BuildBlock Engineering will require project specific engineering and appropriate reinforcement as well as compliance with local codes. BuildBlock does not assume any liability for misuse of its products.

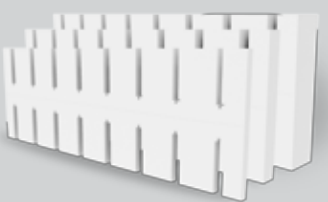
BUILDBLOCK THERMALERT KNOCKDOWN	SPECIFICATIONS	1"	2"	4"
	LENGTH	48"	24"	
	WIDTH	1"	2"	
	HEIGHT	16"	12"	
	R-VALUE	+4.2	+8.4	+16.8
	CONCRETE DISPLACEMENT	.01405099 yd ³	.028105989 yd ³	.056215985 yd ³
	APPLICABLE FORMS	BL-400, BL-600, BL-800, BL-1000, BL-1200+		
	SURFACE AREA	5.33 ft ³	5.33 ft ³	5.33 ft ³
	EPS DIMENSION			
	QTY PER BUNDLE	150	75	36
	PRODUCT ID	BLTS-100	BLTS-200	BLTS-400

Caution: Changing final concrete core dimensions outside of prescriptive or BuildBlock Engineering will require project specific engineering and appropriate reinforcement as well as compliance with local codes. BuildBlock does not assume any liability for misuse of its products.

BUILDBLOCK TECHNICAL & INSTALLATION MANUAL

1.5 PRODUCT TECHNICAL DETAILS

SPECIFICATION	IMPERIAL	METRIC
Expanded Polystyrene density	1.5 lbs./cu.ft.	24.02769 kg/m ³
Average thickness of EPS	2½" per panel (5" total)	12.7cm (6.35cm per panel)
Material R-value	R-22 Foam Value	R-22 Foam Value
Performance R-value (concrete, form R-value, air infiltration reduction, and thermal mass)	R-30 to R-52	R-30 to R-52 U 0.33 to U 0.02
Actual R-value per inch of EPS Foam	4.2/inch	
Thermal Mass (form & concrete)	4" Core: 47.5 lbs./ft ² 6" Core: 72 lbs./ft ² 8" Core: 96 lbs./ft ² 10" Core: 119 lbs./ft ² 12" Core: 143 lbs./ft ²	4" Core: 231.9 kg/m ² 6" Core: 351.5 kg/m ² 8" Core: 468.7 kg/m ² 10" Core: 581.0 kg/m ² 12" Core: 698.2 kg/m ²
K-Factor	.24/inch	
Water absorption	- 3% (ASMC272)	- 3% (ASMC272)
Water vapor	0.56 perms per 2½" Panel	0.84 metric perms per 2½" Panel
Sound class	52 with ½" sheet rock on inside	52 with ½" sheet rock on inside
Fire wall	3 Hour Fire Rating on BB-600 Wall (Loading 5,000 lb. per lineal feet throughout test.) (Post test loading 12,000 lbs. per lineal foot with no additional depletion.)	3 Hour Fire Rating on BB-600 Wall (Loading 7440.6 kg/m throughout test.) (Post test loading 17857.9 kg/m with no additional depletion.)
Concrete compressive strength	Recommended 3000 psi minimum	Recommended 20 MPa minimum
Recommended concrete pouring temperature*	15°F to 120°F*	(-9°C to 49°C)*

*Properly handled, specially formulated concrete can be poured at temperatures as low as -15°F (-26°C). Consult your ready mix company. Important: At temperatures below freezing, you must cover all exposed concrete with insulating material.

ASTM STANDARDS PRODUCT TESTING

BuildBlock ICFs are evaluated to ensure they meet or exceed a variety of industry standards tests

PROPERTIES	ASTM TEST	RANGE REQUIRED	TEST VALUE
Density	ASTM D1622	1.5lb/ft ³	1.69lb/ft ³
Thermal Resistance	ASTM C177	4.0F.ft ² .h/Btu/in	4.08F.ft ² .h/Btu/in
Compressive Strength	ASTM D1621	15.0 psi	23.1 psi
Flexural Strength	ASTM C203	40.0 psi	50.4 psi
Flame Spread	ASTM E84	25 Maximum	>25
Smoke Developed	ASTM E84	450 Maximum	>450
Fire Wall Rating	ASTM E119		3hr
R-Value	ASTM C518	R-22	R-22
STC Rating	ASTM E413	STC 50	STC 50
Vapor Permanence	ASTM E96	3.5 perms/inch Maximum	2.04 perms/inch

BUILDBLOCK TECHNICAL & INSTALLATION MANUAL

1.6 TRANSPORTATION, HANDLING, AND STORAGE OF BUILDBLOCK ICF FORMS AND PRODUCTS

Proper transportation, handling, and storage of BuildBlock Forms are required to prevent damage and deterioration, to ensure the quality of the forms for the end user, and to honor warranty requirements.

TRANSPORTING BUILDBLOCK ICFs



Figure 1.6.1 53' Dry Van Trailer

BuildBlock forms are packaged by the manufacturer in sturdy bundles using corrugated trays and strapping. "Breaking" bundles and transporting unbundled forms voids the warranty on the unbundled forms. BuildBlock will not ship unbundled forms unless expressly requested by the customer and an additional fee applies to do so. BuildBlock highly recommends transporting bundles of forms in an **enclosed** trailer.

Use of an open flat-bed trailer is not recommended and may result in damage which is not covered by the manufacturer's warranty. If using an open trailer, position forms so that wind travels through the cavities, carefully position strapping to avoid damage to forms, and cover the load with a tarp, if possible.

When accepting a shipment of forms, the customer should inspect each bundle. In the unlikely event of an issue, the **customer must note the damage on the Bill of Lading** when signing. Customer should then contact BuildBlock Quality Control immediately to begin the warranty process.



Figure 1.6.2 Unload BuildBlock forms flat to prevent damage to edges and corners.

UNLOADING ICF FORMS

When unloading the forms on the job site take care not to damage the forms or the interlocks. Slide the forms to the edge of the truck and lower them to the ground by two people. They can easily be carried by two people to a convenient location on the job site.

CAUTION:

Dropping bundles of forms off the truck at an angle will damage and crush the blocks. Taking care of small details in the beginning will save you time throughout your job.



Figure 1.6.3 BuildBlock forms are easily moved around a job site by 1 or two people Drag do not roll to prevent damaging interlock or edges.

HANDLING BUILDBLOCK FORMS

The vast majority of form and web damage is a result of mishandling, not manufacturing issues. BuildBlock forms should be handled with care to prevent damage to the EPS material (especially the connection grid) and the plastic webs. If using a forklift be especially careful not to damage webs when lifting bundles.

A forklift is typically not required. Bundles can be easily carried by one or two people. A 2x4 or conduit pipe may be placed through bundles and used as handles.

BUILDBLOCK TECHNICAL & INSTALLATION MANUAL

Figure 1.6.4 BuildBlock ICF forms stored in the manufacturing facility.

STORING ICF FORMS

Secure interior warehouse storage is ideal. Storing forms outside for extended periods of time may result in damage or deterioration by weather elements, insects (especially in termite infested areas), or rodents.

Keep in mind that forms are lightweight and easily blown around by wind. We recommend keeping forms in bundles until ready for use. Be careful to secure bundles if adverse weather is expected.

If forms are stored outside for more than a few weeks, they should be covered and protected from UV (ultraviolet) rays. Prolonged exposure to UV rays causes yellowing (oxidation) of the EPS. This does not affect the integrity of the forms, but you must clean the forms to remove the layer of oxidation prior to bonding anything to the surface such as waterproofing or exterior finishes.

After the forms have been installed and filled with concrete, this can easily be done using a stiff brush or power washer. Keep the sprayer head far enough away from the foam surface to prevent any damage.

BUILDBLOCK TECHNICAL & INSTALLATION MANUAL

This page left intentionally blank.

BUILDBLOCK TECHNICAL & INSTALLATION MANUAL

SECTION 2: TOOLS AND ACCESSORIES

2.1 RECOMMENDED TOOLS & ACCESSORIES

BuildBlock Building System carries a full line of ICF construction accessories that complement BuildBlock ICFs and related products when building residential homes, commercial, and industrial, buildings. Ensuring you have the tools to make installation quick and efficient will decrease frustration and save you money and time, increasing your bottom line.

- Folding Pruning Saw
- Skill saw
- Keyhole saw
- Table saw (optional, for convenience)
- Hammer drill, cordless drill
- Rebar tie tool
- Hot Knife or Hot Knife Kit combo*
- Hammer
- Framing square
- Concrete trowel
- Level
- Tape measure
- Transit or laser level
- Mason's line and chalk line
- Rebar bender
- Rebar cutter
- Wall alignment (bracing) system*
- Scaffold planks
- Concrete pencil vibrator, 3/4" low impact 1" maximum
- Foam guns, foam, and foam cleaner*
- Work gloves
- Sun Screen
- Broom and floor scraper

*These tools and accessories are available from BuildBlock. See <http://store.buildblock.com> for details and purchasing information.

**7" OR 10" FOLDING PRUNING SAW**

Finally, a hand saw designed for ICFs that you can put in your back pocket on the job site. This precision saw makes short work of field cuts and has a great balance and feel. This saw comes in two different sizes, 7" or 10" and is available from Wind-lock.

**BRACING / WALL ALIGNMENT SYSTEMS**

Bracing and aligning ICF walls is vital. BuildBlock recommends several bracing options. See Section 9 of this manual for details.

The BuildBrace system by Plumwall is available in an all-in-one and 3 piece system. Additionally these can be supplemented for tall wall applications.

For more information, visit our website <http://buildblock.com>.

**FOAM GUNS, FOAM ADHESIVE, AND CLEANER**

Low-expanding foam adhesive is a staple product on an ICF job site. It can be used to secure the first course, to hold blocks together if needed, to fill uneven areas, and much more. The foam, foam gun, and gun cleaner are available through BuildBlock. (See details at buildblock.com.)

**CARPENTERS 12"-18" SHARKTOOTH SAW**

This type of saw is very helpful for longer cuts and helpful to have on hand for other needs on your job site.

BUILDBLOCK TECHNICAL & INSTALLATION MANUAL



HOT KNIVES AND ACCESSORIES

Hot knife kits come with the knife, the sled to stabilize the cut, and an array of blades to get the job done. Electrical boxes, grooves for wiring and the new radius blade makes short work of electrical, plumbing, and radius concerns in ICFs. Available from Wind-lock and BuildBlock. See details at <http://buildblock.com>.



SUPER GROOVER KIT

The Super Groover Kit is on the professional level of Wind-lock products and offers the installer a belt-pack transformer for precise control of temperature and ease of use. The industrial hot knife lasts twice as long as conventional products currently available. (Regular hot knives and kits are available through BuildBlock.)



BN PRODUCTS BNCE-20 REBAR CUTTER

This compact and lightweight tool has a 3-position removable side handle and a rotating trigger handle that provides the operator with multiple cutting positions and increased maneuverability in tight areas.

This amazing tool can cut a variety of materials including rebar, all-thread rod, coil rod, EMT conduit, pipe, tubing, burglar bars and more. It is designed to cleanly cut the material flush with the surface in just a couple of seconds per cut. Available through BuildBlock.com



FORM A DRAIN

FORM-A-DRAIN® is the 3-in-1 foundation solution that forms footings, provides an integrated drainage system for footings or basements, eliminates all wood forming material and can be easily adapted to vent radon where needed. Available through BuildBlock.com



DUPLEX SCREWS

Duplex Screws use a Phillips head bit or 1/4" hex drive, are easily removed from concrete forms in commercial and residential projects and are reusable over and over again.

For More Information about Duplex Screws visit: <http://www.removeite.com>

BUILDBLOCK TECHNICAL & INSTALLATION MANUAL



WATERPROOFING

BuildBlock recommends combining methods of water proofing for best results. Either combine a water-based primer and a peel and stick membrane or the peel and stick membrane with the DMX AG (Air Gap) membrane. Available through BuildBlock.com



DOOR AND WINDOW BUCKING

There are a few different types of materials and products used for bucking around doors and windows. BuildBlock recommends using an insulated bucking system such as GorillaBuck or Vinyl bucking system V-Buck.

GorillaBuck is designed with the same materials used in BuildBlock ICFs and provides an insulated break between the concrete and your rough opening. Additionally the hard attachment points surrounding the opening and built-in drainage plane create a safer door and window installation. Gorilla Buck is available in interlocking 4-foot lengths.

V-Buck is easy to assemble and provides a sealed dead air space between the concrete and your window. The V-Buck system has been used for more than 20 years in thousands of projects around the world. V-Buck is available in 16-foot lengths and is cut to size and assembled before being placed in the wall. Available through BuildBlock.com

See <http://buildblock.com> or Section 8 of this manual for details.



FAST FOOT

Made of high density polyethylene fabric, Fastfoot® is a green replacement of lumber and plywood for forming concrete footings. A 100-foot roll of Fastfoot forms the same concrete as 1,500 pounds of lumber. Available through BuildBlock.com

BUILDBLOCK TECHNICAL & INSTALLATION MANUAL**RADIANT FLOORING PANELS**

BuildBlock ICF homes perform so efficiently that adding radiant flooring to your project is one way to significantly reduce the use of your heater and maintain a constant room temperature. Available through BuildBlock.com

RAZ PANEL™ FROM EZ FLOOR

Unlike other products that claim to speed up or simplify the process of installing PEX tubing for in-floor hydronic radiant heat applications, the RAZ Panel™ truly comes through for you with uncompromising performance!

No worries about tubing being kicked out of place as the PEX sits below the working surface of the foam.

No wasted time un-jamming staplers or twisting ties around metal mesh.

NO COSTLY MISTAKES! If you need to adjust the spacing of a run, all you have to do with the RAZ Panel™ is pull up the PEX adjust the spacing and walk it back in. No pulling and wasting staples and damaging the foam insulation!

Installation is as easy as 1-2-3. Lay down the panel, walk in the PEX and pour the concrete.

With a compressive strength of 860 pounds per square foot, the RAZ Panel™ is strong enough to stand up to the rugged job site conditions it will experience. Available through BuildBlock.com

CREATHERM RADIANT FLOOR PANELS

Ready for a simple, innovative PEX tube installation system! CREATHERM Radiant Floor Panels provide an energy efficient solution – one that saves time and labor costs – and can be installed anywhere. They provide an efficient thermal and sound barrier between the ground and heated slab.

Interlocking panels measure approximately two feet by four feet for an easy staggered layout. A snap-tight grid allows for precise tube layout that walks into place. Eliminate the need to tie, clip, staple or screw PEX tubing to a substrate.

Specific product details are outlined below. Create your own custom imprint to achieve exclusivity in your market. CREATHERM™ Radiant Floor Panels are protected under US Patent D541396. Available through BuildBlock.com

BUILDBLOCK TECHNICAL & INSTALLATION MANUAL

SECTION 3: ESTIMATING

3.1 HOW TO ESTIMATE BLOCKS FOR YOUR PROJECT

There are three simple ways to estimate how many ICF forms will be needed in your project. Follow the instructions below to estimate how many BuildBlock forms you'll need for your construction project. Or, download our automated estimator program from our website at: <http://buildblock.com/technical-support/estimating-bidding/>

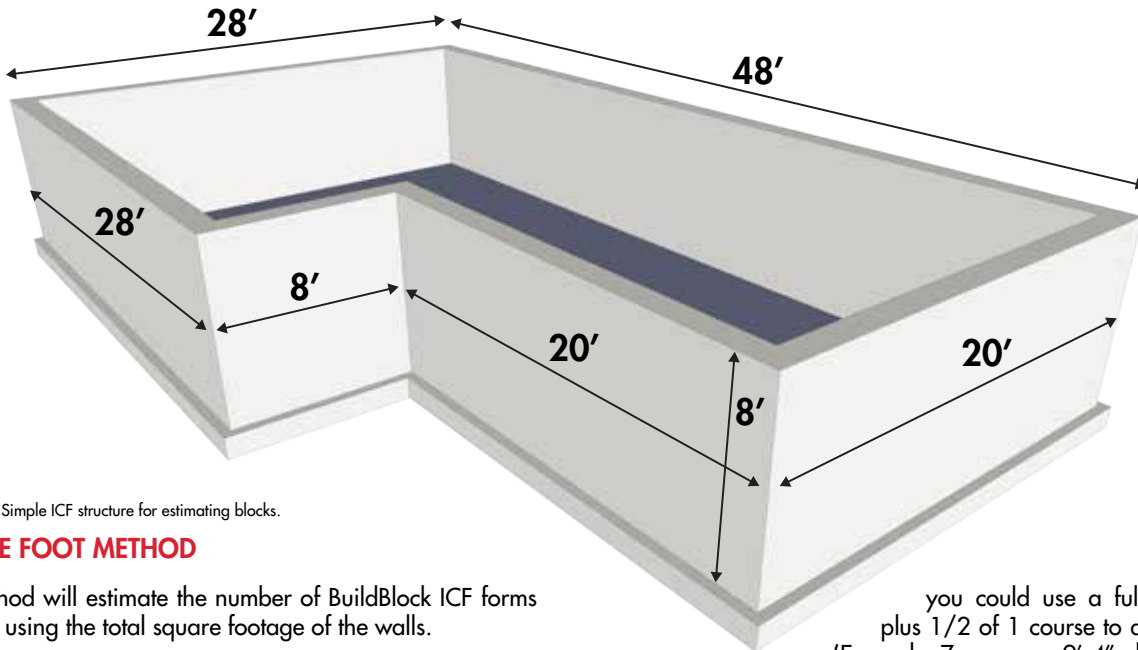

Figure 3.1.1 Simple ICF structure for estimating blocks.

SQUARE FOOT METHOD

This method will estimate the number of BuildBlock ICF forms required using the total square footage of the walls.

1. Calculate the linear footage of wall and multiply it by the height of the wall.
2. Divide the square footage of the wall by 5.33 (the square footage of a straight block). This will give you the number of straight blocks needed.
3. Divide the wall height by the block height (16") and round up. This will give you the number of courses.
4. Multiply the number of courses by the number of corners in the floor plan. This will give you the number of corner blocks needed.
5. Subtract the number of corners from your total blocks and this will give you your final number of straight blocks necessary.
6. Add the square footage of all window and door openings divide by 5.33 and multiply by 80%. Subtract this number from the square footage of straight blocks.

Note: This method doesn't take into account door and window openings.

SQUARE FOOT METHOD (ALTERNATE)

1. Divide wall height by 16" and round up. This is the number of courses required. (Keep in mind that BuildBlock is reversible. This feature allows you to cut the block in half and use an 8" high section instead of the full 16" tall block. For example, if you were figuring a 10' wall height,

you could use a full 7 courses plus 1/2 of 1 course to achieve 10'.
(Example: 7 courses = 9'-4" plus 1/2 of 1 course = 8" of height to make 10'.)

2. Multiply the # of 90° corners in the structure by the # of courses required. This is the number of 90° corner forms required.
3. Multiply the # of 45° corners in the structure by the # of courses required. This is the number of 45° corner forms required.
4. Use the chart below to determine the total square footage of all 90° forms to be used. (Number of 90° forms multiplied by sq. ft. per form.) Do the same for the 45° forms.
5. Determine the total square foot area of wall being formed (perimeter in feet x height, minus 80% of window and door openings). Subtract total square foot of all 90° forms and all 45° forms to be used from this total.
6. Divide the remaining square footage of the wall by 5.33 to determine the number of straight forms required. Add a small number of forms for possible waste. You do not want to be short on material. Expect some mistakes, mis-cuts, or special areas that require additional waste, so have a few extra forms on hand.

LINEAR FOOT METHOD

1. Divide height by 16. This equals the number of courses.

BUILDBLOCK TECHNICAL & INSTALLATION MANUAL

2. Divide the linear feet by 4. This equals the number of blocks per course.
3. Count 90 degree and 45 degree corners, both inside and outside.
4. Subtract 1 straight for every outside corner
5. Subtract 1 straight form for every 2 inside corners.
6. For more accuracy calculate square footage of window and door openings, multiply by 80% and subtract 1 straight form for every 5.33 ft² of openings.
7. Multiple straights and corners by the number of courses.

BUILDBLOCK ESTIMATING TOOL

The BuildBlock Estimating Tool gives the most detailed estimate possible for the ICF portion of your project. This tool is freely distributed on the BuildBlock website. The program is set up with a tab for each level of your home or building.

Basic information for each level such as wall height and form thickness are selected as well as other specifics. Additionally openings for doors and windows are input. The size and spacing of rebar are selected as well as footing information, gables, and radius walls.

The program will display a summary for each level of the building as well as a total job summary including estimated rebar, BuildBlock products, window and door bucking, and more.

Bucking isn't typically used at the bottom of a door opening.

Note: Window and door openings are usually created slightly larger than the actual window or door size so we recommend adding a couple of inches to each leg of an opening for your material purchases.

V-Buck comes in lengths of 8 ft. or 16 ft. Dimensional lumber comes in lengths starting at 8 ft. and every 2 ft. additional lengths up to a maximum of usually 18 ft. to 24 ft.

Properly brace any splices and use full pieces where ever possible. Cross bracing of bucks is important. See notes on building and bracing bucks in Section 8 of this manual.

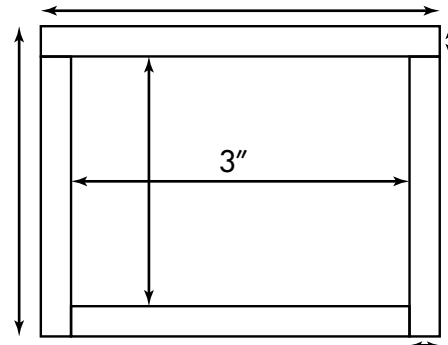

ICF Window opening. Remember to include the thickness of the buck in your calculation.

Figure 3.2.1 Proper window bucking design.

SURFACE AREA PER BLOCK					
FORM TYPE	4"	6"	8"	10"	12"
Straight	5.33 ft ² .4951 m ²	5.33 ft ² .4951 m ²	5.33 ft ² .4951 m ²	5.33 ft ² .4951 m ²	5.33 ft ² .4951 m ²
90° Corner	5.56 ft ² .5165 m ²	6.00 ft ² .5574 m ²	6.44 ft ² .5983 m ²	6.88 ft ² .6391 m ²	7.33 ft ² .6809 m ²
45° Corner	4.89 ft ² .4542 m ²	4.89 ft ² .4542 m ²	4.89 ft ² .4542 m ²	-	-
Brick Ledge	-	5.33 ft ² .5574m ²	5.33 ft ² .5574m ²	-	-
Double Taper	-	5.33 ft ² .5574m ²	5.33 ft ² .5574m ²	-	-
GlobalBlock Straight Block	5.33 ft ² .4951 m ²	5.33 ft ² .4951 m ²	5.33 ft ² .4951 m ²	-	-
GlobalBlock 90° Corner	7.55 ft ² .7023 m ²	8.00 ft ² .7432 m ²	8.44 ft ² .7841 m ²	-	-

BuildBlock and BuildLock Knockdown ICFs in the same size have identical dimensions and surface area. GlobalBlock straight blocks match all BuildBlock & BuildLock Knockdown ICFs, GlobalBlock corners are larger than standard corners but still fully integrate into the same BuildBlock walls.

3.2 ESTIMATING BUCKING MATERIALS

To estimate bucking materials for windows calculate:

- (height of opening + 2x thickness of buck) x 2
- (width of opening + 2x thickness of buck) x 2

To estimate bucking materials for door openings calculate:

- height of opening + thickness of buck) x 2
- (width of opening + 2x thickness of buck) x 1











Figure 3.2.2 Pouring concrete into an ICF basement using a pump truck and flat hose.

3.3 ESTIMATING CONCRETE VOLUME

Estimate the required concrete volume by the following calculation: Divide total square footage of wall to be formed, including corners, by 80, 53 or 40 (for 4", 6" or 8" forms, respectively). This equals the number of cubic yards of concrete required. Add 1-1/2 to 2 additional yards for priming the pump and potential waste or spillage. You do not want to be short on concrete. Delays are too expensive on manpower and pump costs. See Section 10.2 of this manual for concrete mix design. It is also possible to multiply blocks by type by concrete volume, and add that volume together. The above method is faster and more straightforward.

BUILDBLOCK TECHNICAL & INSTALLATION MANUAL

FORM (HEIGHT 16 IN)	CORE	AREA	CONCRETE VOLUME
 Straight	4 in 101	5.33 ft ² .4951 m ²	.065844 yd ³ .050341 m ³
	6 in 152 mm	5.33 ft ² .4951 m ²	.098765 yd ³ .075511 m ³
	8 in 203 mm	5.33 ft ² .4951 m ²	.131687 yd ³ .100682 m ³
 90° Corner	4 in 101	5.56 ft ² .5165 m ²	.054574 yd ³ .041725 m ³
	6 in 152 mm	6.00 ft ² .5574 m ²	.086528 yd ³ .066155 m ³
	8 in 203 mm	6.44 ft ² .5983 m ²	.121517 yd ³ .092906 m ³
 45° Corner	4 in 101	4.89 ft ² .4542 m ²	.054985 yd ³ .042039 m ³
	6 in 152 mm	4.89 ft ² .4542 m ²	.080841 yd ³ .061807 m ³
	8 in 203 mm	4.89 ft ² .4542 m ²	.105425 yd ³ .08060 m ³
 Brickledge	6 in 152 mm	4 ft ² .3716 m ²	.134140 yd ³ .102557 m ³
	8 in 203 mm	4 ft ² .3716 m ²	.167074 yd ³ .127737 m ³
 Double Taper Top	6 in 152 mm	5.33 ft ² .4951 m ²	.130128 yd ³ .099489 m ³
	8 in 203 mm	5.33 ft ² .4951 m ²	.163050 yd ³ .124660 m ³
 BuildLock Knockdown Straight	4 in 101	5.33 ft ² .4951 m ²	.065844 yd ³ .050341 m ³
	6 in 152 mm	5.33 ft ² .4951 m ²	.098765 yd ³ .075511 m ³
	8 in 203 mm	5.33 ft ² .4951 m ²	.131687 yd ³ .100682 m ³
	10 in 254 mm	5.33 ft ² .4951 m ²	.164609 yd ³ .125852 m ³
	12 in 304 mm	5.33 ft ² .4951 m ²	.197529 yd ³ .151022 m ³
 BuildLock Knockdown 90° Corner	10 in 254 mm	6.88 ft ² .6391 m ²	.151444 yd ³ .115787 m ³
	12 in 304 mm	7.33 ft ² .6809 m ²	.191408 yd ³ .146341 m ³
NOTE: 4in–8in corners use existing dedicated BuildBlock corners.			
 GlobalBlock Straight	4 in 101 mm	5.33 ft ² .4951 m ²	.043906 yd ³ .050341 m ³
	6 in 152.4 mm	5.33 ft ² .4951 m ²	.062947 yd ³ .075511 m ³
	8 in 203.2 mm	5.33 ft ² .4951 m ²	.088959 yd ³ .100682 m ³
 GlobalBlock 90° Corner	4 in 101.6 mm	7.55 ft ² .7023 m ²	.040423 yd ³ .038863 m ³
	6 in 152.4 mm	8.00 ft ² .7432 m ²	.086528 yd ³ .064701 m ³
	8 in 203.2 mm	8.44 ft ² .7841 m ²	.121517 yd ³ .097978 m ³

3.4 CHOOSING THE RIGHT REBAR

Reinforcing Bar (Rebar), also known as reinforcing steel, reinforcement steel is a steel bar or mesh of steel wires used as a tension device in reinforced concrete and reinforced masonry structures to strengthen and hold the concrete in tension. Rebar's surface is often patterned to form a better bond with the concrete.

REBAR GRADE



Rebar comes several standard grades, the two most common grades are 40 and 60. This refers to the tensile strength in thousands of pound per square inch, so grade 60 has a tensile strength of 60,000 psi. The size of rebar is indicated in increments of 1/8" (inch), so a #3 rebar is 3/8" in diameter and so forth. While grade 60 rebar is stronger than grade 40, it is also harder to bend. Grade 60 rebar is the preferred rebar choice unless specified by site specific engineering.

In the engineering of steel, the size and grade must be taken into account. Make sure you calculate steel size and grade according to engineering tables or your engineer's specifications.

Note: Rebar spacing may be increased when taking into account stronger concrete and stronger or larger rebar. Many older tables assumed a weaker concrete and weaker rebar. The tables should include a conversion factor for your calculations.

IMPERIAL REBAR SIZES

Imperial bar sizes represent rebar stick diameters in fractions of an inch, such that #8 = 8/8 inch = 1 inch diameter.

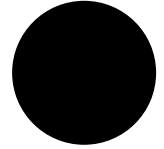
SIZE	ACTUAL SIZE	GRADE
#3 (3/8")		40,60
#4 (1/2")		40, 60
#5 (5/8")		40, 60
#6		40, 60

Rebar size is determined by the Bar # multiplied by .125". The grade indicates the minimum yield strength of the steel in 1000 psi or ksi. Grade 60 = 60,000 psi, Grade 40 = 40,000 psi. Grade 60 rebar is 50% stronger than grade 40.

BUILDBLOCK TECHNICAL & INSTALLATION MANUAL

ADDITIONAL REBAR SIZES

Bar Size	"Soft" Metric Size	Weight (lb/ft)	Nominal Diameter (in)	Nominal Diameter (mm)	Nominal Area (in ²)
#3	#10	0.376	0.375	9.525	0.11
#4	#13	0.668	0.500	12.7	0.20
#5	#16	1.043	0.625	15.875	0.31
#6	#19	1.502	0.750	19.05	0.44
#7	#22	2.044	0.875	22.225	0.60
#8	#25	2.670	1.000	25.4	0.79
#9	#29	3.400	1.128	28.65	1.00
#10	#32	4.303	1.270	32.26	1.27
#11	#36	5.313	1.410	35.81	1.56
#14	#43	7.650	1.693	43	2.25
#18	#57	13.60	2.257	57.33	4.00

The grade indicates the minimum yield strength of the steel in 1000 psi or ksi. Grade 60 = 60,000 psi, Grade 40 = 40,000 psi. Grade 60 rebar is 50% stronger than grade 40.

METRIC REBAR SIZES

Metric bar designation represents the specified rebar stick diameter in millimeters, rounded to the nearest 5 mm.

Bar Size	Mass (kg/m)	Nominal Diameter (mm)	Cross-Section Area (mm ²)
#10 M	0.785	11.3	100
#15 M	1.570	16.0	200
#20 M	2.355	19.5	300
#25 M	3.925	25.2	500
#30 M	5.495	29.9	700
#35 M	7.850	35.7	1000
#45 M	11.775	43.7	1500
#55 M	19.625	56.4	2500

The grade indicates the minimum yield strength of the steel in 1000 psi or ksi. Grade 60 = 60,000 psi, Grade 40 = 40,000 psi. Grade 60 rebar is 50% stronger than grade 40.

3.5 ESTIMATING REBAR

Reinforcing rebar is placed vertically and horizontally in an ICF wall. The size and spacing of the reinforcement is specified by one of two methods: Tables from your structural engineer or our engineered rebar tables.

BuildBlock also recommends the "Prescriptive Method for Insulating Concrete Forms in Residential Construction, Second Edition," as a guide to help assist you with reinforcement and other construction details. Please note the calculations in the Prescriptive Method assume a weaker concrete mix and smaller diameter rebar. In the footnotes of the table, there is a multiplier to help calculate the correct rebar requirements using 3,000 LB or stronger ICF concrete and rebar. This can be found at <http://buildblock.com/technical-support/technical-resources/>

LAP SPLICES

A lap splice occurs where two pieces of reinforcing bar are overlapped to create a continuous line of reinforcement. The length of the lap varies depending on concrete strength, the bar grade, size, and spacing. There are two types of lap splices: contact and non-contact.

A contact splice occurs when two pieces of rebar are overlapped and tied together. The tying of the rebar together prevents any movement and creates a continuous line of reinforcement throughout the structure.

An overlap splice occurs when two pieces of rebar overlap, but are not tied together. This saves time and labor, but there are strict tables regarding the spacing of the rebar and overlap length.

The minimum overlap to create a lap or contact splice is 40 x (bar diameter) unless bars are connected with a mechanical rebar splice connector.

Example

- #4 (1/2") x 40 diameters = 20"
- #5 (5/8") x 40 diameters = 25"

The BuildBlock ICF web is designed with deep rebar fingers to hold two #5 rebar on top of each other to make using the contact lap method easy and straightforward.

The bar capacity of the BuildBlock webs increases with the concrete core width.

BASIC REBAR ESTIMATION FORMULA

The Basic formula to figure rebar is as follows:

(In this example, the reinforcing was specified as 1/2" (or #4) rebar on 18" on center (or 1.5') vertically, and in each course horizontally with a 2' overlap on the horizontal ends.) Make sure you overlap all steel ends no less than 40 diameters of steel size used. In high seismic zones and other areas the overlap may be 48 diameters of steel size used. Please verify existing codes or any site specific engineering before estimating rebar.

Example:

- #4 (1/2") x 40 diameters = 20"
- #5 (5/8") x 40 diameters = 25"

HORIZONTAL REBAR FORMULA

Linear ft. of perimeter of structure / 18 ft. (covers 2' overlap) x number of courses for horizontal.

This gives you the number of 20 ft. sticks of rebar, the standard length available from most suppliers.

Note: Depending on engineering, horizontal rebar may be used every other course, but must be on the first and last courses and 1/3 points of the remainder of wall.

Example: Every other course

- 350 lineal ft. project / 18' = 19.4 bars per course (~20)
- 20 Bars per course x 5 courses = 100 horizontal 20' bars

BUILDBLOCK TECHNICAL & INSTALLATION MANUAL

VERTICAL REBAR FORMULA

Linear ft. / 1.5' plus 1 bar extra for each 90° corner and 2 bars on each side of a window and both sides of all doors. Divide by 2 if 24" centers are desired. All vertical bars must be the height of the wall less 1-inch. Cutting vertical rebar 1" shorter than the wall height prevents rebar from extending above the concrete pour and interfering with the top plate. Remember during the pour, that all walls will compress slightly.

The rebar may be taller if continuing to another level above.

Example:

- 350 lined ft. / 1.5' = 234 vertical rebar + number of corners + windows and doors x 2 = total vertical rebar.

Always order a few extra bars of rebar.

Note: Cut vertical rebar 1" short of the wall height to prevent rebar coming up through your top plate. If building another level on top of this level, cut the rebar 24" longer for overlap into the next floor for #4 rebar 30" for #5 rebar.

Some installers choose to cut rebar to the wall height less 1" for the first level regardless of other levels above. They believe the taller vertical rebar impedes pouring the wall. Once poured, they place 4' or longer vertical rebar in the wet concrete to tie the next level together.

This requires additional steel, but may be helpful.



Figure 3.5.1 Lintels above multiple door and window openings in a residential home.

LINTEL FORMULA

Determining Lintels are based on several factors:

- Opening width
- Lintel Depth
- Loads
- Concrete thickness
- Concrete strength

The horizontal compression and tension bars can be calculated using Prescriptive Design Requirements or engineering tables.

BuildBlock recommends extending these bars a minimum 2'-0" beyond each side of the opening. Stirrups, if required, are most commonly made using #3 Bar. (3/8") " C " Stirrups are

most commonly used and have specific spacing criteria that must be followed to maintain the integrity of the lintel.

Lintels require extra rebar. Order enough bulk #3 rebar to meet your needs according to the tables you are using. Calculate horizontal lintel bars from engineering tables or prescriptive method tables.

Note: Lintel steel needs to be wider than opening width by 24" minimum into each side of the opening.

BUILDBLOCK TECHNICAL & INSTALLATION MANUAL

This page left intentionally blank.

BUILDBLOCK TECHNICAL & INSTALLATION MANUAL



Figure 4.1.1 Typical footing layout with vertical rebar dowels placed.

SECTION 4: FOOTINGS

4.1 FOOTING LAYOUT

Footings or footers are one of the most important structural components of a home or building. In most cases, the footer is the only part of the structure that touches the earth. Footers are commonly called spread footers because they spread the weight of the structure over an area wider than the structure's walls.

Nearly all projects will begin by installing a footing or foundation under the structure you are planning to build. In order to do this properly, you will need to familiarize yourself with a layout method that ensures proper placement and accurate squaring of the project.

The use of levels or a laser will help you in the layout process. There are several methods you can apply to achieve your layout. Here are some popular methods. Height x Run = Square Dimension

PYTHAGOREAN THEOREM (3-4-5 METHOD)

This age old formula is used often to find the third side of a right triangle when two sides are known.

Example

A=25'
B=42'-8"

If you have a measurement that has inches built along with feet like B, then divide the inches by 12 and that would give you 42.666667.

Now multiply A and B by themselves you get the square of those sides.

A) $25 \times 25 = 650$ B) $42.666 \times 42.666 = 1,820.0729$

Add those squared numbers and you get 2,445.729.

If you use square root symbol on your construction calculator you get 49.45431.

Now find your inches: $0.45431 \times 12 = 5.45$ " (or 5-1/2")

H=49'-5-1/2"

With a construction calculator, enter A as the rise then enter B as the run and push "Square" or "Diagonal", the answer will be your diagonal H dimension.

Another way to get a 90° angled corner is to use the framers method: Leg A is set to 3 ft, leg B is set to 4 ft, and H is set to 5 ft. This will give you a 90° angle. Be careful to use Diagonal Squaring to double check your layout before digging or setting blocks. These distances can be multiplied by 10 to be more accurate on a larger layout.

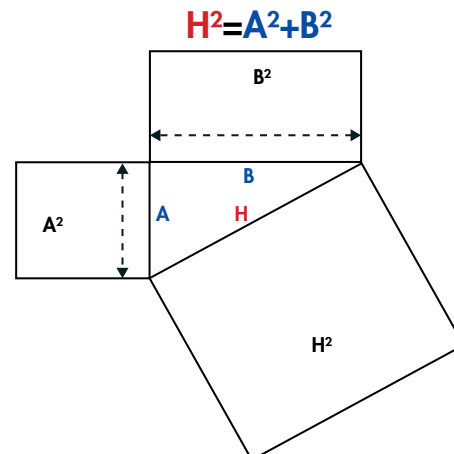

Figure 4.1.2 Pythagorean Theorem (3-4-5) Method.

BUILDBLOCK TECHNICAL & INSTALLATION MANUAL

DIAGONAL SQUARING

A method of squaring a box or rectangle by measuring the diagonals of a square and adjusting the square until the diagonal length is even. Note: This allows us to make a perfect square box or rectangle. In order for this method to work, both A sides must be the same length and both B sides must be the same length before measuring the diagonal measurements C and D.

To adjust the square, when C and D are not equal, two points on a given line will have to be adjusted left or right or up and down until C and D are equal in length. Re-check A and B sides to maintain correct dimensions.

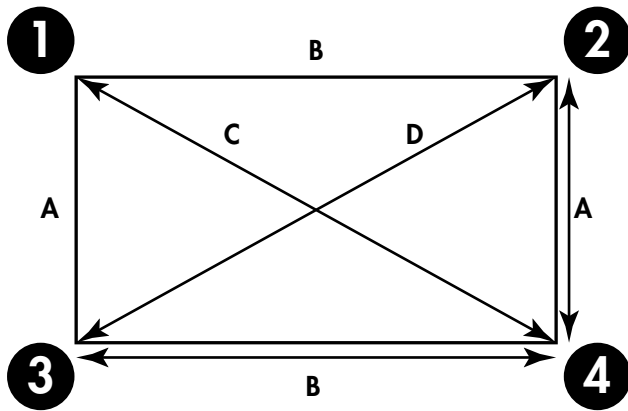

Figure 4.1.3 Diagonal Squaring Method

Note: BuildBlock forms are designed in 1" increments. Using 1" spacing on your wall layouts will eliminate waste and keep all cuts on factory cut lines. To apply this concept even further, consider the ICF block dimensions and corner returns and design your project to eliminate most every block cut.



Figure 4.1.4 Excavated Footprint for footings.



Figure 4.1.5 Formed footings with horizontal rebar placed in per local codes.



Figure 4.1.6 Pour footings and ensure good consolidation and a smooth finish.



Figure 4.1.7 Level footings to the correct height and ensure a smooth finish.



Figure 4.1.8 Place vertical rebar dowels with the correct height to join in the ICF wall.



Figure 4.1.9 A smooth level finish will make stacking and leveling the ICF wall easier.

BUILDBLOCK TECHNICAL & INSTALLATION MANUAL

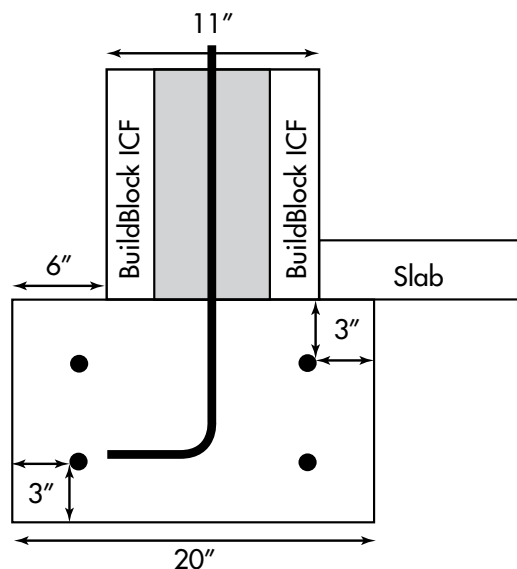

Figure 4.2.1 Typical site excavation staked for square

4.2 EXCAVATION & FOOTINGS

The excavation of footings or foundations for ICF structures is a very important step to an overall successful building experience. Having good communications with your backhoe operator insures your ditch markings will be interpreted and dug properly. For instance, some operators like to use a center line as their basis, some an outer edge. Also, knowing what type of veneer will be used on the structure will help with ICF block placement over the width of the footing to be dug.

An example would be a 6" ICF wall: Total thickness 11" plus a brick ledge, another 6" to the outside of the form, and an additional 3" to the inside of the form for the floating slab to rest or be pinned to. By taking into account these factors, you will obtain an accurate outside wall measurement on the footing and allow for placement of the form, avoiding structure shrinkage or expansion due to misplaced footings, which can be costly and time consuming to fix.



ICF Footing Example using BuildBlock BB-600 6" forms.
ACI 318 requires all rebar in concrete touching soil have at least 3-inches of concrete cover.

Figure 4.2.2 Rebar Footing Design

It also sets the stage for proper rebar placement at the footing first course stage and for lateral support at the base of your ICF structure. This placement is of a crucial nature because of the webs in the forms. You ideally want the rebar in the center of the form and centered between the webs.

Use block dimensions in this manual to place rebar in ideal locations. This may also be achieved using the "Wet Set" method. **This method should only be used by professionals.** Depending on type of construction used in your area, please review our construction details to match your building method.

Note: Dug in ground footings are never perfectly straight. Please take this into account when you need a brick ledge or slab ledge as in the drawing above. If you don't leave some extra width, there will be places which are not wide enough for these applications.



Figure 4.2.2 Formed and reinforced footings ready for pouring.

BUILDING FOOTINGS TO APPLICABLE CODES

Footings distribute loads from the structure to the ground and in most cases are either specified by an engineer or architect. They are regulated, standardized and inspected by local building code officials. They vary dramatically across the country. If you are planning to build in an area that has no restrictions regarding footing size and reinforcing standards, BuildBlock recommends you seek a local structural engineer to specify your load requirements and footing sizings.

This step will avoid costly structural problems and assure your structure sits on a proper foundation for your soil conditions. Keep in mind there are a variety of factors that play into the design of a foundation. Most building professionals seek the services of a structural engineer: So should you!

BUILDBLOCK TECHNICAL & INSTALLATION MANUAL

CONCRETE FOOTING CONSIDERATIONS FOR ICF WALLS

There are a variety of factors that play into the design of a foundation:

- Soil Bearing Capacity and Soil Type
- Structure Loading
- Code Compliance
- Proper Reinforcing
- Frost Lines
- Moisture Control

BuildBlock highly recommends the consultation of a structural engineer familiar with your region's soil load bearing capacities for accurate footing designs. Because different engineers recommend various footing thicknesses and widths, we are providing two footing charts for your convenience

BUILDBLOCK SUGGESTED MINIMUM CONCRETE FOOTINGS FOR ICF WALLS

BuildBlock provides the following information about footing sizes. Refer to local codes or site specific engineering for best results.

ABOVE GRADE		LOAD BEARING VALUE OF SOIL (PSF) ONE STORY				
PROFILE	RT. (PLF)	1,000	1,500	2,000	2,500	3,000
BB-400	1,590	w=20" h=10"	w=20" h=10"	w=16" h=8"	w=16" h=8"	w=16" h=8"
BB-600	1,590	w=20" h=10"	w=20" h=10"	w=13" h=8"	w=16" h=8"	w=16" h=8"
BB-800	1,790	w=22" h=12"	w=22" h=12"	w=18" h=8"	w=16" h=8"	w=16" h=8"

ABOVE GRADE		LOAD BEARING VALUE OF SOIL (PSF) 2 STORY				
PROFILE	RT. (PLF)	1,000	1,500	2,000	2,500	3,000
BB-400	3,130	w=38" h=12"	w=28" h=12"	w=20" h=10"	w=16" h=8"	w=16" h=8"
BB-600	3,130	w=38" h=12"	w=28" h=12"	w=20" h=10"	w=16" h=8"	w=16" h=8"
BB-800	3,550	w=43" h=13"	w=32" h=12"	w=24" h=12"	w=19" h=10"	w=16" h=9"

BELOW GRADE		LOAD BEARING VALUE OF SOIL (PSF)				
PROFILE	RT. (PLF)	1,000	1,500	2,000	2,500	3,000
BB-400	3,130	w=38" h=12"	w=28" h=12"	w=20" h=10"	w=16" h=8"	w=16" h=8"
BB-600	3,130	w=38" h=12"	w=28" h=12"	w=20" h=10"	w=16" h=8"	w=16" h=8"
BB 800	3,550	w=43" h=13"	w=32" h=12"	w=24" h=12"	w=19" h=10"	w=14" h=9"

BELOW GRADE		LOAD BEARING VALUE OF SOIL (PSF) 2 STORY				
PROFILE	RT. (PLF)	1,000	1,500	2,000	2,500	3,000
BB-400	4,670	w=56" h=16"	w=36" h=14"	w=28" h=12"	w=23" h=11"	w=18" h=8"
BB-600	4,670	w=56" h=16"	w=36" h=14"	w=28" h=12"	w=23" h=11"	w=18" h=8"
BB-800	5,310	w=64" h=18"	w=43" h=15"	w=32" h=13"	w=26" h=12"	w=22" h=11"

Note: BuildBlock Building Systems assumes no liability for foundation requirements. Every geography has different soil and seismic conditions. These charts are for reference only. This chart assumes 3,000 PSI Concrete. For walls larger than 8-inches and veneer walls, consult your engineer.

BUILDBLOCK TECHNICAL & INSTALLATION MANUAL

PRESCRIPTIVE CODE MINIMUM CONCRETE FOOTINGS FOR ICF WALLS

The following chart is from the Prescriptive Method for Insulating Concrete Forms in Residential Construction (Second Edition).

TABLE 3.1
MINIMUM WIDTH OF ICF AND CONCRETE
FOOTINGS FOR ICF WALLS^{1,2,3} (inches)

MAXIMUM NUMBER OF STORIES ⁴	MINIMUM LOAD-BEARING VALUE OF SOIL (psf)				
	2,000	2,500	3,000	3,500	4,000
5.5-Inch Flat, 6-Inch Waffle-Grid, or 6-Inch Screen-Grid ICF Wall Thickness⁵					
One Story ⁶	15	12	10	9	8
Two Story ⁶	20	16	13	12	10
7.5-Inch Flat or 8-Inch Waffle-Grid, or 8-Inch Screen-Grid ICF Wall Thickness⁵					
One Story ⁷	18	14	12	10	8
Two Story ⁷	24	19	16	14	12
9.5-Inch Flat ICF Wall Thickness⁵					
One Story	20	16	13	11	10
Two Story	27	22	18	15	14

For SI: 1 foot = 0.3048 m; 1 inch = 25.4 mm; 1 psf = 47.8804 Pa

¹Minimum footing thickness shall be the greater of one-third of the footing width, 6 inches (152 mm), or 11 inches (279 mm) when a dowel is required in accordance with Section 6.0.

²Footings shall have a width that allows for a nominal 2-inch (51-mm) projection from either face of the concrete in the wall to the edge of the footing.

³Table values are based on 32 ft (9.8 m) building width (floor and roof clear span).

⁴Basement walls shall not be considered as a story in determining footing widths.

⁵Actual thickness is shown for flat walls while nominal thickness is given for waffle- and screen-grid walls. Refer to Section 2.0 for actual waffle- and screen-grid thickness and dimensions.

⁶Applicable also for 7.5-inch (191-mm) thick or 9.5-inch (241-mm) thick flat ICF foundation wall supporting 3.5-inch (88.9-mm) thick flat ICF stories.

⁷Applicable also for 9.5-inch (241-mm) thick flat ICF foundation wall story supporting 5.5-inch (140-mm) thick flat ICF stories.

BUILDBLOCK TECHNICAL & INSTALLATION MANUAL

STEP FOOTINGS

A step footing or footing is one that's poured at different levels to transition from one ground height to another. If you transition in several steps, it resembles a set of stairs from one level to the next as the footer changes elevation with the ground.

This type of footing is necessary when a building is constructed on sloped ground, or when part of the building will not have a full foundation. A home with a walkout basement or a basement and an attached garage would both potentially use a step footing to ensure the different levels of the home are built on undisturbed soil and that all footings are at the appropriate depth to prevent any soil heaving due to frost.

Many times when constructing a step footing the transition isn't in increments of 16" or a full block height. One of the outstanding features of a BuildBlock form is its completely symmetrical web design. This means two identical half-height forms are produced when the form is cut in half horizontally. This feature is particularly useful for step

footings — an elevation change at the footing level.

Plan your step footings in increments of one-block height (16") or half-block height (8"). When using half-height blocks, place the cut side of the block on the bottom to interlock with courses above. This will ensure an easy transition maintaining form alignment and eliminates waste.



Figure 4.3.3 Building a Step Footing. Notice the horizontal rebar extending from the higher footing to tie the horizontal block to the footing.

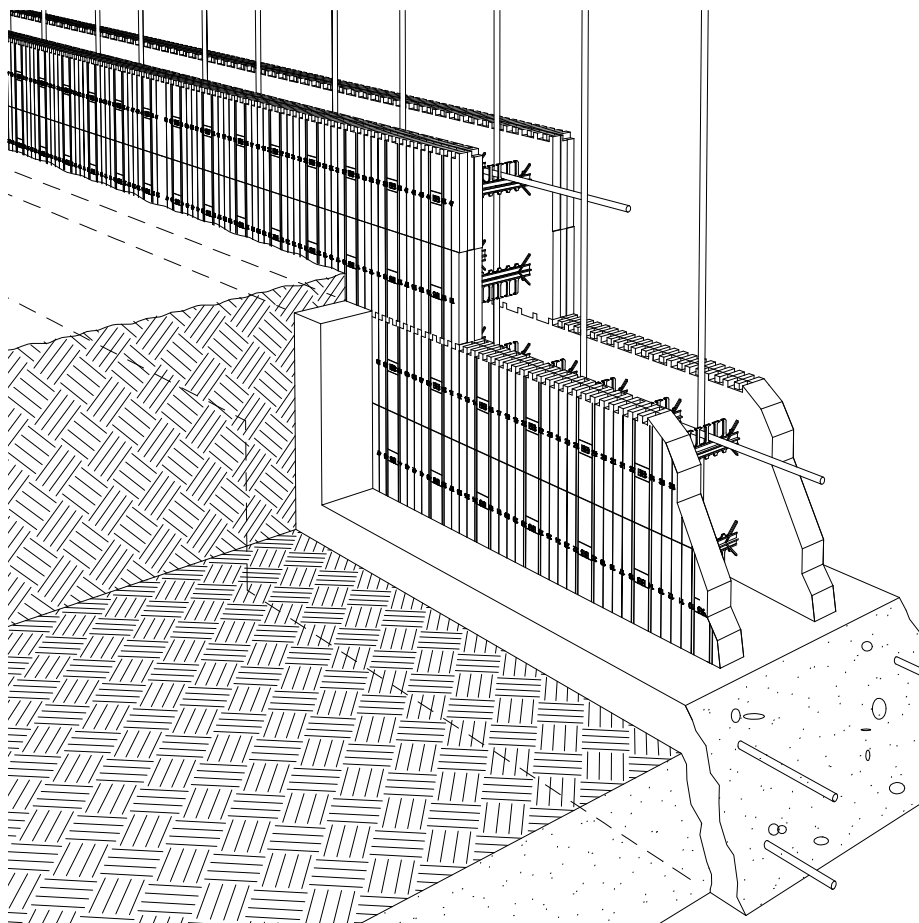

Figure 4.3.4 Step footing transition using full height blocks. Built-in half-height blocks may also be used for smaller transitions, putting the cut side down.

BUILDBLOCK TECHNICAL & INSTALLATION MANUAL



Figure 4.3.1 Stacking first two courses starting from a corner and working in a single direction.

4.3 FIRST COURSE PLACEMENT

There are two methods by which to create a footing and first course connection. Applications differ regionally, but all will either employ a dry stack or wet set process. See the CAD details about the method you will use. Keep in mind, all the CAD details can be constructed using either method.



Figure 4.3.2 First two courses leveled and spot glued using foam adhesive. Use small amounts to prevent lifting the wall. Add additional adhesive after spot glue sets if desired.

DRY-SET OR "GLUE DOWN" METHOD

The dry set method relies on a finished footing or slab that is level, clean, and has vertical rebar placed properly. Most ICF

professionals use foam adhesive to secure the blocks to the surface. It works well and will hold the base of your block in place. For an extra edge secure a 2x4 to the outer base of the block for extra support or a guide.

This method does not come with the sense of urgency a wet-set might encounter and can be leveled as you go with shims. (See CAD Detail 20.)

Before spot gluing the blocks to the footing, stack two full courses of block. This tightly locks all blocks together, assures a proper fit, and keeps any other adjustments relatively minor. Once the two courses are stacked, shim and trim the wall at the bottom to ensure it is level. Many builders choose to find the average point in the footing and work with shims to level the blocks. Choose a point that requires less work and will yield good results.

Once that is done, spot glue the blocks with a small amount of adhesive. **LESS IS BEST.** Too much adhesive could lift the blocks as it expands. A small dab of foam every 18-24 inches will be enough to hold the blocks in place. After the spot glue has set, you can add additional adhesive if desired.

A few hours before the pour, glue the blocks fully to the foundation by running a full bead of foam along each side of the blocks. This will secure the blocks to the footing before the pour or before stacking the remaining courses, but ensure blocks are level and plumb before doing so. For complete dry-set details see Section 4.5.



Figure 4.3.3 Placing corner forms during a wet set. (See CAD Details 6, 7 and 8.)

WET-SET METHOD

A wet-set is a method by which you place the first course of BuildBlock ICFs into a freshly poured and properly leveled footing as a footprint or stem course. This method creates a water stop at the footing, allows for proper rebar placement through the webs and into the footing, and allows the installer to level the first course of block into the footing as opposed to leveling the footing to exacting standards. This method also (if used as a stem course) gives the job an insulated stem wall.

Please note: Footing must be level to within 1/2" for a proper wet-setting of forms. **This method is complex and recommended for seasoned professionals only.** For complete wet-set details see section 4.6.

BUILDBLOCK TECHNICAL & INSTALLATION MANUAL



Figure 4.3.4 Wet set BuildBlock ICF stem wall. The first course is square, stacked, and poured. The site is now ready for the slab to be poured. Notice the rebar extending at least 24" vertically and the clean interlocks so the next course can be stacked.

STEM REINFORCING REBAR

BuildBlock strongly recommends the use of local structural engineers and the Prescriptive Method for Insulating Concrete Forms Vol. II for reinforcing guidelines attributed to your local codes and project particular specifications. The first and last course of your wall and remaining 1/3 points must have horizontal rebar placement as per recommendations set forth by those guidelines and specified by local codes.

As you place your horizontal steel, do so in a staggered, inside to outside manner, so a space will be available for your vertical rebar to thread through downwards after the wall is stacked. This creates a "vertical chase" and will allow you to install more easily the vertical rebar after the wall is stacked and to maintain proper spacing. The time savings versus tying steel is considerable.

Note: Check with your local inspector or engineer to be sure this procedure is allowed or recommended. Some installations or engineering may require all horizontal steel to be placed to the outside or inside portion of the wall.

Having your steel dowel pre-bent and ready to stab into the footing is helpful. Layout the steel around the perimeter along with the block so you can "grab and stab" as you place the block. Figure 4.3.4 shows a wet-set stem with the rebar placed as illustrated in Figure 4.3.5 for brickledge dowel placement. If you are not doing a wet set, you will have to align and properly place the steel coming out of the footing so that it lines up properly within the blocks.

TIPS: If applicable in your area, you can cut 1 1/4" PVC pipe into 1" height rings and place them over your stem rebar before

you stack the walls. This is a neat trick for holding your vertical rebar in place at the base of the wall when stabbing vertical steel on the wall is stacked.

Alternating horizontal rebar position to create a vertical rebar pocket results in restraining the vertical bars between the horizontal bars maintaining required ACI 318 rebar placement eliminating most rebar tying. Please check with local inspectors first. Some will not allow this method.

REBAR FOOTING DOWEL/PIN PLACEMENT

In the example below, the footing is 20" wide and the rebar is placed on 12" OC. The brick ledge is 6" to the outside of the block. (Note: The two corner pin placements are crucial to a good layout.)

- For center of block pins, the measurement is 11-1/2" from outer edge of footing or 8-1/2" from edge of block or wall.
- For the two corner pins, the measurement is 14-1/2" one direction and 11-1/2" the other direction for each pin.
- For the corner web steel, the measurement is 11-3/4" both ways.
- If using 8" block, adjust measurements accordingly.

BRICK LEDGE FOOTING DOWEL PLACEMENT

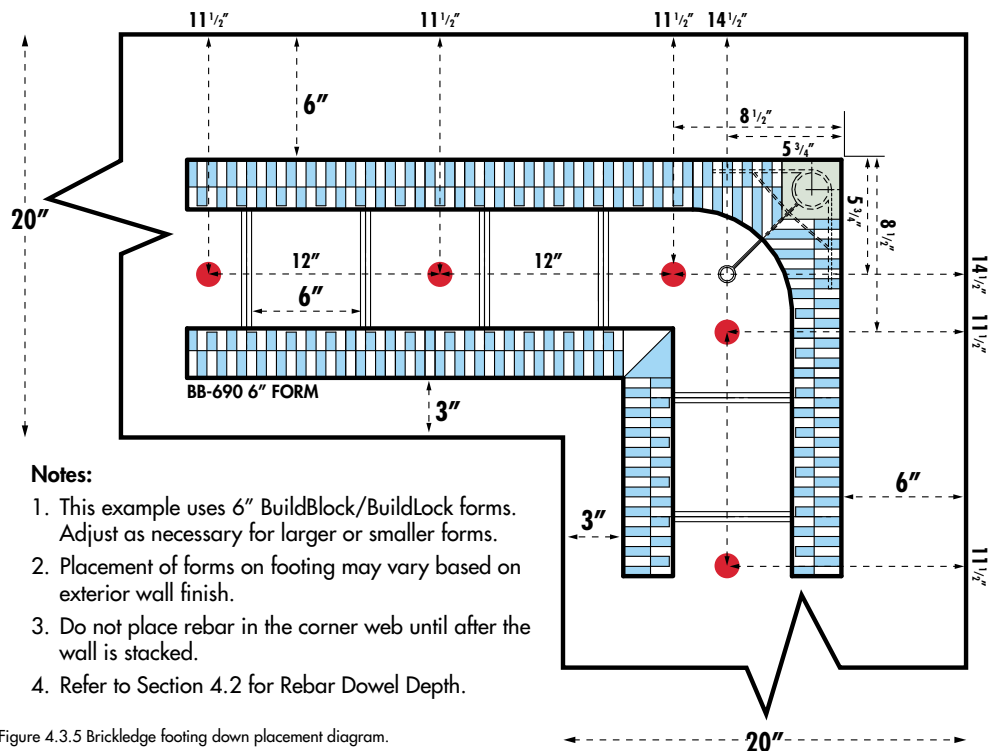

Notes:

1. This example uses 6" BuildBlock/BuildLock forms. Adjust as necessary for larger or smaller forms.
2. Placement of forms on footing may vary based on exterior wall finish.
3. Do not place rebar in the corner web until after the wall is stacked.
4. Refer to Section 4.2 for Rebar Dowel Depth.

Figure 4.3.5 Brickledge footing down placement diagram.

Note: The use of two corner pins is not required but helps in setting the rebar into the proper position when the block is not wet-set. If using outer corner pins for the stem only, you can eliminate them in the upper walls and use the corner web placement point only. When using a brick ledge center on footing, Do not include brick width.

BUILDBLOCK TECHNICAL & INSTALLATION MANUAL



Figure 4.4.1 Footings formed with horizontal rebar in place.

4.4 POURING FOOTINGS

To set concrete pour height to level install #3 rebar pins every 3 to 4 feet with level to your pour height. Pour and level concrete to these pins. When footings are dug and rebar is placed and tied, you are ready for a footing inspection and a call to your local concrete provider. Here are some things to keep in mind during this phase:

Most code officials require a "Pre-Pour" inspection before the footing and pads are poured to ensure that rod and footings are installed as specified and comply with local codes.

- When digging your foundation your footings need to be accessible by a concrete truck. If you cannot get the truck chute to the footings a concrete pump is need or the old fashion way, using a wheelbarrow to pour. Bring extra wheelbarrows and some strong backs as the redi-mix plant charges for extended time on the site. If using a concrete pump you'll have to order your mud as a pump mix.
- Don't wet your mud too much, it weakens the mix considerably — a bad thing for structural concrete! Instead a higher slump, or wetter concrete should be attained by the use of a water reducer additive. This will give you a flowable pour without losing strength of your concrete as adding just water will do. This also makes it easier to smoothly level the footing.
- To level a trench or earth formed footing without form boards install #3 rebar pins every 3 to 4 feet with level to your pour height. Pour and level concrete to these pins. Be sure they are secure and stable so they do not come out or move during your pour. A higher slump (wetter concrete) will aid in the leveling process.

- When footings are poured use a jitterbug if wet-setting or a screed to level the footing.



Figure 4.5.1 Stacking ICF walls using spot glued dry set method.

4.5 DRY-SET STEP BY STEP

For a dry stack to be effective, you will need to place your connective rebar in the footing properly so it is in the center of the block void and it is not in the way of the 6" on center webs in the block when you set it.

The dry-set procedure begins with a clean, debris-free footing or slab. Stack two or three courses of block before gluing anything. Beware of the block offset. Make sure there are no vertical seams closer than 12-inches to a corner if possible; preferably a full block.

BUILDBLOCK TECHNICAL & INSTALLATION MANUAL



Figure 4.5.2 Walls stacked, braced, and prepped before pouring walls.

1. Snap outside wall lines on the slab or footing. Make sure your layout is square and correct. You may also snap inside lines once outside lines are placed. This helps since most people work from the inside of the structure.

NOTE: There are two main types of chalk: Red and Blue. Red chalk is permanent and blue chalk is not. You can use blue chalk if you want and spray it with a clear sealant if you need to prevent it from washing off.

2. Have a plan when stacking blocks and make sure everyone doing the stacking knows the plan. Typically blocks are either started at the corners and work toward a common seam within a door or window or they begin at one corner and continue working around the site until they finish. Look at plan dimensions and choose a method that will work best for your project.
3. Keep blocks aligned to the chalk line to ensure the wall remains straight.
4. Each wall will most likely have a cut block unless the project was created using ICF friendly dimensions. Locate the cut under a window or in a door opening preferably away from a corner. (Note: You will be removing blocks that are in an opening area after we finish these steps. This process will reduce your install time dramatically and you can reuse the cut pieces later.) If no opening is available, try to place the cut block at least 4 to 6 feet from a corner if possible.
5. Note: It is very helpful at this time to know that if a wall does not fit perfectly in length to your chalk line, minor adjustments to wall lengths are acceptable and will greatly

facilitate the stacking process. This step will allow you to use the standard grid pattern in the BuildBlock forms, eliminating cuts that do not match the factory 1" cut lines in the face of the form. If this is not acceptable, any cut blocks will have to be cut between factory lines giving you a "bastard connection" that will continue vertically with every other course thereafter. Because the corner blocks are reversed for each course, your cuts on these connections will be offset 12" between courses back and forth.

6. It is important to note that EPS blocks continue to shrink a small amount over the first six months from the date of manufacture. The above method will help solve length and size issues. Make sure your rebar pins work out within the walls. Otherwise they will have to be moved and reset with epoxy. This is expensive and time-consuming. This should never happen. Double-check everything.
7. Stack your second course, reversing all corners in the opposite direction from the first course. This will create a one foot stagger on all blocks. This second course locks the blocks together. At this time you can stack a third course or proceed to the next step. Note: If you have windows that are low in the wall, you may want to stop at two courses.
8. Now is the time to attach the two or three course stem or wall to your chalk line, leveling and checking for plumb as you go. (Note: Make sure your rebar pins do not interfere with the placement of your forms. Otherwise some pins may have to be moved and replaced.)

BUILDBLOCK TECHNICAL & INSTALLATION MANUAL

9. Using a level or laser level, level the entire stem to the same height. Use wood shims and foam adhesive to perform this step.
10. It is important to make these courses level as it will haunt you throughout the stacking process if not taken care of here.
11. Remove the forms in the door and window openings at this time. You are ready to install door and window bucks (see Section 8 of this manual) and continue the stacking process.

DRY-SET TIPS

- All bucks should be pre-made to the rough opening size and ready to set into the wall.
- Window bucks rough opening sizes should be 1/2" larger than actual window and door sizes both horizontally and vertically. Most wood framers use 3/8". We recommend 1/2" because concrete will not give after poured and any movement might prevent the window or door to be set without additional work. It is easy to foam any gaps afterwards.
- Before spot gluing the blocks to the footing, stack two full courses of block. This tightly locks all blocks together, assures a proper fit, and keeps any other adjustments relatively minor. Once the two courses are stacked, shim and trim the wall at the bottom to ensure it is level. Many builders choose to find the average point in the footing and work with shims to level the blocks. Choose a point that requires less work and will yield good results.
- Establish your door and window openings with center line markings on the slab or footing. This will allow you to know where to place blocks or rebar. You don't want rebar sticking up through a door opening.
- Pay attention to the details of the rough openings that are provided by your door and window manufacturers, keeping in mind the type of bucking materials and method you decide to use.
- Layout your blocks with the intention to set two courses high, around the perimeter of your structure. Having a man prepare your bucks at this time is an expeditious use of manpower while other team members set the blocks.
- Stagger and apply adhesive only to the outer edge of the block to establish a hinge effect for easy movement with no gluing until you get two courses fit and level if desired.
- An excellent method is to stack two courses locked together before gluing to the slab. This will allow you to adjust wall lengths a little if necessary to stay in factory cut lines. This will eliminate any non-standard cuts or minor block shrinkage and everything will stack out much faster. Note: All ICFs will shrink some with time. Blocks will vary in a very small amount in length over time.



Figure 4.5.3 BuildBlock Build1 ICF bracing and alignment system set up with proper spacing.

BRACING AND ALIGNMENT SYSTEM SETUP

Set up your braces inside or outside the structure on 4 to 6 ft. spacing after the second or third course is placed. All though BuildBlock corners are designed larger to help keep walls from moving, it's always a good practice to secure your corners with bracing each way from the outside to maintain plumb.

Applying horizontal bracing or strapping across window and door openings and short walls will also assist in keeping the blocks secure during a pour.

See more details about ICF bracing and alignment in Section 9 of this manual.

BUILDBLOCK TECHNICAL & INSTALLATION MANUAL

4.6 WET-SET PREP

1. Plan ahead to have plenty of help on hand for the pouring.
2. Reset your string or laser lines for outer wall width. Set your height to 15-1/2" above the footing as 1/2" of the form goes into the concrete.
3. Pre-build some large corners by gluing a straight to the short side of a corner and distribute them to all corners of the job.
4. Try using a block on top and bottom of the two you glue together to hold it in place while it dries, therefore eliminating strapping or the use of bungee cords to hold these together. Don't allow glue near these connections or you won't get them apart.
5. If you have long runs, glue two blocks together to make larger sections to set at once. Distribute around perimeter.
6. Distribute your rebar dowels around the site so you can access them easily. These should be set as you stage the block.
7. Make sure you have concrete trucks spaced with enough time so you can set blocks as you go. Otherwise the concrete will set up and you will not be able to wet set blocks or stab the steel rebar pins. The temperature will affect set times greatly.
8. Two or more people need to be available to pour and level concrete while two people set blocks behind them.



4.4.3 Wet set blocks placed with vertical & horizontal rebar

WET-SET — STEP BY STEP

1. Set up all string lines per plans to wall first course top outside edge. String height should be 15-1/2" above finished footing or slab height. This allows the first course to be set 1/2" into the wet concrete. Adjust string height according to concrete mix design and/or slump. Larger aggregate size and particular mix designs may be harder to push the block into the concrete for setting. It is also advisable to place string lines about 1/8" away from the wall outside edge to avoid blocks touching the string line and pushing or misaligning the wall and keeps blocks off the string lines.
2. Start at any corner pouring concrete and setting block. Work down a wall side to a window or door opening. Work from the other corner of this wall back to the window or door opening.
3. Where the walls meet, you will have irregular cuts. Try to line them up in door and window openings if you can.
4. Re-check previously set block for movement from wind and such as you go until the concrete sets securely.

5. Stab the dowels to your established specifications (12" OC - 18" OC, etc.) as block are set in each wall length. This is very important to complete before the concrete sets..
6. Stab your dowels to the base of the footing and then pull them up 2"-3" from the bottom of the footing. Wiggle them slightly to consolidate concrete around the bar.
7. After your wet-set has hardened, you are ready to establish your door opening thresholds if using a slab on grade application. Find your openings and remove 3-1/2" of both sides of the foam. Try to keep the web cross-through in place. Keep in mind when you cut rough openings you will need to make the opening large enough to accommodate not only the window or door but the bucking materials and jams if required. Use the foam you removed to bulkhead the ends of the opening you cut out.
8. It is vital to protect the tops of your new stem from concrete spills. See TIP on the next page and the red arrows for overspill damage to connections in the photo below.

9. When you feel the wet-set stem blocks have had time to dry (sometimes the same day but usually the next), use a small trailer pump and fill the stem with a 3/8 chip mix 3000 PSI or greater concrete mix (see Section 10.2 for concrete design mix). When pouring leave slightly rough and leave stem slightly less than full. This helps avoid getting concrete in the connections which would make block stacking impossible.
10. Screw a 2x6 to the outside of the door openings you have made and level with the top of the stem, so when the slab guys come they will pour over your block cut out to the 2x6 to create a concrete threshold for all door openings.
11. Now you're ready for the plumbers, heat and air, and slab.
12. If applicable, now place the 1-1/4" x 1" PVC rings you cut over each vertical rebar dowel.
13. If you are making a crawl space stem wall, follow above procedures. Adjust additional courses to desired height and figure your block heights along with the ability to use half blocks to build to designed height. Make your vertical steel come to within 1/2" of the top of the form, unless you are taking the wall up from the crawl stem, then 2' or more above height for upper wall overlap per code. Don't forget to place Simpson ICFVL ties or anchor bolts for rim joist banding specified by your structural engineer before your pour, if required.

BUILDBLOCK TECHNICAL & INSTALLATION MANUAL

14. Consider using a termite shield if you are in a high risk zone. Flashing mounted inside the void, over the inner foam, down from the top, lipping out under your rim joist will work all though there are other options becoming available for ICFs.
15. For more complete wet-set instructions see the Technical section of our website.

WET-SET TIPS

- Pour footing in sections: This prevents your footing concrete from setting up prior to stem block placement.
- Start at corners and work inward on all walls.
- Set your block to the string line and check for plumb and level using a bullet level.
- Recheck previously set blocks often and straighten and re-level each wall a second time before concrete hardens.
- Make sure you have the correct slump concrete. When pouring your foundations, a slump of 6" to 8" is not so dry as to set up rapidly or be difficult to work. It also is not so wet that the forms have a tendency to float up.
- If you run into trouble – don't panic! Wet-set as much of the project as possible, then finish off your footers and dry set the remainder. If you do this, remember to make sure you set rebar dowels before the concrete dries and pour the remainder of the footers 1/2" shorter in height.
- Have on hand one or two packages of Fritz-Pak FR-1, a powder concrete retarder. Tossing one in a truck can help buy time if your foundation concrete is getting hot. This is a much better option to make concrete workable than watering it down. Remember – the more water you add, the weaker your concrete becomes.
- An inexpensive way to protect the top of your block from other contractors and concrete spills is ULINE Industrial Tape S-1850, 3" durable tape. (<http://uline.com>)
- 2-1/2" wide C-channel can also be used to protect the interlock connections. It is also a great tool to screed to as well when pouring a slab on grade.

- Leave concrete slightly rough and an inch or two below the connections inside the block. This will be filled when pouring the walls later.
- Protect the top of your block during the pour otherwise time will be spent with a small tool trying to clean dry concrete from the interlocks so you can continue stacking the wall!

When something goes wrong it will cost someone time and money. That someone is usually you. Taking precautions and planning before you pour will make all the difference.

Small mistakes and carelessness can add up quickly.

(Note: This type of construction is used for slab on grade applications in conjunction with using the blocks as an insulated stem wall.)



4.4.4 Wet set blocks placed with vertical & horizontal rebar for slab on grade applications in conjunction with stem wall construction. Leave concrete slightly rough 1-2" below tops of the blocks. Protect block interlocks to continue stacking additional courses.

BUILDBLOCK TECHNICAL & INSTALLATION MANUAL

This page left intentionally blank.

BUILDBLOCK TECHNICAL & INSTALLATION MANUAL



BuildBlock ICF Interior walls braced and ready for pouring.

SECTION 5: ABOVE-GRADE WALL PLACEMENT

5.1 PLACING BUILDBLOCK WALLS

We will begin on the slab for this section. If you did a wet set, you can still benefit from the sequence of events that follows. Assuming you have set your first course (or two-course stacked), you are ready to begin building the walls.

Look at the face of the form. It has a built-in ruler and cut lines marked both vertically and horizontally. The vertical cut lines are on 1" centers and allow proper 1" repeat pattern with the top and bottom connections with the webs lined up vertically.

A center line horizontal mark and corresponding marks are on 2" centers. BuildBlock was designed to help you stack and cut faster and more accurately without having to use a tape measure with every cut.

INTERLOCKING BLOCKS

BuildBlock forms are designed on a 1" grid. This means the interlocking connectivity on the tops and bottoms of the form repeat the same pattern every 1". This is a major difference between BuildBlock ICFs and other blocks and a key reason why there is such little waste created in a BuildBlock wall. Other blocks use a 2", 4", 6" or 12" pattern.

Pay close attention that the marking for webs line up every course. The blocks are fully reversible and if you maintain the correct corner offset the webs will line up vertically on every course. This prevents searching for studs when sheet-rocking. Unless you cut a corner block in length, all webs should line up automatically.

STACK JOINTS

BuildBlock ICFs are designed on a running offset bond. This tightly locks the blocks together horizontally and courses together vertically. Some applications require a stack joint or stack bond. This can occur when the layout of a project doesn't occur in dimensions that match the ICF block length and corner returns. When this occurs sometimes a vertical seam must be created to bring wall sections together. This is a weak section of the project until the concrete is poured and sets. Additional

bracing on both sides of the wall may be required. Many times these seams are placed over doors or windows which will require additional bracing or strapping anyway.

HOW TO BEGIN

Begin with the corners staggering or reversing the corners each time you stack in order to create a offset running bond. Work toward the middle of each wall to a window or door opening.

MINIMIZING WASTE

Minimize waste further by taking full advantage of BuildBlock's features when building your walls. Small cut-offs can be used throughout your walls. Any piece with two webs is safe to use. In special places, even pieces with one web can be utilized with proper care.

These are best used in the next to last course. Position them in areas between door or window openings. This creates a secure connection to the top and bottom of short pieces and by placing them near the top of the wall there is significantly less concrete pressure. Try to space these throughout the walls away from corners and openings or lintels.

CUTTING BLOCKS

Each course between corners will have a cut block somewhere in the wall. Try to place this cut in a window or door area. The cut should happen in each course as you build the wall up. These cut faces may need to be braced if the foam distance to an existing web is over 3"; the same distance from a web to the end of an uncut BuildBlock form. Mark all cuts for bracing or gluing when installed. Later you can foam the cut edges to replace the bracing in most cases.

MAINTAINING LEVEL, PLUMB, AND SQUARE

Constantly verify that you are level, plumb and square as you go, remembering to stagger the corners and the blocks, like brick masons stack brick.

BuildBlock ICFs do not require zip ties, foam adhesive or special clips to keep the blocks together. BuildBlock does not recommend the use of foam adhesive to glue the blocks on top

BUILDBLOCK TECHNICAL & INSTALLATION MANUAL

of one another except possibly in the last one or two courses. Drying adhesive may expand causing blocks to rise or not fit together properly. Use glue sparingly. The BuildBlock ICF block interlock is extremely precise and tight. The block has a 100% surface to surface connection. There is little room for expansion of foam adhesive..

The last course can be tacked down to avoid lifting. Lifting on the last course is typically caused by vibrating too much in the wall or over a door or window opening. Only spot glue the blocks.

PLACING REBAR

BuildBlock recommends placing horizontal rebar in alternating rebar slots, inside to outside, leaving a small slot or space between horizontal bars. Place horizontal rebar with a minimum of 40 x [bar diameter] (usually 24" or 30") of overlap in the rebar holders built in to the web ties. In below grade reinforcement rebar is typically placed on the tension side of the wall increasing its effectiveness.

This alternating rebar layout creates a "chase" for the vertical rebar to easily thread into after the walls are stacked and before they are poured. This minimizes tying of rebar, and lifting the forms over long vertical rebar. Tie each vertical bar at the top connection only.

Creating this chase allows for a non-contact lap splice of the vertical steel to the footing, slab, and wall below. A non-contact lap splice is characterized by spacing no greater than 6 inches between vertical bars being lapped. All ACI lap splice lengths apply to this splice as well. The BuildBlock 6" web spacing combined with the horizontal bars alternating on either side result in any non-contact lap splice limited to less than 6" spacing between bars when placed in the same cavity. Significant labor savings can be gleaned from this method of rebar placement.

The rebar should never touch the foam. ACI 318 requires there be at least 3/4" between any rebar and the edge of the concrete. Concrete should be able to fully surround rebar in order for it to pass code and perform properly.

GAPS & OPENINGS

When stacking, should you encounter a gap it should not be larger than 1/4". If it is fill the gap with foam and scab it with wood across the gap anchoring into webs on each side of the gap and both sides of the wall.

When you reach an opening buck, cut the forms with a hand saw for a good fit. BuildBlock recommends that all cut blocks that stack into the side of a buck be 1/4" shorter than the actual size to allow for settlement and the ability to square the buck. Take care in these areas, otherwise plumbing of the bucks may be impossible without trimming blocks.

Forms cut too tight can cause openings that won't adjust and bulge. Openings too loose may increase the risk of a blowout. Don't forget your rebar in lintels above openings and 2 vertical rebar on the sides. Refer to local codes or site specific engineering for the rebar required by your engineer. It's no fun to have to go back to fix things like this later!

ADDITIONAL COURSES

Ensure the blocks are tightly locked together. Use hands or blocks of wood to hit the blocks without damaging the interlocks to ensure the blocks are well seated together. If the interlocks become damaged or broken, remove the damaged pieces and lock the blocks together. It may be necessary to spot glue damaged areas before pouring the wall, this is usually not a problem.

DISTRIBUTING BLOCK

Use bundles of block in a section of wall. Blocks should be completely uniform in size, but in some cases there could be minor differences. For example, combining older and newer blocks on the same job. Using these blocks in a continuous row could introduce an error. Integrating these blocks into several courses will reduce any error.

THE TOP COURSE

There are several options for ensuring the wall remains straight and plumb. These may not be necessary depending on the spacing of bracing, wall heights, and other factors.

1. Install wood along the top on both sides strapping them together as you go with short strips of wood to form a ladder-looking brace to keep the wall straight.
2. Install a rigid wire ladder type system in the top course. This must be accounted for during your budgeting process. These products are available from concrete block suppliers. Match truss size to form size used.
3. Attach a medium gauge 1.5x1.5 or 2x2 or 3x3 one-eighth inch thick angle iron on both sides of the form. This makes a great screed stop. Using a clip over the top will hold them in place and keep your wall top straight. These are reusable for many years.
4. Use deep leg deflection rack steel framing or use 2.5" C-Channel will side over the EPS foam. This also protects the interlocks during the pour and is easily removed after screeding before the concrete fully sets.

If a top plate is to be used, ensure vertical rebar is installed 1" below the top of the wall. This will maintain appropriate code compliance and ensure the top plate will attach correctly, nor protrude through the top of the wall as the forms will compress slightly, but steel does not.

If the wall will continue beyond the top course of block, ensure the interlock is protected during the pour. It is also recommended to stack an additional course of block above the initial wall height to allow solid attachment of the floor system anchors or supports.

5.2 CONCRETE REINFORCEMENT

Reinforced concrete is a composite material in which concrete's relatively low tensile strength and ductility are counteracted by the inclusion of reinforcement having higher tensile strength and/or ductility.

The reinforcement is usually, though not necessarily, steel reinforcing bars (rebar) and is usually embedded passively in the concrete before the concrete sets. Reinforcing schemes are

BUILDBLOCK TECHNICAL & INSTALLATION MANUAL

generally designed to resist tensile stresses in particular regions of the concrete that might cause unacceptable cracking and/or structural failure.

Modern reinforced concrete can contain varied reinforcing materials made of steel, polymers or alternate composite material in conjunction with rebar or not. Reinforced concrete may also be permanently stressed (in compression), so as to improve the behavior of the final structure under working loads. In the United States, the most common methods of doing this are known as pre-tensioning and post-tensioning.

For a strong, ductile and durable construction the reinforcement needs to have the following properties at least:

- High relative strength
- High toleration of tensile strain
- Good bond to the concrete, irrespective of pH, moisture, and similar factors
- Thermal compatibility, not causing unacceptable stresses in response to changing temperatures.
- Durability in the concrete environment, irrespective of corrosion or sustained stress for example.

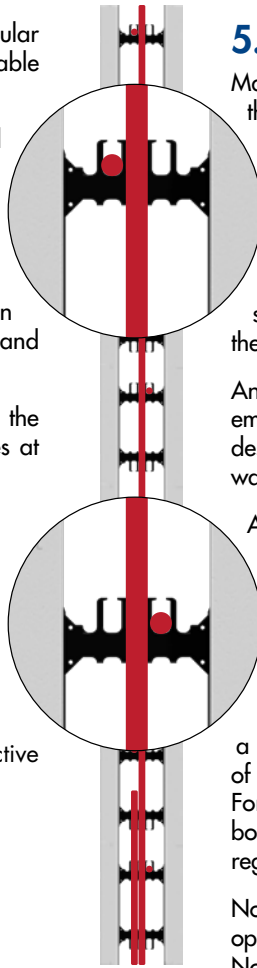

5.3 REBAR REINFORCEMENT

Major building codes in North America and around the world including the International Residential Code (IRC), International Building Code (IBC), National Building Code of Canada, (NBCC) as well as state, local, and municipal organizations recognize Insulating Concrete Forms as a method of concrete wall construction. Each has developed or relies on commonly available engineering tables specifying size, spacing, and placement of rebar reinforcement in the wall based on wall height, seismic zone, etc.

An ICF is simply a concrete wall encased in EPS foam with embedded plastic attachment points. The engineering, design, and final structure are all reinforced concrete walls.

All ICF form systems require rebar for reinforcement. Rebar is placed both horizontally and vertically in the forms as you stack the walls to form a grid, strengthening the wall system. All openings require that you build a lintel over it to dissipate span loads in the bearing areas of the walls.

Every ICF project is subject to and will benefit from a structural engineer's specifications or the consultation of the book Prescriptive Method for Insulating Concrete Forms in Residential Construction (Second Edition) or both. BuildBlock urges you to take the proper steps regarding your rebar selections and placement.

Note: Horizontal rebar in each course; Lintels over openings; Extra verticals near openings; Vertical steel. Note: Two bars of rebar are recommended on each side of a window or door opening.

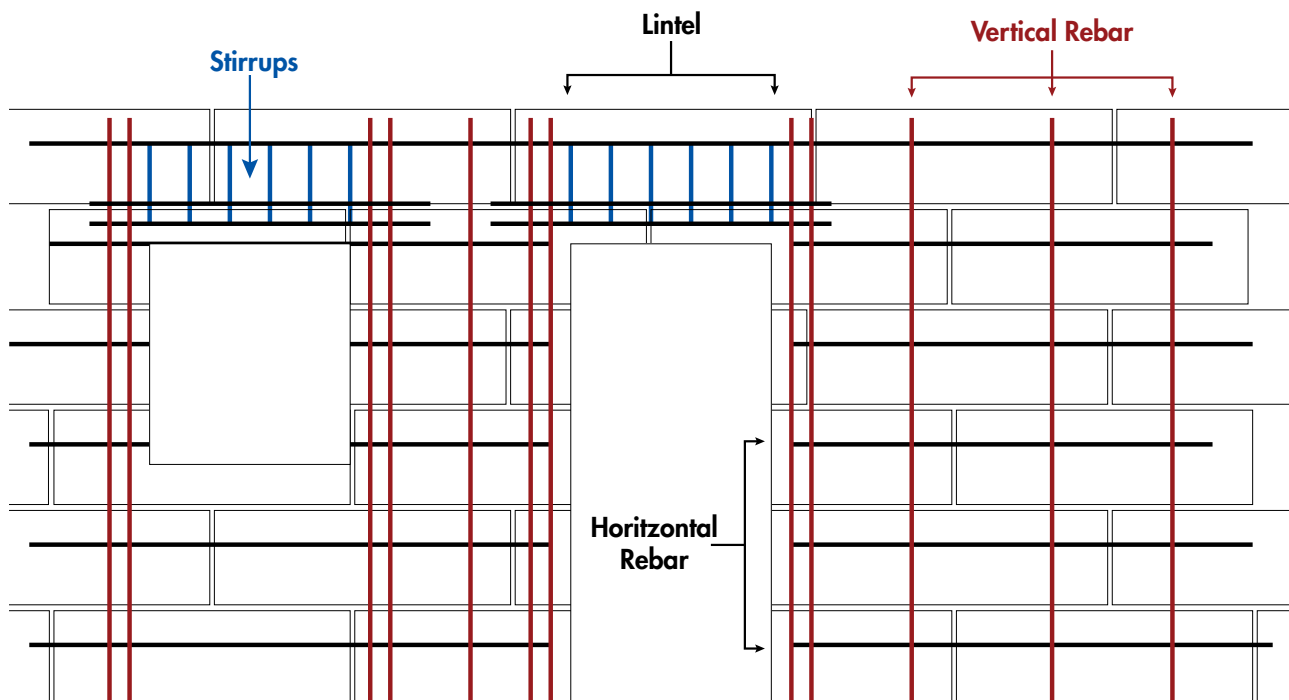

Rebar Reinforcement in an ICF wall.

BUILDBLOCK TECHNICAL & INSTALLATION MANUAL

5.4 REBAR PLACEMENT

- Rebar starts at the footing level with rebar coming up from the footing and into the wall void. This step keeps the base of the wall in place and ties the two systems – footings and walls – together.
- Place horizontal rebar by slightly staggering it in each course to the inside then outside of the wall.
- All rebar must overlap — in most cases 40 times the diameter of the bar, but consult your structural engineer on this. Example: 40 times 1/2" rebar is an 20" overlap on your steel.
- Place lintel rebar as you build up and over openings. Consult the lintel chart. We recommend all lintel horizontal bars extend 24" minimum past each side of the window or door opening.

- Vertical bar can be pre-cut and ready to stab once you walls are built to the top plate height. Make them 1" shorter than the wall in which you place them.
- Many installers have vertical rebar for each floor pre-cut to height so no cutting is required.
- Remember that PVC ring you slipped over the piece of rebar coming from the footing on the stem? Stab your vertical bars into the PVC ring to hold in place and tie the bar to the top horizontal bar. Some installers believe the PVC ring is unnecessary. We believe it's best to hold verticals in between the webs so we recommend it. Make sure the ring is no taller than 3/4" to 1" so concrete fills the ring fully. We use 1-1/4" or larger PVC pipe to cut rings.



Figure 5.5.1 Intersecting Bulkhead wall with strapping. Figure 5.5.2 (top) Wall intersection opening cut. Figure 5.5.3 intersecting wall opening types.

5.5 INTERSECTING WALLS

When you need to build T-wall intersections, follow the detail below for options regarding how they can be built. Don't forget to back brace the intersection. Use a full height 2x4 T (made out of two 2x4s in T fashion) brace properly.

Screw the flat portion to the back of the wall opposite the block T. Brace the bottom and two-thirds height positions to a secure point in the ground. Please note that the T cut may be anywhere in the form. These are just examples. Failure to brace this area properly could result in a bulged area on the back side of a T.

The pictures on the next page are examples of how rebar might look placed in an ICF wall. You must brace the back side of T-walls as noted previously.

INTERSECTING WALL CONSTRUCTION OPTIONS

There are several ways to construction intersecting walls. Some ICF companies use a specialty form called a T-Form. The T-Form is a specialty form used to create demising walls or interior intersecting walls as a part of the standard stacking process. There must be short and long forms to ensure significant overlap is achieved to maintain structural stability during the construction process just like the offset used on corner blocks.

BuildBlock does not use a dedicated T-wall form. The same efficiencies without added cost can be achieved. To build without a t-wall block you must intersect the walls in one of two ways, illustrated on page 46. You can do this integration each course, or you can build your flat wall as if there was no intersection, then remove the area for the intersection and slide the intersecting courses in, tying in rebar as you go.

BUILDBLOCK TECHNICAL & INSTALLATION MANUAL

The advantage of this method is speed, and stability of the wall during the intersection phase. You still must brace accordingly as you stack the intersection, but it works well, saves time, and allows you to use existing block and reduce significant waste.

INTERSECTING WALL NOTES

- Applying bracing as indicated in the diagram is crucial to a successful intersecting wall pour.
- Use braces on either side of the T (indicated by arrows) before a pour for extra support.
- Pay attention to the rebar placement tie in.
- Use pre-bent 90° rebar to flow into the T from the wall being intersected.



Figure 5.5.4 Intersecting wall opening types.



Figure 5.5.5 Intersecting wall opening alternating form placement.



Figure 5.5.6 Intersecting wall opening with wire used to secure webs to intersecting block.



Figure 5.5.7 Intersecting wall opening cavity and wire tied to secure forms.

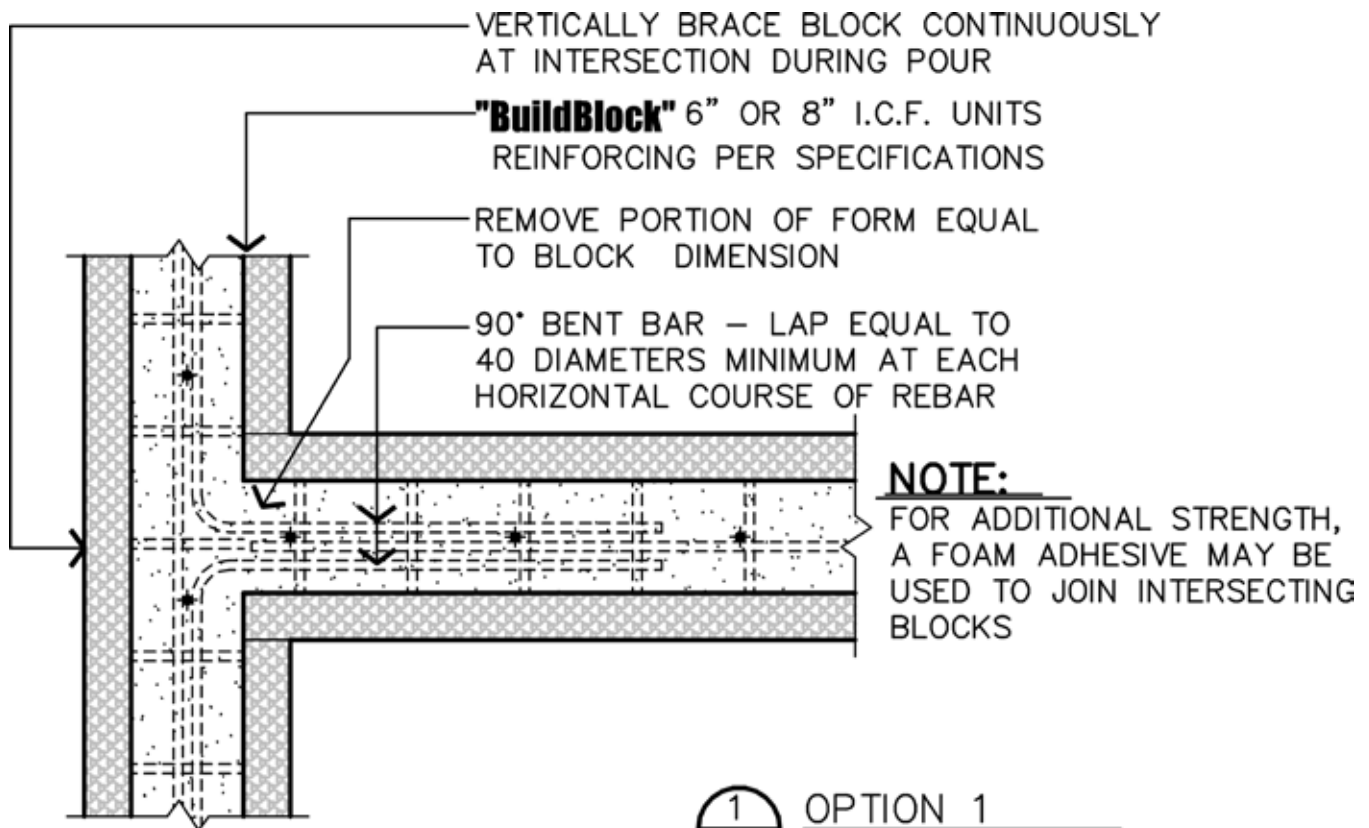

Figure 5.5.8 Intersecting wall opening types.

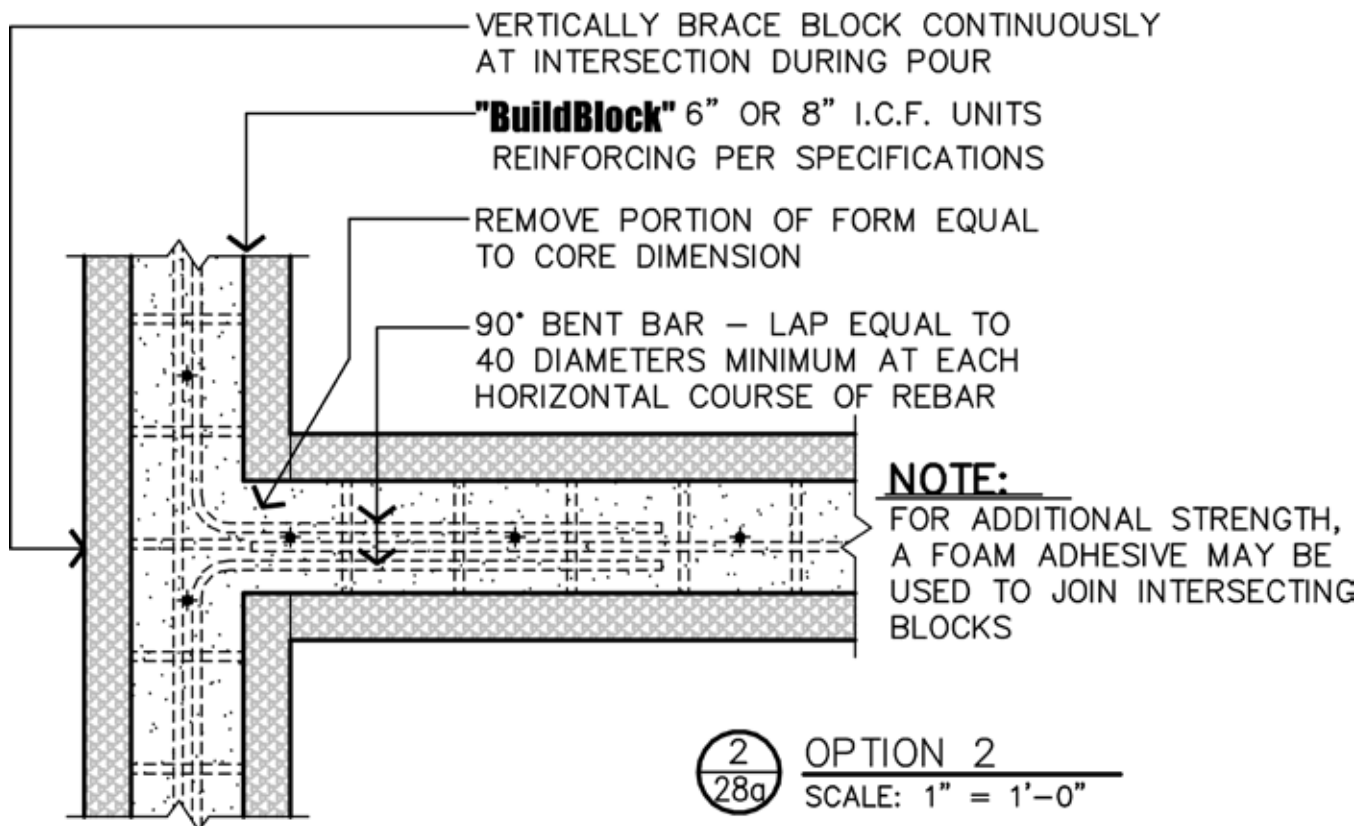

Figure 5.5.9 Intersecting wall opening types.

BUILDBLOCK TECHNICAL & INSTALLATION MANUAL



1
28a OPTION 1
SCALE: 1" = 1'-0"



2
28a OPTION 2
SCALE: 1" = 1'-0"

Figure 5.5.10 Intersecting wall construction details.

BUILDBLOCK TECHNICAL & INSTALLATION MANUAL



5.6 RADIUS WALLS

Radius walls are a unique architectural feature as well as having practical value in a building design. There are two types of radius that are commonly used: large and small.

Small radius walls are typically less than 10 feet in diameter. The diameter of the radius is important because the tighter the radius, the greater the material that must be removed to create the radius.

BuildBlock forms can be cut to form radius walls of any degree. The ICF blocks will be cut either on one side or both sides depending on the diameter. There are numerous methods for handling a form once cut to the particular radius.



Radius wall jig holding blocks together while adhesive foam glue sets. Blocks can be created in a climate controlled workspace, numbered, and transported to a job site to speed construction.

METHOD 1: RADIUS JIG

Once you have determined the radius from your plans, review the radius chart for the proper material removal and make a jig to hold your form in the radius position. A jig is the fastest way to glue together lots of forms.

METHOD 2: COMPASS

A secondary method to create a radius wall is to build the wall in a large space and using a string and a marker inscribe

the radius on the slab. Consult the radius chart and build the radius as indicated ensuring it matches the arc.



HIGHLIGHTS

- Radius jig holding blocks together while being glued with adhesive foam.
- Basement radius wall with intersecting straight T walls and angled T walls.
- Wooden ladder strapping on the top of the wall.
- Vertical rebar placed extending up through the wall for another level to be poured later.
- Wood bracing
- Pre-built supply of radius forms in wait to be stacked.
- All internal bracing due to terrain.
- Spiral staircase supports being placed as the walls are poured

Some professionals do not extend the vertical steel above the first floor ICF wall to prevent it being in the way during the pour. Instead, they use 4' or longer dowels placed immediately after pouring the wall to create a non-contact lap tying floors together. This requires additional extra steel, but may be helpful.

BUILDBLOCK TECHNICAL & INSTALLATION MANUAL

5.7 RADIUS WALL CHART

When preparing a radius wall you must be consistent with the measurement you use to determine the radius. You can choose the inside radius or the outside radius, but you must be consistent. The tables below provide the cuts for the inside of the block.

4" Inner Radius Wall			
		6" O.C.	12" O.C.
Inside Radius	Blocks	Interior Face Cut	Interior Face Cut
2 Feet	5	1-7/16	2-13/16
3 Feet	6	1-3/16	2-3/8
4 Feet	8	7/8	1-3/4
5 Feet	10	1-1/16	1-7/16
6 Feet	11	5/8	1-5/16
7 Feet	13	9/16	1-1/16
8 Feet	14	1/2	1
9 Feet	16	7/16	7/8
10 Feet	17	7/16	13/16
15 Feet	25	5/16	9/16
20 Feet	33	3/16	7/16
30 Feet	49	1/8	5/16
40 Feet	65	1/8	3/16
50 Feet	80	1/16	3/16
60 Feet	96	1/16	1/8
70 Feet	112	1/16	1/8
80 Feet	127	1/16	1/8
90 Feet	143	1/16	1/8
100 Feet	159	1/16	1/16

6" Inner Radius Wall			
		6" O.C.	12" O.C.
Inside Radius	Blocks	Interior Face Cut	Interior Face Cut
2 Feet	5	1-3/4	3-7/16
3 Feet	7	1-1/4	2-1/2
4 Feet	8	1-1/16	2-3/16
5 Feet	10	7/8	1-3/4
6 Feet	11	13/16	1-9/16
7 Feet	13	11/16	1-5/16
8 Feet	15	9/16	1-1/8
9 Feet	16	9/16	1-1/16
10 Feet	18	1/2	15/16
15 Feet	26	5/16	11/16
20 Feet	33	1/4	1/2
30 Feet	49	3/16	3/8
40 Feet	65	1/8	1/4
50 Feet	80	1/8	3/16
60 Feet	96	1/16	3/16
70 Feet	112	1/16	1/8
80 Feet	128	1/16	1/8
90 Feet	143	1/16	1/8
100 Feet	159	1/16	1/8

8" Inner Radius Wall			
		6" O.C.	12" O.C.
Inside Radius	Blocks	Interior Face Cut	Interior Face Cut
2 Feet	5	2-1/16	4-1/16
3 Feet	7	1-7/16	2-15/16
4 Feet	8	1-1/4	2-9/16
5 Feet	10	1	2-1/16
6 Feet	12	7/8	1-11/16
7 Feet	13	13/16	1-9/16
8 Feet	15	11/16	1-3/8
9 Feet	16	5/8	1-1/4
10 Feet	18	9/16	11/8
15 Feet	26	3/8	13/16
20 Feet	34	5/16	5/8
30 Feet	49	3/16	7/16
40 Feet	65	3/16	5/16
50 Feet	81	1/8	1/4
60 Feet	96	1/8	3/16
70 Feet	112	1/16	3/16
80 Feet	128	1/16	3/16
90 Feet	144	1/16	1/8
100 Feet	159	1/16	1/8

4" Outer Radius Wall			
		6" O.C.	12" O.C.
Outside Radius	Blocks	Interior Face Cut	Interior Face Cut
2 Feet	4	1-3/4	3-9/16
3 Feet	5	1-7/16	2-13/16
4 Feet	7	1	2
5 Feet	8	7/8	1-3/4
6 Feet	10	1-1/16	1-7/16
7 Feet	11	5/8	1-5/16
8 Feet	13	9/16	1-1/16
9 Feet	15	1/2	15/16
10 Feet	16	7/16	7/8
15 Feet	24	5/16	9/16
20 Feet	32	1/4	7/16
30 Feet	48	1/8	5/16
40 Feet	63	1/8	1/4
50 Feet	79	1/16	3/16
60 Feet	95	1/16	1/8
70 Feet	110	1/16	1/8
80 Feet	126	1/16	1/8
90 Feet	142	1/16	1/8
100 Feet	158	1/16	1/16

6" Outer Radius Wall			
		6" O.C.	12" O.C.
Outside Radius	Blocks	Interior Face Cut	Interior Face Cut
2 Feet	4	2-3/16	4-5/16
3 Feet	5	1-3/4	3-7/16
4 Feet	7	1-1/4	2-1/2
5 Feet	8	1-1/16	2-3/16
6 Feet	10	7/8	1-3/4
7 Feet	11	13/16	1-9/16
8 Feet	13	11/16	1-5/16
9 Feet	15	9/16	1-1/8
10 Feet	16	9/16	1-1/16
15 Feet	24	3/8	3/4
20 Feet	32	1/4	9/16
30 Feet	48	3/16	3/8
40 Feet	63	1/8	1/4
50 Feet	79	1/8	1/4
60 Feet	95	1/16	3/16
70 Feet	110	1/16	3/16
80 Feet	126	1/16	1/8
90 Feet	142	1/16	1/8
100 Feet	158	1/16	1/8

8" Outer Radius Wall			
		6" O.C.	12" O.C.
Outside Radius	Blocks	Interior Face Cut	Interior Face Cut
2 Feet	4	2-9/16	5-1/16
3 Feet	5	2-1/16	4-1/16
4 Feet	7	1-7/16	2-7/8
5 Feet	8	1-1/4	2-9/16
6 Feet	10	1	2-1/16
7 Feet	11	15/16	1-7/8
8 Feet	13	13/16	1-9/16
9 Feet	15	11/16	1-3/8
10 Feet	16	5/8	1-1/4
15 Feet	24	7/16	7/8
20 Feet	32	5/16	5/8
30 Feet	48	3/16	7/16
40 Feet	63	3/16	5/16
50 Feet	79	1/8	1/4
60 Feet	95	1/8	3/16
70 Feet	110	1/16	3/16
80 Feet	126	1/16	3/16
90 Feet	142	1/16	1/8
100 Feet	158	1/16	1/8

BUILDBLOCK TECHNICAL & INSTALLATION MANUAL

RADIUS WALL CHART CONTINUED

When preparing a radius wall you must be consistent with the measurement you use to determine the radius. You can choose the inside radius or the outside radius, but you must be consistent. The tables below provide the cuts for the inside of the block.

10" Inner Radius Wall			
		6" O.C.	12" O.C.
Inside Radius	Blocks	Interior Face Cut	Interior Face Cut
2 Feet	6	1-15/16	3-15/16
3 Feet	7	1-11/16	3-3/8
4 Feet	9	1-5/16	2-5/8
5 Feet	10	1-3/16	2-3/8
6 Feet	12	1	1-15/16
7 Feet	13	15/16	1-13/16
8 Feet	15	13/16	1-9/16
9 Feet	17	11/16	1-3/8
10 Feet	18	5/8	1-5/16
15 Feet	26	7/16	7/8
20 Feet	34	3/8	11/16
30 Feet	50	1/4	1/2
40 Feet	65	3/16	3/8
50 Feet	81	1/8	5/16
60 Feet	97	1/8	1/4
70 Feet	112	1/8	3/16
80 Feet	128	1/16	3/16
90 Feet	144	1/16	3/16
100 Feet	160	1/16	1/8

12" Inner Radius Wall			
		6" O.C.	12" O.C.
Inside Radius	Blocks	Interior Face Cut	Interior Face Cut
2 Feet	6	2-1/4	4-7/16
3 Feet	7	1-15/16	3-13/16
4 Feet	9	1-1/2	3
5 Feet	11	13/16	27/16
6 Feet	12	1-1/8	2-1/4
7 Feet	14	15/16	1-15/16
8 Feet	15	7/8	1-13/16
9 Feet	17	13/16	19/16
10 Feet	18	3/4	1-1/2
15 Feet	26	1/2	1
20 Feet	34	3/8	13/16
30 Feet	50	1/4	9/16
40 Feet	66	3/16	3/8
50 Feet	81	3/16	5/16
60 Feet	97	1/8	1/4
70 Feet	113	1/8	1/4
80 Feet	128	1/8	3/16
90 Feet	144	1/16	3/16
100 Feet	160	1/16	3/16

10" Outer Radius Wall			
		6" O.C.	12" O.C.
Outside Radius	Blocks	Interior Face Cut	Interior Face Cut
2 Feet	4	2-15/16	5-7/8
3 Feet	5	2-3/8	4 11/16
4 Feet	7	1-11/16	3-3/8
5 Feet	8	1-1/2	2-15/16
6 Feet	10	1-3/16	2-3/8
7 Feet	11	1-1/16	2-1/8
8 Feet	13	1-5/16	1 13/16
9 Feet	15	1-3/16	1-9/16
10 Feet	16	3/4	1-1/2
15 Feet	24	1/2	1
20 Feet	32	3/8	3/4
30 Feet	48	1/4	1/2
40 Feet	63	3/16	3/8
50 Feet	79	1/8	5/16
60 Feet	95	1/8	1/4
70 Feet	110	1/8	3/16
80 Feet	126	1/16	3/16
90 Feet	142	1/16	3/16
100 Feet	158	1/16	1/8

12" Outer Radius Wall			
		6" O.C.	12" O.C.
Outside Radius	Blocks	Interior Face Cut	Interior Face Cut
2 Feet	4	3-3/8	6-11/16
3 Feet	5	2-11/16	5-3/8
4 Feet	7	1-15/16	3-13/16
5 Feet	8	1-11/16	3-3/8
6 Feet	10	15/16	2-11/16
7 Feet	11	13/16	2-7/16
8 Feet	13	1	2-1/16
9 Feet	15	7/8	1-13/16
10 Feet	16	13/16	1-11/16
15 Feet	24	9/16	11/8
20 Feet	32	7/16	13/16
30 Feet	48	1/4	9/16
40 Feet	63	3/16	7/16
50 Feet	79	3/16	5/16
60 Feet	95	1/8	5/16
70 Feet	110	1/8	1/4
80 Feet	126	1/8	3/16
90 Feet	142	1/8	3/16
100 Feet	158	1/16	3/16

BUILDBLOCK TECHNICAL & INSTALLATION MANUAL



Figure 5.8.1 This partial second story has many openings, steps in height, bulkheads for wood frame attic, and is braced on the inside of the wall.

5.8 SECOND STORY WALLS AND ABOVE

Most ICF jobs that are taller than one story take advantage of the floor being placed before the second story wall is built. Some builders prefer to build tall walls and pour them in up to 12' to 16' stages. This may or may not be practical or allowed based on local codes.

ICF construction of the second or higher levels follows the same methods as construction of lower levels. The greatest challenge is that all materials are staged on the ground floor. Use a lift system to stage materials conveniently and safely.

SECOND STORY CONSTRUCTION EXAMPLES

1. Wall height is 14' 8".
2. The wall height includes one course of block is above the plate height of the first floor system. The top course should be clear of the ICFVL brackets. It is important that there is not a cold joint in the course that contains the floor ledger system. This also makes it easier to pour and more than a foot of the next story wall already in place.
3. Vertical rebar must overlap $40 \times$ [bar diameter] and comply with local codes or site specific engineering for a non contact lap splice for second story or higher walls.
4. Kicker braces were added to the top of the wall for the extra height.
5. Openings are properly braced for a pour.
6. The ICFVL joist hanging brackets are set for a 12' plate height on 4' OC. This is the wall in conjunction with the joist side loading. The bearing wall joist hangers were run at 2' OC. For proper spacing of wall joist hangers, refer to Simpson engineering in the CAD Details 15 through 15e in the CAD Details Section.

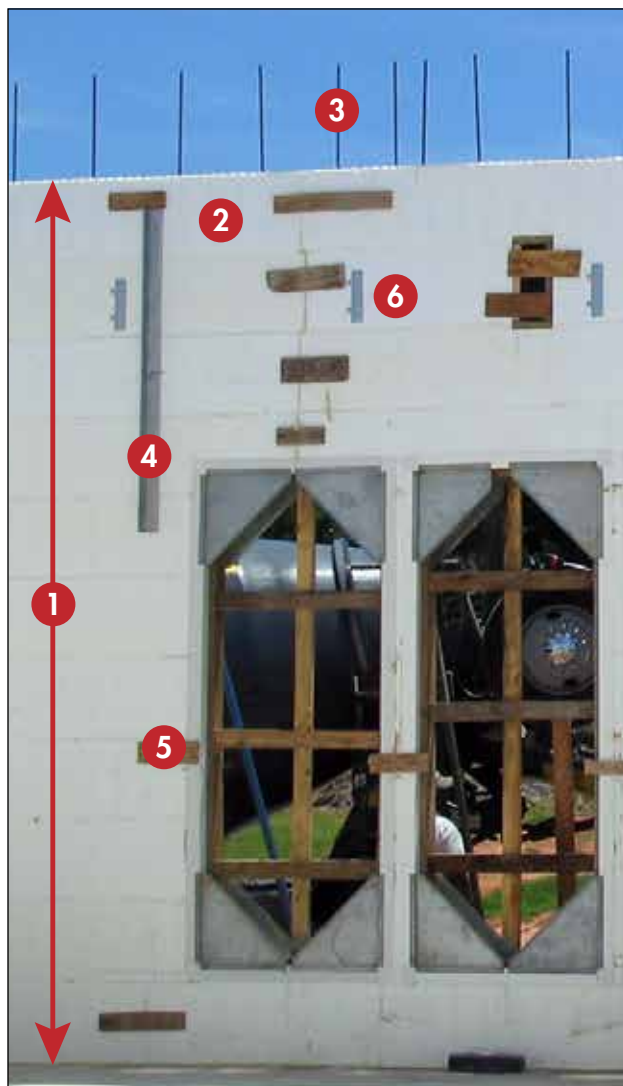

Figure 5.8.2 Second story construction example.

BUILDBLOCK TECHNICAL & INSTALLATION MANUAL

5.9 TRANSITIONING BLOCK SIZES

Projects often require the transition between blocks of different sizes. This is most common when transitioning from below grade walls to above grade walls. Larger block sizes are commonly used below grade and smaller above grade or on a second story or higher.

Walls can also transition on the same level, especially if they are supporting a larger structure above in a certain area. In a split-level home design for example, sections of the first level may be created with an 8-inch block to support a partial second floor while the rest of the home may be built with 6-inch block.

Transitioning between block sizes is typically accomplished by removing the inside row interlocking nubs on the top course inside of the larger block. The interlocking nubs can be removed by popping them off with your fingers or by using a small saw. The outside wall is stacked flush and by removing the inside row of the interlock provides a level ledge location for the block.

This transition method will always work if the size transition is changing by 2". e.g. 6" to 4", 8" to 6", 10" to 8", or 12" to 10", etc. This method also applies to all BuildBlock, BuildLock, and GlobalBlock ICF blocks.

Note: Typically the floor system covers the transition between block sizes on the inside of the wall.

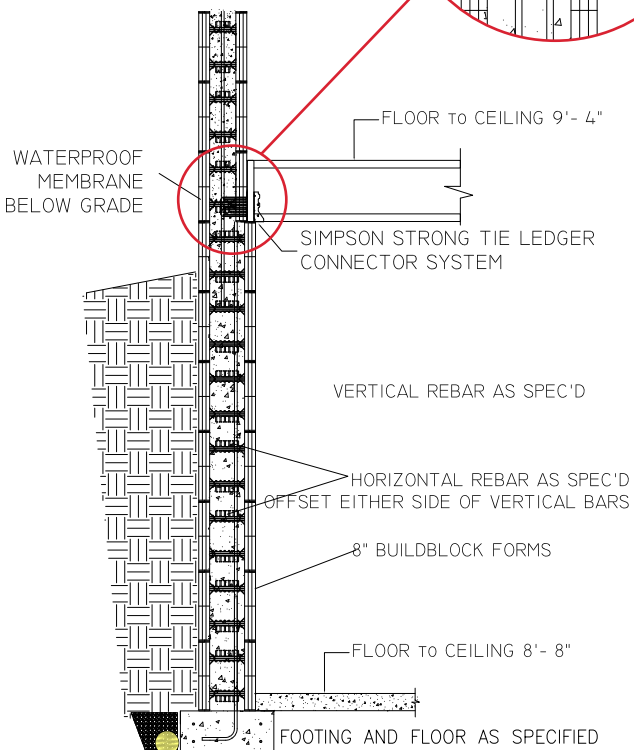

TYPICAL 8" BUILDBLOCK BASEMENT WITH 6" BUILDBLOCK ABOVE. GABLE CROSS SECTION

Figure 5.9.2 Typical block transition from 8-inch BuildBlock ICF below grade wall to 6" BuildBlock ICF above grade wall and Simpson ICFVL.

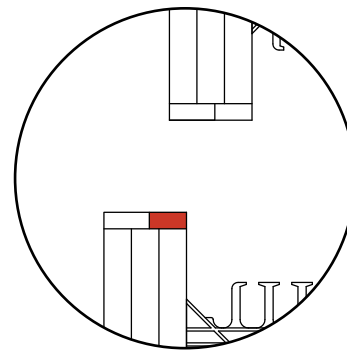

Figure 5.9.3 Inner interlocking nubs are removed to create a flat attachment for the smaller form.

TRANSITIONING BETWEEN BLOCK SIZES

Remove the entire row interlocking nubs from the inside row of larger forms only.

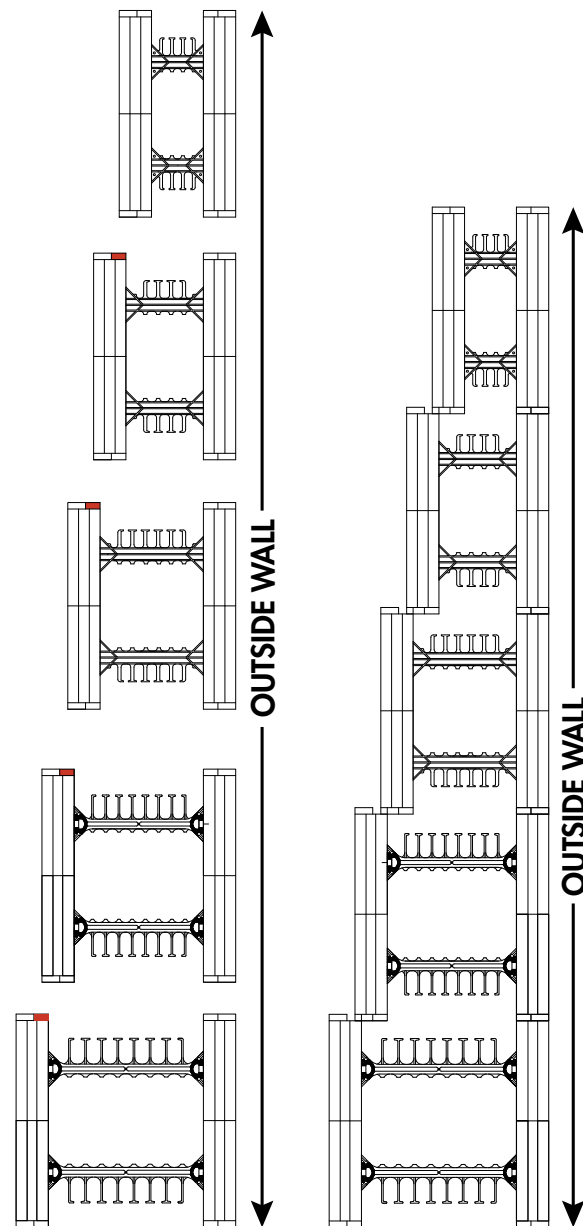

Figure 5.9.4 Remove the inner interlocking nubs on one side of the larger block for placement of the blocks together.

BUILDBLOCK TECHNICAL & INSTALLATION MANUAL

5.10 SECOND FLOOR/JOIST HANGER OPTIONS

BuildBlock recommends the Simpson Strong Tie ICF joist hanging system for rim joist / joist hanging applications. Each system requires structural engineering to comply with manufacturers specifications. Other systems that meet load requirements such as anchor bolts with wood rim joists, Watkins Hangers and others may also be used. Embedded hangers are the best method, but there are several other methods as well.

ABOUT JOIST HANGERS

The ICFVL Ledger Connector System is engineered to solve the challenges of mounting wood or steel ledgers to insulated concrete form (ICF) walls. The ICFVL is designed to provide both vertical and lateral, in-plane performance. The system offers many benefits over traditional anchor bolting, including better on center spacing in most cases, faster installation and no protrusions.

The embedded legs of the ICFVL are embossed for additional stiffness and the hole enables concrete to flow through and around the connector. The exposed flange on the face of the ICF provides a structural surface for mounting either a wood or steel ledger.

For more information visit <http://strongtie.com>

JOIST HANGER OPTIONS

- Use the BuildBlock Brick ledge form with the ledge facing the interior of the structure. This creates a truss ledge.
- Install anchor bolts placed in 2x12 ledger boards, holes cut in the walls, ledger board attaches to the wall with the bolts entering the holes (on 12" OC or some engineered spacing). Ledger board bucks cover the holes. See CAD Detail #14.



Figure 5.10.1 The Simpson Strong Tie ICFVL Joist Hanger System.



Figure 5.10.2 The RP Watkins IFH25-11 is another joist hanger option.

- Embed steel truss weld plates and steel floor/roof trusses (5.10.1).
- Wood frame on top of ICF wall. (CAD Details 21-23.)
- Use a dedicated ICF deck form such as BuildDeck to create a integrated concrete floor or roof. (CAD Detail 56-57)
- Detailed information regarding the installation of Simpson ICFVL Ledger Connector System, ICFVL-W for 1-1/2" nominal lumber rim joists, and the ICFVL-CW for 1-3/4" composite wood joists are available in BuildBlock CAD Detail #15-15e.



Figure 5.10.3 Steel bearing plate embedded into the top of an ICF wall. Ensure the correct height taking into account the interlock.

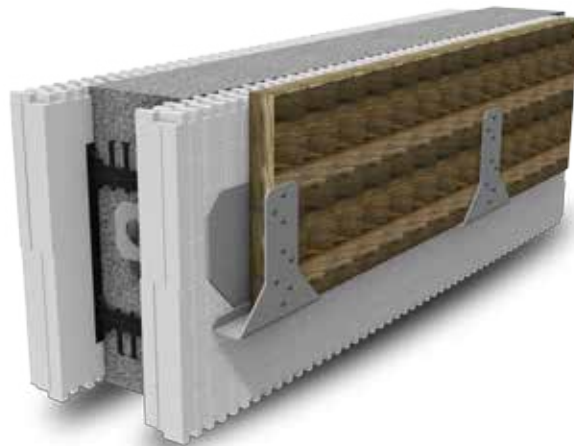

Figure 5.10.4 BuildBlock ICF block with embedded Simpson Strong Tie and rim joist attached.

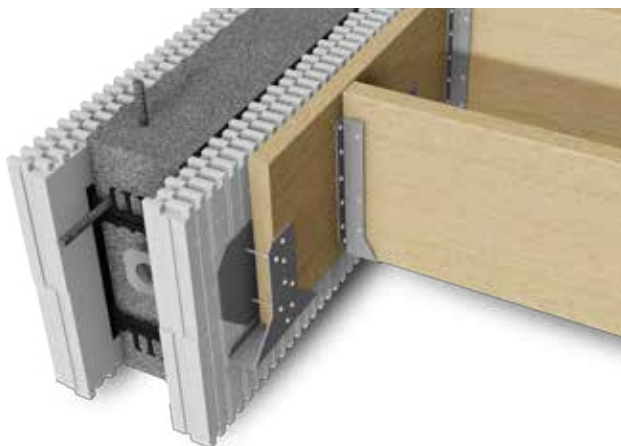

Figure 5.10.5 Attachment of standard floor joists to an ICF using traditional lumber. The Simpson Strong-Tie ICFVL is embedded into the poured concrete and provides mounting for wood or steel ledgers.

BUILDBLOCK TECHNICAL & INSTALLATION MANUAL

5.11 BEAM POCKETS

Beam pockets may be required for the installation of roof and floor beams. These pockets are created by inserting temporary blockouts to create a void in the concrete in a specific location. The size of the beam pocket should include a small tolerance based on the size of the beam ($\pm .25$ inch). This will allow small adjustments for height.

Before you size and form the beam pocket ensure you have the correct spacing required taking into account bearing surface needed, shim plates, and top plates.

CREATING BEAM POCKETS

It is very easy to create a bearing plate in a wall for a structural horizontal support beam by following the guidelines below.

- Determine the proper placement height of bearing plate and size of the beam. Consult your engineer.
- Cut out foam and web ties to accommodate beam size.
- Brace the backside of the beam pocket well with 3/4 plywood or 2x4 scabbing to support the back foam panel once the web ties are removed.
- Re-use the cut-out portions EPS foam to bulkhead the sides of the pocket or create small bucking from wood to hold back concrete on both sides of the beam pocket.
- Secure the bulkheads/bucking with adhesive foam and/or screws to prohibit movement during the pour.
- If bearing or weld plate is needed at the base, insert it after you have poured the concrete and the pocket has slaked, but is still workable.
- It is critical the height of the beam pocket is correct.
- On solid foam, cut slightly larger than the beam pocket size, secure and pour in place.

Beam pockets and placement will impact other trades such as framers and truss engineering. During the plan review ensure the location is noted and planned for. If you suspect by examining the plans that you may need to install a beam pocket, communicate with trades and engineering to obtain specifications, and placement. Add these locations to your pre-pour checklist.

Review during the stacking phase each beam pocket location so you don't have to rush to make one during the pour.



Figure 5.11.1 Steel beam placed in ICF beam pocket.

EXAMPLE

- The picture shows a large I-beam pocket for support of a loft second floor.
- This beam is being prepared by framers to accept sheetrock or a wood veneer.
- The backside of this beam pocket is an outside wall that shows no signs of placement as is expected.
- This steel beam used a 3/8" to 1/2" thick bearing plate, 5" x 8" in size with dowels protruding 7" into the wall cavity.
- It was welded in place after setting. Bearing plates need to be adequate in size for the load resting on them. Please consult your engineer for sizing.



Figure 5.12.1 An end wall, properly braced and strapped prior to installation of bracing & alignment system before concrete pour.

5.12 END WALLS, BULKHEADS AND RETAINING WALLS

There are times when you may experience walls that stop or "dead-end". At these "bulkheads" it is vital to build a strong end cap capable of holding concrete during the pour.

OVERVIEW & CONSIDERATIONS

- Brace wall on both sides for plumb to prevent sway or movement.
- If this wall is a retaining wall, place "dead-men walls" perpendicular to your runs on an engineered prescribed spacing and reinforce for backfill as specified.

There are several ways to create bulkheads:

1. Use dimensional treated lumber, placed inside the form and secured on both sides with screws and adhesive foam.
2. Use dimensional treated lumber or other hardy material as a form placed across the outer face of the form to retain any concrete. Once this buck or bulkhead is removed, the concrete will be exposed unless it's intended to remain in place, in which case 6" ring shank nails or approved anchors should be used as anchors similarly to wood window bucks. Brace securely with runners on both sides back to several web attachment points. See figure 5.12.1.
3. Use an ICF bucking system as required, brace and strap appropriately.

BUILDBLOCK TECHNICAL & INSTALLATION MANUAL



5.13 GABLE WALLS

Using ICFs to form gables increases the strength of the roof and provides greater energy efficiency. There are several methods to create ICF gables.

GABLE CONSTRUCTION OPTION 1

1. One method to construct a gable end on the floor to be installed as a one-piece unit or reassembled and installed at the gable.
2. Construct the gable wall, including any necessary rebar. Connect forms together with zip ties and foam adhesive. To minimize waste, be cautious when foaming outside the gable dimensions.
3. Snap a chalk line for the sloped gable cuts and make the cuts with a pruning, reciprocating or other type of saw. Screw 1x4s along the cuts on both sides of the wall.
4. Ensure that appropriate wall alignment and scaffolding system is in place for safe installation.
5. Using appropriate lifting equipment, place the sloped gable wall in place in the squared wall. Pieces of plywood can be screwed into the 1x4s during the placement to help contain the concrete.
6. Make sure all necessary roof attachment hardware is available prior to concrete placement, as it must be installed during or immediately following the pour.

3. Stack all block courses stepping at each course, leaving a small amount of block to be cut off once wall is completely stacked.
4. Using a chalk line mark the line to cut the gable pitch at desired angle on both sides. Cut on chalk line for desired finished gable.
5. To prevent debris from falling into the wall cavity, remove the blocks after marking with a chalk line and cut each block on the ground then reassemble the gable.
6. Brace gable with proper braces to secure.
7. When pouring gable, the concrete will work fine at a 5-1/2" to 6" slump mix design unless gable slope is too extreme.
8. Go slow and remember to set anchor bolts for the top plate.

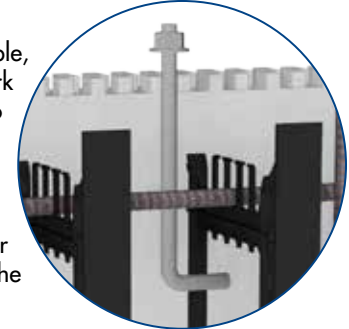

EXAMPLE

A gable cut usually starts at the inside face of the wall. Align the first block so webs align vertically. If the pitch of the roof is a 6/12 this means the walls rises 6-inches per lineal foot of run AG.

GABLE CONSTRUCTION OPTION 2

1. Another option for construction of a gable wall is to assemble the gable in place.
2. Allow blocks to run past your desired pitch angle or cut.

If the inside span is 24-feet to the peak or top of the gable would be half the distance or 12-feet. 12x6 is 72" or 6-feet. You can stack the wall on the floor, snap lines and cut.

Cut one side first, then use the cuts to cut the other side.

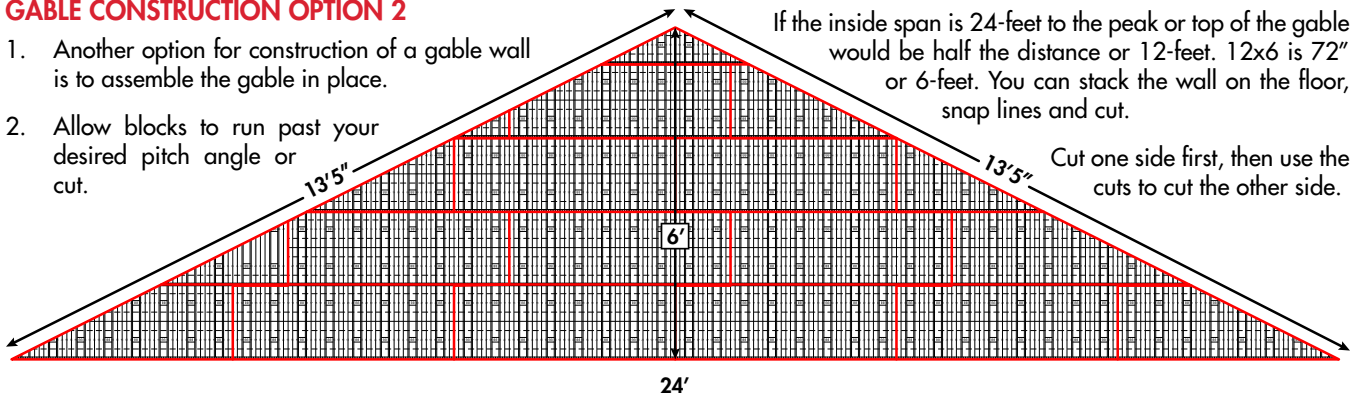

BUILDBLOCK TECHNICAL & INSTALLATION MANUAL

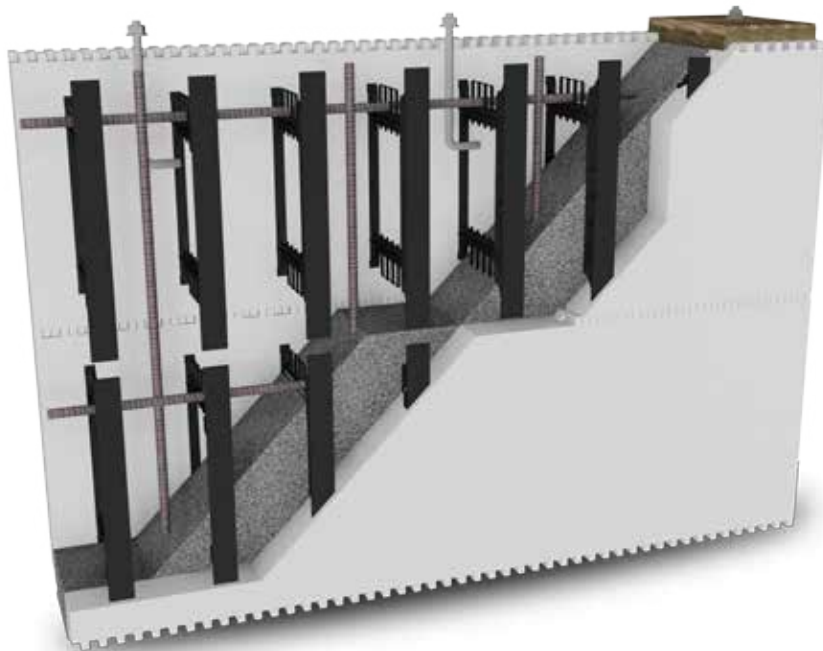

Figure 5.14.1 Anchor bolt placement in an ICF wall. Notice the overlap with vertical rebar and horizontal rebar depth.

5.14 ANCHOR BOLTS

Anchor bolts are the most commonly used fastener for securing the plate at the top of an ICF wall. Most codes require a minimum of 7.5" embedment into the concrete. A 10" x 1/2" anchor bolt can meet this requirement using the distance to the top of the anchor bend. Typically 10" x 1/2" anchors are recommended unless otherwise specified. Some areas require the anchors to be hot dipped galvanized or stainless steel, be sure to verify.

Making the transition from a concrete wall to a wood-framed roof will require the placement of no smaller than 10" anchor bolts between 2 to 4 feet apart (see anchor bolt engineering diagram). The placement can be site, code, or regionally specific, based on wind and other load requirements. Consult your local building requirements and engineers.

Treated lumber used as the plate will require an anchor within 1 foot of each end of the plank in addition to specified spacing.

Place bolts immediately after screeding the top of the wall level. Make adjustments for the top plate material lengths by marking anchor bolt locations prior to the pour. This will prevent missing necessary anchor bolts needed to correctly set the top plate. Leave bolts a minimum of 2-1/2" above the concrete when using a 1-1/2" thick wood plate.

TIPS FOR PLACING ANCHOR BOLTS:

- Before the pour, determine where you will be placing anchor bolts and mark the forms near the top of the wall accordingly.
- Allow ample time for placement of anchor bolts.
- Level out and trowel the top of the wall.
- Set anchor bolts quickly after the top of the wall is finished to ensure solid placement.

- Stagger bolt placement inside to outside. This better secures the top plate to the top of the wall and will help prevent warping.

This picture shows a 10" anchor bolt set in the wall 2-1/2" from the concrete to accept a 2x12 treated dimensional lumber top plate with 1" bolt relief above the nut.

Anchor bolts have been used in ICF form construction since day one and have many applications. (See the CAD Details 6 through 14a and 23-24 for ideas and technical placement.)

Current IRC code requires 8" embedment (requiring a 12" bolt minimum) into the concrete. Note: Make sure anchor bolts extend above the concrete level at least 3/4 to 1" above your plate height for proper tightening.

ADDITIONAL ANCHOR BOLT USES:

- Secure rim joists.
- Place perpendicular to vertical walls to attach heavy gauge steel angle for brick ledges or other areas creating bearing support. See CAD Details 14, 29 and 35.

BEARING POINTS IN ICF WALLS

To form a solid concrete bearing point in the face of the wall:

- Cut a round or square hole in the wall between two webs.
- Secure anchor bolt to a piece of plywood or dimensional lumber larger than the hole.
- Secure plywood to the ICF wall with the anchor bolt inserted into the hole. The wood keeps the concrete from spilling out onto the floor and you have anchor bolts in the void ready to become surrounded by concrete. These can be made to any size for major supports or attachment anchors. See CAD Details 14, 29 and 35.

BUILDBLOCK TECHNICAL & INSTALLATION MANUAL

This page left intentionally blank.

BUILDBLOCK TECHNICAL & INSTALLATION MANUAL

SECTION 6: BASEMENT WALL PLACEMENT

6.1 FOUNDATION DRAINAGE

Foundation drainage is the ability to evacuate hydrostatic pressure and ground water up-surge. This is a vital factor for maintaining a dry basement. This will also prevent foundation problems caused by settling and erosion. Increased water will also decrease the bearing capacity of the soil.



Figure 6.1.1 Standard poured footings with slotted PVC and gravel draining to daylight or a sump pump.

FOUNDATION DRAINAGE GENERAL NOTES

- There are various amounts of foundation drainage that will be necessary based on the soil composition of your project.
- Foundation drainage may be accomplished through several methods: gravel surrounding the foundation, gravel with a PVC pipe acting as a french drain, foundation drain products such as Form-A-Drain, etc.
- A foundation drain may be evacuated to daylight by gravity, or use of a sump pump if the grade cannot drain to daylight.
- Foundation drainage does not take the place of basement waterproofing. See Section 6.4 for details.
- BuildBlock recommends the use of the Form-A-Drain foundation drainage system pictured in this manual.



Figure 6.1.2 Standard french drain using slotted PVC pipe:



Figure 6.1.3 Basement wall showing footing using Form-A-Drain, and Cactus Board waterproof floor edging.

FORM-A-DRAIN

This system is a plastic lineal with slits on one side is covered by a silt cloth to avoid silting in the drainage system. The system is designed to form the footing and is inter-connected with PVC pipe to create an outside/inside french drain that stays in place without wasting or using wood. This will either drain to daylight or to a sump system. Note: Always use a silt landscape fabric over Form-a-Drain to prevent silting from sand or fine soil debris. This product no longer includes silting material in the product itself.



Figure 6.1.4 Form-A-Drain footing layout with rebar placed on chairs and Form-A-Drain Spacer Straps.

FORM-A-DRAIN EXAMPLE

- This basement footing was specified to 18" in depth, so the trench at the bottom of the grade was dug 10" deeper than the 2x8 FAD lineals.
- The FAD profile used was 8" and built on top of the trench.
- Steel was placed and the lineal braced with FAD spacer straps.

BUILDBLOCK TECHNICAL & INSTALLATION MANUAL

- The forms were wet-set into the wet concrete footing. Note the string-lines and the use of a form over a corner section to hold it in place as mentioned in the wet-set step-by-step instructions.



Figure 6.1.5 String lines used to ensure square and ICF form above corner forms locking corner in place until set.

- A fine gravel backfill was placed to the top of the lineal after the first course was placed. Additional gravel was placed after the wall was built and poured to the height of at least one course of block and waterproofed.

- Another layer of silt cloth was placed on top of the gravel before the backfill was placed, after the walls were poured and the floor trusses were placed to help support the walls before further backfilling after the walls were poured.

CAUTION

Never backfill basement walls until the floor system is in place to support the tops of all walls from moving in from backfill pressure.

Any drainage system matches the shape of the outer profile of the structure and either drained to daylight or to a sump drain.

If a sump is used, it will most likely reside inside the basement and plumbing will have to run up a wall, through the footing or under it. The french drain is often covered in silt cloth and gravel much like the Form-A-Drain system.



Figure 6.2.1 ICF walkout basement and garage braced and poured.

6.2 STACKING BASEMENT WALLS

Basement walls are stacked using the same methods as above-grade walls. They may be wet-set or dry stacked for the first course blocks. The notable differences between above grade and below grade walls are: the use of an 8" or larger form, above grade walls typically use a 6" or larger form; more closely spaced or larger size rebar schedule to handle the backfill pressures; rebar placement on the tension side of the wall and fewer windows to build.

Follow the same guidelines and methods for stacking ICF walls and ensure correct rebar placement per the Prescriptive Method, local codes, or project specific engineering. It is a good idea to stack one course higher than the basement ceiling height to envelope your floor system trusses. (See second floor truss options in Section 5.2.)

Either 6" or 8" forms, or larger may be used for basements, depending on soil conditions, backfill heights, and floor levels

above the basement. It is very important to consult an engineer regarding local codes and soil conditions when determining the best size of form to use for a specific project.

WHAT TO SEE:

- Braces and alignment system installed with planks.
- Safety is important. Install railings as necessary to comply with OSHA and other requirements.
- Ensure service penetrations are created properly.
- Extend block one additional course above ceiling height to provide embedment for floor system if using ICFs on the level above.
- Ensure floor system is in place before backfilling.
- Follow all guidelines for proper foundation drainage and waterproofing.
- Properly place a gravel bed over drain system.

BUILDBLOCK TECHNICAL & INSTALLATION MANUAL



Figure 6.3.1 ICF walkout basement with brick ledge installed to support masonry veneer above grade.

6.3 BASEMENT WALL BRICK LEDGES

When attaching masonry finished to BuildBlock ICF basement walls adequate support at the base of the wall is required. This is usually the top of the wall in basement applications just below grade. This bearing ledge is created through the use of a BuildBlock Brick Ledge form. The stone or brick finish is installed using convention methods complying with site specific engineering and local building codes.

When masonry veneers are to be used over a BuildBlock ICF wall a Brick Ledge Form can be installed at varying elevations to create a structural base without the need to extend full width bearing from the footing up. If the BuildBlock walls are continuing up the veneers can be attached with standard wall ties screwed to the webs 6" on center, or in some cases, for commercial and tall walls a two part fastener can be used.

The brick ledge form can be used in several applications and isn't limited to basement use. Brick ledge forms can be used:

- Below a pier and grade beam foundation (See CAD Detail 26.) This is difficult to waterproof and not recommended.
- An interior ledge for second story floor support (See CAD Detail 34.)
- Brick ledge forms can be cut to create inside or outside corners as necessary. Cut marks are located on top of all brick ledge forms to help you. (See CAD Details 41-44.)
- Standard Brick Ledge (See CAD Details 16-19.)

BRICK LEDGE INSTALLATION

- Stack the brick ledge course at the appropriate height to ensure the ledge is correctly located.
- It is vital to have this bearing ledge engineered and built with required rebar and stirrup placement. Seek professional engineering for this or review BuildBlock brick ledge engineering tables.

- If brick ledges need to be staggered due to the grade of the site and project design, you may need to combine other forms to create the appropriate ledges.
- Understand that a 6-inch ICF block may not achieve proper backfill pressure engineering.
- Consult the Prescriptive Method for Insulating Concrete Forms in Residential Construction (Second Edition) and your local structural engineer.



Figure 6.3.2 Brick ledge forms installed at varying heights to support masonry facade above grade.

BUILDBLOCK TECHNICAL & INSTALLATION MANUAL

MECHANICAL BRICK TIE OPTIONS

The use of metal ties in brick masonry dates back to load-bearing masonry walls in the 1850s. The size, spacing and type of ties include various sizes, and configurations. These ties were developed for load-bearing masonry, cavity walls and brick veneer construction.

BuildBlock recommends the POS-I-TIE® Veneer Anchoring System. The POS-I-TIE® is a two piece system for attaching Brick and Stone Veneer to various existing backups. It incorporates a barrel-screw piece which allows easy installation using an ordinary drill with a special chuck adapter.

The barrel makes a positive contact with the backup wall transferring all compression and tension loads to the backup wall and not to the EPS insulating material.

The screws are a part of the system; therefore, no inferior screws can be substituted. The barrel is manufactured of ZAMAC 3 - a 92% zinc alloy. The screws are heat treated and Stalgard® coated for maximum corrosion resistance.

Wire ties are available in Hotdip Galvanized After Fabrication or Stainless Steel. Visit <http://heckmannbuildingprods.com> for more information.

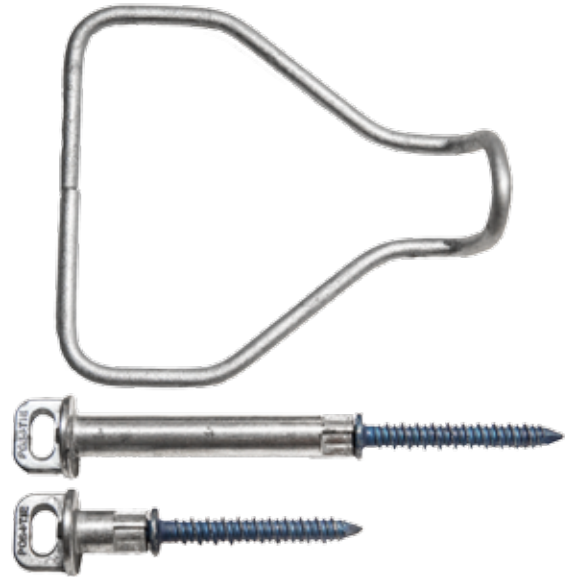

Figure 6.3.3 POS-I-TIE® mechanical brick tie system. The tie can attach to the BuildBlock ICF webs or the concrete itself. When purchasing choose the correct barrel length for you needs.

BRICK LEDGE USING STEEL ANGLE

This method uses anchor bolts embedded into the wall to secure a steel angle plate to create a ledge for the brick or stone. The steel plate will be removed to install waterproofing, but will support the brick or stone above.

1. Establish the route of the brick ledge.
2. Cut openings 6" on center between webs, slightly less tall than the steel angle to be used per engineering.
3. Drill steel to create holes for J-bolts to be inserted into the concrete.
4. Insert J-bolts into block void and hook the J-bolt on the horizontal rebar already in place if possible. This will create a doubly secure connection between the steel plate and the reinforced concrete.
5. After the concrete is poured and set, remove the steel plate to install appropriate waterproofing.
6. Install waterproofing over the entire wall.
7. When reinserting the plate around the waterproofing use a star pattern to allow a pass-through for the bolts. Also use a waterproof caulking between the waterproofing and the backside of the plate. As the two are joined together the caulking will press out around the bolt completing the seal. Secure the bolt back in place and tighten securely.



Figure 6.3.4 POS-I-Tie® mechanical brick tie assembly.

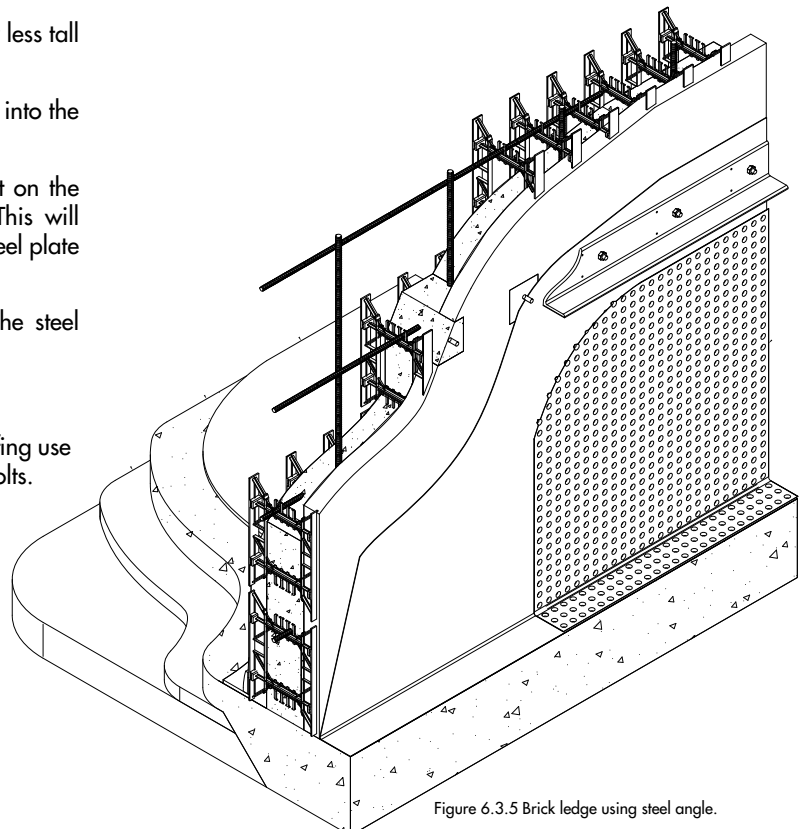

Figure 6.3.5 Brick ledge using steel angle.

BUILDBLOCK TECHNICAL & INSTALLATION MANUAL



Figure 6.4.1 Below grade ICF walls with Tamko TW-60 peel and stick membrane waterproofing applied and DMX-AG Dimpled Membrane to prevent damage from backfill and provide hydrostatic pressure relief.

6.4 BASEMENT WALL WATERPROOFING

Building codes require walls below grade with an interior enclosed space that is habitable be waterproofed. There are many waterproofing systems to choose from. Many of these are widely used and perform exceptionally well.

Newer methods are designed to save labor and material costs. Spray-on membranes for ICF are beginning to grow as well, but currently depend on the regional skills and availability of applicators. Research options and choose the solution that will provide the best protection for below grade protection for the life of the structure. BuildBlock recommends that all below grade crawlspaces or basements be waterproofed even if not used as a living space. Consult local codes, though if not habitable the choice is yours.

In many installations, a combination of materials offers the best waterproofing performance. The primary methods of waterproofing are: peel and stick membranes, liquid systems that are sprayed, rolled, or applied with a trowel, and dimpled drainage mats which are fastened to the ICF walls.

WATERPROOFING OPTIONS:

- A self-adhesive 60 mil membrane such as Tamko TW-60. This can also be used in conjunction with a dimpled membrane such as DMX-AG to protect the waterproofing from backfill and provide additional hydrostatic pressure relief. This product is available from BuildBlock.
- An ICF compatible spray-on membrane. (Caution: Do not use a petroleum based paint or primer. These products will dissolve the EPS foam.)
- A one-step mat type protection (ex. SuperSeal, DMX-AG). This type of plastic mat provides an air gap between the ICF wall and the surrounding earth.

- As hydrostatic pressure increases it will displace the air and allow the pressure to be released and avoid attempting to penetrate the wall. It works in many locations that have soils that perk or drain well. May require a membrane in some areas.
- Other locations that hold water require both the membrane (self-adhesive, roll-on, or spray-on), plus the DMX-AG type mat.

CAUTION

When installing a waterproofing membrane, ensure the membrane is mechanically attached using a thin furring strip of wood or metal at the very top of the wall. It is also possible to use basket screws spaced a maximum of 12-inches. This will ensure the adhesive has adequate time to bond to the foam or primer. This is critical in cold and hot weather or when significant temperature changes occur such as daytime heating and cooling overnight.

Please contact BuildBlock technical support and review CAD Details at the back of this manual for more information.

Figure 6.4.2 Tamko waterproofing products.

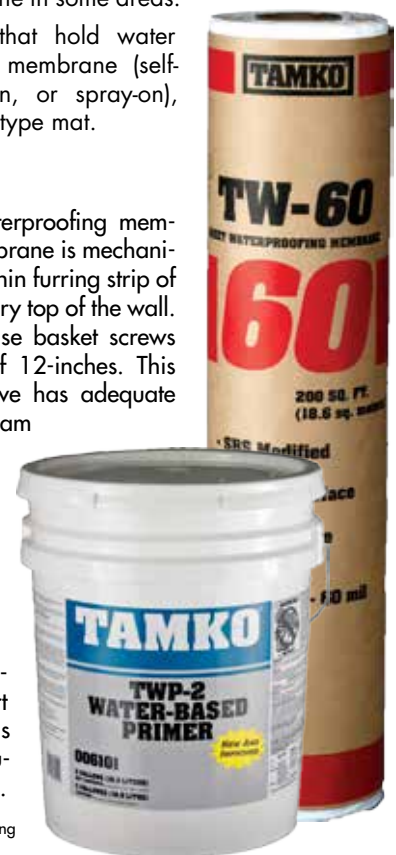

BUILDBLOCK TECHNICAL & INSTALLATION MANUAL



Figure 6.4.3 Installer placing a self-adhesive waterproofing membrane. Notice the 4" of membrane at the bottom of the wall.

1. Clean the block face thoroughly of debris and remove any yellowing from UV breakdown. You may use a broom, brush, or wash the walls. Walls must be free from all oxidation and debris.
2. Fill any holes or major openings in the foam surface, rasp foam level and smooth with the foam surface.
3. Apply an ICF primer to help the adhesive stick.
4. Precut membrane for lengths for the entire height of the backfilled wall plus 12" above grade and an additional 4" for the base.
5. Attach membrane to the wall beginning at 1' above backfill grade and roll downward, overlapping 4" and terminating 4" or 6" over the footing. Only remove about 12" of the backing at a time from the top working down as you attach the membrane to the wall. Work slowly and eliminate air bubbles as you work down the wall. Be cautious not to damage the membrane.
6. Seal the top of the membrane with a thin metal strip to keep the membrane from releasing from the wall. The DMX attach brackets may work well for this. You do not want any construction debris to get behind this membrane either.
7. Use an adhesive caulk such as MP1 to seal the membrane against the concrete and seal the bottom edges. It is very important to seal the bottom edge thoroughly.
8. Use an ICF-friendly mastic such as Hydrocide 800 B to cover all terminations and edge seams in the membrane, top and sides, on the outside of all seams.
9. Follow manufacturing installation instructions to attach a protection mat such as DMX at the top of the wall. This prevents damage from backfill material which could punch or tear holes in the membrane.
10. Do not screw into the membrane to attach the DMX or platon products to the wall unless above grade only. Use mastic with a trowel as an adhesive to stick the DMX or platon to the wall. Overlap the dimples in these products and lock the edges together. Use mastic to secure the bottom of the material. Backfill as soon as possible once



Figure 6.4.4 Peel and stick membrane attached to the ICF wall and sealed to the top of the footing.



Figure 6.4.5 DMX AG air gap membrane is installed over the peel and stick membrane. This prevents damage from backfill as well as relieves hydrostatic pressure. Do not use screws below grade through the membrane, it will leak.



Figure 6.4.6 Waterproofing and air gap membrane is carried at least 1-foot above backfill level. Comply with local codes.



Figure 6.4.7 Extend waterproofing into window openings to ensure moisture cannot enter.

BUILDBLOCK TECHNICAL & INSTALLATION MANUAL

floor system is in place. Heavy winds can damage this installation if not backfilled once installed. Be cautious when backfilling not to pull down the platon or DMX.

Figure 6.4.4 shows the platon waterproofing system:

- One step application barrier product with hangers and termination strips. (NOTE: more hangers are recommended.)
- Overlap all edges and seams at least 6".
- The DMX-AG System creates air gap between wall and backfill to stop hydrostatic pressure.
- Peel & stick membrane around the top is not yet installed.
- Note: BuildBlock assumes no liability on basement waterproofing. Seek your local supplier for application methods. A leaky basement means problems for years to come.

The picture below speaks loudly about waterproofing, basement walls, brick ledges, and how to prepare for natural grade footings that will tie into your basement walls.

PIERS

Depending on the design of a home, sometimes the basement doesn't share the same walls as the home. When this occurs, it may be necessary to build a pier to support the larger footing for an ICF or wood frame structure above since the footing would be placed on previously disturbed soil and could settle.

Example:

- The basement wall has been built to receive a wood frame structure on above that does not share below grade walls.
- This project had three places in which the house's footings and stems were intersecting with the basement.
- The contractor included three piers in the basement footings.
- The elevation of the piers were built to be the height of the bottom of the footings for the house on grade above. (Note: The basement was smaller in size than the structure above.)
- The rebar in the pier was later bent into the footing trenches dug into the backfill and then encapsulated by the new footing concrete on-grade.
- The reason for this method is that an absolute bearing pier allows for no movement in backfilled soils and the basement wall will suffer no penetrations regarding tie-in steel or other attempts to tie a basement wall into a footing for a structure above. Without this method, many foundation leaks would have been created.

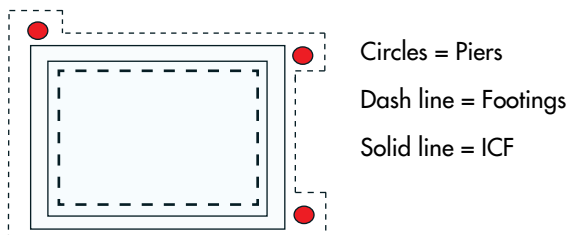

Figure 6.4.8 Basement ICF, Concrete Pier, and Footing design.

- The basement walls are waterproofed and no penetrations are created that could cause water leakage into the basement cavity.
- The footing above was formed with Form-A-Drain and used a protection mat with silt cloth to prevent silting or debris from entering the Form-A-Drain. See figure 6.4.8 for overall design.
- Clearance of 4" from the wall to the pier so the wall could be properly waterproofed.



Figure 6.4.9 Basement with pier for footing above. This is done to prevent sagging of footing as the disturbed soil settles.

OTHER PIER OPTIONS

A square pier can be created by stacking CMU's such as 8" concrete block beside each other to create a 16" square pier. Alternate every other course turning the block 90 degrees. Pour the cores full when pouring the walls and add long enough vertical reinforcement in each core that it can be bent into the next footing. Consult an engineer for the best method for your project.

BUILDBLOCK TECHNICAL & INSTALLATION MANUAL

6.5 TERMITE PROTECTION FOR BELOW-GRADE APPLICATIONS

The EPS foam in BuildBlock ICFs is not a food source for termites but they may burrow into unprotected foam surfaces in search of food (wood). While termites cannot compromise the strength or integrity of the BuildBlock wall, they could burrow through the foam to reach and damage untreated wood.

Below-grade use of foam insulation products like ICFs in termite infestation regions require “an approved method of protecting the foam plastic and structure from subterranean termite damage.”

It is very important that you refer to your local building codes to determine what constitutes “approved methods of protection” in your area.

TERMITE PREVENTION STRATEGIES

There are a number of options when building with ICFs to protect your home from termites.

PREVENTOL

One of the simplest methods is to use ICFs that were molded with Preventol, a termiticide developed by Lanxess, added to the EPS foam during manufacturing. This product coats each bead with a thin layer of protection, preventing termites from tunneling through the foam. BuildBlock Building Systems currently offers this product in our Orlando Florida facility, and is planning to expand this offering in the future. BuildBlock believes this is the best solution, and should be used exclusively below grade in high termite infestation areas, as well as for the first few courses above grade.

These blocks are a special order item and will be priced at the time of order.

TERMITE SHIELD

Termite shields are designed to create a barrier that the termites cannot tunnel through, and thus they are forced out of the foam. They are typically used as a cap, extending across the full width of the ICF and out up to 3 inches, or embedded into the concrete to prevent access on the inside, forcing them out of the sheltered environment of the foam. This creates a highly visible location to inspect for mud tubes. Mud tubes are created by termites to shield them from the sun and dry air. They also provide an easily identifiable trail during a visible inspection. The termite shield doesn't actually block them; it merely forces them into the open where they can be seen. Once you know they are there, make a quick call to your local pest control center to have a treatment program started.

Other termite barriers are used below grade as part of the ICF installation. Some ICF waterproofing materials have been shown through testing to be termite resistant (Colphene ICF and Polyguard XT). Other methods include using a stainless steel mesh (Termimesh) on the outside of the waterproofing to prevent their entry. It is also a good idea to caulk any exposed cracks or expansion joints with a good quality silicone based caulking. Cold Joints can also be sealed with waterstops or other mechanical seals that are embedded into the concrete.

Local pest control companies also have multiple solutions that they can place into the soil which will keep them a good distance from the home, and prevent them nesting in the area. Often these will need to be reapplied on a regular basis. It is important to have an application of this sprayed around exterior areas with foam below grade, as well as under porches and slabs before pouring them.

PREVENTIVE MAINTENANCE

Keep the area around your home clear of wood products and brush. Do not pile or stack wood near the walls. This can create a haven for them and draw them to the home.

Each of these alone will provide a small measure of protection against termite infestation, but together can be a very effective termite deterrent. It is recommended to use a combination of these, to better protect your valuable property.

Termites look for the easiest food source and the more barriers you create between your home and them, the more likely they will pass you by.

BUILDBLOCK TECHNICAL & INSTALLATION MANUAL

SECTION 7: SERVICE & UTILITY PENETRATIONS



Figure 7.1.1 Complex service penetrations before additional strapping.

7.1 INSTALLING UTILITY ACCESS

Utility access is a very important step in planning, prior to any concrete placement. There are many reasons for penetrations through the ICF wall.

COMMON PENETRATION TYPES

- Natural Gas / Propane
- Electric
- Plumbing
- Water
- Communications
- HVAC
- Hydronic Flooring
- Dryer / Range Hood Vents
- Other needs.

SERVICE SLEEVES

Service sleeves must be installed prior to pouring concrete to accommodate services that pass through outside walls. Penetrations can be created after the walls are poured, but that requires boring through the concrete.

Planning ahead will save time and labor after the pour. Keep in mind that concrete in the wall will harden beyond its yield strength by 25% or more.

Access ports are easy to install by inserting a PVC pipe through the wall.

CREATING ICF WALL PENETRATIONS:

- Use a length of PVC pipe of proper diameter and cut a sawtooth-cut pattern into one end of the pipe. This is the best method, is very fast, and is done for each size of pipe used.

- Place the pipe against the wall, press and rotate to begin cutting into the foam. As you bore into the wall be careful not to let large pieces of cut foam fall into the wall cavity.
- You may also use a wider-than-wall piece of PVC and use it to bore into the foam.
- Make an imprint in the foam with the PVC sleeve. Use a long keyhole saw to cut through the foam. Make another imprint, cut the other side making sure they line up.
- You may also use a wood boring bit slightly larger than the PVC pipe and cut a hole in one side of the foam. Use a dowel or piece of rebar to put a indentation marking the center of the penetration through the entire block. Then use the boring bit on each side and slide the pipe in place.
- Secure the sleeve with adhesive foam.
- Brace or secure additional strapping if necessary.
- Cut off any excess PVC pipe at a later time.
- Spread sleeves apart somewhat so concrete is not obstructed by the sleeves during the pour.
- Proper vibrating is required around all sleeves during the pour.
- Working carefully perfectly round holes are easily cut to receive the pipe. Fill the voids with spray foam. Quality speaks for itself.



Figure 7.1.2 Drill hole the same diameter as the pipe sleeve to be used.

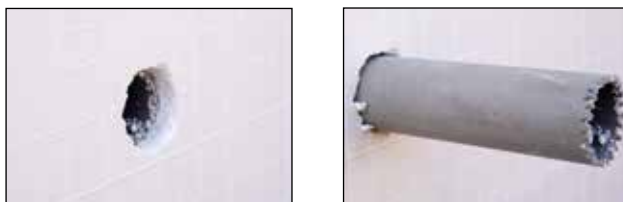

Figure 7.1.3 Cut small teeth on one end of the pipe sleeve and use to saw through the other side of the block to create a smooth opening.



Figure 7.1.4 Secure any space around the pipe sleeve with foam adhesive before the pour.



Figure 7.1.5 Add additional strapping if necessary, cut pipes flush after the pour for a seamless finish.

BUILDBLOCK TECHNICAL & INSTALLATION MANUAL

This page left intentionally blank.

BUILDBLOCK TECHNICAL & INSTALLATION MANUAL



Figure 8.1.1 ICF walls braced and windows bucked before a pour.

SECTION 8: WINDOWS AND DOORS

8.1 WINDOW AND DOOR BUCKING OPTIONS

Openings in ICF walls must stop the flow of concrete and provide attachment points for the installation of doors or windows. This process is called bucking. It is the same concept as completing end walls or bulkhead walls as discussed earlier in this manual.

The bucking size and type is usually determined by the type of opening and the needs of the product to be installed. Consult door or window manufacturers for any specific needs during plan review.

Bucking is generally a permanent part of the wall once the concrete is poured. This creates attachment points for windows and doors and wall finishes. This section will address the most popular types of bucking material: Treated Wood, Metal, Vinyl Bucking, and ICF Foam Bucking.

It is recommended that bucks be pre-built. This will ensure correct sizing, saving time and labor. It is critical that the type of buck material and its thickness be correctly accounted for when creating rough openings. Bucking should be braced appropriately to ensure it stays in place during the pour and remains square and plumb. Bracing horizontally and vertically is required to prevent the buck from shifting due to the concrete forces which could prevent the installation of the door or window without major structural changes.

TREATED WOOD

There are two ways to use treated dimensional lumber to buck a BuildBlock wall opening. Treated wood can be placed inside the wall cavity or across the width of the form.

INSIDE MOUNT

Treated wood can be mounted inside the ICF wall cavity. This is sometimes referred to as a sub-buck.

- Rip the 2X material to fit into the void of the wall.

- Use foam adhesive and screws with plastic cap washers inserted from the side to secure the buck every 6" on both sides around the opening.

OUTSIDE MOUNT

- Match or rip width of the lumber to the block width.
- This utilizes the entire width of the dimensional lumber and covers the entire profile width of the block.

With both methods, it is recommended that you use 6" galvanized ring shank nails, anchor bolts, or tapcons set through the wood into the void area so the concrete can capture the nails and the bucks remain adhered to the concrete when the bracing is removed. Alternate these left and right of center every 8" to 12" up and down the buck and across the header and window sills.

METAL BUCKING SYSTEMS

Metal bucking systems incorporate a support flange that fits around an ICF wall. Metal systems are cast in place and provide extremely solid support for windows or doors. Typically metal bucks or door frames are used in specialty applications such as explosion resistance. It is also possible to install steel door frames and pour them in place. This is very similar to bucking where the frame itself becomes a buck.

If required, some metal bucking systems exist that can be removed after pouring concrete to provide exposed concrete. This is uncommon, but can be used to create a fire break between the outside and inside walls.

Wood frame bucking could accomplish the same task if removed after pouring. If using this method, do not use the 6" ring shank nails.

BUILDBLOCK TECHNICAL & INSTALLATION MANUAL



Figure 8.1.2 V-Buck ICF bucking placed into the walls. Notice cross-bracing on corners to ensure it remains square.

VINYL BUCKING SYSTEMS

Vinyl bucking products such as VBUCK have been very popular for ICF construction for many years. The bucking material is light weight, easily assembled, and removes organic material from the wall. Vinyl bucking does require additional bracing to ensure it doesn't deform during the pour.

The Vbuck system includes the 16' planks, outside and inside corner connectors, and corner braces. VBUCK corner braces are optional; plywood triangles will work well too.

Vbuck was designed with a J-channel for receiving concrete which eliminates the need for ring shank galvanized nails. Vinyl bucking seats perfectly with BuildBlock ICFs and creates a clean, tight seal. Ensure rough opening sizes match vinyl bucking profile dimensions for a successful installation.

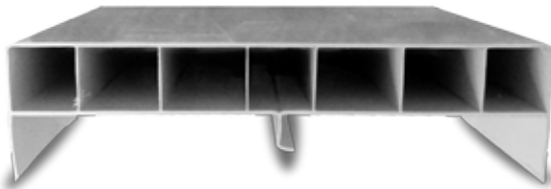

Figure 8.1.3 Section of V-Buck Vinyl Bucking. When assembling seal exposed holes with spray foam to prevent concrete from filling the buck and creating a thermal bridge.

When assembling vinyl bucking, use foam adhesive to seal the open end channels. This will prevent concrete from entering the channels and maintain a dead air space between the exterior and the concrete.

ICF FOAM BUCKING

In the last few years ICF Foam bucking has become more popular. The advantages of an ICF buck that it uses the same materials as the ICF walls. This provides the same type of insulation and attachment that ICF blocks use.

ICF foam bucking uses a plastic embedded web made from either polystyrene or polypropylene and EPS foam. Choose a foam buck designed for the size block being used. ICF bucking must be completely braced on the inside of the opening. This is accomplished by building a frame inside the opening as well as using diagonal braces on corners to ensure the opening remains square.

INSTALLATION NOTES

- Keep in mind the thickness of the bucking material and ensure the rough opening is sized correctly for the required opening size.
- We recommend 1/2" extra for width & height. This allows 1/4" completely around the window or door. Concrete once poured cannot easily be adjusted.
- Brace each opening by building a complete frame inside the opening with cross braces. Add diagonal braces to ensure opening remains square during the pour.
- Recheck all openings for square and plumb before and during the pour. There is only once chance to get it right.



Figure 8.1.4 Fill holes cut into the bottom of a window. Ensure entrained air can escape when pouring a window to prevent any voids.

8.2 BUCK CONSTRUCTION

When using wood for bucks, BuildBlock recommends 2x6, 2x8, 2x10 or 2x12 treated lumber as the best choice. The outside dimension of the BuildBlock 11" form is closest to 2x12 dimensional lumber. You can rip 2X material to fit the forms whether you place your bucks inside the foam cavity or to the outside of the blocks.

Bucks will be subject to a significant downward and side-to-side pressure. Build the bucks as you would a header in a door or window opening so the top plate rests on the sides. The bottom sill needs to fit inside the sides resisting the concrete pressure. Openings in BuildBlock walls need to be designed with the proper reinforcement rebar on all sides and, most importantly, the top (referred to as the lintel). See our lintel engineering chart or the Prescriptive method details.

DOOR BUCK CONSTRUCTION

Start by knowing the required rough in dimensions for all openings. These may be obtained from your window and door suppliers. Make sure the inside dimension is large enough to allow for your door system jambs and shimming to plumb your installation. Door bucks will usually only have three parts – two sides and a top. To keep the bottom aligned, a temporary support should be used in the bottom when bucks are placed. This is removed after the pour.

BUILDBLOCK TECHNICAL & INSTALLATION MANUAL



8.2.1 All bucks must be angle braced to keep them square and true.

WINDOW BUCK CONSTRUCTION

Window bucks differ from doors in that they have a bottom. If using wood, you can use treated 2x4s on the bottom, spread out to the outside, allowing a space in the middle to fill under the openings with concrete. The bottom pieces need to fit inside the sides to act as a brace for concrete pressure pushing inward.

If using Vbuck or foam bucks, a 4" hole saw on 12" centers will make ample holes for you to fill the underside of the opening in order to eliminate voids in this area. After the pour, clean the bucks with a towel while the concrete is fresh. It's much easier to do this now than later, and you'll have a nice clean opening when you are finished. A clean job encourages other trades to do higher quality work.

Keep inside dimensions or rough openings large enough to allow for proper window placement and shimming if necessary. It's very difficult to make an opening larger if the window doesn't fit. A little extra space goes a long way.



8.2.2 Note the concrete threshold poured to the outside wall edge. Bucking was properly braced during the pour to prevent any warping or cupping. Doors do not use bucking on the bottom of the door frame. Also notice the slab poured over the door threshold by cutting the block out 1-2" below the door height.

8.3 DOOR PLACEMENT

- When doors are located and bucks prepared, place the bucks in the walls and brace them firmly.
- To lock the bucks and prevent movement from side to side use 1x4 wood screwed into a buck and back-braced to a web tie to help hold it.
- You can build a brace from 2x6 material, banding the inside of the buck in the center, on all four sides and then supporting the banding with T or cross-bracing.
- BuildBlock recommends using an inside band no smaller than the width of the concrete core for bucking in the center of the buck to prevent the buck from curling inward during the pour. Not needed for wood bucks.
- Vbuck also sells a yoke and tie system to brace bucks. BuildBlock webs have 3/16" holes pre-made into all webs to allow the use of this method. See the Vbuck website at <http://www.vbuck.com> for additional information.
- When placing the buck in the wall, allow for a 1/4" gap between the forms and the back sides. This will allow for adjusting the buck prior to pouring.
- When using wood bucks to the outside of the forms, a 3 1/2" strip of wood on both sides around the buck perimeter made from 1x4 or standard plywood to accommodate the forms will help stacking blocks around the buck and will secure the buck and blocks like Vbuck does. This is not required but very helpful. If not used your bucks will either have to be inside mounted or glued in place to the blocks before pouring. Make sure bucks are square and plumb.
- To insure the buck is anchored into the concrete, use 6" galvanized ring shank nails with no less than 3" into the void, preferably further. Use 2 nails every 16" minimum.
- With wood bucks, the nail or screw anchors are needed on both sides of the bucks every 8" the entire length of the sides and header.
- When building your walls over the openings (called lintels), consult the Prescriptive Method, your engineer's specifications for steel rebar reinforcement, or the BuildBlock engineering tables, as this is a critical step for structural integrity of all lintels.
- After everything is in place and you have braced the buck properly (bottom brace, top brace, and 2x4 T bracing), check for level and plumb. Keep the braces on your door and window headers for seven days after the pour to insure the concrete has cured properly. Do not load your headers for fourteen days minimum without bracing in place. You may remove all cross bracing for side to side loads in 1-2 days.
- You can install flashing after the concrete has been placed and the doors are installed.

BUILDBLOCK TECHNICAL & INSTALLATION MANUAL



Figure 8.4.1 ICF Foam Bucking placed in the wall and cross-braced appropriately.

8.4 WINDOW PLACEMENT

Window bucks are set in place when you have reached the appropriate wall height level for the base of the window. In most cases, you are placing window bucks on your second course. It is vital that you have a window schedule with all rough opening sizes.

If building for a customer, make sure all parties sign off and agree on locations and sizes. It's costly to have to go back and re-set or cut in new windows and doors.

- Set your bucks around the perimeter close to its location in the wall.
- Once in place, the bucks should be secured much like the door buck techniques, made straight and plumb, and the forms stacked around them.
- Once again, we stress that you should have your lintel, side and top support rebar ready to install and distributed along with the bucks. (See lintel diagram and openings engineering page or comply with the recommendations supplied by your structural engineer or Prescriptive Method charts.)
- Make sure the height of all windows and doors are set correctly as specified.

- Plastic webs closer than 3" to the buck can obstruct the flow of concrete and could create voids. Keep a minimum of 3" or more between the last web and the buck. If this is not possible, be sure to mark the window side that is closer to the webs and remember to vibrate more during the pour to solve any concerns regarding concrete consolidation.
- Wood users use 2x4 treated material in the bottom of windows to crate a fill space under the openings.
- Vbuck and foam buck users can drill 3" or 4" holes to create a fill space or cut 3" wide square holes every 12-18" in the bottom of window bucks..
- Brace your bucks securely using the same 2x6 banding and cross bracing techniques for Vbuck and 2x4 cross-bracing for wood users. See Figure 8.4.1
- If any web fingers are within 3" of a buck header, cut the fingers off to allow concrete flow beneath them.
- A story pole comes in handy for setting your window header and sill heights. Example: Take one of your PVC corner dowels and mark the header height of your windows or doors on the pole and cut the pole off at that height. Place the pole at your opening and measure down to locate your sill heights. Before attaching your bucks to the wall, double check your header heights one last time with your story pole. (The pole is then reusable: Simply push the shorter piece into the corner hole first and push it down to the bottom with the longer one.) Note: Sometimes the doors will be (or can be adjusted to be) the same as the window header height around the structure.



Figure 8.4.2 For larger openings than 3' wide, additional bracing and "bracing legs" (long 2x4 wood legs screwed to the vertical bucks and run to a base plate will help keep your openings straight and plumb during the pour..

BUILDBLOCK TECHNICAL & INSTALLATION MANUAL



Figure 8.5.1 Arched windows and doors are easily integrated into BuildBlock ICF walls.

8.5 ARCHED WINDOWS AND BUCKS

Arched windows can be achieved using a variety of bucking methods.

VBUCK

Vbuck can create bucking for arched windows and doors. If you provide your openings to scale, they can make the radius for your particular job and ship them to you at an additional cost.

If you plan this in advance, in your bid process, you will not be surprised by extra costs associated with fabrication or shipping.

When these bucks arrive, use them as a template against the BuildBlock forms to cut the proper radius. (Mind your flanges.)

Contact BuildBlock for more information.

TREATED WOOD BUCKING

- Cut 2 pieces of 3/4" plywood the same width as your block and 3" longer than the rough opening width and with the same radius as the window to create 1-1/2" ends that will overlap the top of both side buck pieces once the arch is fabricated.
- Next trace the arch radius of your window opening onto a piece of plywood then attach small blocks of 2x2 wood along this arch radius line every 6". This will be your template.
- Take your first sheet of plywood and bend around the 2x2 wood blocks. Screw into the plywood from the

2x2 wood side not into the plywood side to hold the plywood in place in the arch radius you have created. Now place the 2nd piece of plywood directly over the first piece. Screw these two together on one end from the plywood side with 1-1/2 screws. Continue bending and screwing the 2nd plywood piece every 6 to 12" about 1" from both edges until the plywood is screwed to the first sheet radius.

- Unscrew the screws from the 2x2 back side of the plywood releasing the plywood arch. Reverse the arch sides to the template making sure both sides of the arch have the exact arch. If not you can reattach the nonconforming side as in the beginning, remove the bottom edge screws and re-screw them once the edges line up to the arch template.
- Note: Make sure you center the arch plywood so you are left with 1-1/2" on each end to rest on your window or door buck side pieces.

BUCKING CONSTRUCTION HIGHLIGHTS

- Radius and standard bucks in the building process
- Concrete threshold
- Interior and exterior bracing being set
- No internal buck bracing set yet

BUILDBLOCK TECHNICAL & INSTALLATION MANUAL

This page left intentionally blank.

BUILDBLOCK TECHNICAL & INSTALLATION MANUAL



BuildBrace Build1 used in a residential project.

SECTION 9: BRACING & ALIGNMENT SYSTEMS

9.1 BRACING OPTIONS

The use of a bracing and alignment system is critical for construction of ICF structures. These systems not only assist in achieving plumb and level walls, they also provide an elevated working surface during the stacking process.

Prior to the pour, these systems provide an active support to the stacked ICF wall and during the pour assist the ICFs in maintaining a stable wall until the concrete hardens.

There are several methods for bracing ICF walls during construction. They each have advantages. A proper bracing and alignment system is a critical step that should not be overlooked or taken lightly.

Bracing should be placed every 4 to 6 feet in a wall that has no openings. Corners should be braced in each wall direction. For walls with openings, place braces on each side of each opening (on the same side of the wall) to reduce movement. Openings should be strapped, bucked and braced appropriately.

SAFETY

Professional bracing systems are designed to meet certain safety standards. Consult the Occupational Health and Safety Administration (OSHA) standards for scaffolding and the relevant Canada Occupational Health and Safety Regulations regarding height, wind speed, and fall protection.

There are many types of bracing and alignment systems designed specifically for ICF construction. Ensure that any bracing system used when installing BuildBlock ICFs meets local, state, and national safety and building code requirements.

If using improvised bracing and alignment methods ensure that the system is sufficient to create straight, level, and plumb walls and appropriate safety precautions are taken while in use.

IMPROVISED BRACING

- 2x4 wood or metal bracing: Fixed angular braces such as these do not allow for quick adjustments, but can be re-used in the project elsewhere.
- 2x4 wood or metal with a turnbuckle installed in the down leg: Closer to a professional set of ICF braces; you will appreciate the adjustment capabilities.

TIP: Screw improvised braces to in-ground stakes. Adjustments to wall can be made more easily than when nailing. Wood bucks cut from 2x6 material 12" to 18" long can be glued to concrete floors or screwed to wood floors to attach the foot bracket of any bracing system without harming the underlying floor. If gluing, they must set for 2 hours or more before attaching the bracing system. When finished remove these with a floor scraper after job completion.

PROFESSIONAL BRACING SYSTEMS

BUILDBLOCK TECHNICAL & INSTALLATION MANUAL

There are many bracing systems made for ICFs. BuildBlock has evaluated many of these systems and endorses BuildBrace by Plumwall. This system is designed to work with BuildBlock ICFs and attachment points, offers superior safety options, and is cost effective for purchase or rental.

Bracing Components

Bracing and alignment systems all have similar designs and components:

- Vertical Strongback
- Horizontal Scaffolding Bracket
- Supporting Struts
- Footplank Supports
- Toeboard (typically 2X12 lumber reused at top plate)
- Diagonal Brace
- Turnbuckle Adjustment
- Handrail Supports
- Anchor Brackets

ABOUT BUILDBRACE

BuildBrace Insulated Concrete Form Bracing is a leading innovator in the field of high quality, easy-to-use ICF bracing systems. These ICF braces are engineered with an exclusive one man alignment control at platform level and are durably built for insulated concrete forms up to 24 feet high.



BUILD1 ALL-IN-ONE FOLDING ICF BRACING SYSTEM

No missing parts – just unfold and go with the BuildBrace All-in-One ICF brace. Designed for quick setup, easy alignment at platform level, storage and transport, the All-in-One gives you unparalleled productivity and efficiency.

BENEFITS:

- All-in-One Design
- Alignments Controls
- Screw Slots
- Triple Anchor Foot
- Safety Rail Mount
- Enclosed Adjustment
- Light Weight
- Available in 8', 9', 10' or 12'



BUILD3 3-PIECE ICF BRACING SYSTEM

Build3 combines an exclusive alignment control at the platform level with the simplicity and durability of a conventional three-piece system. The pin-on platform bracket mounts to the 14-gauge galvanized steel strongback with the outrigger connecting to the platform bracket.

BUILD3 BENEFITS:

- Alignments Controls
- 3-Piece System
- Screw Slots
- Triple Anchor Foot
- Safety Rail Mount
- Enclosed Adjustment
- Light Weight
- Available in 8', 9', 10' or 12'

24 FOOT ADAPTOR KIT

Take ICF to the next level with the BuildBrace Adaptor Kit giving you 24-feet in perfect alignment. By integrating flush with both the All-in-One and Build3 bracing systems, the Adaptor Kit is a 4-foot strongback extension that connects two 10-foot braces together.

This allows you to build and align walls at 10-feet, 14-feet and

BUILDBLOCK TECHNICAL & INSTALLATION MANUAL

24-feet. The Adaptor Kit's extended outrigger holds sturdy with double-walled tubing that is easy to assemble.

All are metal or aluminum, C-channel systems with turnbuckles to adjust your walls. Most have the ability to place walk boards for top of wall access and others interact with scaffolding for taller ICF pours. Visit the <http://buildblock.com> for bracing details.

If you are an ICF professional, we highly recommend that you invest in the proper bracing to help make your pours a consistent success every time. These professional systems will help you install faster and achieve more professional results. Most quality professional crews use these systems.

9.2 BRACING METHODS

INSIDE BRACING

When you brace inside the walls of a structure, you can use a 2x6 wood foot to attach your brace to. Use the foam adhesive to glue the wood to the slab and you will have a cleat to secure to. If you plan to stain the concrete slab, you might want to brace to the outside, as the glue will show through the stain process. You can also drill into the slab using tap con screws. If using a wood floor, just screw to the floor decking.

Note: Do not use screws if in-floor radiant heating is installed.

OUTSIDE BRACING

Bracing to the outside allows the inside space free of obstruction and creates a good workspace. We have seen contractors without walk-board bracing wheel men on roll-around scaffold to place forms and concrete. This is more labor intensive but works well.

9.3 BRACING TECHNIQUES

Once you have decided which bracing method (inside or outside) your job requires:

1. Place your braces vertically on the wall at the proper spacing (every 4-6 feet) and secure them to the ground so they won't pull the walls out of plumb!
2. Brace inside and outside corners and bring to plumb.
3. Brace areas of special need like windows, doors, bulkheads and short walls and areas you deem prone to any movement.
4. End walls should be braced on both sides and from top to bottom, on both sides, near the end.
5. Repeat the process until you have sufficiently placed all braces.
6. Attach the braces to the walls with strong course-threaded screws. (Attach screws to the BuildBlock hard points designed into every web and noted on the block face with the letters BB.)
7. When using alignment systems with slotted holes, such as Build1 and Build3 bracing, it is a good practice to install the screws just slightly snug at the top of the slot. This allows the block to adjust or settle slightly during the pour while not allowing them to move upward.

8. You can also tie the block to the brace with tie wire every odd course for added strength by protruding the outer foam and around a tie, back through the foam and to the brace. This should not be needed except in extreme cases.
9. A string line should be placed at the top of all walls to keep your walls in check after your braces are set.
10. Align bracing to the string line before and immediately after pouring concrete. Concrete sets quickly and you will not get a second chance. **Align each wall as it is poured.**
11. Also remember it is easier to push on a brace than to pull.

TIP: ICF walls have a tendency to settle slightly so some installers will lean their walls in 1/4" off plumb to allow for this natural occurrence. If the walls are tilted in, it is much easier to adjust the walls out by gently pushing from the inside after the pour. This is only a suggestion. Other installers swear by staying plumb during the entire process. Also note another method is to make 1" slots in the brace stiff back to allow the screws to move down slightly if the wall compresses any. For this to work, screws must be slightly loose with a washer under the screw head. Professional braces are made this way to account for this tendency in all ICFs. Attach braces with screws near the top of these slots, not the bottom of the slots.

9.4 BELOW GRADE BRACING

Bracing basement walls will nearly always employ inside bracing techniques. When excavating a basement, remember to give yourself an extra 3-4 ft. over-dig so you'll have plenty of room to work around the exterior and to place bracing for T-walls, and waterproofing, etc.

Note: Excavated basement walls should taper slightly so they don't cave in. Use caution not to become trapped while constructing basements. The soil at your job site will determine how much to over-dig the basement excavation.

1. Place your braces on the wall vertically and secure to the footing, slab, or un-poured excavated ground.
2. Brace inside and outside corners and bring to plumb.
3. Brace areas of special need like openings, bulkheads, short walls and areas you deem prone to any movement.
4. End walls should be braced on both sides and from top to bottom, on both sides, near the end.
5. Repeat the process until you have sufficiently placed all braces.
6. Attach the braces to the walls with strong course-threaded screws (if possible, into the BuildBlock hard points for stronger pull-out strength).
7. A top string line should be placed to align walls after your braces are set and during the pour.

BUILDBLOCK TECHNICAL & INSTALLATION MANUAL

Recommended External ICF Wall Bracing

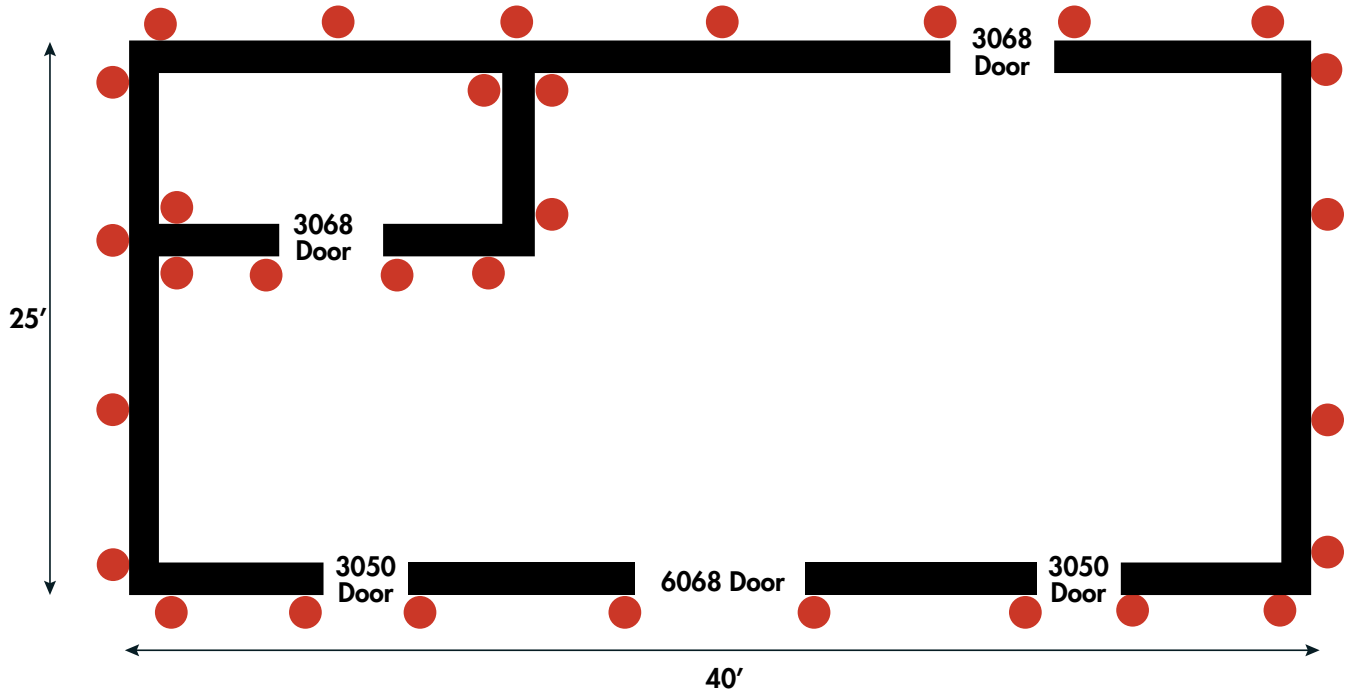

Figure 9.5.1 Example exterior wall bracing. The red dots indicate a recommended location for a brace.

Recommended Internal ICF Wall Bracing

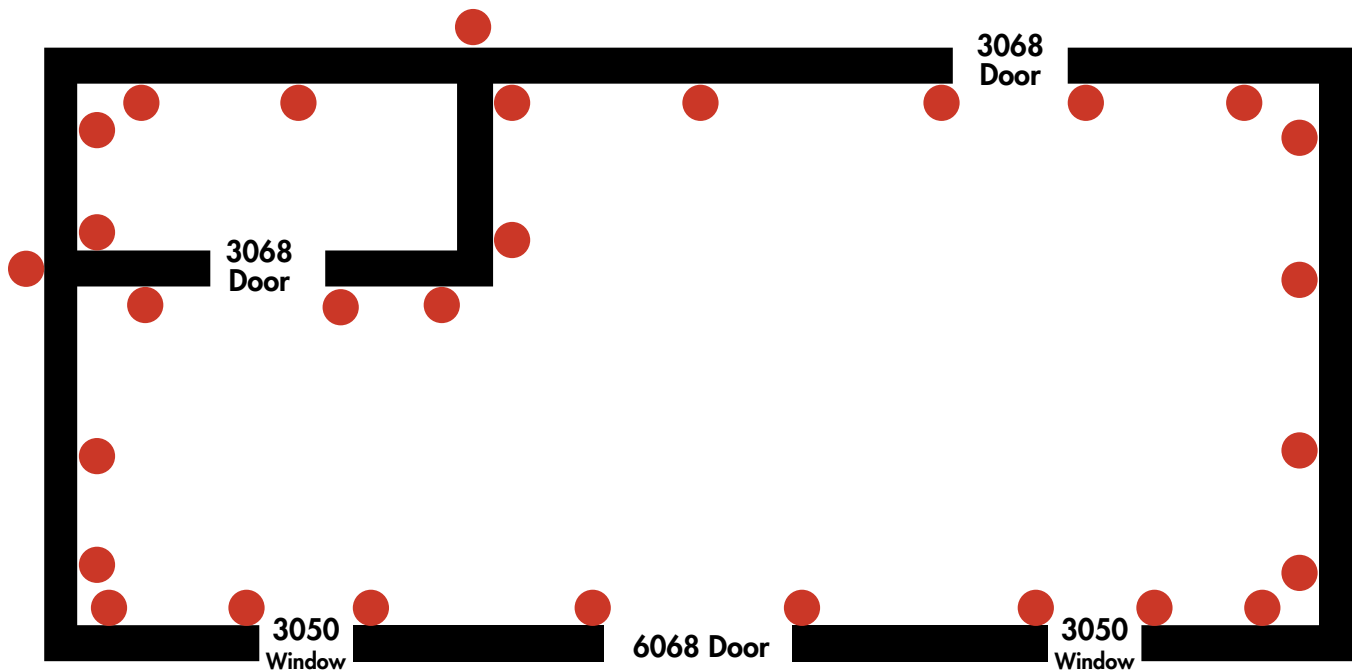

Figure 9.5.2 Example interior wall bracing. The red dots indicate a recommended location for a brace.

BUILDBLOCK TECHNICAL & INSTALLATION MANUAL

9.5 BRACING RECOMMENDATIONS

Figure 9.5.1 and figure 9.5.2 illustrate exterior and interior diagrams for bracing an ICF project. The red dots represent where you might place bracing in order to shore up everything.

Note: We recommend using 5 ft. maximum spacing if using walk boards. Also screw walk boards to the wall brace from underneath.

9.6 BRACING EXAMPLES

The images below demonstrate different brands, types, and styles of bracing an ICF project.



Figure 9.6.1 Minimal Outer Bracing



Figure 9.6.2 More Secure Outer Bracing



Figure 9.6.3 Minimal Inner Bracing



Figure 9.6.4 More Secure Inner Bracing w/ Walk Board



Figure 9.6.5 Ample Outer Bracing with "Scabs" on Non-Factory or Irregular Cut Joints (No Walk Boards)

BUILDBLOCK TECHNICAL & INSTALLATION MANUAL

9.7 PROBLEMS DURING THE POUR

There are several potential problems that can occur during the pour. All of these are preventable with planning, proper bracing, and attention to detail.

ABOUT CONCRETE PRESSURE

In an ICF wall, the pressure is greatest at the bottom of a lift. When pouring concrete, always pour in 3-4-foot lifts. This is a continuous pouring process moving around the structure in a regular pattern until the top of the wall is reached. One of the reasons ICF walls are poured in lifts is because the concrete will begin to set or slake. This initial set provides strength and relieves some of the pressure on the blocks and eliminates the chance of a blowout.

BLOWOUTS

The term "Blowout" is used to describe a failure in a part of the walls capability to hold concrete. However, we hear more words like #&&!*% or other non-printable expletives when one of these events occur.

BuildBlock forms are so strong, it will be rare to experience a blowout caused by form failure. More often it will be caused by an oversight in construction or concrete which is too wet with water (high slump concrete mixture). Sometimes webs can be broken during shipping or through mishandling or storage on the job site. If a bundle of forms appears damaged, look for web damage before installing blocks.

The main thing to note is that a blowout only effects a small portion of a wall. If you have one, here's how to handle it:

1. Continue your wall pour in another area so you don't lose any time.
2. Use a pruning or key hole saw to cut out a clean opening where the damage is located and save the foam piece.
3. Use your hands to remove the excess concrete in the blowout area. Use gloves to protect your hands. Concrete burns are very dangerous.
4. Clean up the removed foam piece and the area around the blowout.
5. Glue the edges of the foam piece and replace it back into the hole.
6. Take a piece of plywood which is 12" longer on each side of the affected area and screw it into the ties on both sides of the opening.
7. Brace adequately across the patch.
8. Pay special attention to the opposite side of the wall where the blowout occurred. You might brace that area as well, if it looks as though the foam has been "stretched" or stressed. You can tell by looking at the composition of the beads. If they have separated, they are compromised and need a patch as well.
9. When re-pouring near the patch, once the area has been refilled, allow it to set a while before topping that part of the wall off further.

10. Remove the patch when you take your braces down. The only damage left will be some concrete stains on the wall foam. This is cosmetic only and can easily be rasped clean.



This blowout occurred when an installer (name withheld) dropped his tool in the void during construction of the wall. He cut a hole in the base of the foam and retrieved his tool, then glued the foam piece back and walked away! Had he braced this area with a scab or 2x4 across, we would not have this lovely story to tell!

BUILDBLOCK TECHNICAL & INSTALLATION MANUAL



SECTION 10: CONCRETE PLACEMENT

10.1 PRE-POUR CHECKLIST

When you have finished building your BuildBlock ICF structure and are ready to pour, use this handy list to make sure you have not overlooked something. Assuming you have followed the steps for all things prior to this stage, your walls should be ready to pour.

- Make sure your job site is accessible to ready mix trucks, pump trucks, and/or line pumps.
- Check for wall level with string-line or laser level and trim tops to level.
- If desired, trim off interlocking nubs for a smooth top plate surface to screed to. (Do not allow them to fall into the wall cavity.)
- Re-check your braces to insure they are screwed to the wall and are firm and secure on the bottom of the wall. It is good to leave all brace screws in professional braces slightly loose so they may slide down if the wall compresses during the pour.
- Re-check all braces for plumb and align top of the wall to the stringline.
- Inspect your openings bracing, and fortify areas you suspect movement could occur.
- Check for square on all openings and make sure your access holes are cut on the bottoms of the window bucks.
- Re-check walls at splices; fortify with scabs and banding to insure no separation or movement.
- Look at all joist hangers, inside and out, to ensure they are installed at correct locations, stable, and firmly secured.
- Re-think your service penetrations and enlist your other trades for their OK on placement and quantity.
- Re-check your service penetrations for movement.
- Re-check your rebar placement and tie off areas where vertical meets horizontal at the top of the wall.
- Anchor bolt placement has been marked off and anchor bolts are staged and ready.
- Re-check your brick ledge forms, bracing, stirrups, and reinforcement.
- Have materials on hand to repair problems, provide additional strapping or bracing, if necessary.
- Re-check your walk boards or scaffolding for security and stability.
- All beam pockets have been determined, built, and braced securely.
- Make sure your pump truck has ample time to set up before the concrete arrives.
- Proper amount, type, and slump of concrete has been ordered.

BUILDBLOCK TECHNICAL & INSTALLATION MANUAL

- Have proper timing of your concrete trucks in place. (Example: 30 minutes apart)
- Have slump test kit ready to test each load to 5" or 6" slump.
- A wash out location has been determined for your ready mix trucks and pumpers.
- Have your pencil vibrators or other vibration methods ready.
- Discuss with your crew who will tamp and vibrate the lower wall areas, who will operate the hose, who will vibrate the wall, screed level the wall, place anchor bolts or bearing plates, and adjust each wall as it is poured.
- Have materials placed on the job site.
- Sweep and clean up job site area during and after the pour.

Having these things off your mind will allow you to focus on concrete placement.

The concrete company should be advised in advance of the expected slump and conditions that are expected. If the concrete comes to you hot or too wet, don't hesitate to send back the truck.

It is a rare occurrence, but the pressure of wet or hot concrete and the consequences of pouring it are worth the wait to get it right.

BUILDBLOCK TECHNICAL & INSTALLATION MANUAL

10.2 ABOUT CONCRETE MIXES

BuildBlock recommends the use of a 3/8" chip or rock mix 3000 PSI or stronger concrete mix for your walls. Your ready-mix plant will most likely have a mix design for a 3/8" chip mix and will refer to it as a pump mix. There are several alterations you can make to the recipe of concrete to combat weather occurrences, such as fly ash and air entrainment. But do avoid adding calcium to your mixes as it has a negative impact on the rebar reinforcement. If pouring in cold weather, have hot water added to formulate the mix.

Depending on the type of material and individual gradation, these ratios may have to be adjusted. Consult with your local ready-mix supplier. The pump may be the controlling factor

(for example, new pump vs. old pump, boom pump vs. trailer pump, etc.).

You may want to make some test cylinders as the concrete comes out of the pump. Take a 5-gallon sample and make five 4" diameter by 8" high cylinders for testing. Your mix design should yield 3000 PSI at a designed slump of 5 1/2" to 6" to pour properly. If not conveyed properly to your concrete company, they may bring out a 3000 PSI mix with a 4" slump design. If you wet it to pour, your concrete will not be 3000 PSI strength. Note: Most common mixes are designed to be wetted to a 6" slump maximum to obtain the mix designed strength. If you have any concerns, just order a stronger mix design (ex: 3500 psi).

TYPICAL 3000 PSI 3/8" CHIP MIX DESIGN			
		WITH FLY ASH	WITHOUT FLY ASH
1.	Cement Content	5.5 bags (517lbs.) 234.5 kg	6.5 bags (611 lbs.) 277.1 kg
2.	Fly Ash* (Class C)	1.5 bags (141lbs.) 310.2 kg	0
3.	Coarse Aggregate** ASTM C-33 #8 100% passing the 1/2 inch screen 85-100% passing the 3/8 inch screen	1270 lbs. 576.06 kg	1270 lbs. 576.06 kg
4.	Fine Aggregate ASTM C-33 (Sand - FM*** 3.70)	1620 lbs. 734.8 kg	1620 lbs. 734.8 kb
5.	Water to make a 5-inch slump to 6-inch slump	40-46 gallons 151.4 liters - 174.1 liters	40-46 gallons 151.4 liters - 174.1 liters
6.	Entrained Air**** (for workability)	4% to 6% or 1 oz. per bag cement/fly ash	4% to 6% or 1 oz. per bag cement
7.	Water Reducer	Encouraged	Encouraged
8.	Recommended Slump	4-inch to 5.5-inch (102 mm to 140 mm) out of the pump	4-inch to 5.5-inch (102 mm to 140 mm) out of the pump
Notes: *The use of Fly Ash improves the flow ability of the concrete and reduces the amount of Portland cement required. This saves you money and results in a concrete mix which is more "green" in terms of LEED points. **The maximum aggregate size for 6" block is 1/2" (3/8" is recommended). The maximum aggregated size for 8" block is 3/4" (3/8" is recommended.) The larger the aggregate, the more problems you will have with concrete flow. ***FM = Fineness Modulus for sand. ****6% Entrained Air results in better flowing concrete.			

10.2 POURING

CONCRETE SLUMP

Proper slump is very important. Do not use less than 4" slump concrete out of the pump hose. Voids could be an issue. Note: We always measure the concrete slump before it ever goes into the pump. A 1/2 inch extra slump will be absorbed by the aggregate during the pumping process so wetting the concrete to a 6" slump will usually give you a 5-1/2 inch slump concrete at the hose end most of the time. Occasionally, sand and aggregate has received recent rain and this may not apply.

Depending on the type of material and individual gradation, these ratios may have to be adjusted. Consult with your local

ready-mix supplier. The pump may be the controlling factor (for example, new pump vs. old pump, boom pump vs. trailer pump, etc.).

Proper procedures must be followed when taking test cylinders or validation may be compromised.

The required slump should be mixed at the redi-mix plant to avoid "watering down" the mix on site. The use of admixtures as a water reducer is recommended as it will provide the desired slump without losing concrete strength. Admixtures make it possible to adjust slump on site with less water. Note: Most common mixes are designed to be wetted to a 6" slump maximum to obtain the mix designed strength.

BUILDBLOCK TECHNICAL & INSTALLATION MANUAL

Note: Typically adding water at the ratio of 1 gallon per yard of concrete raises the concrete slump by 1". Be very careful, adding too much water above a 6" slump will greatly weaken the mix design and could cause a failure or wall bulge.

GlobalBlock works best with a lower slump concrete and a slower pour rate. Pouring GlobalBlock will require a slump in the range of 4" – 5-1/2". It is important to perform a slump test prior to pouring or pumping the concrete to ensure that it will not overstress the system. Lift heights should be limited to 2' for the first lift and 4' for the remaining lifts. The pressures generated on the inside of the form increase dramatically with pour rate and higher slump (thinner) concrete.

CONCRETE CONSOLIDATION

IRC 2012: R611.5.1.5 Consolidation of concrete:

Concrete shall be consolidated by suitable means during placement and shall be worked around embedded items and reinforcement and into corners of forms. Where stay-in-place forms are used, concrete shall be consolidated by internal vibration. All walls must be internally vibrated with a 3/4" to 1" powered vibrator.

POURING NOTES

1. Flow concrete to corners when pouring. Stay at least 3-feet from a corner when pouring until close to the top and topping off the wall.
2. When pumping, push the concrete flow at a 45 degree angle so it flows smoothly. Let the concrete flow naturally.
3. Anchor doors and windows with a small amount of concrete on each side before pouring the first lift around these openings.
4. Work closely with pump operator to pour smoothly.
5. Do not **over** vibrate above or along the sides of doors or windows. This will cause the block or bucking to lift and could blow out a block.
6. Do not over vibrate a wall. Over vibration can cause large aggregate to settle to the bottom of the wall.
7. When vibrating the concrete, it is recommended you use a low impact pencil vibrator with a 3/4" or 1" head maximum size. The technique used is fast in slow out with the average pull out rate of 4" to 6" per second. Do not over vibrate screen grid ICFs.
8. Spot glue top course.
9. Pour top course slightly high as it will settle during vibration.
10. Utilize a restrictor end (such as a LL, Double L nozzle) on your boom hose to your boom hose with a 3" max end size to reduce concrete surge. Discuss this with your pumper when ordering your pump. BuildBlock recommends boom pumps for full wall pours.



Concrete Slump cone



BUILDBLOCK TECHNICAL & INSTALLATION MANUAL



10.3 CONCRETE DELIVERY SYSTEMS

BOOM PUMPS

Boom pumps work the best because they have full job site access from one place. There is no “hose factor,” and it can move a tremendous volume quickly.

HOSE TYPE

BuildBlock recommends a 3-inch “Double L” or a 3-inch Flat Hose (Mud Snake). These provide additional concrete flow control and make it safer for the person directing the pour.

TRAILER PUMPS

Typically used for smaller applications, trailer pumps are sometimes used for big jobs. The down side is hose management (heavy hose across ICF walls) and pumping lesser concrete volumes which results in a slower, longer pour time. A 2” hose for the last 25’ feet is required. A 3” hose will be too heavy to handle.

TRUCK CHUTE

Right off the truck chute is done sometimes when the conditions are perfect (like a basement with minimal over dig) and where you are confident you can direct the chute around the job site. However, chute filling can be messy and wasteful and you are more tempted to water down your mix which will decrease its strength.

BUCKET SYSTEM

A bucket system with attached funnel whereby a large container of concrete is hoisted around the site via forklift or other means requires more labor and time.

CONVEYOR DELIVERY

Conveyor delivery is another possibility but only if you have a trunk hose to direct concrete into the wall cavities. Check with local suppliers. Note: Trying to save money by settling for a less efficient concrete delivery system will cost you extra time and labor and will result in a messy job site and probably wasted concrete that will require later clean up.



BUILDBLOCK TECHNICAL & INSTALLATION MANUAL

THE IMPORTANCE OF A REDUCER SYSTEM

When you order your pump truck, make sure it has a reducer system to help with rate of delivery. Most trucks come with a big 5" hose and you need more flexibility on the wall than that alone can provide.

Most companies now have a flexible end hose attachment in their system that you can close off with your hands after your pumper stops the machine. Others may have hoses that seal off when the pump stops pumping. This will save you from concrete spills time and time again. Check on these things when you order your pump truck.

10.4 PLACING CONCRETE

- Concrete is heavy and falling concrete, well, it can exert some real force into the void when pouring. BuildBlock recommends you pour your projects in lifts of 3 to 4 feet high in the void around the perimeter of your project.
- If your mix is correct, you can approach the underside of your windows from either side to create a "flow" under the opening and get most of the void under the opening full. Top off through the holes on the bottoms of the windows. Vibrate well under all window bucks.
- Begin pumping the walls away from a corner. Let the concrete flow naturally to reduce the force of impact as it travels to the bottom of the form. As you fill the forms lightly begin tamping the walls from the outside. This will help consolidate the base of the wall.
- You will begin to notice that you can create an arch or "flow" of concrete that move forward as you built up a mass in an area of the void. This is a great technique that you should try to employ as you fill around the project. This way the concrete flows ahead of you and does not fall as far, resulting in less vibration & pressure on the wall.

10.5 CONSOLIDATING CONCRETE

- Using a 3/4" (maximum 1") pencil vibrator in the top two-thirds of your walls to consolidate the concrete is highly recommended. Do a quick insert, then remove the vibrator at a withdrawal rate of approximately 4 to 6 inches per second in a pattern of every other cell. It is best to have a man follow the pumper with this method as you go around the perimeter and every GlobalBlock core.
- Take care around doors and windows; be diligent in these areas with consolidation as they are the "busiest" in terms of rebar and ties.
- Avoid vibrating the vertical rebar, as it could make the aggregate separate from the concrete itself in the lower parts of the wall. The lower parts should have been consolidated by the tamping and falling concrete done during your first lifts.
- If you need to stop the pour before you have reached the top, try to do so in the middle of a form so no cold joints and block joints align.



BUILDBLOCK TECHNICAL & INSTALLATION MANUAL

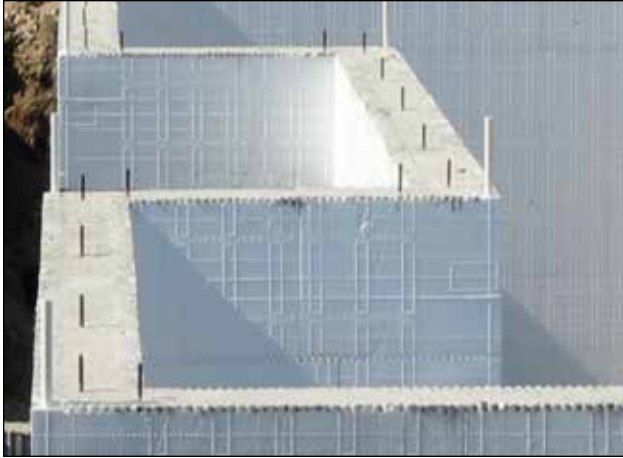

Anchor bolts evenly spaced both in height and width. Two bolts placed in each corner. Smooth concrete finish.

10.6 TOPPING OFF YOUR PROJECT

To get a nice smooth finish and avoid being rushed by hot concrete, toss a bag of FritzPak FR1 into the concrete truck when you are near the last half of the last block. FR1 is a dry powder additive that increases workability of concrete without water so you don't weaken your mix. Check out FR1 at www.fritzpak.com.

As soon the walls are topped off, smooth the top with a trowel to create a nice level top for framers to set the top plate. Non-level tops are an eyesore for framers and show poor quality on a finished job. Remember adjust bracing to the string line after pouring each wall. Correct after each lift as you work around the structure. Concrete hardens quickly, and will not wait for you. Ensure all walls are straight and plumb.

Start setting your anchor bolts as soon as you finish troweling your wall tops. They should be marked and ready for insertion. (In the photo on the right, anchor bolts were placed in the center of the wall.)

Note the off-sets on the corner bolts. The top plate ends need anchors near each end. At the corners, two top plates will join requiring the proper placement of two bolts. They will not be symmetrically placed. Otherwise, you will not be able to hold the ends of each top plate down properly.

Another strategy is to stagger the anchor bolts from side to side within 12" of the end of the top plate to control any warping.

BUILDBLOCK TECHNICAL & INSTALLATION MANUAL

This page left intentionally blank.

BUILDBLOCK TECHNICAL & INSTALLATION MANUAL

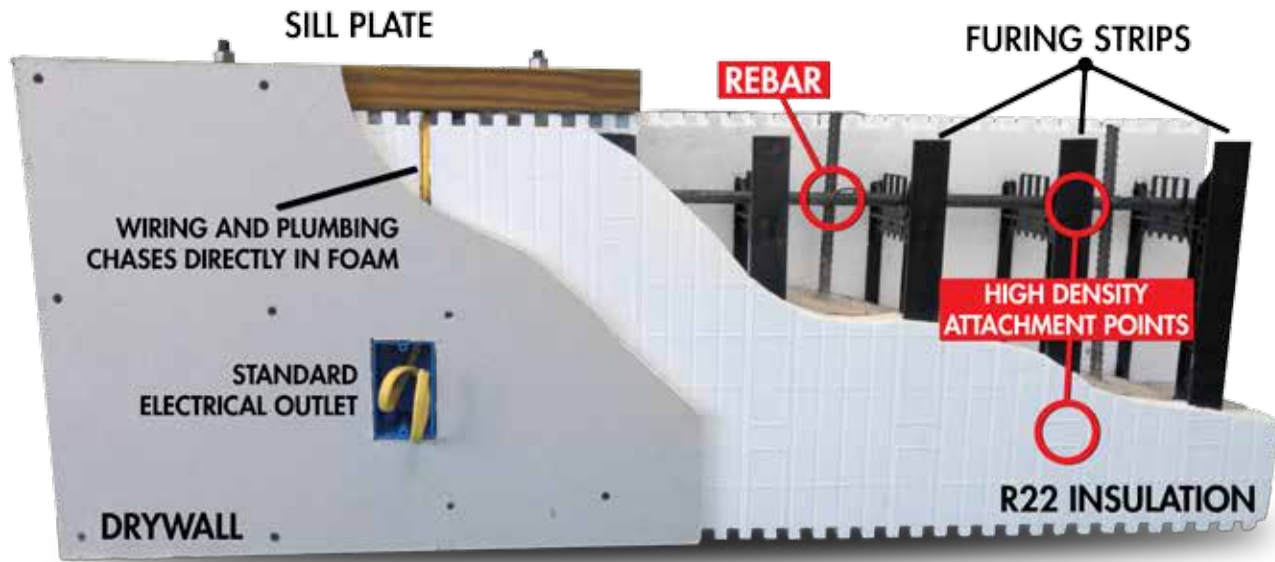

BUILDBLOCK INTERIOR ICF WALL

SECTION 11: FINISHING ICF WALLS

11.1 ABOUT INTERIOR WALLS

Most builders utilize BuildBlock to form the exterior walls of a structure. This maximizes their efficiency since the greatest change in temperature is from the outside. BuildBlock ICFs are well suited as interior partitions as well. Create interior walls to separate activity rooms such as home theater or media rooms, create safe rooms, create firewalls in multi-tenant housing or hotels, and more.



Figure 11.1.1 BuildBlock ICF wall showing standard and heavy-duty attachment points with webs correctly aligned.

Generally most builders will build interior walls from wood or Structural Insulated Panel (SIPS). Attaching these walls systems to a BuildBlock ICF wall is simple, straightforward, and strong. BuildBlock features large attachment points through each block as indicated on the face of each form. Also included every 8-inches vertically are high density attachment points with a 450lbs.+ screw pullout strength. The full face of each embedded web attachment is 150lbs.

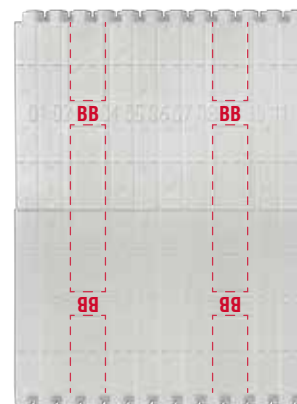

Figure 11.1.2 BuildBlock ICF showing standard and heavy-duty attachment points.

Inspect your walls and ensure that every 6-inches horizontally the webs line up correctly as shown in the graphic on the left. Beneath that design, submerged one-half inch into the foam, are embedded plastic webs. Attach interior wood walls or SIPS panels with screws to these attachment points.

It is possible to use ring shank nails for speed, but BuildBlock recommends screws for best results. In each web face there are two additional heavy-duty connection points marked on the face of the form with a BB. These hard attachment points can be used to attach cabinetry or other heavy materials directly to the ICF wall and may not require a backing. The spacing of BuildBlock webs provides ample connectivity for cabinets and the like.

If more rigid connectivity is required, such as for very heavy items, place Simpson ICFVL ledger connectors in the wall where this connectivity is needed. If it is necessary for wall attachments that do not line up with a BuildBlock web use a

BUILDBLOCK TECHNICAL & INSTALLATION MANUAL

6" tapcon screw to attached studs, sips, or other items to the concrete itself. For larger areas, such as behind cabinetry, you can replace sheet rock with 1/2" plywood where needed so you can screw into the wall at any spot desired.



Figure 11.1.3 Internal wood framing is attached to BuildBlock ICF walls with screws. Tapcons can also be used if needed.

Notice the interior wood framed wall above. The wood framing is attached to the BuildBlock ICFs with screws. Tapcons into the concrete can also be used.

- Wood top plate on ICF wall.
- Floor trusses for attic floor above wood frame wall.
- Very tight openings in intersecting walls.
- Door bucking around all openings.
- Clean ICF walls after the pour so trades can easily see and use markings on the face of every block.

CREATING UTILITY CHASES

Electrical and plumbing services are easy to add to BuildBlock ICF walls. The picture to the right shows Romex inside a horizontal chase cut into the foam using a hot knife. Chases can be created in many ways. Tools such as hot knives, routers, side grinders, or chainsaws with a guide attached to limit the depth of the cut.

The important thing when making a horizontal chase is to use the space between block courses. BuildBlock webs do not run the full height of the block. This creates an area between each course with only foam that is 1-inch in height.

Vertical runs can be made in the foam between the webs. There is 2 1/2" of foam available to remove to make a hole for boxes. Most boxes are 2-1/2" to 2-3/4" deep, so with a

1/2" sheetrock return there is plenty of space available.

There is 1" of space between vertical webs at each horizontal block course connection to allow wiring and small plumbing to run horizontally along a wall.



Figure 11.1.4 Electrical box with small wire chase cut in foam.

ELECTRICAL

In wood framed structures the wiring is placed inside the wall cavity, this is not true in most all ICF applications. Services are placed through wall penetrations to bring utilities inside, but typically conduit is not installed inside the concrete wall because it will weaken the wall. The preferred code compliant method is to install electrical into the EPS foam on the face of the wall. Cut chases at least 2" to 2 1/2" deep so the finished wire or conduit is 3/4" minimum from the wall face to avoid sheetrock screws hitting any lines. Foam over the wire to hold in place.

Place all wiring as deep into the foam as possible to meet code requirements and keep inspectors happy. Check local code requirements when planning your project.

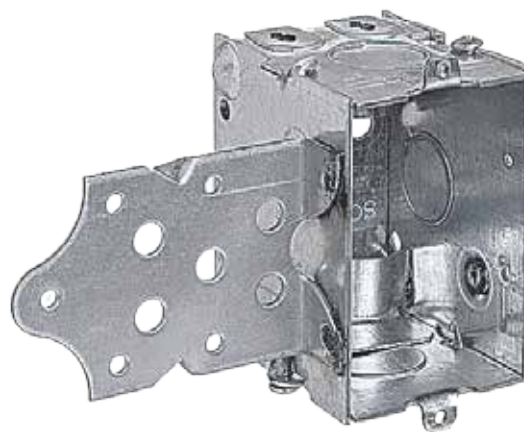

Figure 11.1.5 Steel City Electrical Box 806SW can attach directly to the ICF webs.



Figure 11.1.6 Windlock ICF Electrical boxes designed to lock into EPS foam.

BUILDBLOCK TECHNICAL & INSTALLATION MANUAL



Figure 11.1.7 2" PVC pipe chased into an ICF wall.

PLUMBING

Plumbing is installed in the same manner by creating chases in the foam and using adhesive foam to secure any pipes in place. Mark the route of the pipe on the foam before cutting. Keep in mind it isn't possible to install pipes with a diameter larger than 2½" due to the thickness of the foam. For larger pipe runs, choose an inside wood framed wall. Note: 2" schedule 40 pipe has approximately a 2½" outside diameter. This is the maximum size pipe that can be run in the ICF wall surface.

BuildBlock does not recommend running plumbing inside the concrete wall unless absolutely necessary. Placing pipe in the void of an ICF wall and pouring concrete around it has a tendency to create voiding and consolidation issues and is unrecoverable should the pipe fail. If placing any plumbing inside a wall cavity, extra vibration is required to ensure proper consolidation.

When planning your project it is always wise to consult with any trade that an ICF wall will impact. This helps each trade prepare for their respective installations and alterations, if necessary, to follow their methods or materials more suited for ICF job sites.

11.2 ABOVE GRADE EXTERIOR FINISH MECHANICAL ATTACHMENT

The exterior surface of the ICF must be covered with an approved wall covering in accordance with the applicable Code or a current evaluation report. When the wall covering is mechanically attached to structural members, the wall covering must be attached to the flanges of the embedded cross-ties with fasteners, described in Table 3, having sufficient length to penetrate through the flange a minimum of 1/4 inch (6.4 mm). The fasteners have an allowable fastener withdrawal and lateral shear strength as noted in Table 3. Screws placed into the BuildBlock® (BB) flange hard point areas have additional fastening withdrawal and lateral capacities. The fastener spacing must be designed to support the gravity loads of the wall covering and to resist the negative wind pressures. Please reference the BuildBlock Code Compliance Research Report (CCRR-1003) for additional specifications and information.

BUILDBLOCK TECHNICAL & INSTALLATION MANUAL



BUILDBLOCK EXTERIOR WALL

11.3 VENEERS AND COATINGS

There are no limits to the types of veneers you can attach to a BuildBlock ICF wall. BuildBlock forms can accommodate all traditional methods of installation and help save money on some. For instance, since the BuildBlock form has the interlocking 2-1/2" foam outer layer, you can eliminate house wrap altogether.

- Brick and natural stone can attach to the embedded web attachments located 6" OC. If possible try and use the BuildBlock heavy-duty attachment points for brick and rock ties for the most secure connections.
- Adhesive veneers such as traditional stucco, EIFS and new veneer products made specifically for ICF are installed easily. Most of these products install as easily as conventional methods.
- Some veneers that utilize foam backing may be able to skip the step of the additional foam sheets and be applied directly to the BuildBlock forms.
- Siding of all types can attach directly to the wall via the embedded web attachment points 6" OC with or without a vapor barrier.
- Vertical, stamped, stained concrete is an increasingly popular option and works well with ICFs. Many shapes and styles makes this a creative option.



FINISHING PRODUCTS

BuildBlock recommends the use of BuildCrete Stucco and Plaster for applications.

BUILDCRETE STUCCO

BuildCrete Stucco is a true one-coat stucco designed to adhere directly to any EPS foam, CMU block, DensGlass, Securock, concrete and other building materials. BuildCrete has been used on ICF construction for its durability, strength, and ease of application. It allows contractors to be green without complexity, compromising performance, or high cost.

BuildCrete Stucco exterior wall finish coating performs beyond any conventional exterior stucco on the market today and features: excellent water resistance, impact and abrasion resistance and resistance to mold and mildew.

It is the perfect choice for exterior applications including as a bonding agent and mortar for manufactured (cultured) stone facings. The 3/16" one coat application has over 3,500 PSI compressive strength. BuildCrete™ is designed to be environmentally responsible, utilizing natural limestone sand and zero portland type cements. It is sustainable and emits no pollutants.

BUILDBLOCK TECHNICAL & INSTALLATION MANUAL

BUILDCRETE STUCCO BENEFITS

- Provides a hard, durable single 3/16-inch thick coat applied directly over EPS, 3500+ PSI compressive strength.
- Noncombustible building material, Zero flame spread and smoke developed indices.
- Highly resistant to water, mold and mildew growth.
- Impact and abrasion resistant.
- Low shrinkage minimizing cracking.
- Resistant to freeze and thaw damage.
- Single day hand or machine application; prime and paint once cured.
- Qualifies for LEED points.
- Arrives in bags to be mixed with water on the job site.
- Applies directly over EPS.
- Noncombustible building material
- Zero flame spread, and zero smoke developed indices
- Single day application
- Low shrinkage minimizing cracking
- Highly resistant to sulphate attack
- Low permeability
- Hand or machine applied
- Silica free

BUILDCRETE PLASTER

BuildCrete™ Plaster is an ultra-high-performance finish for architectural and industrial applications. This abuse-resistant interior veneer plaster is designed for buildings that require extreme abrasion resistance.

BuildCrete Plaster is a single product application that provides the ultimate in resistance to abrasion and indent far exceeding abuse type drywall. This product is formulated for industrial strengths exceeding 8,500 psi and provides an attractive, smooth or textured finish over a variety of substrates, such as BuildBlock ICFs, GlobalBlock, gypsum board, cement board, CMU block, mag-board, fiber board, monolithic concrete and unit masonry. Typical application thicknesses is 3/16" depending on the needs abuse resistance.

The BuildCrete Plaster mix contains all needed ingredients so no sand is added at the job site to minimize the risk of mixing errors. Produced using environmentally-friendly manufacturing techniques, BuildCrete Plaster is easy to mix and apply using conventional plaster tools and techniques. It is applied in a scratch and double-back one-coat application along with a 4.5 oz or 11 ounce or heavier fiberglass mesh depending on the abuse resistance needed. For texture finishes, complete texturing after the plaster has firmed up and before the final set. Polyurethane roller texture finishes can also be used and rapidly finished. One thin coat is applied directly over the EPS foam, a fiberglass mesh is embedded and then covered over with the same material giving about 3/16" finished thickness.

BuildCrete™ Plaster was specifically developed for the toughest industrial applications, but it is also an ideal finish for walls

in homes, schools, universities, restaurants, medical facilities, hotels, commercial offices, government/military buildings, correctional facilities, multi-family housing, and other high-traffic, high-abuse applications. The strength and abrasion and abuse-resistance features also provide the means for reduced long-term maintenance costs. Architects and designers can also take advantage of the wide range of decorative options of this product. Besides many types of smooth and textured finishes, BuildCrete™ Plaster can be easily painted or stained. It is designed to be environmentally responsible and emits zero pollutants, and uses less water than similar products currently on the market. It can also be color tinted on the job site.

All BuildCrete™ Plaster products exceed USEPA and California indoor air quality and VOC standards and conserve water compared to other similar products. Abuse-resistant features such as resistance to cracking, indentation and abrasion, coupled with ease of installation, fire protection, design options, and resistance to mold and gives BuildCrete™ Plaster unparalleled versatility inside any structure.

A Level III (highest) abuse resistance is achieved by applying a 3/16" thickness and it replaces fragile 1/2" or 5/8" gypsum board over ICF walls and ceilings. BuildCrete Plaster™ is tested and code approved for ICFs to ASTM E-136, ASTM E-84 and NFPA-286 code compliance by Intertek.

BUILDCRETE PLASTER BENEFITS

- Provides a hard, durable single 3/16-inch thick coat applied directly over EPS, 8500+ PSI compressive strength.
- Noncombustible building material, Zero flame spread and smoke developed indices.
- Highly resistant to water, mold and mildew growth.
- Impact and abrasion resistant.
- Low shrinkage minimizing cracking.
- Resistant to freeze and thaw damage.
- Single day hand or machine application; prime and paint once cured.
- Qualifies for LEED points.
- Arrives in bags to be mixed with water on the job site.
- Applies directly over EPS.
- Noncombustible building material
- Zero flame spread, and zero smoke developed indices
- Single day application
- Low shrinkage minimizing cracking
- Highly resistant to sulphate attack
- Low permeability
- Hand or machine applied
- Silica free

OTHER FINISHING PRODUCTS

Because each job is different geographically and in terms of use and exposure, BuildBlock does not endorse any particular product listed here or their application. This page is simply a reference tool for BuildBlock customers. Each manufacturer

BUILDBLOCK TECHNICAL & INSTALLATION MANUAL

has different specifications so research your local installation contractors and make a choice based on product and installation quality. Here are some brands to consider:

Synergy Products	www.senergy.basf.com
Styro Industries	www.styro.net
Parex	www.parex.com
PermaCrete	www.permacrete.com
Grail Coat	www.grailcoat.com
Multi Coat	www.multicoat.com
Omega Products	www.omega-products.com
Dryvit	www.dryvit.com

11.4 INTERIOR FINISH MECHANICAL ATTACHMENTS

ICF units exposed to the building interior must be finished with an approved 15-minute thermal barrier, such as minimum 1/2 inch thick (12.7 mm) regular gypsum wallboard complying with ASTM C1396, installed vertically and attached to the cross-tie flanges with minimum 1-5/8 inch long (41 mm), No. 6, Type W, coarse-thread gypsum wallboard screws spaced 16 inches (406 mm) on center vertically and 12 inches (305 mm) on center horizontally.

The screws must penetrate a minimum of 1/4 inch through the flange. Gypsum board joints and screw heads must be taped and finished with joint compound in accordance with ASTM C840 or GA216. See Section 4.3.2 for installation details for crawl space applications without an ignition barrier on the interior face. Please reference the BuildBlock Code Compliance Research Report (CCRR-1003) for additional specifications and information.

11.5 ATTIC AND CRAWL SPACE INSTALLATIONS

When the ICFs are used for walls of attic or crawl spaces, an ignition barrier complying with IBC Section 2603.4.1.6, or IRC Sections R316.5.3 or R316.5.4, is required, except when all of the following conditions are met:

- Entry to the attic or crawl space is only to service utilities, and no storage is permitted.
- There are no interconnected attic or basement areas.
- Air in the attic or crawl space is not circulated to other parts of the building.
- Under-floor (crawl space) ventilation is provided that complies with IBC Sections 1203.3 [2015 - 1203.4] [2009 - 1203.3] or IRC Section R408.1, as applicable.
- Attic ventilation is provided when required by IBC Section 1203 or IRC Section R806, as applicable.
- Combustion air is provided in accordance with IMC (International Mechanical Code) Section 701.

11.6 VAPOR BARRIERS (RETARDERS) AND AIR BARRIERS

Air and moisture can get into a home a number of ways. Convective transfer involves moving air, such as a draft around a window or door, electrical boxes, or other wall penetrations. Diffusion refers to moisture moving through a material, similar to a sponge soaking up water. Cavity wall construction typically with fiberglass batts placed into the cavities between studs allows air to pass through, and requires an additional, separate vapor barrier, typically polyethylene sheet (Visqueen) or kraft paper facing on the fiberglass batts. Continuous insulation (EPS foam or XPS foam) can also be used as a vapor barrier. Vapor barriers, or more properly worded, retarders, must be sealed properly to prevent air infiltration and vapor transmission.

Insulating Concrete Forms (ICFs) do not require a separate vapor barrier or retarder. ICF walls are mass walls, characterized by a solid structure from interior to exterior, with no voids or cavities. The EPS and the concrete are bonded together at the inner face of the form, eliminating airflow through the wall. BuildBlock's EPS at 2.5" of thickness per side, provides a perm rating of .408, and classifies the ICF form as a class II vapor retarder. The monolithic concrete core also serves as an air barrier, and has its own perm rating at 6 inches thickness of .533. (Estimated according to the average perm rating of 3.2 per inch of concrete; per ASHRAE).

The concrete core of a BuildBlock ICF wall effectively seals the wall from air infiltration. Being a poured product, it will fill any openings or gaps completely, eliminating air movement. The EPS forms will bond to the concrete, creating a seal, and breaking the path for moisture to penetrate the wall. Additionally the insulative effects of the EPS can serve to maintain a more stable inner wall temperature, lessening the condensation seen in cavity walls.

Any condensation that does occur, has no effect on the EPS or the concrete. Concrete and EPS are both inorganic, and do not serve as a food source for mold or mildew, and the highly alkaline environment of the concrete further reduces the incidence of mold and mildew growth.

Applying additional vapor barriers can potentially trap moisture, and allow it to run down or evaporate up into more moisture sensitive areas of the structure. A properly sized HVAC unit will ensure that any moisture present will be quickly reduced to a level below 50% humidity, thus stopping mold and mildew growth.

Below is additional information from the IRC 2012 regarding Vapor Barriers.

R702.7 Vapor Retarders

Class I or II vapor retarders are required on the interior side of frame walls in Climate Zones 5, 6, 7, 8 and Marine 4.

Exceptions:

1. Basement walls.
2. Below grade portion of any wall.
3. Construction where moisture or its freezing will not damage the materials.

BUILDBLOCK TECHNICAL & INSTALLATION MANUAL**VAPOR BARRIERS AND WATER RESISTIVE BARRIERS
ON ABOVE-GRADE APPLICATIONS**

There is much misunderstanding regarding vapor barrier and water resistive barrier requirements on above-grade ICF applications. Some, but not all, EIFS systems have code approval to install on ICF without a vapor barrier.

However, even this approval may be circumvented by local code requirements. It is very important to research your local code requirements and refer to the applicable sections of the current International Residential Code noted below:

**INTERNATIONAL RESIDENTIAL CODE EXTERIOR COVERINGS
REFERENCE**

R701	EXTERIOR COVERING
703.1	General.
703.2	Weather-resistant sheathing paper.
703.3	Wood, hardboard and wood structural panel siding.
703.4	Attachments. .
703.7	Stone & Masonry Veneer
703.9	Exterior insulation finish systems, general.
703.9.1	Weather-resistive barrier.
703.9.2	Flashing, general.
7.304	Weather-resistant siding attachment and minimum thickness.

BUILDBLOCK TECHNICAL & INSTALLATION MANUAL

This page left intentionally blank.

BUILDBLOCK TECHNICAL & INSTALLATION MANUAL

RECOMMENDED PRODUCTS

These products are available for sale in the MyBuildBlock Online Ordering System (<http://store.buildblock.com>). Details about the products can be found on the BuildBlock website.

BRACING / SUPPORT SYSTEMS	
BuildBrace	Laser fabrication technology and state of the art design capability has led to the development of premier all-in-one and 3-piece bracing systems. These bracing systems eliminate the issues that frustrate builders on the job site. BuildBrace is specially designed to match attachment points on the BuildBlock webs. Easy adjustment and leveling from the top of the wall, convenient transport and storage cases, as well as extensions for tall walls make BuildBrace the single best bracing choice on the market.
BUCKING (WINDOW AND DOOR OPENINGS)	
VBuck® Vinyl Block-Out System	The V-Buck vinyl block-out system is easy to assemble, installs quickly, helps job sites look cleaner, and is available at an installed price equal to wood. Complete your energy efficient package for builders and buyers of ICF structures with V-Buck vinyl block-outs.
GorillaBuck	EPS foam bucking for use in ICF construction eliminates wood and other organic matter from the wall system and provides an insulated thermal break between concrete, the outside environment, and the window or door.
JAMB-it-ALL™ All Steel Jamb System	20-gauge galvanized steel system designed for ICF forms. Jamb-it-All provides a simple design and standard concepts to encapsulate the openings and integrate into the concrete itself. For more information visit www.jamb-it-all.net
DECKING & ROOFING SYSTEM	
BuildDeck	The BuildDeck System is a lightweight, stay-in-place Insulating Concrete Form (ICF) made of Expanded Polystyrene (EPS) and used to construct a solid monolithic insulating concrete floor and/or roof decking system.
Lite-Deck	BuildBlock now offers Lite-Deck ICF decking, roofing & flooring panels and top hats.
FOOTINGS	
FastFoot® by Fab-Form™	Fastfoot® is a fabric footing form that prevents rising damp.
Form-A-Drain™	A permanently installed system that forms footings, drains foundations, and provides a sub-slab perimeter radon evacuation system.
ICF CONNECTORS	
Simpson Strong-Tie®	The ICFVL Ledger Connector System is engineered to solve the challenges of mounting wood or steel ledgers to insulated concrete form (ICF) walls. Simpson's new ICF component of the system, the ICFVL, is designed to provide both vertical and lateral, in-plane performance. More information at http://strongtie.com/
RP Watkins Hangers	ICF Floor Truss Solutions...The Watkins Hanger eliminates the need for plates, hangers, rim boards, and additional truss hangers in two easily placed products that create a bearing ledge for bottom bearing floor/roof trusses direct to the ICF. More information at http://watkinshanger.com/
RADIANT FLOORING	
Creatherm™ Panels	Provides efficient thermal and sound barrier between the ground and heated slab. Details: www.creatherm.com
RAZ Panel™ by EZ Floor	Speeds up and simplifies the process of installing PEX tubing for in-floor hydronic radiant heat applications.

BUILDBLOCK TECHNICAL & INSTALLATION MANUAL

TOOLS & ACCESSORIES	
Wind-Lock®	Wind-lock is a supplier of tools and accessories for the ICF construction industry including foam adhesive, guns, kits, and more.
Pro-1 Hot Knife	Heavy duty hot knife maintains high temperatures for long periods of time and offers a rigid blade design that can quickly plunge, carve, and sculpt through large pieces of high density foam.
BN Products BNCE-20 Rebar Cutter	This compact and lightweight tool has a 3-position removable side handle and a rotating trigger handle that provides the operator with multiple cutting positions and increased maneuverability in tight areas. This amazing tool can cut a variety of materials including rebar, all-thread rod, coil rod, EMT conduit, pipe, tubing, burglar bars and more. It is designed to cleanly cut the material flush with the surface in just a couple of seconds per cut. Available through BuildBlock.com

WATERPROOFING	
DMX FlexSheet™ Dimpled Membrane	DMX FlexSheet™'s air-gap membrane technology keeps basements dry, no matter what the weather or soil conditions. Unlike traditional foundation coatings, DMX FlexSheet™ bridges cracks and drains away moisture to the FlexTube™ footing drains.
Tamko® Sheet Waterproofing Membrane	TAMKO TW-60 is a flexible, self-adhering, rubberized asphalt sheet waterproofing membrane with a polymer film on the surface and a removable treated release film on the adhesive side.

FINISHES - INTERIOR & EXTERIOR WALLS	
BuildCrete Stucco Exterior BuildCrete Plaster Interior	BuildCrete™ Stucco is a true one-coat system designed to adhere directly to any EPS foam, CMU block, DensGlass, Securock, concrete and other building materials. BuildCrete has been used on ICF construction for its durability, strength, and ease of application. It allows contractors to be green without complexity, compromising performance, or high cost. Visit buildblock.com for more information.
BASF Wall Systems	As the manufacturer of EIFS and stucco wall systems, BASF provides all the components to create the stucco look and offer impact resistance in a surfacing system for ICFs. Brand names: Senergy, SonoWall, Finestone, and Acrocrete. Visit www.wallsystems.basf.com .
Dryvit Systems, Inc.	Dryvit Systems, Inc. is the original Exterior Insulation and Finish Systems (EIFS) manufacturer in the United States and the company that spawned the highly-successful EIFS industry in North America beginning in 1969. Visit dryvit.com for more information.
KonCote Products	KonCote is a unique and versatile surfacing product that can be applied over foam, concrete, masonry, steel, stucco and aggregate surfaces. It is an architectural, chemical-concrete with more than two times the strength of standard concrete. Visit www.koncote.com .
Perma-Crete®	PermaCrete is applied to many substrates including concrete, masonry, foam, steel, stucco and aggregate. These applications commonly include interior & exterior walls, pool decks & pool interiors, driveways, sidewalks, patios, bathrooms, and countertops. Visit permacrete.com to learn more about PermaCrete's applications.

FLOOR SYSTEMS	
Hambro	Hambro composite floors are a tested and proven concrete forming system for elevated slabs. It is extremely compatible with ICF wall systems; the addition of in-floor radiant heat does not require a second pour! Go to www.hambro.ws or call 1800 546 9008.
Metwood™ Building Solutions	Metwood Building Solutions offers innovative cold formed steel building products, including beams, joists, steel framing, and more. Our products are stronger, lighter and better than any competing product. For more information visit metwood.com

FOOTINGS	
FastFoot®	Made of high density polyethylene fabric, Fastfoot is a green replacement of lumber and plywood for forming concrete footings. A 100' roll of Fastfoot forms the same concrete as 1,500 pounds of lumber. Fastfoot is ideal for residential and commercial strip footings and pad edging. fastfoot.com

BUILDBLOCK TECHNICAL & INSTALLATION MANUAL

HOME PLANS & DESIGN SERVICES	
BuildBlock	We design custom homes for property owners and builders anywhere in the United States. From the comfort and convenience of your home or office, we will work with you on-line, by FAX or by telephone to provide you with the design you need for your new home. Visit buildblock.com today.
Robert Klob Designs, Inc.	Professional Residential Design Services in the United States, Canada, Mexico, Latin America & the Caribbean. RKD provides high quality and affordable residential design for everyone, regardless of their financial standing. Visit rkdzns.com for more information.
Nelson Design Group	<p>Nelson Design Group, is a nationally known design firm with plans published by Architectural Designs, Harris Publications, Home styles Publishing, Home Design Alternatives, Builder Magazine, Home Planners, Garlinghouse, Old House Journal, House Beautiful, Good Housekeeping, Better Homes & Gardens and many more.</p> <p>At Nelson Design Group, our goal is to provide our clients with a design that perpetuates a constant feeling of pride. Each owner should step into their dream home each day knowing they made the best decision possible, not only with their home, but with their surroundings.</p> <p>Call 1-800-590-2423 with questions or visit nelsondesigngroup.com</p>

INSULATION	
ThermalSert	<p>BuildBlock ThermalSert are insulation inserts for BuildBlock and BuildLock Knockdown ICF forms. Each 1-inch of foam insert adds 4.2 R-Value increasing the overall r-value of the wall. The insert is placed toward the outside of the block to insulate against the greatest difference in temperature.</p> <p>Visit http://buildblock.com for more information.</p>
Fomo Products, Inc.	Products include spray foam insulation in both low pressure refillable and disposable systems, a construction adhesive specifically designed for use with polystyrene applications and a patented closed-cell, low pressure window and door foam. Visit www.fomo.com .

MOULDING	
Decorawall® Systems	Pre-based and meshed EPS Foam Architectural details. For Details: www.decorawall.com

TERMITE PROTECTION	
Termimesh USA, Inc. Termite Proofing Wire Mesh	Termimesh is a unique physical termite barrier using a simple concept of woven stainless mesh to stop termites entering homes through concealed entry points. Go to www.termimeshusa.com

WINDOWS AND DOORS	
Andersen®	Quality Andersen windows and doors are now available through BuildBlock by special order.
European Windows	European Windows is the exclusive distributor for the exciting line of Windows, French Doors, and more manufactured in Germany by HEINZMANN®. For Details: www.europeanwindows.com

WATERPROOFING & VAPOR BARRIERS	
Insulation Solutions	Insul-Tarp® under-slab insulation provides a superior thermal and moisture barrier beneath the slab. Viper VaporCheck® is a high performance under-slab vapor barrier. (866) 698-6562 or www.insulationsolutions.com .
Platon Waterproofing System	Air-gap waterproofing system that is effective for all types of foundations. It's a tough, dimpled, 24-mil high-density polyethylene wrap. For details: www.systemplaton.com
Resisto Waterproofing	RESISTO foundation products are various and fit a broad variety of needs. For details visit their website at www.resisto.ca .
SuperSeal Dimpled Membrane	Extremely durable, inexpensive and easy to use waterproofing membrane. It can be used on all types of foundations and does not require any additional coatings. For details: www.superseal.ca

BUILDBLOCK TECHNICAL & INSTALLATION MANUAL

This page left intentionally blank.



NORTH AMERICAN MANUFACTURING FACILITIES

BuildBlock Building Systems has fourteen manufacturing facilities across North America and plans to add locations for the next several years. This means we have the manufacturing capacity to meet your ICF needs now and in the future. Shorter shipping distances mean lower freight costs for you and your customers.

BuildBlock continually develops new products and technologies solving problems and meeting needs in residential, commercial, industrial, and institutional construction. We innovate with the goal of creating cost-effective techniques and products for our customers.

BuildBlock partners have facilities around the world to meet your needs including the Philippines, Cyprus, and Egypt and continue to expand. Choosing BuildBlock isn't just about choosing the best ICF block on the market, it's about finding a partner with a strong commitment to our customers, our business partners, and our industry.

BuildBlock Building Systems, LLC
9705 N. Broadway Extension, Suite 200
Oklahoma City, OK 73114

866-222-2575 Toll free
405-840-3386 Office
831-597-0792 Fax
buildblock.com
store.buildblock.com

SOCIAL MEDIA



MISSION

We envision a world where BuildBlock ICF technology delivers energy-efficient, safe, healthy, comfortable and sustainable ICF homes and buildings to millions of people worldwide through the uncompromising integrity of BuildBlock's team of distributors, dealers and customers.

VISION

To harmoniously use the extraordinary gifts and talents of our distributors and dealers to fulfill the goals and dreams of millions of people who want to build better structures as reflected by our motto: "Build it once. Build it for life."

To manufacture one of the most affordable and highest quality Insulating Concrete Forms available in the world today.

To build greatness by providing the resources and services needed for building successful ICF businesses and sustainable ICF structures.

To build an enduring, profitable company while conducting business with Godly character, fairness and integrity.

VALUES

INTEGRITY – We strive to balance the best interests of our distributors, dealers, customers, employees, and investors in an environment of Godly character and honesty.

EDUCATION – We seek to educate the public on the valuable benefits of ICF structures while recognizing that in order to expand the industry, we must educate installers, architects, and engineers in ICF best practices.

CUSTOMER SATISFACTION – We commit to building a team of employees that is inspired, empowered, and driven to meet the ever-changing needs of our distributors, dealers, and customers while we seek to distinguish ourselves in the marketplace by delivering exceptional customer satisfaction.

INNOVATION – We value and invest heavily in innovation while continually expanding our product line through the development of technologically advanced products.

QUALITY – We commit to producing the finest quality products. We stand by the belief that our brand embodies quality, consistency, user satisfaction, and service.

PROFITABILITY – We commit to the strong work ethic and financial prudence necessary to deliver financial results for our business partners and investors and to ensure a long-term profitable relationship.

EMPOWERMENT – We dedicate ourselves to empowering people to improve and enrich their lives and the world around them.