

solinos 40

Kleinteil-Einfachspanner
Single vice for small workpieces

3

Kleines, leichtes und flexibles Spannsystem

Kleinteil-Einfachspannsystem in mechanischer Ausführung mit kompletter Kapselung und modularen Wechselbacken. Ideal geeignet für Kleinteile, Mehrfachspannungen und Automation auf Paletten speichern.

Small, light and flexible clamping system

Single clamping system for small workpieces, mechanical, complete encapsulated and with modular interchangeable jaws. Ideally suitable for small workpieces, multiple clamping and automation on pallet storage units.

Vorteile Advantages



Modulares Spannsystem

- einfaches Handling
- komplett gekapselt
- vielseitiges Backenprogramm
- fixer Nullpunkt (Festbacke)

Modular clamping system

- easy handling
- completely encapsulated
- versatile range of jaws
- fixed zero point (fixed jaw)



Kompakt und präzise

- kompakte Bauweise
- sehr lange Führung der Spannbacke
- nur minimales Abheben der Backen
- Roh- und Fertigteilspannung
- Spannkraft bis 12 kN

Compact and precise

- compact design
- very long guide for the moveable jaw
- only minimum lifting of the jaws
- suitable for blank and finished workpieces
- clamping force up to 12 kN

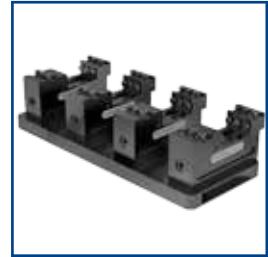

Ideal als Mehrfachspanner

- kostengünstige Lösung für Palettspeicher
- kostengünstige Lösung als Mehrfachspanner auf Grundplatten oder Spanntürmen

Ideal for multiple clamping

- inexpensive solution for pallet storage units
- inexpensive solution for multiple clamping devices on base plates or tombstones

- 1** **Komplett gekapselt**
 - Schutz vor Verschmutzung
 - unempfindlich gegen Späne und damit hohe Funktionssicherheit

Completely encapsulated

 - protection against contamination
 - resistant to chips and coolant, thus, high functional reliability
- 2** **Spannbereichseinstellung**
 - mit Drehmomentschlüssel SW 8 ohne Demontage der Backen

Adjustment of clamping ranges

 - with torque wrench width 8 without removal of the jaws
- 3** **Hohe Genauigkeit**
 - Grundkörper und Festbacke sind aus einem Teil gefertigt

High precision

 - tool body and fixed jaw are made of one part

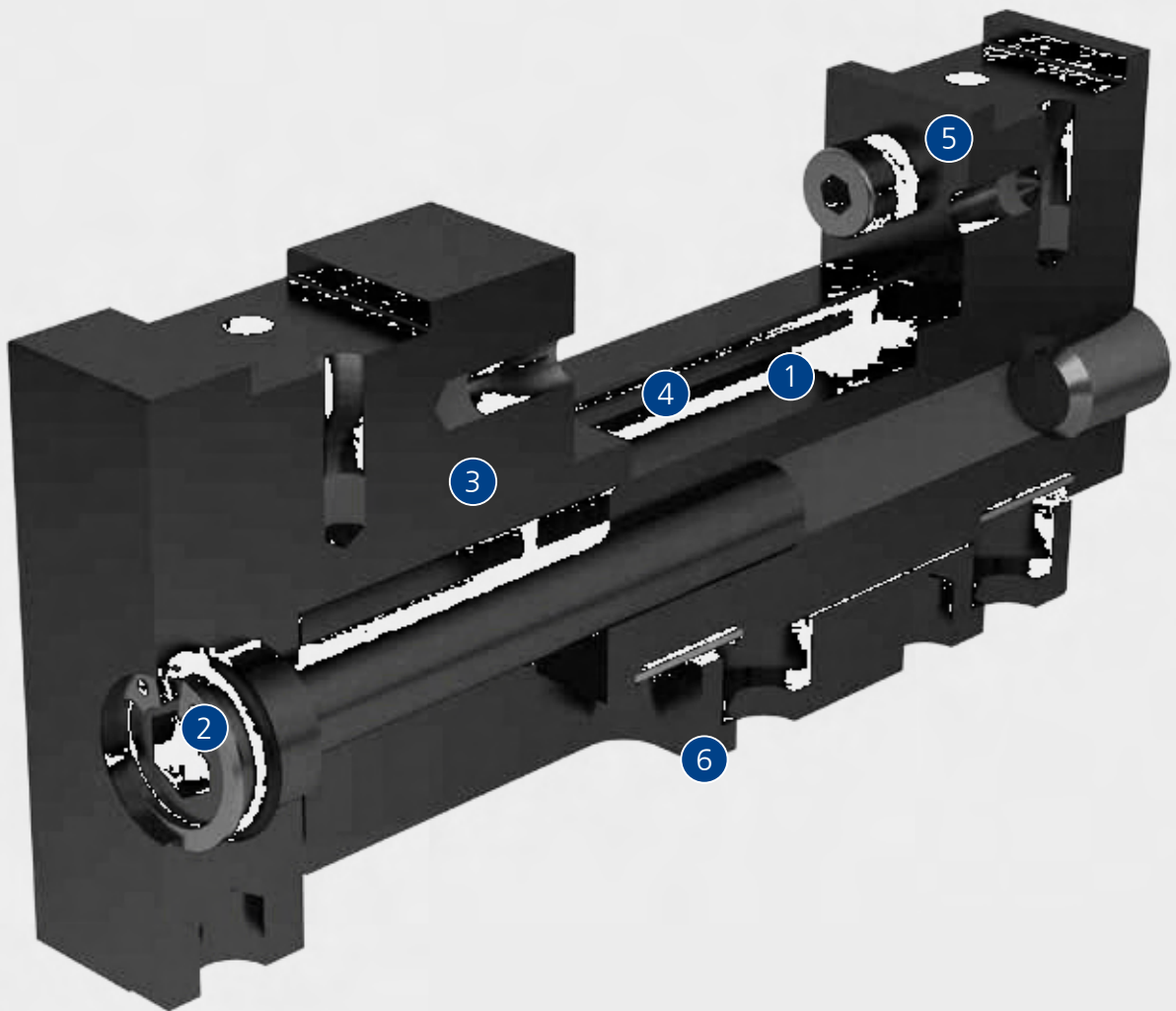

- 4** **Werkstückunterlagen**
 - einschwenkbare GRESSEL Werkstückunterlagen in unterschiedlichen Höhen

Workpiece supports

 - swivelling GRESSEL workpiece supports in different heights
- 5** **Modulares System**
 - vielseitig in der Anwendung durch modulares Aufsatzbacken-System

Modular system

 - versatile application thanks to modular top jaws system
- 6** **Kompakte Bauweise**
 - ideal für GRESSEL Werkstück-speicher-Paletten
 - ideal als Mehrfachspanner auf Grund-platten oder Aufspanntürmen

Compact design

 - ideal for GRESSEL workpiece storage pallets
 - ideal for multiple vices on base plates or tombstones

Baukasten Construction kit



solinos 40
Seite · page 89



solinos 40
Stufenbacke
stepped jaw



solinos 40
Backe grip
grip jaw



solinos 40
vergrößerte Spannweite Backe grip
extended grip clamping range



solinos 40-4V-IT
integriert in Turm
integrated into the tombstone
Seite · page 90

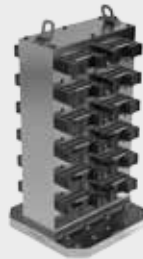

solinos 40 auf Aufspannturm
Mehrfachspannung auf Aufspannturm
multiple clamping on a tombstone

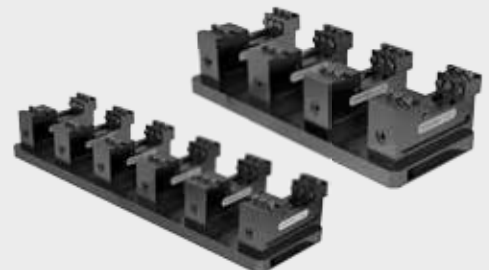

solinos 40
Mehrfachspannung auf Spannpaletten
multiple clamping on clamping pallets
Seite · pages 91/92

Standard Schnittstelle Standard interface

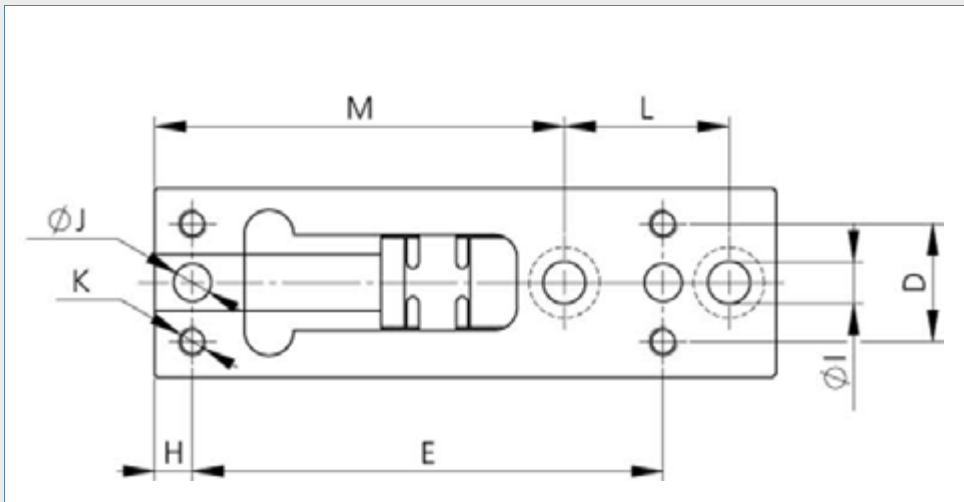

Masse (mm) Dimensions (mm)

Typ	Type	D	E	H	ØI	ØJ _{H7}	K	L	M
solinos 40		25	100	8	9	8	M6	40	82

Anwendungen Applications



solinos 40
8 solinos 40 auf Schwenkbrücke montiert
solinos 40
8 solinos 40 mounted on the swivel bridge



solinos 40
24 solinos 40 auf Kreuzturm montiert
solinos 40
24 solinos 40 mounted on a cross tombstone

Anwendungen Applications



solinos 40
Spannpalette 4-fach mit 4 solinos 40 montiert auf gredoc NRS 10-fach, ø660
solinos 40
Clamping pallet 4-fold with 4 solinos 40 mounted on gredoc NRS 10-fold, ø660



solinos 40
Spannpalette 4-fach mit 4 solinos 40 montiert auf gredoc eckig
solinos 40
Clamping pallet 4-fold with 4 solinos 40 mounted on rectangular gredoc

Anwendungen Applications



solinos 40
Spannpalette 4-fach mit 4 solinos 40 montiert auf gredec eckig
solinos 40
Clamping pallet 4-fold with 4 solinos 40 mounted on rectangular gredec



solinos 40-4V-IT
Montiert auf Lehmann Teilapparat 520
solinos 40-4V-IT
Mounted on Lehmann 520 component part

Anwendungen Applications



solinos 40-4V-IT
Monoblockturm gespannt auf gredec rund
solinos 40-4V-IT
Monoblock tombstone clamped on round gredec



solinos 40
Spannpalette 8-fach mit 8 solinos 40 montiert
solinos 40
Clamping pallet 8-fold with 8 solinos 40 mounted

Technische Informationen

1. Funktionsprinzip solinos 40

Der solinos 40 ist ein Direktspanner. Der mechanische Antrieb erfolgt über ein abgedichtetes Gewinde. Der Kraftaufbau erfolgt direkt, ohne Kraftverstärker und ist linear. Die Spannkraften sind abhängig vom eingeleiteten Drehmoment und der Spannereich reicht von 0 bis max. 122 mm.

2. Spannkraften solinos 40

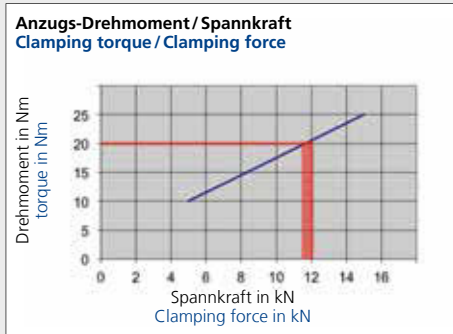

Technical information

1. Functional principle solinos 40

solinos 40 is a direct clamping device. The mechanical drive is integrated in a sealed spindle assembly. The force is generated directly without a force amplifier and is linear. The clamping forces depend on the torque moment, clamping range from 0 to max. 122 mm.

2. Clamping forces solinos 40

Baugröße Assembly size	max. Anzugs-Drehmoment max. torque moment	max. Spannkraft max. clamping force
solinos 40	20 Nm	12 kN

3. Aufspannen/Ausrichten

Die Positionierung erfolgt in der Grundausführung mit 2 Stück Positionierbohrungen $\varnothing 8H7$, mit denen der solinos 40 auf Rasterplatten (Raster 50x50) und Maschinentischen mit T-Nut ausgerichtet werden kann. Der solinos 40 kann mit 2 Befestigungsschrauben M8 von oben befestigt werden. Alternativ: Mit 4 Befestigungsschrauben M6 von unten befestigen.



In the basic version two positioning holes $\varnothing 8H7$ serve for positioning of the solinos 40 clamping device on grid plates (grid size 50x50) and machine tables with T-slots. solinos 40 is clamped from above using 2 clamping screws M8. Alternatively it may be clamped from below with 4 clamping screws M6.

Alternativ kann der solinos 40 auch mit Spannpratzen seitlich aufgespannt werden.



Otherwise it is also possible to clamp solinos 40 laterally with clamping claws.

Der solinos 40 kann in Kombination mit einer Zwischenplatte auf dem Nullpunkt-Spannsystem gredoc aufgebaut werden. Siehe Kapitel 13 gredoc.



In combination with an intermediate plate solinos 40 can also be mounted on a gredoc zero point clamping system. See chapter 13, gredoc.

solinos 40

**Standard
Standard**



solinos 40

3

Typ Type	Beschreibung Description	Backenbreite Jaw width	Spannkraft Clamp. force	Gewicht Weight	Lieferumfang Delivery details	Bestell-Nr. Order No.
		mm	kN	kg		
solinos 40	Kleinteil-Einfachspanner mechanisch Single vice for small workpieces mechanical	40	max. 12	1.7	solinos 40 inkl. Schrauben für Aufsatzbacken solinos 40 incl. screws for top jaws	KLM.040.001.01

Masse (mm) Dimensions (mm)

Typ Type	A	B	B1	B2	C _{±0.01}	D	E	F _{±0.02}	G	L _{max}
solinos 40	40	17-58	40-81	83-122	40	22	62	100	132	141

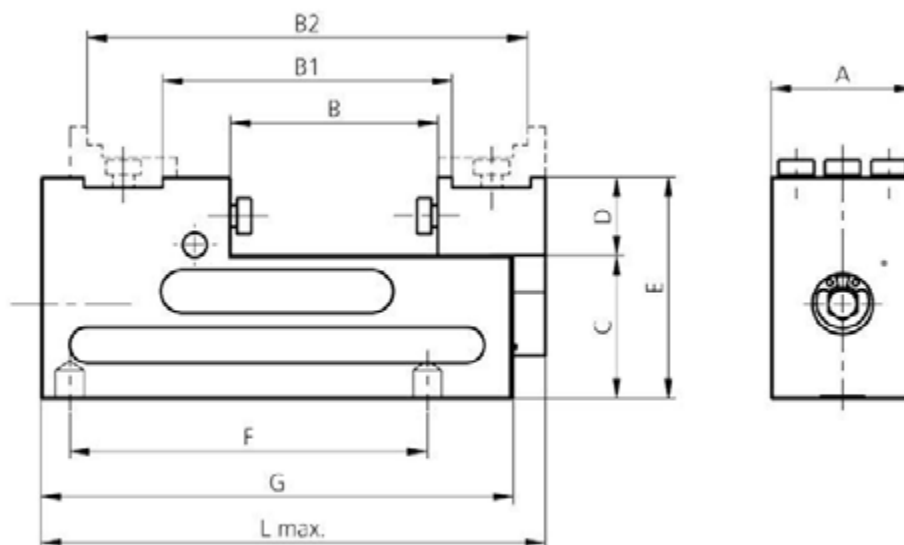

solinos 40-4V-IT

4-fach Monoblock-Turm
4-fold monobloc tombstone



Typ Type	Beschreibung Description	Backenbreite Jaw width	Spannkraft Clamp. force	Gewicht Weight	Lieferumfang Delivery details	Bestell-Nr. Order No.
		mm	kN	kg		
solinos 40-4V-IT	Kleinteil-Einfachspanner mechanisch, 4-fach Monoblock Turm Single vice for small workpieces, me- chanical, 4-fold monobloc tombstone	40	max. 12	8.0	Schrauben für Aufsatzbacken, ohne Palette Screws for top jaws, without pallet	KLM.040.020.01

Masse (mm) Dimension (mm)

Typ Type	A	B	B1	C _{±0.02}	D	E	øF	G	H _{±0.015}	I	øJ _{m6}	øK _{H7}	L	M	M1	N
solinos 40-4V-IT	40	17-58	40-81	91	22	135	149	132	100	100	12	25	148	34	53	M10

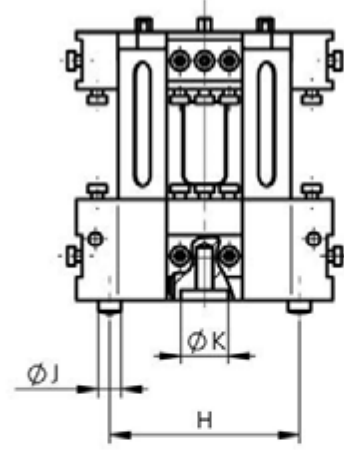
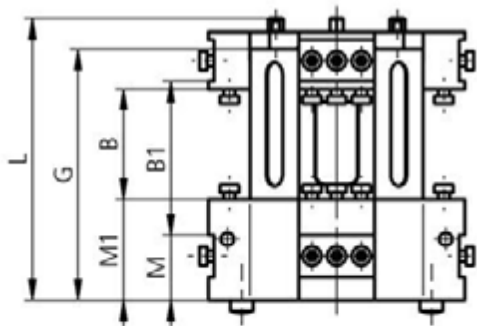

Ansicht A
View A

Ansicht von unten
Bottom view

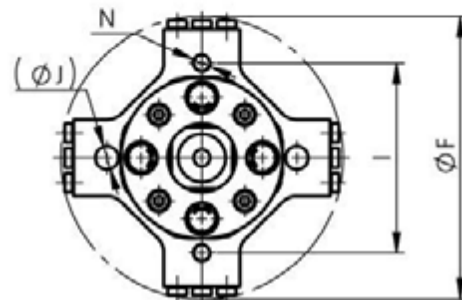
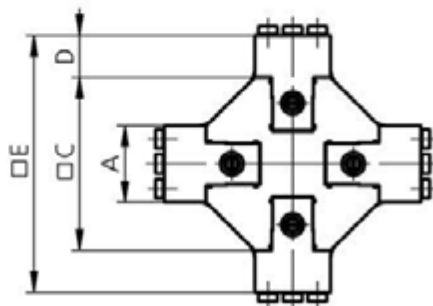

Ansicht von unten
Bottom view

solinos 40 Spannpalette · Clamping pallet

Spannpalette 4-fach Clamping pallet 4-fold



Typ Type	Beschreibung Description	Backenbreite Jaw width	Masse Dimensions	Gewicht Weight	Lieferumfang Delivery details	Bestell-Nr. Order No.
		mm	mm	kg		
solinos 40	Spannpalette 4-fach Clamping pallet, 4-fold	40	360 x 140	7.2	Palette inkl. Befestigungsmaterial für 4 solinos 40, ohne Spannmittel und Aufnahmebolzen Pallet, incl. fastening material for 4 solinos 40, without clamping device and alignment bolts	NGA.000.035.01

Alle solinos 40 können längs und quer montiert werden.
All solinos 40 can be mounted longitudinal and transverse.

Masse (mm) Dimension (mm)

Typ Type	A	B	C	D	E	F _{±0.015}
solinos 40 Spannpalette 4-fach solinos 40 Clamping pallet, 4-fold	360	140	20	100	75	200

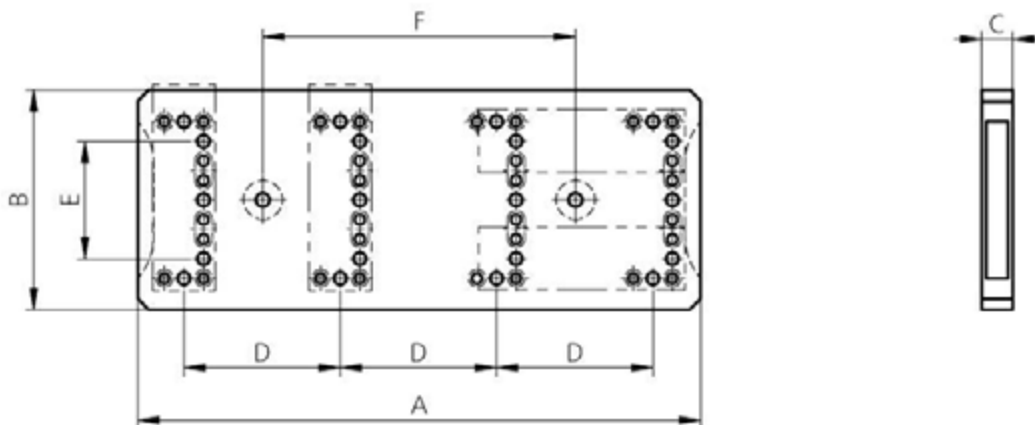

solinos 40 Spannpalette · Clamping pallet

Spannpalette 6-fach
Clamping pallet 6-fold

Typ Type	Beschreibung Description	Backenbreite Jaw width	Masse Dimensions	Gewicht Weight	Lieferumfang Delivery details	Bestell-Nr. Order No.
		mm	mm	kg		
solinos 40	Spannpalette 6-fach Clamping pallet, 6-fold	40	560 x 140	11.4	Palette inkl. Befestigungsmaterial für 6 solinos 40, ohne Spannmittel und Aufnahmebolzen Pallet, incl. fastening material for 6 solinos 40, without clamping device and alignment bolts	NGA.000.036.01

Alle solinos 40 können längs und quer montiert werden.
All solinos 40 can be mounted longitudinal and transverse.





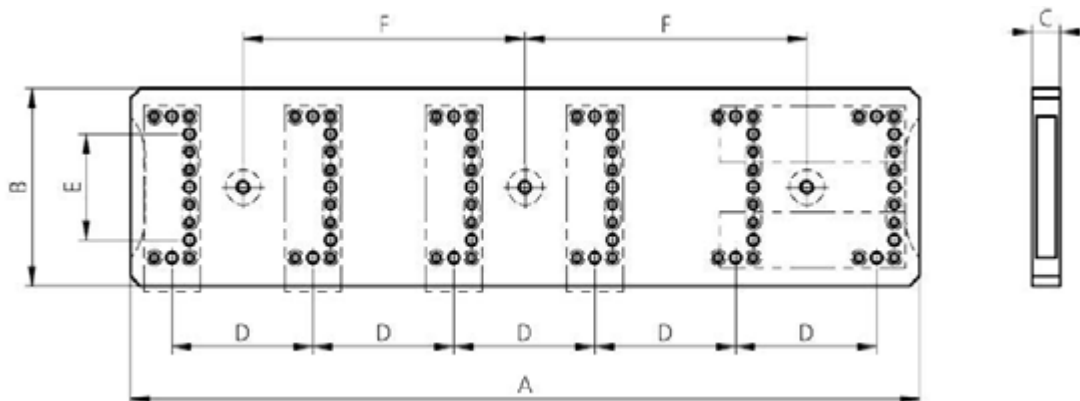

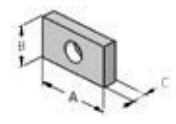
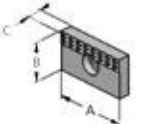
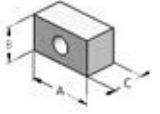
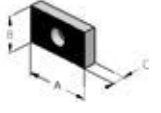
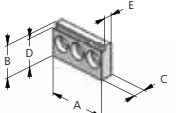
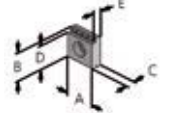
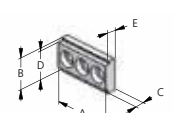
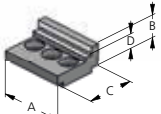
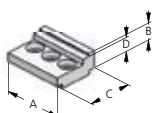

Masse (mm) Dimension (mm)

Typ Type	A	B	C	D	E	F _{±0.015}
solinos 40 Spannpalette 6-fach	560	140	20	100	75	200



solinos 40 Aufsatzbacken · Top jaws

	Bezeichnung Designation	Masse (mm) Dimensions (mm)					passend zu Typ suitable for type	Bestell-Nr. Order No.
		A	B	C	D	E		
	Backe geschliffen Höhe = 22 mm (1 Stk.) Ground jaw Height = 22 mm (1 pc.)	40	22	7.7			solinos 40	FSA.040.036.11
	Backe grip Höhe = 22 mm (1 Stk.) Grip jaw Height = 22 mm (1 pc.)	40	22	7.8			solinos 40	FSA.040.039.01
	Backe weich Höhe = 22 mm (1 Stk.) Soft jaw Height = 22 mm (1 pc.)	40	22	20			solinos 40	FSA.040.037.11
	Backe gehauen Höhe = 22 mm (1 Stk.) Serrated jaw Height = 22 mm (1 pc.)	40	22	8			solinos 40	FSA.040.035.11
	Universal-Stufenbacke (1 Stk.) Universal stepped jaw (1 pc.)	40	22	8	19	5.5	solinos 40	KLA.040.001.11
	Backe grip Breite 22 = 65, wendbar (1 Stk.) Grip jaw Width 22 = 65, reversible (1 pc.)	22	22	8	19	5.5	solinos 40	CSA.065.005.11
	Backe grip wendbar Stufe mit 2 mm vertikal, Stufe mit 2 mm horizontal (1 Stk.) Grip jaw, reversible Step with 2 mm vertical, Step with 2 mm horizontal (1 pc.)	40	22	8	20	5.5	solinos 40	KLA.040.002.11
	Backe glatt VS beschichtet, horizontal (1 Stk.) Smooth jaw, VS coated, horizontal (1 pc.)	40	14	30	9		solinos 40	KLA.040.003.11
	Backe grip VS horizontal (1 Stk.) Grip jaw, VS horizontal (1 pc.)	40	11	30	9		solinos 40	KLA.040.004.11

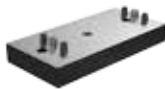
solinos 40 Zubehör · Accessories			
	Bezeichnung Designation	passend zu Typ suitable for type	Bestell-Nr. Order No.
	Werkstückanschlag Workpiece stop	solinos 40	FSA.000.010.01
	Werkstückunterlagen für solinos 40, Höhe ... (Satz à 2 Stk.) Workpiece supports for solinos 40, height ... (set of 2 pcs.)	11 mm 16 mm	KLA.040.011.01 KLA.040.016.01
	Drehmomentschlüssel 8–50 Nm, mit Vierkant-Antrieb 3/8" ohne Sechskant-Einsatz Torque wrench 8–50 Nm, with square-drive 3/8" without hexagonal-insert	solinos 40	XNF.91101.021
	Sechskant-Stifteinsatz SW 8, 3/8" Hexagonal pin insert SW 8, 3/8"	solinos 40	XNF.91102.080
	Schnellverstellung SW 8 Quick adjustment SW 8	solinos 40	CSA.065.010.01
	Aufspannschrauben für Spannpratzen , für T-Nut (Satz à 2 Stk.) Clamping screws for clamping claws , for T-slot (set of 2 pcs.)	12 mm/M10 14 mm/M12 16 mm/M14 18 mm/M16	MAA.000.012.01 MAA.000.014.01 MAA.000.016.01 MAA.000.018.01
	Aufspannset für Befestigung durch den Grundkörper (2x M8 Schrauben und 2x Stifte ø8) Clamping set for fixing through the tool body (2x M8 screws and 2x pins ø8)	solinos 40	KLA.040.030.01
	Spannpratzen (2 Stk.) Clamping claws (2 pcs.)	solinos 40	GPA.000.015.01
	Positionieret gredoc (ø8, ø12) gredoc positioning set (ø8, ø12)	solinos / gredoc	CSA.000.012.01
	Zwischenplatte solinos solinos intermediate plate	solinos 40	NGA.000.031.01