

# INSTALLATION, OPERATION AND MAINTENANCE INSTRUCTIONS FOR 6 VOLT 50 WATT HEAVY DUTY EMERGENCY UNIT

---

## IMPORTANT SAFEGUARDS:

When using Electrical equipment, basic safety precautions should always be followed including the following.

## READ AND FOLLOW ALL SAFETY INSTRUCTIONS

- Do not use outdoors.
- Do not let power supply cords touch hot surfaces.
- Do not mount near gas or electric heaters.
- Equipment should be mounted securely in locations and at heights where it will not be subjected to tampering by unauthorized personnel.
- The use of accessory equipment and replacement parts not recommended by the manufacturer may cause an unsafe condition.
- Do not use this equipment for other than its intended purpose.
- The AC voltage rating of this equipment is specified on the product label. Do not connect equipment to any other voltage.

## SAVE THESE INSTRUCTIONS!

## INSTALLTION:

1. Remove the front cover.
2. Mount the equipment securely in place on the wall. Two additional 'Key Hole' mounting holes are located at the top of the unit housing in addition to the 'J-Box' mounting holes. These '2' additional mounting slot holes must be used when the unit is mounted to the wall. Additional chain support may be required by local codes. Chain hook holes are provided at each end of the enclosure.
3. Extend 24 hr AC supply of rated voltage to the equipment, which is furnished with a dual voltage (120/277V) field selectable input. Connect unit to utility power using an approved connector. For 120V supply connect the line wire to the black lead and for 277V supply connect the line wire to the red lead. Connect neutral wire to the white lead. The ground wire (green lead) needs to be connected in accordance with the local codes. DO NOT energize the circuit at this time. (**CAUTION:** Insulate the unused black or red wire. Failure to do so may cause an unsafe condition.)
4. If remote fixtures are to be connected to the equipment extend the remote circuit in accordance with Article 700 and 720 of the National Electric Code (NEC) and connect to the yellow and violet leads coming out of the unit. (**CAUTION:** The minimum wire size required by the NEC is 12 gauge Copper or equivalent. Your installation may require larger sized wire to ensure that the voltage drop DOES NOT exceed 5%. Do not exceed the total output rating of the equipment including any additional mounted heads.)
5. Install and connect the battery. Refer to the Illustration. Connect the Red (+) lead from the PC board assembly to the positive (+) terminal on the battery and the Blue (-) lead from the PC board assembly to the negative (-) terminal. (**CAUTION:** Observe polarity. Failure to connect the battery properly will result in equipment failure and an unsafe condition.) **NOTE: The Emergency lights will NOT come ON at this time.**
6. Energize the unit with AC supply. The charge indicator will illuminate.
7. Replace the unit cover.
8. Adjust and focus the lighting heads as required.

## OPERATION:

1. To test the equipment, depress the TEST switch. The charge (LED) indicator will turn OFF and the emergency lights will illuminate.
2. Once you release the TEST switch the emergency lights will turn OFF and the charge (LED) indicator will illuminate.
3. The automatic charger will return into action, charging the battery and trying to maintain it in a fully charged state. (**CAUTION:** This equipment is furnished with a sophisticated solid state transfer switch which will automatically disconnect the emergency lights from the battery if the battery has been discharged to the end of its useful output.)

**NOTE: Allow the battery to charge for a minimum of 24 hrs after installation or after a power failure before conducting a 90-minute test (see TESTING section).**

## MAINTENANCE:

**CAUTION:** Always turn OFF AC power to the equipment before servicing. Servicing should be performed only by a qualified service technician. Only manufacturer SUPPLIED or APPROVED replacement parts must be used.

1. **BATTERY:** The battery supplied with this unit requires ZERO maintenance. However it should be tested periodically (see TESTING section) and replaced when it no longer operates the connected fixtures for the complete duration of a 30-second or 90-minute test. It has a life expectancy of 5-7 yrs when used in a normal ambient temperature of 72oF.
2. **OTHER:** Clean lenses and replace lamps as and when required.

## TESTING:

Paragraph 31-1.3.7 of NFPA 101-1985, Life Safety Code requires that all emergency lighting equipment be functionally tested every 30 days for a minimum of 30 seconds and tested annually for full 90-minute duration. Written records of the testing are to be kept for examination by the authority having jurisdiction.

## TROUBLE-SHOOTING:

1. The emergency lights DO NOT operate and
  - a. If the charge indicator light is OFF – Check that the circuit breaker for AC supply is ON.
  - b. If the charge indicator light is ON
    - Check that the battery is properly connected.
    - If remote lamps are connected to the equipment, then turn OFF the AC supply and disconnect the remote circuit wires from the equipment. Turn ON the AC supply and depress the test switch. If the local lamps (mounted on the equipment itself) come ON, then check the remote circuit for short or overload condition and correct as required. Reconnect the circuit wires and restore AC power.
    - If the local lamps don't turn ON after disconnecting the remote circuit wires, then replace battery.
2. Emergency lights are dim – Implies battery might not be fully charged. Allow battery to recharge for 24 hours and then re-test.
3. Remote lights are dim – Remote wire size is too small causing excessive voltage drop (more than the permitted 5%) and thus causing the lamps to illuminate with less intensity. Refer to STEP 4 of INSTALLATION section for more information.

**WARNING:** Unused wires must be capped using enclosed wire nuts.

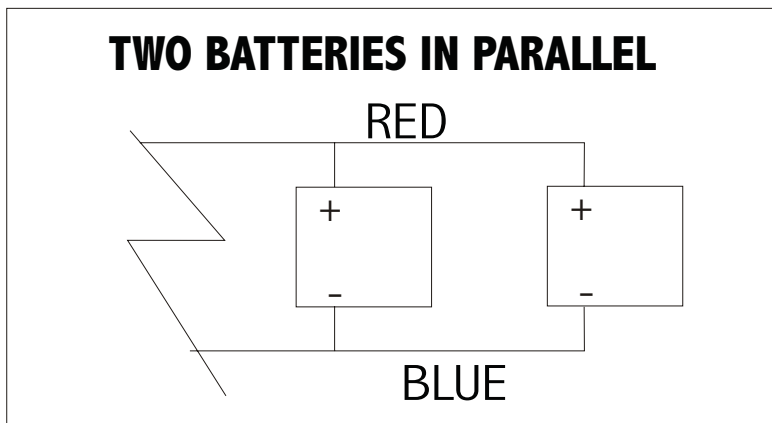
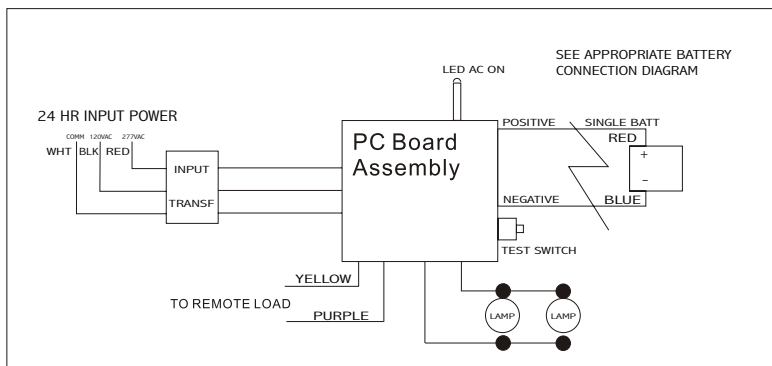

**NOTE:** See battery replacement label inside of unit for battery part number. See lamp replacement label inside of unit or on lamp head for part number.