

# FLOOD LIGHT(MFD08)



## DESCRIPTION

The MFD08 luminaire is a high performance LED lighting solution designed with optical versatility and a slim, low profile design. Its rugged cast aluminum housing minimizes wind load requirements and features an integral, watertight LED driver compartment and high performance aluminum heat sinks. Markets include parking lots, walkways, campuses, car dealerships, office complexes, and internal roadways.

## SPECIFICATION FEATURES

### Construction

- Housing, electrical compartment and fitter are all made from die case aluminum that is pre-treated and powder-coated to meet the most rugged industry standards.
- Door frame features an integral accessory channel for the mounting of optional light control accessories.
- Vented housing isolates LED module from driver, maximizing product life and performance
- Door frame seals to housing with a continuous extruded silicone gasket.

### Optics

- Optics(NEMA Type): 7H\*6V, 4Hx4V
- Scalable Lumen Packages from 1,950 to 50,000 Lumens.
- Provides the best combination of vertical and horizontal illumination while reducing light behind the poles.
- High performance acrylic optic securely attached to internal heat sink for maximum thermal dissipation.

### Electrical

- Universal 120-277 VAC or 347-480 VAC input voltage.
- Both drivers have a power factor >90%, THD <20%, and an expected life of 100,000 hours.
- Operating Temperature Range: -40°C - + 40°C (-40°F - + 104°F)

### Lifespan

- Estimated 100,000-hour LED lifespan based on IES LM-80 results and TM-21 calculations

### Warranty

- Five-year warranty.

### Certifications

- DesignLights Consortium™ Qualified.
- UL cUL wet location listed.
- Note: DesignLights Consortium™ Qualified and classified for DLC Standard (all lumen packages), refer to [www.designlights.org](http://www.designlights.org) for details.

15W&27W



70W&100W



135W&200W



250W&350W



45W&60W



### PHOTOMETRICS

4HX4V  
only suitable for 135W,  
200W, 250W, 350W

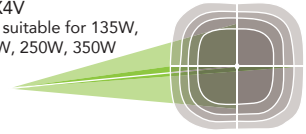

7HX6V

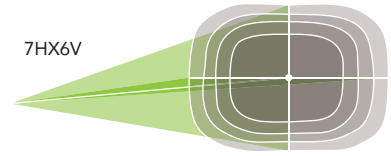

### ACCESSORIES



#### Photocell

No. PC-JL-120-277V

USE: Photocell is field installed or pre-installed in factory by requesting

## DIMENSIONS

unit: mm/inch

15W&27W(Knuckle Mount)

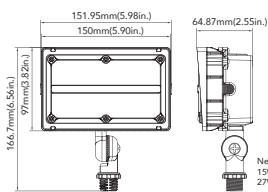

15W&27W(Trunnion Mount)

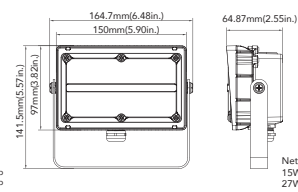

45W&60W(Knuckle Mount)

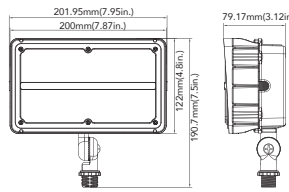

45W&60W(Trunnion Mount)

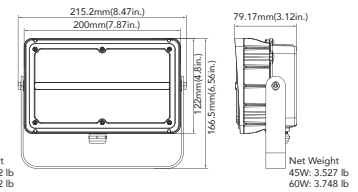

70W&100W(Slipfitter Mount)

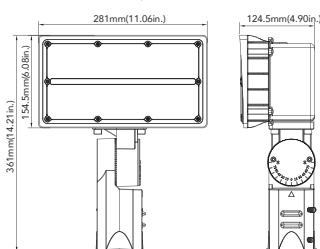

70W&100W(Yoke Mount)

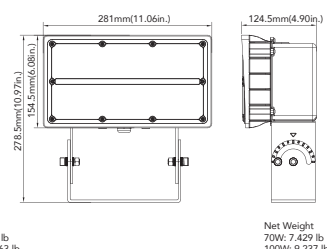

135W&200W(Slipfitter Mount)

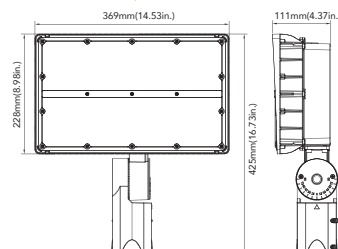

135W&200W(Yoke Mount)

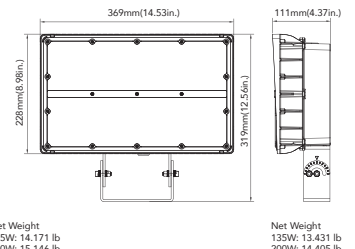

250W/350W(Trunnion Mount)

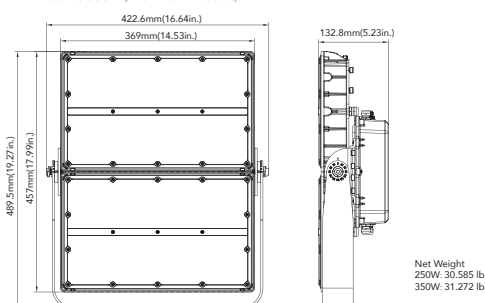





## PERFORMANCE DATA

SYSTEM WATTS	VOLTAGE	DIST. TYPE	CRI	LUMENS (3000K)	LPW (3000K)	LUMENS (3500K)	LPW (3500K)	LUMENS (4000K)	LPW (4000K)	LUMENS (5000K)	LPW (5000K)
15W	120-277V	7Hx6V	70	1950lm	130 lm/W	1950lm	130 lm/W	2000lm	133 lm/W	2000lm	133 lm/W
27W	120-277V	7Hx6V	70	3600lm	133 lm/W	3600lm	133 lm/W	3700lm	137 lm/W	3700lm	137 lm/W
45W	120-277V	7Hx6V	70	6000lm	133 lm/W	6000lm	133 lm/W	6150lm	137 lm/W	6150lm	137 lm/W
60W	120-277V	7Hx6V	70	7400lm	123 lm/W	7400lm	123 lm/W	7800lm	130 lm/W	7800lm	130 lm/W
60W	347-480V	7Hx6V	70	7500lm	125 lm/W	7500lm	125 lm/W	7800lm	130 lm/W	7800lm	130 lm/W
70W	120-277V	7Hx6V	70	9200lm	131 lm/W	9200lm	131 lm/W	9400lm	134 lm/W	9400lm	134 lm/W
70W	347-480V	7Hx6V	70	9100lm	130 lm/W	9100lm	130 lm/W	9300lm	133 lm/W	9300lm	133 lm/W
90W	347-480V	7Hx6V	70	13000lm	144 lm/W	13000lm	144 lm/W	13400lm	149 lm/W	13400lm	149 lm/W
100W	120-277V	7Hx6V	70	13100lm	131 lm/W	13100lm	131 lm/W	13500lm	135 lm/W	13500lm	135 lm/W
135W	120-277V	4Hx4V	70	17500lm	130 lm/W	17500lm	130 lm/W	18000lm	133 lm/W	18000lm	133 lm/W
135W	347-480V	4Hx4V	70	17500lm	130 lm/W	17500lm	130 lm/W	18000lm	133 lm/W	18000lm	133 lm/W
135W	120-277V	7Hx6V	70	18000lm	133 lm/W	18000lm	133 lm/W	18500lm	137 lm/W	18500lm	137 lm/W
135W	347-480V	7Hx6V	70	18000lm	133 lm/W	18000lm	133 lm/W	18500lm	137 lm/W	18500lm	137 lm/W
200W	120-277V	4Hx4V	70	26000lm	130 lm/W	26000lm	130 lm/W	26500lm	133 lm/W	26500lm	133 lm/W
200W	347-480V	4Hx4V	70	26000lm	130 lm/W	26000lm	130 lm/W	26500lm	133 lm/W	26500lm	133 lm/W
200W	120-277V	7Hx6V	70	26000lm	130 lm/W	26000lm	130 lm/W	27000lm	135 lm/W	27000lm	135 lm/W
200W	347-480V	7Hx6V	70	26000lm	130 lm/W	26000lm	130 lm/W	27000lm	135 lm/W	27000lm	135 lm/W
250W	120-277V	4Hx4V	70	36500lm	146 lm/W	36500lm	146 lm/W	37500lm	150 lm/W	37500lm	150 lm/W
250W	347-480V	4Hx4V	70	36500lm	146 lm/W	36500lm	146 lm/W	37500lm	150 lm/W	37500lm	150 lm/W
250W	120-277V	7Hx6V	70	36000lm	144 lm/W	36000lm	144 lm/W	37000lm	148 lm/W	37000lm	148 lm/W
250W	347-480V	7Hx6V	70	36000lm	144 lm/W	36000lm	144 lm/W	37000lm	148 lm/W	37000lm	148 lm/W
350W	120-277V	4Hx4V	70	48000lm	137 lm/W	48000lm	137 lm/W	49500lm	141 lm/W	49500lm	141 lm/W
350W	347-480V	4Hx4V	70	48000lm	137 lm/W	48000lm	137 lm/W	49500lm	141 lm/W	49500lm	141 lm/W
350W	120-277V	7Hx6V	70	48000lm	137 lm/W	48000lm	137 lm/W	50000lm	143 lm/W	50000lm	143 lm/W
350W	347-480V	7Hx6V	70	48000lm	137 lm/W	48000lm	137 lm/W	50000lm	143 lm/W	50000lm	143 lm/W

## ELECTRICAL DATA

Number Of Drivers	Driver Current (mA)	Nominal Power (W)	INPUT VOLTAGE (V)	CURRENT (Amps)
1	250	15	120	0.13
		15	208	0.07
		15	240	0.06
		15	277	0.05
1	430	27	120	0.23
		27	208	0.13
		27	240	0.11
		27	277	0.10
1	770	45	120	0.38
		45	208	0.22
		45	240	0.19
		45	277	0.16
1	920	60	120	0.50
		60	208	0.29
		60	240	0.25
		60	277	0.22
1	1750	70	120	0.58
		70	208	0.34
		70	240	0.29
		70	277	0.25
1	1850	70	347	0.20
		70	480	0.15
1	2600	100	120	0.83
		100	208	0.48
		100	240	0.42
		100	277	0.36
2	2400	90	347	0.26
		90	480	0.19
2	3500	135	120	1.13
		135	208	0.65
		135	240	0.56
		135	277	0.49
		135	347	0.39
		135	480	0.28
2	5000	200	120	1.67
		200	208	0.96
		200	240	0.83
		200	277	0.72
		200	347	0.58
		200	480	0.42
1	6500	250	120	2.08
		250	208	1.20
		250	240	1.04
		250	277	0.90
		250	347	0.72
		250	480	0.52
1	5600	350	120	2.92
		350	208	1.68
		350	240	1.46
		350	277	1.26
		350	347	1.01
		350	480	0.73

# EPA

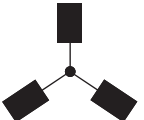
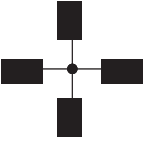
Item							
	1	2 @90°	2 @120°	2@180°	3 @90°	3 @120°	4 @90°
70W/100W	0.2885	0.6097	0.7475	0.577	0.8982	0.8196	0.8982
135W/200W	0.3868	0.8125	0.9973	0.7736	1.1993	1.0874	1.1993
250W/350W	0.536	1.061	1.278	1.072	1.597	1.803	1.597

## ORDERING GUIDE

Example:MFD0845W27V50KYYYYY

Fixture Type	Wattage	Voltage	CCT	Finish	Photocell (Option)	Nema	Mounting	Internal Code
<input type="text"/>	<input type="text"/>	<input type="text"/>	<input type="text"/>	<input type="text"/>	<input type="text"/>	<input type="text"/>	<input type="text"/>	<input type="text"/>
<b>MFD08</b> Flood Light series	<b>15</b> 15W <b>27</b> 27W <b>45</b> 45W <b>60</b> 60W	<b>27V</b> 120-277V	<b>30K</b> 3000K <b>35K</b> 3500K <b>40K</b> 4000K <b>50K</b> 5000K	<b>D</b> Dark Bronze <b>B</b> Black <b>W</b> White	<b>P0</b> With Photocell <b>Blank</b> Without Photocell	<b>B76</b> 7HX6V	<b>TR</b> Trunnion Mount <b>KN</b> Knuckle Mount	<b>Blank</b> <b>Alphanumeric</b>

Example:MFD08135W27V50KYYYYYY

Fixture Type	Wattage	Voltage	CCT	Dimmable	Finish	Photocell (Option)	Nema	Mounting	Internal Code
<input type="text"/>	<input type="text"/>	<input type="text"/>	<input type="text"/>	<input type="text"/>	<input type="text"/>	<input type="text"/>	<input type="text"/>	<input type="text"/>	<input type="text"/>
<b>MFD08</b> Flood Light series	<b>70</b> 70W <b>90</b> 90W <b>100</b> 100W <b>135</b> 135W <b>200</b> 200W <b>250</b> 250W <b>350</b> 350W	<b>27V</b> 120-277V <b>48V</b> 347-480V	<b>30K</b> 3000K <b>35K</b> 3500K <b>40K</b> 4000K <b>50K</b> 5000K	<b>D</b> 1-10VDIM <b>Blank</b> NO DIM	<b>D</b> Dark Bronze <b>B</b> Black <b>W</b> White	<b>P0</b> With Photocell <b>Blank</b> Without Photocell	<b>B44</b> 4Hx4V <b>B76</b> 7HX6V	<b>TR</b> Trunnion Mount <b>YK</b> Yoke <b>SP</b> Slipfitter Mount	<b>Blank</b> <b>Alphanumeric</b>

Note: Only 135W,200W,250W,350W optional for NEMA 4Hx4V.

## MOUNTING

1/2" Knuckle Mount (15W/27W/45W/60W)



Trunnion Mount (15W/27W/45W/60W/250W/350W)



Yoke Mount(70W/100W/135W/200W)



Slipfitter Mount(70W/100W/135W/200W)

