

Floating Curved Troffer

Back-lit LED | CCT & Wattage Adjustable

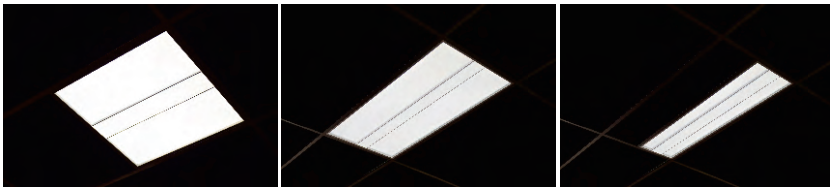

Designed to deliver an unprecedented uniformity and functionality, this floating curved troffer features a compact yet sturdy aluminum construction designed to blend into modern architectural spaces. Featuring a low profile form factor, it is ideal for buildings with a low plenum space and is suitable for all standard 2x2, 1X4 or 2x4 grid ceilings. This creates a soft and comfortable lighting experience for commercial and institutional spaces including open offices, classrooms, retail and healthcare facilities, goes beyond what was previously possible with traditional LED luminaires.



Feature

- Low profile design
- Uniform and soft illumination with back-lit technology
- CCT selectable from 3500k, 4000k and 5000k
- Wattage adjustable, up to 110lm/W



*DesignLights Consortium Qualified and classified for DLC standard/premium, refer to www.designlights.org for details

PERFORMANCE

Model NO.	Dimension	Wattage Adjustable	Lumen Output			Efficacy	CCT Adjustable
			High	Medium	Low		
TR22-DM-TWTS	2'x2'	35W/30W/25W	3850lm	3300lm	2750lm	Up to 110lm/w	3500K/4000K/5000K
TR14-DM-TWTS	1'x4'	35W/30W/25W	3850lm	3300lm	2750lm	Up to 110lm/w	3500K/4000K/5000K
TR24-DM-TWTS	2'x4'	50W/40W/30W	5500lm	4400lm	3300lm	Up to 110lm/w	3500K/4000K/5000K

All efficacy is ±5% base on different CCT and wattage. Check the IES file to gain the accurate data .

Floating Curved Troffer

Back-lit LED | CCT & Wattage Adjustable

PRODUCT PERFORMANCE

Finish

Extruded aluminum housing with powder coat white finish provides long term performance and superior aesthetic.

Electrical

LED Driver	It is powered by Class 2 high efficiency LED driver, with a standard 1-10V dimming which continuous dims to 10% that works with many types of controls. Tested Dimmers: Lutron® Diva-Dvtv, Leviton® IP-710-DL.
THD	<20%
Power Factor	>0.9
Input Voltage	Standard electronic driver is UL recognized and available for 110-277V or 110-347V* AC.

LED System

CRI	Minimum 80 color rendering index
CCT	CCT selectable from 3500K, 4000K and 5000K with a great color consistency
LED	life Minimum 50,000h with 87.8% of lumen maintenance in 25°C ambient temperature, in compliance with IES LM-80 testing measurements.
Thermal Management	Aluminum housing acting as the heat sink to maximize life.
Environment	Damp rated in operating ambient temperatures of -20°C-40°C .

Mounting

Recessed

Approvals

- cULus listed for damp locations
- Tested to IESNA LM-79 and LM-80
- DesignLights Consortium Qualified and classified for DLC standard/premium, refer to www.designlights.org for details
- 5 years limited warranty

Optional Function

Emergency Option Optional high voltage 8W emergency LED driver EM-H08170-LBF can be provided. When AC power fails, it immediately switches to the emergency mode, operating for lighting up to 120 minutes. When AC power is restored, it automatically returns to the charging mode which meets critical life-safety lighting requirements. For more info or spec sheet, please visit our website or contact sales. Emergency Lumen Output:



Fixture Efficacy	Output Power 8w
110lm/w	880 Lumens

PRODUCT ORDERING GUIDE

Sample

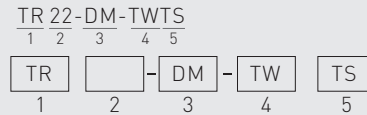

1. Base Model

TR Floating Curved Troffer

2. Size

- 22 2'X2'
 14 1'X4'
 24 2'X4'

3. Dimming

DM 1-10V Dimming

4. CCT

TW CCT Selectable 3500K / 4000K / 5000K

5. Efficacy

TS 110lm/w

OPTIONAL ORDERING GUIDE

Optional Functions

LED Emergency Driver (Order Separated)

Floating Curved Troffer

Back-lit LED | CCT & Wattage Adjustable

DIMENSION

2x2ft

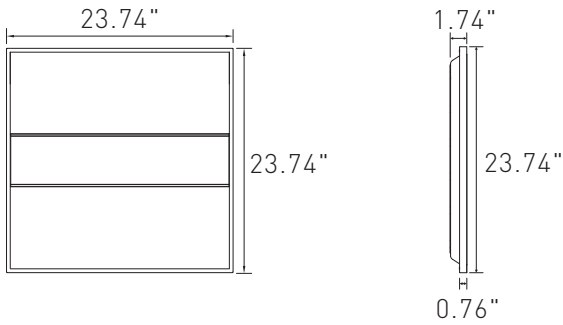

2x4ft

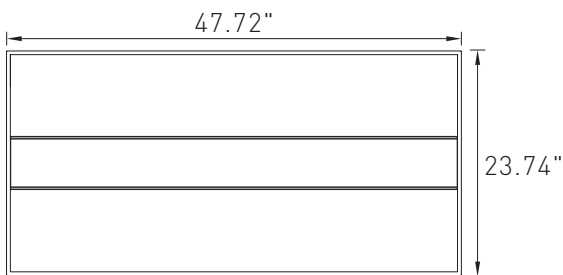

1x4ft

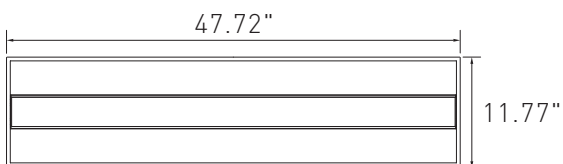

T-GRIDS CEILING COMPATIBILITY

It is architectural recessed lighting solution that compatible with most 15/16" and 9/16" t-grid systems for commercial and institutional environment. The following are only as some common examples to show.

9/16" Flat

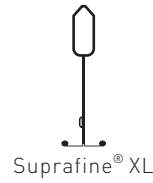

9/16" Slot

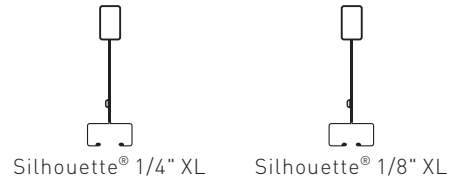

9/16" Interlude



15/16" Flat

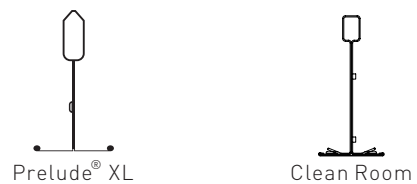

*Please verify compatibility with factory.

Floating Curved Troffer

Back-lit LED | CCT & Wattage Adjustable

DISTRIBUTION DIAGRAM

2'X2' / 3500K

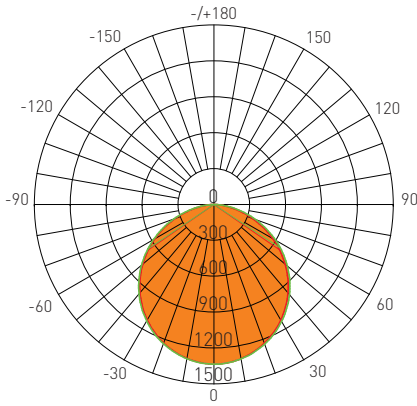

AVERAGE BEAM ANGLE(50%): 111.7°

Test Number: TR22-DM-TWTS UNIT: cd
 Lumens: 3747.4 Lm — C0/180, 110.8°
 Watts: 33.80 W — C30/270, 112.6°
 LPW: 110.86 Lm/W
 CCT: 3500K

Zonal Flux Diagram

τ	C0	C45	C90	C135	C180
10	1308	1309	1311	1307	1306
20	1233	1236	1242	1233	1232
30	1118	1121	1132	1118	1115
40	964.2	968.6	983.4	966.3	961.9
50	777.6	785.4	802.5	783.2	777.2
60	566.6	575.9	594.9	575.0	568.6
70	344.4	354.0	372.1	354.2	346.5
80	128.7	139.2	154.9	139.9	132.6
90	0	0	0	0	0
100	0	0	0	0	0
110	0	0	0	0	0
120	1.021	0.0582	0.0031	0.0692	0.3140
130	1.326	0.1745	1.151	0.0346	0.9394
140	1.302	0	1.281	0	1.406
150	1.213	0	0.7683	0	1.452
160	0.8069	0	0.7699	0	1.452
170	1.023	0.1111	0.7715	0	1.452
180	1.196	0.1708	0.9402	0	1.452
DEG	LUMINOUS INTENSITY:cd				

Zonal Lumens

τ	φ total
0-10	126.1
10-20	486.2
20-30	1031
30-40	1686
40-50	2364
50-60	2972
60-70	3430
70-80	3686
80-90	3745
90-100	3745
100-110	3745
110-120	3745
120-130	3746
130-140	3746
140-150	3747
150-160	3747
160-170	3747
170-180	3747
UNIT: lm	

Luminance cd/(m2)

G(DEG)	C0/180	C90/270
85	4616	6897
80	7416	8919
75	8994	10072
70	10072	10875
65	10794	11451
60	11335	11895
55	11773	12229
50	12101	12481
45	12370	12675

1'X4' / 3500K

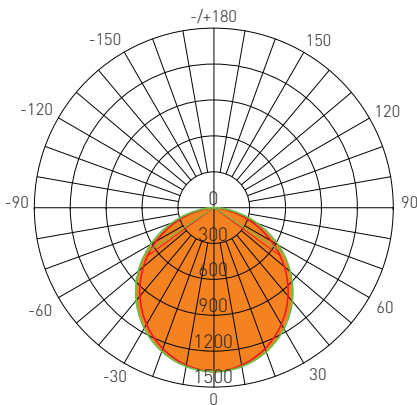

AVERAGE BEAM ANGLE(50%): 110.8°

Test Number: TR14-DM-TWTS UNIT: cd
 Lumens: 3786.8 Lm — C0/180, 108.0°
 Watts: 33.72 W — C30/270, 113.7°
 LPW: 112.30 Lm/W
 CCT: 3500K

Zonal Flux Diagram

τ	C0	C45	C90	C135	C180
10	1336	1347	1348	1340	1336
20	1254	1271	1281	1261	1252
30	1127	1150	1170	1138	1126
40	963.6	989.3	1020	978.3	964.1
50	769.5	795.2	834.4	786.5	771.1
60	551.3	576.8	620.4	571.2	554.9
70	322.2	345.0	387.4	343.2	327.4
80	102.7	128.4	159.0	128.4	111.3
90	0	0.0247	0.5103	0.0435	0
100	0	0	0.5118	0	0
110	0	0	0.5112	0	0
120	0	0.3431	0	0	0
130	0	0.5709	0	0.2935	0.2782
140	0	0.7287	0	0.4054	0.4477
150	0.0863	1.378	0	0.5128	0.6047
160	0.3184	1.551	0	1.301	0.7618
170	1.149	2.584	0.0846	0.398	1.383
180	1.209	2.671	0	2.658	1.468
DEG	LUMINOUS INTENSITY:cd				

Zonal Lumens

τ	φ total
0-10	129.4
10-20	498.5
20-30	1056
30-40	1724
40-50	2412
50-60	3025
60-70	3482
70-80	3729
80-90	3784
90-100	3784
100-110	3785
110-120	3785
120-130	3785
130-140	3785
140-150	3786
150-160	3786
160-170	3787
170-180	3787
UNIT: lm	

Luminance cd/(m2)

G(DEG)	C0/180	C90/270
85	4497	7271
80	5915	9158
75	8087	10431
70	9427	11330
65	10340	11958
60	11033	12412
55	11548	12744
50	11979	12985
45	12309	13172

Floating Curved Troffer

Back-lit LED | CCT & Wattage Adjustable

DISTRIBUTION DIAGRAM

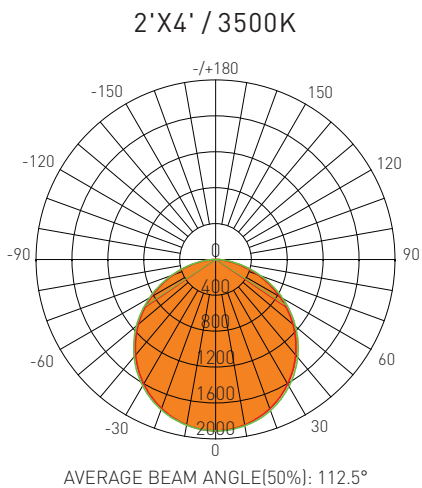

Test Number: TR24-DM-TWTS UNIT: cd
 Lumens: 5425.2 Lm — CD/180, 111.5°
 Watts: 48.74 W — C30/270, 113.6°
 LPW: 111.32 Lm/W
 CCT: 3500K

Zonal Flux Diagram

τ	C0	C45	C90	C135	C180
10	1871	1885	1882	1874	1870
20	1768	1790	1790	1772	1766
30	1605	1631	1635	1609	1603
40	1388	1414	1424	1393	1387
50	1123	1147	1161	1129	1124
60	821.0	840.5	860.8	829.1	824.3
70	500.1	515.0	538.1	508.5	504.0
80	185.1	205.2	225.2	204.5	198.1
90	0.0436	0.4280	1.015	0.3364	0
100	0	0.2581	0.7634	0	0
110	0.2049	0.3759	1.199	0.2440	0.2564
120	0.3209	0.4964	0	0.2991	0.4912
130	0.6043	0.4431	0	0.3249	0.9462
140	0.5623	0	0	0	1.032
150	0.5230	0	0	0	1.032
160	0.5951	0	0.1246	0	1.032
170	0.7622	0	0.1512	0.1108	1.032
180	0.6881	0	0.1698	0.1699	0.8602
DEG	LUMINOUS INTENSITY:cd				

Zonal Lumens

τ	φ total
0-10	180.6
10-20	697.7
20-30	1482
30-40	2429
40-50	3410
50-60	4293
60-70	4959
70-80	5333
80-90	5423
90-100	5423
100-110	5424
110-120	5424
120-130	5425
130-140	5425
140-150	5425
150-160	5425
160-170	5425
170-180	5425
	UNIT: lm

Luminance cd/(m2)

G(DEG)	C0/180	C90/270
85	7012	10530
80	10671	12962
75	13070	14547
70	14634	15729
65	15670	16562
60	16434	17211
55	17045	17696
50	17492	18060
45	17844	18351