

# ZETA 1.8"

Pendant | Architectural LED Linear



Combining superior esthetics, quality performance and unparalleled versatility, Zeta offers new opportunities to capture the beauty and benefits of true lighting.

With a maximum output of 1000 lm/ft and a choice of various lengths, Zeta is capable of delivering the light levels needed for the most demanding applications by CCT adjustable and wattage selectable functions, compatible for dry ceiling and drop ceiling.

While simple in appearance, Zeta provides wide, powerful lighting thanks to innovating line joint. Optional 42' continuous roll-out len is resulting in seamless architectural integration.

## Feature

- 3 lengths & 1.8" width
- Internal Driver
- Up to 1000 lm/ft
- Individual units or continuous runs
- Custom pattern with optional Line, L, X, T, Y, V joiners
- CCT adjustable and wattage selectable
- Dry ceiling and drop ceiling compatible

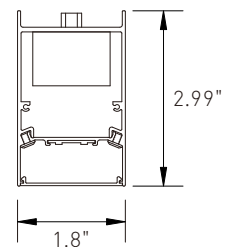

## PERFORMANCE

Finish	Lumen Package		
	High	Medium	Low
White Finish	1000lm/ft, 10w/ft	750lm/ft, 7.5w/ft	500lm/ft, 5w/ft
Black Finish	800lm/ft, 10w/ft	600lm/ft, 7.5w/ft	400lm/ft, 5w/ft

\* Please consult factory for custom lumen output and wattage. All efficacy is  $\pm 5\%$  base on different CCT. Check the IES file to gain the accurate data.

# ZETA 1.8"

Pendant | Architectural LED Linear

## STRUCTURE

### Finish

Extruded aluminum housing with powder coat white, black or custom.

### Electrical

Mini Internal LED Driver	It is powered by Class 2 high efficiency LED driver, with a standard 1-10V dimming which continuous dims to 10% that works with many types of controls. Tested Dimmers: Lutron® Diva-Dvtv, Leviton® IP-710-DL.
Wattage Adjustable	2' : 20w, 15w, 10w 4' : 40w, 30w, 20w 8' : 80w, 60w, 40w
THD	<20%
Power Factor	>0.9
Input Voltage	Standard electronic drivers are UL recognized and available for 120-277V input voltage.

### LED System

CRI	Minimum 80 color rendering index
CCT	CCT adjustable from 3000K, 3500K and 4000K with a great color consistency.
LED	Minimum 50,000h with 87.8% of lumen maintenance in 25°C ambient temperature, in compliance with IES LM-80 testing measurements.

### Approvals

- cULus listed
- Suitable for damp locations
- Designed for indoor use only
- 5 years limited warranty

### Optional Function

#### Emergency Option



Optional high voltage 8W emergency LED driver EM-H08170-LBF can be provided. When AC power fails, it immediately switches to the emergency mode, operating for lighting up to 120 minutes. When AC power is restored, it automatically returns to the charging mode which meets critical life-safety lighting requirements. For more info or spec sheet, please visit our website or contact sales.

Emergency Lumen Output:

FIXTURE EFFICACY	OUTPUT POWER 8W
100lm/w	800 Lumens
80lm/w	640 Lumens

## PRODUCT ORDERING GUIDE

### Sample

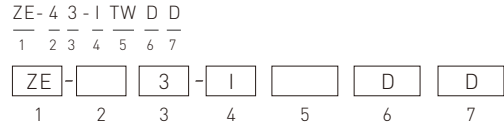

#### 1. Base Model

ZE ZETA

#### 2. Length

2F 2 feet  4F 4 feet  8F 8 feet

#### 3. Width

3 1.8inch

#### 4. Driver

I Internal

#### 5. CCT

TW CCT Selectable (3000K, 3500K, 4000K)  30 3000K \*  
 35 3500K \*  
 40 4000K \*  
 50 5000K \*

#### 6. Light Distribution

D 100% Downlight

#### 7. Optics Options

D Diffuser

## OPTIONAL ORDERING GUIDE

### Ceiling Type

- Dry Wall (Mount to J-box)
- Drop Ceiling Clips (Suitable for 9/16" and 15/16" Flat Ceiling)
- Drop Ceiling Clips (Suitable for 9/16" Slot Ceiling)
- Drop Ceiling Clips (Suitable for 15/16" Slot Ceiling) \*

### Canopy

1.6" Round  4.5" Round (Designed for power cable)

### Joiner

"-" pattern  "T" pattern \*  "X" pattern \*  
 "Y" pattern \*  "L" pattern \*  "V" pattern \*

### Optional Accessory

Rolling Diffuser (42')

### Optional Functions

LED Emergency Driver (Order Separated)

\*Additional cost and/or lead time on customized fixtures may apply. Some fixtures require an MOQ. Please contact your sales rep for more information.

# ZETA 1.8"

Pendant | Architectural LED Linear

## DIMENSIONS

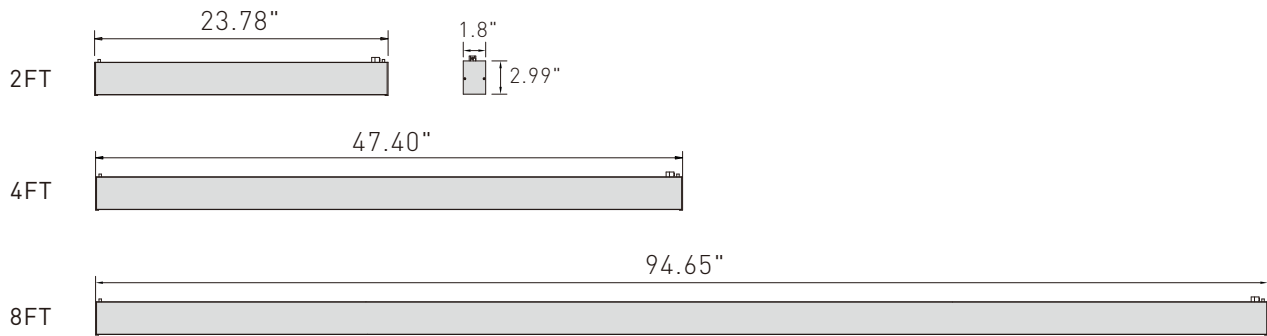

## MOUNTING

### Canopy Style

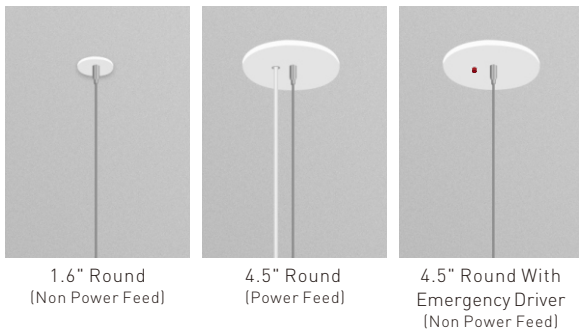

### Dry Ceiling / Off Grid

"Various Hard Ceilings"  
(Mount to J-box)

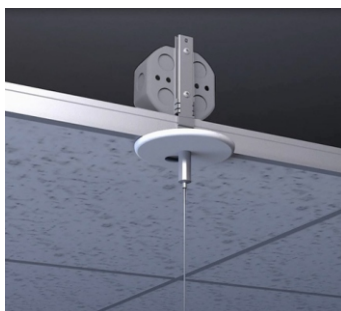
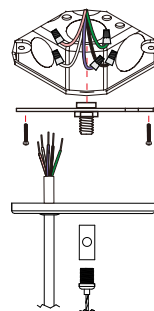
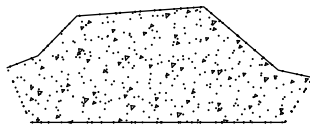

### Drop Ceiling / On Grid

Suspending the luminaire in the T-grid. Compatible for various T-grid, including 9/16" Flat, 9/16" Slot, 15/16" Flat.

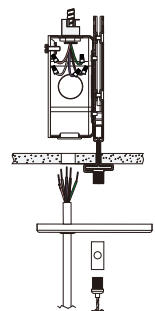
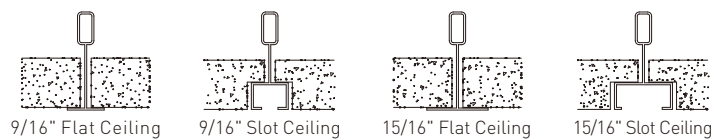

\*Please see the installation instruction for more details.

# ZETA 1.8"

Pendant | Architectural LED Linear

## Standard Line Runs In 120v

Luminaire Run Length (ft)	Run Configuration	Line Joiner	5' Power Cable	5' Aircraft Cable	Canopy
2	2'	-	1	2	2
4	4'	-	1	2	2
6	4'+2'	1	1	3	3
8	8'	-	1	2	2
10	8'+2'	1	1	3	3
12	8'+4'	1	1	3	3
14	8'+4'+2'	2	1	4	4
16	8'+8'	1	1	3	3
18	8'+8'+2'	2	1	4	4
20	8'+8'+4'	2	1	4	4
22	8'+8'+4'+2'	3	1	5	5
24	8'+8'+8'	2	1	4	4
26	8'+8'+8'+2'	3	1	5	5
28	8'+8'+8'+4'	3	1	5	5
30	8'+8'+8'+4'+2'	4	1	6	6
32	8'+8'+8'+8'	3	1	5	5
34	8'+8'+8'+8'+2'	4	1	6	6
36	8'+8'+8'+8'+4'	4	1	6	6
38	8'+8'+8'+8'+4'+2'	5	1	7	7
40	8'+8'+8'+8'+8'	4	1	6	6
42	8'+8'+8'+8'+8'+2'	5	2	7	7
44	8'+8'+8'+8'+8'+4'	5	2	7	7
46	8'+8'+8'+8'+8'+4'+2'	6	2	8	8
48	8'+8'+8'+8'+8'+8'	5	2	7	7

Note: 4.5" canopy is designed for power cable

### Individual

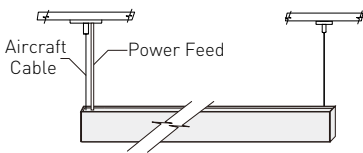

### Continuous Run

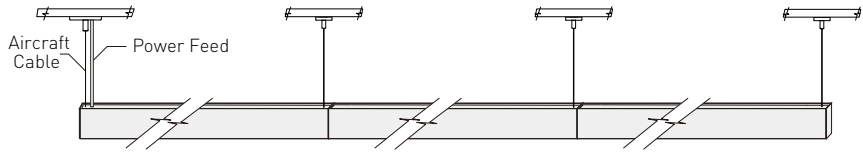

120VAC: connections up to 40ft.  
277VAC: connections up to 100ft.

### Custom Pattern With Joiners

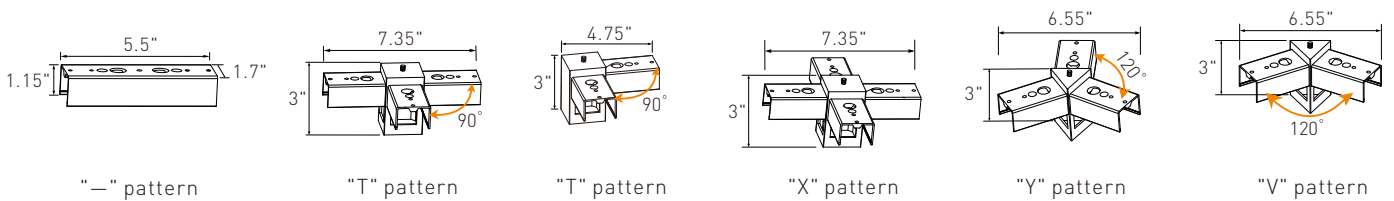

# ZETA 1.8"

Pendant | Architectural LED Linear

## DISTRIBUTION DIAGRAM

2' / 35000K

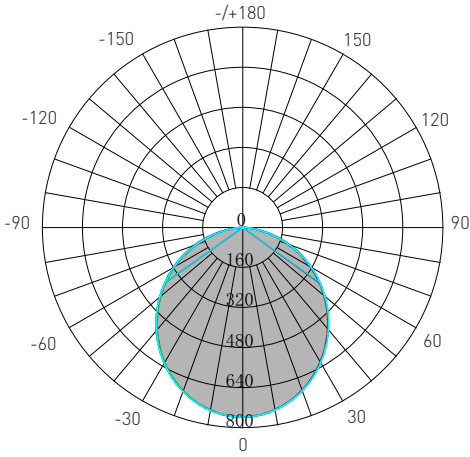

AVERAGE BEAM ANGLE(50%): 109.0°

Test Number: ZE-23-I35DD  
 Lumens: 2000 Lms  
 Watts: 20 W  
 LPW: 100 Lm/W  
 CCT: 3500K

UNIT: cd  
 — C0/180, 108.5°  
 — C30/210, 108.8°  
 — C60/240, 109.3°  
 — C90/270, 109.4°

Zonal Flux Diagram

τ	C0	C45	C90	C135	C180
10	739.5	740.0	740.4	740.3	740.8
20	692.3	693.4	694.2	693.9	694.8
30	619.7	622.1	623.3	622.5	623.5
40	527.6	530.8	533.0	531.8	532.3
50	423.2	426.7	428.9	427.3	428.1
60	309.1	312.4	314.4	313.0	314.8
70	189.2	191.3	191.3	191.4	193.9
80	72.58	73.20	72.06	72.77	77.06
90	1.497	1.349	0.1848	1.430	2.611
100	0.4056	0.3856	0.3520	0.3720	0.3790
110	0.6354	0.6424	0.6225	0.6065	0.6045
120	0.9014	0.9265	0.9156	0.8837	0.8751
130	1.163	1.204	1.209	1.159	1.132
140	1.420	1.463	1.475	1.425	1.398
150	1.646	1.682	1.687	1.650	1.628
160	1.876	1.883	1.881	1.865	1.831
170	2.047	2.011	2.011	2.002	2.002
180	2.074	2.043	2.034	2.047	2.074
DEG	LUMINOUS INTENSITY:cd				

Zonal Lumens

τ	φ total
0-10	71.48
10-20	274.9
20-30	580.0
30-40	943.0
40-50	1315
50-60	1648
60-70	1899
70-80	2039
80-90	2072
90-100	2072
100-110	2073
110-120	2073
120-130	2074
130-140	2075
140-150	2076
150-160	2077
160-170	2078
170-180	2078
UNIT: lm	

Luminance cd/(m2)

G(DEG)	C0/180	C90/270
85	10520	9762
80	14927	14821
75	17681	17948
70	19759	19980
65	21091	21333
60	22077	22459
55	22866	23212
50	23513	23832
45	24062	24363

4' / 35000K

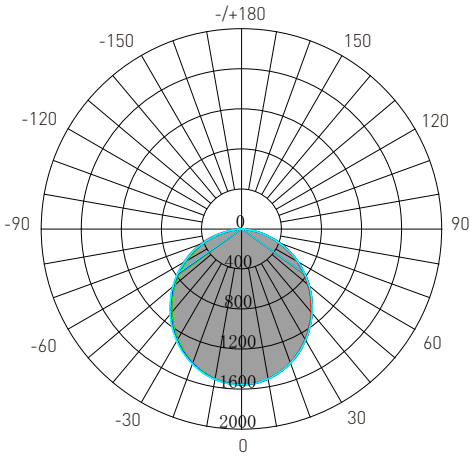

AVERAGE BEAM ANGLE(50%): 108.9°

Test Number: ZE-43-I30DD  
 Lumens: 4000 Lms  
 Watts: 40 W  
 LPW: 100 Lm/W  
 CCT: 3500K

UNIT: cd  
 — C0/180, 108.1°  
 — C30/210, 108.6°  
 — C60/240, 109.4°  
 — C90/270, 109.7°

Zonal Flux Diagram

τ	C0	C45	C90	C135	C180
10	1520	1522	1520	1517	1521
20	1423	1427	1425	1419	1425
30	1273	1282	1280	1270	1276
40	1084	1096	1095	1083	1087
50	868.6	882.1	881.8	867.5	872.7
60	632.5	646.4	646.0	632.3	639.3
70	385.5	397.9	395.6	384.0	393.6
80	145.2	152.5	146.9	140.4	151.9
90	1.792	2.172	0.3294	1.070	3.152
100	0.7296	0.7281	0.7309	0.7373	0.6906
110	1.185	1.233	1.295	1.247	1.164
120	1.731	1.799	1.894	1.813	1.692
130	2.299	2.372	2.476	2.374	2.224
140	2.813	2.908	2.999	2.897	2.751
150	3.291	3.359	3.427	3.344	3.225
160	3.810	3.756	3.788	3.743	3.689
170	4.166	4.025	4.009	4.049	4.095
180	4.230	4.101	4.081	4.101	4.230
DEG	LUMINOUS INTENSITY:cd				

Zonal Lumens

τ	φ total
0-10	146.8
10-20	564.8
20-30	1191
30-40	1937
40-50	2702
50-60	3386
60-70	3902
70-80	4187
80-90	4251
90-100	4252
100-110	4253
110-120	4254
120-130	4256
130-140	4258
140-150	4260
150-160	4262
160-170	4263
170-180	4263
UNIT: lm	

Luminance cd/(m2)

G(DEG)	C0/180	C90/270
85	9921	9804
80	14927	15104
75	18028	18499
70	20128	20653
65	21570	22064
60	22589	23072
55	23450	23860
50	24130	24496
45	24697	25038