

Rear View
Inside
Cabinet

Rear
Cover
Plate

CABINET DETAIL

Left Side
View

Right Side
View

Front View

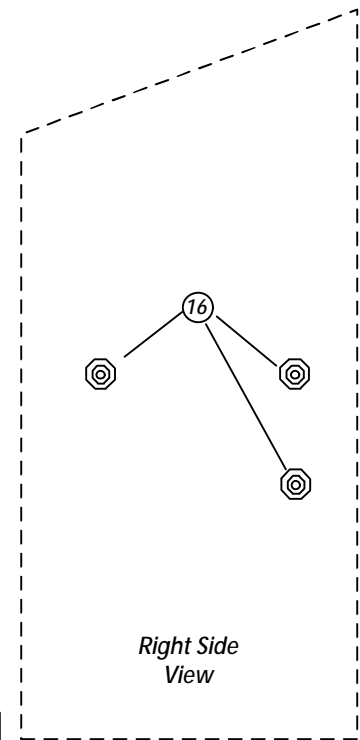
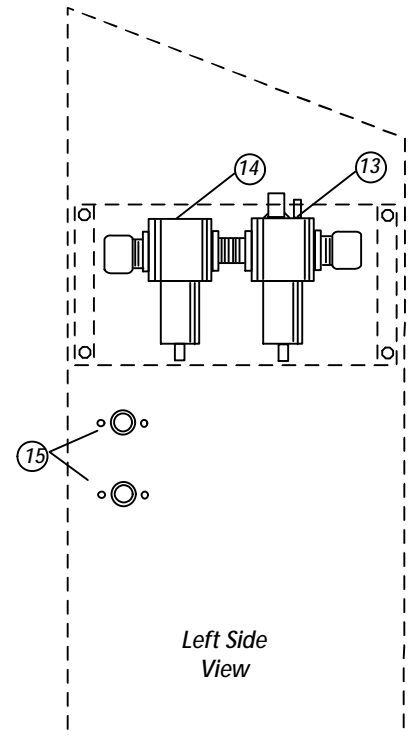
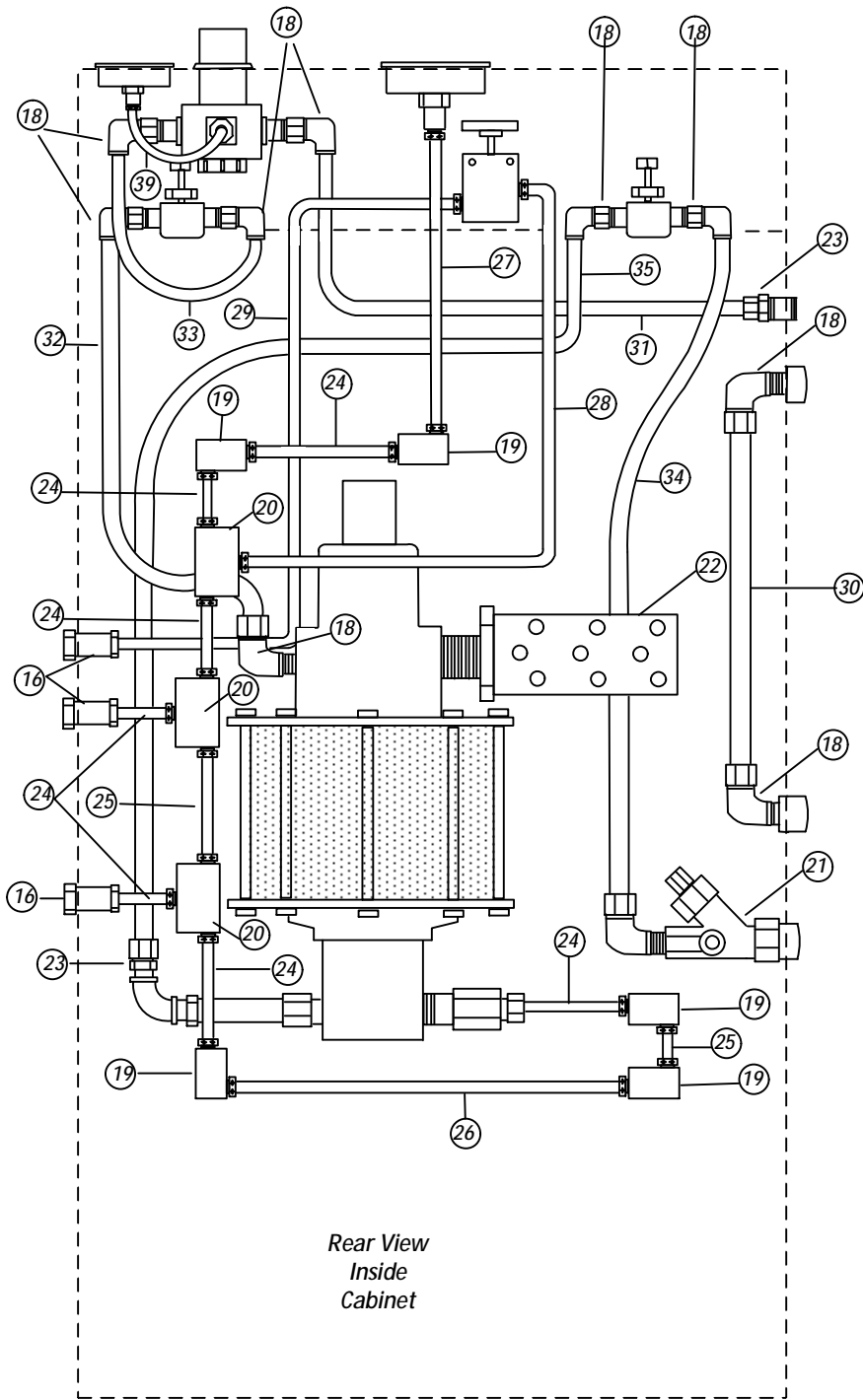

PARTS DETAIL

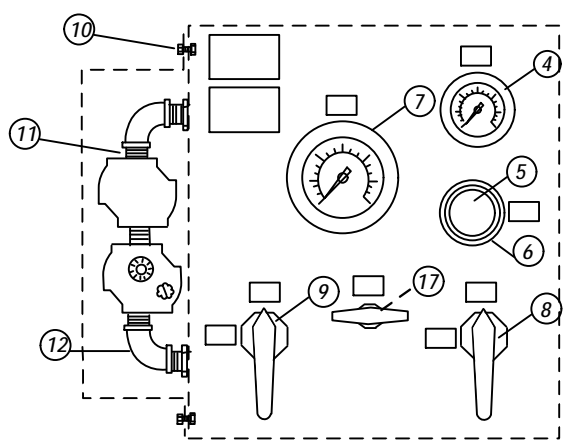

AT 25000
ATLAS SERIES

*Information is proprietary to Gulf Coast Tool and Rental
And can not be reproduced or copied without
Prior written consent.*

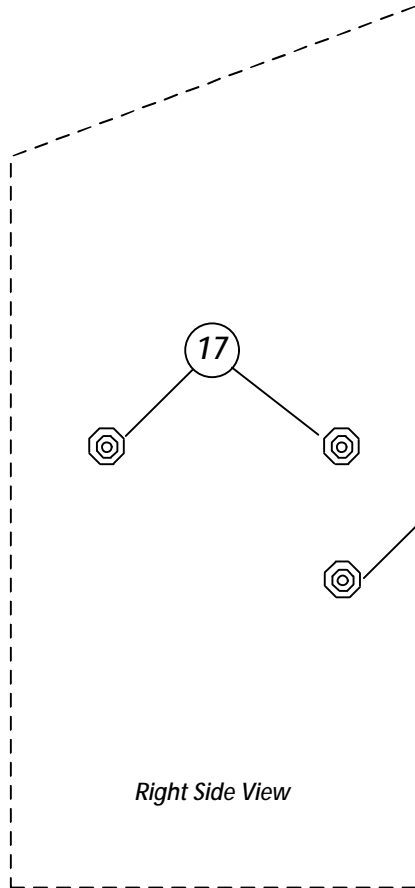

PARTS DETAIL

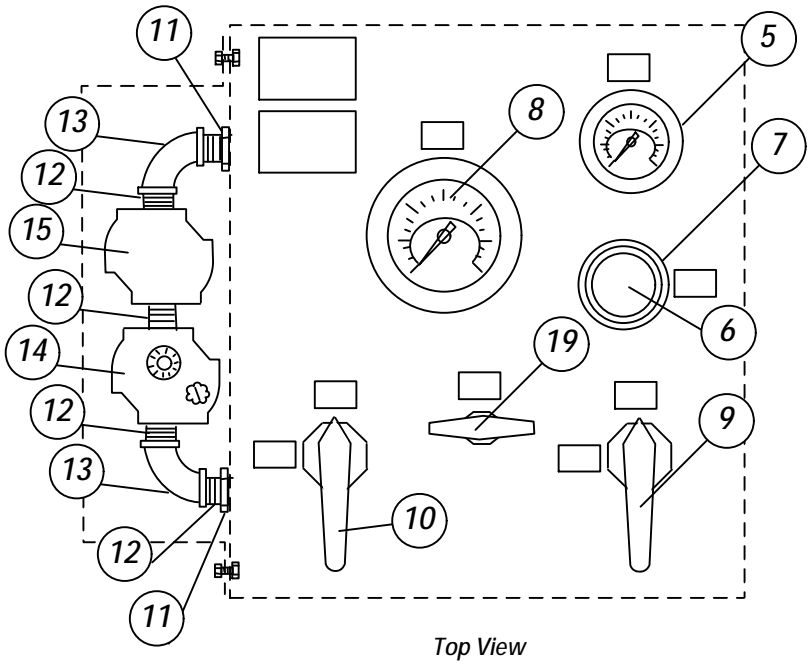
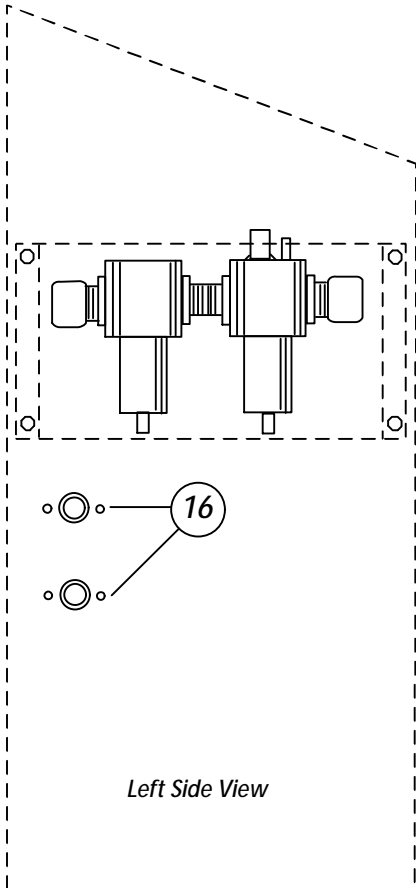

TA 10000
ATLAS Series

<i>Item #</i>	<i>Description</i>	<i>Part #</i>	<i>Qty. Req</i>
①	Back Cover	GCT-AT-250001	1
②	Console	GCT-AT-250002	1
③	Cover	GCT-AT-250003	1
④	Air Gauge 2-200 PSI	GCT-20S-160-FP-B-GF	1
⑤	Pressure Regulator Assembly	GCT-R74G-4AK-RMN	1
⑥	Panel Nut	GCT-4348-89	1
⑦	Pressure Gauge	GCT-40S-30K-FP-B-GF	1
⑧	Air Valve	GCT-B45F8	1
⑨	Water Valve	GCT-B45F8	1
⑩	Bulkhead Assembly	GCT-BBHA-8	1
⑪	Brass Nipple	GCT-BN5-1	6
⑫	Brass Elbow	GCT-BN5-E	2
⑬	Lubricator	GCT-L74C-4AP-QDN	1
⑭	Filter (Air)	GCT-F74G-4AN-QD3	1
⑮	Bulkheads Air/Water	GCT-SS-BHA-8	2
⑯	High Pressure Bulkheads ¼" HPF	GCT-60BF-4433	3
⑰	Needle Valve	GCT-30VM4081	1
⑱	Brass Tube Elbow	GCT-B-810-2-8	10
⑲	Elbow High Pressure	GCT-CL4400	5
⑳	Tee High Pressure	GCT-CT444D	3
㉑	Water Filter	GCT-1RNB4	1
㉒	Muffler	GCT-5500 A 6003	1
㉓	Brass Tube Fitting	GCT-B-810-1-8	2
㉔	High Pressure Nipple 3"	GCT-CN4403	5
㉕	High Pressure Nipple 4"	GCT-CN4404	2
㉖	High Pressure Nipple 8"	GCT-CN4408	1
㉗	High Pressure Nipple 6"	GCT-CN4406	1
㉘	High Pressure Tube Assy.	GCT-HPTA-4-NV-1	1
㉙	High Pressure Tube Assy.	GCT-HPTA-4-NV-2	1

<i>Item #</i>	<i>Description</i>	<i>Part #</i>	<i>Qty. Req</i>
③⑩	<i>Air Poly Tubing Assembly</i>	<i>GCT-PT-810-NFSET-1</i>	<i>1</i>
③①	<i>Air Poly Tubing Assembly</i>	<i>GCT-PT-810-NFSET-2</i>	<i>1</i>
③②	<i>Air Poly Tubing Assembly</i>	<i>GCT-PT-810-NFSET-3</i>	<i>1</i>
③③	<i>Air Poly Tubing Assembly</i>	<i>GCT-PT-810-NFSET-4</i>	<i>1</i>
③④	<i>Water Poly Tubing Assembly</i>	<i>GCT-PT-810-NFSET-5</i>	<i>1</i>
③⑤	<i>Water Poly Tubing Assembly</i>	<i>GCT-PT-810-NFSET-6</i>	<i>1</i>
③⑥	<i>Wheels</i>	<i>GCT-10.5-58</i>	<i>2</i>
③⑦	<i>Axle</i>	<i>GCT-58AXLE</i>	<i>1</i>
③⑧	<i>Axle Collars</i>	<i>GCT-2X569</i>	<i>2</i>
③⑨	<i>Air Gauge Poly Tubing Assembly</i>	<i>GCT-AG-PTA</i>	<i>1</i>
④⑩	<i>Handle Assembly</i>	<i>GCT-1-H</i>	<i>1</i>

NOT SHOWN:

<i>High Pressure Hose 20' ¼" HPM</i>	<i>GCT-25000-20</i>
<i>High Pressure Hose 50' ¼" HPM</i>	<i>GCT-25000-50</i>
<i>High Pressure Hose 100' ¼" HPM</i>	<i>GCT-25000-100</i>
<i>Label Kit</i>	<i>GCT-LK-25000</i>
<i>Hardware Kit</i>	<i>GCT-SSHDKIT</i>