



RAM | 2020
CRICKET



INTRODUCTION

Welcome to the 2020 RAM cricket catalogue - it's all 20-20 - the year of perfect vision!- we have the ladies 20-20 world cup in February with the men's 20-20 world cup later this year both being held in Australia. In between England tour Sri Lanka whilst we welcome the West Indies and Pakistan in the summer.

Ram cricket are delighted to supply many clubs, universities and schools with the latest technologically advanced equipment and essential items for this coming season. Personally and professionally I am pleased to be a part of the Ram family and endorse this comprehensive range.

Ram have supported cricket since 2005 and are proud of their status as the brand for grassroots cricket supplying equipment at exceptionally competitive prices to offer great value for money. They operate as a family business from a warehouse and office in Surrey with a dedicated team of devoted and enthusiastic cricket supporters.

Ram Cricket delivers a true one stop shop to save customers time and money. The team are happy to discuss requirements personally or by handling orders completed by way of the comprehensive web site <http://www.ramcricket.co.uk> join us and move forward together.

I wish you a wonderful sunny season ahead

Yours in cricket

Nasser Hussein
Non Executive Director
nasser@ramcricket.co.uk
0208 123 6812



Here are what customers are saying



Chris Finney - Junior Section Manager - Rowledge Cricket Club

“Rowledge CC are very happy with the service received from RAM over the past few years. We are always striving to source top quality kit which is competitively priced for our 30+ ECB qualified coaches. The equipment and balls from RAM allow us to provide quality training for the hundreds of boys and girls enjoying their cricket at our thriving village club. RAM has been fantastic in helping us achieve this goal.”



Hampton Hill CC - Rob Fullicks - Club Captain

“We began using Ram at the start of the 2018 season and we have been very pleased with the service received since then. We are delighted with the quality of all the clothing supplied, including our junior playing shirts and polo shirts for our Kwiks. We also purchased a large amount of training kit and casual wear, all of which the membership loved. There was a huge selection of designs and colours available which was perfect. Ram also supplied us with our new Gazebo/Marquee which we have been very pleased with and is of very good quality. All in all, we as a club are very excited to be using Ram Cricket for the coming season and hope to continue this relationship for the foreseeable future.”



Chris Adams - Head of Cricket - Seaford College

“We are delighted with the service we get from Ram Cricket. The high quality of equipment is matched by the efficiency of delivery and ever friendly customer service. A first class operation.”

Check other reviews on TRUSTPILOT



Dan Pratt - , Master i/c Cricket, Wellington College

“Wellington have used Ram Cricket for a variety of equipment over the past eight years. The quality, service and value provided by Ram Cricket and their staff has always been of the highest standard, hence why we continue to use them, year in, year out, for kit, such as training balls, coaching aids and kit bags. I couldn't recommend them more highly.”



Alison Slack - Secretary, Fishlake CC

“Ram Cricket were extremely helpful in their knowledge of what packages to buy for optimum benefit to our coaches when we required equipment to support a coaching project at our club. Ram helped us get better value out of our budget, and I would recommend their services to all clubs.”



Mark Mason - Level 3 Head Coach MCC

“My experiences of Ram Cricket have never been less than wonderful; great prices and the goods arrive almost before I've closed up my laptop! They're a lovely company with which to do business.”





County Crown

Ram Cricket's County is a superb quality match ball, designed to give outstanding performance at the highest level of play and is recommended for 50-80 overs use.

Specification:

- Solid core for shape retention
- Hand stitched
- 9 Ply super nylon thread
- Alum tanned cow hide leather
- 4 piece construction
- 5 Layer wool and cork

Size: 5.5oz

Colour: Red



Code: 3015-R-S

Sold in boxes of 6



Dukes Prince

The Dukes Prince Match ball is designed for use in top level league cricket. Suitable for matches of 45 overs and more.

Specification:

- Premium quality chrome tanned leather
- Cortex centre for excellent shape retention
- Hand stitched
- Premium anti-scurf finish

Size: 5.5oz

Colour: Red



Code: DT072

Sold in boxes of 6



ECB DIRECTIVE ON BALL SIZES

| | |
|---------------------|----------------|
| Under 7 to Under 14 | - Size 4.75 oz |
| Under 15 & above | - Size 5.5 oz |



For Ball Bundles see pages 12 & 13





5 Star

Top-grade match ball for senior and junior level matches.
Recommended for 40-60 overs use.

Specification:

- 4 layer compressed cork with rubber centre
- Hand stitched
- Alum tanned cow hide leather with wax finish
- 4 piece construction

Sizes: 5.5oz, 5oz or 4.75oz

Colours: Red, White or Pink



Code: 3020

Sold in boxes of 6



Dukes Select

The Dukes Select Match ball is ideal for use in good standard league cricket matches.
Suitable for matches of 40 overs and more.

Specification:

- Quality selected chrome tanned leather
- Cork/rubber moulded centre for shape retention
- Hand stitched
- Durable anti-scurry finish

Sizes: 5.5oz or 5oz

Colour: Red



Code: DT073

Sold in boxes of 6



For Ball Customisation see page 6





MATCH & COACHING BALLS

3 Star

Superb value match ball, perfect for use in Sunday league and school cricket. Suitable for 20-40 overs.

Specification:

- Standard cow hide leather with 4 piece construction
- 2 layer cork and wool with wooden centre
- Hand stitched
- Lacquered for durable finish

Sizes: 5.5oz, 5oz or 4.75oz

Colour: Red or Pink



Code: 3025 Red
Code: 3025-P Pink

Sold in boxes of 6



Dukes Club

Great value match ball, ideal for club or school cricket. Suitable for matches of 20 overs or more.

Specification:

- Quality Chrome tanned leather
- Cork/rubber moulded centre for shape retention
- Hand stitched
- Anti-scu^o finish

Club Sizes: 5.5oz, 5oz or 4.75oz (Called Tiger 'A')

Colours: Red, White, Pink or Orange



Code: DT074 - Dukes Club Match - Red
Code: DT074 - Dukes Club Match - White, Pink or Orange
Code: DT872 - Dukes Tiger 'A' Multi Purpose - Red
Code: DT872 - Dukes Tiger 'A' Multi Purpose - White, Pink or Orange

Sold in boxes of 6



Leather Coaching Ball

Perfect training ball for all types of coaching, including swing and spin bowling development.

Specification:

- All leather construction
- Hand stitched

Sizes: 5.5oz, 5oz or 4.75oz

Colours: Red/White



NOW AVAILABLE
IN 5OZ

Code: 3045

Sold in boxes of 6



For Ball Bundles see pages 11 & 12





Custom Cricket Balls

Have you thought about customising your club or school cricket balls? Why not try it in 2020/21? Ram Cricket make it easy and affordable...

Custom cricket balls are a popular choice for gaining added exposure for your club, school, county, league or sponsor. With the help of our in-house design service, you can create a professional-looking design in your choice of either Gold Print or Embossed finish.

- Free in-house design
- Choice of Gold Embossing or printing
- Leather Balls - Minimum 60 balls – 24 per size and type
- Coaching Balls - Minimum 120 Balls per type - 60 per size
- Supplied in boxes of 6

BEST SELLER



Custom Embossing



Custom Printing

These prices include full colour customisation on two panels:

| Code | Ball |
|------------|--|
| 3000-SU | Custom Cricket Ball Set up |
| 3015P-EXP | County Crown |
| 3020P-EXP | 5 Star |
| 3025P-EXP | 3 Star |
| 3045P-EXP | Leather Training ball |
| 3060P-EXP | Wondaball |
| 3061P-EXP | Polysoft ball |
| 3062P-EXP | Wind Ball |
| 3063P-EXP | Wind Ball - Finger |
| 3065P-EXP | Softie Ball |
| 3067P-EXP | Swing Ball |
| 3068P-EXP | Tennis Cricket Ball |
| 3195P-EXP | Cricket Ball Key Ring (120 minimum) |
| DT072P-EXP | Cricket Ball - Dukes Prince - Match |
| DT073P-EXP | Cricket Ball - Dukes Select Match |
| DT074P-EXP | Cricket Ball - Dukes Club Match |
| DT872P-EXP | Cricket Ball - Dukes Tiger 'A' - Multi Purpose |

Template Example:



Design Guide:

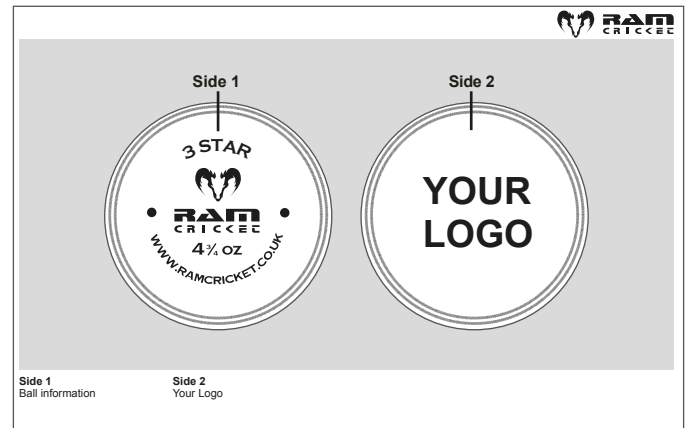

Leather Ball Colours:

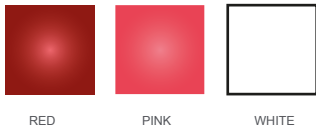

Coaching Ball Colours:

All colours are possible see our colour guide on page 93

Delivery

8 weeks from approval

Not in a hurry?

For orders over 100 balls, contact us about sea freight savings



Hand-stitched

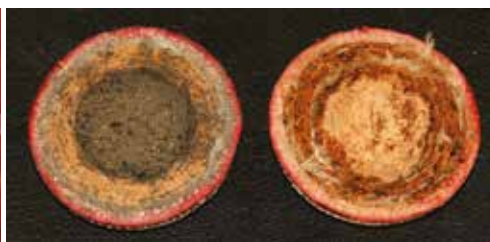

High quality internals



Quality checked at every stage of production



COACHING BALLS

Wondaball

Suitable for junior and senior practice. A must for all coaches.

Specification:

- Stitched seam
- Durable PVC outer construction
- Realistic bounce

Sizes: Senior or Junior

Colours: Red, Red/White or Pink



Code: 3060

Sold in boxes of 6

Poly Soft Ball

Confidence building, coaching training ball of a good weight.

Specification:

- Embossed Seam
- Soft Construction
- Realistic bounce

Sizes: Senior or Junior

Colour: Red



Code: 3061

Sold in boxes of 6

Wind Ball

Our most popular practice ball. Now also available with coaching finger marks

Specification:

- Embossed seam
- Soft plastic construction
- High-pressure firm bounce

Sizes: Senior or Junior

Options: Fluoro Orange
Red with Finger Markings



Code: 3062

Code: 3063

Sold in boxes of 6

Softee Ball

Mid-pressured coaching ball

Specification:

- Embossed seam
- Soft plastic construction
- Mid-pressure soft bounce

Sizes: Senior or Junior

Colour: Fluoro Yellow



Code: 3065

Sold in boxes of 6

Swing Ball

Perfect for coaching swing bowling & batting technique

Specification:

- Raised seam to aid swing grip
- Half rubber & half tennis ball
- Realistic bounce

Colours: Red/Silver



Code: 3067

Sold in boxes of 6

Tennis Cricket Ball

Ideal for coaching young kids

Specification:

- Tennis ball construction
- Inbuilt Seam
- Low bounce

Colour: Red



Code: 3068

Sold in boxes of 6



Cricket Training Ball Set

Multi Pack of 3 training balls.

Specification:

- Wind Ball
- Wondaball
- 3 Star

Sizes: Senior or Junior



Code: 3073



Cricket Skills Ball Set

Multi Pack of 3 skills coaching balls.

Specification:

- Reaction Ball
- Wind Ball
- Tennis Cricket Ball

Size: Junior



Code: 3075



Cricket Development Ball Set

Multi Pack of 3 development coaching balls.

Specification:

- Swing Ball
- Windynger Ball
- Tennis Cricket Ball

Size: Junior



Code: 3077





BALL STORAGE

Coaches Ball Bag

A storage essential for all coaches.

Specification:

- Holds up to 72 balls
- 4 internal compartments
- Strong reinforced carry handle
- Durable PVC

Size: 47cm x 33cm

Colour: Black



Code: 3092



Ball Carry Case

Store and transport up to 12 cricket balls.

Specification:

- Holds up to 12 balls
- 12 padded internal compartments
- Double zip closing
- Braided Polyester

Size: 30cm x 26cm

Colour: Black/Fluoro Yellow



Code: 3091





Breathable Ball Bag

Breathable mesh bag with carry strap for ease of storage and transport.

Specification:

- Holds up to 24 balls
- Strong reinforced carry strap
- Nylon mesh

Sizes: 39cm x 24cm

Colour: Black



Code: 3093



Ball Carry Bag

A great value storage option.

Specification:

- Holds up to 24 balls
- Single compartment
- Drawstring top and carry strap
- Durable nylon material

Sizes: 39cm x 24cm

Colour: Black



Code: 3094



Ball Crate

Recommended for carrying match balls.

Specification:

- Holds up to 12 cricket balls
- Carry handle
- Durable PVC coated wire
- Protects balls from knocking against each other

Colour: Blue



Code: 3090





BALL BUNDLES

Ram County Crown Bundle

Specification:

- 12 x County Crown Balls
- Ball Carry Case

Sizes: 5.5oz**Colours:** Red**Code:** Bundle 69

Ram 5 Star Bundle

Specification:

- 12 x 5 Star Balls
- Ball Carry Case

Sizes: 5.5oz, 5oz or 4.75oz**Colours:** Red, White or Pink**Code:** Bundle 60

Dukes Select Bundle

Specification:

- 12 x Dukes Select Balls
- Ball Carry Case

Size: 5.5oz or 5oz**Colour:** Red**Code:** Bundle 61

Ram Star Mix Bundle

Specification:

- 6 x 5 Star Balls
- 6 x 3 Star Balls
- Ball Carry Case

Size: 5.5oz, 5oz or 4.75oz**Colour:** Red or Pink**Code:** Bundle 70

Ram 3 Star Bundle

Specification:

- 24 x 3 Star Balls
- Breathable Ball Bag

Sizes: 5.5oz, 5oz or 4.75oz**Colour:** Red or Pink**Code:** Bundle 63

Dukes Club Bundle

Specification:

- 24 x Dukes club or Tiger 'A' balls
- Breathable Ball Bag

Size: 5.5oz, 5oz or 4.75oz (Called Tiger 'A')**Colour:** Red, White, Pink or Orange

| | | |
|------------------------|---------------|-----------------------|
| Code: Bundle 62 | 5.75oz or 5oz | Red |
| | 5.75oz or 5oz | White, Pink or Orange |
| | 4.75oz | Red |
| | 4.75oz | White, Pink or Orange |

Ram Leather Coaching Ball Bundle

Specification:

- 24 x Leather Coaching Balls
- Breathable Ball Bag

Sizes: 5.5oz, 5oz or 4.75oz**Colour:** Red/White**Code:** Bundle 71

Ram Wondaball Bundle

Specification:

- 24 x Wondaballs
- Breathable Ball Bag

Size: Senior or Junior**Colour:** Red, Red/White or Pink**Code:** Bundle 72

Upgrade ball bundles to custom balls
(Minimum order of 60 balls)





Ram Coaching Bundle 1

Specification:

- 12 x 3 Star Balls (Red or Pink)
- 12 x Leather Coaching Balls
- 12 x Wondaballs (Red, Red/White or Pink)
- 12 x Wind Balls (Standard or with yñger marks)
- Coaches Ball Bag

Sizes: Senior or Junior



Code: Bundle 64



Ram Coaching Bundle 2

Specification:

- 12 x Wondaballs (Red, Red/White or Pink)
- 12 x Wind Balls (Standard or with yñger marks)
- 12 x Softees
- 12 x Tennis Cricket Balls
- Coaches Ball Bag

Size: Senior or Junior



Code: Bundle 65



Ram Coaching Bundle 3

Specification:

- 12 x 5 Star Balls (Red, White or Pink)
- 18 x 3 Star Balls (Red or Pink)
- 18 x Wondaballs (Red, Red/White or Pink)
- 18 x Poly Soft Balls
- Coaches Ball Bag

Size: Senior, Ladies or Junior



Code: Bundle 73





Coaching Bat

Helps improve catching and yielding skills.

Specification:

- Double-sided coaching bat
- One side high-density foam for long-range yielding practice
- Standard bat face for slip catch practice
- Rubber chevron grip

Size: Senior

Colour: As shown



Code: 3385



Flexi Base Target Stump

Ideal for practising run-outs and yielding drills.

Specification:

- Single fluorescent stump
- Rubber base with detachable metal spike or self righting rubber base
- Strong plastic construction

Size: Senior

Colour: Yellow



Code: 3356 Detachable spike

Code: 3321-FB Self righting base



Detachable Spike

Self righting base

Pop-Up Ball Stop

Back drop catching net to reduce time having to fetch balls.

Specification:

- Lightweight & collapsible for easy transportation
- Supplied as single net with carry bag & pegs

Size: 180cm W x 110cm H

Colour: As shown



Code: 3321 - Pop-Up Ball Stop

Code: 3321-ST - Pop-Up Ball Stop with fabric stumps



*Stumps not included
- see pages 28 & 29*





Fusion Multi-Stump and Spike

Specification:

- Single uorescent stump
- Lightweight durable shaped rubber construction
- Toughened 5" detachable spike
- Multi-stump base option

Colours: Yellow stump / Black base

Code: 3353S - 3 Stumps, 3 Spikes and Base

Code: 3353 - Stump and Spike

Code: 3353B - Base



Fusion Multi-Stump - Shorty and Spike

Perfect for focussing bowlers and yelders towards the base of the stump.

Specification:

- Single uorescent shorty stump
- 14" in height
- Same exible and resilient material as the Multi-Stump

Colours: Orange stump / Black base

Code: 3354S - 3 Stumps, 3 Spikes and Base

Code: 3354 - Stump and Spike

Code: 3353B - Base



Catching Mitt

Specification:

- Baseball style mitt with large ball catching cup
- Soft & exible for ease of catching

Size: Senior or Junior

Code: 3395-RH - Right handed for left hand throwing

Code: 3395-LH - Left handed for right hand throwing



*Ball not included

Reaction Ball Set

Improves reaction times and re°exes.

Specification:

- Suitable for seniors and juniors
- Rubber construction
- Set of 4 Balls in carry bag

Size: 10cm

Colour: Red, Yellow, Blue and Green

Code: 4338





Katchet

The Katchet has become one of the leading coaching aids in the world. Used by international cricket teams - a must have for any coach.

Specification:

- Uneven surface replicates real ball deviation - increasing game performance
- Suitable for use with hard balls and soft balls
- Weatherproof and impact resistant polypropylene construction
- Snap together multiple units to increase size
- Weight - 2kg
- Supplied with carry bag



Code: 3365



 Put 4 Katchets together to make a lightweight slip catch cradle 

Katchmax

The Katchmax sits on top of your Katchet, meshing with its grooves to provide a slimline product for additional coaching options.

Specification:

- Can be combined with the Katchet to provide greater variety and challenge
- Gives coaches and players another level of deflection to improve foot movement and catching skills
- Can also be used flat on the ground for yielding, inner circle practice
- Supplied with carry bag

Code: 3367



Code: 3367

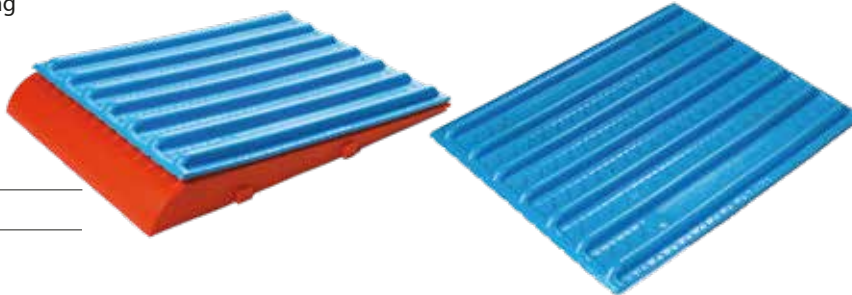

Slip Catch Cradle

The traditional slip catch cradle for all aspects of yielding.

Specification:

- Ash timber lathes
- 6 x 4ft painted steel frame
- Comes with 2 spare lathes
- Spare lathes sold individually



Code: CR.SC-1A

Code: CR.SC-2 (Spare Lathes)





Crazy Catch Range

Improve both hand-eye coordination and improve reaction times with the ultimate rebound net.

Freestyle

Specification:

- Dual Layer Net for unpredictable ball return
- One sided net with two handles for coaches to hold on to
- Ideal for indoor or outdoor use
- Easy to transport
- Includes carry bag
- 520mm(w) x 520mm(h)

Code: 3375 Standard Orange



Joe Root using the Crazy Catch Freestyle for warm up drills

Upstart 2.0

Specification:

- Smallest and most portable freestanding net
- Two sides – Sane (predictable) and Insane (unpredictable)
- Ideal for individuals or team training
- Includes level 2 vision ball and carry bag
- 740mm(w) x 740mm(h)
- ***Double Trouble Option**

Code: 3374 Standard or Double Trouble Green



Wildchild 2.0

Specification:

- Medium sized freestanding net for added rebound space
- Two sides – Sane (predictable) and Insane (unpredictable)
- Ideal for indoor or outdoor use
- Includes level 2 vision ball and carry bag
- 930mm(w) x 930mm(h)
- ***Double Trouble Option**

Code: 3373 Standard or Double Trouble Red



Professional 2.0

Specification:

- Features the largest rebound surface
- Two sides – Sane (predictable) and Insane (unpredictable)
- Great for practising longer distance throwing and catching
- Option of having horizontal or vertical frame orientation
- Ideal for group use – schools and clubs
- 1480mm(w) x 910mm(h)
- ***Double Trouble Option**

Code: 3372 Standard or Double Trouble Light Blue



***Double Trouble nets have insane rebound on both sides. One side is designed for small ball rebound (cricket, hockey, tennis) and the other side for large ball rebound (football, basketball, rugby).**

Single Rebound Net

This great value option is perfect for improving both your reaction time and hand-eye coordination.

Specification:

- Lightweight single side rebound net
- Rubber feet to reduce slipping
- 2x metal ground spikes for outdoor use
- Durable metal construction

Code: 3338 75cm x 75cm
Code: 3337 100cm x 100cm
Code: 3339 150cm x 100cm





Technique Bat

This thin bladed bat improves batting technique and develops hand-eye coordination.

Specification:

- 7cm bat face
- Kashmir Willow
- Chevron bat grip

Sizes: SH, 6 & 4



Code: 3383



Batting Tees

Perfect for developing and coaching batting skills.

Specification:

- Set of 5 - 12cm tees (supplied in carrier bag) or single - 17cm
- Indoor and outdoor use
- Soft rubber moulded construction



Code: 3381 Set of 5 - 12cm

Code: 3379 Single - 17cm

Ball not included - see page 8



Sidearm - Elite & Club

Whatever standard of cricket you play, this coaching aid will help your players become better batsmen. You can also use the Sidearm for yielding and wicket keeping drills.

Specification:

- Perfect for generating pace, bounce, swing and seam deliveries
- One person only required for all types of deliveries
- Flexible plastic construction



Code: Elite - 3334-E

Code: Club - 3334

"The Sidearm should be an indispensable part of the coach's kit bag."

Graham Gooch



Elite

Club



Cricket Batting Coaching Set

Specification:

- Technique Bat
- Batting Tee
- Wondaball
- Supplied in carry bag

Sizes: 6 & 4



Code: 3387



Metal Bowling Target

Improves and coaches bowling accuracy.

Specification:

- 35cm diameter target ring
- Drawstring ball net
- Strong metal construction

Colour: Blue



Code: 3332

Stumps not included - see pages 30 & 31



Foam Bowling Targets

Improves and coaches bowling accuracy.

Three holes in the base of target to be positioned above one, two or three stumps.

Specification:

- 23 x 23cm foam target - Standard
- 23 x 96cm foam target - Extended
- Lightweight foam construction

Colours: Black/Silver/Red



Code: 3332-F 23cm x 23cm Standard

Code: 3332-F-L 23cm x 96cm Extended

Stumps not included - see pages 30 & 31



For Coaching Aids bundles see page 20





Tactics Board

Specification:

- Cricket pitch layout
- 15 x Magnetic player counters
- Wall mountable
- Wipe clean
- 60cm x 46cm



Code: 3470

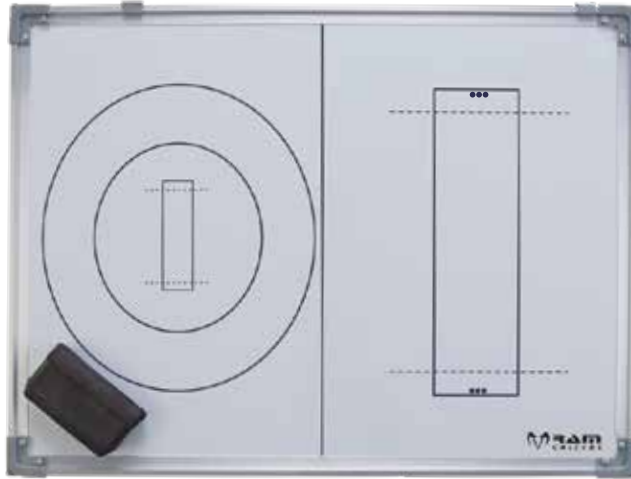

Cricket Clipboard

Specification:

- Cricket pitch layout
- Double-sided
- Wipe clean
- 25cm x 40cm



Code: 3471

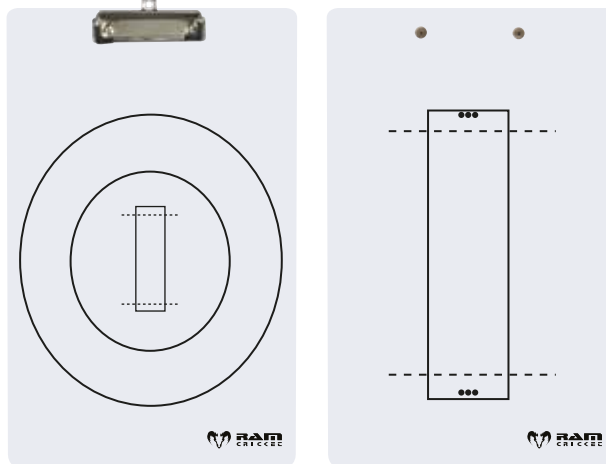

Stopwatch

Specification:

- Multi-purpose



Code: 3473



Whistles



Code: 4725 Acme Thunderer
 Code: 3475 Fox 40 Classic



Acme Thunderer

Fox 40 Classic



Batting Coaching Bundle

Specification:

- 12 x 3 Star Cricket Balls (4.75oz, 5oz or 5.5oz in Red or Pink)
- 6 x Wind Balls (Junior or Senior) (Standard or ynger)
- 1 x Breathable ball bag
- 1 x Batting Tees (Pack of 5)
- 1 x Technique Bat (SH, 6 or 4)
- 1 x Flexi Base Stumps
- 1 x Sidearm - Club



Code: Bundle 66

Fielding Coaching Bundle

Specification:

- 12 x 3 Star Cricket Balls (4.75oz, 5oz or 5.5oz in Red or Pink)
- 6 x Wind Balls (Junior or Senior) (Standard or ynger)
- 1 x Set of 4 Reaction Balls
- 1 x Breathable ball bag
- 1 x Coaching Bat
- 1 x Flexi Based Target Stump with detachable metal spike
- 1 x Catching Mitt (RH or LH in Senior or Junior)
- 1 x Grid Marker Cones - Club
- 1 x Katchet



Code: Bundle 67

Bowling Coaching Bundle

Specification:

- 6 x Leather Coaching Balls (4.75oz or 5.5oz)
- 6 x Wondaballs (Junior or Senior in Red, Red/White or Pink)
- 6 x Wind Balls (Junior or Senior) (Standard or ynger)
- 6 x Swing Balls
- 1 x Breathable ball bag
- 1 x Spring Loaded Stumps
- 1 x Foam Bowling Target
- Run Up Markers (Pair)



Code: Bundle 68



Crazy Cricket Set - Senior

- Strong plastic construction
- 2 x Softee Balls (Senior)
- 1 x Batting End Stumps set
- 1 x Bowlers Stump
- 2 x Size 6 Bat
- Supplied in Carry Bag

Size: Senior

Colours: Fluoro Yellow/Black/Red

Code: 3298-S



Crazy Cricket Set - Junior

- Strong plastic construction
- 2 x Softee Balls (Junior)
- 1 x Batting End Stumps set
- 1 x Bowlers Stump
- 1 x Size 5 Bat
- 1 x Size 3 Bat
- Supplied in Carry Bag

Size: Junior

Colours: Fluoro Yellow/Black/Red

Code: 3298-J



Crazy Cricket Set - Mini

- Plastic construction
- 1 x Softee Ball (Junior)
- 1 x Batting End Stumps set
- 1 x Bowlers Stump
- 1 x Size 2 Bat
- Supplied in Carry Bag

Size: Mini

Colours: Fluoro Yellow/Black/Red

Code: 3299-M



Crazy Cricket Set - Micro

- Plastic construction
- 1 x Softee Ball (Junior)
- 1 x Batting End Stumps set
- 1 x Bowlers Stump
- 1 x Size 0 Bat
- Supplied in Carry Bag

Size: Micro

Colours: Fluoro Yellow/Black/Red

Code: 3299-MIC



Crazy Cricket Bat & Ball Set

- Strong plastic construction
- 1 x Crazy Cricket Bat
- 1 x Softee Ball
- Supplied in drawstring bag

Size: 6,4,2,0

Colours: Fluoro Yellow/Black/Red



Code: 3297 - Size 6 or 4

Code: 3297 - Size 2 or 0



Individual Bats

- 6 sizes available

Code: 3299-6

3299-5

3299-4

3299-3

3299-2

3299-0



Size: 4,5 or 6

Size: 0,2 or 3



Batting End Stumps

- 3 x Stumps
- 1 x Base
- 2 x Bails

Code: 3298-ST



Code: 3298-ST



Bowlers Stump

- 1 x Stump
- 1 x Base

Code: 3298-BS



Code: 3298-BS



Softee Ball

- Mid-pressure soft bounce
- Embossed seam
- Soft plastic construction

Sizes: Senior or Junior

Code: 3065



Code: 3065

Sold in boxes of 6



AGILITY LADDERS & HURDLES

Agility Ladder - Tubular Rungs - Quad

Specification:

- Tubular plastic rungs
- Multiple layout options - as shown
- Velcro ends for joining ladders
- 4m x 4m ladders
- Supplied in carry bag

Colours: Red, Yellow, Green & Blue ladders



Code: FSL-QUAD

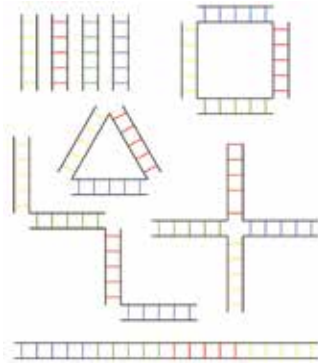

Agility Ladder - Fabric

Specification:

- Fabric covered metal rungs
- Suitable for indoor and outdoor use
- Suitable for use with studs and spikes
- Velcro ends for joining ladders
- 9m ladder
- Supplied in carry bag

Colours: Black / Red



Code: FSL-9



Agility Ladder - Hoops

Specification:

- 12 Plastic hoops with velcro fastening
- 50cm diameter hoops
- Supplied in carry bag

Colour: Yellow



Code: FSL-HOOP



Step Training Hurdles

Specification:

- Flat design to allow for compression if stepped on
- Set of 6 hurdles (same size)
- Supplied in carry bag

Colours: Yellow (15cm), Orange (23cm), Red (30cm)



Code: STH6

Yellow 15cm

Code: STH9

Orange 23cm

Code: STH12

Red 30cm





Marker Cones

- 50 per set
- Stand holder
- 5cm (h) x 19cm (dia)

Colours: Multi Colour Pack - 10 x Each of Fluoro Orange, Fluoro Yellow, White, Red & Blue



Code: 2373 Club 40gms - Multi Colour



Mini Marker Cones

- 50 per set
- Stand holder
- Webbing holder
- 3cm (h) x 12cm (dia)

Colours: Multi Colour Pack - 10 x Each of Fluoro Orange, Fluoro Yellow, White, Red & Blue



Code: 2373-M Standard 12gms - Multi Colour



Flat Markers

- 20 per set
- 5 of each colour
- Non-slip rubber
- Suitable for indoors and outdoors
- 20cm (dia) - 62 gms
- Supplied in carry bag

Colours: Yellow, Red, White & Blue



Code: 2376



Traffic Cones

- 10 per set
- 30cm (h)
- Supplied in carry bag

Colour: Red



Code: 2377-W



Pop-Up Cones

- 20 per set
- 23cm (h) x 14cm (w) - 50 gms
- Supplied in carry bag

Colour: Red



Code: 2377





WATER BOTTLES, CARRIERS & SETS

Hygienic Water Bottles

Specification:

- Ergonomically designed
- Easy squeeze
- 750ml capacity
- Chin rest
- Screw cap

Colours: Black/Silver or Clear/Silver



Code: 4709



Water Bottles

Specification:

- Ergonomically designed
- Push pull lid
- 750ml capacity
- Screw cap

Colours: Black/Silver or Clear/Silver



Code: 4710



Water Bottle Carrier Only



Code: 4714 8 Bottle Carrier (Plastic)

Code: 4715 8 Bottle Carrier (Metal)



Water Bottles & Carrier Sets

Specification:

- Robust construction
- Plastic crate - 8 bottle carrier
- Metal crate - 8 bottle carrier
- Choice of black or clear water bottles
- Customisation of bottles available for 50+ bottles



Code: 4714-SET 8 Bottles + Carrier (Plastic)

Code: 4715-SET 8 Bottles + Carrier (Metal)



Upgrade to hygienic lids



CUSTOM WATER BOTTLES



Custom Water Bottles



4711-P-SU Print Set Up Cost £25

| Code | Product | Size | 50+ | 100+ | 250+ |
|-------------|-------------------------------|--------|-----|------|------|
| 4711-1000-1 | 1 Colour Print & Water Bottle | 1000ml | - | Y | Y |
| 4711-1000-2 | 2 Colour Print & Water Bottle | 1000ml | - | - | Y |
| 4711-1000-D | Digital Print & Water Bottle | 1000ml | Y | Y | Y |
| 4711-750-1 | 1 Colour Print & Water Bottle | 750ml | - | Y | Y |
| 4711-750-2 | 2 Colour Print & Water Bottle | 750ml | - | - | Y |
| 4711-750-D | Digital Print & Water Bottle | 750ml | Y | Y | Y |
| 4711-500-1 | 1 Colour Print & Water Bottle | 500ml | - | Y | Y |
| 4711-500-2 | 2 Colour Print & Water Bottle | 500ml | - | Y | Y |
| 4711-500-D | Digital Print & Water Bottle | 500ml | Y | Y | Y |

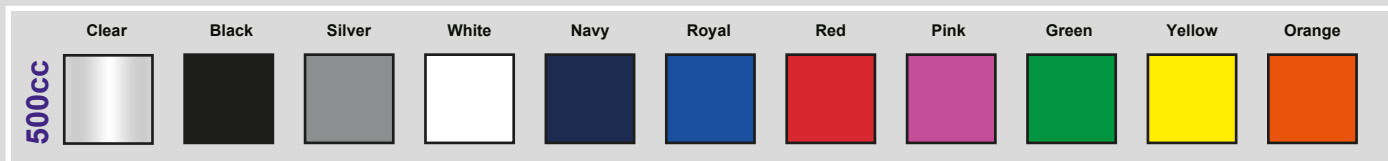
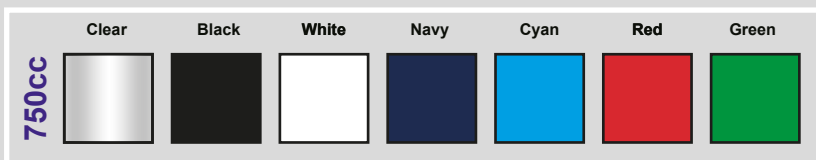

Upgrade to hygienic lids



Template Example:

Hampton Hill Cricket Club

750ml Water Bottle
4711-750-D

Specification:
- Ergonomically designed
- Push pull lid
- 750ml capacity
- Screw Cap

Bottle Colour: Black

Lid Colour: Black

Print Colours: White, 871c

Design Guide:

Logo Positions

UP - Upper Front S1UP - Upper Side 1 S2UP - Upper Side 2 UB - Upper Back

CF - Centre Front S1CF - Centre Side 1 S2CF - Centre Side 2

LF - Lower Front S1LF - Lower Side 1 S2LF - Lower Side 2



County Match Stumps

Specification:

- English Ash wood
- Includes two sets of ash bails
- Supplied with carry case with elastic holders

Size: Senior (28") or Junior (27") - 1.5" Diameter**Colour:** Natural Wood**Code:** 3426

Club Match Stumps

Specification:

- Mango bleached wood with lacquer polish
- Includes two sets of bails
- Supplied with carry bag

Sizes: Senior (28") or Junior (27") - 1.5" Diameter**Colour:** Natural Wood**Code:** 3427

Mulberry Bails

Specification:

- Heavyweight replacement bails
- Resistant to strong winds
- Set of 4 bails
- Made from Mulberry wood

Colour: Natural**Code:** 3429

Stump Gauge

Specification:

- Cast iron construction
- Facilitates perfect stump alignment
- Not suitable for indoor use

**Code:** 3435

Crease Marker

Specification:

- Accurate crease measuring product
- Folding for transporting or storage
- Powder coated steel construction
- Centre stump location hole

**Code:** 3432

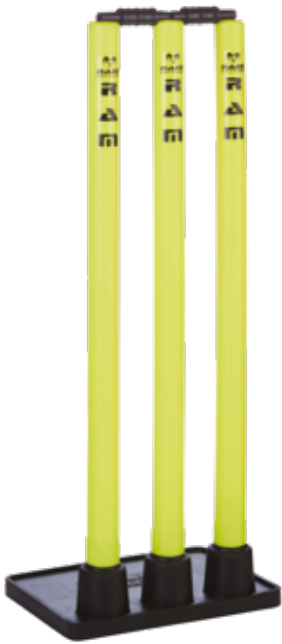

Flexi Base - Plastic

Specification:

- Durable plastic
- Heavy flexi base
- Two bails included
- Not suitable for leather ball

Sizes: Senior (28")
Junior (27")

Colour: Fluoro Yellow



Code: 3410



Flexi Base

Specification:

- Mango Wood
- Heavy flexi base
- Two bails included

Sizes: Senior (28")
Junior (27")

Colour: Natural Wood



Code: 3410-W

**JUNIOR
NOW
AVAILABLE**



Spring Loaded

Specification:

- Mango wood
- Heavy metal base
- Durable springs
- Ideal for heavy duty use
- Two bails included

Sizes: Senior (28")
Junior (27")

Colour: Natural Wood



Code: 3412

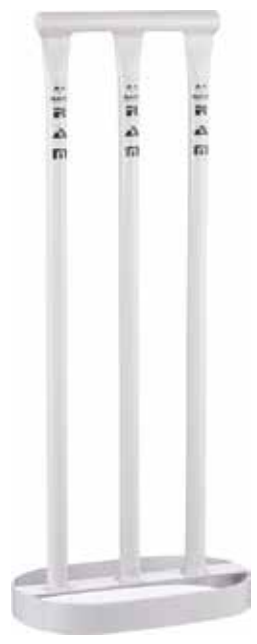

Metal

Specification:

- Metal with attached bails
- Ideal for heavy prolonged use
- Suitable for all ages
- Weight 2.5kg

Sizes: Senior (28")
Junior (27")

Colour: White



Code: 3414

Customisation Details

Ram Stumps can be customised with either durable stickers or laser engraving - displaying your logo and/or text.



Laser Engraving (Wooden stumps only)

Code: 3426-SU Set up charge

Code: 3426-ENG Per 6 stumps Delivery - 14 weeks

Stickers

Code: 3426-CUST Per 72 stump stickers

Stickers to be applied to stumps by customer
Delivery - 6 weeks



Indoor Stumps

Specification:

- PVC spring-loaded stumps
- Weighted base
- Bails are tied on for quick replacement

Size: Senior (28")

Colour: Yellow



Code: 3413

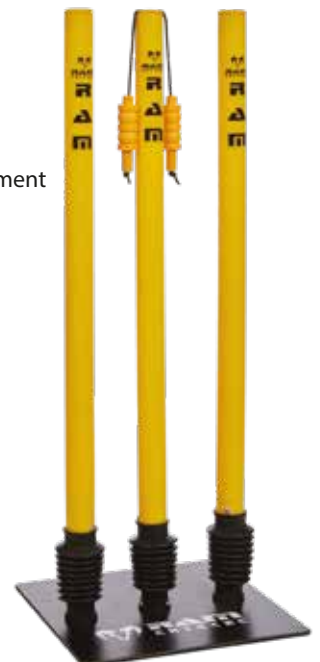



BOWLING MACHINES

Continual development and reynement over a quarter of a century have made the BOLA Cricket Bowling Machine an indispensable coaching tool. Used by thousands of schools, clubs & counties, BOLA machines are an a° ordable yrst class practice facility. All BOLA machines are manufactured in the UK.

Professional Bowling Machine - 2019 Model

Specification:

- Brushless Electric Motor - lighter, longer lasting with decreased maintenance and better performance
- Speed - 15 mph to 95 mph
- Bias & Swing - 1 to 9 levels with colour settings
- Pro-model only - Electronic random delivery mode
 - Various automatic changes to the delivery
- Ball Joint Mounting - Inñnite amount of line and length variations
- Delivery types - Straight, Outswing, Inswing, O° Break, Leg Break, Top Spin, Back Spin & Random delivery



Code: 3310 Pro Bowling Machine

Code: 3310-PP Pro Bowling Machine + Power Pack



Junior Bowling Machine

Specification:

- Brushless Electric Motor - lighter, longer lasting with decreased maintenance and better performance
- Speed - up to 65 mph
- Two ball throwing wheels for realistic bounce and swing
- Easy to carry and set up, so can be operational in a few minutes
- Selectable Electronic Random Mode will provide variation of speed (which varies length) at random



Code: 3310-J Junior Bowling Machine

*Includes auto feeder, battery and charger



Accessories

BOLA - Balls

- Code:** 3316-R Red (5oz)
 3316-Y Yellow (5oz)
 3317-O Orange (3oz)
 3316-J Orange (Junior)

Per dozen



28 Ball Automatic Feeder

Code: 3311



Power Pack

Code: 3310PACK



Column Stand

Code: 3314



Stand on Wheels

Code: 3318



Code: 3312 12v Battery

Code: 3313 12v Battery-Charger



The Paceman – Pro X2

The Paceman Pro X2 has what you need to take your game to the next level. The Paceman Pro X2 offers high quality bowling simulation for all levels.

Specification:

- Solid metal construction with an upgrade Titan 1/2 HP heavy duty DC motor
- Variable bowling pace with top speeds over 110kph (Light Ball)
- Integrated fine tuning length adjustment system allows for simplified, minor adjustments to angle and pitch
- Includes automatic 12 ball feeder
- Easy to assemble, put away and store
- Able to produce inswing, outswing, no spin and leg spin deliveries
- Can be used with all Paceman balls
- Maintenance free concave moulded TPR wheel
- Suitable for Club or Home use
- Mains powered

Code: C-PPROX2



The Paceman - S2 Original

The second generation Paceman offers quality, accurate, reliable bowling simulation for the backyard cricketer and beyond.

Specification:

- Integrated 3G (3rd Generation) Paceman Drive System with Titan 1/4 HP AC motor
- Upgraded rubber guarded protected housing
- Variable bowling speeds up to 90kph
- Fully adjustable for full pitch and short pitch deliveries
- Includes automatic 12 ball feeder
- Able to produce inswing and outswing deliveries
- Easy to assemble, put away and store
- Can be used with Paceman Light and Performance Light balls
- Suitable for Club or Home use
- Mains powered

Code: C-PBM-S2



Paceman - Bowling Machine Balls

Code: C-REG – Regular – Performance and feel of a regulation cricket ball. Suitable for use with Pro machines.

C-PLB – Light – Performance without the risk of a heavier ball. Suitable for use with all machines.

C-PLB6 – Mixed – Includes 2 x Junior, 2 x Light and 2 x Performance Light Balls. Suitable for use with all machines.



C-REG (per dozen)
C-PLB (per dozen)
C-PLB6 (per 6)





BATTING CAGES & WICKETS

County Batting Cage



The County Batting Cage is a robust, portable option for batting and bowling practice.

Specification:

- 3m H x 3.6m W x 7.6m D
- Galvanised box section steel frame - 10-year steel guarantee
- 6 x Swivel wheels for ease of use
- Supplied with one-piece 1.8mm or 3mm thick polypropylene netting
- **Velcro netting at the back for wicket keeper to use**
- Easily moved by two adults

Colour: Galvanised frame with black netting

Code: CR-NET-COUNTY-6WH

Delivery and installation £150 UK Mainland



Concertina Batting Cage



The unique Concertina Batting Cage has been designed for use in facilities where space is limited.

Specification:

- 2.9m High
- Galvanised steel finish frame
- Extendable to 8m, 10m or 12m
- 10 x (8m) / 12 x (10m) / 14 x (12m) Plastic wheels
- Fix to a wall or fence - or support post can be provided
- Supplied with one-piece 2.3mm thick knotless polypropylene net
- Simple to operate by two adults

Colour: Galvanised frame (as standard)

Also available (at extra cost): Powder Coated Black / Green / Red

Code: CON-8-290 8m x 2.9m

Code: CON-10-290 10m x 2.9m

Code: CON-12-290 12m x 2.9m

Code: CON-PO Support posts and Crossrail
Delivery
Delivery & Assembly



2G Flick Match Wickets



The Flick 2G wicket range is constructed from an easy roll soft pitch tile system, making them ideal for play on a multitude of surfaces at clubs and schools.

Specification:

- All green traditional design
- Constructed from 2G Flick Pitch tiles
- Consistent ball bounce
- Impressive seam and spin performance
- Improved traction when wet
- Suitable for indoor and outdoor use

**FREE TROLLEY
WITH EACH FULL
MATCH WICKET**

Code: F2G710 Extra Length 22.12m x 1.8m

Code: F2G711 Match Pitch 20.12m x 1.8m

Code: F2G712 Colts Match 18.12m x 1.8m

Code: F2G713 Junior Match 16.12m x 1.8m

Code: F2G714 Batting End 10m x 1.8m

Code: F2G715 Junior Batting End 7.5m x 1.6m





Premier Portable Cricket Cage - 2 wheel

- Available in galvanised steel or aluminium
- Detachable front lifting handle also prevents unauthorised play
- Surround and roof netting joined for ease of installation and safety

Specification:

- 3.2m H x 3.6m W x 7.2m D
- 50mm diameter uprights and topods in either steel or aluminium
- Heavy duty 60mm steel jxing joints
- Diagonal steel supports for added stablilty
- Supplied complete with 2mm thick black polypropylene netting
- Two cellular jxed rear wheels
- Complete with 4 "U" Peg and anchors
- Can easily be moved by two adults

Colour: Black Netting



Code: CRK -150 Galvanised Steel - 199 kg

Code: CRK - 155 Aluminium - 114 kg

Code: CRK - 152 Replacement Net

Prices include delivery to UK Mainland



Premier Portable Cricket Cage - 6 wheel

Specification:

- As per above



Code: CRK -151 Galvanised Steel - 215 kg

Code: CRK - 156 Aluminium - 130 kg

Code: CRK - 152 Replacement Net

Prices include delivery to UK Mainland



Home Ground Batting Cage

Specification:

- 2.5m H x 3m W x 5m D
- Galvanised steel uprights and topods
- Provides a spacious and secure batting environment
- Ideally used with the Paceman Bowling machines (See Page 33)
- Supplied complete with black UV treated netting
- Partial closing front to stop the struck balls exiting the net
- Includes removeable wheels for easy transport

Colour: Black Netting



Code: C-HG-FS5 Galvanised Steel - 39 kg



Portable nets are ideal for use with our Bowling Machines see pages 29-30





SIGHT SCREENS

Professional Revolving Black & White Sight Screen

A high-quality sight screen which is easily converted to black or white by one person. An easy solution for clubs and schools who play both red and white ball cricket.

Specification:

- Rotatable black/white screen
- Fully galvanised frame
- Extremely thick and reinforced UPVC lattes
- Galvanised steel wheels
- 10-year structural guarantee

Size: 4.1m (h) x 8m (w) or 4.1m (h) x 4m (w)

Colour: Black/White - Powder Coated Option Available



Code: 3483-8 4.1m x 8m

Code: 3483-4 4.1m x 4m

Delivery and installation - POA

Poly - Sight Screen

This low maintenance screen is weather resistant and gives a professional look, enhancing your pitch.

Specification:

- Heavy duty galvanised steel for extra stability (powder coating in white option available)
- 15 x UPVC slats
- 4 x solid wheels
- Easy to assemble and dismantle for convenient storage

Size: 4.5m (h) x 4.25m (w)

Colour: White



Code: 3482

Delivery & installation £150 UK Mainland

Timber - Sight Screen

Timber sight screen for a traditional look and feel.

Specification:

- Hit and miss style European softwood slats
- 300mm diameter galvanised steel wheels and stub axles
- Sturdy timber braces

Colours: Matt White or Duck Egg Blue



Code: CR/SS-1 3.66m(h) x 4.27m(w)

Code: CR/SS-2 3.66m(h) x 3.66m(w)

Code: CR/SS-3 3m(h) x 4.27m(w)

Code: CR/SS-5 3m(h) x 3.66m(w)

Code: CR/SS-4 3m(h) x 3m(w)

Delivery and installation - POA





Mobile Rain Covers

Specification:

- Frame - Galvanised steel for maximum strength
- 3 Units for storage and mobility - each unit 7.3m x 4m or 8m x 4m
- Covers - PVC UV Stabilised with overlaps between the units
- Wheels - 4 Wheels per section, 2 swivel and 2 fixed
- Gutters - Integral with excellent drainage system of hoses
- Hoses - 75m of hosing included for drainage
- Optional side sheets and bowlers run up sheets - see below
- Assembly - The covers will be assembled on site

Colours: White, Blue, Red, Green



| | | |
|--------------------------|------|-------------------------------------|
| Code: CR/WC-D | 7.3m | |
| Code: CR/WC-D2 | 8m | |
| Code: CR/WC-AT | | (Sheets attachment kit) |
| Code: CR/WC-D-SS | | (2 x 25m x 4m Side Sheets) |
| Code: CR/WC-D-BRS | | (2 x 9m x 4m Bowlers run-up Sheets) |

Customisation Detail



- Customise your mobile cricket covers with logos and colours
- Wide range of printing colour options on white covers
- Decals can be designed and applied to coloured tops
- Great for sponsors or benefactors
- Please enquire for assistance and prices

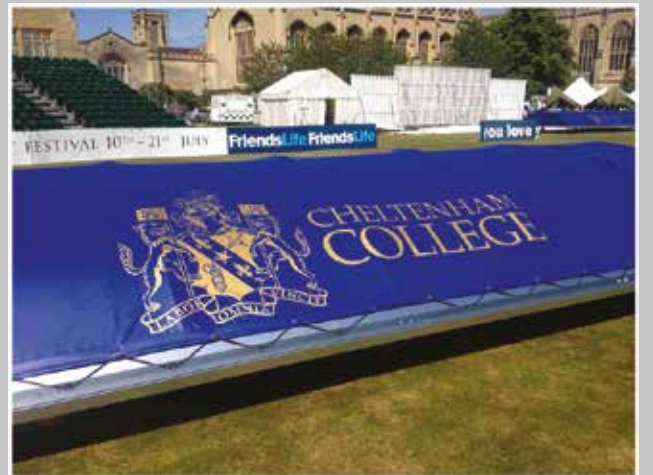

County Wicket Protector Flat Sheet

Specification:

- Lightweight 250gsm material
- Reinforced hems and eyelets (take out for easy durable pegging)
- Grab handles every 1.5m
- Pegs available as optional extra

Colour: White



| | |
|------------------------------|------------------------|
| Code: 3493 - 25m x 4m | - 40x Pegs recommended |
| Code: 3494 - 25m x 6m | - 42x Pegs recommended |
| Code: 3495 - 25m x 8m | - 45x Pegs recommended |
| Code: 3496 - Pegs | - per peg |





SCORE BOXES & NUMBERS

Electronic LED Scoreboxes

Specification:

- Focal point of any club or school ground for spectators
- Fully customisable LED scoreboards
- All environments, grounds & budgets catered for
- Choose from mobile to permanent structures
- Optional laptop style scorers control box for remote use

Colour: Black



Prices subject to designs and required features



Sit In Cricket Scoreboxes

Specification:

- Manufactured in attractive timber with telegraph numbers
- Beautiful presentation with double scorers window
- Hand operated
- Box size : 336cm (w) x 274cm (h) x 173cm (d)
- Optional wheels for re-positioning available

Colour: Black



Code: CR/SB-SEP/C - Ply

Code: CR/SB-SEC/C - Cedar wood



Remote Control Number Indicators

Specification:

- Manufactured from black coated mild steel
- Hand operation by nylon cord - with operator indicator
- Box size : 29cm (w) x 36cm (h)

Colour: Black



Code: CR/MS-1 (0-9 Set)



Telegraph Number Plates

Specification:

- Numbers on black anti-glare plates
- Complete with fixing brackets
- U rings and windclip
- Number plates: 23cm (w) x 30.5cm (h)

Colours: Matt Black/White



Code: CR/TN-2 (0-9 Set)





Standard Scoreboard

Specification:

- Made from birch faced exterior plywood painted matt black
- Complete with telegraph numbers with vinyl lettering - 23cm digits
- Weight - 42kg
- 137cm (w) x 152cm (h)



Code: CR/SF-S

Code: CR/SF-S/ST - Legs



Folding Scoreboard

Sturdy timber scoreboard designed to be folded for storage or transportation.

Specification:

- Made from birch faced exterior plywood painted matt black
- Complete with telegraph numbers with vinyl lettering - 23cm Digits
- Weight - 12kg
- 94cm (w) x 96cm (h)



Code: CR/SF-PS

Code: CR/SF-PS/ST - Stand



Portable Scoreboard

Ideal for Schools or small pitches.

Specification:

- 20cm digits
- Weight - 7kg
- 130cm (w) x 45cm (h)
- Supplied in carry case



Code: 3457



Portable Cricket Scorer

Specification:

- Lightweight aluminium frame
- Black numbers on turning rings
- Stabilising leg
- 80cm (w) x 85cm (h) x 10cm (d)



Code: 3458

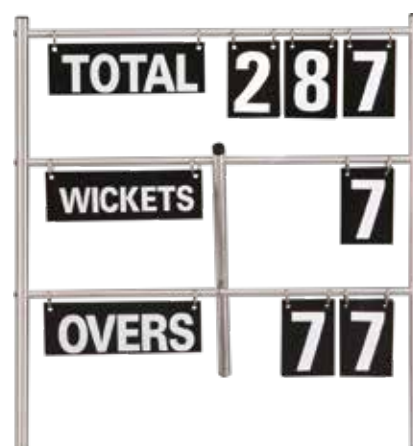



BOUNDARY MARKING

Boundary Rope

Specification:

- White polypropylene construction
- Supplied in coils of 220m lengths with sealed ends
- Choice of 3 different diameters

Colour: White

| | |
|-----------------------|--------------------|
| Code: CR/BR-20 | 20mm Diameter Rope |
| Code: CR/BR-24 | 24mm Diameter Rope |
| Code: CR/BR-28 | 28mm Diameter Rope |



Boundary Rope - Trolley

Specification:

- Holds 2 x 220m long ropes up to 28mm diameter
- Heavy-duty galvanised steel
- Large, strong winding wheels



Code: CR/BR-T



Boundary Flags

Durable set of flags to be placed around the boundary of a cricket pitch.

Specification:

- White moulded polypropylene flags
- 21.5cm x 28cm (21cm out of ground)
- Pack of 20 in bag

Colour: White



Code: 3466



Fielding Disc Markers

Specification:

- White moulded polypropylene discs
- Marks out the inner circles for league cricket
- 21.5cm diameter
- Pack of 20 in bag

Colour: White



Code: 3465



Run-Up Markers

Allows bowlers to accurately mark out their run up.

Specification:

- 63mm diameter disc with small spike
- Strong plastic construction
- Sold in pairs

Colour: White



Code: 3463 (Per Pair)



Bowdry MK III

Designed specifically to efficiently and effectively remove standing water from pitches, outfield and covers.

Specification:

- Light, strong and cost-effective solution to prevent cancellation of games
- 4 wheel chassis that evenly distributes the weight
- All steel chromed handle
- Collects up to 60 litres of water per minute
- Delivered ready for use and easy to store and transport



Code: 3442

Bowdry - Spare Sponge

Code: 3442-S



Fleet Lionel 7.5cm (3") - Line Marker

Specification:

- 18 Litre paint tank
- 7.5cm marking wheel
- Unique curved tank for cleaning
- Adjustable handlebars



Code: LIONFINP0201



Pitchmarker C White

Specification:

- 10 Litre drums
- Low cost, ideal for large areas
- Wheel to wheel or spray application
- Dilute up to 4:1 dilution rate
- Approximate coverage - 4 pitches

Code: PMCZ0010WHI





BALL STOP NETS

Cricket Throw Down Net

A quick and easy net system which one person can set up in minutes for cricket pre-match warm-up practice or many different coaching drills.

Specification:

- 11m Long x 2m High
- 2 x Octagonal wooden cricket poles with notch at the top & metal spike at the bottom
- Complete with guy lines, hardwood runners and metal pegs
- Netting is 50mm square mesh x 2mm thick black knotted polypropylene

Weight: 9kg

Code: CR/NT-TD11



Cricket Ball-Stop Kit

- Semi-permanent netting to stop balls being lost
- Ideal for protecting the cricket square

Specification:

- 1m x 50m strong durable netting
- 14 x push in, metal pigtail posts

Colour: Black Netting

Code: 3440



Perimeter Pole System

Specification:

- Poles are 7.4m with 6.4m above ground
- Made from 3mm thick polyester powder coated green steel
- Comes with 15m haulage rope, eye and cleat

Colour: Powder Coated Green



Code: FBL-101 - Poles (40kg per one piece upright)

Code: FBL-100 - Pole socket

Code: CRK-110 - Black netting 2mm per sqm





Flags and Poles

Classic and contemporary flags for clubs and schools.

Specification:

- Sublimated print
- Finished ready to fly
- High-quality flag fabric

Colours: Any



Please contact us with your requirement



Feather & Lollipop Flags

Ideal outdoor promotional tool.

Specification:

- 4.2m high flag
- Carbon pole that slots together
- Sublimated dye flags that give great print qualities

Colours: Any



Code: 4464 - Lollipop Flag inc. pole (full colour print)

Code: 4465 - Feather Flag inc. pole (full colour print)

Code: 4466 - Hard ground base for flags



Lollipop Flags



Feather Flags



Flag Customisation

Print set-up and all colour printing is included in our flag pricing. Fully customise your flag in your club or school colours with logos and print.

Please note that only one sided prints are included in the pricing, second sides are charged at an extra cost.

Delivery

3 weeks from approval





CROSSFIRE - BAT, PADS, GLOVES

The Crossfire range has been specifically developed by Ram for the club cricketer. The collection offers the individual cricketer a high performance product at a great price.

Crossfire Bat

Specification:

- Grade 3 English Willow
- Handle - Singapore cane
- Bow - Mid-blade
- Strike Zone Mid-blade sweet spot
- Grip - Octopus
- Weight - 2lb 8oz to 2lb 12oz

Size: SH

Colours: Red/Black



Code: 3125-SH

Crossfire Batting Pads

Specification:

- Ambidextrous
- Lightweight high-density foam padding with PU facing
- Reinforced pro-tex knee cap for better fit and protection
- Three section shin bolster
- Reinforced instep

Size: Senior

Colours: White/Red/Black



Code: 3205-S

Crossfire Batting Gloves

Specification:

- Armour solid protection for lead fingers
- Flexible sheep leather palm gives a superior grip
- Air flow gusset for ventilation

Size: Senior

Options: Left or Right handed

Colours: White/Red/Black



Code: 3235-S





Classically designed collection with a traditional look focusing on high level performance and style - for a great level of impact resistance.

Challenger Bat

Specification:

- Grade 1 Kashmir Willow
- Handle - Spring cane
- Bow - Bowed blade
- Strike Zone - Mid-blade sweet spot
- Weight - 2lb 8oz to 2lb 12oz
- Grip - Aqua

Size: H / 6 / 5 / 4 / 3

Colours: White/Blue/Lime



Code: 3135



Challenger Batting Pads

Specification:

- Ambidextrous
- High-density foam with a traditional PU face
- Dual wing design
- Large, breathable, padded shin foam bolsters
- 2" ankle centre straps for perfect fit

Sizes: Y / J / SMJ

Colours: White/Blue/Lime



Code: 3215



Challenger Batting Gloves

Specification:

- Two-piece thumb for better movement
- High-density foam padding for protection
- Natural cow hide leather with air cow gusset

Size: Y / J / SMJ

Options: Left or Right handed

Colours: White/Blue/Lime



Code: 3245



For Sizing Guides see page 45





PROTECTIVE WEAR & GRIPS

Ram Thigh Guard Shorts

Specification:

- Integral padded support shorts
- Ambidextrous design
- Cotton Lycra

Sizes: S / Y / J

Colour: White

Code: 3243



Ram Arm Guard

Specification:

- Lightweight high-density foam padding with PU face
- Ambidextrous design
- Elasticated and Velcro straps

Sizes: S / Y / J

Colour: White/Blue/Lime

Code: 3231



Ram Abdo Guard

Specification:

- Tested for maximum protection
- Ergonomically designed for assured fit
- Impact absorbent padding

Sizes: S / Y / J

Colour: White

Code: 3272



Bat Grips

- Finest rubber compound
- Choice of different textures and colours
- Pack of 5



Code: 3182-SC - Scale - Orange/Black

Code: 3182-AQ - Aqua - Blue/Lime

Code: 3182-OC - Octopus - Red/Black

Code: 3182-CH - Chevron - Black/Red



Re-Gripping Cone

- Wood & metal construction



Code: 3192

£





Protec Cricket Helmet

Specification:

- Improved for 2018
- British Standard approved - ICC international standard
- Match quality slimline shell with reinforced peak
- Adjustable steel grille for protection and high levels of visibility
- Black adjustable strap with chin piece
- Classic hole style venting
- Supplied in grey cloth bag

Sizes: Senior (57cm - 60cm)

Junior (54cm - 57cm)

*Helmets are measured around the fullest part of your head, slightly above the eyebrows and ears.



Colour: Black

Code: 3291



Ram Wicket Keeping Gloves

Specification:

- Ultra-supple aniline leather construction with full leather internal lining
- Octopus suction grip palm provide increased catching traction
- Large web, high-density foam cuff and backing
- Finger reinforcement, turned thumb to help natural catching

Sizes: S / Y / J / SMJ

Colour: Black/Red

+ Inners

Colour: White



Code: 3266

Code: 3268

Ram Wicket Keeping Pads

Specification:

- Lightweight EVA moulded padding with
- PU face Triple padded foam bolsters
- Wide comfortable straps for secure fit

Sizes: S / Y / J / SMJ

Colour: White/Black/Red

Code: 3263





Cricket Players Bundle - Club

- 1 x Club Bat
- 1 x Club Gloves
- 1 x Club Pads
- Supplied in Du_e Bag

Sizes: Junior - Size 5 Bat & Junior Pads & Gloves
Mini - Size 3 Bat & Small Junior Pads & Gloves

Colours: As shown



Code: 3293



Cricket Players Bundle - Challenger

- 1 x Challenger Bat
- 1 x Challenger Gloves
- 1 x Challenger Pads
- Supplied in Du_e Bag

Sizes: Senior - Size SH Bat & Senior Pads & Gloves
Youth - Size 6 Bat & Youth Pads & Gloves

Colours: As shown



Code: 3294



Cricket Bat, Pads & Gloves Sizing Guide

Bat Measuring Guide

| Height | Bat Size |
|--------------|-------------------|
| Up to 4' | 0 |
| 4' to 4'3" | 1 |
| 4'3" to 4'6" | 2 |
| 4'6" to 4'9" | 3 |
| 4'9" to 5' | 4 |
| 5' to 5'3" | 5 |
| 5'3" to 5'5" | 6 |
| 5'5" to 5'8" | Harrow (H) |
| 5'8" to 6' | Short Handle (SH) |

Pads Measuring Guide

| Shin | RAM Pad Size |
|--------|--------------|
| 30.5cm | ExSMJ |
| 33cm | SMALL JNR |
| 35.5cm | JUNIOR |
| 38cm | YOUTH |
| 43.5cm | SENIOR |

*Pads are measured from the knee roll to the top of the foot

Batting Gloves Measuring Guide

| Hand | RAM Glove Size |
|--------|----------------|
| 14.5cm | ExSMJ |
| 16.5cm | SMALL JNR |
| 18cm | JUNIOR |
| 19cm | YOUTH |
| 20.5cm | SENIOR |

*Gloves are measured from start of the wrist to the tip of your middle finger in a straight line

Wicket Keeping Gloves Measuring Guide

| Hand | RAM Glove Size |
|--------|----------------|
| 17cm | SMALL JNR |
| 19.5cm | JUNIOR |
| 20.5cm | YOUTH |
| 21.5cm | SENIOR |

*Gloves are measured from start of the wrist to the tip of your middle finger in a straight line



TEAM KIT BUNDLES



CHALLENGER

Bat :

- Grade 1 Kashmir Willow
- 3 Spring cane handle
- Bowed blade
- Strike Zone - Mid-blade sweet spot
- Weight - 2lb 8oz to 2lb 12oz
- Grip - Aqua

Pads:

- Traditional front with PU face
- Dual wing design with high-density foam
- Ambidextrous
- Large vertical foam bolsters with breathable mesh
- 2" ankle and centre straps for perfect fit
- Padded shin bolster

Gloves:

- Multi-section lightweight design
- High-density foam padding protection
- Natural cow hide Indian Pittard leather
- Airflow gusset
- Two-piece thumb

| | Senior (15+) | Youth (Age 11-14yrs) | |
|-----------------------|------------------|---------------------------|---|
| Bats | 2x SH, 1x H | 2x H, 1x 6 | KEY SH = Short Handle Bat H = Harrow Bat RH = Right Hand LH = Left Hand S = Senior Y = Youth J = Junior SMJ = Small Junior ExSMJ = Extra Small Junior |
| Pads | 3x S | 1x S, 2x Y | |
| Gloves | 3x S-RH, 1x S-LH | 1x S-RH, 2x Y-RH, 1x Y-LH | |
| Thigh Guards | 3x S | 1x S, 2x Y | |
| Helmets | 2x S | 2x S | |
| Abdo Guards | 3x S | 3x Y | |
| Wicket Keeping Gloves | 1x S | 1x Y | |
| Wicket Keeping Pads | 1x S | 1x Y | |
| Chamois Inners | 1x S | 1x Y | |
| Team Kit Bag | 1 | 1 | |



Code: 3810-S
Code: 3810-Y



For Sizing Guides see page 45





CLUB

Bat :

- Grade 2 Kashmir Willow
- 3 Spring cane handle
- Natural bowed blade
- Strike Zone - Powerful sweet spot
- Grip - Scale

Pads:

- Traditional front with PU face
- Dual wing design with high-density foam
- Ambidextrous
- Large vertical foam bolsters with breathable mesh
- 2" ankle and centre straps for perfect fit
- Padded shin bolster

Gloves:

- Multi-section lightweight design
- High-density foam jilling protection
- Natural cow hide palm
- Airflow gusset & toweling

| | Senior (15+) | Youth (Age 11-14yrs) | Junior (Age 9-11yrs) | Mini (Age 6-9yrs) |
|-----------------------|------------------|---------------------------|-----------------------------|-------------------------------------|
| Bats | 2x SH, 1x H | 2x H, 1x 6 | 2x 5, 1x 4 | 2x 3, 1x 2 |
| Pads | 3x S | 1x S, 2x Y | 2x J, 1x SMJ | 2x SMJ, 1x ExSMJ |
| Gloves | 3x S-RH, 1x S-LH | 1x S-RH, 2x Y-RH, 1x Y-LH | 2x J-RH, 1x J-LH, 1x SMJ-RH | 2x SMJ-RH, 1x ExSMJ-RH, 1x ExSMJ-LH |
| Thigh Guards | 3x S | 1x S, 2x Y | 2x J, 1x SMJ | 3x SMJ |
| Helmets | 2x S | 2x S | 2x J | - |
| Abdo Guards | 3x S | 3x Y | 3x J | - |
| Wicket Keeping Gloves | 1x S | 1x Y | 1x J | 1x SMJ |
| Wicket Keeping Pads | 1x S | 1x Y | 1x J | 1x SMJ |
| Chamois Inners | 1x S | 1x Y | 1x J | 1x SMJ |
| Team Kit Bag | 1 | 1 | 1 | 1 |



Code: 3820-S
Code: 3820-Y
Code: 3820-J
Code: 3820-M



For Sizing Guides see page 45





PLAYERS BAGS

Pro Players Kit Bag

Specification:

- Cordura material
- Y2K-Nylon Grade 8 Zips
- Suitcase style opening for easy storage
- Padded bat compartment for 2 bats
- Reinforced tractor wheels
- Retractable trolley handle

Size: 95cm (l) x 45cm (w) x 50cm (h)

Colours: Black/Red/Grey

Code: 4650-C-P



Club Players Bag

NEW

Specification:

- Cordura material
- Y2K-Nylon Grade 8 Zips
- Classic style with external bat slip pocket
- Reinforced tractor wheels

Sizes: Large - 90cm (l) x 40cm (w) x 35cm (h)

Medium - 75cm (l) x 40cm (w) x 30cm (h)

Colours: Black/Fluoro Yellow/Silver

Code: 4650-C-C Large

Code: 4650-C-C-J Medium





Duffle Bag

Specification:

- Cordura material
- Y2K-Nylon Grade 8 Zips
- Padded shoulder straps
- Huge vertical storage space
- Top helmet pocket
- Cricket bat pocket
- Bottom shoe pocket
- Two side pockets

Sizes: Large - 98cm (h) x 47cm (w) x 23cm (d)
 Medium - 92cm (h) x 38cm (w) x 18cm (d)

Colours: Black/Fluoro Yellow/Silver

Code: 4658-C Large
Code: 4658-C-J Medium



BEST SELLER



Backpack

Specification:

- Cordura material with bottle holder
- Quality zips
- Padded shoulder straps

Sizes: Senior - 44 x 33 x 22 cm
 Junior - 39 x 26 x 17 cm

Colours: Black/Red

Code: 4651-S Senior
Code: 4651-J Junior



Boot Bag

Specification:

- Matty material
- Two separate boot compartments

Size: 36cm x 14cm x 15cm
Colours: Black/Silver

Code: 2086



Draw String Bag

Specification:

- Nylon material
- Zipped front pocket

Size: 46cm x 38cm
Colours: Black/Red

Code: 4654





TEAM KIT BAG & BAG CUSTOMISATION

Team Kit Bag - Pro

Specification:

- Cordura material
- Suitcase style opening for easy storage
- Reinforced tractor wheels
- Reinforced bottom for strength
- Retractable trolley handle

Size: 107cm (l) x 45cm (w) x 44cm (h)

Colours: Black/Red

Code: 4655-C



Team Kit Bag - Premier

Specification:

- Waterproof PVC
- Strong webbing straps
- End pocket

Size: 82cm x 35cm x 35cm

Colour: Red

Code: 4652



Bag Customisation

We can customise your bags for Club, School or tour needs. This applies to all bags on pages 86 & 88. Any number of logos, names, initials and numbers can be added

- Minimum order 20 bags
- RAM branded Grey webbing as standard

| Colour | Cordura | Matty | Nylon | Nylon - Ripstop | Piping | Zips | Webbing |
|---------------|---------|-------|-------|-----------------|--------|------|---------|
| Black | ● | ● | ● | ● | ● | ● | ● |
| Charcoal | ● | ● | | | | | |
| Grey | ● | ● | | ● | ● | ● | ● |
| White | ○ | ○ | ○ | | ○ | ○ | ○ |
| Navy | ● | ● | ● | ● | ● | ● | ● |
| Royal | ● | ● | | | ● | ● | ● |
| Petrol | ● | | | | | | |
| Cyan | ● | ● | | | ● | ● | ● |
| Purple | ● | ● | | ● | | | |
| Orange | ● | ● | | | ● | ● | ● |
| Gold | | ● | | ● | | ● | ● |
| Sunbrust | ● | ● | | | ● | ● | ● |
| Maroon | ● | ● | | | | ● | ● |
| Red | ● | ● | ● | ● | ● | ● | ● |
| Hot Pink | ● | ● | | | ● | ● | ● |
| Khakhi | | ● | | ● | | | |
| Electric Lime | ● | | | | | ● | ● |
| Brown | ● | ● | ● | | | ● | ● |
| Fluoro Orange | ● | | | | | ● | ● |

| Code | Bag | Price |
|-------------------|--|--------|
| 4650-P-SU | Custom Bags - Set Up Cost | £25.00 |
| Decoration | | |
| 4650-C | Custom Bag Printing - Logo | £2.50 |
| 4650-C-IN | Custom Bag Printing - Initials / Numbers | £2.50 |
| 4650-C-E | Custom Bag Embroidery - Logo | £3.00 |
| 4650-C-E-IN | Custom Bag Embroidery - Initials / Numbers | £2.50 |

Template Example:

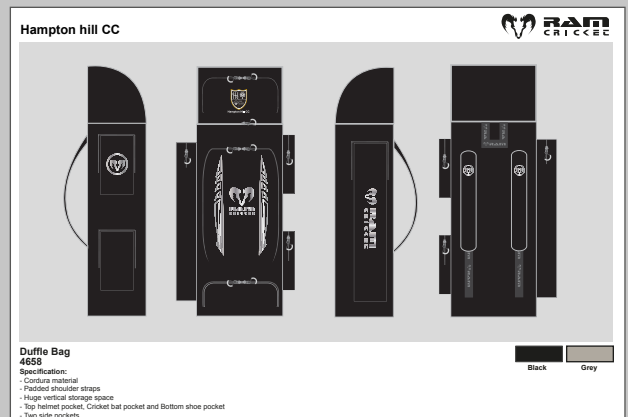

Delivery

14 weeks from approval
 Ask for Airfreight pricing for 8 week delivery



Umpire Jacket

Specification:

- 100% Polyester
- Full length zip
- Elasticated cuffs

Sizes: S - 36", M - 38", L - 40", XL - 42"

Colour: White



Code: 3460-J



Umpire Set

Specification:

- Umpire counter
- Set of bails
- Ball gauge
- Stump & Bail gauge
- Bat gauge
- Supplied in zipped carry case



Code: 3260-S



Umpire Counter

Specification:

- 3 Dial read-out
- Red dial - number of overs from 0-99
- Yellow dial - number of balls in the over
- Plastic construction

Colour: White



Code: 3460-C



Scorebook

Specification:

- Classic clear design
- 120 innings

Colour: White



Code: 3459-120





RAM
CRICKET

Catalyst Sports Asia Pte Ltd

65 9723 1255
info@catalyst-sport.com

www.catalyst-sport.com

HELP
PRICING
DELIVERY

For further details please contact our sales team.

