

## The Large Size

100x300cm - 120x360cm - 160x320cm

# Kalesinterflex







# Index

## İçindekiler

- 1. Kalesinterflex**
- 08 **1.1 Kalesinterflex | Redefines Spaces**  
*Mekanları Baştan Yaratan Buluş, Kalesinterflex*
- 10 **1.2 Care For Your World**  
*İyi Bak Dünyana*
- 12 **1.3 Sustainability**  
*Sürdürülebilirlik*
- 14 **1.4 History of Kale**  
*Kale'nin Tarihçesi*
- 16 **1.5 Human Factor**  
*İnsan Faktörü*
- 18 **1.6 Kalesinterflex Superior Technologies**  
*Kalesinterflex Üstün Yüzey Teknolojileri*
- 2. Spaces**
- Alanlar*
- 26 **2.1 Bathroom**  
*Banyo*
- 30 **2.2 Kitchen**  
*Mutfak*
- 32 **2.3 Interior**  
*İç Mekan*
- 36 **2.4 Exterior**  
*Dış Mekan*
- 3. Collections**
- Koleksiyonlar*
- 40 **3.1 Marble Look**  
*Mermer Görünüm*
- 66 **3.2 Stone Look**  
*Doğaltaş Görünüm*
- 86 **3.3 Cement Look**  
*Çimento Görünüm*
- 98 **3.4 Metal Look**  
*Metal Görünüm*
- 106 **3.5 Artwall**  
*Artwall*
- 116 **3.6 Solid Colors**  
*Düz Renkler*
- 128 **3.7 Wood Look**  
*Ahşap Görünüm*
- 4. Technical Specifications**
- Teknik Özellikler*
- 137 **4.1 Sizes & Thicknesses**  
*Ebatlar & Kalınlıklar*
- 138 **4.2 Features**  
*Özellikler*
- 140 **4.3 Kaleguard**
- 142 **4.4 Kaleguard Defence**
- 144 **4.5 Services**  
*Hizmetler*
- 146 **4.6 Size Table**  
*Ebat Tablosu*
- 154 **4.7 Technical Specifications**  
*Teknik Özellikler*
- 160 **4.8 Packaging and Shipping Details**  
*Paketleme ve Gönderim Detayları*



**The first and only  
largest porcelain  
slabs produced  
in Turkey:  
Kalesinterflex**

*Türkiye'de üretilen  
ilk ve tek en büyük  
porselen plaka:  
Kalesinterflex*

The Large Size  
**160x  
320**  
cm

6mm / 12mm / 20mm





There is a place where imaginations  
run with a boundless energy.

Art and science together as one.

Where impossible is an illusion.  
A figment. A fiction.

We know this place because we live  
and breathe ceramics of  
incomparable beauty and quality.

Here we see homes as they  
were meant to be.

No dream too great.  
No vision too stunning.

It's what's possible when everything  
you do rests on deeply held principles.

Technology that inspires with its fusion  
of innovation, form, function and performance  
in ways that are deeply enduring.

Design that is deeply authentic, breathing  
life into every dream, every vision and that brings  
new meaning to the spaces in which we live.

A resolve to make sustainability a way of life  
as much as it is a way of doing business.  
Caring for the future by caring for the world.

It's what happens when you reimagine  
what the ultimate covering material could be.

It's what happens when you reimagine possible.

■ Kalesinterflex

*Hayat, hayal edince güzel.  
Yaşam alanlarınıza nasıl yeni anlamlar kazandırabiliriz?*

*Dünyayı düşünerek başlayalım mı mesela?*

*Sürdürülebilir bir ürün düşünün...  
Evinizin her yerinde.  
İlham veren.*

*Ama aynı zamanda ekonomik çözümler de üreten.*

*Sadece çevre dostu değil, sizin de dostunuz.  
İşlevsellik ve estetik arasında benzersiz bir denge sunan  
bir ürün.*

*Hiç aklınıza gelmeyecek bambaşka yerlerde karşınıza  
çıktığını düşünün.  
Her seferinde şaşırtıyor.  
Heyecanlandırıyor.*

*Yenilikçi teknolojisiyle, hayata, dünyaya ve insana değer  
katıyor.*

*Şimdi gözlerinizi kapatın.  
Dünyayı değiştiren bu yenilikle hayalinizdeki mekanı  
tasarladığınızı düşünün.  
Rafine bir zevkle.  
İncelikle. Zarafetle.*

*Ve gözlerinizi dünyaya yeniden açın.*

*Hayal ettiğiniz ne varsa,  
hayat bulmuş bir şekilde karşınızda.*

*Biz Kalesinterflex'i üretirken hep daha güzelini hayal ettik.  
Çünkü hayat, hayal edince güzel.*

■ Kalesinterflex



## **Kalesinterflex. Redefines Spaces**

Life has value in places.

That's why every place has a memory.  
Kalesinterflex is designed to give spaces soul  
and accompany our lives.

Each experience and emotion, deserve an  
exquisite and subtle companionship.  
To create new memories by adapting  
to modern aesthetics in micro world  
that we designed.

There is a revolutionary brand that brings  
innovation, aesthetics, and performance  
together in the background of our lives.

■ Kalesinterflex

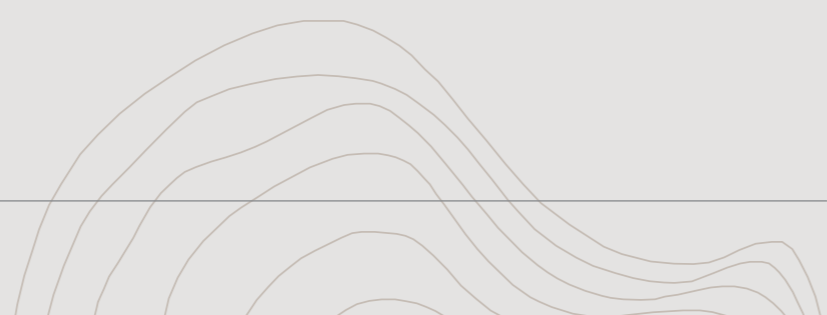

## **Kalesinterflex. Mekanları baştan yaratan buluş.**

*Hayatı, mekânlar anlamlandırır.*

*Bu yüzden her mekanın bir hafızası var.  
Meknlara ruhunu veren Kalesinterflex ise  
hayatlarımıza eşlik etmek için.*

*Her deneyim, her duygu; zarif ve incelikli bir  
yoldaşlığı hak eder.*

*Tasarladığımız mikro dünyalardaki modern  
estetik anlayışına uyum sağlayarak yeni anılar  
yaratmak için...*

*Hayatımızın fonunda inovasyonu, estetiği,  
performansı bir araya getiren  
devrimsel bir marka var.*

■ Kalesinterflex





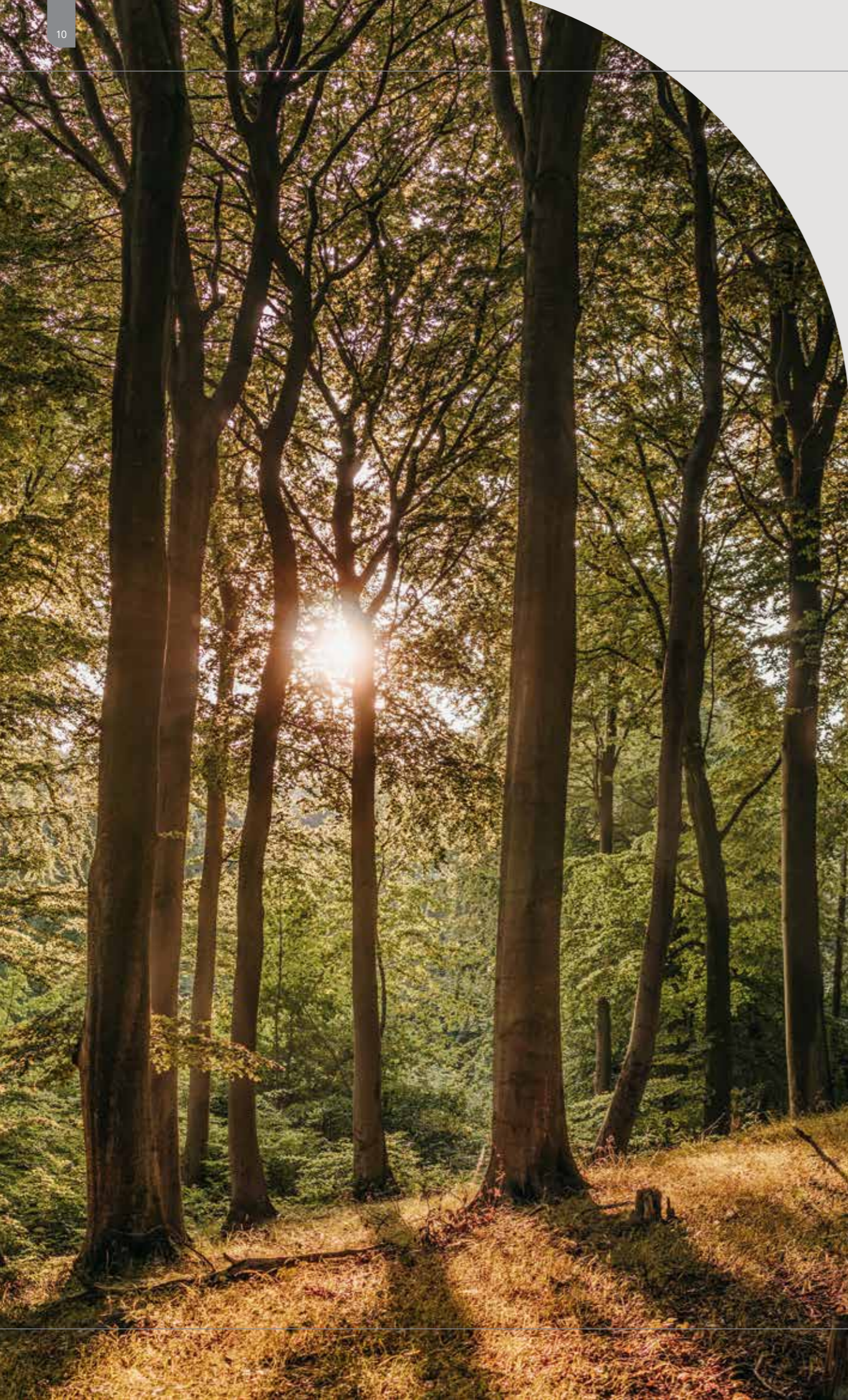

If you can say "what a relief!" as you step in your home...  
 If you can see more than four-walls while "inside" ...  
 If you can reflect your own colors, own delights as you wish...  
 If you can host your dreams as much as your friends for dinner...  
 If you can raise a flower, a child, or a hope within the peace of your home...  
 Then, your home becomes your world,  
 and the world is your home!

And us,

With our design-oriented durable products, with our not only inspirational but also sustainable and economical solutions, with our unique balance between the functionality and esthetics, we are ready to reflect your imagination and style to every corner of your home; to take good care of your home, your world, and you.

## **"Kale** **#CareForYourWorld**

*Eve adınızı attığınız anda "dünya varmış" diyebiliyorsanız eğer...  
 Dört duvardan fazlasını görüyorsanız "içeride" ...  
 Kendi renklerinizi, kendi zevklerinizi yansıtabiliyorsanız gönlünüzce...  
 Dostlarınız kadar düşlerinizi ağırlayabiliyorsanız sofralarınızda...  
 Bir çiçeği, bir çocuğu ya da belki bir ümidi yeşertebiliyorsanız evinizin huzurunda...  
 İşte o zaman, eviniz sizin dünyanız,  
 dünya sizin eviniz!  
 Ve biz,*

*Tasarımı odağa alan dayanıklı ürünlerimiz, ilham verici olduğu kadar sürdürülebilir ve tasarruflu çözümlerimiz, fonksiyonellik ve estetik arasında kurduğumuz eşsiz denge ile hayallerinizi ve tarzınızı yuvanızın her köşesine yansıtabilmek;  
 evinize, dünyanıza ve size iyi bakmak için hazırız.*

## **"Kale** **#İyiBak Dünyana**



# Sustainability

## Sürdürülebilirlik

Nature. The place where it all begins. Self-existent, life-giving, color-producing, uniquely shaping.

The inventor of imagination, the owner of creativity, our ultimate inspirer.

We strive We are working to be a consistent part of this part of this miracle that can exist without human beings.

We aim to protect its delicate balance, respect its resources, and adapt to its ecosystem.

It is in our nature to be inspired by nature.

### Raw Material Consumption: Compared to standard ceramic tiles,

*Ham madde Tüketimi:  
Standart seramik karolarla  
karşılaştırıldığında,*

**57% less**  
*daha az*

### Water Consumption: Compared to standard ceramic tiles,

*Su Tüketimi:  
Standart seramik karolarla  
karşılaştırıldığında,*

**20% less**  
*daha az*

*Doğa. Her şeyin başladığı yer.  
Kendi kendini var etme gücüne sahip, hayat  
veren, renklendiren, şekillendiren...*

*Hayalgücünün mucidi, yaratıcılığın sahibi, ilham  
vericimiz.*

*İnsandan bağımsız var olabilen bu mucizenin,  
dengeli bir parçası olabilmek için çalışıyoruz.*

*Hedefimiz hassas dengesini korumak,  
kaynaklarına saygı duymak ve ekosistemine  
uyumlanmak.*

*Doğadan ilham alarak üretmek doğamızda var.*

### Natural Gas Consumption: Compared to standard ceramic tiles,

*Doğal Gaz Tüketimi:  
Standart seramik karolarla  
karşılaştırıldığında,*

**47% less**  
*daha az*

### Logistics: Compared to standard ceramic tiles,

*Lojistik:  
Standart seramik karolarla  
karşılaştırıldığında bir konternerde,*

**90% more**  
*daha fazla*

**products can be transported in a container.**  
*ürün taşınabilirliği sağlıyoruz.*





# History

## Tarihçe

The Kale Group, whose foundations were set by Dr. (h.c.) İbrahim Bodur's Çanakkale Seramik Fabrikaları A.Ş. in 1957, began its industrial journey with the production of ceramics and then expanded into the construction chemicals, logistics, and aviation industries. Today, over 5,000 employees, the Kale Group is spread throughout Türkiye, with Çanakkale as its primary location. Kaleseramik, which pioneered the establishment of the ceramic industry in Türkiye, is a value produced in these lands. Our philosophy is to invest where we earn.

Çanakkale Seramik Fabrikaları A.Ş., Türkiye's first ceramic tile manufacturer, was founded in 1957, and Kalebodur Seramik Sanayi A.Ş., Türkiye's first floor-tile manufacturer, was founded in 1972.

While Çanakkale Seramik set the standards for quality in wall tiles, Kalebodur started a new era in the sector as a generic brand. Çanakkale Seramik Fabrikaları A.Ş. and Kalebodur Seramik Sanayi A.Ş. merged under a single roof in 2000, under the name "Kaleseramik Çanakkale Kalebodur Seramik Sanayi A.Ş.". Kaleseramik, which continues its production under the Çanakkale Seramik and Kalebodur brands, is the world's largest ceramic company, with its production capacity in a single area.

Kalesinterflex porcelain slab was developed in 2005 with the expertise of Kaleseramik, which is the first largest ceramic producer in Türkiye and one of the biggest in the world, respectively carries porcelain slab to new usage areas with its large sizes, thin form, light structure, and environmentally-friendly production technology.

*Dr. (h.c.) İbrahim Bodur tarafından 1957 yılında kurulan Çanakkale Seramik Fabrikaları A.Ş. ile temelleri atılan Kale Grubu, seramik üretimi ile başladığı sanayi yolculuğunda zamanla yapı kimyasalları, lojistik, havacılık sanayiine uzanan bir gelişim yaşadı. Günümüzde, 5 bini aşkın çalışanıyla Kale Grubu, Çanakkale başta olmak üzere Türkiye'nin çeşitli bölgelerinde bulunuyor. Türkiye'de seramik sektörünün kuruluşuna öncülük eden Kaleseramik, bu topraklarda üreten, bu topraklardan kazandığını yine bu topraklara yatıran bir değer.*

*Türkiye'nin ilk seramik karo üreticisi olan Çanakkale Seramik Fabrikaları A.Ş. 1957 yılında, ilk yer karosu üreticisi olan Kalebodur Seramik Sanayi A.Ş. ise 1972 yılında kuruldu. Çanakkale Seramik, duvar karosunda kalitenin adı olurken, Kalebodur jenerik marka olarak sektörde yeni bir dönemi başlattı.*

*Çanakkale Seramik Fabrikaları A.Ş ve Kalebodur Seramik Sanayi A.Ş. 2000 yılında "Kaleseramik Çanakkale Kalebodur Seramik Sanayi A.Ş" ismiyle tek çatı altında birleşti. Çanakkale Seramik ve Kalebodur markaları ile üretimini sürdüren Kaleseramik üretim kapasitesi ile tek bir alanda üretim yapan dünyanın en büyük seramik kuruluşudur.*

*Türkiye'nin 1., dünyanın en büyük seramik üreticilerinden biri olan Kaleseramik uzmanlığıyla 2005 yılında geliştirilen Kalesinterflex Porselen plaka; büyük ebatları, ince formu, hafif yapısı ve çevreci üretim teknolojisiyle seramiği yeni kullanım alanlarına taşıyor.*

With the new investment made in 2023, Kalesinterflex, which will be produced with the dimensions of 160x320cm, 6mm, 12mm, and 20mm thicknesses, as well as matte, satin, and polished surface options, is getting ready to put its stamp on the innovations that will revolutionize architecture.

*2023 yılında hayata geçirilen yeni yatırımla 160x320cm büyüklüğünde, 6mm, 12mm, 20mm inceliğinde, mat, satin ve parlak yüzey alternatifleriyle üretilecek olan Kalesinterflex; mimaride devrim etkisi yaratacak yeniliklere imza atmaya hazırlanıyor.*





## Human Factor

### *İnsan Faktörü*

Beginning in 6000 BC, this journey opens the doors to worlds waiting to be discovered with cutting-edge technology.

As Kaleseramik, we combine tradition, innovation, creativity, and craftsmanship for a unique form and functionality. Each new day brings novelty to our work, and our passion for ceramics grows daily, giving meaning to living spaces.

Because we know ceramic takes shape in the right hands. Thanks to its industrialist heritage and entrepreneurship, it continues economic and social activities with the priority of being a reputable group of companies that is a pioneer in its field, respects people and the environment, and adds sustainable value to society.

*Milattan önce 6000'li yıllarda başlayan bu yolculuk, yenilikçi teknolojiyle keşfedilmeyi bekleyen dünyaların kapılarını açıyor.  
Benzersiz bir form ve fonksiyonellik için Kaleseramik olarak gelenekle yeniliği, yaratıcılıkla zanaati buluşturuyoruz.  
Her yeni gün işimize de yenilik katıyor ve seramiğe duyduğumuz tutkuyu günden güne büyütüyor, yaşayan mekanlara anlam katıyoruz.*

*Çünkü seramiğin doğru ellerde şekil aldığını biliyoruz.  
Sanayici mirası ve girişimciliği ile alanında önder, insana ve çevreye saygılı, topluma sürdürülebilir değer katan itibarlı şirketler grubu olma önceliğiyle ekonomik ve toplumsal faaliyetlerine devam ediyor.*



# KALESINTERFLEX SUPERIOR TECHNOLOGIES

Kalesinterflex Üstün Yüzey Teknolojileri

- **DECOTECH**
- **BODYTECH**
- **FLOWTECH**
- **GLOWTECH**
- **FORMTECH**
- **OPENBOOK**





## DECOTECH

### The Technology Of Art

Sanatın Teknolojisi



DECOTECH technology, which stands out due to the application of special materials to the surfaces and their separation from flatly printed products, and matte or glossy materials bearing the name of granilla create a striking relief effect on the products.

Reliefs, which can be applied synchronously or independently according to different design needs and wishes, are often preferred in decorative and positive spaces.

Yüzeyle özel malzemelerin uygulanması ve düz baskılı ürünlerden ayrıştırılmasıyla öne çıkan DECOTECH teknolojisi, granilya adını taşıyan mat veya parlak malzemeler, ürünlerde çarpıcı bir kabartma etkisi oluşturur.

Farklı tasarım ihtiyaçlarına ve isteklere göre senkronize veya bağımsız olarak uygulanabilen kabartmalar, dekoratif ve pozitif mekanlarda sıklıkla tercih edilir.



## BODYTECH

### The Technology Of Consistency

Devamlılığın Teknolojisi



BODYTECH technology, which refers to the use of salt-pepper-mas in traditional porcelain production, is constituted from finely ground mas mixtures containing homogeneous stone textures and different color shades on the surface of the products. Thanks to the special method that carries the visual effect on the surface of the product to the product structure, each edge and each cut point of the product offers a harmonious and holistic appearance with the surface.

Geleneksel porselen üretimindeki tuz biber masse kullanımını ifade eden BODYTECH teknolojisi, ürünlerin yüzeyinde homojen taş dokusu ve farklı renk tonlarını içeren ince öğütülmüş masse karışımlarıyla oluşturulur. Ürünün yüzeyindeki görsel etkiyi ürün bünyesine taşıyan özel yöntemle, ürünün her bir kenarı ve kesilen her noktası, yüzeyle uyumlu ve bütünsel bir görünüm sunar.

## FLOWTECH

### The Technology Of Eternity

Sonsuzluğun Teknolojisi



FLOWTECH, used as a pattern tracking technology, ensures the progression of the pattern between the panels of marble-look products in particular. It creates a more impressive ambiance in wall applications in spaces. Some marble products were designed using this method. However, during the production phase, the products are produced in a combination. Practitioners should make the right choice during the covering to capture this flow. Thus, the aesthetic and design potential of the space is maximized.

Desen takip teknolojisi olarak kullanılan FLOWTECH, özellikle mermer görümlü ürünlerin panelleri arasındaki desenin devamlılığını sağlar. Mekanlardaki duvar kullanımlarında daha etkileyici bir atmosfer oluşturur. Bazı mermer ürünleri bu yöntemle tasarlanmıştır, ancak üretim aşamasında ürünler karma şekilde üretilir. Bu akışı yakalamak için döşeme sırasında uygulayıcıların doğru seçim yapması gerekmektedir. Böylece mekanın estetik ve tasarım potansiyeli en üst düzeye çıkar.

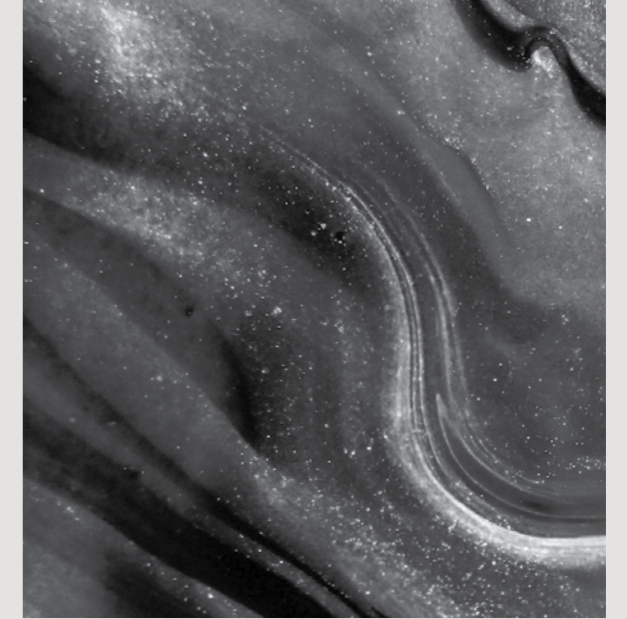
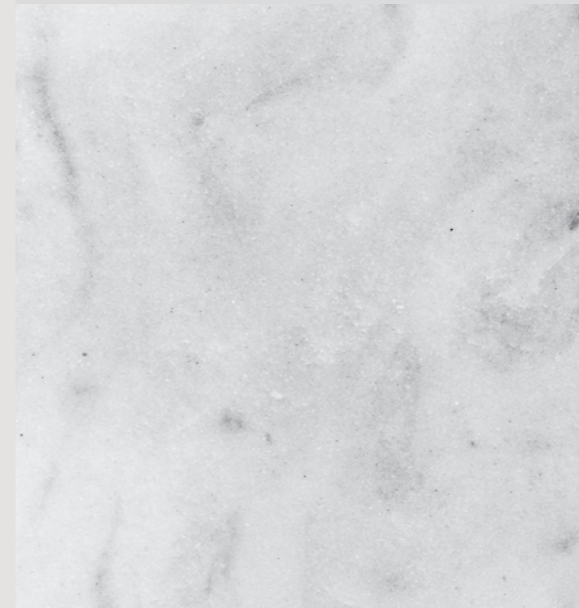

## GLOWTECH

### The Technology Of Sparkle

Işıltının Teknolojisi



GLOWTECH, used as a glitter/bright luminescence technology, refers to the effect caused by the glare of micro pieces on the surface of glossy products. This special effect gives the products a more exclusive and eye-catching glow by distinguishing them from standard glossy ones. While it is described as the reflection of the natural mineral glow in some marbles on the ceramic technology, an aesthetic and elegant shine is obtained in the spaces.

Simli/parlak ışıltılar teknolojisi olarak kullanılan GLOWTECH, parlak ürünlerde yüzeydeki mikro parçaların parlamasıyla oluşan etkiyi tanımlar. Bu özel etki, ürünleri standart parlaklardan ayırarak daha özel ve göz alıcı bir ışıltıya kavuşturur. Bazı mermerlerde bulunan doğal mineral ışıltılarının seramik teknolojisine yansımış hali olarak da nitelendirilirken, mekanlarda estetik ve zarif bir parlaklık elde edilir.



## OPENBOOK

### The Technology Of Symmetry

Simetri Teknolojisi



OPENBOOK, used as a correspondent pattern technology, enables one module to come face to face with the other module and create a unique pattern, especially in marble-look products. This special design distinguishes both modules as A and B with different codes while allowing small pattern shifts of 1-2 cm between them. Thanks to this method, aesthetic and visual diversity is achieved in spaces, and the integrity of the design is preserved.

Karşılıklı desen teknolojisi olarak kullanılan OPENBOOK, özellikle mermer görümlü ürünlerde, bir modülün diğer modül ile yüz yüze gelerek özgün bir desen oluşturmasını sağlar. Bu özel tasarım, modüller arasında 1-2 cm gibi küçük desen kaymalarına izin verirken, her iki modülü de A ve B olarak farklı kodlarla ayırt eder. Bu yöntem sayesinde mekanlarda estetik ve görsel çeşitlilik elde edilirken, tasarımın bütünlüğü korunur.

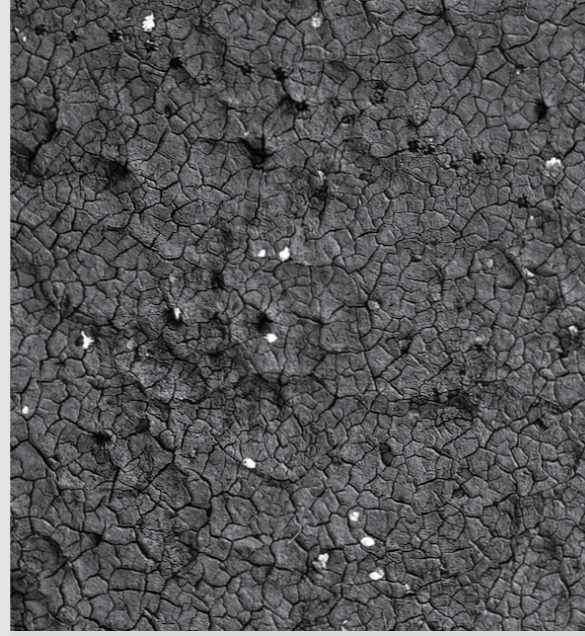

## FORMTECH

### The Technology Of Sensation

Dokunun Teknolojisi



Porcelain slabs mimicking the appearance of natural stone carry aesthetic elegance to living spaces. FORMTECH shapes porcelain slabs with inspiration from nature.

Bringing surfaces an embossed and ragged feel, FORMTECH technology adds depth to spaces. Special surfaces adapted to different patterns, textures and colors offer visual richness to living spaces. It creates a more attractive and unique atmosphere in every space.

Yüzeyle kabartmalı ve pütürlü bir dokunuş hissiyatı kazandıran FORMTECH teknolojisi, mekanlara derinlik ekler. Farklı desen ve renklere uyarlanan özel yüzeyler, yaşam alanlarına görsel zenginlik sunar. Her mekanda daha çekici ve özgün bir atmosfer yaratır.





# Spaces

## Alanlar

### Your home is your world.

Creating aesthetically pleasing and stylish products that fit seamlessly into your world is our world.

Crafted with attention to detail and pride, we collaborate with creators and manufacturers with similar passions. All to be a breath of fresh air in living spaces.

### Eviniz, sizin dünyanız.

Sizin dünyanıza uyum sağlayacak estetik ve şık ürünler tasarlamak da bizim dünyamız. Detaylarla mükemmelleştirilmiş bir işçilik, benzer tutkuları paylaştığımız yaratıcılar ve üreticilerle yaptığımız işbirlikleri. Hepsî yaşayan mekanlara taptaze bir nefes olmak için.



EARTH COLLECTION/TRAVERTINE SILVER  
EARTH KOLEKSİYONU/TRAVERTINE SILVER



FIORI DI BOSCO



MARMO METALLO



# Bathroom

*Banyo*



CRYSTALLUS



DENISE



CRYSTALLUS



# Bathroom

*Banyo*





# Kitchen

Mutfak



TRAVERTINE SILVER



OLIMPO



PIETRA NERO





CALACATTA GOLD



CRYSTALLUS



EARTH COLLECTION  
EARTH KOLEKSİYONU







## Exterior

*Dış Mekan*

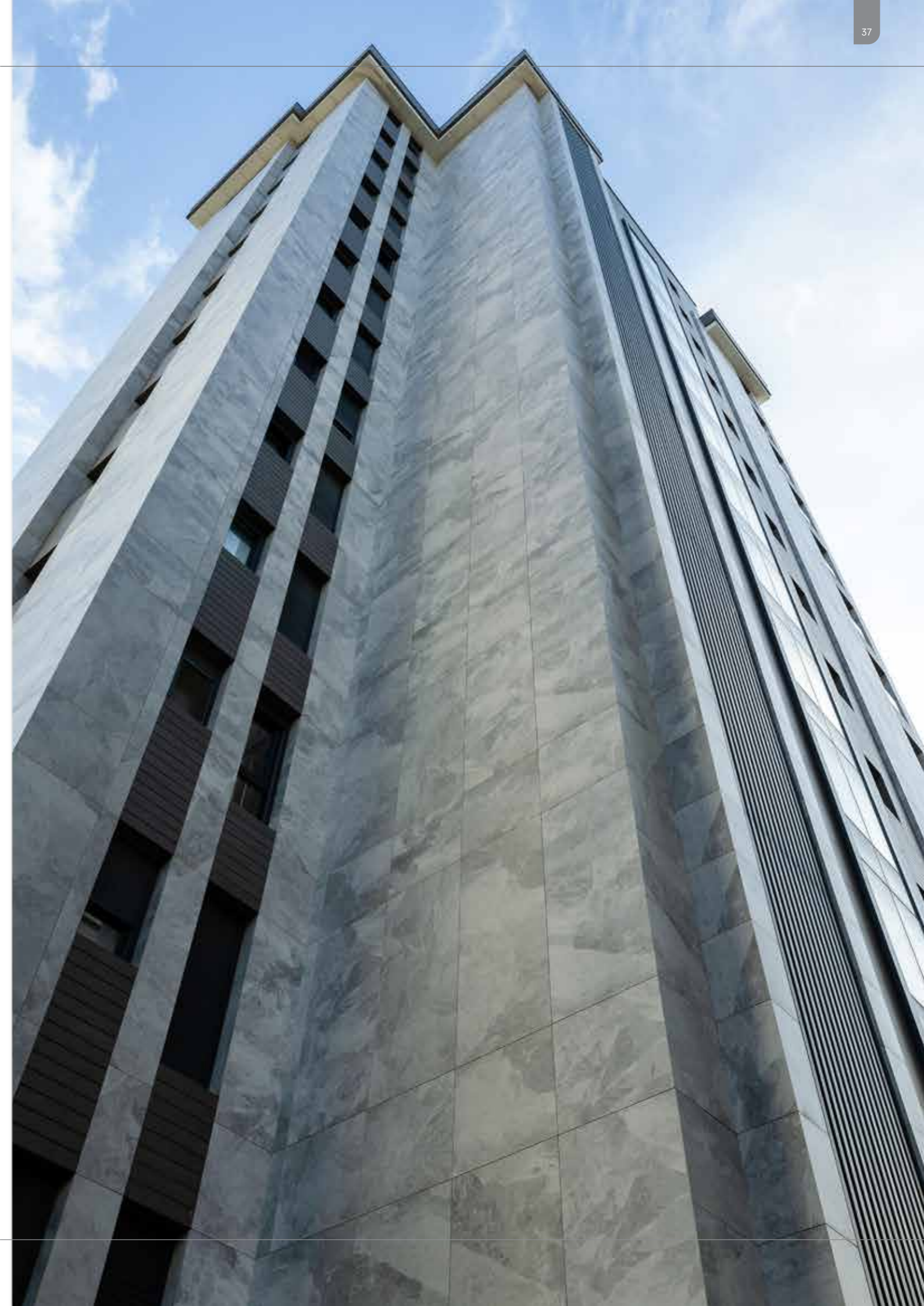



## Marble Look

### Mermer Görünüm

The timeless beauty of marble inspires high-tech porcelain slabs. Each curve and pattern created by the hand of nature turns these rare slabs into sustainable works of art.

*Mermerin zamana karşı koyan güzelliği, yüksek teknolojinin eseri porselen plakalara ilham veriyor. Doğanın eliyle yaratılan her bir kıvrım ve deseni birer sanat eserine çeviriyor.*

100x300 - 3mm • 120x360 - 3mm • 160x320 - 6mm •  
162x323 - 6mm - 12mm - 20mm - 5mm - 3mm

## Wood Look

### Ahşap Görünüm

When the simplicity and naturalness of a wood-like appearance come together, elegant porcelain plates are prepared for spaces, creating perfect beauty.

*Ahşap görünümün sadeliği ve doğallığı buluştuğunda mekanlar için şık porselen plakalar hazırlanarak kusursuz bir güzellik yaratılıyor.*

100x300 - 3mm • 120x360 - 3mm

## Solid Color

### Düz Renkler

A striking simplicity. For a refined look, it creates subtle, broad, sophisticated surfaces that leave a lasting impression.

*Çarpıcı bir sadelik. Rafine bir görünüm için incelikli, geniş, sürekli etki bırakan incelikli yüzeyler yaratır.*

100x300 - 3mm • 120x360 - 3mm • 160x320 - 6mm •  
162x323 - 6mm - 12mm

## Stone Look

### Doğaltaş Görünüm

The original and rare beauty of natural stone meets the extraordinary durability of porcelain slab. The optimal and aesthetic interpretation of the materials given by nature provides a characterful perfection to spaces.

*Doğal taşın orijinal ve nadir güzelliği, porselen plakanın olağanüstü dayanıklılığıyla buluşuyor. Doğanın verdiği malzemelerin en ideal ve estetik bir şekilde yorumlanmasıyla oluşan bu görünüm mekanlara karakterli bir kusursuzluk katıyor.*

100x300 - 3mm • 120x360 - 3mm • 160x320 - 6mm •  
162x323 - 6mm - 12mm - 20mm

## Metal Look

### Metal Görünüm

The mineral beauty of metals is revitalized and deepened with large porcelain slabs that allow for stunning designs. These products bring the ideal solution for spaces designed with contemporary architecture.

*Metallerin mineral güzelliği yeniden hayat buluyor ve çarpıcı tasarımlara olanak veren büyük porselen plakalarla derinlik kazanıyor. Bu ürünler, çağdaş mimariye sahip mekanlar için ideal çözüm sunuyor.*

100x300 - 3mm • 120x360 - 3mm • 160x320 - 6mm • 162x323 - 6mm - 12mm

## Cement Look

### Çimento Görünüm

Cement, the unsung hero of every endeavor, weaves a magical beauty with its cement-like appearance on porcelain plates. An extraordinary touch that beautifies and gives character to a structure.

*Çimento, her projenin gizli kahramanıdır; porselen plakaların üzerindeki çimento görünümü, büyümlü bir estetik yaratır. Bir yapıyı güzelleştiren ve ona karakter katan sıradışı bir dokunuş.*

100x300 - 3mm • 120x360 - 3mm • 160x320 - 6mm •  
162x323 - 6mm - 12mm - 20mm



## Artwall

### Artwall

Artwall'un artistik görünümlü porselen plakaları, teknoloji ve estetiği bir araya getiriyor. Doğanın zarafetini taşıyan desenleri, yaşam alanlarınızı adeta bir sanat galerisine çeviriyor.

*Artwall's porcelain slabs with artistic looks bring together technology and aesthetics. Their patterns that bear the elegance of nature transform your living spaces into a kind of art gallery.*

160x320 - 6mm • 162x323 - 6mm - 12mm - 20mm



**MARBLE LOOK**  
*MERMER GÖRÜNÜM*





## Marble Look

*Mermer Görünüm*



PIETRA NERO



CRYSTALLUS



## Marble Look

*Mermer Görünüm*



CALACATTA UNIQUE OPENBOOK



ALASKA WHITE



# Marble | Black & White

*Mermer | Siyah & Beyaz*

new  
yeni



CALACATTA UNIQUE

	mm	Matte	Soft Matte	Polished	Satin	Face
100x300 cm	3	•				
	5	•				
120x360 cm	3	•				
	5	•				
160x320 cm 162x323 cm	6		•	•		3F
	12		•	•	•	
	20		•	•		

FLOW  
TECH

new  
yeni



CALACATTA UNIQUE OPENBOOK

	mm	Matte	Soft Matte	Polished	Satin	Face
100x300 cm	3					
	5					
120x360 cm	3					
	5					
160x320 cm 162x323 cm	6		•	•		3F
	12		•	•		
	20		•	•		

FLOW  
TECH

OPEN  
BOOK

new  
yeni



GOLDEN HOUR

	mm	Matte	Soft Matte	Polished	Satin	Face
100x300 cm	3					
	5					
120x360 cm	3					
	5					
160x320 cm 162x323 cm	6		•	•		3F
	12		•	•		
	20		•	•		

FLOW  
TECH

new  
yeni



GOLDEN HOUR OPENBOOK

	mm	Matte	Soft Matte	Polished	Satin	Face
100x300 cm	3					
	5					
120x360 cm	3					
	5					
160x320 cm 162x323 cm	6		•	•		3F
	12		•	•		
	20		•	•		

FLOW  
TECH

OPEN  
BOOK



Interior &  
Design  
İç Mekan &  
Tasarım



Facade  
Cephe



Kitchen  
Mutfak



Furniture  
Mobilya



Bathroom  
Banyo



Indoor  
Konut



Outdoor  
Dış Mekan



Commercial  
Ticari Alan



Gleaming  
Parıltılı



Wall  
Duvar



Floor  
Yer



Moderate  
Variation  
Önemli  
Farklılık



Indicates the  
number of faces  
Yüzey sayısını  
gösterir

100x300cm, 120x360cm and 160x320cm are rectified sizes.  
100x300cm, 120x360cm ve 160x320cm ebatlar karelenmiş ebatlardır.

Please check pages between 146-153 for dimension detail chart.

Ebat tablosu için 146-153 sayfaları arasına bakınız.

The use of polished products in areas with heavy pedestrian traffic is not recommended.  
Parlak ürünlerin yoğun yaya trafiği olan alanlarda kullanımı önerilmez.



Interior &  
Design  
İç Mekan &  
Tasarım



Facade  
Cephe



Kitchen  
Mutfak



Furniture  
Mobilya



Bathroom  
Banyo



Indoor  
Konut



Outdoor  
Dış Mekan



Commercial  
Ticari Alan



Gleaming  
Parıltılı



Wall  
Duvar



Floor  
Yer



Moderate  
Variation  
Önemli  
Farklılık



Indicates the  
number of faces  
Yüzey sayısını  
gösterir

100x300cm, 120x360cm and 160x320cm are rectified sizes.  
100x300cm, 120x360cm ve 160x320cm ebatlar karelenmiş ebatlardır.

Please check pages between 146-153 for dimension detail chart.

Ebat tablosu için 146-153 sayfaları arasına bakınız.

The use of polished products in areas with heavy pedestrian traffic is not recommended.  
Parlak ürünlerin yoğun yaya trafiği olan alanlarda kullanımı önerilmez.



# Marble | Black & White

*Mermer | Siyah & Beyaz*

new  
yeni



FLORENCE

	mm	Matte	Soft Matte	Polished	Satin	Face
100x300 cm	3					
	5					
120x360 cm	3					
	5					
160x320 cm 162x323 cm	6		•	•		3F
	12		•	•		
	20					

FLOW  
TECH

new  
yeni



FLORENCE OPENBOOK

	mm	Matte	Soft Matte	Polished	Satin	Face
100x300 cm	3					
	5					
120x360 cm	3					
	5					
160x320 cm 162x323 cm	6		•	•		
	12		•	•		
	20					

FLOW  
TECH

OPEN  
BOOK



Interior &  
Design  
İç Mekan &  
Tasarım



Facade  
Cephe



Kitchen  
Mutfak



Furniture  
Mobilya



Bathroom  
Banyo



Indoor  
Konut



Outdoor  
Dış Mekan



Commercial  
Ticari Alan



Gleaming  
Parıltılı



Wall  
Duvar



Floor  
Yer



Moderate  
Variation  
Önemli  
Farklılık



Indicates the  
number of faces  
Yüzey sayısını  
gösterir

100x300cm, 120x360cm and 160x320cm are rectified sizes.

100x300cm, 120x360cm ve 160x320cm ebatlar karelenmiş ebatlardır.

The use of polished products in areas with heavy pedestrian traffic is not recommended.

Parlak ürünlerin yoğun yaya trafiği olan alanlarda kullanımı önerilmez.

Please check pages between 146-153 for dimension detail chart.

Ebat tablosu için 146-153 sayfaları arasına bakınız.



COLORADO ORO

	mm	Matte	Soft Matte	Polished	Satin
100x300 cm	3	•			
	5	•			
120x360 cm	3				
	5				
160x320 cm 162x323 cm	6				
	12				
	20				



COLORADO ORO OPENBOOK

	mm	Matte	Soft Matte	Polished	Satin
100x300 cm	3	•			
	5	•			
120x360 cm	3				
	5				
160x320 cm 162x323 cm	6				
	12				
	20				

OPEN  
BOOK



Interior &  
Design  
İç Mekan &  
Tasarım



Facade  
Cephe



Kitchen  
Mutfak



Furniture  
Mobilya



Bathroom  
Banyo



Indoor  
Konut



Outdoor  
Dış Mekan



Commercial  
Ticari Alan



Gleaming  
Parıltılı



Wall  
Duvar



Floor  
Yer



Uniform  
Appearance  
Aynı  
Görünüm



Indicates the  
number of faces  
Yüzey sayısını  
gösterir

100x300cm, 120x360cm and 160x320cm are rectified sizes.

100x300cm, 120x360cm ve 160x320cm ebatlar karelenmiş ebatlardır.

The use of polished products in areas with heavy pedestrian traffic is not recommended.

Parlak ürünlerin yoğun yaya trafiği olan alanlarda kullanımı önerilmez.

Please check pages between 146-153 for dimension detail chart.

Ebat tablosu için 146-153 sayfaları arasına bakınız.



# Marble | Black & White

Mermer | Siyah & Beyaz

new  
yeni



PIETRA NERO

	mm	Matte	Soft Matte	Polished	Satin	Face
100x300 cm	3 5	•				
120x360 cm	3 5	•				
160x320 cm 162x323 cm	6 12 20		•	•		3F

new  
yeni

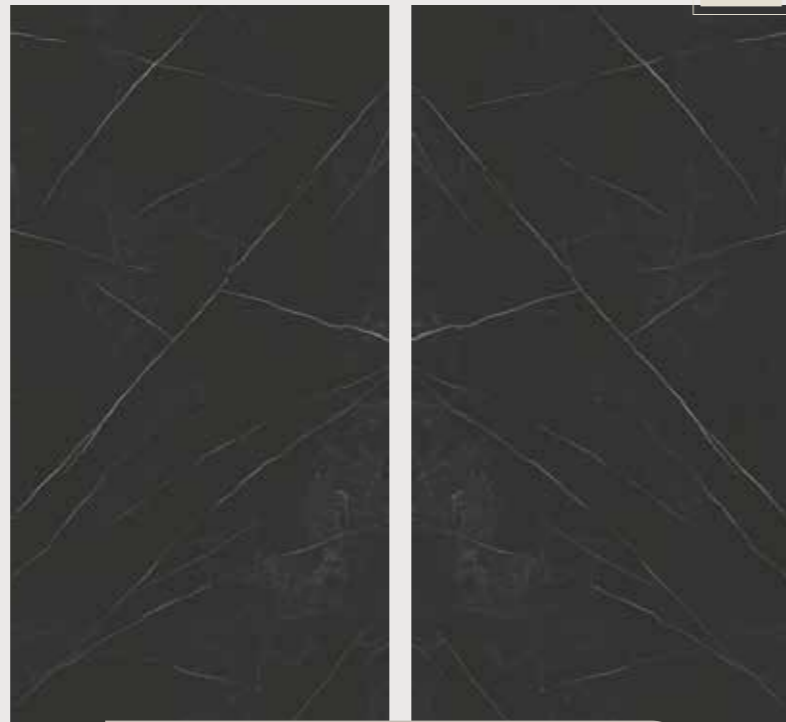

PIETRA NERO OPENBOOK

	mm	Matte	Soft Matte	Polished	Satin	Face
100x300 cm	3 5					
120x360 cm	3 5					
160x320 cm	6 12 20		•	•		

OPEN  
BOOK

new  
yeni



CALACATTA CALDIA

	mm	Matte	Soft Matte	Polished	Satin	Face
100x300 cm	3 5	•				
120x360 cm	3 5	•				
160x320 cm 162x323 cm	6 12 20		•	•	•	3F

new  
yeni



BRONZE LINE

	mm	Matte	Soft Matte	Polished	Satin	Face
100x300 cm	3 5					
120x360 cm	3 5					
160x320 cm 162x323 cm	6 12 20		•	•		3F

new  
yeni



CALACATTA GOLD\*

	mm	Matte	Soft Matte	Polished	Satin	Face
100x300 cm	3 5	•				
120x360 cm	3 5	•				
160x320 cm 162x323 cm	6 12 20		•	•	•	3F

DECO  
TECH

\*Gleaming Surface: Regional shiny / sparkle effect on matte surface.  
Parıltılı Yüzey: Mat yüzey üzerinde bölgesel ışıltı / parıltı efekti.



Interior &  
Design  
İç Mekan &  
Tasarım



Facade  
Cephe



Kitchen  
Mutfak



Furniture  
Mobilya



Bathroom  
Banyo



Indoor  
Konut



Outdoor  
Dış Mekan



Commercial  
Ticari Alan



Gleaming  
Parıltılı



Wall  
Duvar



Floor  
Yer



Moderate  
Variation  
Önemli  
Farklılık



Indicates the  
number of faces  
Yüzey sayısını  
gösterir

100x300cm, 120x360cm and 160x320cm are rectified sizes.  
100x300cm, 120x360cm ve 160x320cm ebatlar karelenmiş ebatlardır.

Please check pages between 146-153 for dimension detail chart.

Ebat tablosu için 146-153 sayfaları arasına bakınız.

The use of polished products in areas with heavy pedestrian traffic is not recommended.  
Parlak ürünlerin yoğun yaya trafiği olan alanlarda kullanımı önerilmez.

100x300cm, 120x360cm and 160x320cm are rectified sizes.  
100x300cm, 120x360cm ve 160x320cm ebatlar karelenmiş ebatlardır.

Please check pages between 146-153 for dimension detail chart.

Ebat tablosu için 146-153 sayfaları arasına bakınız.

The use of polished products in areas with heavy pedestrian traffic is not recommended.  
Parlak ürünlerin yoğun yaya trafiği olan alanlarda kullanımı önerilmez.



# Marble | Black & White

Mermer | Siyah & Beyaz

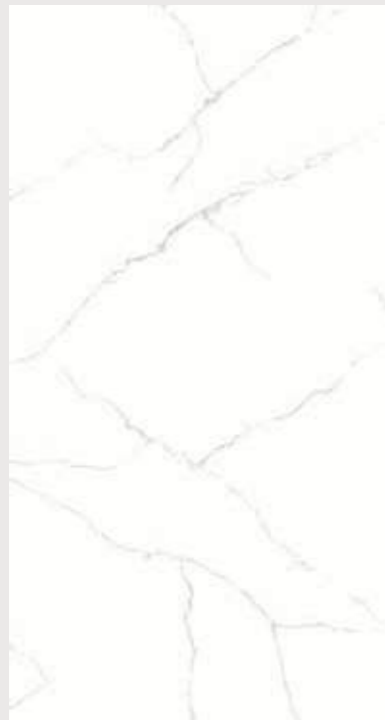

MARBLE STATUARIO

	mm	Matte	Soft Matte	Polished	Satin
100x300 cm	3				
	5				
120x360 cm	3				
	5				
160x320 cm 162x323 cm	6				
	12		•	•	
	20				



CALACATTA ICE

	mm	Matte	Soft Matte	Polished	Satin
100x300 cm	3	•			
	5				
120x360 cm	3	•			
	5				
160x320 cm 162x323 cm	6				
	12				
	20				



PALISSANDRO\*

	mm	Matte	Soft Matte	Polished	Satin	Face
100x300 cm	3	•				
	5	•				
120x360 cm	3	•				
	5	•				
160x320 cm 162x323 cm	6		•			4F
	12		•			
	20					

DECO  
TECH



CALACATTA 2.0

	mm	Matte	Soft Matte	Polished	Satin	Face
100x300 cm	3	•				3F
	5	•				
120x360 cm	3	•				3F
	5	•				
160x320 cm 162x323 cm	6					
	12					
	20					



CALACATTA MACCHIA

	mm	Matte	Soft Matte	Polished	Satin
100x300 cm	3	•			
	5				
120x360 cm	3	•			
	5				
160x320 cm 162x323 cm	6		•	•	3F
	12		•	•	
	20				

DECO  
TECH



CALACATTA VIOLA

	mm	Matte	Soft Matte	Polished	Satin
100x300 cm	3				
	5				
120x360 cm	3				
	5				
160x320 cm 162x323 cm	6		•	•	3F
	12		•	•	
	20				

new  
yeni

\*Gleaming Surface: Regional shiny / sparkle effect on matte surface.  
Parıltılı Yüzey: Mat yüzey üzerinde bölgesel ışıltı / parıltı efekti.



Interior & Design  
İç Mekan & Tasarım



Facade  
Cephe



Kitchen  
Mutfak



Furniture  
Mobilya



Bathroom  
Banyo



Indoor  
Konut



Outdoor  
Dış Mekan



Commercial  
Ticari Alan



Gleaming  
Parıltılı



Wall  
Duvar



Floor  
Yer



Moderate  
Variation  
Önemli  
Farklılık



Indicates the  
number of faces  
Yüzey sayısını  
gösterir

100x300cm, 120x360cm and 160x320cm are rectified sizes.  
100x300cm, 120x360cm ve 160x320cm ebatlar karelenmiş ebatlardır.

Please check pages between 146-153 for dimension detail chart.

Ebat tablosu için 146-153 sayfaları arasına bakınız.

The use of polished products in areas with heavy pedestrian traffic is not recommended.  
Parlak ürünlerin yoğun yaya trafiği olan alanlarda kullanımı önerilmez.

100x300cm, 120x360cm and 160x320cm are rectified sizes.  
100x300cm, 120x360cm ve 160x320cm ebatlar karelenmiş ebatlardır.

Please check pages between 146-153 for dimension detail chart.

The use of polished products in areas with heavy pedestrian traffic is not recommended.  
Parlak ürünlerin yoğun yaya trafiği olan alanlarda kullanımı önerilmez.

Ebat tablosu için 146-153 sayfaları arasına bakınız.



## Marble | Black & White

*Mermer | Siyah & Beyaz*



WINTERLAND

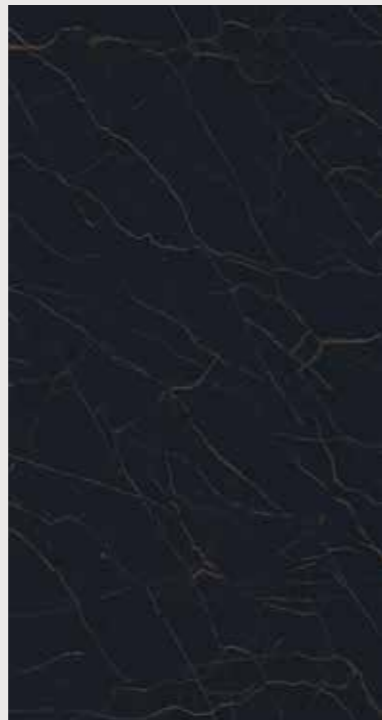

PORT LAURENT

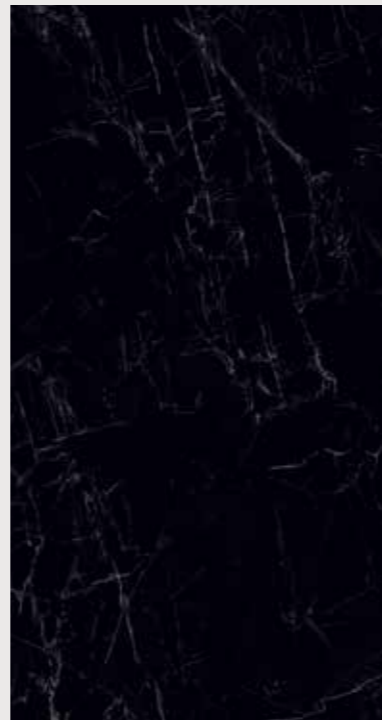

MARBLE DARK

	mm	Matte	Soft Matte	Polished	Satin
100x300 cm	3	•			
	5	•			
120x360 cm	3	•			
	5	•			
160x320 cm 162x323 cm	6				
	12				
	20				

	mm	Matte	Soft Matte	Polished	Satin	Face
100x300 cm	3	•				
	5	•				
120x360 cm	3	•				
	5	•				
160x320 cm 162x323 cm	6		•	•		2F
	12		•	•		
	20					

	mm	Matte	Soft Matte	Polished	Satin
100x300 cm	3	•			
	5	•			
120x360 cm	3	•			
	5	•			
160x320 cm 162x323 cm	6				
	12				
	20				

## Marble | Exclusive

*Mermer | Özel*

new  
yeni



PATAGONIA

	mm	Matte	Soft Matte	Polished	Satin	Face
100x300 cm	3					
	5					
120x360 cm	3					
	5					
160x320 cm 162x323 cm	6		•	•		3F
	12					
	20					

FLOW  
TECH

new  
yeni



PATAGONIA OPENBOOK

	mm	Matte	Soft Matte	Polished	Satin	Face
100x300 cm	3					
	5					
120x360 cm	3					
	5					
160x320 cm 162x323 cm	6		•	•		
	12					
	20					

FLOW  
TECH

OPEN  
BOOK



Interior &  
Design  
İç Mekan &  
Tasarım



Facade  
Cephe



Kitchen  
Mutfak



Furniture  
Mobilya



Bathroom  
Banyo



Indoor  
Konut



Outdoor  
Dış Mekan



Commercial  
Ticari Alan



Gleaming  
Parıltılı



Wall  
Duvar



Floor  
Yer



Moderate  
Variation  
Önemli  
Farklılık



Indicates the  
number of faces  
Yüzey sayısını  
gösterir

100x300cm, 120x360cm and 160x320cm are rectified sizes.  
100x300cm, 120x360cm ve 160x320cm ebatlar karelenmiş ebatlardır.

Please check pages between 146-153 for dimension detail chart.

Ebat tablosu için 146-153 sayfaları arasına bakınız.

The use of polished products in areas with heavy pedestrian traffic is not recommended.  
Parlak ürünlerin yoğun yaya trafiği olan alanlarda kullanımı önerilmez.

100x300cm, 120x360cm and 160x320cm are rectified sizes.  
100x300cm, 120x360cm ve 160x320cm ebatlar karelenmiş ebatlardır.

Please check pages between 146-153 for dimension detail chart.

The use of polished products in areas with heavy pedestrian traffic is not recommended.  
Parlak ürünlerin yoğun yaya trafiği olan alanlarda kullanımı önerilmez.

Ebat tablosu için 146-153 sayfaları arasına bakınız.



## Marble | Exclusive

Mermer | Özel



QUARZITE JADORE

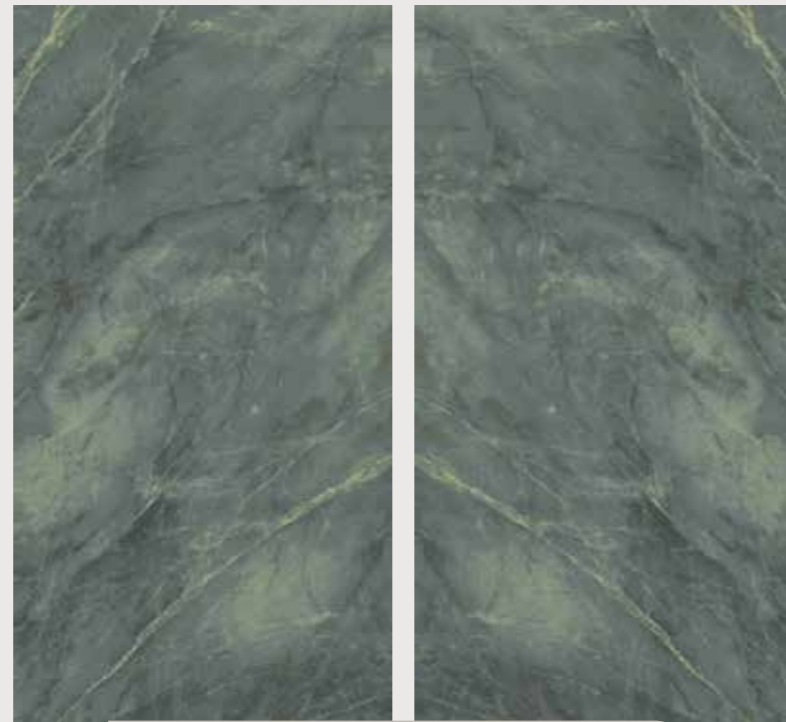

QUARZITE JADORE OPENBOOK

	mm	Matte	Soft Matte	Polished	Satin	Face
100x300 cm	3					
	5					
120x360 cm	3					
	5					
160x320 cm 162x323 cm	6			•		3F
	12			•		
	20					

	mm	Matte	Soft Matte	Polished	Satin	Face
100x300 cm	3					
	5					
120x360 cm	3					
	5					
160x320 cm 162x323 cm	6			•		
	12			•		
	20					



Interior & Design  
İç Mekan & Tasarım



Facade  
Cephe



Kitchen  
Mutfak



Furniture  
Mobilya



Bathroom  
Banyo



Indoor  
Konut



Outdoor  
Dış Mekan



Commercial  
Ticari Alan



Gleaming  
Parıltılı



Wall  
Duvar



Floor  
Yer



Moderate  
Variation  
Önemli  
Farklılık



Indicates the  
number of faces  
Yüzey sayısını  
gösterir

100x300cm, 120x360cm and 160x320cm are rectified sizes.  
100x300cm, 120x360cm ve 160x320cm ebatlar karelenmiş ebatlardır.

Please check pages between 146-153 for dimension detail chart.

Ebat tablosu için 146-153 sayfaları arasına bakınız.

The use of polished products in areas with heavy pedestrian traffic is not recommended.  
Parlak ürünlerin yoğun yaya trafiği olan alanlarda kullanımı önerilmez.

new  
yeni

TIFFANY BLUE

	mm	Matte	Soft Matte	Polished	Satin	Face
100x300 cm	3					
	5					
120x360 cm	3					
	5					
160x320 cm 162x323 cm	6			•		3F
	12					
	20					

new  
yeni

TIFFANY BLUE OPENBOOK

	mm	Matte	Soft Matte	Polished	Satin	Face
100x300 cm	3					
	5					
120x360 cm	3					
	5					
160x320 cm 162x323 cm	6			•		
	12					
	20					



Interior & Design  
İç Mekan & Tasarım



Facade  
Cephe



Kitchen  
Mutfak



Furniture  
Mobilya



Bathroom  
Banyo



Indoor  
Konut



Outdoor  
Dış Mekan



Commercial  
Ticari Alan



Gleaming  
Parıltılı



Wall  
Duvar



Floor  
Yer



Moderate  
Variation  
Önemli  
Farklılık



Indicates the  
number of faces  
Yüzey sayısını  
gösterir

100x300cm, 120x360cm and 160x320cm are rectified sizes.  
100x300cm, 120x360cm ve 160x320cm ebatlar karelenmiş ebatlardır.

Please check pages between 146-153 for dimension detail chart.

Ebat tablosu için 146-153 sayfaları arasına bakınız.

The use of polished products in areas with heavy pedestrian traffic is not recommended.  
Parlak ürünlerin yoğun yaya trafiği olan alanlarda kullanımı önerilmez.



## Marble | Exclusive

Mermer | Özel

new  
yeni

NAMIBIA

mm	Matte	Soft Matte	Polished	Satin	Face
100x300 cm	3				
	5				
120x360 cm	3				
	5				
160x320 cm	6		•		3F
162x323 cm	12		•		
	20				

FLOW  
TECHnew  
yeni

ALASKA WHITE

mm	Matte	Soft Matte	Polished	Satin	Face
100x300 cm	3				
	5				
120x360 cm	3				
	5				
160x320 cm	6		•		3F
162x323 cm	12		•		
	20				

FLOW  
TECHSAHARA BROWN  
SAHARA KAHVE

mm	Matte	Soft Matte	Polished	Satin	Face
100x300 cm	3	•			
	5				
120x360 cm	3				
	5				
160x320 cm	6		•		3F
162x323 cm	12		•		
	20				

new  
yeni

MARINA

mm	Matte	Soft Matte	Polished	Satin	Face
100x300 cm	3				
	5				
120x360 cm	3				
	5				
160x320 cm	6		•		3F
162x323 cm	12		•		
	20				

FLOW  
TECH

SEA NATURE

mm	Matte	Soft Matte	Polished	Satin	Face
100x300 cm	3	•			
	5				
120x360 cm	3				
	5				
160x320 cm	6				
162x323 cm	12				
	20				

Interior &  
Design  
İç Mekan &  
TasarımFacade  
CepheKitchen  
MutfakFurniture  
MobilyaBathroom  
BanyoIndoor  
KonutOutdoor  
Dış MekanCommercial  
Ticari AlanGleaming  
ParıltılıWall  
DuvarFloor  
YerModerate  
Variation  
Önemli  
FarklılıkIndicates the  
number of faces  
Yüzey sayısını  
gösterir100x300cm, 120x360cm and 160x320cm are rectified sizes.  
100x300cm, 120x360cm ve 160x320cm ebatlar karelenmiş ebatlardır.

Please check pages between 146-153 for dimension detail chart.

Ebat tablosu için 146-153 sayfaları arasına bakınız.

The use of polished products in areas with heavy pedestrian traffic is not recommended.  
Parlak ürünlerin yoğun yaya trafiği olan alanlarda kullanımı önerilmez.Interior &  
Design  
İç Mekan &  
TasarımFacade  
CepheKitchen  
MutfakFurniture  
MobilyaBathroom  
BanyoIndoor  
KonutOutdoor  
Dış MekanCommercial  
Ticari AlanGleaming  
ParıltılıWall  
DuvarFloor  
YerModerate  
Variation  
Önemli  
FarklılıkIndicates the  
number of faces  
Yüzey sayısını  
gösterir100x300cm, 120x360cm and 160x320cm are rectified sizes.  
100x300cm, 120x360cm ve 160x320cm ebatlar karelenmiş ebatlardır.

Please check pages between 146-153 for dimension detail chart.

Ebat tablosu için 146-153 sayfaları arasına bakınız.

The use of polished products in areas with heavy pedestrian traffic is not recommended.  
Parlak ürünlerin yoğun yaya trafiği olan alanlarda kullanımı önerilmez.



## Marble | Exclusive

Mermer | Özel

new  
yeni

SARRANCOLIN



MARMO METALLO\*



VERSAILLES



ASTEROID



MOCHA PERLA



OLIMPO

	mm	Matte	Soft Matte	Polished	Satin	Face
100x300 cm	3 5					
120x360 cm	3 5					
160x320 cm 162x323 cm	6 12 20		•	•		3F

	mm	Matte	Soft Matte	Polished	Satin	Face
100x300 cm	3 5	•				
120x360 cm	3 5	•				
160x320 cm 162x323 cm	6 12 20		•			3F

	mm	Matte	Soft Matte	Polished	Satin	Face
100x300 cm	3 5					
120x360 cm	3 5					
160x320 cm 162x323 cm	6 12 20		•	•		

	mm	Matte	Soft Matte	Polished	Satin	Face
100x300 cm	3 5	•				5F
120x360 cm	3 5	•				5F
160x320 cm 162x323 cm	6 12 20					

	mm	Matte	Soft Matte	Polished	Satin	Face
100x300 cm	3 5	•				
120x360 cm	3 5	•				
160x320 cm 162x323 cm	6 12 20					

	mm	Matte	Soft Matte	Polished	Satin	Face
100x300 cm	3 5	•				
120x360 cm	3 5	•				
160x320 cm 162x323 cm	6 12 20		•	•		3F

Interior & Design  
İç Mekan & TasarımFacade  
CepheKitchen  
MutfakFurniture  
MobilyaBathroom  
BanyoIndoor  
KonutOutdoor  
Dış MekanCommercial  
Ticari AlanGleaming  
ParıltılıWall  
DuvarFloor  
YerModerate  
Variation  
Önemli  
FarklılıkIndicates the  
number of faces  
Yüzey sayısını  
gösterir

100x300cm, 120x360cm and 160x320cm are rectified sizes.

100x300cm, 120x360cm ve 160x320cm ebatlar karelenmiş ebatlardır.

Please check pages between 146-153 for dimension detail chart.

Ebat tablosu için 146-153 sayfaları arasına bakınız.

The use of polished products in areas with heavy pedestrian traffic is not recommended.

Parlak ürünlerin yoğun yaya trafiği olan alanlarda kullanımı önerilmez.

Interior & Design  
İç Mekan & TasarımFacade  
CepheKitchen  
MutfakFurniture  
MobilyaBathroom  
BanyoIndoor  
KonutOutdoor  
Dış MekanCommercial  
Ticari AlanGleaming  
ParıltılıWall  
DuvarFloor  
YerModerate  
Variation  
Önemli  
FarklılıkIndicates the  
number of faces  
Yüzey sayısını  
gösterir

100x300cm, 120x360cm and 160x320cm are rectified sizes.

100x300cm, 120x360cm ve 160x320cm ebatlar karelenmiş ebatlardır.

Please check pages between 146-153 for dimension detail chart.

Ebat tablosu için 146-153 sayfaları arasına bakınız.

The use of polished products in areas with heavy pedestrian traffic is not recommended.

Parlak ürünlerin yoğun yaya trafiği olan alanlarda kullanımı önerilmez.



## Marble | Exclusive

*Mermer | Özel*



ALAMEDA

	mm	Matte	Soft Matte	Polished	Satin
100x300 cm	3	•			
	5				
120x360 cm	3	•			
	5				
160x320 cm 162x323 cm	6				
	12				
	20				



Interior & Design  
İç Mekan & Tasarım



Facade  
Cephe



Kitchen  
Mutfak



Furniture  
Mobilya



Bathroom  
Banyo



Indoor  
Konut



Outdoor  
Dış Mekan



Commercial  
Ticari Alan



Gleaming  
Parıltı



Wall  
Duvar



Floor  
Yer



Moderate  
Variation  
Önemli  
Farklılık



Indicates the  
number of faces  
Yüzey sayısını  
gösterir

100x300cm, 120x360cm and 160x320cm are rectified sizes.  
100x300cm, 120x360cm ve 160x320cm ebatlar karelenmiş ebatlardır.

The use of polished products in areas with heavy pedestrian traffic is not recommended.  
Parlak ürünlerin yoğun yaya trafiği olan alanlarda kullanımı önerilmez.

Please check pages between 146-153 for dimension detail chart.

Ebat tablosu için 146-153 sayfaları arasına bakınız.

## Marble | Timeless

*Mermer | Zamansız*



FIORI DI BOSCO

	mm	Matte	Soft Matte	Polished	Satin	Face
100x300 cm	3					
	5					
120x360 cm	3					
	5					
160x320 cm 162x323 cm	6		•	•		3F
	12					
	20					

FLOW  
TECH



Interior & Design  
İç Mekan & Tasarım



Facade  
Cephe



Kitchen  
Mutfak



Furniture  
Mobilya



Bathroom  
Banyo



Indoor  
Konut



Outdoor  
Dış Mekan



Commercial  
Ticari Alan



Gleaming  
Parıltı



Wall  
Duvar



Floor  
Yer



Moderate  
Variation  
Önemli  
Farklılık



Indicates the  
number of faces  
Yüzey sayısını  
gösterir

100x300cm, 120x360cm and 160x320cm are rectified sizes.  
100x300cm, 120x360cm ve 160x320cm ebatlar karelenmiş ebatlardır.

The use of polished products in areas with heavy pedestrian traffic is not recommended.  
Parlak ürünlerin yoğun yaya trafiği olan alanlarda kullanımı önerilmez.

Please check pages between 146-153 for dimension detail chart.

Ebat tablosu için 146-153 sayfaları arasına bakınız.



# Marble | Timeless

Mermer | Zamansız

new  
yeni



CRYSTALLUS

	mm	Matte	Soft Matte	Polished	Satin	Face
100x300 cm	3 5					
120x360 cm	3 5					
160x320 cm 162x323 cm	6 12 20			•		3F

GLOW  
TECH

new  
yeni



DENISE

	mm	Matte	Soft Matte	Polished	Satin	Face
100x300 cm	3 5					
120x360 cm	3 5					
160x320 cm 162x323 cm	6 12 20		•	•		3F

GLOW  
TECH



PULPIS

	mm	Matte	Soft Matte	Polished	Satin
100x300 cm	3 5	•			
120x360 cm	3 5	•			
160x320 cm 162x323 cm	6 12 20				



TRANSLUCENT ONYX

	mm	Matte	Soft Matte	Polished	Satin
100x300 cm	3 5	•			
120x360 cm	3 5				
160x320 cm 162x323 cm	6 12 20				



Interior & Design  
İç Mekan & Tasarım



Facade  
Cephe



Kitchen  
Mutfak



Furniture  
Mobilya



Bathroom  
Banyo



Indoor  
Konut



Outdoor  
Dış Mekan



Commercial  
Ticari Alan



Gleaming  
Parıltılı



Wall  
Duvar



Floor  
Yer



Moderate  
Variation  
Önemli  
Farklılık



Indicates the  
number of faces  
Yüzey sayısını  
gösterir



Interior & Design  
İç Mekan & Tasarım



Facade  
Cephe



Kitchen  
Mutfak



Furniture  
Mobilya



Bathroom  
Banyo



Indoor  
Konut



Outdoor  
Dış Mekan



Commercial  
Ticari Alan



Gleaming  
Parıltılı



Wall  
Duvar



Floor  
Yer



Moderate  
Variation  
Önemli  
Farklılık



Indicates the  
number of faces  
Yüzey sayısını  
gösterir

100x300cm, 120x360cm and 160x320cm are rectified sizes.  
100x300cm, 120x360cm ve 160x320cm ebatlar karelenmiş ebatlardır.

Please check pages between 146-153 for dimension detail chart.

Ebat tablosu için 146-153 sayfaları arasına bakınız.

The use of polished products in areas with heavy pedestrian traffic is not recommended.  
Parlak ürünlerin yoğun yaya trafiği olan alanlarda kullanımı önerilmez.

100x300cm, 120x360cm and 160x320cm are rectified sizes.  
100x300cm, 120x360cm ve 160x320cm ebatlar karelenmiş ebatlardır.

Please check pages between 146-153 for dimension detail chart.

The use of polished products in areas with heavy pedestrian traffic is not recommended.  
Parlak ürünlerin yoğun yaya trafiği olan alanlarda kullanımı önerilmez.

Ebat tablosu için 146-153 sayfaları arasına bakınız.



STONE LOOK  
*DOĞALTAŞ GÖRÜNÜM*





## Stone Look

*Doğaltaş Görünüm*



UPTOWN DARK



RAPOLANO IVORY



## Stone Look

*Doğaltaş Görünüm*





## Stone

Doğaltaş

new  
yeni

**EARTH COLLECTION  
RAPOLANO IVORY**  
EARTH KOLEKSİYONU  
RAPOLANO IVORY

mm	Matte	Soft Matte	Polished	Satin	Face
100x300 cm	3				
	5				
120x360 cm	3				
	5				
160x320 cm	6	•			3F
162x323 cm	12				
	20				

**FORM**  
TECH **DECO**  
TECH



**EARTH COLLECTION  
RAPOLANO SILVER**  
EARTH KOLEKSİYONU  
RAPOLANO SILVER

mm	Matte	Soft Matte	Polished	Satin	Rock Surface
100x300 cm	3				
	5				
120x360 cm	3				
	5				
160x320 cm	6	•			3F
162x323 cm	12				
	20				

**FORM**  
TECH **DECO**  
TECH

new  
yeni

**EARTH COLLECTION  
TRAVERTINE IVORY**  
EARTH KOLEKSİYONU  
TRAVERTINE IVORY

mm	Matte	Soft Matte	Polished	Satin	Face
100x300 cm	3				
	5				
120x360 cm	3				
	5				
160x320 cm	6	•			3F
162x323 cm	12				
	20				

**FORM**  
TECH

new  
yeni

**EARTH COLLECTION  
TRAVERTINE SILVER**  
EARTH KOLEKSİYONU  
TRAVERTINE SILVER

mm	Matte	Soft Matte	Polished	Satin	Face
100x300 cm	3				
	5				
120x360 cm	3				
	5				
160x320 cm	6	•			3F
162x323 cm	12				
	20				

**FORM**  
TECH



Interior &  
Design  
İç Mekan &  
Tasarım



Facade  
Cephe



Kitchen  
Mutfak



Furniture  
Mobilya



Bathroom  
Banyo



Indoor  
Konut



Outdoor  
Dış Mekan



Commercial  
Ticari Alan



Gleaming  
Parıltılı



Wall  
Duvar



Floor  
Yer



Moderate  
Variation  
Önemli  
Farklılık



Indicates the  
number of faces  
Yüzey sayısını  
gösterir

100x300cm, 120x360cm and 160x320cm are rectified sizes.  
100x300cm, 120x360cm ve 160x320cm ebatlar karelenmiş ebatlardır.

Please check pages between 146-153 for dimension detail chart.

Ebat tablosu için 146-153 sayfaları arasına bakınız.

The use of polished products in areas with heavy pedestrian traffic is not recommended.  
Parlak ürünlerin yoğun yaya trafiği olan alanlarda kullanımı önerilmez.



Interior &  
Design  
İç Mekan &  
Tasarım



Facade  
Cephe



Kitchen  
Mutfak



Furniture  
Mobilya



Bathroom  
Banyo



Indoor  
Konut



Outdoor  
Dış Mekan



Commercial  
Ticari Alan



Gleaming  
Parıltılı



Wall  
Duvar



Floor  
Yer



Moderate  
Variation  
Önemli  
Farklılık



Indicates the  
number of faces  
Yüzey sayısını  
gösterir

100x300cm, 120x360cm and 160x320cm are rectified sizes.  
100x300cm, 120x360cm ve 160x320cm ebatlar karelenmiş ebatlardır.

Please check pages between 146-153 for dimension detail chart.

Ebat tablosu için 146-153 sayfaları arasına bakınız.

The use of polished products in areas with heavy pedestrian traffic is not recommended.  
Parlak ürünlerin yoğun yaya trafiği olan alanlarda kullanımı önerilmez.



## Stone

Doğaltaş

new  
yeniCALCARIO COLLECTION  
GREIGEnew  
yeniCALCARIO COLLECTION  
LINE GREIGEnew  
yeniCALCARIO COLLECTION  
LIGHT GREIGEnew  
yeniCALCARIO COLLECTION  
LIGHT LINE GREIGEOCEAN WHITE  
OCEAN BEYAZOCEAN BLACK  
OCEAN SİYAH

	mm	Matte	Soft Matte	Polished	Satin	Rock Surface	Face
100x300 cm	3 5						
120x360 cm	3 5						
160x320 cm 162x323 cm	6 12 20		•			•	2F

	mm	Matte	Soft Matte	Polished	Satin	Rock Surface	Face
100x300 cm	3 5						
120x360 cm	3 5						
160x320 cm 162x323 cm	6 12 20		•				2F

	mm	Matte	Soft Matte	Polished	Satin	Rock Surface	Face
100x300 cm	3 5						
120x360 cm	3 5						
160x320 cm 162x323 cm	6 12 20		•			•	2F

	mm	Matte	Soft Matte	Polished	Satin	Face
100x300 cm	3 5					
120x360 cm	3 5					
160x320 cm 162x323 cm	6 12 20		•			2F

	mm	Matte	Soft Matte	Polished	Satin	Face
100x300 cm	3 5	•				3F
120x360 cm	3 5					
160x320 cm 162x323 cm	6 12 20					

	mm	Matte	Soft Matte	Polished	Satin	Face
100x300 cm	3 5	•				3F
120x360 cm	3 5					
160x320 cm 162x323 cm	6 12 20					

BODY  
TECH FORM  
TECHBODY  
TECH FORM  
TECH DECO  
TECHBODY  
TECH FORM  
TECHBODY  
TECH FORM  
TECH DECO  
TECHInterior &  
Design  
İç Mekan &  
TasarımFacade  
CepheKitchen  
MutfakFurniture  
MobilyaBathroom  
BanyoIndoor  
KonutOutdoor  
Dış MekanCommercial  
Ticari AlanGleaming  
ParıltılıWall  
DuvarFloor  
YerSlight  
Variation  
Hafif  
FarklılıkIndicates the  
number of faces  
Yüzey sayısını  
gösterir100x300cm, 120x360cm and 160x320cm are rectified sizes.  
100x300cm, 120x360cm ve 160x320cm ebatlar karelenmiş ebatlardır.

Please check pages between 146-153 for dimension detail chart.

Ebat tablosu için 146-153 sayfaları arasına bakınız.

The use of polished products in areas with heavy pedestrian traffic is not recommended.  
Parlak ürünlerin yoğun yaya trafiği olan alanlarda kullanımı önerilmez.Interior &  
Design  
İç Mekan &  
TasarımFacade  
CepheKitchen  
MutfakFurniture  
MobilyaBathroom  
BanyoIndoor  
KonutOutdoor  
Dış MekanCommercial  
Ticari AlanGleaming  
ParıltılıWall  
DuvarFloor  
YerModerate  
Variation  
Önemli  
FarklılıkIndicates the  
number of faces  
Yüzey sayısını  
gösterir100x300cm, 120x360cm and 160x320cm are rectified sizes.  
100x300cm, 120x360cm ve 160x320cm ebatlar karelenmiş ebatlardır.

Please check pages between 146-153 for dimension detail chart.

Ebat tablosu için 146-153 sayfaları arasına bakınız.

The use of polished products in areas with heavy pedestrian traffic is not recommended.  
Parlak ürünlerin yoğun yaya trafiği olan alanlarda kullanımı önerilmez.



## Stone

Doğaltaş



NATURAL STONE  
LECCESE LIGHT SAND

	mm	Matte	Soft Matte	Polished	Satin
100x300 cm	3	•			
	5	•			
120x360 cm	3				
	5				
160x320 cm 162x323 cm	6				
	12				
	20				



NATURAL STONE  
LECCESE DARK SAND

	mm	Matte	Soft Matte	Polished	Satin
100x300 cm	3	•			
	5	•			
120x360 cm	3	•			
	5	•			
160x320 cm 162x323 cm	6				
	12				
	20				



NATURAL STONE  
LECCESE GREY

	mm	Matte	Soft Matte	Polished	Satin
100x300 cm	3	•			
	5	•			
120x360 cm	3				
	5				
160x320 cm 162x323 cm	6				
	12				
	20				



NATURAL STONE PIETRA BLUE  
NATURAL STONE PIETRA MAVİ

	mm	Matte	Soft Matte	Polished	Satin	Rock Surface
100x300 cm	3	•				
	5	•				
120x360 cm	3	•				
	5	•				
160x320 cm 162x323 cm	6					
	12					
	20					



NATURAL STONE PIETRA GREY  
NATURAL STONE PIETRA GRİ

	mm	Matte	Soft Matte	Polished	Satin	Rock Surface
100x300 cm	3	•				
	5	•				
120x360 cm	3					
	5					
160x320 cm 162x323 cm	6					
	12					
	20					



Interior &  
Design  
İç Mekan &  
Tasarım



Facade  
Cephe



Kitchen  
Mutfak



Furniture  
Mobilya



Bathroom  
Banyo



Indoor  
İç Mekan



Outdoor  
Dış Mekan



Commercial  
Ticari Alan



Wall  
Duvar



Floor  
Yer



Slight  
Variation  
Hafif  
Farklılık



Interior &  
Design  
İç Mekan &  
Tasarım



Facade  
Cephe



Kitchen  
Mutfak



Furniture  
Mobilya



Bathroom  
Banyo



Indoor  
İç Mekan



Outdoor  
Dış Mekan



Commercial  
Ticari Alan



Wall  
Duvar



Floor  
Yer



Slight  
Variation  
Hafif  
Farklılık

100x300cm, 120x360cm and 160x320cm are rectified sizes.  
100x300cm, 120x360cm ve 160x320cm ebatlar karelenmiş ebatlardır.

Please check pages between 146-153 for dimension detail chart.

Ebat tablosu için 146-153 sayfaları arasına bakınız.

The use of polished products in areas with heavy pedestrian traffic is not recommended.  
Parlak ürünlerin yoğun yaya trafiği olan alanlarda kullanımı önerilmez.

100x300cm, 120x360cm and 160x320cm are rectified sizes.  
100x300cm, 120x360cm ve 160x320cm ebatlar karelenmiş ebatlardır.

Please check pages between 146-153 for dimension detail chart.

Ebat tablosu için 146-153 sayfaları arasına bakınız.

The use of polished products in areas with heavy pedestrian traffic is not recommended.  
Parlak ürünlerin yoğun yaya trafiği olan alanlarda kullanımı önerilmez.



## Stone

Doğaltaş



**C-STONE WHITE**  
C-STONE BEYAZ

	mm	Matte	Soft Matte	Polished	Satin
100x300 cm	3	•			
	5	•			
120x360 cm	3	•			
	5	•			
160x320 cm 162x323 cm	6				
	12				
	20				



**C-STONE BEIGE**  
C-STONE BEJ

	mm	Matte	Soft Matte	Polished	Satin
100x300 cm	3	•			
	5	•			
120x360 cm	3	•			
	5	•			
160x320 cm 162x323 cm	6				
	12				
	20				



**C-STONE GREY**  
C-STONE GRİ

	mm	Matte	Soft Matte	Polished	Satin
100x300 cm	3	•			
	5	•			
120x360 cm	3	•			
	5	•			
160x320 cm 162x323 cm	6				
	12				
	20				



**C-STONE BROWN**  
C-STONE KAHVE

	mm	Matte	Soft Matte	Polished	Satin
100x300 cm	3	•			
	5	•			
120x360 cm	3	•			
	5	•			
160x320 cm 162x323 cm	6				
	12				
	20				



**C-STONE ANTHRACITE**  
C-STONE ANTRASİT

	mm	Matte	Soft Matte	Polished	Satin
100x300 cm	3	•			
	5	•			
120x360 cm	3	•			
	5	•			
160x320 cm 162x323 cm	6				
	12				
	20				



Interior &  
Design  
İç Mekan &  
Tasarım



Facade  
Cephe



Kitchen  
Mutfak



Furniture  
Mobilya



Bathroom  
Banyo



Indoor  
İç Mekan



Outdoor  
Dış Mekan



Commercial  
Ticari Alan



Wall  
Duvar



Floor  
Yer



Slight  
Variation  
Hafif  
Farklılık

100x300cm, 120x360cm and 160x320cm are rectified sizes.  
100x300cm, 120x360cm ve 160x320cm ebatlar karelenmiş ebatlardır.

Please check pages between 146-153 for dimension detail chart.

Ebat tablosu için 146-153 sayfaları arasına bakınız.

The use of polished products in areas with heavy pedestrian traffic is not recommended.  
Parlak ürünlerin yoğun yaya trafiği olan alanlarda kullanımı önerilmez.



Interior &  
Design  
İç Mekan &  
Tasarım



Facade  
Cephe



Kitchen  
Mutfak



Furniture  
Mobilya



Bathroom  
Banyo



Indoor  
İç Mekan



Outdoor  
Dış Mekan



Commercial  
Ticari Alan



Wall  
Duvar



Floor  
Yer



Slight  
Variation  
Hafif  
Farklılık

100x300cm, 120x360cm and 160x320cm are rectified sizes.  
100x300cm, 120x360cm ve 160x320cm ebatlar karelenmiş ebatlardır.

Please check pages between 146-153 for dimension detail chart.

Ebat tablosu için 146-153 sayfaları arasına bakınız.

The use of polished products in areas with heavy pedestrian traffic is not recommended.  
Parlak ürünlerin yoğun yaya trafiği olan alanlarda kullanımı önerilmez.



## Stone

Doğaltaş



PIETRA BASALTINA

	mm	Matte	Soft Matte	Polished	Satin	Rock Surface
100x300 cm	3	•				
	5					
120x360 cm	3					
	5					
160x320 cm	6					
	12		•			
162x323 cm	12					•
	20					

FORM  
TECH

PIETRA CHATILLONN

	mm	Matte	Soft Matte	Polished	Satin
100x300 cm	3	•			
	5	•			
120x360 cm	3				
	5				
160x320 cm	6				
	12				
162x323 cm	12				
	20				

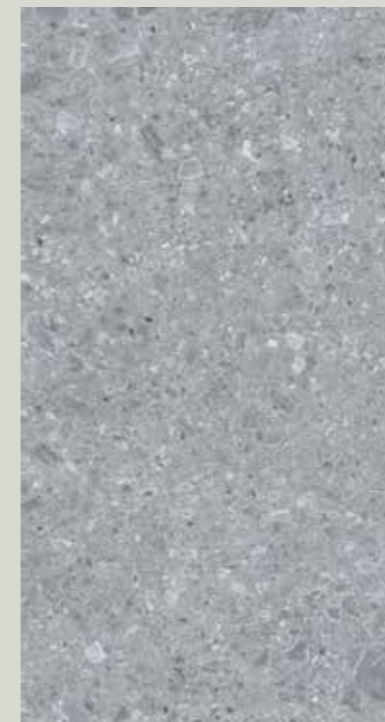
FORM  
TECHPIETRA DI GRE GREY  
PIETRA DI GRE GRİ

	mm	Matte	Soft Matte	Polished	Satin	Face
100x300 cm	3	•				
	5					
120x360 cm	3	•				
	5					
160x320 cm	6		•			3F
	12		•			
162x323 cm	12		•			
	20					

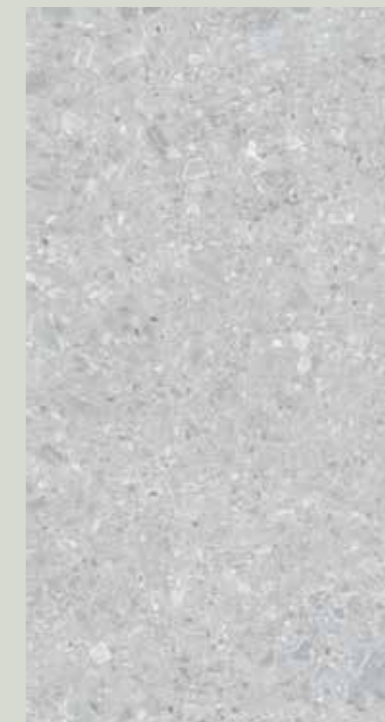
FORM  
TECHPIETRA DI GRE BONE  
PIETRA DI GRE KEMİK

	mm	Matte	Soft Matte	Polished	Satin	Face
100x300 cm	3	•				
	5					
120x360 cm	3	•				
	5					
160x320 cm	6		•			3F
	12		•			
162x323 cm	12		•			
	20					

FORM  
TECHInterior &  
Design  
İç Mekan &  
TasarımFacade  
CepheKitchen  
MutfakFurniture  
MobilyaBathroom  
BanyoIndoor  
KonutOutdoor  
Dış MekanCommercial  
Ticari AlanGleaming  
ParıltılıWall  
DuvarFloor  
YerModerate  
Variation  
Önemli  
FarklılıkIndicates the  
number of faces  
Yüzey sayısını  
gösterir

100x300cm, 120x360cm and 160x320cm are rectified sizes.  
100x300cm, 120x360cm ve 160x320cm ebatlar karelenmiş ebatlardır.

Please check pages between 146-153 for dimension detail chart.

Ebat tablosu için 146-153 sayfaları arasına bakınız.

The use of polished products in areas with heavy pedestrian traffic is not recommended.  
Parlak ürünlerin yoğun yaya trafiği olan alanlarda kullanımı önerilmez.

Interior &  
Design  
İç Mekan &  
TasarımFacade  
CepheKitchen  
MutfakFurniture  
MobilyaBathroom  
BanyoIndoor  
KonutOutdoor  
Dış MekanCommercial  
Ticari AlanGleaming  
ParıltılıWall  
DuvarFloor  
YerModerate  
Variation  
Önemli  
FarklılıkIndicates the  
number of faces  
Yüzey sayısını  
gösterir

100x300cm, 120x360cm and 160x320cm are rectified sizes.  
100x300cm, 120x360cm ve 160x320cm ebatlar karelenmiş ebatlardır.

Please check pages between 146-153 for dimension detail chart.

The use of polished products in areas with heavy pedestrian traffic is not recommended.  
Parlak ürünlerin yoğun yaya trafiği olan alanlarda kullanımı önerilmez.

Ebat tablosu için 146-153 sayfaları arasına bakınız.



## Stone

Doğaltaş



**UPTOWN DARK**  
UPTOWN KOYU

	mm	Matte	Soft Matte	Polished	Satin
100x300 cm	3	•			
	5	•			
120x360 cm	3	•			
	5	•			
160x320 cm 162x323 cm	6				
	12				
	20				



**UPTOWN LIGHT**  
UPTOWN AÇIK

	mm	Matte	Soft Matte	Polished	Satin
100x300 cm	3	•			
	5	•			
120x360 cm	3	•			
	5	•			
160x320 cm 162x323 cm	6				
	12				
	20				



**TRAVERTINO**

	mm	Matte	Soft Matte	Polished	Satin
100x300 cm	3				
	5				
120x360 cm	3	•			
	5				
160x320 cm 162x323 cm	6				
	12				
	20				



**LIMESTONE**

	mm	Matte	Soft Matte	Polished	Satin
100x300 cm	3	•			
	5	•			
120x360 cm	3	•			
	5	•			
160x320 cm 162x323 cm	6				
	12				
	20				



Interior &  
Design  
İç Mekan &  
Tasarım



Facade  
Cephe



Kitchen  
Mutfak



Furniture  
Mobilya



Bathroom  
Banyo



Indoor  
Konut



Outdoor  
Dış Mekan



Commercial  
Ticari Alan



Structured  
Kalıplı



Wall  
Duvar



Floor  
Yer



Slight  
Variation  
Hafif Farklılık



Interior &  
Design  
İç Mekan &  
Tasarım



Facade  
Cephe



Kitchen  
Mutfak



Furniture  
Mobilya



Bathroom  
Banyo



Indoor  
Konut



Outdoor  
Dış Mekan



Commercial  
Ticari Alan



Structured  
Kalıplı



Wall  
Duvar



Floor  
Yer



Slight  
Variation  
Hafif Farklılık

100x300cm, 120x360cm and 160x320cm are rectified sizes.  
100x300cm, 120x360cm ve 160x320cm ebatlar karelenmiş ebatlardır.

Please check pages between 146-153 for dimension detail chart.

Ebat tablosu için 146-153 sayfaları arasına bakınız.

The use of polished products in areas with heavy pedestrian traffic is not recommended.  
Parlak ürünlerin yoğun yaya trafiği olan alanlarda kullanımı önerilmez.

100x300cm, 120x360cm and 160x320cm are rectified sizes.  
100x300cm, 120x360cm ve 160x320cm ebatlar karelenmiş ebatlardır.

Please check pages between 146-153 for dimension detail chart.

The use of polished products in areas with heavy pedestrian traffic is not recommended.  
Parlak ürünlerin yoğun yaya trafiği olan alanlarda kullanımı önerilmez.

Ebat tablosu için 146-153 sayfaları arasına bakınız.



## Stone

Doğaltaş

new  
yeni

STONE GALLERY QUARTZ ASH



CITYSCAPE



BRERA CREME



MONOLITH



PIAMONTE

	mm	Matte	Soft Matte	Polished	Satin
100x300 cm	3 5	•			
120x360 cm	3 5				
160x320 cm 162x323 cm	6 12 20				

	mm	Matte	Soft Matte	Polished	Satin
100x300 cm	3 5				
120x360 cm	3 5				
160x320 cm 162x323 cm	6 12 20		•		

	mm	Matte	Soft Matte	Polished	Satin
100x300 cm	3 5	•			
120x360 cm	3 5				
160x320 cm 162x323 cm	6 12 20				

	mm	Matte	Soft Matte	Polished	Satin
100x300 cm	3 5	•			
120x360 cm	3 5				
160x320 cm 162x323 cm	6 12 20				

	mm	Matte	Soft Matte	Polished	Satin
100x300 cm	3 5	•			
120x360 cm	3 5				
160x320 cm 162x323 cm	6 12 20				

**BODY** TECH **FORM** TECH



Interior &  
Design  
İç Mekan &  
Tasarım



Facade  
Cephe



Kitchen  
Mutfak



Furniture  
Mobilya



Bathroom  
Banyo



Indoor  
İç Mekan



Outdoor  
Dış Mekan



Commercial  
Ticari Alan



Wall  
Duvar



Floor  
Yer



Slight  
Variation  
Hafif  
Farklılık



Interior &  
Design  
İç Mekan &  
Tasarım



Facade  
Cephe



Kitchen  
Mutfak



Furniture  
Mobilya



Bathroom  
Banyo



Indoor  
İç Mekan



Outdoor  
Dış Mekan



Commercial  
Ticari Alan



Wall  
Duvar



Floor  
Yer



Slight  
Variation  
Hafif  
Farklılık

100x300cm, 120x360cm and 160x320cm are rectified sizes.  
100x300cm, 120x360cm ve 160x320cm ebatlar karelenmiş ebatlardır.

Please check pages between 146-153 for dimension detail chart.

Ebat tablosu için 146-153 sayfaları arasına bakınız.

The use of polished products in areas with heavy pedestrian traffic is not recommended.  
Parlak ürünlerin yoğun yaya trafiği olan alanlarda kullanımı önerilmez.

100x300cm, 120x360cm and 160x320cm are rectified sizes.  
100x300cm, 120x360cm ve 160x320cm ebatlar karelenmiş ebatlardır.

Please check pages between 146-153 for dimension detail chart.

Ebat tablosu için 146-153 sayfaları arasına bakınız.

The use of polished products in areas with heavy pedestrian traffic is not recommended.  
Parlak ürünlerin yoğun yaya trafiği olan alanlarda kullanımı önerilmez.



CEMENT LOOK  
ÇİMENTO GÖRÜNÜM



LUXURY CEMENT GREY  
LUXURY CEMENT GRİ







## Cement

Çimento

new  
yeniLUXURY CEMENT WHITE  
LUXURY CEMENT BEYAZLUXURY CEMENT BEIGE  
LUXURY CEMENT BEJLUXURY CEMENT GREY  
LUXURY CEMENT GRİLUXURY CEMENT CEMENTO  
LUXURY CEMENT ÇİMENTO

LUXURY CEMENT TAUPE

LUXURY CEMENT MINK  
LUXURY CEMENT VİZON

	mm	Matte	Soft Matte	Polished	Satin
100x300 cm	3	•			
	5	•			
120x360 cm	3	•			
	5	•			
160x320 cm 162x323 cm	6		•		
	12		•		
	20		•		

	mm	Matte	Soft Matte	Polished	Satin
100x300 cm	3	•			
	5	•			
120x360 cm	3	•			
	5	•			
160x320 cm 162x323 cm	6		•		
	12		•		
	20		•		

	mm	Matte	Soft Matte	Polished	Satin
100x300 cm	3	•			
	5	•			
120x360 cm	3	•			
	5	•			
160x320 cm 162x323 cm	6		•		
	12		•		
	20		•		

	mm	Matte	Soft Matte	Polished	Satin
100x300 cm	3	•			
	5	•			
120x360 cm	3	•			
	5	•			
160x320 cm 162x323 cm	6		•		
	12		•		
	20		•		

	mm	Matte	Soft Matte	Polished	Satin
100x300 cm	3	•			
	5	•			
120x360 cm	3	•			
	5	•			
160x320 cm 162x323 cm	6		•		
	12		•		
	20		•		

	mm	Matte	Soft Matte	Polished	Satin
100x300 cm	3	•			
	5	•			
120x360 cm	3	•			
	5	•			
160x320 cm 162x323 cm	6		•		
	12		•		
	20		•		

Interior &  
Design  
İç Mekan &  
TasarımFacade  
CepheKitchen  
MutfakFurniture  
MobilyaBathroom  
BanyoIndoor  
İç MekanOutdoor  
Dış MekanCommercial  
Ticari AlanWall  
DuvarFloor  
YerUniform  
Appearance  
Aynı Görünüm

100x300cm, 120x360cm and 160x320cm are rectified sizes.  
100x300cm, 120x360cm ve 160x320cm ebatlar karelenmiş ebatlardır.

Please check pages between 146-153 for dimension detail chart.

Ebat tablosu için 146-153 sayfaları arasına bakınız.

The use of polished products in areas with heavy pedestrian traffic is not recommended.  
Parlak ürünlerin yoğun yaya trafiği olan alanlarda kullanımı önerilmez.

Interior &  
Design  
İç Mekan &  
TasarımFacade  
CepheKitchen  
MutfakFurniture  
MobilyaBathroom  
BanyoIndoor  
İç MekanOutdoor  
Dış MekanCommercial  
Ticari AlanWall  
DuvarFloor  
YerUniform  
Appearance  
Aynı Görünüm

100x300cm, 120x360cm and 160x320cm are rectified sizes.  
100x300cm, 120x360cm ve 160x320cm ebatlar karelenmiş ebatlardır.

Please check pages between 146-153 for dimension detail chart.

Ebat tablosu için 146-153 sayfaları arasına bakınız.

The use of polished products in areas with heavy pedestrian traffic is not recommended.  
Parlak ürünlerin yoğun yaya trafiği olan alanlarda kullanımı önerilmez.

## Cement

Çimento



LUXURY CEMENT ANTHRACITE  
LUXURY CEMENT ANTRASİT

	mm	Matte	Soft Matte	Polished	Satin
100x300 cm	3	•			
	5	•			
120x360 cm	3	•			
	5	•			
160x320 cm 162x323 cm	6		•		
	12				
	20				



LUXURY CEMENT ANTHI

	mm	Matte	Soft Matte	Polished	Satin
100x300 cm	3	•			
	5	•			
120x360 cm	3	•			
	5	•			
160x320 cm 162x323 cm	6		•		
	12				
	20				

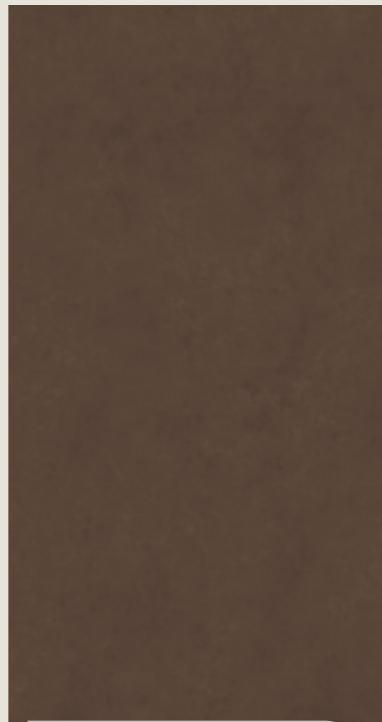

LUXURY CEMENT BROWN  
LUXURY CEMENT KAHVE

	mm	Matte	Soft Matte	Polished	Satin
100x300 cm	3	•			
	5	•			
120x360 cm	3	•			
	5	•			
160x320 cm 162x323 cm	6		•		
	12				
	20				

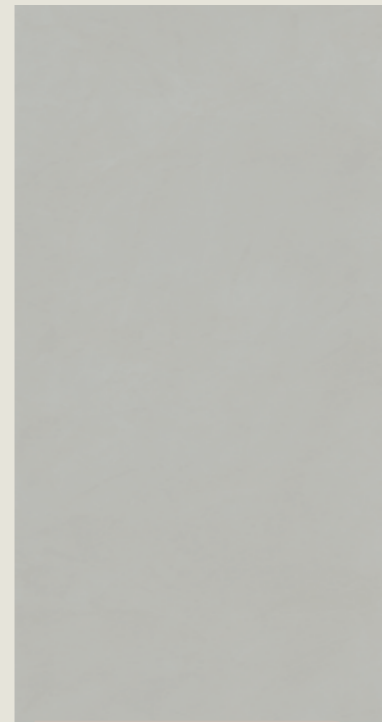

HUED OFF WHITE

	mm	Matte	Soft Matte	Polished	Satin
100x300 cm	3	•			
	5	•			
120x360 cm	3	•			
	5	•			
160x320 cm 162x323 cm	6		•		
	12				
	20				

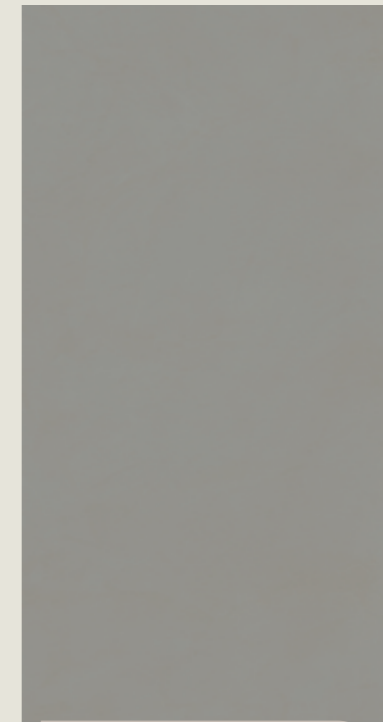

HUED GREY  
HUED GRİ

	mm	Matte	Soft Matte	Polished	Satin
100x300 cm	3	•			
	5	•			
120x360 cm	3	•			
	5	•			
160x320 cm 162x323 cm	6		•		
	12				
	20				



HUED DARK GREY  
HUED KOYU GRİ

	mm	Matte	Soft Matte	Polished	Satin
100x300 cm	3	•			
	5	•			
120x360 cm	3	•			
	5	•			
160x320 cm 162x323 cm	6		•		
	12				
	20				



Interior &  
Design  
İç Mekan &  
Tasarım



Facade  
Cephe



Kitchen  
Mutfak



Furniture  
Mobilya



Bathroom  
Banyo



Indoor  
İç Mekan



Outdoor  
Dış Mekan



Commercial  
Ticari Alan



Wall  
Duvar



Floor  
Yer



Uniform  
Appearance  
Aynı Görünüm

100x300cm, 120x360cm and 160x320cm are rectified sizes.  
100x300cm, 120x360cm ve 160x320cm ebatlar karelenmiş ebatlardır.

Please check pages between 146-153 for dimension detail chart.

Ebat tablosu için 146-153 sayfaları arasına bakınız.

The use of polished products in areas with heavy pedestrian traffic is not recommended.  
Parlak ürünlerin yoğun yaya trafiği olan alanlarda kullanımı önerilmez.



Interior &  
Design  
İç Mekan &  
Tasarım



Facade  
Cephe



Kitchen  
Mutfak



Furniture  
Mobilya



Bathroom  
Banyo



Indoor  
İç Mekan



Outdoor  
Dış Mekan



Commercial  
Ticari Alan



Wall  
Duvar



Floor  
Yer



Uniform  
Appearance  
Aynı Görünüm

100x300cm, 120x360cm and 160x320cm are rectified sizes.  
100x300cm, 120x360cm ve 160x320cm ebatlar karelenmiş ebatlardır.

Please check pages between 146-153 for dimension detail chart.

Ebat tablosu için 146-153 sayfaları arasına bakınız.

The use of polished products in areas with heavy pedestrian traffic is not recommended.  
Parlak ürünlerin yoğun yaya trafiği olan alanlarda kullanımı önerilmez.



## Cement

Çimento



**HUED ANTHRACITE**  
HUED ANTRASİT

	mm	Matte	Soft Matte	Polished	Satin
100x300 cm	3	•			
	5	•			
120x360 cm	3	•			
	5	•			
160x320 cm 162x323 cm	6				
	12				
	20				



**HIGHWAY BONE**  
HIGHWAY KEMİK

	mm	Matte	Soft Matte	Polished	Satin
100x300 cm	3				
	5				
120x360 cm	3	•			
	5				
160x320 cm 162x323 cm	6		•		
	12				
	20				

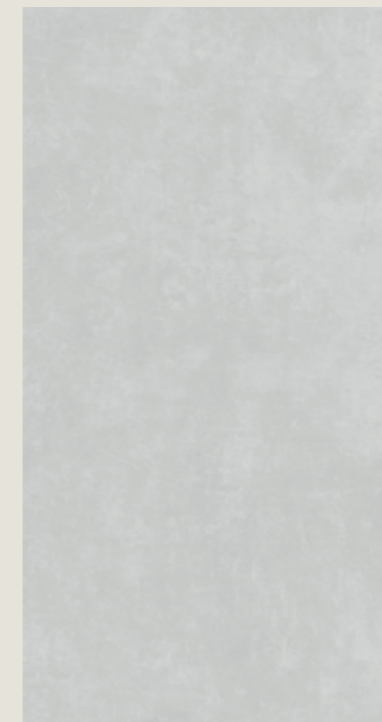

**ARCHE WHITE**  
ARCHE BEYAZ

	mm	Matte	Soft Matte	Polished	Satin
100x300 cm	3	•			
	5	•			
120x360 cm	3				
	5				
160x320 cm 162x323 cm	6				
	12				
	20				



**ARCHE GREY**  
ARCHE GRİ

	mm	Matte	Soft Matte	Polished	Satin
100x300 cm	3	•			
	5	•			
120x360 cm	3				
	5				
160x320 cm 162x323 cm	6				
	12				
	20				



Interior &  
Design  
İç Mekan &  
Tasarım



Facade  
Cephe



Kitchen  
Mutfak



Furniture  
Mobilya



Bathroom  
Banyo



Indoor  
İç Mekan



Outdoor  
Dış Mekan



Commercial  
Ticari Alan



Wall  
Duvar



Floor  
Yer



Slight  
Variation  
Hafif  
Farklılık

100x300cm, 120x360cm and 160x320cm are rectified sizes.  
100x300cm, 120x360cm ve 160x320cm ebatlar karelenmiş ebatlardır.

The use of polished products in areas with heavy pedestrian traffic is not recommended.  
Parlak ürünlerin yoğun yaya trafiği olan alanlarda kullanımı önerilmez.

Please check pages between 146-153 for dimension detail chart.

Ebat tablosu için 146-153 sayfaları arasına bakınız.



Interior &  
Design  
İç Mekan &  
Tasarım



Facade  
Cephe



Kitchen  
Mutfak



Furniture  
Mobilya



Bathroom  
Banyo



Indoor  
İç Mekan



Outdoor  
Dış Mekan



Commercial  
Ticari Alan



Wall  
Duvar



Floor  
Yer



Slight  
Variation  
Hafif  
Farklılık

100x300cm, 120x360cm and 160x320cm are rectified sizes.  
100x300cm, 120x360cm ve 160x320cm ebatlar karelenmiş ebatlardır.

The use of polished products in areas with heavy pedestrian traffic is not recommended.  
Parlak ürünlerin yoğun yaya trafiği olan alanlarda kullanımı önerilmez.

Please check pages between 146-153 for dimension detail chart.

Ebat tablosu için 146-153 sayfaları arasına bakınız.

## Cement

Çimento



**FACTORY BLACK**  
FACTORY SİYAH

	mm	Matte	Soft Matte	Polished	Satin
100x300 cm	3 5	•			
120x360 cm	3 5				
160x320 cm 162x323 cm	6 12 20				



**FACTORY GREIGE**

	mm	Matte	Soft Matte	Polished	Satin
100x300 cm	3 5	•			
120x360 cm	3 5				
160x320 cm 162x323 cm	6 12 20				



**FACTORY SILVER**  
FACTORY GÜMÜŞ

	mm	Matte	Soft Matte	Polished	Satin
100x300 cm	3 5	•			
120x360 cm	3 5				
160x320 cm 162x323 cm	6 12 20				



Interior &  
Design  
İç Mekan &  
Tasarım



Facade  
Cephe



Kitchen  
Mutfak



Furniture  
Mobilya



Bathroom  
Banyo



Indoor  
İç Mekan



Outdoor  
Dış Mekan



Commercial  
Ticari Alan



Wall  
Duvar



Floor  
Yer



Slight  
Variation  
Hafif  
Farklılık



Interior &  
Design  
İç Mekan &  
Tasarım



Facade  
Cephe



Kitchen  
Mutfak



Furniture  
Mobilya



Bathroom  
Banyo



Indoor  
İç Mekan



Outdoor  
Dış Mekan



Commercial  
Ticari Alan



Wall  
Duvar



Floor  
Yer



Slight  
Variation  
Hafif  
Farklılık

100x300cm, 120x360cm and 160x320cm are rectified sizes.  
100x300cm, 120x360cm ve 160x320cm ebatlar karelenmiş ebatlardır.

The use of polished products in areas with heavy pedestrian traffic is not recommended.  
Parlak ürünlerin yoğun yaya trafiği olan alanlarda kullanımı önerilmez.

Please check pages between 146-153 for dimension detail chart.

Ebat tablosu için 146-153 sayfaları arasına bakınız.

100x300cm, 120x360cm and 160x320cm are rectified sizes.  
100x300cm, 120x360cm ve 160x320cm ebatlar karelenmiş ebatlardır.

The use of polished products in areas with heavy pedestrian traffic is not recommended.  
Parlak ürünlerin yoğun yaya trafiği olan alanlarda kullanımı önerilmez.

Please check pages between 146-153 for dimension detail chart.

Ebat tablosu için 146-153 sayfaları arasına bakınız.



METAL LOOK  
*METAL GÖRÜNÜM*





## Metallic Look

*Metalik Görünüm*



METALLIC ANTHRACITE  
METALİK ANTRASİT



## Metallic

Metalik



**METALLIC ANTHRACITE**  
METALİK ANTRASİT

	mm	Matte	Soft Matte	Polished	Satin
100x300 cm	3 5	• •			
120x360 cm	3 5				
160x320 cm 162x323 cm	6 12 20		•		



**METALLIC CORAL**  
METALİK KIZIL

	mm	Matte	Soft Matte	Polished	Satin
100x300 cm	3 5	• •			
120x360 cm	3 5				
160x320 cm 162x323 cm	6 12 20				



**FERRO**

	mm	Matte	Soft Matte	Polished	Satin	Face
100x300 cm	3 5	• •				2F
120x360 cm	3 5	• •				
160x320 cm 162x323 cm	6 12 20					



**STEEL**

	mm	Matte	Soft Matte	Polished	Satin	Face
100x300 cm	3 5	• •				2F
120x360 cm	3 5	• •				
160x320 cm 162x323 cm	6 12 20					



**LEDER BROWN**  
LEDER KAHVE

	mm	Matte	Soft Matte	Polished	Satin
100x300 cm	3 5	•			
120x360 cm	3 5				
160x320 cm 162x323 cm	6 12 20				



Interior &  
Design  
İç Mekan &  
Tasarım



Facade  
Cephe



Kitchen  
Mutfak



Furniture  
Mobilya



Bathroom  
Banyo



Indoor  
İç Mekan



Outdoor  
Dış Mekan



Commercial  
Ticari Alan



Wall  
Duvar



Floor  
Yer



Slight  
Variation  
Hafif  
Farklılık



Interior &  
Design  
İç Mekan &  
Tasarım



Facade  
Cephe



Kitchen  
Mutfak



Furniture  
Mobilya



Bathroom  
Banyo



Indoor  
Konut



Outdoor  
Dış Mekan



Commercial  
Ticari Alan



Gleaming  
Parıltı



Wall  
Duvar



Floor  
Yer



Moderate  
Variation  
Önemli  
Farklılık



Indicates the  
number of faces  
Yüzey sayısı  
gösterir

100x300cm, 120x360cm and 160x320cm are rectified sizes.  
100x300cm, 120x360cm ve 160x320cm ebatlar karelenmiş ebatlardır.

Please check pages between 146-153 for dimension detail chart.

Ebat tablosu için 146-153 sayfaları arasına bakınız.

The use of polished products in areas with heavy pedestrian traffic is not recommended.  
Parlak ürünlerin yoğun yaya trafiği olan alanlarda kullanımı önerilmez.

100x300cm, 120x360cm and 160x320cm are rectified sizes.  
100x300cm, 120x360cm ve 160x320cm ebatlar karelenmiş ebatlardır.

Please check pages between 146-153 for dimension detail chart.

Ebat tablosu için 146-153 sayfaları arasına bakınız.

The use of polished products in areas with heavy pedestrian traffic is not recommended.  
Parlak ürünlerin yoğun yaya trafiği olan alanlarda kullanımı önerilmez.

## Metallic

Metalik

new  
yeni

RUSTONE

	mm	Matte	Soft Matte	Polished	Satin	Face
100x300 cm	3 5					
120x360 cm	3 5					
160x320 cm 162x323 cm	6 12 20		•			3F

new  
yeni

CORTEN

	mm	Matte	Soft Matte	Polished	Satin	Face
100x300 cm	3 5					
120x360 cm	3 5					
160x320 cm 162x323 cm	6 12 20		•			2F

DECO  
TECHInterior &  
Design  
İç Mekan &  
TasarımFacade  
CepheKitchen  
MutfakFurniture  
MobilyaBathroom  
BanyoIndoor  
KonutOutdoor  
Dış  
MekanCommercial  
Ticari AlanGleaming  
ParıltılıWall  
DuvarFloor  
YerModerate  
Variation  
Önemli  
FarklılıkIndicates the  
number of faces  
Yüzey sayısını  
gösterir

100x300cm, 120x360cm and 160x320cm are rectified sizes.  
100x300cm, 120x360cm ve 160x320cm ebatlar karelenmiş ebatlardır.

The use of polished products in areas with heavy pedestrian traffic is not recommended.  
Parlak ürünlerin yoğun yaya trafiği olan alanlarda kullanımı önerilmez.

Please check pages between 146-153 for dimension detail chart.

Ebat tablosu için 146-153 sayfaları arasına bakınız.





# ARTWALL

ARTWALL





## Floral

Floral

new  
yeni

BLUE BLOSSOMS

	mm	Matte	Soft Matte	Polished	Satin
100x300 cm	3 5				
120x360 cm	3 5				
160x320 cm	6		•		
162x323 cm	12 20				

DECO  
TECHInterior &  
Design  
İç Mekan &  
TasarımFacade  
CepheKitchen  
MutfakFurniture  
MobilyaBathroom  
BanyoIndoor  
İç MekanOutdoor  
Dış MekanCommercial  
Ticari AlanWall  
DuvarFloor  
YerUniform  
Appearance  
Aynı Görünüm

100x300cm, 120x360cm and 160x320cm are rectified sizes.  
100x300cm, 120x360cm ve 160x320cm ebatlar karelenmiş ebatlardır.

The use of polished products in areas with heavy pedestrian traffic is not recommended.  
Parlak ürünlerin yoğun yaya trafiği olan alanlarda kullanımı önerilmez.

Please check pages between 146-153 for dimension detail chart.

Ebat tablosu için 146-153 sayfaları arasına bakınız.



## Floral

Floral

new  
yeni

JASMINE

	mm	Matte	Soft Matte	Polished	Satin
100x300 cm	3 5				
120x360 cm	3 5				
160x320 cm	6		•		
162x323 cm	12 20				

DECO  
TECHInterior &  
Design  
İç Mekan &  
TasarımFacade  
CepheKitchen  
MutfakFurniture  
MobilyaBathroom  
BanyoIndoor  
İç MekanOutdoor  
Dış MekanCommercial  
Ticari AlanWall  
DuvarFloor  
YerUniform  
Appearance  
Aynı Görünüm

100x300cm, 120x360cm and 160x320cm are rectified sizes.  
100x300cm, 120x360cm ve 160x320cm ebatlar karelenmiş ebatlardır.

The use of polished products in areas with heavy pedestrian traffic is not recommended.  
Parlak ürünlerin yoğun yaya trafiği olan alanlarda kullanımı önerilmez.

Please check pages between 146-153 for dimension detail chart.

Ebat tablosu için 146-153 sayfaları arasına bakınız.



## Geometric

Geometrik



new  
yeni



LACE

	mm	Matte	Soft Matte	Polished	Satin
100x300 cm	3				
	5				
120x360 cm	3				
	5				
160x320 cm	6		•		
	12				
162x323 cm	20				

DECO  
TECH



Interior &  
Design  
İç Mekan &  
Tasarım



Facade  
Cephe



Kitchen  
Mutfak



Furniture  
Mobilya



Bathroom  
Banyo



Indoor  
İç Mekan



Outdoor  
Dış Mekan



Commercial  
Ticari Alan



Wall  
Duvar



Floor  
Yer



Uniform  
Appearance  
Aynı Görünüm

100x300cm, 120x360cm and 160x320cm are rectified sizes.  
100x300cm, 120x360cm ve 160x320cm ebatlar karelenmiş ebatlardır.

The use of polished products in areas with heavy pedestrian traffic is not recommended.  
Parlak ürünlerin yoğun yaya trafiği olan alanlarda kullanımı önerilmez.

Please check pages between 146-153 for dimension detail chart.

Ebat tablosu için 146-153 sayfaları arasına bakınız.



## Geometric

Geometrik



new  
yeni



MOONDUST

	mm	Matte	Soft Matte	Polished	Satin
100x300 cm	3				
	5				
120x360 cm	3				
	5				
160x320 cm	6		•		3F
	12				
162x323 cm	20				

DECO  
TECH



Interior &  
Design  
İç Mekan &  
Tasarım



Facade  
Cephe



Kitchen  
Mutfak



Furniture  
Mobilya



Bathroom  
Banyo



Indoor  
İç Mekan



Outdoor  
Dış Mekan



Commercial  
Ticari Alan



Wall  
Duvar



Floor  
Yer



V3  
Moderate  
Variation

Önemli  
Farklılık

100x300cm, 120x360cm and 160x320cm are rectified sizes.

100x300cm, 120x360cm ve 160x320cm ebatlar karelenmiş ebatlardır.

The use of polished products in areas with heavy pedestrian traffic is not recommended.

Parlak ürünlerin yoğun yaya trafiği olan alanlarda kullanımı önerilmez.

Please check pages between 146-153 for dimension detail chart.

Ebat tablosu için 146-153 sayfaları arasına bakınız.

**SOLID COLORS**  
*DÜZ RENKLER*





## Solid Colors

*Düz Renkler*



## Solid Colors

*Düz Renkler*

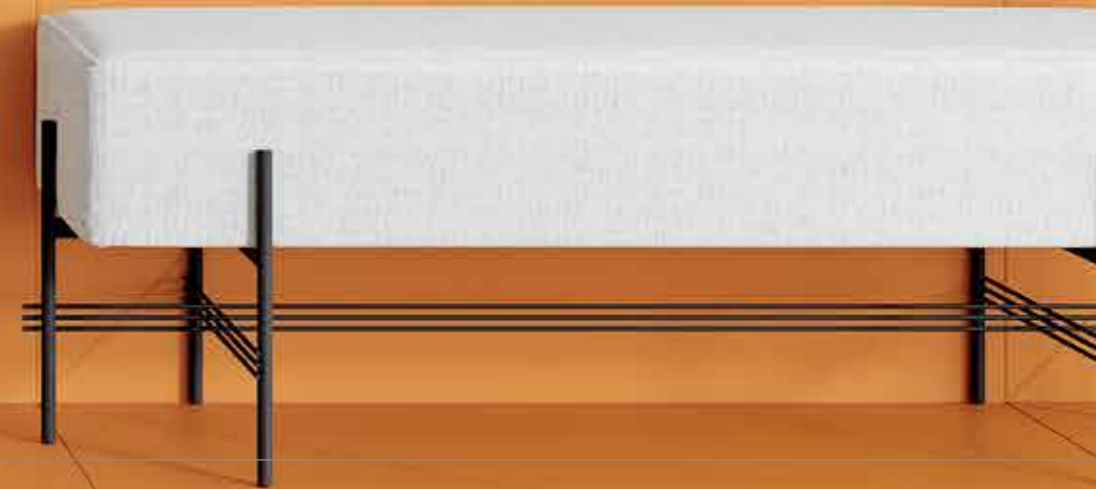



## Solid Colors

### Düz Renkler



**INNOVATION EXTRA WHITE**  
INNOVATION EXTRA BEYAZ

	mm	Matte	Soft Matte	Polished	Satin
100x300 cm	3	•			
	5	•			
120x360 cm	3	•			
	5	•			
160x320 cm 162x323 cm	6		•	•	
	12				
	20				

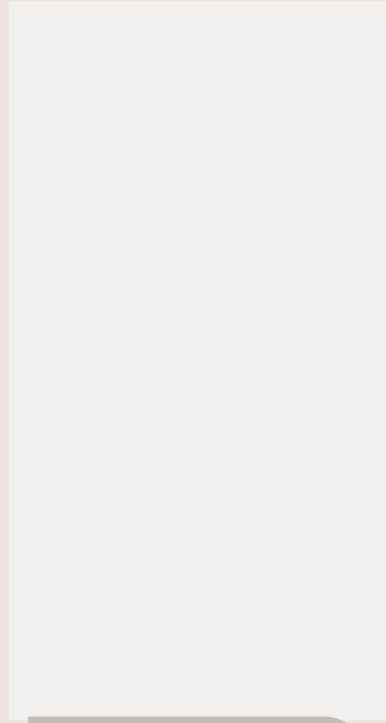

**INNOVATION WHITE 2.0**  
INNOVATION BEYAZ 2.0

	mm	Matte	Soft Matte	Polished	Satin
100x300 cm	3	•			
	5	•			
120x360 cm	3	•			
	5	•			
160x320 cm 162x323 cm	6		•		
	12		•		
	20				



**INNOVATION BEIGE**  
INNOVATION BEJ

	mm	Matte	Soft Matte	Polished	Satin
100x300 cm	3	•			
	5	•			
120x360 cm	3	•			
	5	•			
160x320 cm 162x323 cm	6				
	12				
	20				



**INNOVATION BEIGE-GREY**  
INNOVATION BEJ-GRİ

	mm	Matte	Soft Matte	Polished	Satin
100x300 cm	3	•			
	5	•			
120x360 cm	3	•			
	5	•			
160x320 cm 162x323 cm	6				
	12				
	20				



**INNOVATION CEMENT GREY**  
INNOVATION ÇİMENTO GRİ

	mm	Matte	Soft Matte	Polished	Satin
100x300 cm	3	•			
	5	•			
120x360 cm	3				
	5				
160x320 cm 162x323 cm	6				
	12				
	20				



**INNOVATION PISTACHIO GREEN**  
INNOVATION FISTIK YEŞİLİ

	mm	Matte	Soft Matte	Polished	Satin
100x300 cm	3	•			
	5	•			
120x360 cm	3				
	5				
160x320 cm 162x323 cm	6				
	12				
	20				



Interior & Design  
İç Mekan & Tasarım



Facade  
Cephe



Kitchen  
Mutfak



Furniture  
Mobilya



Bathroom  
Banyo



Indoor  
İç Mekan



Outdoor  
Dış Mekan



Commercial  
Ticari Alan



Wall  
Duvar



Floor  
Yer



Uniform  
Appearance  
Aynı Görünüm

100x300cm, 120x360cm and 160x320cm are rectified sizes.  
100x300cm, 120x360cm ve 160x320cm ebatlar karelenmiş ebatlardır.

Please check pages between 146-153 for dimension detail chart.

Ebat tablosu için 146-153 sayfaları arasına bakınız.

The use of polished products in areas with heavy pedestrian traffic is not recommended.  
Parlak ürünlerin yoğun yaya trafiği olan alanlarda kullanımı önerilmez.



Interior & Design  
İç Mekan & Tasarım



Facade  
Cephe



Kitchen  
Mutfak



Furniture  
Mobilya



Bathroom  
Banyo



Indoor  
İç Mekan



Outdoor  
Dış Mekan



Commercial  
Ticari Alan



Wall  
Duvar



Uniform  
Appearance  
Aynı Görünüm

100x300cm, 120x360cm and 160x320cm are rectified sizes.  
100x300cm, 120x360cm ve 160x320cm ebatlar karelenmiş ebatlardır.

Please check pages between 146-153 for dimension detail chart.

Ebat tablosu için 146-153 sayfaları arasına bakınız.

The use of polished products in areas with heavy pedestrian traffic is not recommended.  
Parlak ürünlerin yoğun yaya trafiği olan alanlarda kullanımı önerilmez.

## Solid Colors

Düz Renkler

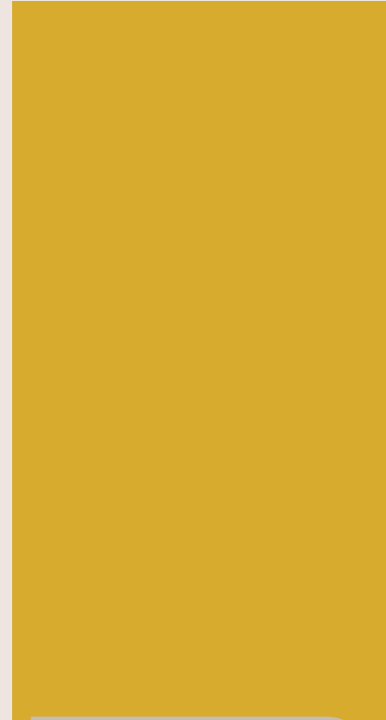

INNOVATION ORANGE  
INNOVATION TURUNCU

	mm	Matte	Soft Matte	Polished	Satin
100x300 cm	3 5	•			
120x360 cm	3 5				
160x320 cm 162x323 cm	6 12 20				



INNOVATION CORAL  
INNOVATION KIZIL

	mm	Matte	Soft Matte	Polished	Satin
100x300 cm	3 5	•			
120x360 cm	3 5				
160x320 cm 162x323 cm	6 12 20				



INNOVATION BLUE  
INNOVATION MAVİ

	mm	Matte	Soft Matte	Polished	Satin
100x300 cm	3 5	•			
120x360 cm	3 5				
160x320 cm 162x323 cm	6 12 20				



Interior &  
Design  
İç Mekan &  
Tasarım



Facade  
Cephe



Kitchen  
Mutfak



Furniture  
Mobilya



Bathroom  
Banyo



Indoor  
İç Mekan



Outdoor  
Dış Mekan



Commercial  
Ticari Alan



Wall  
Duvar



Uniform  
Appearance  
Aynı Görünüm



Interior &  
Design  
İç Mekan &  
Tasarım



Facade  
Cephe



Kitchen  
Mutfak



Furniture  
Mobilya



Bathroom  
Banyo



Indoor  
İç Mekan



Outdoor  
Dış Mekan



Commercial  
Ticari Alan



Wall  
Duvar



Uniform  
Appearance  
Aynı Görünüm

100x300cm, 120x360cm and 160x320cm are rectified sizes.  
100x300cm, 120x360cm ve 160x320cm ebatlar karelenmiş ebatlardır.

The use of polished products in areas with heavy pedestrian traffic is not recommended.  
Parlak ürünlerin yoğun yaya trafiği olan alanlarda kullanımı önerilmez.

Please check pages between 146-153 for dimension detail chart.

Ebat tablosu için 146-153 sayfaları arasına bakınız.

100x300cm, 120x360cm and 160x320cm are rectified sizes.  
100x300cm, 120x360cm ve 160x320cm ebatlar karelenmiş ebatlardır.

The use of polished products in areas with heavy pedestrian traffic is not recommended.  
Parlak ürünlerin yoğun yaya trafiği olan alanlarda kullanımı önerilmez.

Please check pages between 146-153 for dimension detail chart.

Ebat tablosu için 146-153 sayfaları arasına bakınız.



## Solid Colors

### Düz Renkler



**INNOVATION BROWN**  
INNOVATION KAHRERENGİ

	mm	Matte	Soft Matte	Polished	Satin
100x300 cm	3 5	•			
120x360 cm	3 5				
160x320 cm 162x323 cm	6 12 20				



**INNOVATION DARK GREY**  
INNOVATION KOYU GRİ

	mm	Matte	Soft Matte	Polished	Satin
100x300 cm	3 5	•			
120x360 cm	3 5				
160x320 cm 162x323 cm	6 12 20				



**INNOVATION BLACK**  
INNOVATION SİYAH

	mm	Matte	Soft Matte	Polished	Satin
100x300 cm	3 5	•			
120x360 cm	3 5	•			
160x320 cm 162x323 cm	6 12 20		•		

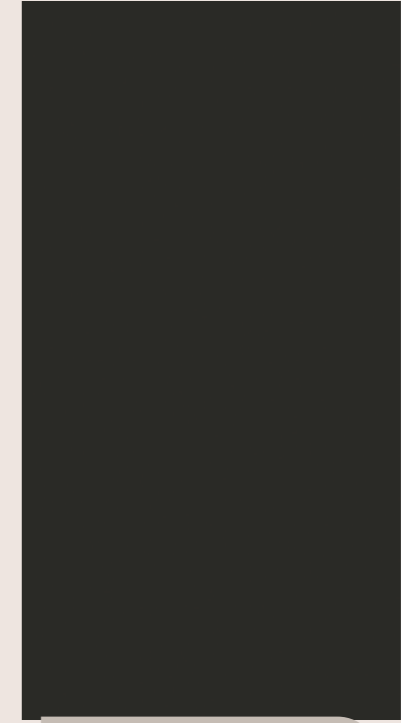

**INNOVATION MEGA BLACK**  
INNOVATION MEGA SİYAH

	mm	Matte	Soft Matte	Polished	Satin
100x300 cm	3 5	•			
120x360 cm	3 5	•			
160x320 cm 162x323 cm	6 12 20		•	•	



Interior &  
Design  
İç Mekan &  
Tasarım



Facade  
Cephe



Kitchen  
Mutfak



Furniture  
Mobilya



Bathroom  
Banyo



Indoor  
İç Mekan



Outdoor  
Dış Mekan



Commercial  
Ticari Alan



Wall  
Duvar



Uniform  
Appearance  
Aynı Görünüm



Interior &  
Design  
İç Mekan &  
Tasarım



Facade  
Cephe



Kitchen  
Mutfak



Furniture  
Mobilya



Bathroom  
Banyo



Indoor  
İç Mekan



Outdoor  
Dış Mekan



Commercial  
Ticari Alan



Wall  
Duvar



Floor  
Yer



Slight  
Variation  
Hafif  
Farklılık

100x300cm, 120x360cm and 160x320cm are rectified sizes.  
100x300cm, 120x360cm ve 160x320cm ebatlar karelenmiş ebatlardır.

Please check pages between 146-153 for dimension detail chart.

Ebat tablosu için 146-153 sayfaları arasına bakınız.

The use of polished products in areas with heavy pedestrian traffic is not recommended.  
Parlak ürünlerin yoğun yaya trafiği olan alanlarda kullanımı önerilmez.

100x300cm, 120x360cm and 160x320cm are rectified sizes.  
100x300cm, 120x360cm ve 160x320cm ebatlar karelenmiş ebatlardır.

Please check pages between 146-153 for dimension detail chart.

Ebat tablosu için 146-153 sayfaları arasına bakınız.

The use of polished products in areas with heavy pedestrian traffic is not recommended.  
Parlak ürünlerin yoğun yaya trafiği olan alanlarda kullanımı önerilmez.

WOOD LOOK  
AHŞAP GÖRÜNÜM





## Wood Look

Ahşap Görünüm



CALACATTA UNIQUE  
WOODLINE OAK  
WOODLINE MEŞE

## Wood

## Ahşap



**HOLLYWOOD BEIGE**  
HOLLYWOOD BEJ

	mm	Matte	Soft Matte	Polished	Satin
100x300 cm	3 5	•			
120x360 cm	3 5	•			
160x320 cm 162x323 cm	6 12 20				



**HOLLYWOOD BROWN**  
HOLLYWOOD KAHVE

	mm	Matte	Soft Matte	Polished	Satin
100x300 cm	3 5				
120x360 cm	3 5	•			
160x320 cm 162x323 cm	6 12 20	•			



**WOODLINE WALNUT**  
WOODLINE CEVİZ

	mm	Matte	Soft Matte	Polished	Satin
100x300 cm	3 5	•			
120x360 cm	3 5				
160x320 cm 162x323 cm	6 12 20				



**WOODLINE CHERRY**  
WOODLINE KİRAZ

	mm	Matte	Soft Matte	Polished	Satin
100x300 cm	3 5	•			
120x360 cm	3 5				
160x320 cm 162x323 cm	6 12 20				



**WOODLINE OAK**  
WOODLINE MEŞE

	mm	Matte	Soft Matte	Polished	Satin
100x300 cm	3 5	•			
120x360 cm	3 5				
160x320 cm 162x323 cm	6 12 20				



Interior &  
Design  
İç Mekan &  
Tasarım



Facade  
Cephe



Kitchen  
Mutfak



Furniture  
Mobilya



Bathroom  
Banyo



Indoor  
Konut



Outdoor  
Dış Mekan



Commercial  
Ticari Alan



Gleaming  
Parıltılı



Wall  
Duvar



Floor  
Yer



Slight  
Variation  
Hafif Farklılık



Indicates the  
number of faces  
Yüzey sayısını  
gösterir



Interior &  
Design  
İç Mekan &  
Tasarım



Facade  
Cephe



Kitchen  
Mutfak



Furniture  
Mobilya



Bathroom  
Banyo



Indoor  
İç Mekan



Outdoor  
Dış Mekan



Commercial  
Ticari Alan



Wall  
Duvar



Floor  
Yer



Slight  
Variation  
Hafif Farklılık

100x300cm, 120x360cm and 160x320cm are rectified sizes.  
100x300cm, 120x360cm ve 160x320cm ebatlar karelenmiş ebatlardır.

Please check pages between 146-153 for dimension detail chart.

Ebat tablosu için 146-153 sayfaları arasına bakınız.

The use of polished products in areas with heavy pedestrian traffic is not recommended.  
Parlak ürünlerin yoğun yaya trafiği olan alanlarda kullanımı önerilmez.

100x300cm, 120x360cm and 160x320cm are rectified sizes.  
100x300cm, 120x360cm ve 160x320cm ebatlar karelenmiş ebatlardır.

Please check pages between 146-153 for dimension detail chart.

Ebat tablosu için 146-153 sayfaları arasına bakınız.

The use of polished products in areas with heavy pedestrian traffic is not recommended.  
Parlak ürünlerin yoğun yaya trafiği olan alanlarda kullanımı önerilmez.



## Wood

## Ahşap



PLANK 104

	mm	Matte	Soft Matte	Polished	Satin
100x300 cm	3 5	•			
120x360 cm	3 5				
160x320 cm 162x323 cm	6 12 20				



PLANK 110

	mm	Matte	Soft Matte	Polished	Satin
100x300 cm	3 5	•			
120x360 cm	3 5				
160x320 cm 162x323 cm	6 12 20				



PLANK 111

	mm	Matte	Soft Matte	Polished	Satin
100x300 cm	3 5	•			
120x360 cm	3 5				
160x320 cm 162x323 cm	6 12 20				



PLANK 114

	mm	Matte	Soft Matte	Polished	Satin
100x300 cm	3 5	•			
120x360 cm	3 5				
160x320 cm 162x323 cm	6 12 20				



SHELL WOOD DARK

	mm	Matte	Soft Matte	Polished	Satin
100x300 cm	3 5	•			
120x360 cm	3 5	•			
160x320 cm 162x323 cm	6 12 20				



Interior &  
Design  
İç Mekan &  
Tasarım



Facade  
Cephe



Kitchen  
Mutfak



Furniture  
Mobilya



Bathroom  
Banyo



Indoor  
İç Mekan



Outdoor  
Dış Mekan



Commercial  
Ticari Alan



Wall  
Duvar



Floor  
Yer



Slight  
Variation  
Hafif  
Farklılık

100x300cm, 120x360cm and 160x320cm are rectified sizes.  
100x300cm, 120x360cm ve 160x320cm ebatlar karelenmiş ebatlardır.

The use of polished products in areas with heavy pedestrian traffic is not recommended.  
Parlak ürünlerin yoğun yaya trafiği olan alanlarda kullanımı önerilmez.

Please check pages between 146-153 for dimension detail chart.

Ebat tablosu için 146-153 sayfaları arasına bakınız.



Interior &  
Design  
İç Mekan &  
Tasarım



Facade  
Cephe



Kitchen  
Mutfak



Furniture  
Mobilya



Bathroom  
Banyo



Indoor  
İç Mekan



Outdoor  
Dış Mekan



Commercial  
Ticari Alan



Wall  
Duvar



Floor  
Yer



Slight  
Variation  
Hafif  
Farklılık

100x300cm, 120x360cm and 160x320cm are rectified sizes.  
100x300cm, 120x360cm ve 160x320cm ebatlar karelenmiş ebatlardır.

The use of polished products in areas with heavy pedestrian traffic is not recommended.  
Parlak ürünlerin yoğun yaya trafiği olan alanlarda kullanımı önerilmez.

Please check pages between 146-153 for dimension detail chart.

Ebat tablosu için 146-153 sayfaları arasına bakınız.





Kalesinterflex perfectly reproduces the excellence and richness of colors and textures, along with the veining and shading of marble, natural stone and the most innovative designer materials, to create alluring atmospheres/environments.

A unique, seamless material that remains unchanged over time, suitable for indoor and outdoor spaces and ideal for surfaces that require optimum hygiene, durability and aesthetic harmony.

Offering superb freedom to mix and match, Kalesinterflex surfaces create habitats with unique style and elegance.

*Kalesinterflex, mükemmel bir şekilde renklerin ve dokuların zenginliğini, mermer, doğal taş ve en yenilikçi tasarımcı malzemelerin damarlarını ve tonlarını mükemmel bir şekilde yeniden üretiyor ve büyüleyici atmosferler/yerler yaratıyor.*

*Zaman içinde değişmeden kalan, iç ve dış mekanlar için uygun ve optimum hijyen, dayanıklılık ve estetik uyum gerektiren yüzeyler için ideal olan benzersiz, dikişsiz bir malzeme.*

*Karıştırma ve eşleştirme konusunda üstün özgürlük sunan Kalesinterflex yüzeyler, benzersiz stil ve zarafete sahip yaşam alanları yaratır.*

*Boyutlar değişir, kalite değişmez.*

120x360cm / 48"x144"

100x300cm / 40"x120"

160x320cm / 62.99" x 125.98"

Dimensions change,  
**but quality remains the same.**



## Features / Özellikler

Everything that must be in a ceramic tile and more... Designed to shape the architecture of the future, Kalesinterflex is equipped with superior features to ensure flawless performance under any condition.

Bir seramikte olması gereken her şey ve daha fazlası... Geleceğin mimarisini şekillendirmek için tasarlanan Kalesinterflex, her koşulda kusursuz performans göstermesi için üstün özelliklerle donatıldı.

### WEIGHT\*

A 3mm-thick Kalesinterflex slab weighs 7kg/sqm while a 5mm-thick Kalesinterflex slab weighs 11.5kg/sqm.



### AĞIRLIK\*

3mm kalınlığındaki bir Kalesinterflex porselen plaka 7kg/m<sup>2</sup>, 5mm kalınlığındaki bir Kalesinterflex porselen plaka 11,5kg/m<sup>2</sup> ağırlığındadır.

### FLEXIBILITY

The convex flexibility radius of a 3mm-thick Kalesinterflex Fit slab is 5.5m.



### ESNEKLİK

3mm kalınlığındaki Kalesinterflex Fit porselen plaka dışbükey esneklik yarıçapı 5.5m'dir.

### NON-FLAMMABLE (FLAME RESISTANT)

Kalesinterflex is totally fire resistant and non-flammable.



### YANMAZ (ALEVE DAYANIKLI)

Kalesinterflex ateşe tamamen dayanıklı, alev almaz ve yanmaz niteliktedir.

### CHEMICAL RESISTANCE

Kalesinterflex is resistant to chemicals (acids and bases) due to its porcelain ceramic structure and glaze layer on its surface.



### KİMYASALLARA DAYANIKLILIK

Kalesinterflex yüzeyindeki koruyucu sır tabakası ve porselen yapısı sayesinde en güçlü kimyasallara (asitlere ve bazlara) karşı dayanıklıdır.

### CUTTING

It can be cut with standard glass, ceramic cutters and computer controlled automatic cutting machines in the required dimensions.



### KESME

Kalesinterflex, standart cam ve seramik kesicileri ve bilgisayar kontrollü otomatik kesme ve delme makineleri ile istenen boyutlarda kesilebilir.

### DRILLING

Kalesinterflex can be drilled with glass drills as well as with other automatic drilling devices.



### DELME

Kalesinterflex, cam ya da benzer malzemeler için kullanılan alet ve matkaplar ile delinebileceği gibi diğer bilinen otomatik aletlerle de delinebilir.

### HIGH HEAT AND FROST RESISTANCE

Kalesinterflex's surface is equipped with advanced technology to accommodate various climate conditions. It maintains its durability against sudden changes in heat and frost.



### YÜKSEK SICAKLIĞA VE SOĞUĞA DAYANMA DİRENCİ

Kalesinterflex'in üstün teknolojiyle donatılan yüzeyi farklı iklim koşullarına uygun olarak tasarlanmıştır. Ani ısı değişikliklerine ve dona karşı sağlamlığını korur.

### EASE OF CLEANING

Kalesinterflex has a smooth surface on which dirt does not accumulate. If required it can be cleaned with water and known cleaning agents.

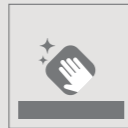

### TEMİZLEME

Kalesinterflex'in düzgün yüzeyi kir tutmayan bir yapıya sahiptir. Gerektiği takdirde su ve bilinen temizlik ürünleri ile kolayca temizlenebilir, lekelenmez.

\*The specified weights reflect average values and may vary depending on the product.

\*Belirtilen rakamlar ortama değerlerdir. Farklı ürünlerde değişiklik gösterebilir.

### ANTI-GRAFFITI

Easy to wipe and clean pollutants like crayon, graffiti, permanent marker, board marker.



### ANTI-GRAFİTİ

Boya kalem, keçeli kalem ve tahta kalem yazılan kolayca silinir ve temizlenir.

### PHOTOCATALYTIC

Kalesinterflex is photocatalytic thanks to its Nano-tech coating surface. Kalesinterflex cleans itself with rain and sunlight.



### FOTOKATALİTİK

Kalesinterflex Nano Kompozit yüzey özelliği sayesinde fotokataliktir. Leke tutmaz, yağmur ve güneş ışığı sayesinde lekeler temizlenir.

### HYGIENIC

Protects both outdoor and indoor, even in poorly lit environment. Hygienic; resistant to bacteria, mould and fungus. The antibacterial feature of Kalesinterflex is approved by TÜBİTAK. (The Scientific and Technological Research Council of Turkey)



### HİJYENİK

Yetersiz aydınlatmaya sahip ortamlarda dahi hem iç mekanları hem de dış mekanları bakterilerden korur. Hijyeniktir; bakterilere, küfe ve mantara karşı dayanıklıdır. Kalesinterflex Antibakteriyel Ürün Güvencesi TÜBİTAK tarafından onaylıdır.

### ECO-FRIENDLY

Produced with an environmentally-friendly technology, Kalesinterflex has Ecospecifier certificate. Compared to the traditional ceramic production process, its gas and dust emission is 20 times, its CO2 emission is 1000 times less.



### ÇEVRE DOSTU

Çevreye duyarlı bir teknoloji ile üretilen Kalesinterflex, Ecospecifier belgesine sahiptir. Geleneksel seramik üretim süreçleriyle karşılaştırıldığında gaz ve toz emisyonu 20 kat, CO2 emisyonu ise 1000 kat daha azdır.

### HIGH STAIN RESISTANCE



### YÜKSEK LEKE DİRENCİ

### HIGH ABRASION RESISTANCE



### YÜKSEK AŞINMA DİRENCİ

### HIGH RESISTANCE TO UV RAYS



### UV IŞINLARINA YÜKSEK DİRENCİ

### LOW WATER ABSORPTION (NEAR ZERO)



### DÜŞÜK SU EMMELİ (0'A YAKIN)

### EVERLASTING



### UZUN ÖMÜRLÜ

### HIGH SCRATCH RESISTANCE



### YÜKSEK ÇİZİLME DİRENCİ



# Kaleguard

*We use science and technology for human health.  
The health of you and your loved ones are under protection  
thanks to Kaleguard Surface Protection Technology.*

Bilim ve teknolojiyi insan sağlığı için kullanıyoruz.  
Kaleguard Yüzey Koruma Teknolojisi ile sizin ve sevdiklerinizin  
sağlığı koruma altında.

*We equip ceramic surfaces with superior  
protection with Kaleguard technology which  
is developed for the first time in the world.*

Dünyada sadece Kale'de bulunan Kaleguard  
teknolojisiyle, seramik yüzeyleri üstün koruma  
özelliliyle donatıyoruz.

## 3 SUPERIOR FEATURES DESIGNED FOR LIVING SPACES!

YAŞAM ALANLARI İÇİN TASARLANAN  
3 ÜSTÜN ÖZELLİK!

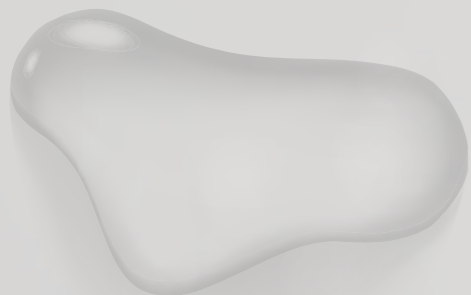

**Effective protection against bacteria!**  
Bakterilere karşı etkili koruma!

*Preventing the formation of bacteria mold,  
fungus and bacteria; Kaleguard technology offers  
maximum hygiene everywhere. It protects your  
health in many living areas open to public use  
such as homes, hotels, hospitals, shopping malls,  
poolside and schools.*

Küf, mantar ve bakteri oluşumunu önleyen  
Kaleguard teknolojisi, her yerde maksimum hijyen  
sunuyor. Ev, otel, hastane, alışveriş merkezi, havuz  
kenarı ve okul gibi toplu kullanıma açık birçok  
yaşam alanında sağlığınıza koruyor.

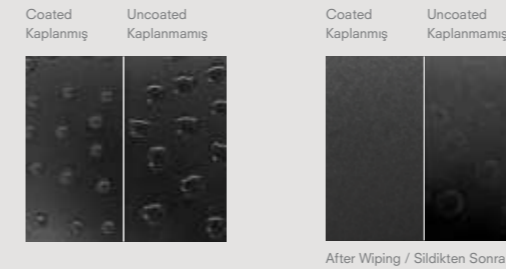

**More easily cleanable eco-friendly surfaces!**  
Daha rahat temizlenen çevreci yüzeyler!

*Providing water and oil repellency to ceramic surfaces; Kaleguard technology creates a healthy environment in wet  
spaces such as bathrooms and kitchens. Protecting the environment, Kaleguard technology offers a comfortable  
and easy cleaning experience since less water and cleaning materials are used compared to standard surfaces.*

Seramik yüzeylere su ve yağ iticilik özelliği kazandıran Kaleguard teknolojisi; banyo ve mutfak gibi ıslak hacimli  
mekanlarda sağlıklı bir ortam oluşturuyor. Standart yüzeylere göre daha az su ve temizlik malzemesi kullanıldığı için  
çevreyi koruyan Kaleguard teknolojisi, rahat ve yormayan bir temizlik deneyimi sunuyor.

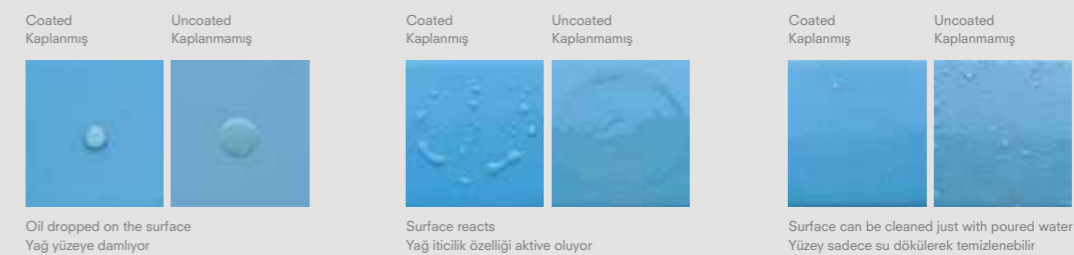

**Self-cleaning hygienic ceramics!**  
Kendi kendini temizleyen hijyenik seramikler!

*Stains and dirt caused by different environmental  
effects cannot hold on to ceramic surfaces thanks  
to Kaleguard technology. While providing a clean  
appearance indoors and outdoors, it designs healthy  
living spaces with its unique technology.*

Farklı çevresel etkilerle oluşacak leke ve kirlere Kaleguard  
teknolojisi ile seramik yüzeylerde tutunmıyor. İç ve dış  
mekanlarda temiz bir görünüm sağlarken, benzersiz  
teknolojisiyle sağlıklı yaşam alanları tasarlıyor.

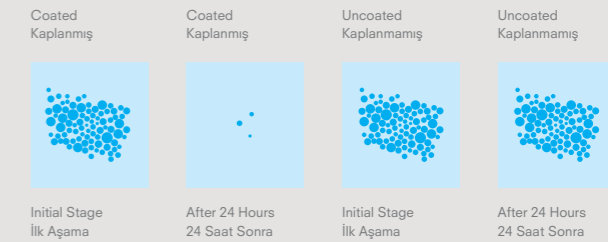





# Kaleguard

DEFENCE

## VIRUSES HAVE NO PLACE IN YOUR LIVING SPACE THANKS TO KALEGUARD DEFENCE!

Kaleguard Defence ile virüslerin yaşam alanınızda yeri yok!



*Kalebodur products; which keep the spaces alive with functional products and inspire with unique ceramic collections; offer you and your loved ones a healthy life with antimicrobials.*

Fonksiyonel ürünlerle mekanları yaşatan, eşsiz seramik koleksiyonlarıyla ilham veren yapılarda yer alan Kalebodur ürünleri, antimikrobiyal ile size ve sevdiğinizlere sağlıklı bir hayat sunuyor.



*Healthy living spaces in all parts of life!*

*With Kaleguard Defence, there is no virus and bacteria; there is healthy and comfortable life. You can safely touch ceramic surfaces with Kaleguard Defence; guaranteed and certified by national and international organisations.*

Hayatın her yerinde sağlıklı yaşam alanları!

Kaleguard Defence ile virüs ve bakteri yok, sağlıklı ve konforlu bir hayat var. Ulusal ve uluslararası kuruluşlarca onaylanan Kaleguard Defence güvencesiyle, seramik yüzeylere güvenle dokunun.



Kitchen / Mutfak



Bathroom / Banyo



Living Room / Salon



Airport / Havalimanı



Shopping Mall / AVM



Hospital / Hastane



Hotel / Otel



School / Okul



Pool & SPA / Havuz & SPA



Gym / Spor Salonu

*Thanks to Kaleguard assurance, there is hygiene and health on the surfaces you contact. Kaleguard güvencesiyle, temas ettiğiniz yüzeylerde hijyen ve sağlık var.*

### Superior features that protect your health! Sağlığınızı koruyan üstün özellikler!



**Kaleguard Defence Protection**  
Provides effective protection against viruses and bacteria.

**Kaleguard Defence Koruma**  
Virüs ve bakterilere karşı etkin koruma sağlar.



**Environment-friendly**  
It has no harmful effect on the environment.

**Çevre Dostu**  
Çevreye zararlı bir etkisi yoktur.



**Chemical Resistance**  
It has chemical resistance. It does not corrode due to cleaners.

**Kimyasal Dayanım**  
Kimyasal dirence sahiptir. Temizleyiciler ile aşınmaz.



**Hygienic**  
It has stain resistance. In this way, surfaces can be cleaned easily.

**Hijyenik**  
Lekelenme direncine sahiptir. Bu sayede yüzeyler kolay temizlenebilir.



**Invisible Surface Application**  
Since it can be applied very thin, the aesthetic properties of the product do not deform.

**Görünmez Yüzey Uygulaması**  
Çok ince uygulanabildiği için ürünün estetik özellikleri bozulmaz.



**Long-lasting**  
It preserves its antimicrobial features for 2 years in wall and floor applications.

**Uzun Ömürlü**  
Duvar ve zemin uygulamalarında 2 yıl antimikrobiyal özelliğini korur.



# Services

## Hizmetler

Houses, offices, shopping malls, and airports... We see all of them as meeting points where we touch life. We carry the care we take while producing our designs to product applications and we aim to make our entire operation process, from production to implementation, perfect.

With the help of our expert technical sales staff, we guide the sales processes by ensuring the right product, practitioner, and project matches in facade projects.

Working in cooperation with the relevant departments and staff of the universities, specific to our product groups, we ensure that technical details and specifications are prepared and shared. We come together with stakeholders such as architects, contractors, and facade practitioners, share with them technical specifications, principle detail drawings, and static calculation studies in accordance with our products, and offer technical guidance in special detail and grid works.

We provide technical support for the smooth progress of field applications and work with the practitioners in coordination to supervise compliance with the specifications.

*Evler, ofisler, alışveriş merkezleri ve havaalanları... Hepsini hayata dokunduğumuz buluşma noktaları olarak görüyoruz. Tasarımlarımızı üretirken gösterdiğimiz özeni ürün uygulamalarına taşıyor; üretimden uygulamaya bütün operasyon sürecimizin kusursuz olmasını hedefliyoruz.*

*Uzman teknik satış kadromuz ile satış sürecinin her aşamasında doğru ürünün, doğru uygulama ve detayla eşleştirilmesini hedefliyoruz.*

*Ürün gruplarımızın teknik özelliklerini ve kullanım avantajlarını en iyi şekilde ortaya koyabilmek için uzman kadrolarla iş birliği yaparak detaylı teknik dokümanlar ve şartnameler hazırlıyoruz. Bilgileri sektör profesyonelleriyle paylaşarak ürünlerimizin teknik yeterliliklerinin akademik çevrelerce de desteklenmesini sağlıyoruz. Mimari gruplar, müteahhitler, uygulamacılar, cephe danışmanları, cephe uygulamacıları gibi sektörün önemli paydaşları ile sürekli iletişim halinde olup, projelerin başarıyla tamamlanmasını sağlayacak teknik şartnameler, prensip detay çizimleri ve statik hesap çalışmalarını paylaşıyoruz.*

*Saha uygulamalarının sorunsuz ilerlemesi için teknik destek veriyor ve şartnameye uygunluğunu denetlemek üzere uygulayıcı ekiplerle koordineli şekilde çalışıyoruz.*

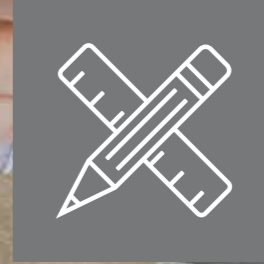
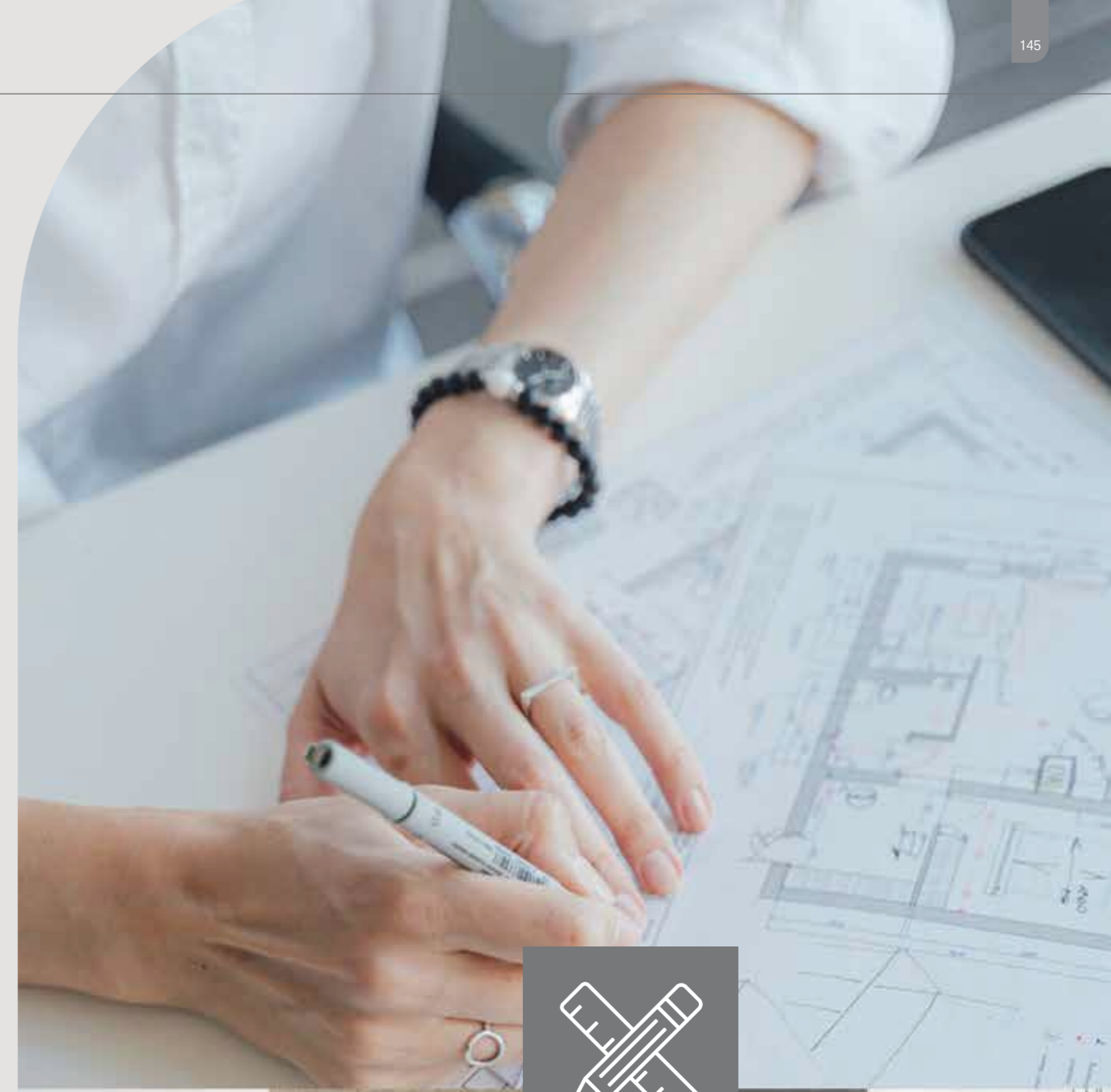



# Size Table

## Ölçü Tablosu

TIPOLOJİ TYPOLOGY	SERİ SERIES	ÜRÜN PRODUCT	100x300		120x360		160x320/162x323			162x323			162x323			OPENBOOK
			3MM	5MM	3MM	5MM	6MM			12MM			20MM			
			MAT / MATTE		MAT / MATTE		SOFT MAT / SOFT MATTE	PARLAK / POLISHED	SATEN / SATIN	SOFT MAT / SOFT MATTE	PARLAK / POLISHED	SATEN / SATIN	SOFT MAT / SOFT MATTE	PARLAK / POLISHED	KAYA YÜZEY / ROCK SURFACE	
MARBLE B&W / MERMER B&W	MARBLES	CALACATTA 2.O	X	X	X	X										
MARBLE B&W / MERMER B&W	CALCATTÀ UNIQUE	CALACATTA UNIQUE NEW / YENİ	X	X	X	X	X	X		X	X	X	X		X	
MARBLE B&W / MERMER B&W	CALCATTÀ CALDIA	CALACATTA CALDIA NEW / YENİ	X	X	X	X	X	X		X	X	X				
MARBLE B&W / MERMER B&W	CALACATTA GOLD	CALACATTA GOLD	X		X		X	X		X	X	X				
MARBLE B&W / MERMER B&W	MARBLES	CALACATTA ICE	X		X											
MARBLE B&W / MERMER B&W	FLORENCE	FLORENCE NEW / YENİ					X	X		X	X				X	
MARBLE B&W / MERMER B&W	GOLDEN HOUR	GOLDEN HOUR NEW / YENİ					X	X		X	X				X	
MARBLE B&W / MERMER B&W	BRONZE LINE	BRONZE LINE NEW / YENİ					X	X		X	X					
MARBLE B&W / MERMER B&W	CALACATTA VIOLA	CALACATTA VIOLA NEW / YENİ					X	X		X	X					
MARBLE B&W / MERMER B&W	CALACATTA MACCHIA	CALACATTA MACCHIA		X		X	X	X		X	X					
MARBLE B&W / MERMER B&W	MARBLES	COLORODO ORO	X												X	
MARBLE B&W / MERMER B&W	MARBLES	MARBLE DARK	X	X	X	X										
MARBLE B&W / MERMER B&W	PIETRA NERO	PIETRA NERO NEW / YENİ	X	X	X	X	X	X		X	X		X		X	
MARBLE B&W / MERMER B&W	PALISSANDRO	PALISSANDRO	X	X	X	X	X			X						
MARBLE B&W / MERMER B&W	PORT LAURENT	PORT LAURENT	X	X	X	X	X	X		X	X					
MARBLE B&W / MERMER B&W	MARBLES	WINTERLAND	X	X	X	X										
MARBLE B&W / MERMER B&W	MARBLES	MARBLE STATUARIO								X	X					
MARBLE EXCLUSIVE / MERMER EXCLUSIVE	SAHARA BROWN / SAHARA KAHVE	SAHARA BROWN / SAHARA KAHVE	X				X			X						
MARBLE EXCLUSIVE / MERMER EXCLUSIVE	MARBLES	ALAMEDA	X		X											
MARBLE EXCLUSIVE / MERMER EXCLUSIVE	MARBLES	ASTEROID	X	X	X	X										
MARBLE EXCLUSIVE / MERMER EXCLUSIVE	MARMO METALLO	MARMO METALLO	X	X	X	X	X			X						
MARBLE EXCLUSIVE / MERMER EXCLUSIVE	MARBLES	MOCHA PERLA	X	X	X	X										
MARBLE EXCLUSIVE / MERMER EXCLUSIVE	MARBLES	OLIMPO	X	X	X	X	X	X		X						
MARBLE EXCLUSIVE / MERMER EXCLUSIVE	SARRANCOLIN	SARRANCOLIN- NEW / YENİ					X	X		X	X					
MARBLE EXCLUSIVE / MERMER EXCLUSIVE	PATAGONIA	PATAGONIA NEW / YENİ						X		X	X				X	
MARBLE EXCLUSIVE / MERMER EXCLUSIVE	QUARZITE J'ADORE	QUARZITE J'ADORE NEW / YENİ						X			X				X	
MARBLE EXCLUSIVE / MERMER EXCLUSIVE	MARBLES	SEA NATURE	X	X												
MARBLE EXCLUSIVE / MERMER EXCLUSIVE	MARBLES	VERSAILLES						X		X						
MARBLE EXCLUSIVE / MERMER EXCLUSIVE	MARINA	MARINA NEW / YENİ						X			X					
MARBLE EXCLUSIVE / MERMER EXCLUSIVE	ALASKA WHITE	ALASKA WHITE NEW / YENİ						X			X					
MARBLE EXCLUSIVE / MERMER EXCLUSIVE	TIFFANY BLUE	TIFFANY BLUE NEW / YENİ						X							X	
MARBLE EXCLUSIVE / MERMER EXCLUSIVE	NAMIBIA	NAMIBIA NEW / YENİ						X			X					

# Size Table

## Ölçü Tablosu

TIPOLOJİ TYPOLOGY	SERİ SERIES	ÜRÜN PRODUCT	100x300		120x360		160x320/162x323			162x323			162x323			OPENBOOK
			3MM	5MM	3MM	5MM	6MM			12MM			20MM			
			MAT / MATTE		MAT / MATTE		SOFT MAT / SOFT MATTE	PARLAK / POLISHED	SATEN / SATIN	SOFT MAT / SOFT MATTE	PARLAK / POLISHED	SATEN / SATIN	SOFT MAT / SOFT MATTE	PARLAK / POLISHED	KAYA YÜZEY / ROCK SURFACE	
MARBLE TIMELESS / MERMER TIMELESS	MARBLES	PULPIS	X		X											
MARBLE TIMELESS / MERMER TIMELESS	FIORI DI BOSCO	FIORI DI BOSCO NEW / YENİ					X	X		X	X					
MARBLE TIMELESS / MERMER TIMELESS	DIAMOND COLLECTION	DENISE NEW / YENİ						X		X	X					
MARBLE TIMELESS / MERMER TIMELESS	MARBLES	TRANSLUCENT ONYX	X													
MARBLE TIMELESS / MERMER TIMELESS	MARBLES	TRAVERTINO			X											
MARBLE TIMELESS / MERMER TIMELESS	DIAMOND COLLECTION	CRYSTALLUS NEW / YENİ						X			X					
STONE / DOĞALTAŞ	MARBLES	LIMESTONE	X	X	X	X										
STONE / DOĞALTAŞ	C-STONE	C-STONE ANTHRACITE / C-STONE ANTRASİT	X	X	X	X										
STONE / DOĞALTAŞ	C-STONE	C-STONE BEIGE / C-STONE BEJ	X	X	X	X										
STONE / DOĞALTAŞ	C-STONE	C-STONE WHITE / C-STONE BEYAZ	X	X	X	X										
STONE / DOĞALTAŞ	C-STONE	C-STONE GREY / C-STONE GRİ	X	X	X	X										
STONE / DOĞALTAŞ	C-STONE	C-STONE BROWN / C-STONE KAHVE	X	X	X	X										
STONE / DOĞALTAŞ	KSF UPTOWN	UPTOWN DARK	X	X	X	X										
STONE / DOĞALTAŞ	KSF UPTOWN	UPTOWN LIGHT	X	X	X	X										
STONE / DOĞALTAŞ	NATURAL STONE	BRERA CRÈME	X	X												
STONE / DOĞALTAŞ	NATURAL STONE	LECCESE DARK SAND	X	X	X	X										
STONE / DOĞALTAŞ	NATURAL STONE	LECCESE GREY	X	X												
STONE / DOĞALTAŞ	NATURAL STONE	LECCESE LIGHT SAND	X	X												
STONE / DOĞALTAŞ	NATURAL STONE	PIETRA BLUE	X	X	X	X										
STONE / DOĞALTAŞ	NATURAL STONE	PIETRA GREY	X	X												
STONE / DOĞALTAŞ	OCEAN	OCEAN BLACK	X	X												
STONE / DOĞALTAŞ	OCEAN	OCEAN WHITE	X	X												
STONE / DOĞALTAŞ	OMNITECH	PIAMONTE	X													
STONE / DOĞALTAŞ	OMNITECH	MONOLITH	X													
STONE / DOĞALTAŞ	PIETRA BASALTINA	PIETRA BASALTINA	X									X		X		
STONE / DOĞALTAŞ	PIETRA DI CHATIL	PIETRA CHATILLONN	X	X												
STONE / DOĞALTAŞ	STONE GALLERY	QUARTZ ASH	X													
STONE / DOĞALTAŞ	CALCARIO COLLECTION	CALCARIO COLLECTION LINE NEW / YENİ GREIGE						X								
STONE / DOĞALTAŞ	CALCARIO COLLECTION	CALCARIO COLLECTION NEW / YENİ GREIGE						X			X			X		
STONE / DOĞALTAŞ	CALCARIO COLLECTION	CALCARIO COLLECTION LIGHT GREIGE						X			X			X		
STONE / DOĞALTAŞ	CALCARIO COLLECTION	CALCARIO COLLECTION LIGHT LINE GREIGE						X								
STONE / DOĞALTAŞ	STONELAND	PIETRA DI GRE BONE / PIETRA DI GRE KEMİK	X		X		X				X		X			
STONE / DOĞALTAŞ	STONELAND	PIETRA DI GRE GREY / PIETRA DI GRE GRİ	X		X		X				X		X			









# Kalesinterflex 100\*300 - 120\*360 3mm Technical Specifications

## Kalesinterflex 100\*300 - 120\*360 3mm Teknik Özellikler

	Norm - Test Method Norm - Test Methodu	Requirements for Nominal Size N Nominal Boyut N Gereklikleri		KALE 1000x3000R (mm) Rectified / Rektifiyeli		KALE 1200x3600R (mm) Rectified / Rektifiyeli	
		N ≥ 15cm		Matte Mat	Polished Parlatılmış	Matte Mat	Polished Parlatılmış
		% (for rectified) (Rektifiye edilmiş için)	mm (for rectified) (Rektifiye edilmiş için)				
Length and width Uzunluk ve genişlik	ISO 10545-2	± 0,3	± 1	Suitable Uygun	Suitable Uygun	Suitable Uygun	Suitable Uygun
Thickness Kalınlık		± 0,5	± 0,5	Suitable Uygun	Suitable Uygun	Suitable Uygun	Suitable Uygun
Straightness of sides Kenarların düzgünlüğü		± 0,3	± 0,8	Suitable Uygun	Suitable Uygun	Suitable Uygun	Suitable Uygun
Rectangularity (Measurement only on short edges when L/l ≥ 3) Gönyeden sapma (Sadece L/l ≥ 3 olduğunda ölçülür)		± 0,3	± 1,5	Suitable Uygun	Suitable Uygun	Suitable Uygun	Suitable Uygun
Surface flatness Yüzey düzgünlüğü		c.c. ± 0,4	c.c. ± 1,8	Suitable Uygun	Suitable Uygun	Suitable Uygun	Suitable Uygun
		e.c. ± 0,4	e.c. ± 1,8				
	w. ± 0,4	w. ± 1,8					
Water absorption Su emme	ISO 10545-3	Ev ≤ 0,5 % Individual max 0,6 % Ev ≤ 0,5 % tek olarak max 0,6 %		≤ 0,3 %	≤ 0,3 %	≤ 0,3 %	≤ 0,3 %
Breaking strength (Thickness < 7,5mm) Kırılma dayanımı (Kalınlık < 7,5mm)	ISO 10545-4	Not less than 700 N Daha az değil 700 N		≥ 700N	≥ 700N	≥ 700N	≥ 700N
Modulus of rupture Eğilme dayanımı		R ≥ 35 N/mm <sup>2</sup>		≥ 45 N/mm <sup>2</sup>	≥ 45 N/mm <sup>2</sup>	≥ 45 N/mm <sup>2</sup>	≥ 45 N/mm <sup>2</sup>
Impact resistance, as coefficient of restitution Çarpma dayanımı	ISO 10545-5	Declared value Beyan edilen değer		≥ 55	≥ 55	≥ 55	≥ 55
Resistance to deep abrasion of unglazed tiles (removed volume) Derin aşınma	ISO 10545-6	≤ 175mm <sup>3</sup>		Suitable Uygun	Suitable Uygun	Suitable Uygun	Suitable Uygun
Coefficient of thermal linear expansion Lineer ısı genleşme	ISO 10545-8	Declared value Beyan edilen değer		≤ 7 x 10 <sup>-6</sup>	≤ 7 x 10 <sup>-6</sup>	≤ 7 x 10 <sup>-6</sup>	≤ 7 x 10 <sup>-6</sup>
Thermal shock resistance Isıl şok dayanımı	ISO 10545-9	Pass according to EN ISO 10545-1 EN ISO 10545-1'e göre geçer		Resistant Dayanıklı	Resistant Dayanıklı	Resistant Dayanıklı	Resistant Dayanıklı
Moisture expansion Rutubet genleşmesi (in mm/m)	ISO 10545-10	Declared value Beyan edilen değer		≤ 0,01% (0,1mm/m)	≤ 0,01% (0,1mm/m)	≤ 0,01% (0,1mm/m)	≤ 0,01% (0,1mm/m)
Frost resistance Dona dayanım	ISO 10545-12	Pass according to EN ISO 10545-1 EN ISO 10545-1'e göre geçer		Resistant Dayanıklı	Resistant Dayanıklı	Resistant Dayanıklı	Resistant Dayanıklı
Bond strength / adhesion for improved cementitious adhesives Geliştirilmiş çimento esaslı yapıştırıcılar için bağlanma / yapışma mukavemeti	EN 1348	Declared value Beyan edilen değer		≥ 0,5 N/mm <sup>2</sup>	≥ 0,5 N/mm <sup>2</sup>	≥ 0,5 N/mm <sup>2</sup>	≥ 0,5 N/mm <sup>2</sup>
Reaction to fire Yangına tepki	-	A1 or / veya Af1		A1 without fiberglass Fiberglassız A1	A1 without fiberglass Fiberglassız A1	A1 without fiberglass Fiberglassız A1	A1 without fiberglass Fiberglassız A1
Resistance to household chemicals and swimming pool salts Ev ve havuz kimyasallarına dayanım		Minimum Class B Minimum sınıf B		A	A	A	A
Resistance to low concentrations of acids and alkalis Düşük konsantrasyonlu asit ve alkalilere dayanım	ISO 10545-13	Declared value Beyan edilen değer		LA	LA	LA	LA
Resistance to high concentrations of acids and alkalis Yüksek konsantrasyonlu asit ve alkalilere dayanım		Declared value Beyan edilen değer		HA	-	HA	-
Resistance to staining Lekelenme dayanımı	ISO 10545-14	Declared value Beyan edilen değer		5	5	5	5
Release of dangerous substances: cadmium (in mg/dm <sup>2</sup> ) and lead (in mg/dm <sup>2</sup> ) Tehlikeli madde salınımı: kadmiyum (mg/dm <sup>2</sup> ) ve kurşun (mg/dm <sup>2</sup> )	ISO 10545-15	Declared value Beyan edilen değer		≤ 0,01 mg/dm <sup>2</sup> Cd ≤ 0,1 mg/dm <sup>2</sup> Pb	≤ 0,01 mg/dm <sup>2</sup> Cd ≤ 0,1 mg/dm <sup>2</sup> Pb	≤ 0,01 mg/dm <sup>2</sup> Cd ≤ 0,1 mg/dm <sup>2</sup> Pb	≤ 0,01 mg/dm <sup>2</sup> Cd ≤ 0,1 mg/dm <sup>2</sup> Pb

# Kalesinterflex 100\*300 - 120\*360 5mm Technical Specifications

## Kalesinterflex 100\*300 - 120\*360 5mm Teknik Özellikler

	Norm - Test Method Norm - Test Methodu	Requirements for Nominal Size N Nominal Boyut N Gereklilikleri		KALE 1000x3000R (mm) Rectified / Rektifiyeli		KALE 1200x3600R (mm) Rectified / Rektifiyeli	
		N ≥ 15cm		Matte Mat	Polished Parlatılmış	Matte Mat	Polished Parlatılmış
		% (for rectified) (Rektifiye edilmiş için)	mm (for rectified) (Rektifiye edilmiş için)				
Length and width Uzunluk ve genişlik	ISO 10545-2	± 0,3	± 1	Suitable Uygun	Suitable Uygun	Suitable Uygun	Suitable Uygun
Thickness Kalınlık		± 0,5	± 0,5	Suitable Uygun	Suitable Uygun	Suitable Uygun	Suitable Uygun
Straightness of sides Kenarların düzgünlüğü		± 0,3	± 0,8	Suitable Uygun	Suitable Uygun	Suitable Uygun	Suitable Uygun
Rectangularity (Measurement only on short edges when L/l ≥ 3) Gönyeden sapma (Sadece L/l ≥ 3 olduğunda ölçülür)		± 0,3	± 1,5	Suitable Uygun	Suitable Uygun	Suitable Uygun	Suitable Uygun
Surface flatness Yüzey düzgünlüğü		c.c. ± 0,4	c.c. ± 1,8	Suitable Uygun	Suitable Uygun	Suitable Uygun	Suitable Uygun
		e.c. ± 0,4	e.c. ± 1,8				
	w. ± 0,4	w. ± 1,8					
Water absorption Su emme	ISO 10545-3	Ev ≤ 0,5 % Individual max 0,6 % Ev ≤ 0,5 % tek olarak max 0,6 %		≤ 0,3 %	≤ 0,3 %	≤ 0,3 %	≤ 0,3 %
Breaking strength (Thickness < 7,5mm) Kırılma dayanımı (Kalınlık < 7,5mm)	ISO 10545-4	Not less than 700 N		≥ 700N	≥ 700N	≥ 700N	≥ 700N
Modulus of rupture Eğilme dayanımı		R ≥ 35 N/mm <sup>2</sup>		≥ 45 N/mm <sup>2</sup>	≥ 45 N/mm <sup>2</sup>	≥ 45 N/mm <sup>2</sup>	≥ 45 N/mm <sup>2</sup>
Impact resistance, as coefficient of restitution Çarpma dayanımı	ISO 10545-5	Declared value Beyan edilen değer		≥ 55	≥ 55	≥ 55	≥ 55
Resistance to deep abrasion of unglazed tiles (removed volume) Derin aşınma	ISO 10545-6	≤ 175mm <sup>3</sup>		Suitable Uygun	Suitable Uygun	Suitable Uygun	Suitable Uygun
Coefficient of thermal linear expansion Lineer ısı genleşme	ISO 10545-8	Declared value Beyan edilen değer		≤ 7 x 10 <sup>-6</sup>	≤ 7 x 10 <sup>-6</sup>	≤ 7 x 10 <sup>-6</sup>	≤ 7 x 10 <sup>-6</sup>
Thermal shock resistance Isıl şok dayanımı	ISO 10545-9	Pass according to EN ISO 10545-1 EN ISO 10545-1'e göre geçer		Resistant Dayanıklı	Resistant Dayanıklı	Resistant Dayanıklı	Resistant Dayanıklı
Moisture expansion Rutubet genleşmesi (in mm/m)	ISO 10545-10	Declared value Beyan edilen değer		≤ 0,01% (0,1mm/m)	≤ 0,01% (0,1mm/m)	≤ 0,01% (0,1mm/m)	≤ 0,01% (0,1mm/m)
Frost resistance Dona dayanım	ISO 10545-12	Pass according to EN ISO 10545-1 EN ISO 10545-1'e göre geçer		Resistant Dayanıklı	Resistant Dayanıklı	Resistant Dayanıklı	Resistant Dayanıklı
Bond strength / adhesion for improved cementitious adhesives Geliştirilmiş çimento esaslı yapıştırıcılar için bağlanma / yapışma mukavemeti	EN 1348	Declared value Beyan edilen değer		≥ 0,5 N/mm <sup>2</sup>	≥ 0,5 N/mm <sup>2</sup>	≥ 0,5 N/mm <sup>2</sup>	≥ 0,5 N/mm <sup>2</sup>
Reaction to fire Yangına tepki	-	A1 or Af1		A1 without fiberglass	A1 without fiberglass	A1 without fiberglass	A1 without fiberglass
Resistance to household chemicals and swimming pool salts Ev ve havuz kimyasallarına dayanım		Minimum Class B Minimum sınıf B		A	A	A	A
Resistance to low concentrations of acids and alkalis Düşük konsantrasyonlu asit ve alkalilere dayanım	ISO 10545-13	Declared value Beyan edilen değer		LA	LA	LA	LA
Resistance to high concentrations of acids and alkalis Yüksek konsantrasyonlu asit ve alkalilere dayanım		Declared value Beyan edilen değer		HA	-	HA	-
Resistance to staining Lekelenme dayanımı	ISO 10545-14	Declared value Beyan edilen değer		5	5	5	5
Release of dangerous substances: cadmium (in mg/dm <sup>2</sup> ) and lead (in mg/dm <sup>2</sup> ) Tehlikeli madde salınımı: kadmiyum (mg/dm <sup>2</sup> ) ve kurşun (mg/dm <sup>2</sup> )	ISO 10545-15	Declared value Beyan edilen değer		≤ 0,01 mg/dm <sup>2</sup> Cd ≤ 0,1 mg/dm <sup>2</sup> Pb	≤ 0,01 mg/dm <sup>2</sup> Cd ≤ 0,1 mg/dm <sup>2</sup> Pb	≤ 0,01 mg/dm <sup>2</sup> Cd ≤ 0,1 mg/dm <sup>2</sup> Pb	≤ 0,01 mg/dm <sup>2</sup> Cd ≤ 0,1 mg/dm <sup>2</sup> Pb



# Kalesinterflex 160\*320 - 162x323 6mm-12mm Technical Table

## Kalesinterflex 160\*320 - 162x323 6mm-12mm Teknik Tablo

	Norm - Test Method Norm - Test Methodu	Requirements for Nominal Size N Nominal Boyut N Gereklilikleri		KALE 1620X3230 (mm) Non-rectified / Rektifiyesiz		KALE 1600X3200R (mm) Rectified / Rektifiyeli	
		N≥15cm		Matte Mat	Polished Parlatılmış	Matte Mat	Polished Parlatılmış
		% (for rectified) (Rektifiye edilmiş için)	mm (for rectified) (Rektifiye edilmiş için)				
Length and width Uzunluk ve genişlik	ISO 10545-2	± 0,3	± 1	N.A.	N.A.	Suitable Uygun	Suitable Uygun
Thickness Kalınlık		± 0,5	± 0,5	N.A.	N.A.	Suitable Uygun	Suitable Uygun
Straightness of sides Kenarların düzgünlüğü		± 0,3	± 0,8	N.A.	N.A.	Suitable Uygun	Suitable Uygun
Rectangularity (Measurement only on short edges when L/l ≥ 3) Gönyeden sapma (Sadece L/l ≥ 3 olduğunda ölçülür)		± 0,3	± 1,5	N.A.	N.A.	Suitable Uygun	Suitable Uygun
Surface flatness Yüzey düzgünlüğü		c.c. ± 0,4	c.c. ± 1,8	N.A.	N.A.	Suitable Uygun	Suitable Uygun
		e.c. ± 0,4	e.c. ± 1,8				
	w. ± 0,4	w. ± 1,8					
Water absorption Su emme	ISO 10545-3	Ev ≤ 0,5% Individual max 0,6% Ev ≤ 0,5% tek olarak max 0,6%		≤ 0,1 %	≤ 0,1 %	≤ 0,1 %	≤ 0,1 %
Breaking strength Kırılma dayanımı	ISO 10545-4	for thickness / kalınlık < 7,5mm S ≥ 700 N for thickness/kalınlık ≥ 7,5mm S ≥ 1300 N		6mm -> S ≥ 700N 12mm -> S ≥ 4000N	6mm -> S ≥ 700N 12mm -> S ≥ 4000N	6mm -> S ≥ 700N 12mm -> S ≥ 4000N	6mm -> S ≥ 700N 12mm -> S ≥ 4000N
Modulus of rupture Eğilme dayanımı		R ≥ 35 N/mm <sup>2</sup>		6mm -> R ≥ 35 N/mm <sup>2</sup> 12mm -> R ≥ 45 N/mm <sup>2</sup>	6mm -> R ≥ 35 N/mm <sup>2</sup> 12mm -> R ≥ 45 N/mm <sup>2</sup>	6mm -> R ≥ 35 N/mm <sup>2</sup> 12mm -> R ≥ 45 N/mm <sup>2</sup>	6mm -> R ≥ 35 N/mm <sup>2</sup> 12mm -> R ≥ 45 N/mm <sup>2</sup>
Impact resistance, as coefficient of restitution Çarpma dayanımı	ISO 10545-5	Declared value Beyan edilen değer		≥ 55	≥ 55	≥ 55	≥ 55
Resistance to deep abrasion of unglazed tiles (removed volume) Derin aşınma	ISO 10545-6	≤ 175mm <sup>3</sup>		Suitable Uygun	Suitable Uygun	Suitable Uygun	Suitable Uygun
Coefficient of thermal linear expansion Lineer ısı genleşme	ISO 10545-8	Declared value Beyan edilen değer		≤ 7 MK-1	≤ 7 MK-1	≤ 7 MK-1	≤ 7 MK-1
Thermal shock resistance Isıl şok dayanımı	ISO 10545-9	Pass according to EN ISO 10545-1 EN ISO 10545-1'e göre geçer		Resistant Dayanıklı	Resistant Dayanıklı	Resistant Dayanıklı	Resistant Dayanıklı
Moisture expansion Rutubet genleşmesi (in mm/m)	ISO 10545-10	Declared value Beyan edilen değer		≤ 0,01% (0,1mm/m)	≤ 0,01% (0,1mm/m)	≤ 0,01% (0,1mm/m)	≤ 0,01% (0,1mm/m)
Frost resistance Dona dayanım	ISO 10545-12	Pass according to EN ISO 10545-1 EN ISO 10545-1'e göre geçer		Resistant Dayanıklı	Resistant Dayanıklı	Resistant Dayanıklı	Resistant Dayanıklı
Bond strength / adhesion for improved cementitious adhesives Geliştirilmiş çimento esaslı yapıştırıcılar için bağlanma / yapışma mukavemeti	EN 1348	Declared value Beyan edilen değer		≥ 0,5 N/mm <sup>2</sup>	≥ 0,5 N/mm <sup>2</sup>	≥ 0,5 N/mm <sup>2</sup>	≥ 0,5 N/mm <sup>2</sup>
Reaction to fire Yangına tepki	-	A1 or AfI		A1 without fiberglass	A1 without fiberglass	A1 without fiberglass	A1 without fiberglass
Resistance to household chemicals and swimming pool salts Ev ve havuz kimyasallarına dayanım	ISO 10545-13	Minimum Class B Minimum sınıf B		A	A	A	A
Resistance to low concentrations of acids and alkalis Düşük konsantrasyonlu asit ve alkalilere dayanım		Declared value Beyan edilen değer		LA	LA	LA	LA
Resistance to high concentrations of acids and alkalis Yüksek konsantrasyonlu asit ve alkalilere dayanım		Declared value Beyan edilen değer		HA	-	HA	-
Resistance to staining Lekelenme dayanımı		Declared value Beyan edilen değer		5	5	5	5
Release of dangerous substances: cadmium (in mg/dm <sup>2</sup> ) and lead (in mg/dm <sup>2</sup> ) Tehlikeli madde salınımı: kadmiyum (mg/dm <sup>2</sup> ) ve kurşun (mg/dm <sup>2</sup> )	ISO 10545-15	Declared value Beyan edilen değer		≤ 0,01 mg/dm <sup>2</sup> Cd ≤ 0,1 mg/dm <sup>2</sup> Pb	≤ 0,01 mg/dm <sup>2</sup> Cd ≤ 0,1 mg/dm <sup>2</sup> Pb	≤ 0,01 mg/dm <sup>2</sup> Cd ≤ 0,1 mg/dm <sup>2</sup> Pb	≤ 0,01 mg/dm <sup>2</sup> Cd ≤ 0,1 mg/dm <sup>2</sup> Pb

# 100\*300-120\*360 Packaging and Shipping Details

100\*300-120\*360 Paketleme ve Gönderim Detayı

CRATE SIZE ÜRÜN EBADI cm	CRATE SIZE SANDIK EBADI cm	PRODUCT GROUP ÜRÜN GRUBU	kg/m <sup>2</sup>	PIECE ADET/m <sup>2</sup>	EMPTY CRATE BOŞ SANDIK kg	CRATE DETAILS SANDIK DETAY			TRUCK TIR			20" CONTAINER 20 LİK KONTEYNER			40" CONTAINER 40 LİK KONTEYNER		
						PRODUCT QUANTITY ÜRÜN ADET	PRODUCT ÜRÜN m <sup>2</sup>	KG (PRODUCT+CRATE) (ÜRÜN+SANDIK)	PRODUCT-CRATE SANDIK ADET	m <sup>2</sup>	KG (PRODUCT+CRATE) (ÜRÜN+SANDIK)	PRODUCT-CRATE SANDIK ADET	m <sup>2</sup>	KG (PRODUCT+CRATE) (ÜRÜN+SANDIK)	PRODUCT-CRATE SANDIK ADET	m <sup>2</sup>	KG (PRODUCT+CRATE) (ÜRÜN+SANDIK)
100x300cm	114x317x40	3MM PLAİN	7	3	180	50	150,00	1.365	19	2.850	25.935	10	1.500	13.650	19	2.850	25.935
		5MM PLAİN	11,66	3	180	35	105,00	1.404	18	1.890	25.277	10	1.050	14.043	18	1.890	25.277
		6MM PLAİN	14	3	180	15	45,00	810	18	810	14.580	10	450	8.100	18	810	14.580
		3MM FİT	8	3	180	45	135,00	1.260	20	2.700	25.200	10	1.350	12.600	19	2.565	23.940
		5MM FİT	12,5	3	180	32	96,00	1.380	19	1.824	26.220	10	960	13.800	18	1.728	24.840
		6MM FİT	15	3	180	26	78,00	1.350	19	1.482	25.650	10	780	13.500	18	1.404	24.300
100x150 CM	113x163X40	3MM PLAİN	7	1,5	90	50	75,00	615	36	2.700	22.140	30	2.250	18.450	36	2.700	22.140
		5MM PLAİN	11,66	1,5	90	35	52,50	702	36	1.890	25.277	30	1.575	21.065	36	1.890	25.277
		6MM PLAİN	14	1,5	90	30	45,00	720	36	1.620	25.920	30	1.350	21.600	36	1.620	25.920
		3MM FİT	8	1,5	90	45	67,50	630	36	2.430	22.680	30	2.025	18.900	36	2.430	22.680
		5MM FİT	12,5	1,5	90	32	48,00	690	36	1.728	24.840	30	1.440	20.700	36	1.728	24.840
		6MM FİT	15	1,5	90	26	39,00	675	36	1.404	24.300	30	1.170	20.250	36	1.404	24.300
100x100 CM	113x113X40	3MM PLAİN	7	1	60	50	50,00	410	50	2.500	20.500	50	2.500	20.500	50	2.500	20.500
		5MM PLAİN	11,66	1	60	35	35,00	468	50	1.750	23.405	50	1.750	23.405	50	1.750	23.405
		6MM PLAİN	14	1	60	18	18,00	312	50	900	15.600	50	900	15.600	50	900	15.600
		3MM FİT	8	1	60	45	45,00	420	50	2.250	21.000	50	2.250	21.000	50	2.250	21.000
		5MM FİT	12,5	1	60	32	32,00	460	50	1.600	23.000	50	1.600	23.000	50	1.600	23.000
		6MM FİT	15	1	60	26	26,00	450	50	1.300	22.500	50	1.300	22.500	50	1.300	22.500
50x300 CM	114x317X40	3MM PLAİN	7	1,5	180	100	150,00	1.230	19	2.850	23.370	10	1.500	12.300	19	2.850	23.370
		5MM PLAİN	11,66	1,5	180	70	105,00	1.404	18	1.890	25.277	10	1.050	14.043	18	1.890	25.277
		6MM PLAİN	14	1,5	180	60	90,00	1.440	19	1.710	27.360	10	900	14.400	18	1.620	25.920
		3MM FİT	8	1,5	180	90	135,00	1.260	20	2.700	25.200	10	1.350	12.600	19	2.565	23.940
		5MM FİT	12,5	1,5	180	64	96,00	1.380	19	1.824	26.220	10	960	13.800	18	1.728	24.840
		6MM FİT	15	1,5	180	52	78,00	1.350	19	1.482	25.650	10	780	13.500	18	1.404	24.300
50x150 CM	113x163X40	3MM PLAİN	7	0,75	90	100	75,00	615	36	2.700	22.140	30	2.250	18.450	36	2.700	22.140
		5MM PLAİN	11,66	0,75	90	70	52,50	702	36	1.890	25.277	30	1.575	21.065	36	1.890	25.277
		6MM PLAİN	14	0,75	90	60	45,00	720	36	1.620	25.920	30	1.350	21.600	36	1.620	25.920
		3MM FİT	8	0,75	90	90	67,50	630	36	2.430	22.680	30	2.025	18.900	36	2.430	22.680
		5MM FİT	12,5	0,75	90	64	48,00	690	36	1.728	24.840	30	1.440	20.700	36	1.728	24.840
		6MM FİT	15	0,75	90	52	39,00	675	36	1.404	24.300	30	1.170	20.250	36	1.404	24.300
50x100 CM	113x113X40	3MM PLAİN	7	0,5	60	100	50,00	410	50	2.500	20.500	50	2.500	20.500	50	2.500	20.500
		5MM PLAİN	11,66	0,5	60	70	35,00	468	50	1.750	23.405	50	1.750	23.405	50	1.750	23.405
		6MM PLAİN	14	0,5	60	60	30,00	480	50	1.500	24.000	50	1.500	24.000	50	1.500	24.000
		3MM FİT	8	0,5	60	90	45,00	420	50	2.250	21.000	50	2.250	21.000	50	2.250	21.000
		5MM FİT	12,5	0,5	60	64	32,00	460	50	1.600	23.000	50	1.600	23.000	50	1.600	23.000
		6MM FİT	15	0,5	60	52	26,00	450	50	1.300	22.500	50	1.300	22.500	50	1.300	22.500



# 100\*300-120\*360 Packaging and Shipping Details

100\*300-120\*360 Paketleme ve Gönderim Detayı

CRATE SIZE ÜRÜN EBADI cm	CRATE SIZE SANDIK EBADI cm	PRODUCT GROUP ÜRÜN GRUBU	kg/m <sup>2</sup>	PIECE ADET/m <sup>2</sup>	EMPTY CRATE BOŞ SANDIK kg	CRATE DETAILS SANDIK DETAY			TRUCK TIR			20" CONTAINER 20 LİK KONTEYNER			40" CONTAINER 40 LİK KONTEYNER		
						PRODUCT QUANTITY ÜRÜN ADET	PRODUCT ÜRÜN m <sup>2</sup>	KG (PRODUCT+CRATE) (ÜRÜN+SANDIK)	PRODUCT-CRATE SANDIK ADET	m <sup>2</sup>	KG (PRODUCT+CRATE) (ÜRÜN+SANDIK)	PRODUCT-CRATE SANDIK ADET	m <sup>2</sup>	KG (PRODUCT+CRATE) (ÜRÜN+SANDIK)	PRODUCT-CRATE SANDIK ADET	m <sup>2</sup>	KG (PRODUCT+CRATE) (ÜRÜN+SANDIK)
120x360 CM	134X377x34	3MM PLAİN	7	4,32	220	40	172,80	1.430	15	2.592	21.444	5	864	7.148	15	2.592	21.444
		5MM PLAİN	11,66	4,32	220	27	116,64	1.580	15	1.750	23.700	5	583	7.900	15	1.750	23.700
		6MM PLAİN	14	4,32	220	22	95,04	1.551	15	1.426	23.258	5	475	7.753	15	1.426	23.258
		3MM FİT	8	4,32	220	35	151,20	1.430	15	2.268	21.444	5	756	7.148	15	2.268	21.444
		5MM FİT	12,5	4,32	220	23	99,36	1.462	15	1.490	21.930	5	497	7.310	15	1.490	21.930
		6MM FİT	15	4,32	220	20	86,40	1.516	15	1.296	22.740	5	432	7.580	15	1.296	22.740
120x180 CM	134x193x34	3MM PLAİN	7	2,16	110	40	86,40	715	30	2.592	21.444	20	1.728	14.296	30	2.592	21.444
		5MM PLAİN	11,66	2,16	110	27	58,32	790	30	1.750	23.700	20	1.166	15.800	30	1.750	23.700
		6MM PLAİN	14	2,16	110	22	47,52	775	30	1.426	23.258	20	950	15.506	30	1.426	23.258
		3MM FİT	8	2,16	110	35	75,60	715	30	2.268	21.444	20	1.512	14.296	30	2.268	21.444
		5MM FİT	12,5	2,16	110	23	49,68	731	30	1.490	21.930	20	994	14.620	30	1.490	21.930
		6MM FİT	15	2,16	110	20	43,20	758	30	1.296	22.740	20	864	15.160	30	1.296	22.740
120x120 CM	134x134x34	3MM PLAİN	7	1,44	80	40	57,60	483	50	2.880	24.160	20	1.152	9.664	45	2.592	21.744
		5MM PLAİN	11,66	1,44	80	27	38,88	533	50	1.944	26.667	20	778	10.667	45	1.750	24.000
		6MM PLAİN	14	1,44	80	22	31,68	524	50	1.584	26.176	20	634	10.470	45	1.426	23.558
		3MM FİT	8	1,44	80	35	50,40	483	50	2.520	24.160	20	1.008	9.664	45	2.268	21.744
		5MM FİT	12,5	1,44	80	23	33,12	494	50	1.656	24.700	20	662	9.880	45	1.490	22.230
		6MM FİT	15	1,44	80	20	28,80	512	50	1.440	25.600	20	576	10.240	45	1.296	23.040
60x360 CM	134x377x34	3MM PLAİN	7	2,16	220	80	172,80	1.430	15	2.592	21.444	5	864	7.148	15	2.592	21.444
		5MM PLAİN	11,66	2,16	220	54	116,64	1.580	15	1.750	23.700	5	583	7.900	15	1.750	23.700
		6MM PLAİN	14	2,16	220	44	95,04	1.551	15	1.426	23.258	5	475	7.753	15	1.426	23.258
		3MM FİT	8	2,16	220	70	151,20	1.430	15	2.268	21.444	5	756	7.148	15	2.268	21.444
		5MM FİT	12,5	2,16	220	46	99,36	1.462	15	1.490	21.930	5	497	7.310	15	1.490	21.930
		6MM FİT	15	2,16	220	40	86,40	1.516	15	1.296	22.740	5	432	7.580	15	1.296	22.740
60x180 CM	134x193x34	3MM PLAİN	7	1,08	110	80	86,40	715	30	2.592	21.444	20	1.728	14.296	30	2.592	21.444
		5MM PLAİN	11,66	1,08	110	54	58,32	790	30	1.750	23.700	20	1.166	15.800	30	1.750	23.700
		6MM PLAİN	14	1,08	110	44	47,52	775	30	1.426	23.258	20	950	15.506	30	1.426	23.258
		3MM FİT	8	1,08	110	70	75,60	715	30	2.268	21.444	20	1.512	14.296	30	2.268	21.444
		5MM FİT	12,5	1,08	110	46	49,68	731	30	1.490	21.930	20	994	14.620	30	1.490	21.930
		6MM FİT	15	1,08	110	40	43,20	758	30	1.296	22.740	20	864	15.160	30	1.296	22.740
60x120 CM	134x134x34	3MM PLAİN	7	0,72	80	80	57,60	483	50	2.880	24.160	20	1.152	9.664	45	2.592	21.744
		5MM PLAİN	11,66	0,72	80	54	38,88	533	50	1.944	26.667	20	778	10.667	45	1.750	24.000
		6MM PLAİN	14	0,72	80	44	31,68	524	50	1.584	26.176	20	634	10.470	45	1.426	23.558
		3MM FİT	8	0,72	80	70	50,40	483	50	2.520	24.160	20	1.008	9.664	45	2.268	21.744
		5MM FİT	12,5	0,72	80	66	47,52	674	50	1.656	24.700	20	662	9.880	45	1.490	22.230
		6MM FİT	15	0,72	80	40	28,80	512	50	1.440	25.600	20	576	10.240	45	1.296	23.040

# Packaging and Shipping Details

## Paketleme ve Gönderim Detayları

### Packaging And Packages

#### Ambalaj ve Paketler

Kalesinterflex 6mm, 12mm and 20mm thick full-length 1620x3230mm slabs are vertically packed on metal "A-Frame".

Kalesinterflex 6mm, 12mm ve 20mm tam boy 1620x3230mm plakalar, metal "A Frame" üzerinde dikey olarak ambalajlanır.

#### A-Frame

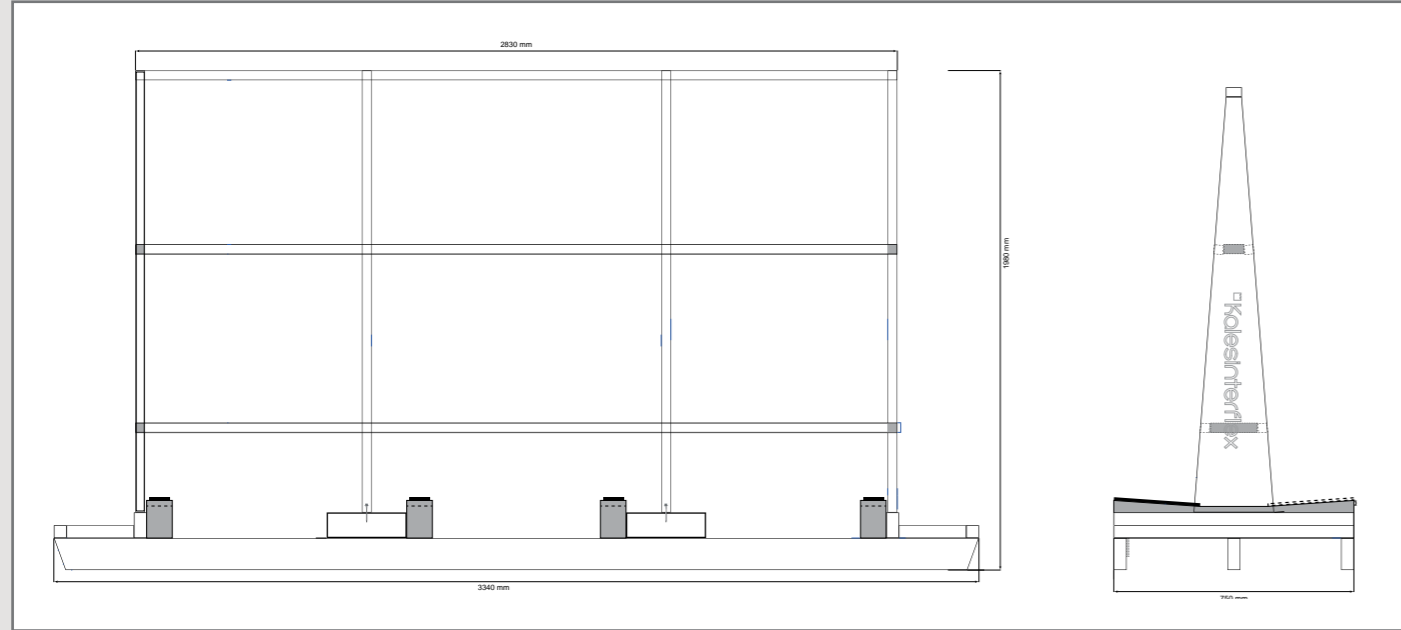

## 162x323 cm Quantity, Weight and Size Information of A-Frame;

### 162x323 cm A-Frame Metraj, Kilogram ve Ölçü Bilgileri;

Format /mm (vertical stacking) (dikey istifleme)	Thickness Kalınlık (mm)	Pcs for A-Frame (Pcs / A-Frame) A-Frame için adet (Adet / A-Frame)	m <sup>2</sup> for A-Frame A-Frame için m <sup>2</sup>	Weight (kg) for A-Frame (A-Frame is included.) Ağırlık (kg) A-Frame için (A-Frame dahil)	Full Size of A-Frame A-Frame'in Tam Boyutu (cm)
Kalesinterflex 6mm Full Length* Tam Boy* 1620x3230mm 63.7"x127.7"	6	44	230.12	3420	334x75x198h
Kalesinterflex 12mm Full Length* Tam Boy* 1620x3230mm 63.7"x127.7"	12	24	125.52	3782	334x75x198h
Kalesinterflex 20mm Full Length* Tam Boy* 1620x3230mm 63.7"x127.7"	20	12	62.76	3173	334x75x198h

\*"Furnace Slab" having untrimmed format. 5,23 m<sup>2</sup>/piece-Empty A-Frame 130kg (metal)

\* Tıraşlanmamış "fırın çıkışı" formatı plaka. 5.23m<sup>2</sup>/adet - Boş A-Frame 130kg (metal)

## 160x320 cm Quantity, Weight and Size Information of A-Frame;

### 160x320 cm A-Frame Metraj, Kilogram ve Ölçü Bilgileri;

Format /mm (vertical stacking) (dikey istifleme)	Thickness Kalınlık (mm)	Pcs for A-Frame (Pcs / A-Frame) A-Frame için adet (Adet / A-Frame)	m <sup>2</sup> for A-Frame A-Frame için m <sup>2</sup>	Weight (kg) for A-Frame (A-Frame is included.) Ağırlık (kg) A-Frame için (A-Frame dahil)	Full Size of A-Frame A-Frame'in Tam Boyutu (cm)
Kalesinterflex 6mm Full Length* Tam Boy* 1600x3200mm 63.0"x126.0"	6	44	225.28	3348	334x75x198h
Kalesinterflex 12mm Full Length* Tam Boy* 1600x3200mm 63.0"x126.0"	12	24	122.88	3703	334x75x198h
Kalesinterflex 20mm Full Length* Tam Boy* 1600x3200mm 63.0"x126.0"	20	12	61.44	3108	334x75x198h



## 162x323 cm Information Regarding the A-Frame Carrying Capacities of Containers and Trucks

162x323 cm Konteyner ve Tır A-Frame Kapasite Bilgileri

Container Loading with A-Frame / A-Frame Konteyner Yükleme									
(1620x3230mm (63.7"x127.7"))									
Container Type Konteyner Tipi	20" Container Konteyner			40" Container Konteyner			Truck / Tır (13.60m)		
The Thickness of the Slab Slab Kalınlık (mm)	6	12	20	6	12	20	6	12	20
A-Frame That Can Be Loaded (Pieces) Yüklenebilir A-Frame (Adet)	3	3	3	7	7	7	7	7	7
Slabs That Can Be Loaded (Pcs) Yüklenebilir Slab (Adet)	132	72	36	308	168	84	308	168	84
Loadable Area Yüklenebilir (m <sup>2</sup> )	690.36	376.56	188.28	1610.84	878.64	439.32	1610.84	878.64	439.32
Maximum Total Weight Azami toplam ağırlık (kg)	10.260	11.346	9.519	23.940	26.474	22.212	23.940	26.474	22.212

\* Empty weight of A-Frame 121kg (metal)

\* Bos A-Frame ağırlığı 130kg (metal)

## 160x320 cm Information Regarding the A-Frame Carrying Capacities of Containers and Trucks

160x320 cm Konteyner ve Tır A-Frame Kapasite Bilgileri

Container Loading with A-Frame / A-Frame Konteyner Yükleme									
(1600x3200mm (63.0"x126.0"))									
Container Type Konteyner Tipi	20" Container Konteyner			40" Container Konteyner			Truck / Tır (13.60m)		
The Thickness of the Slab Slab Kalınlık (mm)	6	12	20	6	12	20	6	12	20
A-Frame That Can Be Loaded (Pieces) Yüklenebilir A-Frame (Adet)	3	3	3	7	7	7	7	7	7
Slabs That Can Be Loaded (Pcs) Yüklenebilir Slab (Adet)	132	72	36	308	168	84	308	168	84
Loadable Area Yüklenebilir (m <sup>2</sup> )	675.84	368.64	184.32	1576.96	860.16	430.08	1576.96	860.16	430.08
Maximum Total Weight Azami toplam ağırlık (kg)	10.044	11.109	9.324	23.436	25.921	21.756	23.436	25.921	21.756

# 1. Carrying and Storing

## 1. Taşıma ve Depolama

Kalesinterflex 1620x3230mm slabs should be carried in safe conditions to protect their original appearance and prevent accidental damage. It is recommended to be careful and make sure that the carrying area is closed to pedestrians while the product is carried.

*Kalesinterflex 1620x3230mm plakaların taşınması, malzemenin orijinal görünümünü korumak ve kazara kırılmalarını önlemek için güvenli koşullarda gerçekleştirilmelidir. Malzemenin taşınması aşamalarında, alanın yayalara kapalı olduğundan emin olarak dikkat gösterilmesi tavsiye edilir.*

## 1.1. Carrying A-Frame with a Forklift

### 1.1. Forklift ile A-Frame Taşıma

A-Frame should be symmetrically loaded before carrying to prevent balance problems. Before carrying, the operator should always check that the slabs are fixed to A-Frame with special tapes. It is recommended to be careful while carrying the slabs loaded on the A-Frame since they are not protected at the points corresponding to the outer edges.

A-Frame's are equipped with two gripping points to be carried with a forklift:

The distance between the forklift's forks for "A" front gripping point is 740mm. The distance between the forks for the "B" lateral gripping point is 500mm.

If both A and B lateral loading points are to be used, a forklift that has 8000 kg. maximum load capacity is recommended. The Kalesinterflex porcelain slabs loaded on the A-Frame in the warehouse or near the transformer should be preferably carried by using the "A" front gripping point. In other words, the process should be carried out by using a 3230mm A-Frame, to which the products are to be fixed, and a forklift that has 1200mm long forks at least, and a 5000-8000 kg load capacity. If the 'B' gripping point is to be used, a forklift that has an 8000 kg load capacity and at least 2800mm forks should be used. It should be ensured that the load does not move on the forks. While loading and unloading trucks and containers, fix A-Frame with the help of the two "A" and "B" gripping points in the way specified in the following paragraphs, respectively. While loading/unloading the trucks and containers and carrying even a single slab, fix the slabs to A-Frame with cloth or plastic tapes / straps. Metal chains should not be used at this stage.

Before the slabs are taken out from the A-Frame, it is necessary to place it on a flat surface having no defects that may cause the slab(s) to fall.

*Taşımadan önce, dengesizlik problemlerini önlemek için A-Frame simetrik olarak yüklenmelidir. Operatör taşımaya geçmeden önce, plakaların özel bantlarla A-Frame sabitlenmiş olduklarını daima kontrol etmelidir. A-Frame üzerine yüklenen plakalar dış kenarlara karşılık gelen noktalarda korunmadığından, malzemeyi taşıma aşamaları esnasında dikkatli olunması önerilir.*

*A-Frame'ler forklift ile taşıma için iki kavrama noktası ile donatılmıştır:*

*"A" ön kavrama noktası; En az 740mm forklift bıçak aralığı mesafesi. "B" yanal kavrama noktası bıçak aralığı mesafesi 500mm'dir.*

*Eğer A ve B yan al yükleme noktalarından her ikisi de kullanılacak ise max. 8000 kg kapasiteli forklift tercih edilmesi önerilir. Depodaki veya transformatör yakınındaki A-Frame üzerine yüklenmiş Kalesinterflex porselen plakaların taşınması, tercihen ön kavrama noktası "A" kullanılarak, yani A-Frame 3230mm tarafından en az 1200mm uzunluğunda çatallar ve en az 5000-8000 Kg kapasiteye sahip bir forklift kullanmak suretiyle sabitleyerek gerçekleştirilmelidir. Kavrama noktası 'B' kullanılıyorsa, en az 2800mm uzunluğunda çatallara sahip 8000 Kg kapasiteli bir forklift kullanılmalıdır.*

*Yükün çatallar üzerinde sabit durduğundan ve sallanmadığından emin olunmalıdır. Kamyonlardan ve konteynerlerden yükleme ve boşaltma aşamalarında, sırasıyla aşağıdaki paragraflarda belirtilen "A" ve "B" iki kavrama noktası yardımıyla A-Frame sabitleyin. Yüklerken/boşaltırken ve ardından tek bir plakayı bile taşıırken, bez veya plastik bantlar / kayışlar kullanarak plakayı A-Frame sabitleyin. Bu aşamada metal zincirler kullanılmamalıdır.*

*Plakalar A-Frame sabitleyen bantlardan serbest bırakılmadan önce, A-Frame, plakanın / plakaların düşmesine neden olabilecek zemin seviye farklılıklarının olmadığı düz bir yüzeye yerleştirildiğinden emin olunması gerekmektedir.*

Forklift with 5000 weight (kg)  
capacity to carry from direction A

*A yönünden taşıma için 5000 kg  
kapasiteli forklift*

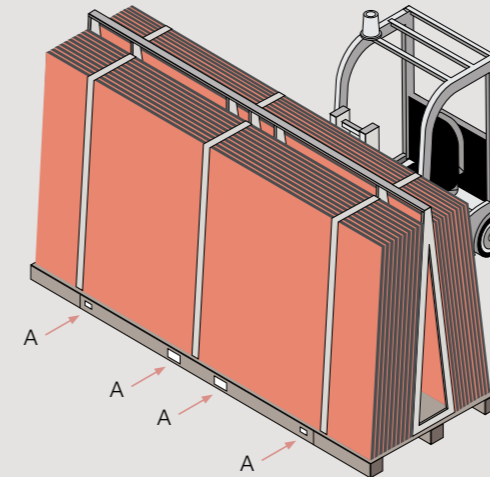

Forklift with 8000 weight (kg)  
capacity to carry from direction B

*B yönünden taşıma için 8000 kg  
kapasiteli forklift*

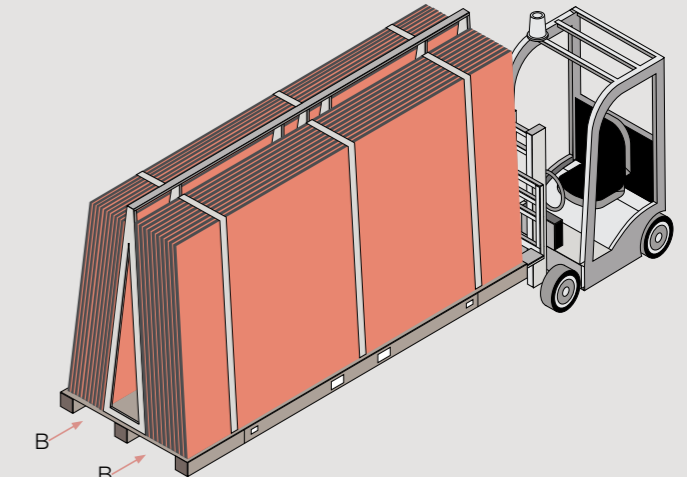



## 1.1.1. Loading / Unloading the Truck with A-Frame

### 1.1.1. Kamyon Üzerine A-Frame Yükleme / Boşaltma

To load and unload the trucks which have dropside bodies, fix the A-Frame by placing the forklift forks at two "A" gripping points and leaving at least a distance of 740mm between them. Forklift forks with a minimum length of 1200mm should be used to place the A-Frame in the middle of the truck.

To safely carry the products on the vehicles, fix the A-Frame's to the truck bed from the base and top. Use polyester or similar straps for this work. If you load several rows of A-Frame's, you should leave a distance of at least 50mm between them.

During loading and unloading, the operator should be careful about the people around. A-Frame should always be kept low while being carried and only be lifted when it is very close to the truck. You will find below an example of loading an A-Frame on a truck with a standard length of 13.60m.

Wooden boards having at least 7x9cm sizes, which are placed in the forklift lifting slots, are used to bolster the A-Frame's.

*Kenarları açılan kamyonlara yüklemek ve boşaltmak için, forklift çatallarını en az 740mm forklift bıçak açıklığı olacak şekilde iki kavrama noktasına "A" yerleştirerek A-Frame'i sabitleyin. A-Frame kamyonun merkezi konumuna yerleştirmek için minimum 1200mm uzunluğa sahip forklift çatallar kullanılmalıdır.*

*Araçlar üzerinde güvenli taşıma için, A-Frame'leri kamyon kasasına hem tabandan hem de yapının üst kısmından sabitleyin. Bu amaçla polyester veya benzeri kayışlar kullanın. Birkaç sıra A-Frame yüklerken arasında en az 50mm mesafe bırakın.*

*Yükleme ve boşaltma sırasında operatör çevredeki insanlara dikkat edilmelidir. A-Frame yük taşıma sırasında her zaman alçak tutulmalı ve yalnızca kamyonu çok yakın iken yukarı kaldırılmalıdır. Aşağıda 13,60m standart uzunluktaki bir kamyon için bir A-Frame yükleme örneği gösterilmiştir*

*A-Frame'leri desteklemek için forkliftin taşıma yuvalarından geçen en az 7x9cm kesitli latalar kullanılır.*

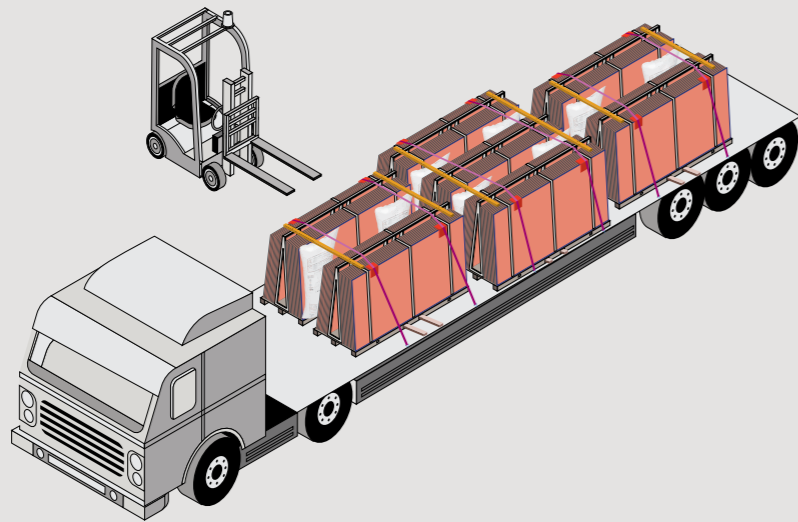

## 1.1.2. Domestic and International Highway Transportation with Truck

### 1.1.2. Yurt içi ve Yurt dışı Karayolu Kamyon Taşıma

In international transportation with trucks, two A-Frame's are fixed to the vehicle chassis with at least two safety ropes. Airbag or styrofoam is used as abolster between the two A-Frame's.

*Yurtdışı Kamyon ile taşımada, iki A-Frame en az 2 spanzet ile araç şasisine bağlanır ki A-Frame arasında destek olarak hava yastığı veya strafor kullanılır.*

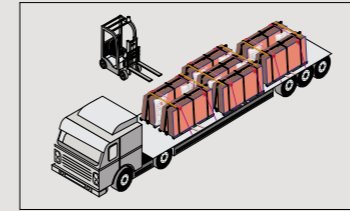
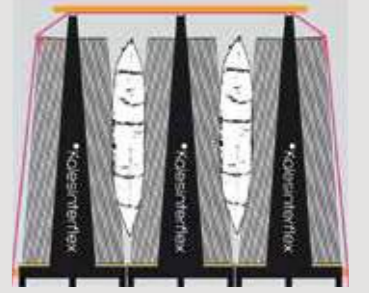

Domestic and international highway transportation with trucks.

Yurt içi ve yurt dışı karayolu kamyon taşıma.



Domestic and international highway transportation with trucks.

Yurt içi ve yurt dışı karayolu kamyon taşıma.

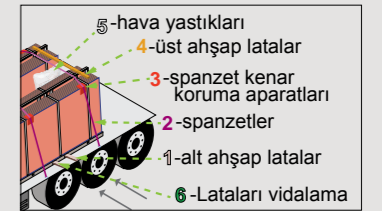

Domestic and international highway transportation with trucks.

Yurt içi ve yurt dışı karayolu kamyon taşıma.

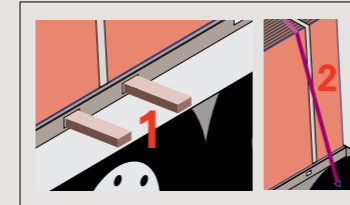

1- To support one or three A-Frame's in a row, two wooden boards, which have at least 7x9cm cross-sections and 240cm lengths, are used and placed in the forklift lifting slots.  
2- A-Frame's are fixed to the trailer with at least two safety ropes that will pass through the top profile of the Frame's. **The safety ropes should not be over-tightened.**

1- Bir sıradaki 1 veya 3 A-Frame'leri desteklemek için, forkliftin taşıma yuvalarından geçen, 2 adet en az 7x9cm kesitli 240cm boyunda latalar kullanılır.  
2- A-Frame'lerin en üst profilinden geçecek, en az 2 adet spanzet ile dorseye bağlanır. **Spanzetin aşırı sıkılmamasına dikkat edilmeli.**

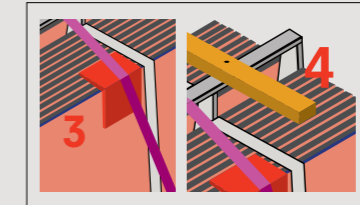

3- Protective plastic supports are placed on the edges where the safety ropes touch the slab.  
4- The two or three A-Frame's in a row are screwed to the wooden boards from their upper profiles and thus, their movement is restricted.

3- Spanzetlerin slab ürüne temas ettiği kenarlara koruyucu plastik destekler konur.  
4- Bir sıradaki 2 veya 3 A-Frame'ler, vida yardımı ile üst profillerinden latalarla birleştirilerek hareket etmeleri kısıtlanır.

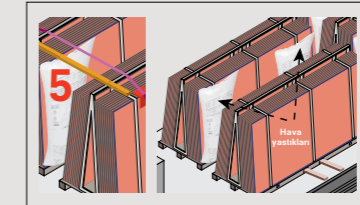

5- Two airbags are vertically placed between the A-Frame's in each row.

5- Her sıradaki A-Frame'lerin arasına ikişer adet dikey şekilde hava yastığı konur.

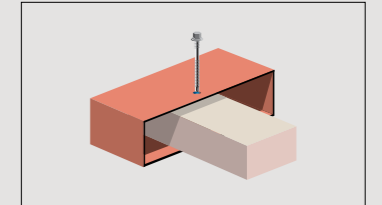

Wooden boards are screwed from the slots where the forklift forks are inserted. Two or three A-Frame's are fixed by screwing the wooden boards, which have been passed through the Frame's, to the outward-facing sides of the truck trailer. If there is no screw hole on the A-Frame, it is fixed with 5.5x90 DIN7504k, Hexagon drill-tip trapeze-panel screws with EPDM Rubber Washer.

Foklift bıçaklarının girdiği yuvalardan latalar vidalama yapılır ki veya üç A-Frame, içinden geçirilen latalar kamyon kasasında dışa bakan taraflardan vidalanarak sabitlenir. A-Frame'de hazır vida deliği yok ise 5,5x90 DIN7504k Altı köşe, Epdm Pullu, matkap uçlu trapez-panel vidaları ile sabitlenir.

## 1.1.3. Loading / Unloading Container with A-Frame

### 1.1.3. Konteyner üzerine A-Frame Yükleme / Boşaltma

Use a pallet jack or forklift with a 8000 kg load capacity and forks of at least 2800mm while the products are loaded on the container, and the container is unloaded. The operator moves the loaded A-Frame after taking and lifting the load with the help of the two "B" gripping points.

During loading, check the balance of the product by fixing the A-Frame's to each other and the towing platform. To carry the Frame's safely on the container, fill the gaps between the sca olds and between the sca old rows and airbags. Before the unloading, always check the methods used while locking the A-Frame's, to remove the locks.

Outside the container, carry the product by attaching the A-Frame's to the "A" gripping point every time.

*Konteyner içine malzemenin yüklenmesi ve boşaltılması aşamalarında bir transpalet veya minimum 2800mm uzunluğunda çatallar ile donatılmış 8000 kg kapasiteli bir forklift kullanın. Operatör, iki kavrama noktası "B" yardımıyla yükü alarak ve kaldırarak dolu A-Frame hareket ettirir.*

*Yükleme sırasında, A-Frame'ları birbirine ve çekme platformuna bağlayarak ve sabitleyerek malzemenin doğru dengesini kontrol edin. Konteyner üzerinde güvenli taşıma için, iskeleler arasındaki ve iskele sıraları arasındaki boşlukları hava yastıklarıyla doldurun.*

*Boşaltma aşamasından önce, kilitlerin etkili bir şekilde çıkarılmasını sağlamak için, daima A-Frame'ların kilitledikleri yöntemi kontrol edin. Konteyner dışında, malzemeyi daima A-Frame'ları "A" kavrama noktasına tutturarak taşıyın.*

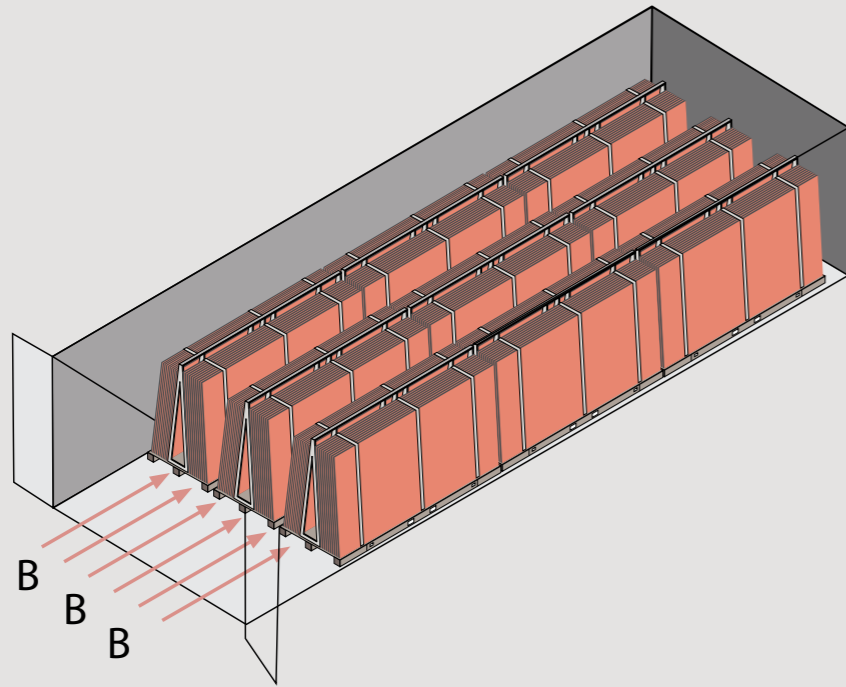

For loading / unloading the slabs, as seen in the picture below, a special lifting tool with belts, which is installed on a forklift having a load capacity of 5000-8000 kg. should be used. On the other hand, a crane equipped with a lifting arm, which is usually used to carry slabs, can be utilized.

*Bu Plaka yüklenmesi / boşaltılması için, forklifte uygulanmış aşağıdaki resimdeki gibi vakumlu özel bir kaldırma ekipmanı veya alternatif olarak genellikle plakaları taşımak için kullanılan kaldırma kolu ile donatılmış bir vinç kullanılmalıdır.*





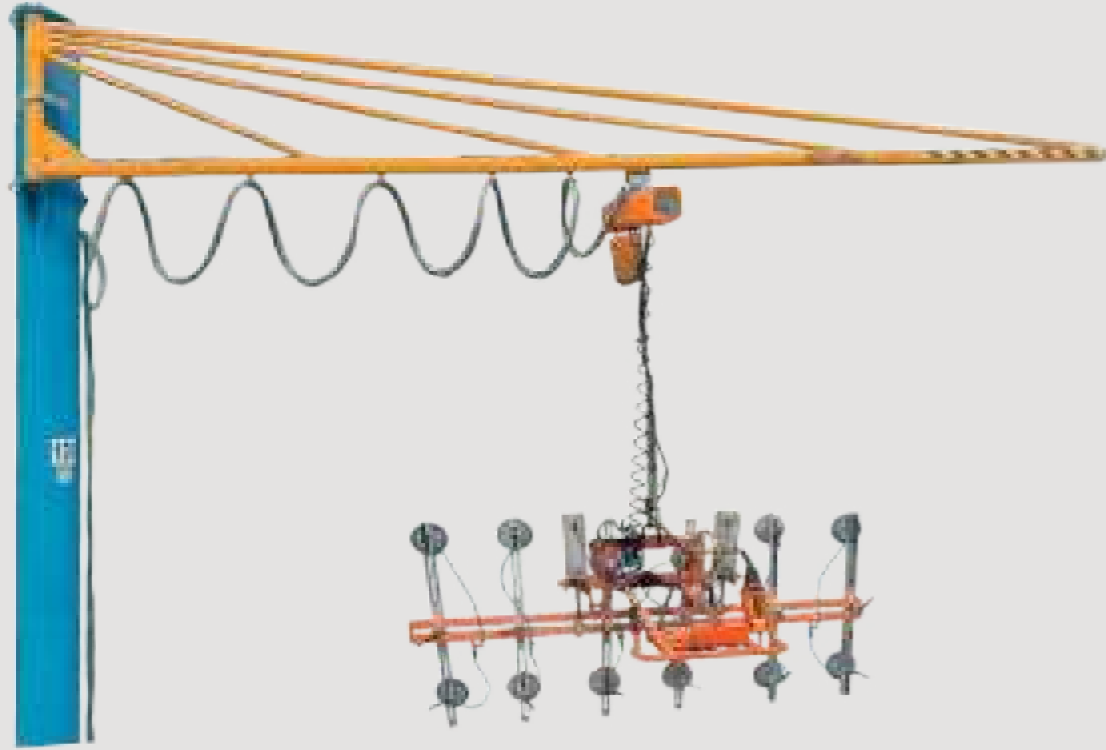

We recommend you use a similar tool and follow the same method to prevent imbalance and accidental damage during the unloading period.

Regardless of the method used for storing, other materials should not be put on Kalesinterflex porcelain slabs, especially on glossy surfaces.

If it is necessary to put them on top of each other, there should be no contact between the slabs. If the products are to be transferred from A-Frame to A-Frame one by one, precautions should be taken against surface damage that may occur.

*Boşaltırken dengesizliği ve kazayla kırılmayı önlemek için benzer bir alet kullanmanızı ve aynı çalışma yöntemini takip etmenizi öneririz.*

*Depolama için kullanılan yöntem ne olursa olsun, Kalesinterflex porselen plakalar üzerine, özellikle parlak yüzeyler üzerine başka malzemelerin üst üste konmamasıdır.*

*Üst üste koymak gerekiyorsa, plakaların aralarından temas kesilmelidir. Ürünleri tekil olarak A-Frame'den A-Frame'e aktarılırken oluşabilecek yüzey hasarlanmalarına karşı önlem alınmalıdır*

## 1.1.4.Safety Criteria

### 1.1.4.Güvenlik Kriterleri

#### Instruction for Slab Loading / Unloading / Transportation

*Porselen Plaka Yükleme / Boşaltma / Taşıma Talimatı*

#### DİKKAT! ATTENTION!

Konteyner ve Tır / Kamyon yükleme ve boşaltma içindir.  
Container and truck for loading and unloading.

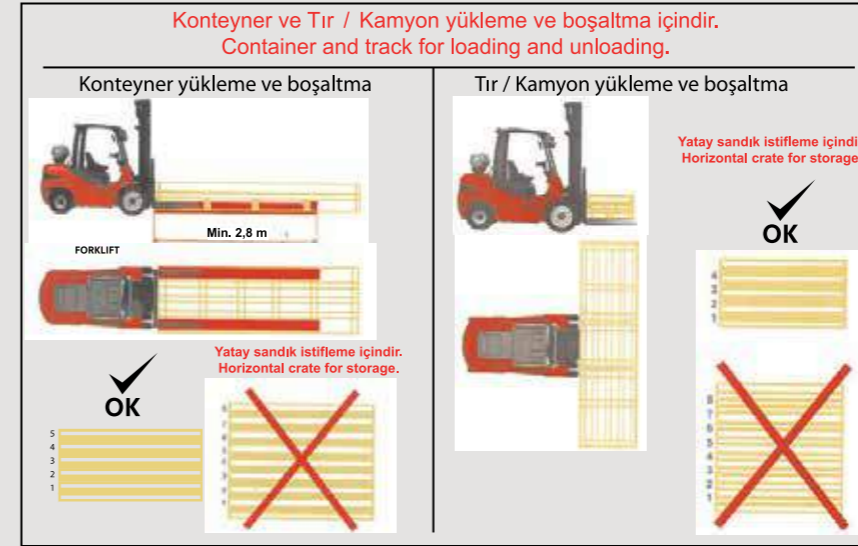

#### DİKKAT! ATTENTION!

Konteyner ve Tır / Kamyon yükleme ve boşaltma içindir.  
For container and truck loading and unloading.

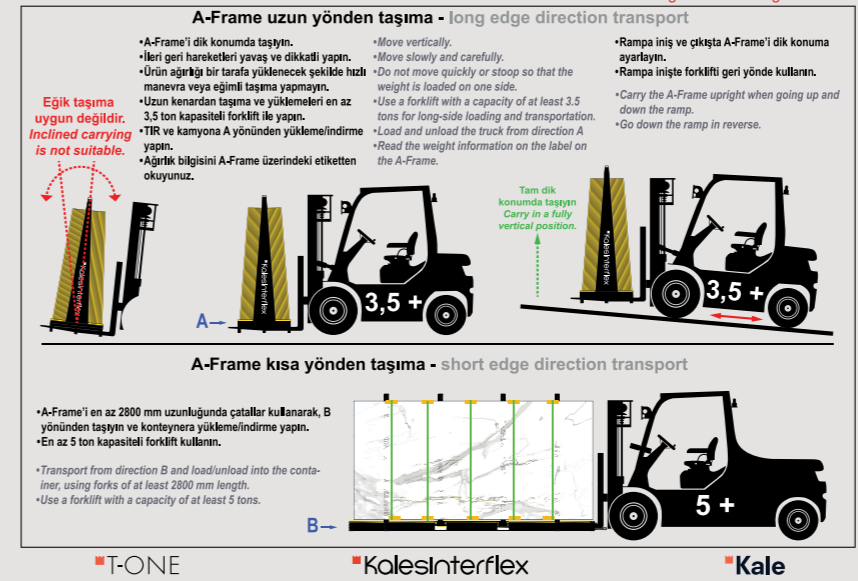

T-ONE

Kalesinterflex

Kale

## Kalesinterflex® AHŞAP YATAY AMBALAJ SANDIĞI AÇMA, BOŞALTIMA VE ÜRÜN TAŞIMA TALİMATI

INSTRUCTION FOR OPENNING, UNLOADING AND HANDLING THE Kalesinterflex® HORIZONTAL WOODEN CASE

1. YATAY SANDIĞIN SADECE ÜST KAPAĞINI AÇIN. Kalesinterflex® İNCE KENARININ ÜZERİNE KALDIRIP (ŞEKİL 1), VAKUMLU TAŞIMA APARATI İLE VEYA YERE DİK TUTARAK SPANZET İLE TAŞIYIN. İNSAN GÜCÜ İLE TAŞIMA İÇİN EN AZ 5 KİŞİ EL VAKUMLU APARATLARI İLE YERE DİK OLARAK TAŞIMALIDIR.
2. Kalesinterflex® İ KESİNLİKLE YERE PARALEL ESNETEREK TAŞIMAYINIZ.
3. YATAY SANDIĞIN YAN TAHTALARINI AÇARAK BOŞALTIMA KESİNLİKLE YAPMAYINIZ.
4. DOĞRU TAŞIMA YÖNTEMİ OLARAK AYRICA Kalesinterflex® İN YERE DİK TUTULARAK VANTUZ İLE 5 KİŞİ TARAFINDAN TAŞINMASI TAVSİYE EDİLİR.

1. OPEN ONLY THE TOP COVER OF THE HORIZONTAL CASE. LIFT Kalesinterflex® ON ITS THIN SIDE (Figure 1). CARRY IT WITH THE VACUUM CARRYING APPARATUS OR KEEP IT VERTICAL TO THE FLOOR WITH A SPANZET. FOR HANDLING WITH PEOPLE, AT LEAST 5 PEOPLE SHOULD CARRY IT UP TO THE GROUND WITH HAND VACUUM APPARATUS.
2. PLEASE DO NOT BEND THE SLAB IN A PARALLEL POSITION TO GROUND.
3. PLEASE DO NOT UNPACK THE PRODUCT BY REMOVING THE SIDE WALLS OF THE CASE.
4. FOR PROPER HANDLING, IT IS RECOMMENDED TO HOLD THE Kalesinterflex® VERTICALLY AND HANDLE THE SLABS WITH SUCTION CUPS BY TWO STAFF.

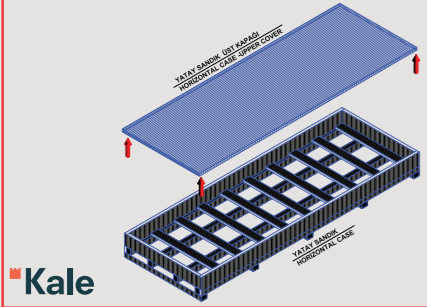

Kale

TAŞIMA ÖNERİLERİ CARRYING RECOMMENDED



ŞEKİL 1  
FIGURE 1

Kalesinterflex®

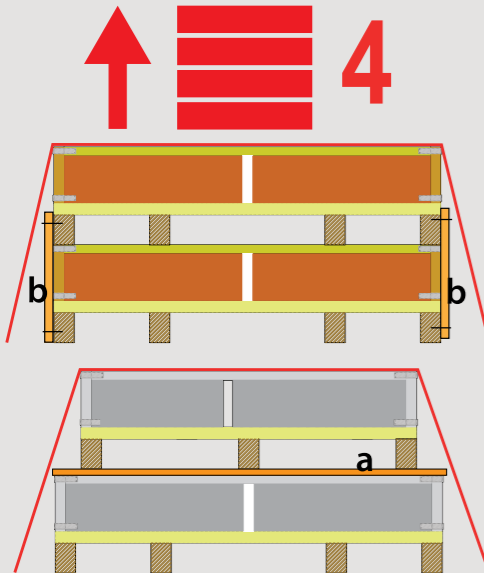

### KALESINTERFLEX SANDIKLARININ YÜKLEME TALİMATI

#### LOADING INSTRUCTION FOR KALESINTERFLEX CHESTS

Aynı ebata sahip en fazla 4 sandık üstü üste istiflenebilir. Aynı boyuttaki sandıklar ayakları her yönden bir biri üzerine hizalanacak şekilde dizilir. Ayaklar, kapağın destek-siz kısımlarına basmamalıdır. Sandıklar ayaklarından birbirine lata (b) ile vidalanarak sabitlenir.

Farklı boyutlarda sandıklar dizilirken küçük ve hafif olan büyük ve ağır olan üzerine konulur. Sandıklar arasında destek malzemeler (lata/kalas) (a) konulur ve kaymayı önlemek için ayaklardan lata (b) ile vidalanarak sabitlenir.

Tüm sandıklar spanzet ile kamyon kasasına veya konteynra bağlanarak sabitlenir.

A maximum of 4 crates of the same size can be stacked on top of each other.

Crates of the same size are arranged so that their legs are aligned on top of each other from all directions. Feet should not step on unsupported parts of the cover. The crates are fixed to each other by screwing their legs with laths (b).

While crates of different sizes are arranged, the small and light ones are placed on top of the large and heavy ones. The legs are aligned on at least two edges, support materials (laths/planks) (a) are placed between the crates and the legs are fixed by screwing with laths (b) to prevent slipping. All crates are fixed to the truck or container with spanners.

Kale Kalesinterflex

## Instruction for Empty A-Frame Loading

Boş A-Frame Yükleme Talimatı

### DİKKAT! ATTENTION!

Tır / Kamyon ile A-Frame taşıma içindir.  
For A-Frame transportation by truck

#### Boş A-Frame taşıma talimatı - Empty A-Frame transport instructions

Matters to be considered in the loading instruction:

- Empty A-Frames should be loaded with a forklift from the side.
- There should be two people on the trailer for support during the loading.
- The first A-Frame in the figure is loaded first. The second A-frame is carried by the forklift and placed on the third A-frame with the support of the two people.
- The fourth A-frame is placed on the third A-frame and the wedge, as shown in the image, with the support of the two people.
- Each loaded A-Frame is tied and fixed with a safety rope or steel rope.

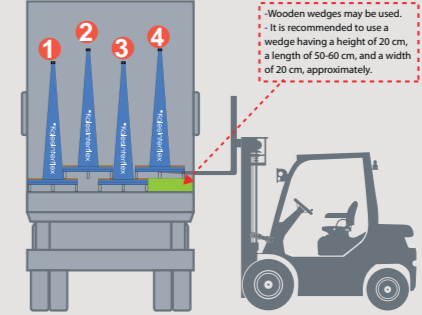

Loading horizontally a total of 16 pieces of 75x335x198cm A-Frames on the truck, in a row of 4x4, in 4 groups, each containing four frames

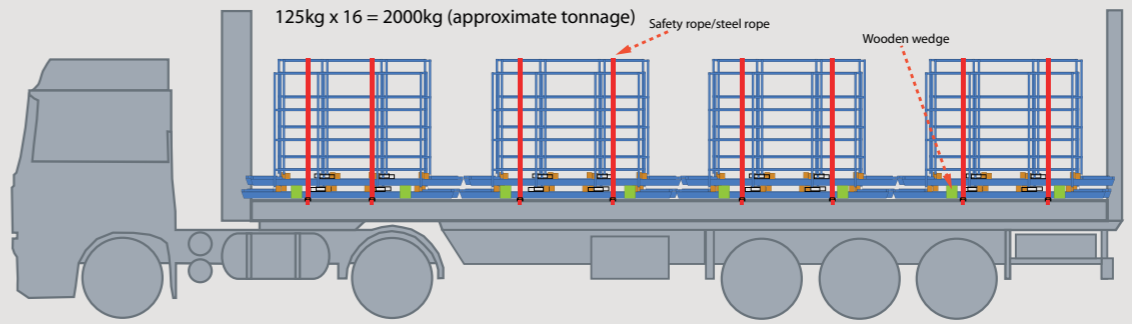

T-ONE

Kalesinterflex

Kale



# 1. Loading Instruction for Kalesinterflex Chests

## 1. Kalesinterflex Sandıklarının Yükleme Talimatı

- Up to 4 crates of the same size may be stacked on top of one another.
- Crates of the same size are lined by enabling their feet to overlap on top of one another from all directions. The feet should come across the unsupported parts of the cover. Crates are fixed to each other by screwing their feet to the wooden board (b).
- When lining up crates of different sizes, the small and light ones are placed on the large and heavy ones. Supporting materials (wooden board/plank) (a) are placed between the crates and **the feet of the crates are fixed by screwing them to the wooden board (b) to prevent slipping.**
- All crates are fixed by fastening them to the truck trailer or container with a safety rope.

- Aynı ebata sahip en fazla 4 sandık üst üste istiflenebilir.
- Aynı boyuttaki sandıklar ayakları her yönden bir biri üzerine hizalanacak şekilde dizilir. Ayaklar, kapağın desteksiz kısımlarına basmalıdır. Sandıklar ayaklarından birbirine lata (b) ile vidalanarak sabitlenir.
- Farklı boyutlarda sandıklar dizilirken küçük ve hafif olan büyük ve ağır olan üzerine konulur. Sandıklar arasına destek malzemeler (lata/kalas) (a) konulur ve **kaymayı önlemek için ayaklardan lata (b) ile vidalanarak sabitlenir.**
- Tüm sandıklar spanzet ile kamyon kasasına veya konteynıra bağlanarak sabitlenir.

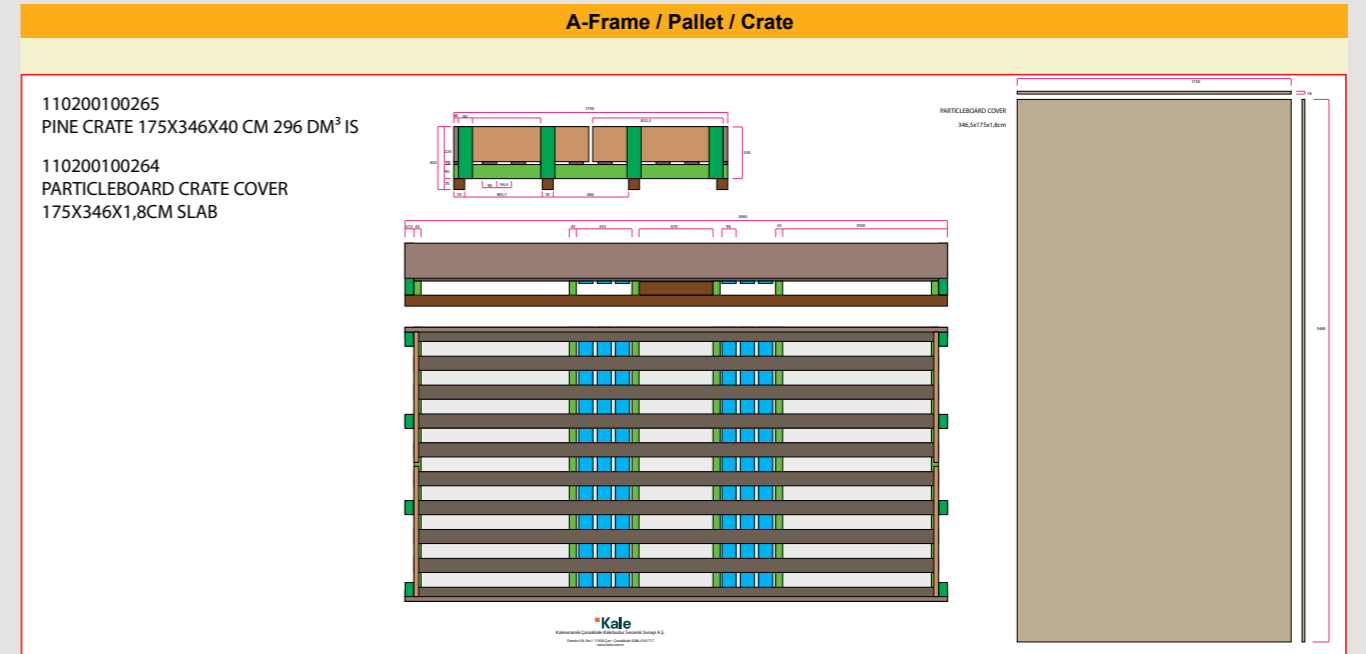
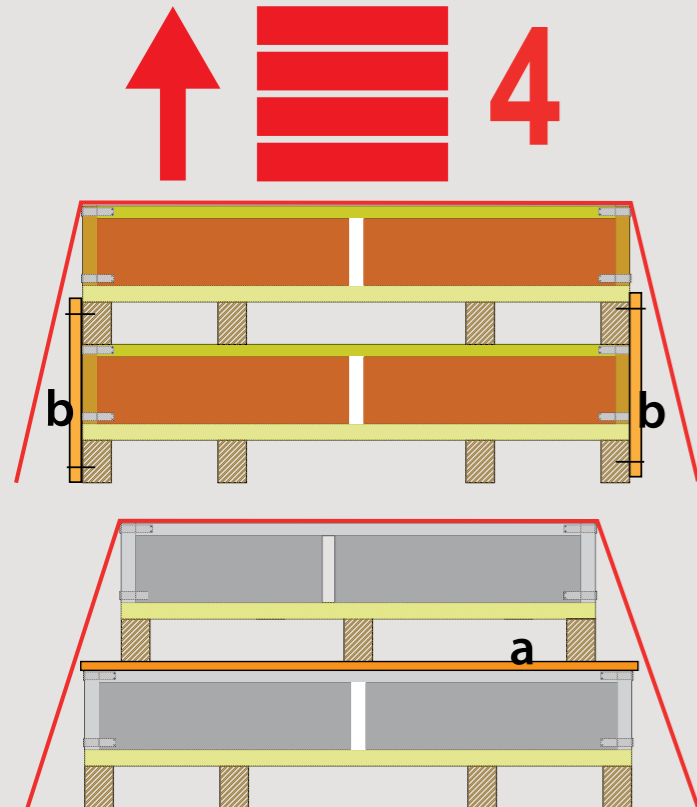

### Product Index of Packaging Materials

110200100265	PINE CRATE 175X346X40 CM 296 DM³ IS	1 piece
110200100264	PARTICLEBOARD CRATE COVER 175X346X1,8CM SLAB	1 piece
110200600050	STYROFOAM 60x100x2cm	18 pieces-to bottom and uppermost
110400100220	INSTRUCTION FOR SLAB-LOADING, UNLOADING AND CARRYING A&B	1 set (2 piece)
110200400134	LABEL 20X15CM 160X320 6-6,5MM 14A BX	2 piece
100200300086	STRETCH HOOD 2900-550-550 MM BX	1 piece

### Unit Quantity Definitions

	Piece	Piece/Crate	40" Container
Piece	1	14	15
m2	5,120	71,680	1075,2
Weight (kg)	73	1222	18330
Size	160x320		
Thickness	6-6,5 mm		
Row/Layer		14	

### Labels and Marking / Tying

#### Part Label / Marking



100x150mm parça etiketi

#### A-Frame/ Pallet / Crate Label



Instructions to be attached to the crate  
110400100220 INSTRUCTION FOR SLAB-LOADING,  
UNLOADING AND CARRYING A&B

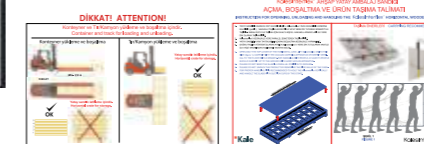

#### Tying

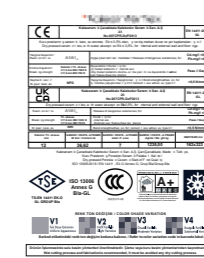

A-Frame / Pallet / Crate

110200100265  
PINE CRATE 175X346X40 CM 296 DM<sup>3</sup> IS  
  
110200100264  
PARTICLEBOARD CRATE COVER  
175X346X1,8CM SLAB

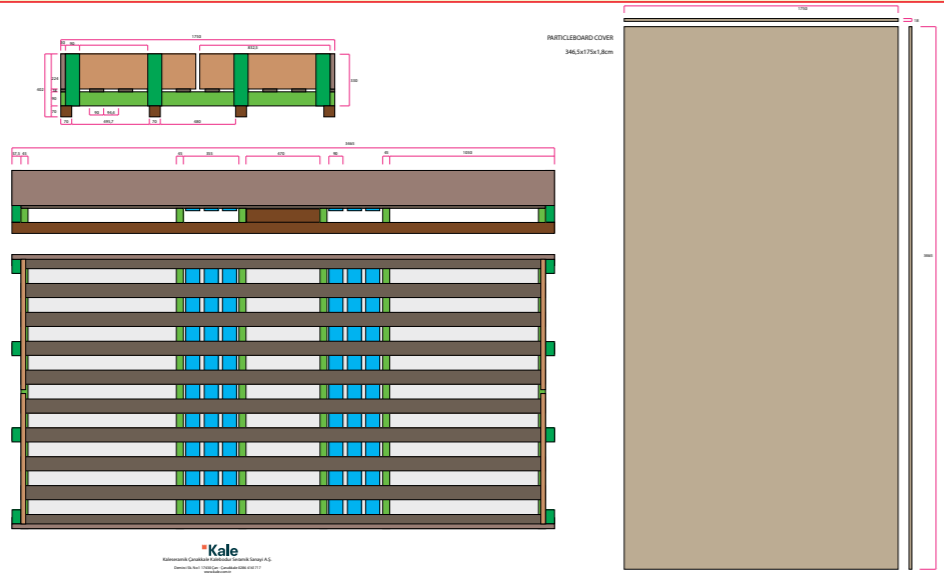

Product Index of Packaging Materials

110200100265	PINE CRATE 175X346X40 CM 296 DM <sup>3</sup> IS	1 piece
110200100264	PARTICLEBOARD CRATE COVER 175X346X1,8CM SLAB	1 piece
110200600050	STYROFOAM 60x100x2cm	18 pieces-to bottom and uppermost
110400100220	INSTRUCTION FOR SLAB-LOADING, UNLOADING AND CARRYING A&B	1 set (2 piece)
110200400134	LABEL 20X15CM 162X323 6-6,5MM 14A BX	2 piece
100200300086	STRETCH HOOD 2900-550-550 MM BX	1 piece

Unit Quantity Definitions

	Piece	Piece/Crate	40" Container
Piece	1	14	15
m2	5,23	73,22	1098,3
Weight (kg)	76,1	1265	18976
Size	162x323		
Thickness	6-6,5 mm		
Row/Layer		14	

Labels and Marking / Tying

Part Label / Marking



100x150mm parça etiketi

A-Frame/ Pallet / Crate Label



Pallet label 150x100mm

Instructions to be attached to the crate  
110400100220 INSTRUCTION FOR SLAB-LOADING, UNLOADING AND CARRYING A&B

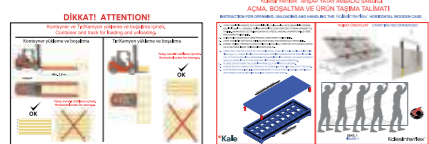

Tying



110200400134  
LABEL 20X15CM 160X320 6-6,5MM 14A BX

A-Frame / Pallet / Crate

110200100265  
PINE CRATE 175X346X40 CM 296 DM<sup>3</sup> IS  
  
110200100264  
PARTICLEBOARD CRATE COVER  
175X346X1,8CM SLAB

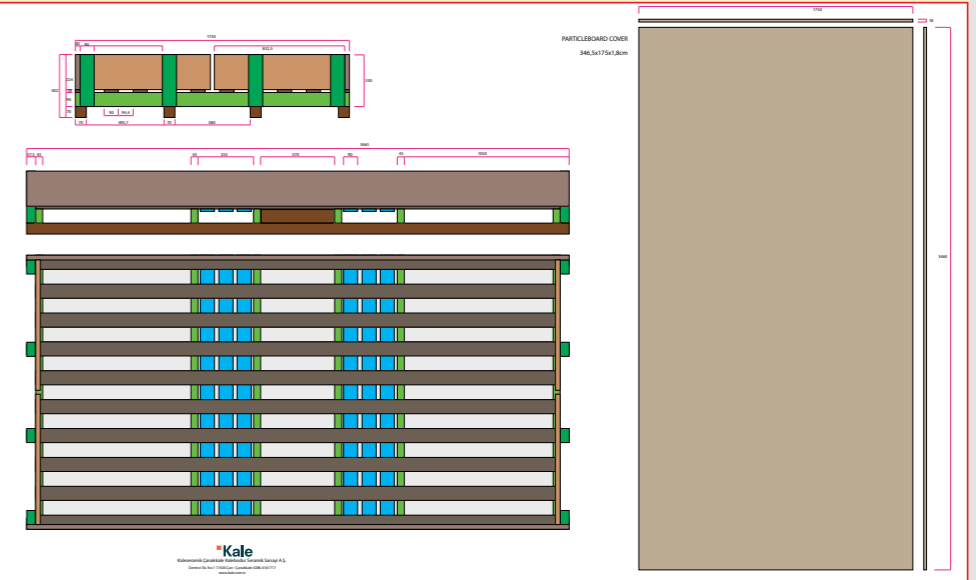

Product Index of Packaging Materials

110200100265	PINE CRATE 175X346X40 CM 296 DM <sup>3</sup> IS	1 piece
110200100264	PARTICLEBOARD CRATE COVER 175X346X1,8CM SLAB	1 piece
110200600050	STYROFOAM 60x100x2cm	18 pieces-to bottom and uppermost
110400100220	INSTRUCTION FOR SLAB-LOADING, UNLOADING AND CARRYING A&B	1 set (2 piece)
110200400134	LABEL 20X15CM 160X320 12MM 6A BX	2 piece
100200300086	STRETCH HOOD 2900-550-550 MM BX	1 piece

Unit Quantity Definitions

	Piece	Piece/Crate	40" Container
Piece	1	6	15
m2	5,12	30,720	460,80
Weight (kg)	148,9	1093	16399,0
Size	160x320		
Thickness	12 mm		
Row/Layer		6	

Labels and Marking / Tying

Part Label / Marking



100x150mm parça etiketi

A-Frame/ Pallet / Crate Label



110200400139  
LABEL 20X15CM  
160X320 12MM 6A BX



Pallet label 150x100mm

Instructions to be attached to the crate  
110400100220 INSTRUCTION FOR SLAB-LOADING, UNLOADING AND CARRYING A&B

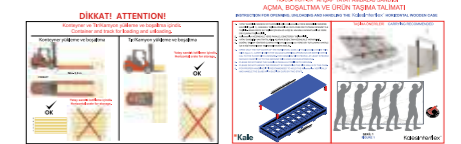



**A-Frame / Pallet / Crate**

110200100265  
PINE CRATE 175X346X40 CM 296 DM<sup>3</sup> IS  
  
110200100264  
PARTICLEBOARD CRATE COVER  
175X346X1,8CM SLAB

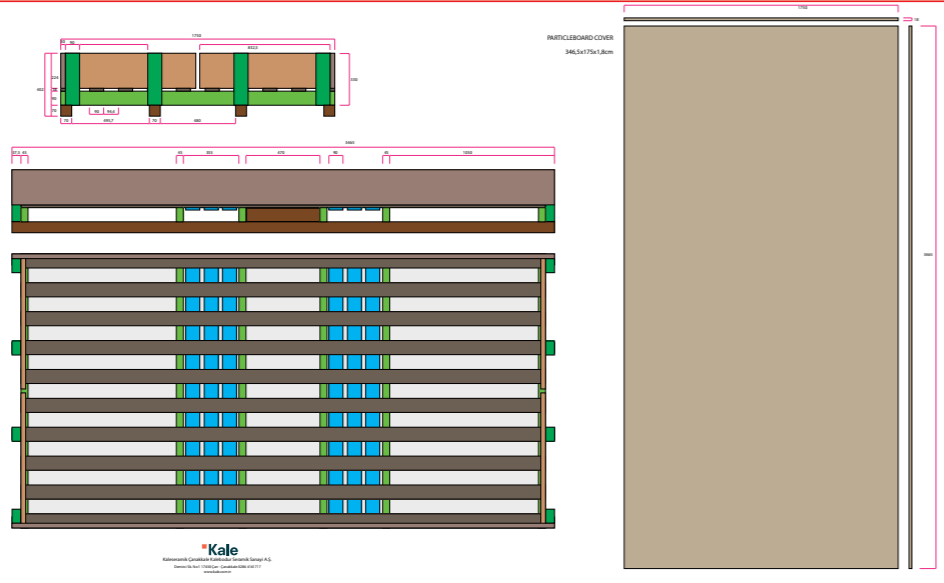

**Product Index of Packaging Materials**

110200100265	PINE CRATE 175X346X40 CM 296 DM <sup>3</sup> IS	1 piece
110200100264	PARTICLEBOARD CRATE COVER 175X346X1,8CM SLAB	1 piece
110200600050	STYROFOAM 60x100x2cm	18 pieces-to bottom and uppermost
110400100220	INSTRUCTION FOR SLAB-LOADING, UNLOADING AND CARRYING A&B	1 set (2 piece)
110200400134	LABEL 20X15CM 162X323 12MM 6A BX	2 piece
100200300086	STRETCH HOOD 2900-550-550 MM BX	1 piece

**Unit Quantity Definitions**

	Piece	Piece/Crate	40" Container
Piece	1	6	15
m2	5,23	31,38	470,7
Weight (kg)	152,2	1113,0	16694,0
Size	162x323		
Thickness	12 mm		
Row/Layer		6	

**Labels and Marking / Tying**

**Part Label / Marking**



100x150mm parça etiketi

**A-Frame/ Pallet / Crate Label**



Pallet label 150x100mm

**Tying**

Instructions to be attached to the crate  
110400100220 INSTRUCTION FOR SLAB-LOADING,  
UNLOADING AND CARRYING A&B

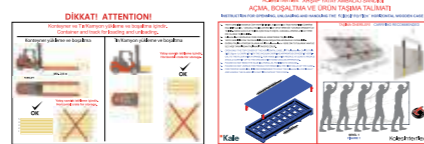

# Certificates

## Sertifikalar

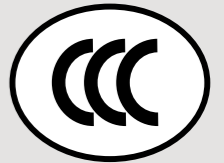







**Kale**

**Kaleseramik Çanakkale Kalebodur Seramik San. A.Ş.**  
Büyükdere Cad. Kaleseramik Binası 34330 Levent - İstanbul / Türkiye  
T: 0850 800 5253

kale.com.tr



Modiki 41040200177