



Appendix G

Vizion PMA Autopilot Piper PA-32 Installation

**RESTRICTION ON USE, DUPLICATION, OR DISCLOSURE OF
PROPRIETARY INFORMATION**

THIS DOCUMENT CONTAINS PROPRIETARY INFORMATION OF TRUTRAK FLIGHT SYSTEMS, INC. AND MAY NOT BE REPRODUCED, COPIED, DISCLOSED OR UTILIZED IN ANY WAY, IN WHOLE OR IN PART, WITHOUT THE PRIOR WRITTEN CONSENT OF TRUTRAK FLIGHT SYSTEMS, INC.

Prepared by

TruTrak Flight Systems, Inc.

	Function/Title	Name
Prepared by	Engineering	Zach Williamson
Prepared by	President	Andrew Barker
Checked by	GM	Moss Foster
Approved by	President	Andrew Barker



Table of Contents

1. Document Revision History.....	3
2. Piper PA-32 Servo Installation.....	4
2.1. Materials List	4
2.2. Pitch and Roll Servo Mounting Instructions	6
2.3. Piper PA-32 Vizion IPC	26
3. Piper PA-32 Controller / Wiring Harness Installation.....	28
3.1. Wiring Harness Materials List.....	28
3.2. Wiring Harness / Controller Mounting Instructions.....	29
4. Piper PA-32 Autopilot Settings.....	35
4.1. Lateral Autopilot Settings	35
4.2. Vertical Autopilot Settings.....	36



1. Document Revision History

Rev	Description	Pages	Date
IR	Initial Release	34	11-1-18

2. Piper PA-32 Servo Installation

2.1. Materials List

QTY	PART NUMBER	DESCRIPTION
1	8100-078 (12 Volt) OR 8100-079 (24 Volt)	100 in-lb PMA Servo
1	8100-064 (12 Volt) OR 8100-065 (24 Volt)	60 in-lb PMA Servo
1	8000-177	PMA Link Sensor
	8200-146	Piper PA-32 Hardware (Includes the following items)
1	7200-108	PA-32 Bellcrank (Raw)
1	7200-103	PA-28 Pitch Bracket Assembly
1	7200-102	PA-28 Roll Bracket Assembly
5	7200-097	2" PMA Servo Arm Assembly
1	2520-010	6" Push Rod
2	2510-052	CM-3B-14
2	2510-051	Small Rod End Bearing MM-3-300
2	2510-050	MS20219-2
1	2500-231	AN4-11A
1	2500-230	AN4-7A
9	2500-223	10-32 x 1/2" Flat Head 1/8" Hex Drive Zinc Plated Alloy Steel Screw
2	2500-222	AN4-6A
6	2500-216	8-32 x 3/8 Flat Head Socket Cap Screw SS
2	2500-208	AN90-416
3	2500-205	AN970-4 Washer
18	2500-121	MS20365-832 8-32 Fiberlock Nut
2	2500-113	MS20365-428 1/4-28 Fiberlock Nut
8	2500-081	MS35333-39 Internal Lock Washer
8	2500-076	AN960-10
6	2500-075	AN3-3A
3	2500-071	AN3-10A
18	2500-069	8-32 X 5/8 Screw AN526C832R10
1	2500-068	AN3-7A
6	2500-066	AN3-5A
2	2500-055	AN345-10
2	2500-054	AN315-4
4	2500-047	AN970-3 Washer
2	2500-044	10-32 x 3/8 Socket Head Cap Screw SS



18	2500-042	MS20364-1032
1	1420-233	PMA Capstan Wheel
1	1420-230	PMA Cable Clamp Half Plain
1	1420-229	PMA Cable Clamp Half Countersunk
4	1420-044	Cable Clamp Side
1	7200-113	PA-32 Bridle Cable
1	7200-102	PA-32 Fuel Line

2.2. Pitch and Roll Servo Mounting Instructions

NOTE: Apply torque seal to all bolts after final torquing is achieved.

1. The pitch and roll servos will be mounted to the lower fuselage skin under the rear seat as shown in Figure 2-1.

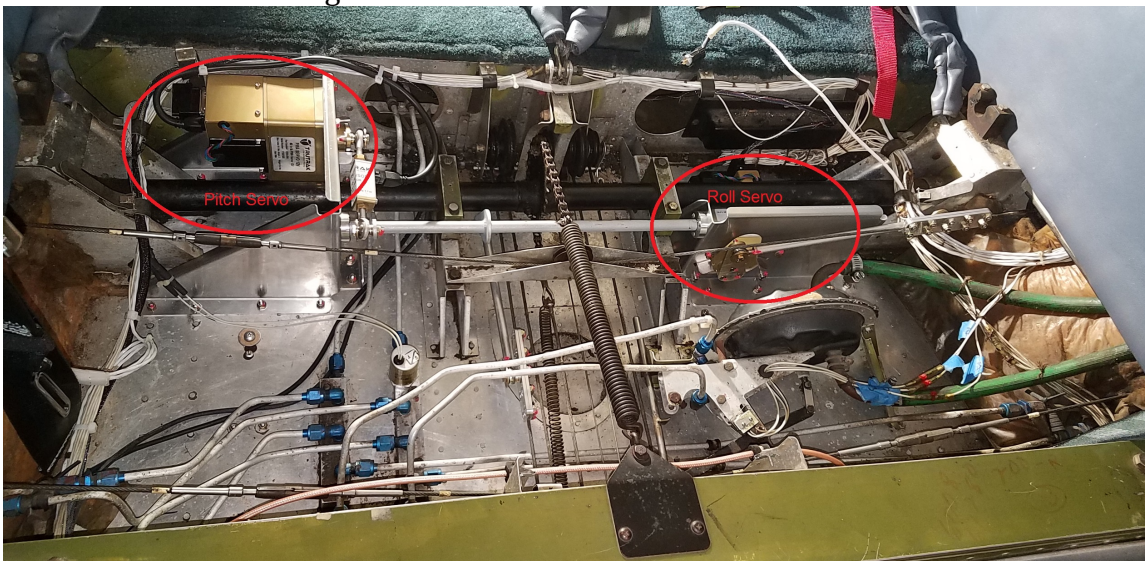

Figure 2-1

- 1.1. Remove the front and middle seats as well as the floor under the middle seat.
- 1.2. Verify that elevator and aileron cable tensions and control travels are adjusted according to the appropriate aircraft service manual.
- 1.3. Some aircraft have a fuel line routed as shown in Figure 2-2. If this style line is present remove and replace with the PA-32 Fuel Line (7200-109). Torque both nuts to 230 to 260 in-lb.

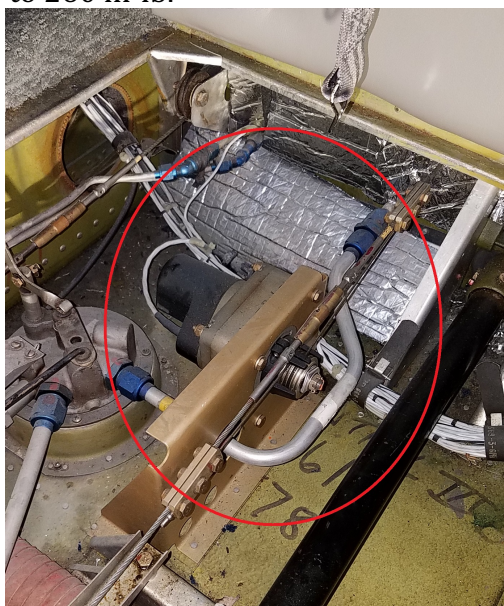

Figure 2-2

- 1.4. Remove the lower right interior panel as shown in Figure 2-3.



Figure 2-3

- 1.5. Place the PA-28 roll bracket assembly (P/N 7200-102) under the flap tube on the left side of the fuselage
- 1.6. Secure the PA-32 bellcrank (P/N 7200-108) to the PA-28 pitch bracket assembly (P/N 7200-103) with an AN4-6A as shown in Figure 2-4. Note that the end of the bellcrank connected to the pitch bracket assembly has an

arm close to the end. Hand tighten AN4-6 bolt as it will be removed prior to final fitting.

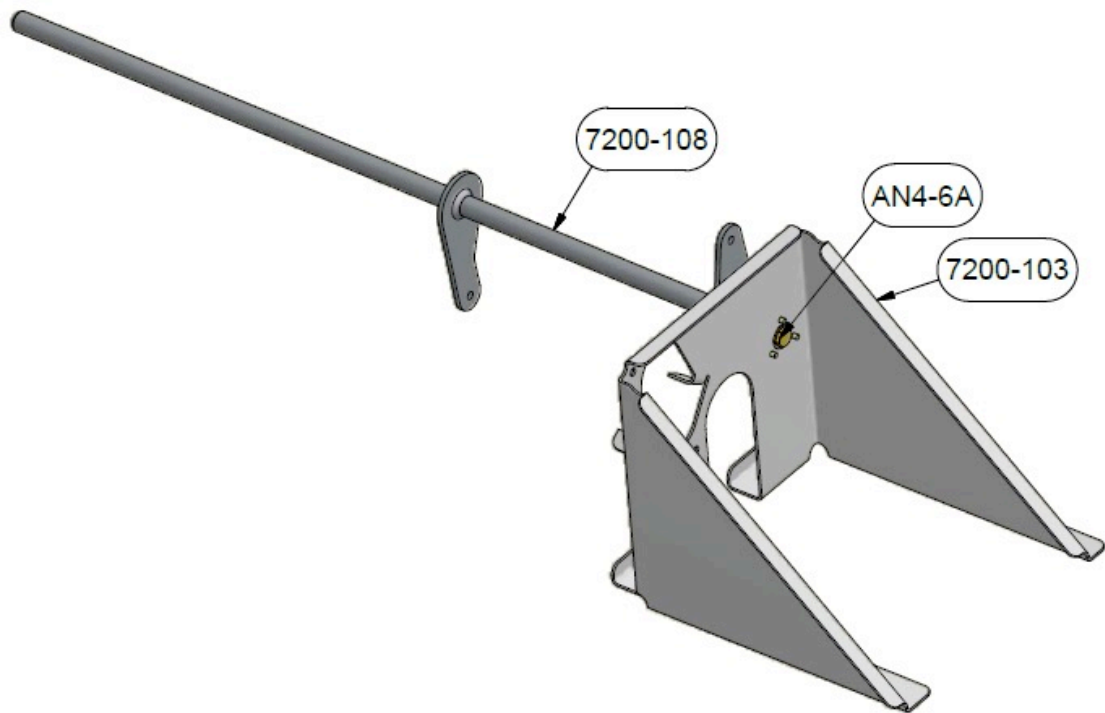

Figure 2-4

- 1.7. Place the PA-28 pitch bracket assembly (P/N 7200-103) over the flap tube on the as shown in Figure 2-5. Connect the free end of the PA-32 bellcrank (P/N 7200-108) to the PA-28 roll bracket assembly (P/N 7200-102) using an AN4-6 bolt. Hand tighten AN4-6A bolt as it will be removed prior to final fitting.

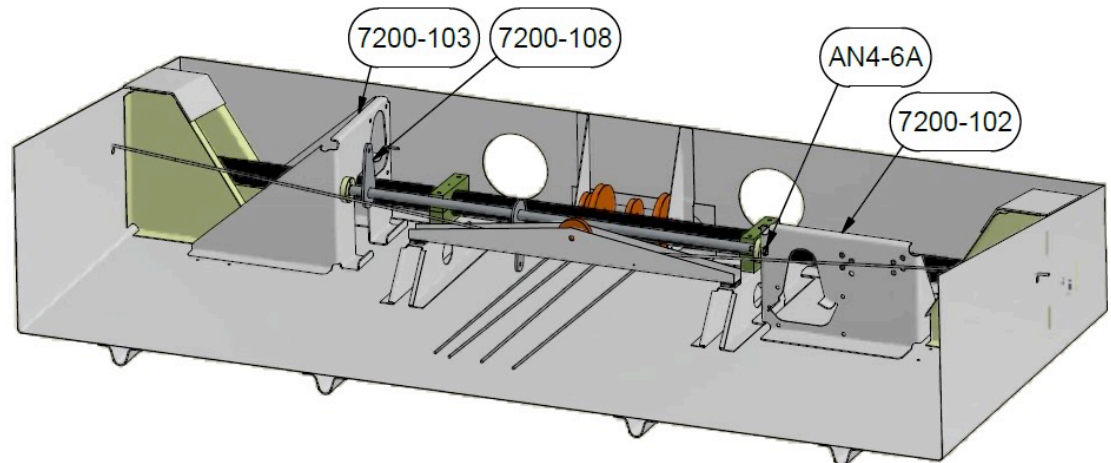
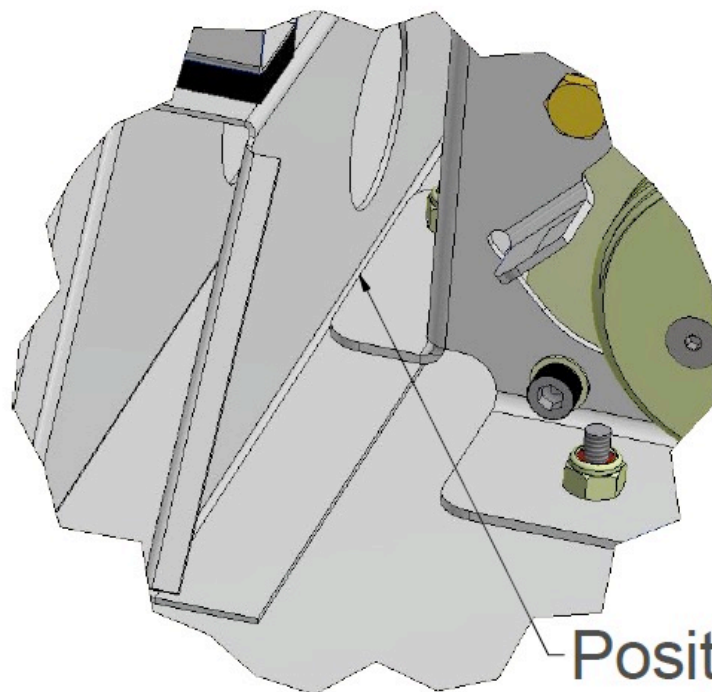

Figure 2-5

- 1.8. Position the roll bracket assembly so that the inboard flange is just outside of the bend of the flap tube support bracket as shown in Figure 2-6. This will establish the lateral positioning of both the pitch and roll servos.



Position 7200-102
as shown

Figure 2-6

- 1.9. Position the pitch bracket assembly so that the flap tube cutout is centered over the flap tube and the left face is parallel to the centerline of the aircraft as shown in Figure 2-7. This will establish the fore/aft position of the pitch bracket assembly. Note that the PA-32 bellcrank (P/N 7200-108) should be installed at this time. It has been removed from the figure for clarity.

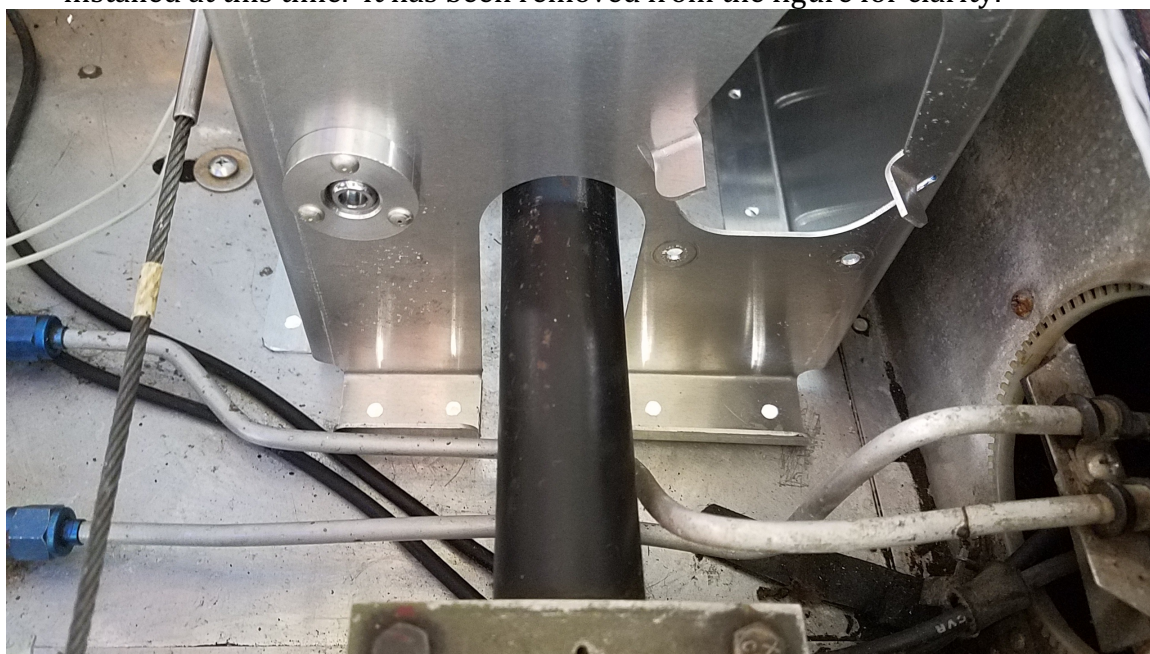

Figure 2-7

- 1.10. Adjust the fore/aft position of the roll bracket so that the forward edge is perpendicular to the centerline of the aircraft and there is a $\frac{1}{4}$ " gap between the inboard flange of the bracket and the flap tube. This will establish the fore/aft position of the roll bracket assembly.
- 1.11. Check for any interference with attaching the brackets to the fuselage.
- 1.12. Remove the pitch bracket assembly (P/N 7200-103). Drill out 2 rivets through the lower fuselage skin in the locations shown in Figure 2-8. After rivet removal enlarge the holes with a #18 drill (.1695").

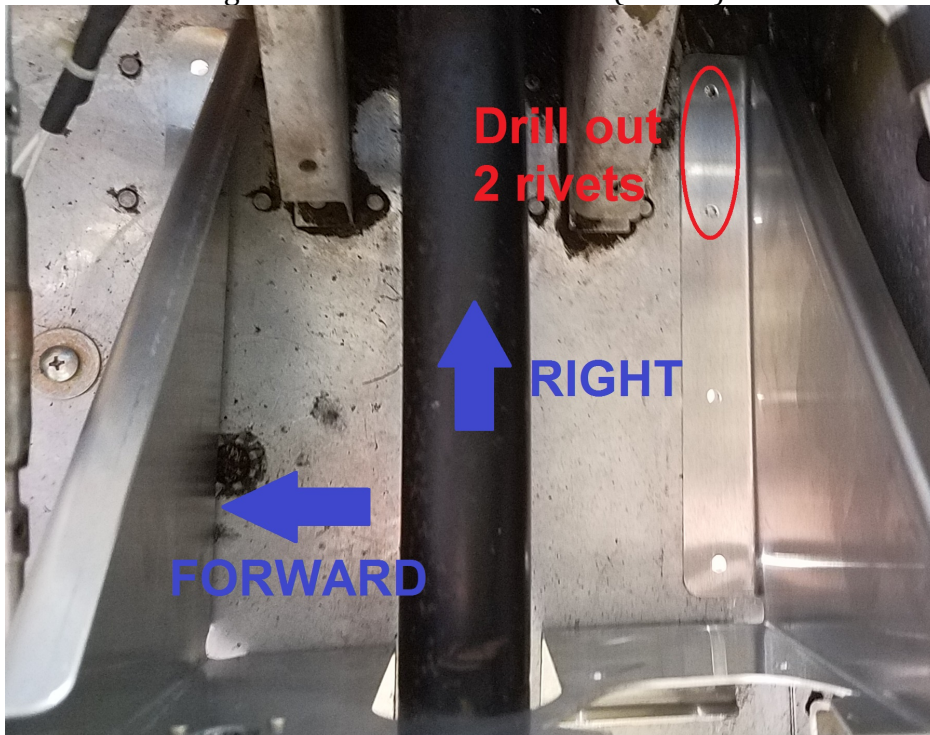

Figure 2-8

- 1.13. Reposition the PA-28 pitch bracket assembly (P/N 7200-103) so that it is centered over the flap tube and reconnect the PA-32 bellcrank (P/N 7200-108) using an AN4-6 bolt.
- 1.14. Match drill the lower rear flange to the holes drilled in the previous step. Secure the pitch bracket assembly to the fuselage using clecos or 8-32 fasteners after drilling each hole in the pitch bracket assembly.
- 1.15. Drill 2 more #18 holes through the lower rear flange of the pitch bracket assembly (P/N 7200-103) and lower fuselage as shown in Figure 2-9.

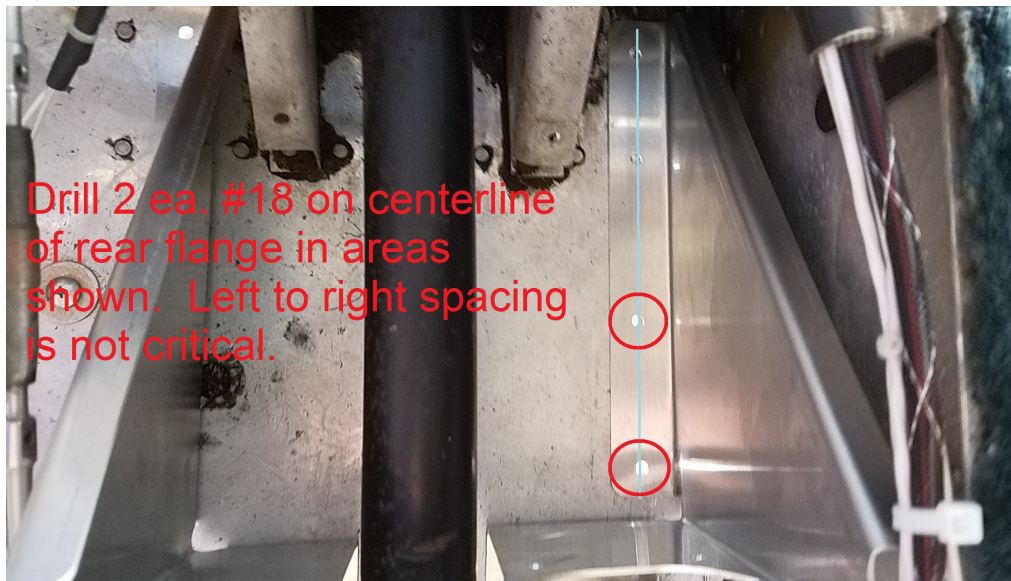

Figure 2-9

- 1.16. Drill 4 #18 holes through the lower left flange of the pitch bracket assembly (P/N 7200-103) and lower fuselage in the areas shown in Figure 2-10. Note that the PA-32 bellcrank (P/N 7200-108) should be installed at this time. It has been removed from the figure for clarity.

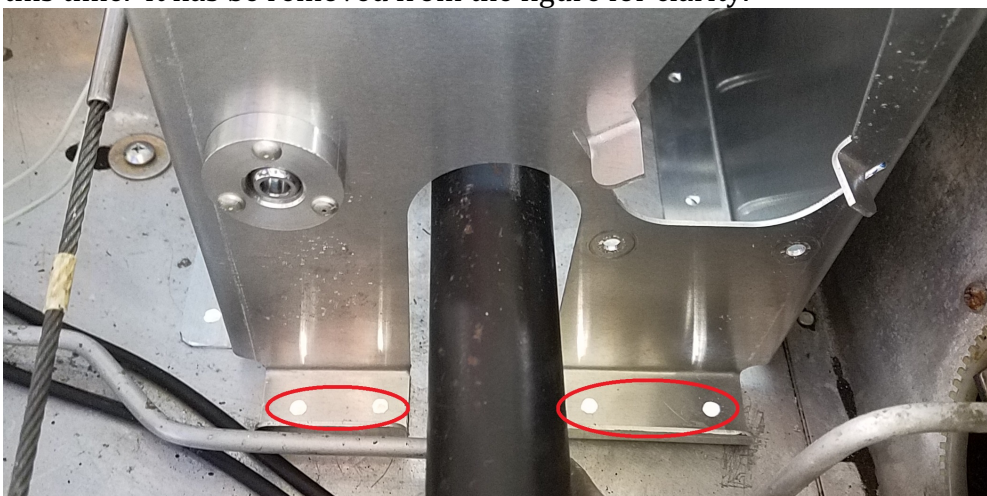

Figure 2-10

- 1.17. Drill 4 #18 holes through the centerline of the lower forward flange of the pitch bracket assembly (P/N 7200-103) and lower fuselage as shown

in Figure 2-11. The two holes on the right side of the bracket should align with the existing rows of rivets. Left to right spacing of the left two holes is not critical.

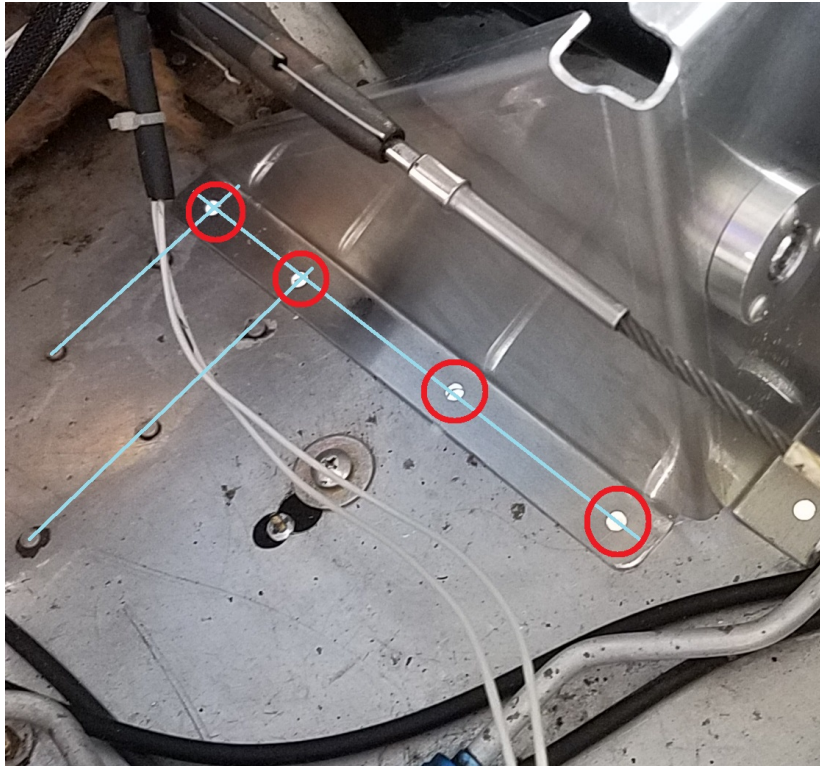

Figure 2-11

- 1.18. Remove the pitch bracket assembly (P/N 7200-103) to clean and deburr all holes.
- 1.19. Mount the pitch bracket assembly (P/N 7200-103) to the aircraft by inserting 12 ea. AN526C-832R8 screws from the outside of the aircraft and securing with 12 ea. MS20365-832 nuts. Torque to 18-20 in-lb.
- 1.20. Verify that the roll bracket assembly is located in the position from step 1.10.
- 1.21. Drill 6 #18 holes through the lower flanges of the PA-28 roll bracket assembly (P/N 7200-102) and the lower fuselage in the areas shown in Figure 2-12 and Figure 2-13. When drilling holes in the front flange do not align the holes with the lower servo mounting holes in the PA-28 roll bracket assembly (P/N 7200-102). Also avoid drilling in the an area that will interfere with the capstan. Drill holes on the lower left and right flanges on the existing rivet lines. This step may require removing rivets in which case the rivet holes should be enlarged to #18 and match drilled on the roll bracket assembly. If an autopilot servo has previously been mounted in this area it may be applicable to match drill the bracket to the existing holes in

the fuselage. Secure the roll bracket assembly to the fuselage using clecos or 8-32 fasteners after drilling each hole in the roll bracket assembly.

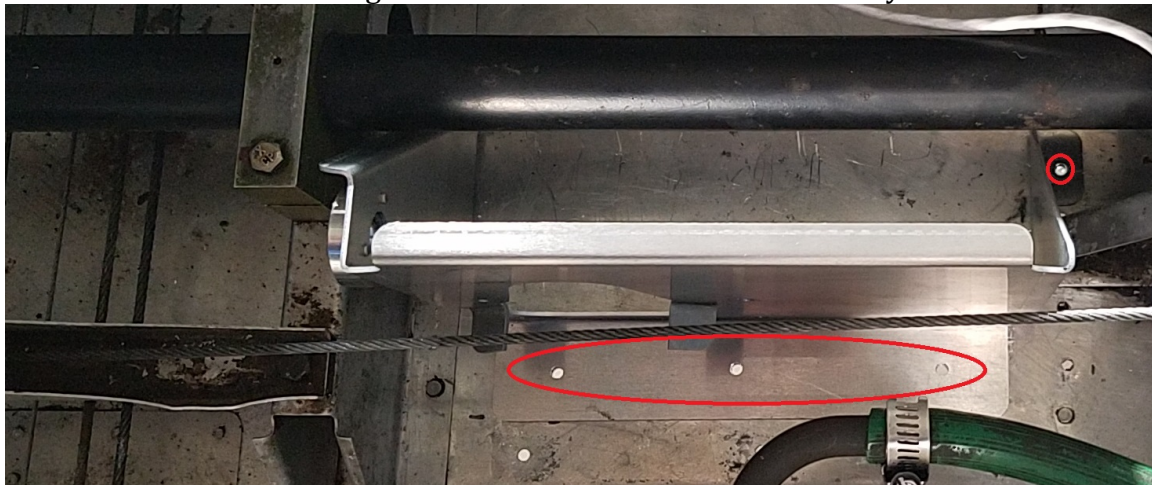

Figure 2-12

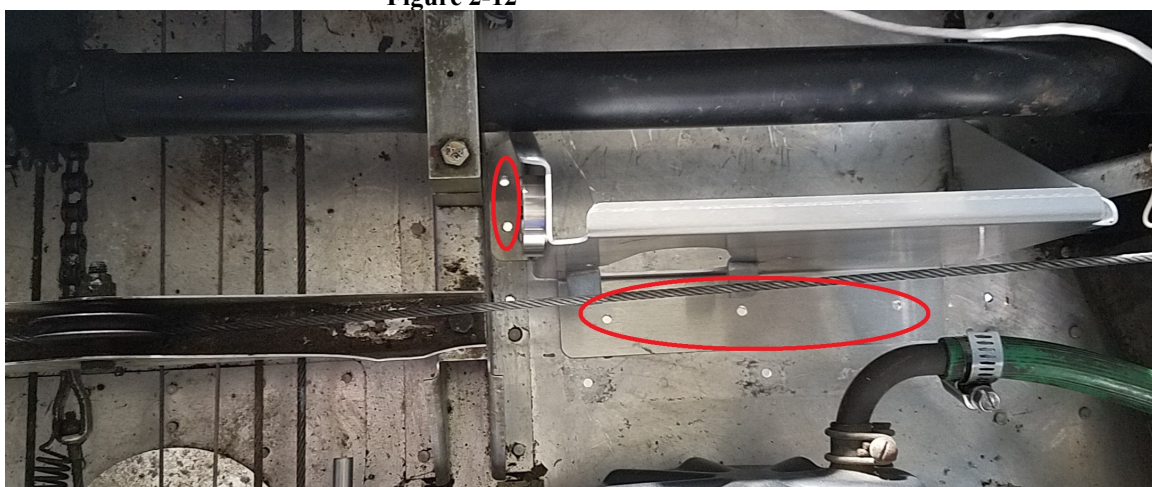

Figure 2-13

- 1.22. Remove the roll bracket assembly (P/N 7200-102) to clean and deburr all holes.
- 1.23. Remove the 2 jack screws from both servos and install 2 of the hex head slide lock jack screws included in the wiring harness kit. Use blue

threadlocker (Loctite 242 or equivalent) and torque the screws to 2-3 in-lb.

	Torque	12 Volt P/N	24 Volt P/N
Roll Servo	60 in-lb	8100-064	8100-065
Pitch Servo	100 in-lb	8100-078	8100-079

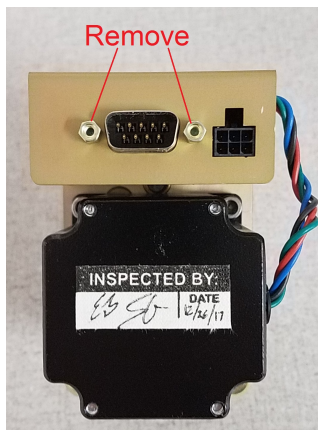

Figure 2-14



Figure 2-15

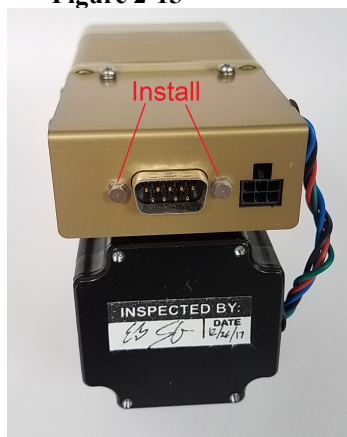

Figure 2-16

- 1.24. Attach the PMA Capstan Wheel (P/N 1420-233) to the roll servo using 3 ea. of the provided 8-32 x 3/8" flat head screws. Use blue threadlocker (Loctite 242 or equivalent) and torque the screws to 18-20 in-lb.
- 1.25. Place the roll servo under the flap tube in the orientation shown in Figure 2-17.



Figure 2-17

- 1.26. Attach the roll servo to the PA-28 roll bracket assembly (P/N 7200-102) using 2 ea. AN3-3A bolts with MS35333-39 lock washers in the upper holes and 2 ea. of the provided 10-32 x 3/8" stainless steel socket head cap screws with MS35333-39 lock washers in the lower holes. Apply blue threadlocker (Loctite 242 or equivalent) to all fasteners and torque to 20-25 in-lb. The servo must be in place under the flap tube during this attachment as it cannot be positioned after attaching the bracket.
- 1.27. Mount the roll bracket assembly (P/N 7200-102) to the aircraft by inserting 6 ea. AN526C-832R8 screws from the outside of the aircraft and securing with 6 ea. MS20365-832 nuts. Torque to 18-20 in-lb.
- 1.28. Remove the AN4-6A bolts holding each end of the PA-28 bellcrank (P/N 7200-104) to the PA-28 roll bracket assembly (P/N 7200-102) and PA-28 pitch bracket assembly (P/N 7200-103). Apply blue threadlocker (Loctite 242 or equivalent), reinstall the AN4-6A bolts and torque to 50-70 in-lb.
- 1.29. Attach a 2" PMA servo arm assembly (P/N 7200-097) to the pitch servo using 3 ea. of the provided 8-32 x 3/8" flat head screws. Use blue threadlocker (Loctite 242 or equivalent) and torque the screws to 18-20 in-lb.
- 1.30. Attach the pitch servo to the PA-28 pitch bracket assembly (P/N 7200-103) using 4 ea. AN3-3A bolts with MS35333-39 lock washers. Apply blue threadlocker (Loctite 242 or equivalent) to all fasteners and torque to 20-25 in-lb.
- 1.31. Install large rod end bearings (P/N 2510-052) in the PMA link sensor (P/N 8000-177) as shown in Figure 2-18. Apply blue threadlocker (Loctite 242 or equivalent) to rod ends and torque AN315-4 nuts to 50-70 in-lb.

Maintain orientation of large rod end bearings (P/N 2510-052) and hold the link sensor body and extension rod while torquing AN315-4 nuts.

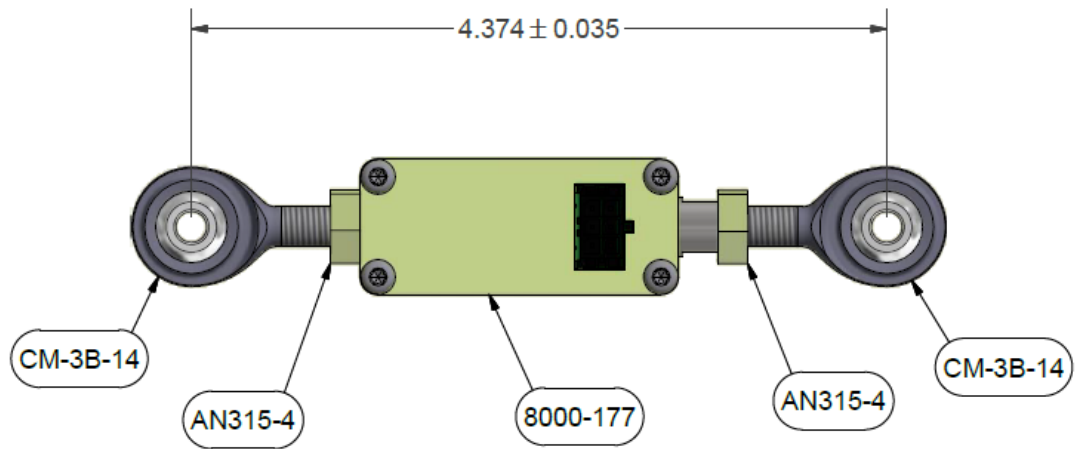

Figure 2-18

- 1.32. Install the link sensor assembly as shown in Figure 2-19. Torque fasteners to 20-25 in-lb.

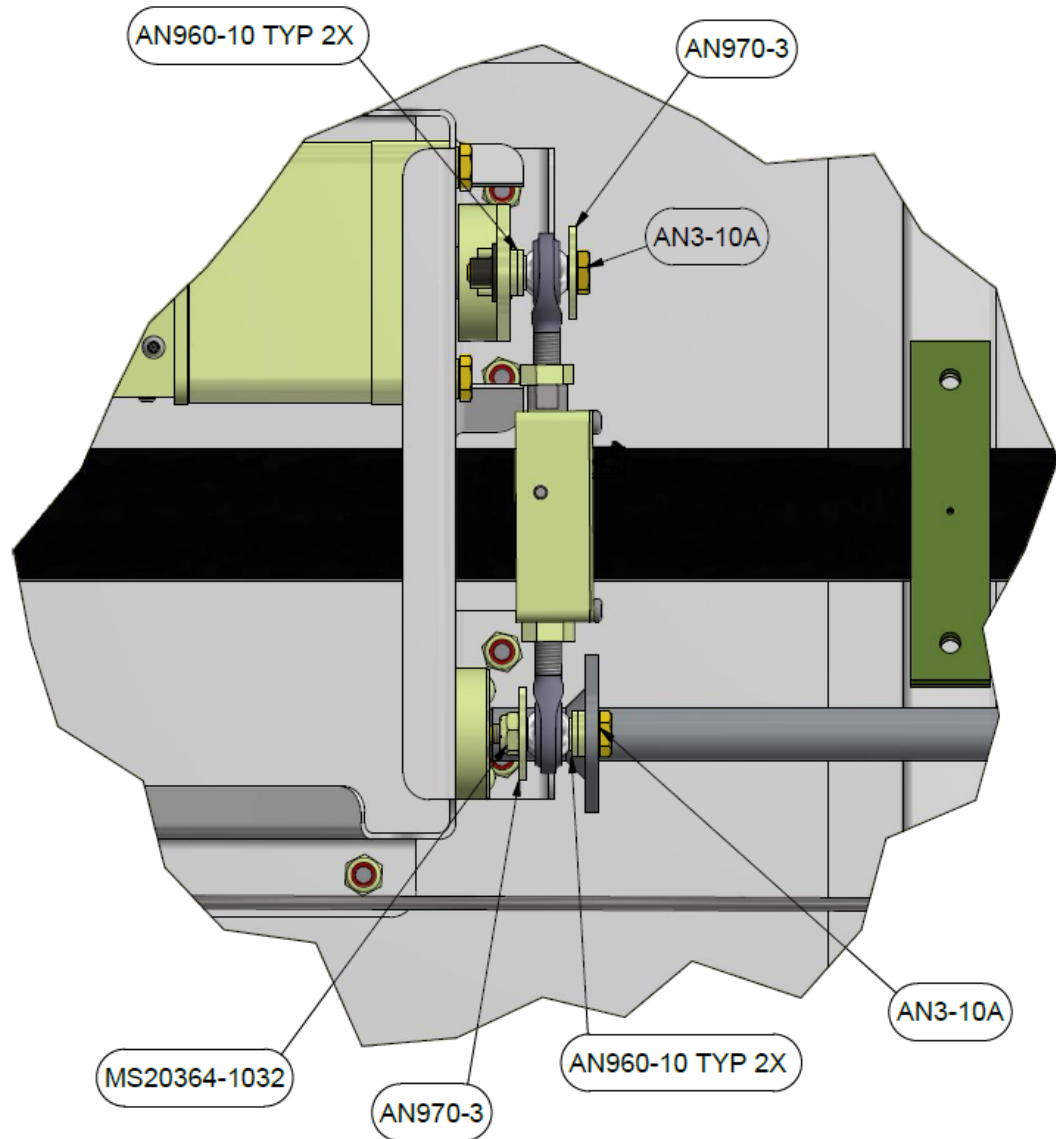

Figure 2-19

- 1.33. Assemble the pitch pushrod assembly as shown in Figure 2-20. Apply blue threadlocker (Loctite 242 or equivalent) to rod ends and torque

AN345-10 nuts to 20-25 in-lb. Maintain alignment of the MM-3-300 rod end bearings after tightening.

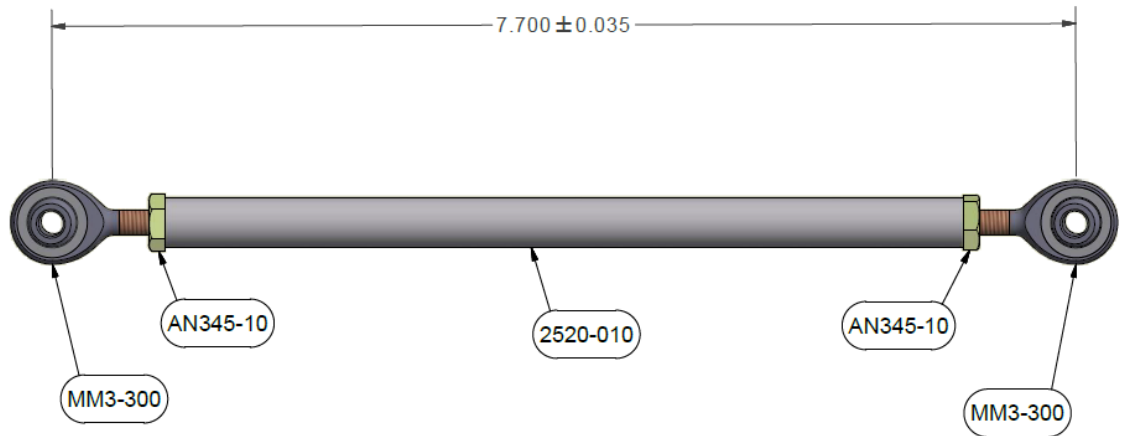

Figure 2-20

- 1.34. Attach the pitch pushrod assembly to the PA-32 bellcrank (P/N 7200-108) as shown in Figure 2-21.

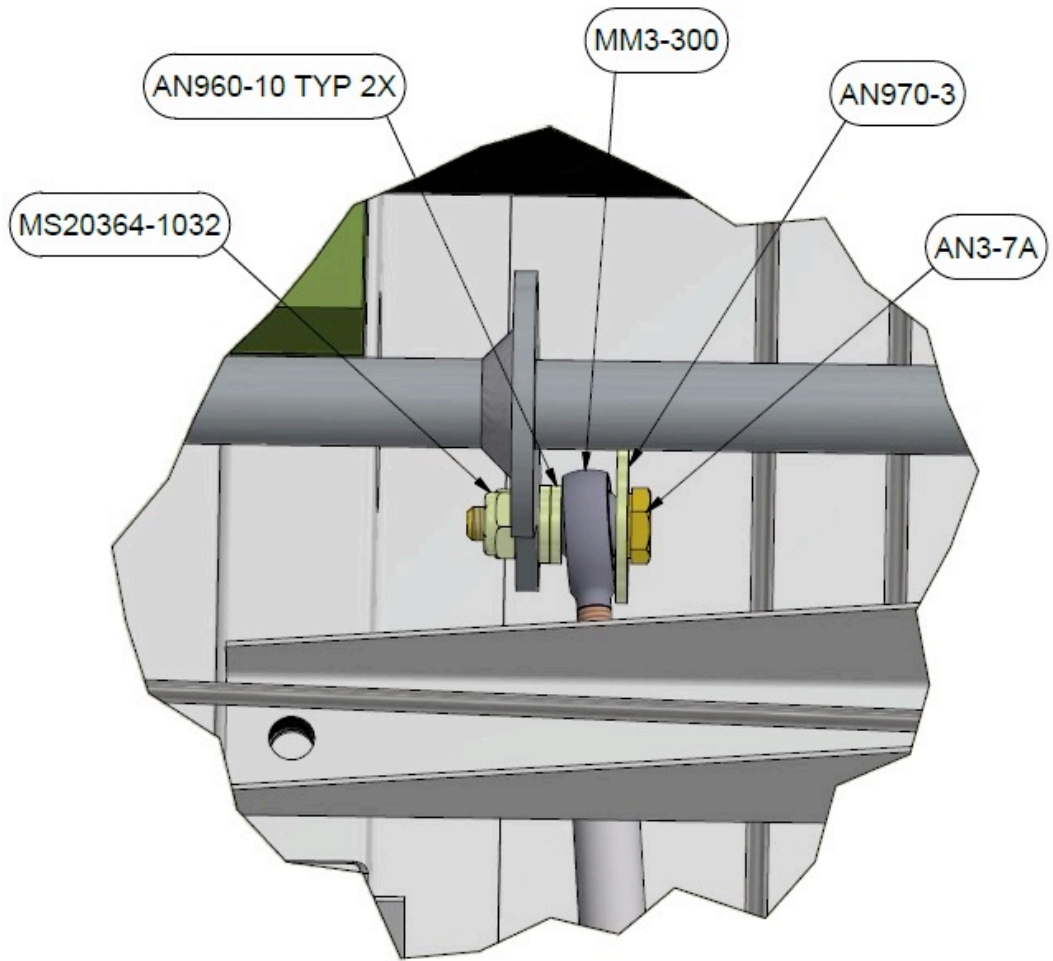

Figure 2-21

- 1.35. Move the controls in pitch to ascertain the location of the elevator cable marked in red in Figure 2-22.

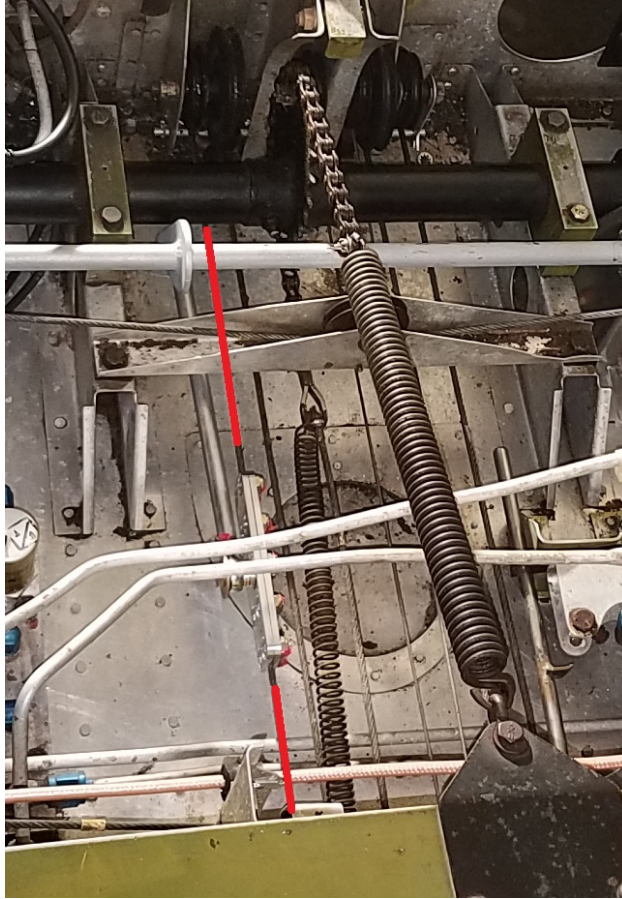

Figure 2-22

- 1.36. Loosely assemble the pitch cable clamp assembly around the elevator cable as shown in Figure 2-23 so that the clamp will freely move on the elevator cable.

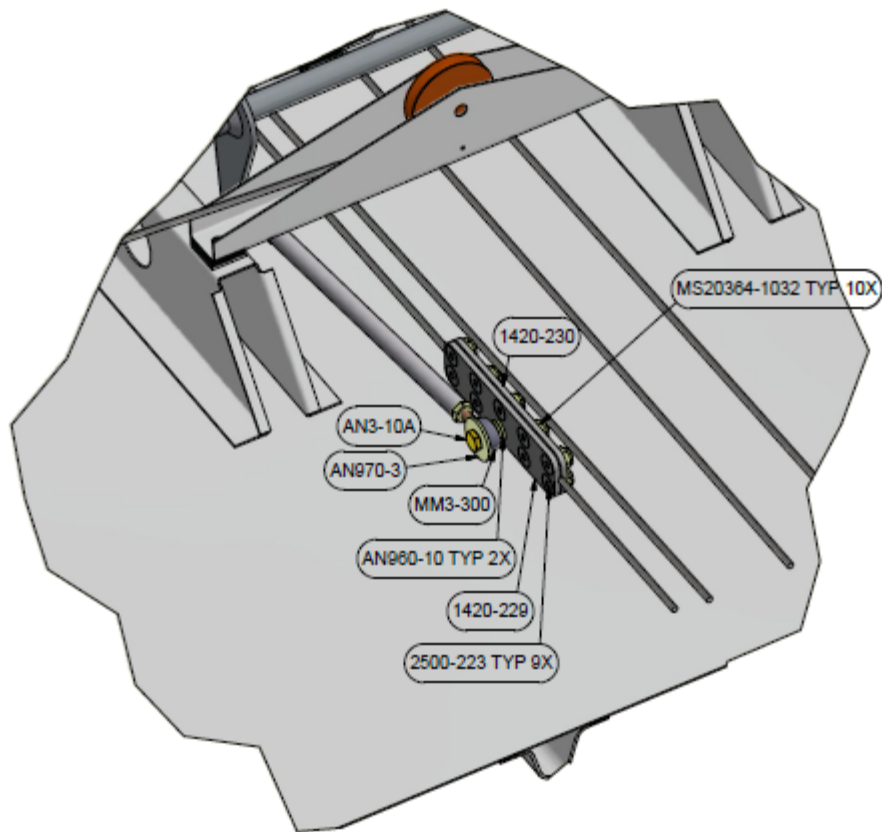

Figure 2-23

- 1.37. Position pitch cable clamp.
 - 1.37.1. Begin by holding the controls at full deflection up and moving the cable clamp until the 2" PMA servo arm assembly (P/N 7200-097) has contacted the corresponding stop on the PA-28 pitch bracket assembly (P/N 7200-103). Tighten the center bolts on the cable clamp until the clamp no longer slides on the cable.
 - 1.37.2. Position and hold the controls at full down deflection and note the amount of space remaining between the 2" PMA servo arm assembly (P/N 7200-097) and the stop on the PA-28 pitch bracket assembly (P/N 7200-103).
 - 1.37.3. Loosen the cable clamp bolts and move the clamp so that the distance remaining between the 2" PMA servo arm assembly (P/N 7200-097) and the stop on the PA-28 pitch bracket assembly (P/N 7200-103) is approximately $\frac{1}{2}$ the distance noted in step 1.37.2.
 - 1.37.4. Verify that the 2" PMA servo arm assembly (P/N 7200-097) is evenly spaced between stops on the PA-28 pitch bracket assembly

(P/N 7200-103) when the controls are placed in full up and full down deflection.

- 1.37.5. Torque the 10 fasteners on the clamp assembly to 20-25 in-lb in an even manner. Take care not to close one side of the clamp before torquing the opposing bolts.
- 1.37.6. Verify that full control travel is not impeded by the pitch servo.

1.38. Roll Bridle Cable installation

- 1.38.1. Loosely assemble two cable clamps as shown in Figure 2-24.

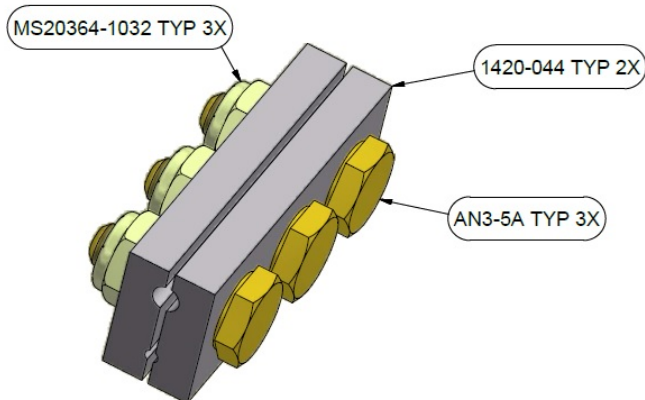

Figure 2-24

- 1.38.2. Clean the primary aileron control cable on the left side of the fuselage. The clamping areas must be free of dirt, oil and grease.
- 1.38.3. Place the cable clamps on the primary aileron control cable in the area shown in Figure 2-25. Note that the large groove in the clamps will capture the primary aileron control cable. The small groove will capture the bridle cable.



Figure 2-25

- 1.38.4. The bridle cable will be routed as shown in Figure 2-26. It is important that the bridle cable routing is as close to parallel with the primary aileron control cable as possible.



Figure 2-26

- 1.38.5. Determine which set of pulley holes on the roll bracket assembly (P/N 7200-102) will best locate the bridle cable parallel to the primary aileron control cable. Use a permanent marker to circle the holes to be used.
- 1.38.6. Attach the MS20219-2 pulleys to the circled holes in the roll bracket assembly (P/N 7200-102) as shown in Figure 2-27. Torque AN4 bolts to 50-70 in-lb.

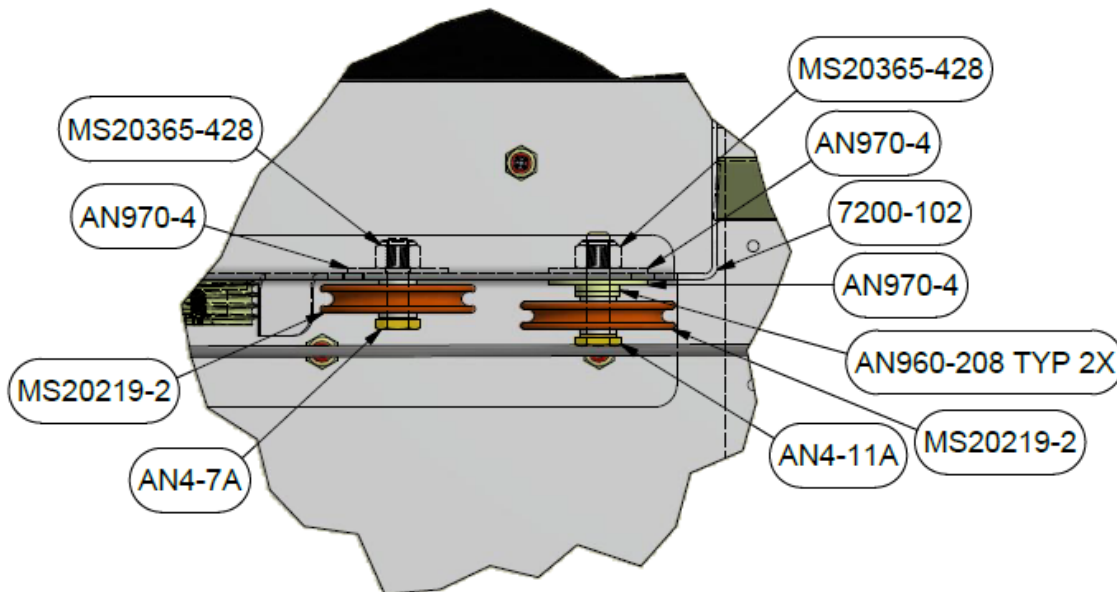

Figure 2-27

- 1.38.7. Hold the controls so that the primary aileron control cable is deflected fully to the left side of the aircraft. Slide the outboard cable clamp as far outboard as possible without the possibility interference

- with other aircraft components. Use a permanent marker to mark the primary aileron control cable at the outboard edge of the cable clamp.
- 1.38.8. Continue holding the aileron controls at full deflection and slide the inboard cable clamp as far outboard as possible until contacting the inboard pulley on the roll servo bracket. Use a permanent marker to mark the primary aileron control cable at the outboard edge of the cable clamp.
 - 1.38.9. Fully deflect and hold the aileron controls in the opposite direction. Slide the outboard cable clamp as far inboard as possible until contacting the outboard pulley on the roll servo bracket. Use a permanent marker to mark the primary aileron control cable at the inboard edge of the cable clamp.
 - 1.38.10. Continue holding the aileron controls at full deflection and slide the inboard cable clamp as far inboard as possible without the possibility interference with other aircraft components. Use a permanent marker to mark the primary aileron control cable at the inboard edge of the cable clamp.
 - 1.38.11. Center and hold the aileron controls.
 - 1.38.12. The pin on the PA-32 Bridle Cable (P/N 7200-113) is located offset from the center of the cable. Orient the cable so that the longer side will be directed outboard.

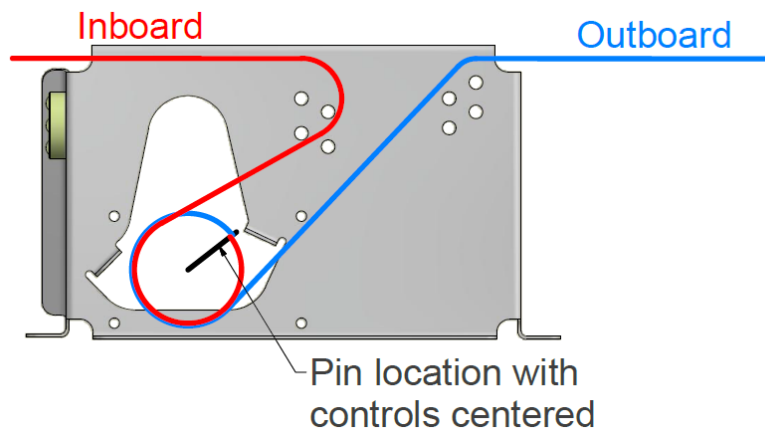

Figure 2-28

- 1.38.13. Place the pin on the PA-32 Bridle Cable (P/N 7200-113) in the hole on the circumference of the PMA Capstan Wheel (P/N 1420-233). Lightly tap the pin into the capstan so that the cable is fully seated in the groove of the capstan.
- 1.38.14. Route the PA-32 Bridle Cable (P/N 7200-113) as shown in Figure 2-26 and 2-28. The capstan should have approximately 1-½ wraps of cable.
- 1.38.15. Position and hold the capstan so that the bridle cable pin is approximately centered between the points where the cable exits the capstan as shown in Figure 2-28.
- 1.38.16. Place the outboard end on the bridle cable in the small groove of the outboard cable clamp leaving a ¼" gap between the stop ball

and the cable clamp. Tighten the center bolt of the outboard cable clamp so that the cables are lightly clamped in place. Final torquing will occur later.

- 1.38.17. Place the inboard end of the bridle cable in the small groove of the inboard cable clamp leaving a $\frac{1}{4}$ " gap between the stop ball and the cable clamp. Tension the cable by hand and tighten the center bolt of the outboard cable clamp so that the cables are lightly clamped in place.
- 1.38.18. Verify that the cable clamps are no closer than $\frac{3}{8}$ " to the marks made on the primary aileron control cable in the previous steps. If the clamps are closer than $\frac{3}{8}$ " recheck the aileron travel and contact Trutrak before proceeding with the installation.
- 1.38.19. Torque the AN3 bolts on the outer cable clamp to 35-40 in-lbs.
- 1.38.20. Bridle cable tension will be set to 0 to 3 pounds less than the primary aileron control cable tension
- 1.38.21. While holding the controls in place pull the inboard stop ball on the PA-32 Bridle Cable (P/N 7200-113) to tension the bridle cable. Torque one of the inboard cable clamp bolts to 35-40 in-lbs. Check that bridle cable tension is set correctly and repeat if needed.
- 1.38.22. Torque the AN3 bolts on the inboard cable clamp to 35-40 in-lbs.
- 1.38.23. Apply torque seal to both cable clamps at the 4 cable entrance locations.
- 1.39. Verify that full control travel is not impeded by the roll servo.

2.3. Piper PA-32 Vizion IPC

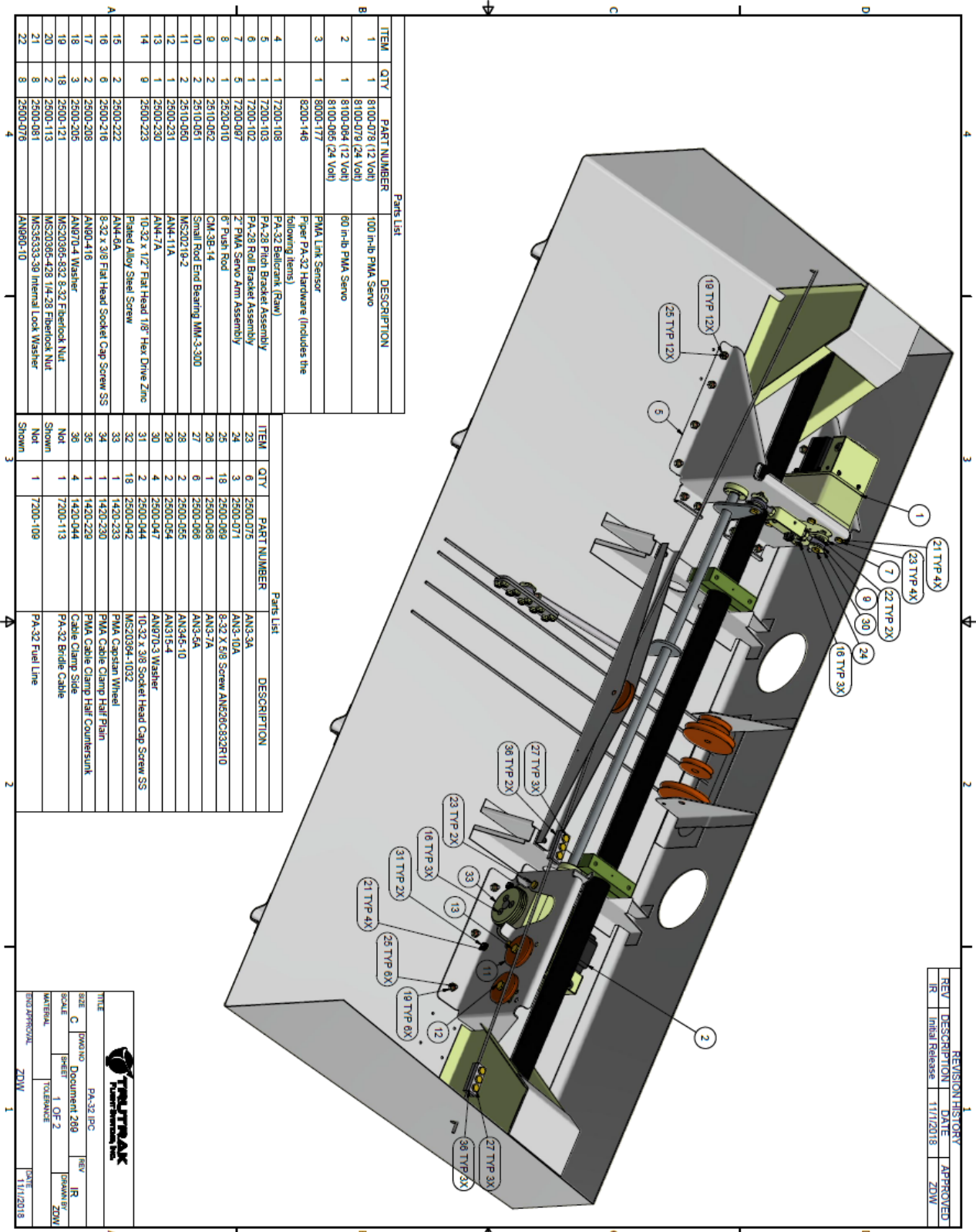

REVISION HISTORY			
REV	DESCRIPTION	DATE	APPROVED
IR	Initial Release	11/17/2018	ZDW

Parts List		
ITEM	QTY	PART NUMBER DESCRIPTION
1	1	8100-078 (12 Volt) 100 m-hb PMA Servo
2	1	8100-094 (12 Volt) 60 m-hb PMA Servo
3	1	8100-085 (24 Volt) PMA Link Sensor
4	1	8200-146 Piper PA-32 Hardware (Includes the following items)
5	1	7200-108 PA-32 Belcrank (Rear)
6	1	7200-103 PA-32 Push Bracket Assembly
7	1	7200-102 PA-32 Rod Bracket Assembly
8	1	7200-087 Z7 PMA Servo Arm Assembly
9	2	2500-010 9" Push Rod
10	2	2510-082 CK-38-14
11	2	2510-051 Small Rod End Bearing MM-3-300
12	1	2500-231 MS20219-2
13	1	2500-230 ANH-7A
14	9	2500-223 10-32 x 1/2" Flat Head 1/8" Hex Drive Zinc Plated Alloy Steel Screw
15	2	2500-222 ANH-8A
16	6	2500-216 8-32 x 3/8 Flat Head Socket Cap Screw SS
17	2	2500-209 ANR04-18
18	3	2500-205 ANR04-18 Washer
19	2	2500-121 MS20395-832 8-32 Fibertock Nut
20	2	2500-113 MS20395-428 1/4-28 Fibertock Nut
21	8	2500-081 MS39333-38 Internal Lock Washer
22	8	2500-076 ANR00-10

Parts List		
ITEM	QTY	PART NUMBER DESCRIPTION
23	6	2500-075 AN3-3A
24	3	2500-071 AN3-10A
25	18	2500-068 8-32 X 5/8 Screw AN520C832R10
26	1	2500-068 AN3-7A
27	6	2500-065 AN3-5A
28	2	2500-055 AN345-10
29	2	2500-054 AN315-4
30	4	2500-047 ANR07-3 Washer
31	2	2500-044 10-32 x 3/8 Socket Head Cap Screw SS
32	18	MS20394-1032 PMA Cardan Wheel
33	1	1420-230 PMA Cable Clamp Half Pin
34	1	1420-229 PMA Cable Clamp Half Pin
35	1	1420-228 PMA Cable Clamp Half Countersunk
36	1	1420-044 Cable Clamp Side
37	4	1420-113 PA-32 Brake Cable
38	1	1420-108 PA-32 Fuel Line

TRU TRAK
 THE AUTOPILOT PEOPLE

TITLE: PA-32 IPC
 SIZE: C
 SCALE: 1 OF 2
 WATERMARK: TRU TRAK
 THE APPROVAL: ZDW
 DATE: 11/17/2018

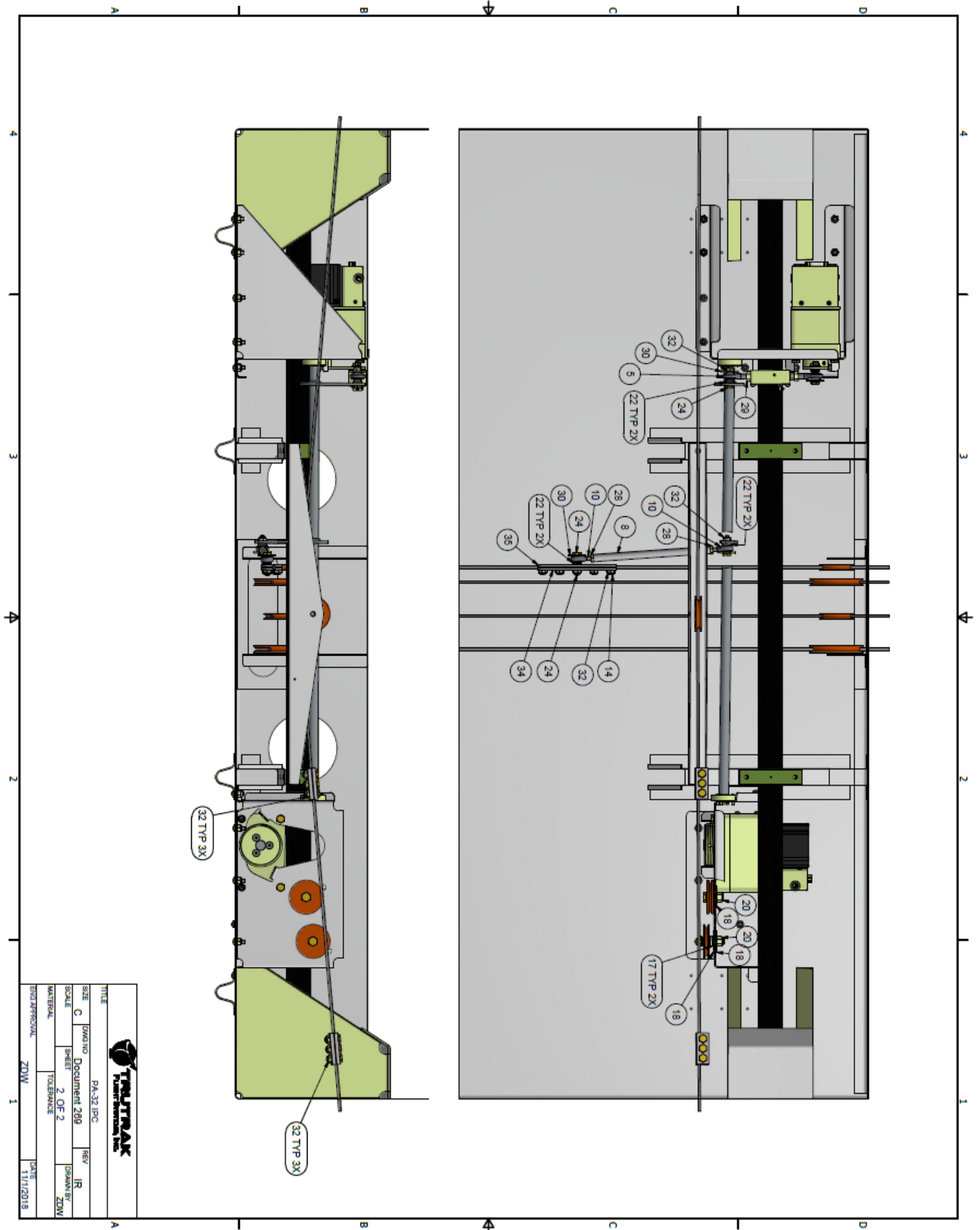

3. Piper PA-32 Controller / Wiring Harness Installation

3.1. Wiring Harness Materials List

Qty	Description	Part Number
1	Vizion Wiring Harness 25'	8220-033
1	Vizion 2" Controller OR Vizion 3" Controller OR Vizion Flat Pack Controller	8000-174 OR 8000-176 OR 8000-175
100	MS3367-1-0 Cable Tie	
2	Connector D-sub Female 9 Pin Crimp	2100-044
16	Female Socket Crimp Connector D-sub	2100-045
2	Right Angle D-sub 9 Pin Backshell Kit	8210-011
1	Vizion Emergency Level Button Kit	8100-113
1	Vizion Limitations Placard	8300-092
1	5A AP circuit breaker (not supplied)	
1	Control Wheel Steering Switch (not supplied, but MUST be RED in color)	
1	AP Master Switch (not supplied)	
4	6-32 X 3/8" Instrument mounting screw (not supplied)	
N/A	Various terminals and pins for connection of power and GPS	
N/A	1/8"-27 NPT male fittings and tees for connecting the A/P pitot and static to the aircraft systems	

3.2. Wiring Harness / Controller Mounting Instructions

1. Begin by disconnecting the aircraft battery.
2. Select a mounting location for the autopilot controller.
 - 2.1. Consider the overall mounting depth of the controller with pitot, static, and electrical connections and allow clearance where necessary, especially surrounding the moving yoke assembly.
 - 2.2. Ensure that mounting location does not require autopilot servo lines to run near com antenna coax.
 - 2.3. Ensure that there is sufficient space near the autopilot controller to install the Vizion Limitations Placard (Trutrak P/N 8300-092)
3. Remove the instrument panel and panel overlays as necessary.
4. Wiring harness routing.
 - 4.1. Route the pitch (white) and roll (black) servo harnesses from the controller to the right side of the panel.
 - 4.2. Follow the existing harness routing down the right side of the fuselage and through the spar.



Figure 3-1

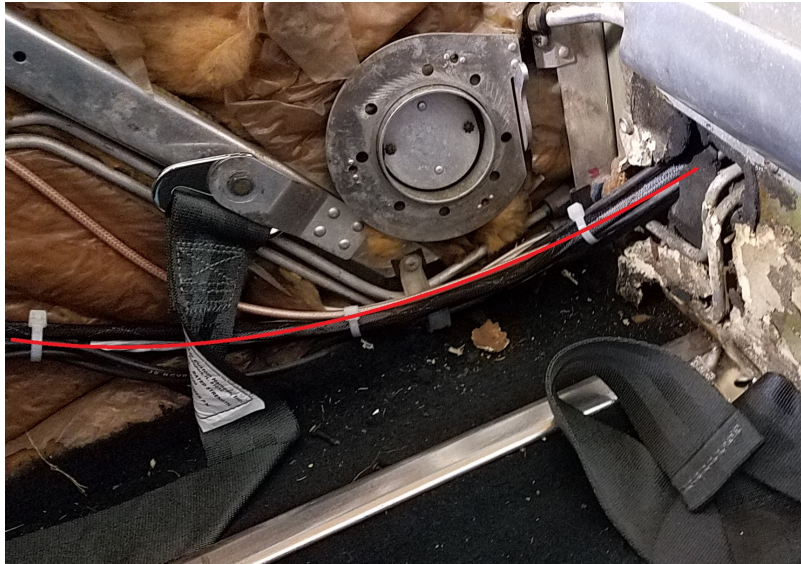

Figure 3-2

4.3. Route the pitch and roll harnesses to the corresponding servos as shown in Figure 3-3.

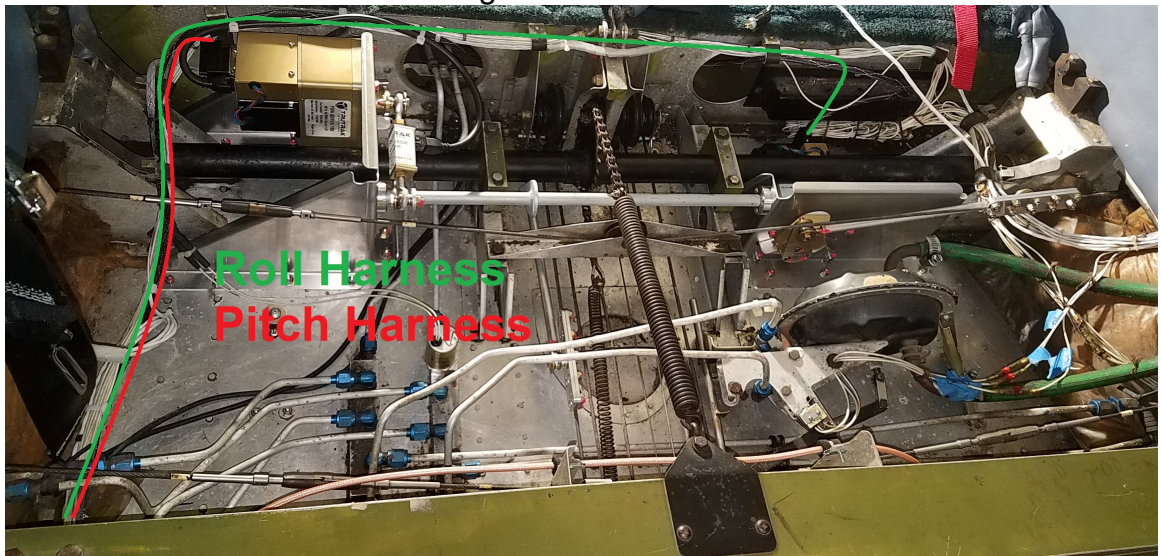

Figure 3-3

- 4.4. Secure pitch servo harness with MS3367-1-0 Cable Ties every 6-12" ensuring that there is no interference with any moving parts.
5. Terminate both the pitch and roll servo wiring harness per the Vizion wiring diagram **USING OPTION A** in the Vizion PMA Installation Guide (TruTrak Doc. 166) using 2 ea. Right Angle D-sub 9 Pin Backshell Kit (P/N 8210-011).

5.1. The roll servo connector backshell and slidlock should be assembled as shown in Figure 3-4.

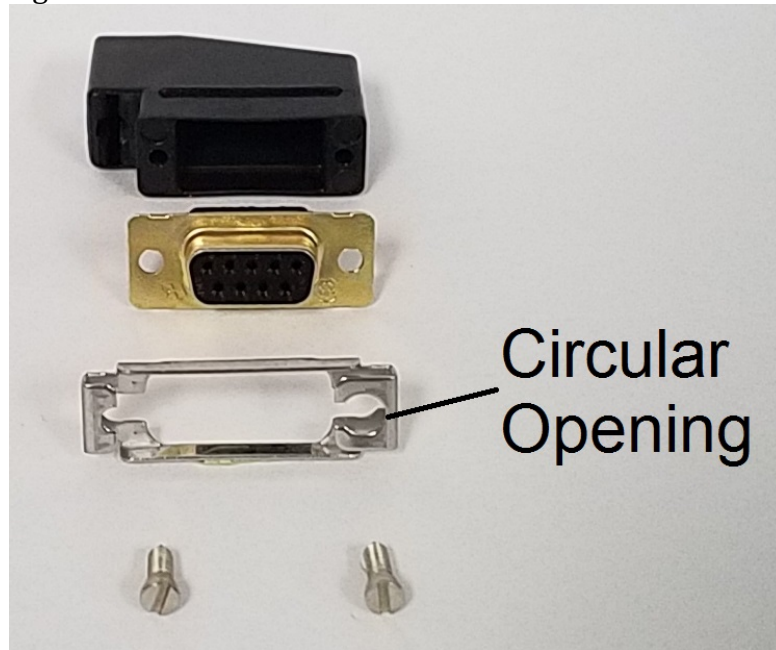

Figure 3-4

5.2. The pitch servo connector backshell and slidlock should be assembled as shown in Figure 3-5.

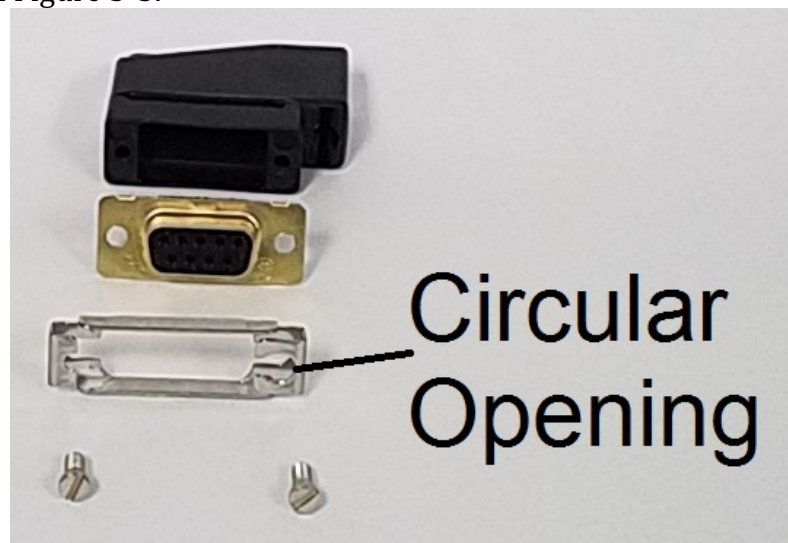

Figure 3-5

5.3. Insert and tighten the cable retention clamp on each servo connector backshell.

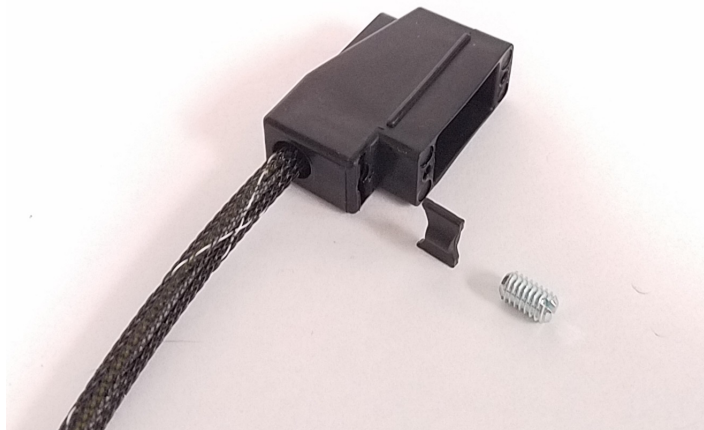

Figure 3-6

6. Connect pitch and roll servos connectors.
7. Connect the Sheathed Microfit Cable Assembly 1M (P/N 6000-064) to the PMA link sensor (P/N 8000-177) and pitch servo (P/N 8100-064 for 12 volt or P/N 8100-065 for 24 volt).
8. Secure the Sheathed Microfit Cable Assembly 1M (P/N 6000-064) so that routing is as shown in Figure 3-7. Ensure that cable is free to move as the link sensor moves through full control deflection without excess pressure on the connector.

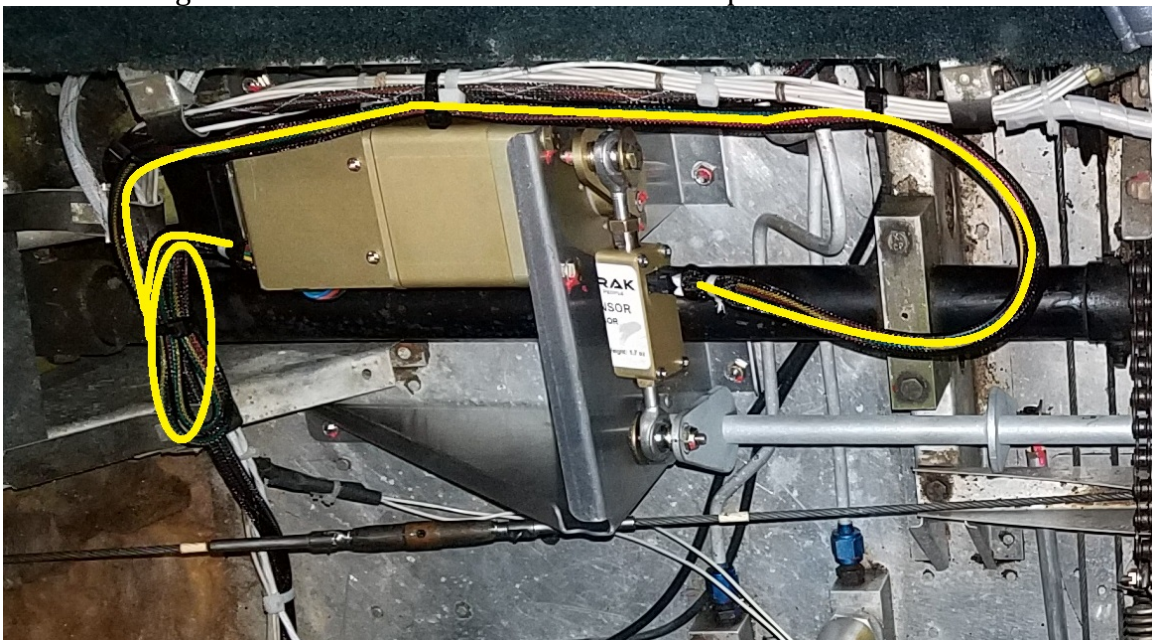

Figure 3-7

9. Select appropriate mounting locations for the AP Master, AP Circuit Breaker, Emergency Level and control wheel steering switches. Connect these items per the Vizion wiring diagram in the Vizion PMA Installation Guide (TruTrak Doc. 166).



- 9.1. All items in this step are required to be installed. The AP Master Switch, AP Circuit Breaker, and Control Wheel Steering switches must be labeled. The Control Wheel Steering Switch must be red.**
10. Connect GPS inputs per the Vizion wiring diagram in Vizion PMA Installation Guide (TruTrak Doc. 166)
- 11. Conduct pitot / static check of aircraft system before opening any pitot/ static connections!**
12. Mount autopilot controller in panel using 4 6-32 X 3/8" screws. Connect wiring harness and connect pitot and static per Vizion PMA Installation Guide (TruTrak Doc. 166).

13. Install Vizion Limitations Placard (TruTrak P/N 8300-092) near the Vizion autopilot. A sample panel with potential placard location is shown below:

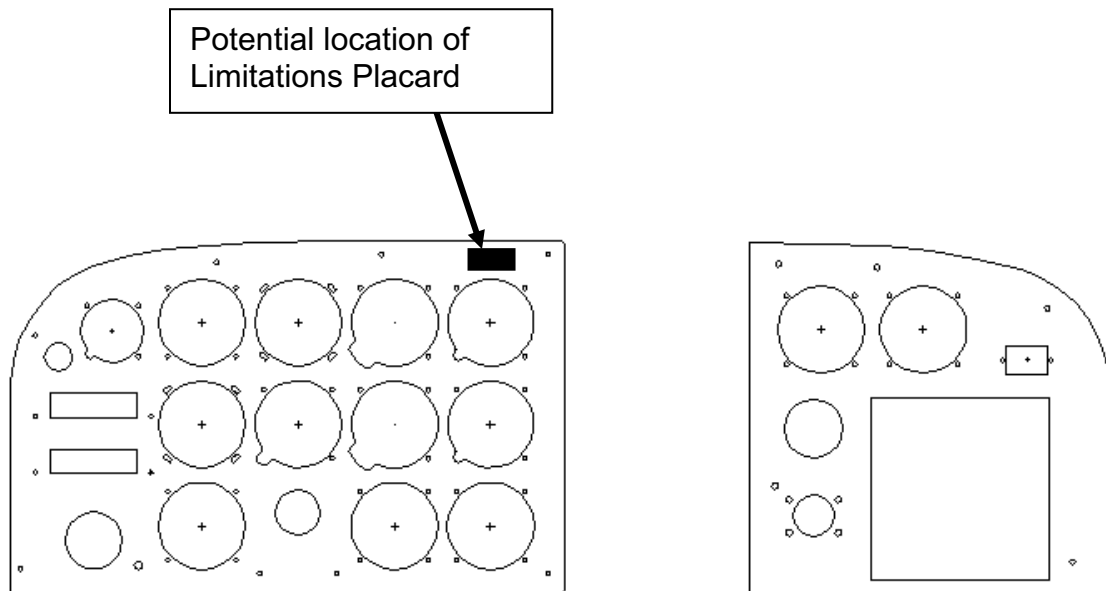

14. Reinstall the instrument panel and panel overlays.
15. Reinstall interior trim.
16. Reinstall seats.
17. Reconnect battery.
18. Once autopilot settings are confirmed, perform autopilot system test per the Vizion PMA Installation Guide (TruTrak Doc. 166).

4. Piper PA-32 Autopilot Settings

Once all wiring is complete, verified, and the GPS setup has been completed (Vizion PMA Installation Guide (TruTrak Doc. 166)), follow the steps below to verify proper autopilot settings.

THIS STEP MUST BE COMPLETED PRIOR TO GROUND CHECK AND FLIGHT CHECK!!!

4.1. Lateral Autopilot Settings

- 1) PRESS and HOLD KNOB
- 2) Apply power to autopilot and GPS
- 3) Release KNOB.
- 4) PRESS KNOB to advance to min backlight
- 5) PRESS KNOB to advance to SETUP ENABLE.
- 6) ROTATE KNOB to select a value of **10**.
- 7) PRESS KNOB to exit.
- 8) PRESS and HOLD MODE button until LAT ACTIVITY is shown.
- 9) ROTATE KNOB to select a LAT ACTIVITY of **17**
- 10)PRESS ALT button to advance to next setup screen.
- 11)ROTATE KNOB to select a BAUD that matches the baud rate of the GPS (this will be either **4800** or **9600**).
- 12)PRESS ALT button to advance to next setup screen.
- 13)ROTATE KNOB to select a BANK ANGLE of **MED**.
- 14)PRESS ALT button to advance to next setup screen.
- 15)ROTATE KNOB to select a MICROACTIVITY of **10**.
- 16)PRESS ALT button to advance to next setup screen.
- 17)ROTATE KNOB to select a GPSS GAIN of **16**.
- 18)PRESS ALT button to advance to next setup screen.
- 19)ROTATE KNOB to set ROLL REV to **N**.
- 20)PRESS KNOB exit lateral setup and return to the home screen.
- 21)PRESS ALT AND HOLD alt button until VRT AVTIVITY is shown.
- 22)WHILE CONTINUING TO HOLD ALT, PRESS MODE.
- 23)RELEASE MODE AND ALT.
- 24)PRESS MODE until MAC is displayed.
- 25)ROTATE KNOB to set MAC to **2**.
- 26)PRESS KNOB to exit menu and return to home screen.
- 27)Do not remove power from autopilot.

4.2. Vertical Autopilot Settings

- 1) PRESS and HOLD ALT button until VRT ACTIVITY is shown.
- 2) ROTATE KNOB to select a VRT ACTIVITY of **16**.
- 3) PRESS ALT button to advance to next setup screen.
- 4) ROTATE KNOB to select a MIN AIRSPD of (Refer to aircraft POH and set a value equal to **1.3 V_S** in knots).
- 5) PRESS ALT button to advance to next setup screen.
- 6) ROTATE KNOB to select a MAX AIRSPD of (Refer to aircraft POH and set a value equal to **0.9 V_{NE}** in knots).
- 7) PRESS ALT button to advance to next setup screen.
- 8) ROTATE KNOB to select a PITCH REV of **N**.
- 9) PRESS ALT button to advance to next setup screen.
- 10) ROTATE KNOB to select a STATIC LAG of **0**.
- 11) PRESS ALT button to advance to next setup screen.
- 12) ROTATE KNOB to select a MICROACTIVITY of **6**.
- 13) PRESS ALT button to advance to next setup screen.
- 14) ROTATE KNOB to select a HALF STEP of **N**.
- 15) PRESS KNOB exit vertical setup and return to the home screen.
- 16) Cycle power on the autopilot.



TruTrak Flight Systems, Inc.