

**GENERAL
PARTITIONS** *Mfg. Corp.*

PRODUCT GUIDE

**OPENING
NEW
POSSIBILITIES**



**All New
Accessories**

SEE PAGE 10

INDICATOR LOCK



EASY MAINTENANCE



DIAMOND TEXTURE
STAINLESS STEEL

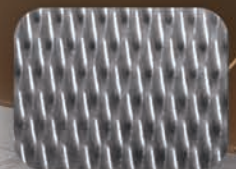

ADVANTAGES AND ACCESSORIES



- ▶ A leader in the industry with **over 60 years of experience**, offering the largest selection of partitions in the industry, with 4 different styles, and 9 different material options.
- ▶ **USA Made**—All of our products are proudly manufactured in Erie, PA U.S.A.
- ▶ **Outstanding customer service** since its inception—**second to none!**

- ▶ Our shipments arrive to you safely with our cellular poly wrap, which has proven to reduce freight damage.
- ▶ Express ship allows your orders to ship in as few as **2 working days**.
- ▶ Use of TORX head fasteners with pin to prevent theft and vandalism.
- ▶ Barrier free design and operational handles to meet ADA requirements.



PROJECTS THAT WE ARE PROUD TO BE PART OF



Fort Benning

Series 40-3

Fort Knox

Series 40-7

PNC Ballpark

280
Compartments:
of Series 40
floor mounted/
overhead braced.
Material: Powder
Coated Steel

Pentagon Wedge 1

240
Compartments: of
Series 40 floor
mounted/overhead
braced
Material: Solid
Phenolic Core

Boston Convention Center

250 Compartments:
Series 60
floor to ceiling.
Material: Stainless
Steel

Estadio-Chavis: Chivas Soccer Stadium— Guadalajara

680
Compartments: Combination
of 40 and 50 floor mounted/
overhead braced, and ceiling
hung.
Material: Anti-Graffiti Powder
Coated Steel, Stainless Steel
and Solid Phenolic Core



30 SERIES

Where no overhead bracing is required, but ceiling hung partitions are impractical, General Partitions' 30 series (floor supported) is ideal. Modern spaciousness and rigidity are important features. The 30 Series is also featured in a 54" "Junior Size" which has proved to be a great help with younger children.



40 SERIES

Our most popular style of toilet compartment construction is 40 Series (floor supported with headrail.) It is recommended for new and old buildings where economy, ease of installation, and rigid overhead bracing are required.



50 SERIES

The ease of floor maintenance when General Partitions' 50 Series (ceiling hung) style is used, has influenced architects and building owners to utilize this style particularly on construction where dropped ceiling or open span type construction is practical.



60 SERIES

General Partitions' floor to ceiling Series 60 is recommended for all areas subject to heavy usage. For problem areas, we recommend the use of full length aluminum brackets and hinges.



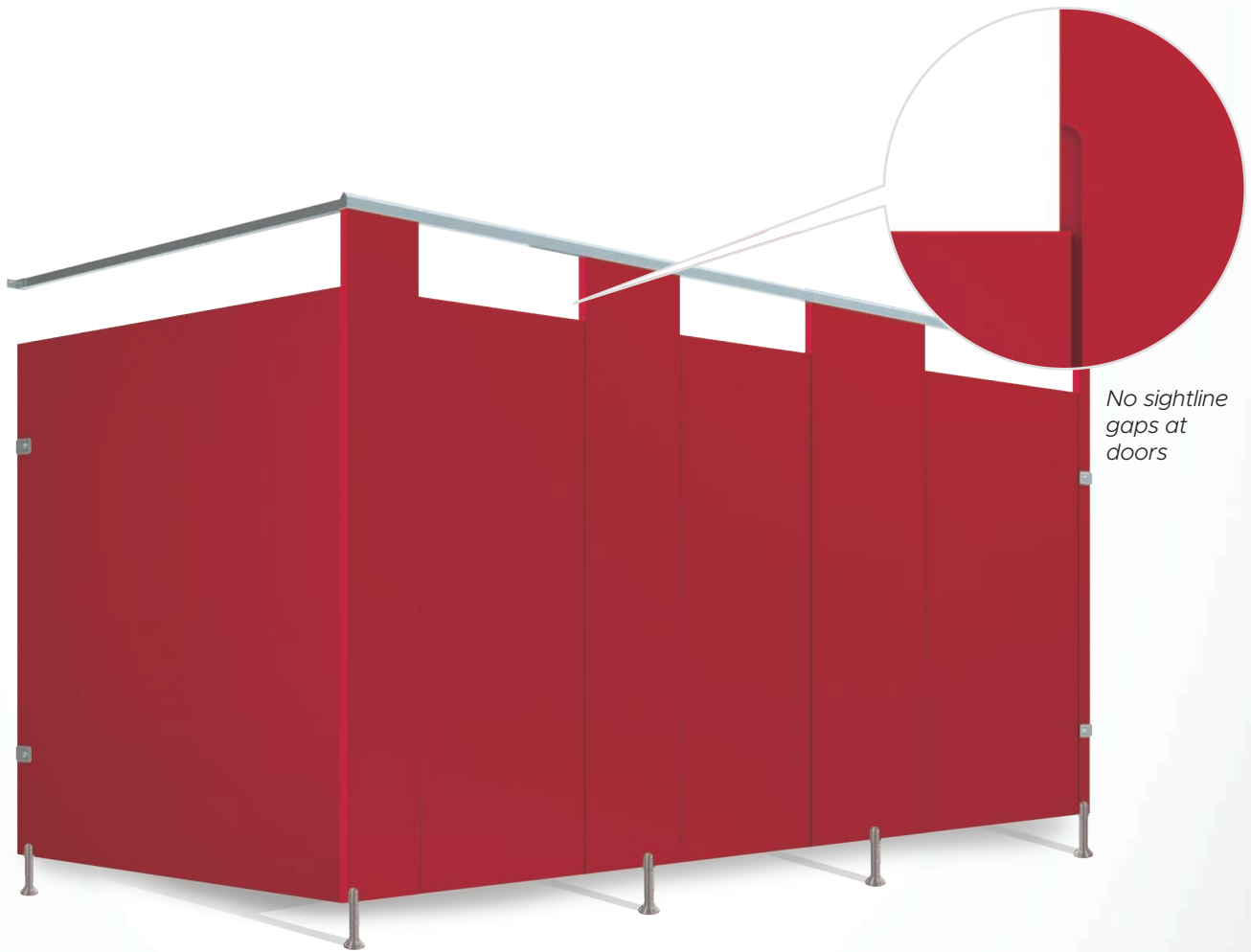

*No sightline
gaps at
doors*

EASTERN STYLE

When increased privacy is required **“Eastern style” is an option that can be incorporated into any of our partition series and materials.** Panels and doors are specified as 67” high and mounted 3-1/2” off of the floor.

EASTERN MAX STYLE

Eastern Max Style can be incorporated into any series and material of partitions when maximum privacy is required. Panels and doors are specified as 72” high and mounted 3-1/2” off of the floor. Continuous brackets and no-sight door options are available as add-ons to either Eastern Style to minimize any sight gaps.

FEATURES

- ▶ 67” or 72” high doors and panels
- ▶ Mounted 3-1/2” off the floor

OPTIONAL

- ▶ Continuous brackets / hinges
- ▶ No sightline gaps at doors
- ▶ Indicator latches
- ▶ Pedestal footing





PARTITION STYLES



2 DAY ULTRA
EXPRESS
SHIPPING

ANTI-GRAFFITI
OPTION AVAILABLE

Fireproof steel partition will not support a flame or produce toxic gases.

Express shipment will ship in 2 working days on all 21 colors. Some restrictions apply. Our complete color chart is available upon request.



No upcharge

POWDER COATED & STAINLESS STEEL CONSTRUCTION & DETAILS

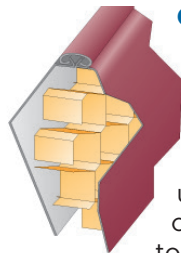
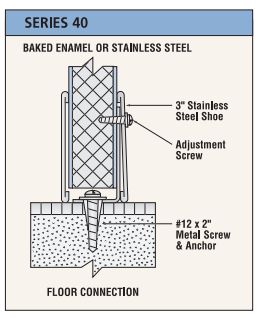

CONSTRUCTION

General's standard panel with Ribcore sound deadening reinforcement is offered as a standard at no extra charge. Sheet metal skins are bonded under pressure, to each cell of the core with an adhesive impervious to moisture. Lighter weight, greater strength and permanently flat panels are provided through this type of construction.

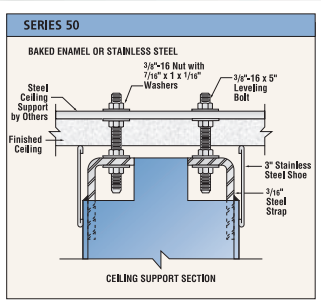

CORNER REINFORCEMENTS

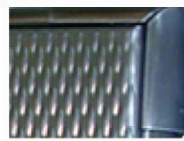

Used on all steel partitions at exposed corners. Mechanically fused to the edges. Doubles the strength of the corner. Also allows field repairs if and when required. Eliminates welding and grinding of the corners which removes the protective zinc coating.

MATERIAL OVERVIEW

General's Powder Coated Galvanized Bonderized Steel is available in all styles for toilet partitions, showers and dressing compartments. The economy and durability of Powder Coated Steel makes it the popular choice for new construction or remodeling.

GREEN ALERT

Environmentally safe—our Hybrid Polyester—Epoxy powder contains no harmful solvents or VOC's applied electrostatically and baked in an energy efficient infrared oven to cure. Contains post consumer and post industrial recycled steel and may contribute to LEED Certification.

MIN. 50% RECYCLED



STAINLESS STEEL



Stainless Steel is not only a good selection for strength and durability, but is an architecturally pleasing addition to any decor. Available in Satin, or two textured options for an upcharge.

- ▶ Fireproof steel partition will not support a flame or produce toxic gases.

TEXTURED STAINLESS STEEL

The partitions are fabricated with a deep textured finish, and offer the following advantages:

- ▶ Vandal Resistant
- ▶ Resists Fingerprints and Smudges
- ▶ Reduces Maintenance Costs
- ▶ Guaranteed 15 Years

MATERIAL OVERVIEW

General's stainless steel is available in all styles for toilet partitions, showers and dressing compartments. Stainless steel, the deluxe steel partition material will hold it's beauty for years. Dirt, grease and cosmetics are easily removed. Even scratches can be eliminated by buffing the finish and blending the surface.

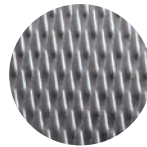

Diamond Pattern

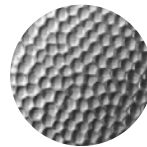

Dyno Pattern

Satin finish shown



GREEN ALERT

- ▶ No VOC's
- ▶ Contains post consumer and post industrial recycled steel and may contribute to LEED Certification.
- ▶ Stainless Steel is 100% recyclable.

MIN. 50% RECYCLED



POWDER COATED & STAINLESS STEEL CONSTRUCTION & DETAILS

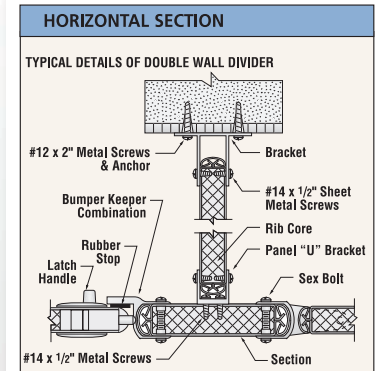
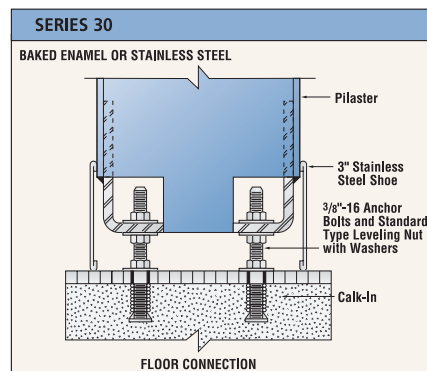



STANDARD

- ▶ Heavy duty 8" wraparound hinges and continuous aluminum brackets at all locations adds strength and durability
- ▶ Graffiti resistant
- ▶ 25 year guarantee

OPTIONS:

- ▶ Continuous plastic brackets and shoes
- ▶ Integral and continuous hinges
- ▶ No sight strike
- ▶ Also available to meet ASTM E 84 Class 'B' Fire Rating (as an upcharge)

Express shipment for all 18 colors will ship in 2 working days—some restrictions apply. Our color chart is available upon request.

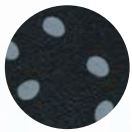

205
Galaxy



225
Designer White



228
Linen



236
Sterling



220
Cobalt

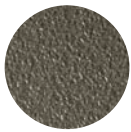

245
Shale



242
Titanium



250
Onyx



260
Sandstone



262
Latte



272
Fern

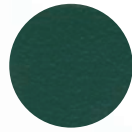

274
Hunter



290
Bordeaux



297
Mahogany

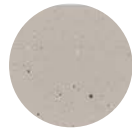

608
Quartz



602
Glacier Grey

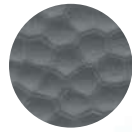

501
Hammered
Stainless



502
Hammered
Bronze

MATERIAL OVERVIEW

General's HDP toilet partitions, showers and dressing compartments are manufactured using high density polymer resin. Color is solid thru-out. Compartments will not rust, rot delaminate or absorb odors like marble. Water resistant, can be used under any moisture condition. Perfect for shower and dressing compartments as well as toilet partitions. Resists mold, mildew, bacteria & fungus.



GREEN ALERT

- ▶ We recycle all waste and scrap during our manufacturing process.
- ▶ We use reclaimed material in our production.
- ▶ Our HDP sheets are completely 100% recyclable.

25-70% PRECONSUMER MATERIAL

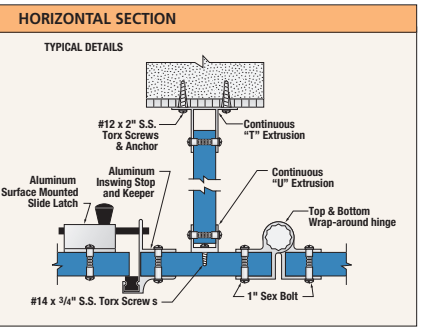

SOLID PHENOLIC CORE



1573-60* Frosty White	D30-60* Natural Almond	D381-60* Fashion Grey	4830-60* Satin Stainless	4878-60* Pewter Mesh
4882-60* Oiled Soapstone	4623-60* Graphite Nebula	4142-60* Grey Glace	1595-60* Black	D321-60* Brittany Blue
4926-60 Black Alicante	4924-60 White Carrara	4170-60 Beige Pampas	4990-60 Flax Linen	D327-60 Pepperdust
4886-60 Pearl Soapstone	4843-60 Misted Zephyr	4992-60 Tailored Linen	4779-60 Pewter Brush	4879-60 Steel Mesh
4651-60 Navy Legacy	4674-60 Evening Tigris	8204-60 Weathered Char	4820-60 Carbon Ev	4888-60 Rustic Slate
4669-60 Natural Tigris	D307-60 Hollyberry	D14-60 Port	7937-60 River Cherry	7954-60 Natural Rift



SCRATCH AND GRAFFITI RESISTANT FINISH



General's SPC toilet partitions, showers and dressing compartments are fabricated of solid phenolic core with matte finish high pressure melamine fusion welded to surface of core to form a one piece unit which will not delaminate, edges are black solid phenolic resin. Resists moisture, scratches and abrasion. SPC panels provide exceptional chemical and stain resistance combined with superior impact resistance. Class 'B' Fire Rating is standard.

GREEN ALERT

- ▶ NSF & SFI Certified
- ▶ May contribute to LEED Certification

***Express shipment will ship in 2 working days**
—some restrictions apply. Our color chart is available upon request.

COLOR-THRU SOLID PHENOLIC CORE

Color-Thru Solid Phenolic Core offers all the strength and durability of our black core phenolic, with the added advantage of consistent matching color throughout the core. It is a perfect choice for high traffic areas. The Color-Thru Phenolic carries all the same specs and hardware as our standard black core SPC. Class 'A' Fire Rating is standard.



COLOR THROUGHOUT

SCRATCH AND GRAFFITI RESISTANT FINISH

ADVANTAGES

Toilet Partitions offering all of the dependability of Phenolic, but adds the advantage of being color consistent throughout the thickness of the partition.

STANDARD PRODUCT HIGHLIGHTS

- ▶ Core color extends all the way through the product
- ▶ All 15 colors made in USA
- ▶ Resists moisture, scratches, and abrasions

15 COLORS

STANDARD COLORS								
	4990 Flax Linen	D50 Khaki Brown	D92 Dove Grey	4981 Calacatta Oro	4887 Tan Soapstone	4991 Pressed Linen	4886 Pearl Soapstone	D30 Natural Almond
PREMIUM COLORS								
	8203 Silver Oak Ply	4860 Silver Alchemy	8212 Phantom ECRU	8202 Light Oak Ply	7967 Park Elm	7970 High Line	7999 Field Elm	



Introducing General Partitions' new line of washroom accessories. We have been in the commercial bathroom partition manufacturing business for over 50 years, providing outstanding products and customer service. General Partitions' line of accessories is the perfect addition to any commercial washroom. Included in this product guide are our most popular accessories, but you can view our accessory catalog at www.generalpartitions.com for our complete list of available accessories.



SURFACE MOUNTED DUAL ROLL TOILET TISSUE DISPENSER

- Two standard toilet tissue roll capacity
- Satin stainless steel
- Net weight: 4.32 lbs
- 150 (W) x 280 (H) x 155 (D) mm
- 5-7/8" (W) x 11" (H) x 6-1/8" (D)

Item number: GP-107



SURFACE MOUNTED DUAL ROLL TOILET TISSUE DISPENSER

- Two standard toilet tissue roll capacity
- Satin stainless steel
- Net weight: 4.59 lbs
- 155 (W) x 280 (H) x 145 (D) mm
- 6-1/8" (W) x 11" (H) x 5-11/16" (D)

Item number: GP-108



SURFACE MOUNT PAPER TOWEL DISPENSER

- C-fold or multifold towels
- Tumbler lock
- Satin stainless steel
- Net weight: 2.2 lbs
- 285 (W) x 370 (H) x 105 (D) mm
 - 11-1/4" (W) x 14-9/16" (H) x 4-1/8" (D)

Item number: GP-201



STAINLESS STEEL TOILET SEAT COVER DISPENSER

- Satin stainless steel
- Net weight: 1.25 lbs
- 400 (W) x 290 (H) x 50 (D) mm
 - 15-3/4" (W) x 11-3/7" (H) x 2" (D)

Item number: GP-109



SINGLE ROBE HOOK

- Bright polished finish
- Concealed surface mounting
- Satin stainless steel
- Net weight: .23 lbs
- 2" x 2" x 1 5/8"

Item number: GP-907



**View more products
on our website
generalpartitions.com**

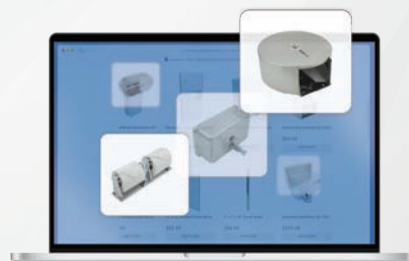



18" STAINLESS STEEL GRAB BAR

- Stainless steel
- Snap-on flange
- Net weight: 1.2 lbs
- Length 18" (450mm)
- Depth 2-3/4" (70mm)

Item number: GP-609
1-1/2" Diameter

36" STAINLESS STEEL GRAB BAR

- Stainless steel
- Snap-on flange
- Net weight: 1.8 lbs
- Length 36" (900mm)
- Depth 2-3/4" (70mm)

Item number: GP-612
1-1/2" Diameter

42" STAINLESS STEEL GRAB BAR

- Stainless steel
- Snap-on flange
- Net weight: 2.0 lbs
- Length 42" (1070mm)
- Depth 2-3/4" (70mm)

Item number: GP-613
1-1/2" Diameter



SANITARY NAPKIN DISPOSAL

- Satin stainless steel
- Net weight: 0.65 lbs
- 206 (W) x 280 (H) x 105 (D) mm
 - 8-1/8" (W) x 11" (H) x 4-1/8" (D)
- 4.8L capacity

Item number: GP-401



AUTO MULTI-FUNCTION SOAP DISPENSER

- Hands-free
- Auto-detecting sensor
- Capacity: 500 mL (16.9 oz.)
- Net weight: 2 lbs
- 106 (W) x 230 (H) x 95 (D) mm
 - 4-1/6" (W) x 9" (H) x 3-3/4" (D)

Item number: GP-505



CHANNEL FRAME MIRROR

- Satin stainless steel frame with mitered corners
- 1/4" Thick Float Glass Mirror, electrolytic copper back
- 22 gauge wall plate and backplate

Item number: GP-901 **18" X 36"**

Item number: GP-902 **24" X 36"**



View more products
on our website
generalpartitions.com



SOLID PLASTIC HDP LOCKERS



General Partitions' solid plastic locker is constructed of a one-piece HDP body with no mechanical fasteners or hardware.

The locker frame is attached using full length dado joints secured by continuous plastic welds. The continuous spring-loaded latch mechanism provides a vertical lift that is designed to accept a padlock. The latch mechanism is attached to the length of the door, providing a continuous, secure latch.







Our Door Hinge is also continuous and contains no metallic knuckles or pins. Solid Plastic benches with pedestals available to match the lockers.

- ▶ Solidly Constructed of High Density Polymer
- ▶ Perfect for High Moisture Areas
- ▶ Will not Rust, Rot, Dent or Corrode
- ▶ 20 Year Limited Warranty



- ▶ We recycle all waste and scrap during our manufacturing process.
- ▶ We use reclaimed material in our production.
- ▶ Our HDP sheets are completely 100% recyclable.



-  **250**
onyx
-  **274**
hunter
-  **236**
sterling
-  **290**
bordeaux
-  **238**
oyster
-  **220**
cobalt

AVAILABLE SIZES

A = 12", 15", or 18"
 B = 12", 15", or 18"
 C = 60" or 72"

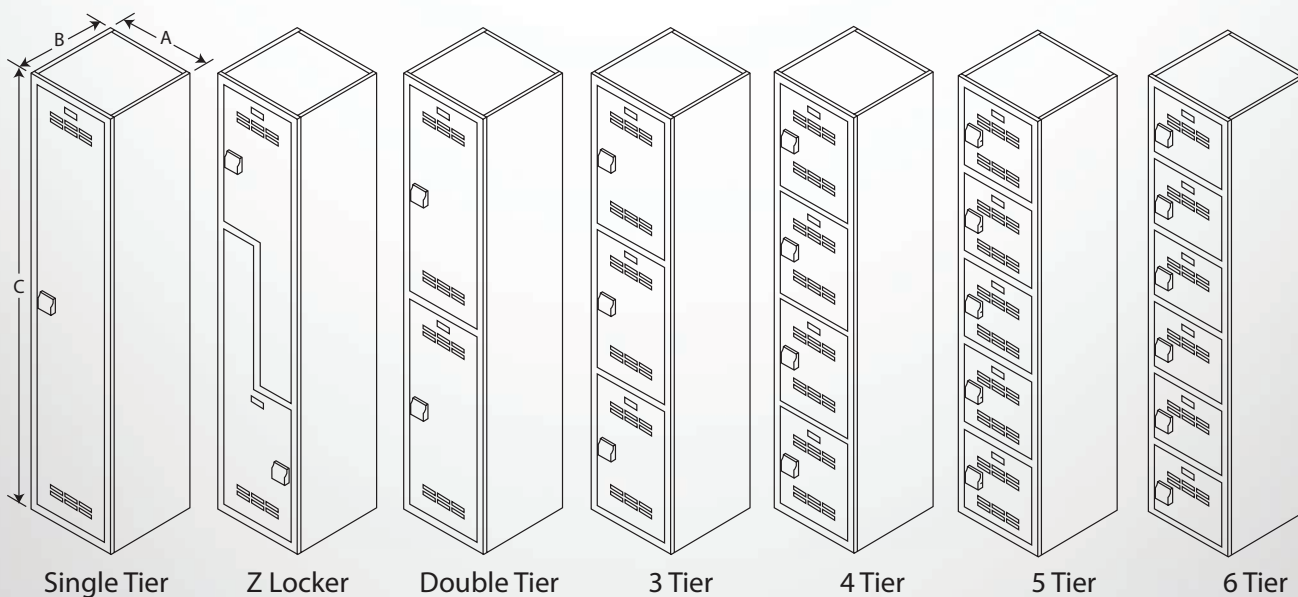



URINAL SCREENS

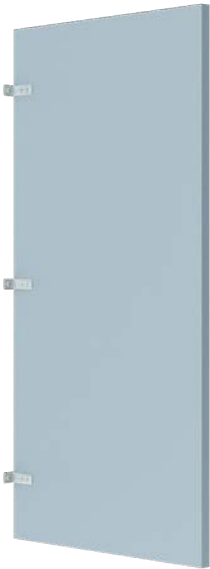

Wall Hung (WHS)

Wall Hung (WHS)

Screen is hung from three chrome-plated "T" brackets.



Wall Hung (WHS)
(Shown with
optional flange)



Floor Braced
Screen (FBS)

Floor Braced Screen (FBS)

Screen panel supported by a floor supported pilaster (see Series 30 specification).

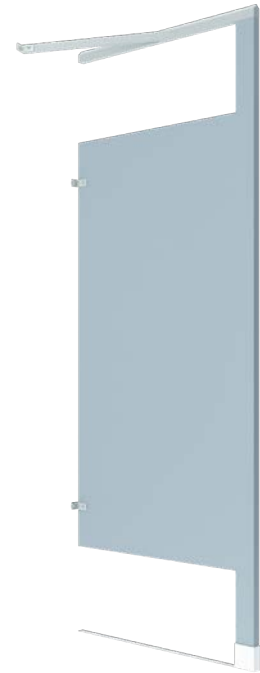

Floor Supported
with Headrail (FSH)

Floor Supported With Headrail (FSH)

Headrail braced (see Series 40 specification). Panel supported by pilaster with headrail bracing.

SHOWER CABINETS

Shower Cabinets

General Partitions' shower is the finest in double-wall unit shower construction. It features a pre-cast terrazzo receptor. Available sizes—32" x 32" x 82", 36" x 36" x 82", 40" x 40" x 82" Neocorner, 40" x 40" x 82" or 40" x 48" x 82" Handicapped.



Physically Handicapped Accommodations

SHOWER/DRESSING COMPARTMENTS

Our shower / dressing compartments are available in Powder Coated, Stainless Steel, SPC (Solid Phenolic Core), HDPE (High Density Polymer). Perfect for dividing off shower rooms with a central drain. Can be configured with either curtains or doors. Eastern Height or Eastern Max can be incorporated when more privacy is desired.

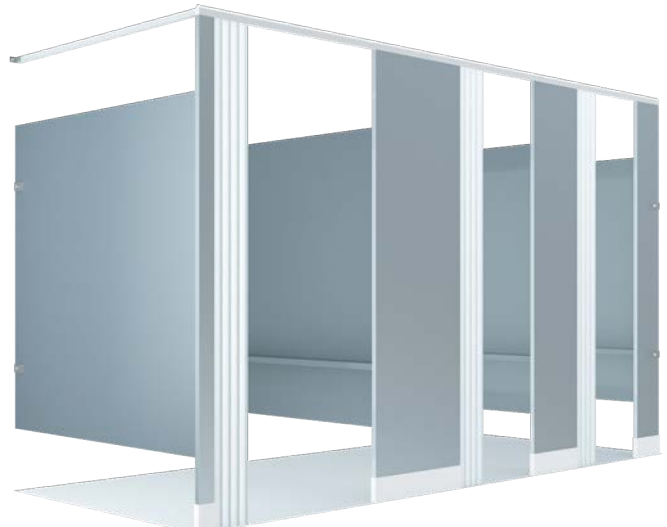

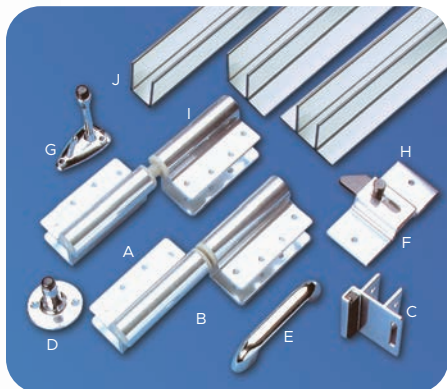

H.D.P. (HIGH DENSITY POLYMER)

- A 1500 AL-T Top Assembly Aluminum Wrap-Around Gravity Hinge
- B 1500 AL-B Bottom Assembly Aluminum Wrap-Around Gravity Hinge
- C 2060-IAL Inswing Stop and Keeper—Aluminum 2060-OAL Outswing (Not Shown) Stop and Keeper—Aluminum
- D 6250 Door Bumper
- E 6300 Door Pull
- F 2000 AL Surface Mounted Slide Latch—Aluminum
- G 6200D Combination Coat Hook and Bumper
- H 6000 EXT 1" (54") "T" Bracket
- I 6060 EXT 1" (54") "L" Bracket
- J 6030 EXT 1" (54") "U" Bracket



BAKED ENAMEL/STAINLESS STEEL

- A 2060D Combination Stop and Keeper
- B 1250D Top Hinge Bracket
- C 1250D-B Bottom Hinge Bracket with Male Cam (sold separately)
- D 6200D Combination Coat Hook and Bumper
- E 1500D-T Top Hinge Pin
- F 1000D-C Spring Activated Cam Mechanism
- H Miscellaneous Screws
- I 4000 1" Two Ear Chrome Wall Bracket
- J 4030 1" "U" Chrome Bracket
- K 2000D Concealed Latch Operating Handle
- M 6250 Door Bumper
- N 4120 1 1/4" One Ear Chrome Wall Bracket
- O 4060 1" One Ear Chrome Wall Bracket
- P 6300 Door Pull



PLASTIC LAMINATE

- A 2060C-PL Combination Stop and Keeper
- B 1250PL-T Top Hinge Bracket
- C 1500PL Concealed Top Hinge
- D 1500PL-T Top Hinge Pin
- E 1000PL Concealed Bottom Hinge
- F 1000PL Female Cam
- G 1250PL-B Bottom Hinge Bracket with Male Cam (sold separately)
- H 2000CPL Concealed Latch with Bar
- J Miscellaneous Screws
- K 4120 1 1/4" One Ear Chrome Wall Bracket
- L 4060 1" One Ear Chrome Wall Bracket
- M 6300 Door Pull
- N 6250 Door Bumper
- O 6200D Combination Coat Hook and Bumper
- P 4000 1" Two Ear Chrome Wall Bracket
- Q 4030 1" "U" Chrome Bracket

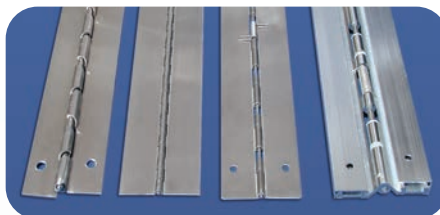

OPTIONAL FULL LENGTH HINGES

- ▶ Stainless Steel Cam
- ▶ Stainless Steel Piano
- ▶ Spring Loaded Stainless Steel
- ▶ Spring Loaded Aluminum Hinge with Covers (Concealed Fasteners)

OPTIONAL HEAVY DUTY FULL LENGTH BRACKETS

Available in Aluminum or Stainless Steel

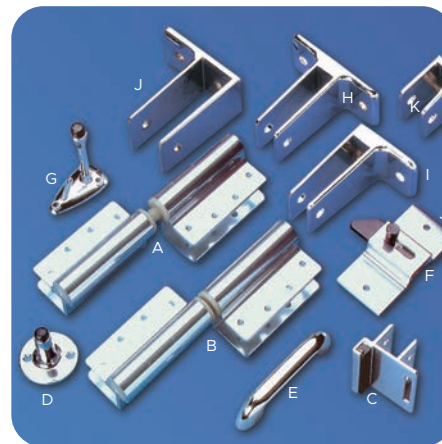

S.P.C. (SOLID PHENOLIC CORE)

- A 1500 AL-T Top Assembly Aluminum Wrap-Around Gravity Hinge
- B 1500 AL-B Bottom Assembly Aluminum Wrap-Around Gravity Hinge
- C 2060-IAL Inswing Stop and Keeper—Aluminum 2060-OAL Outswing (Not Shown) Stop and Keeper—Aluminum
- D 6250 Door Bumper
- E 6300 Door Pull
- F 2000 AL Surface Mounted Slide Latch—Aluminum
- G 6200D Combination Coat Hook and Bumper
- H 4000 (.5) 1/2" "T" Chrome Bracket
- I 4060 (.5) 1/2" "L" Chrome Bracket
- J 4060 1" "L" Chrome Bracket
- K 4030 (.5) 1/2" "U" Chrome Bracket



F.R.P. (FIBERGLASS REINFORCED PLASTIC)

- A 1500 AL-T Top Assembly Aluminum Wrap-Around Gravity Hinge
- B 1500 AL-B Bottom Assembly Aluminum Wrap-Around Gravity Hinge
- C 2060-IAL Inswing Stop and Keeper—Aluminum 2060-OAL Outswing (Not Shown) Stop and Keeper - Aluminum
- D 6250 Door Bumper
- E 6300 Door Pull
- F 2000 AL Surface Mounted Slide Latch - Aluminum
- G 6200D Combination Coat Hook and Bumper
- H 4000 1" Double Aluminum "T" Bracket
- I 4060 1" Double Aluminum "L" Bracket
- I 4030 1" Double Aluminum "U" Bracket (not shown)



GENERAL PARTITIONS MFG. CORP.
 1702 Peninsula Drive • Erie, PA 16505-4243
 P.O. Box 8370 • Erie, PA 16505-0370
 Phone 814.833.1154 • Fax 814.838.3473
 GeneralPartitions.com
 info@GeneralPartitions.com

Printed on Recycled Paper

Printed in the USA 2022