

privacy by **DESIGN**

Eclipse Partitions – Color: White, Texture: Orange Peel
Configuration: Floor Mounted Overhead Braced, Height: 62" High Panels & Doors

Eclipse Partitions are the future of restroom partitions that offer both **innovative design aesthetics** and **durable performance**.

The clean lines of this system provide a **contemporary look** to any bathroom décor. The high privacy design delivers **enhanced privacy** above traditional partitions.



**ECLIPSE
PARTITIONS™**

FEATURES

- High privacy design
- Innovative hinge & post design structure
- Contemporary anti-grip head rail
- Durable solid performance plastic material

next GENERATION OF PARTITIONS



Eclipse Partitions – Color: Sandstone, Texture: Orange Peel
Configuration: Floor Mounted Overhead Braced, Height: 62" High Panels & Doors

ECLIPSE PARTITIONS
Combining **innovative aesthetics** with **durable performance**, Eclipse Partitions' **minimum sight design** offers advanced privacy. The contemporary look and extensive color and texture collections are sure to **enhance your facility décor.**

INNOVATIVE HINGE
The new edge-mounted continuous stainless steel hinge provides a no sight and sleek aesthetic to your restroom design.

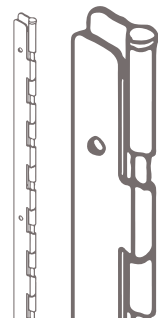

SHIPLAP EDGE
Creates an overlap, eliminating vertical sight lines for increased privacy.

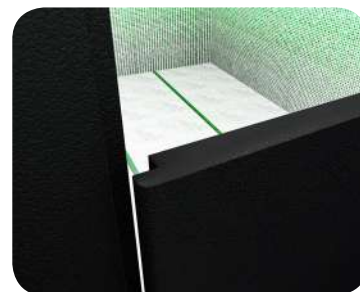

Example of shiplap

CLEAN EXTERIOR AESTHETICS
Designed with minimal exterior hardware visible on the outside of the stalls.



HEIGHT OPTIONS
55" standard, *62" high, and *72" extra high doors and panels.

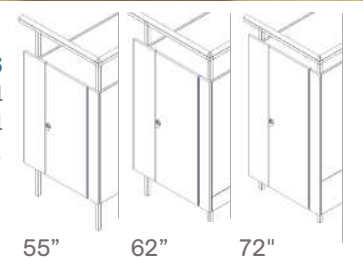

*Modular panel may be required if stall depth is greater than 55".

COLOR, TEXTURE & DESIGN OPTIONS



TRADITIONAL COLOR COLLECTION



BOLD COLOR COLLECTION

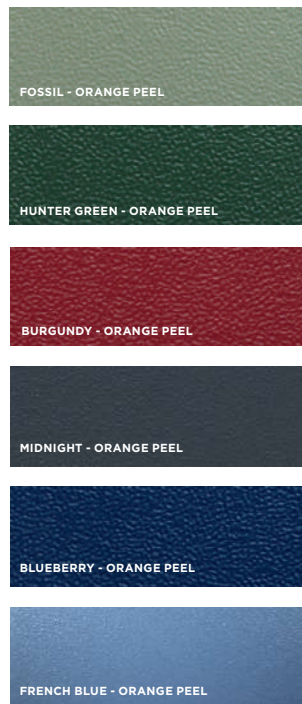

WARM COLOR COLLECTION



METALLIC COLOR COLLECTION

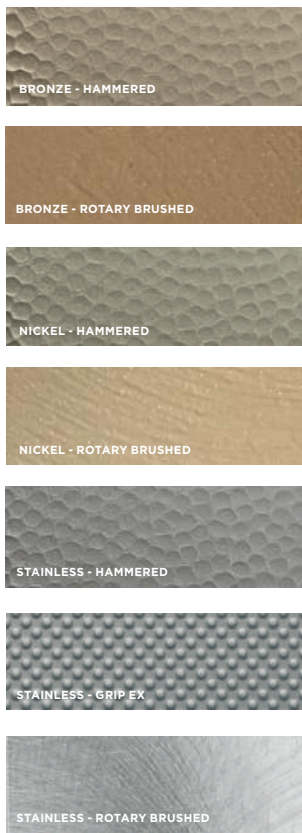

CUSTOM COLORS AVAILABLE UPON REQUEST.

Color matching is limited by printing process. Actual samples are available and recommended prior to color selections.

*Special orders require extended lead times. Minimum order requirements may apply.

DESIGN OPTIONS

BRACKETS
Single Ear Bracket

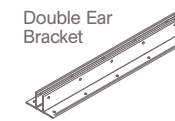
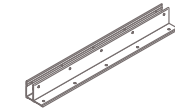

HINGES
Edge-Mounted
Stainless Steel
Continuous Hinge



STANCHION

Stanchion Cap



Stanchion

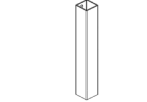

Corner Cap

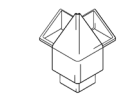

Stanchion Support

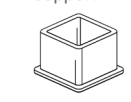

HEAD RAIL
Aluminum

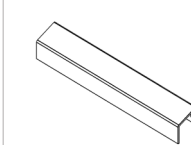

LATCH
Occupancy Indicator

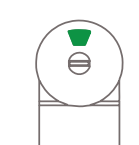

HEIGHT OPTIONS

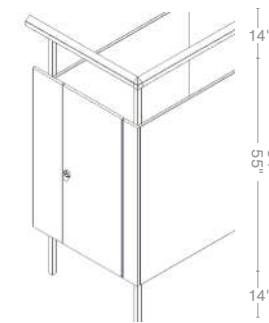

55" Standard



62" High*

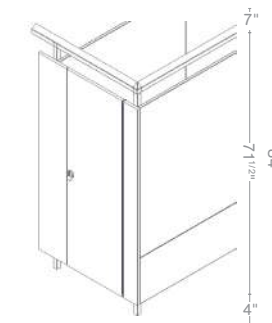

72" Extra High*

*Modular panel may be required if stall depth is greater than 55".

Modular Panels

*Panel stacking with hidden dowels are provided on all configurations



CONFIGURATION OPTIONS

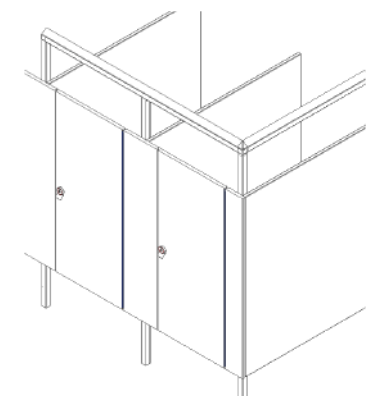

Floor Mounted
Overhead Braced

FIRE RATING

Whether your fire rating needs are NFPA 286, Class A, or Class B, we have the material to match.