



**POWDER COATED**  
TOILET PARTITIONS

hadrian®



**RBC CENTRE**  
TORONTO, ONTARIO, CANADA  
414 HEADRAIL BRACED POWDER COATED TOILET PARTITIONS

© LAWRENCE BLACK/EMPORIS

POWDER COATED

MARKET COST INDEX: \$  \$\$\$

FIRE RATING: C (GOOD)  B (BETTER)  A (BEST)

RECYCLED CONTENT: 36% post-consumer / 14% pre-consumer

# Powder Coated

TOILET PARTITIONS

Low Cost and High Performance – The Best Industry Value

## FAST, RELIABLE LEAD TIMES

With great stock programs and lightning fast lead times, Hadrian's powder coated toilet partitions are available to meet any deadline. 99% on time deliveries and 98% damage-free shipments ensure that your toilet partitions are there when you need them.



## ENVIRONMENTALLY FRIENDLY

Hadrian's powder coated toilet partitions have an excellent **recycled content of 50% (36% post-consumer and 14% pre-consumer)**, making them a great choice for environmentally sensitive projects.

Hadrian is proud of the fact that its powder coating system is environmentally friendly. There is virtually no waste, energy consumption is low, and there are no solvent emissions.



## INDUSTRY-BEST FIRE RESISTANCE

Hadrian's powder coated toilet partitions are completely fireproof and will not give off toxic smoke if exposed to heat or flame. With a CLASS A fire rating, no other product performs better.

## DURABLE AND REPAIRABLE

Unlike other materials, powder coated toilet partitions can be successfully repaired should vandalism occur.

# Styles

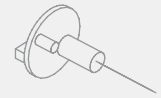
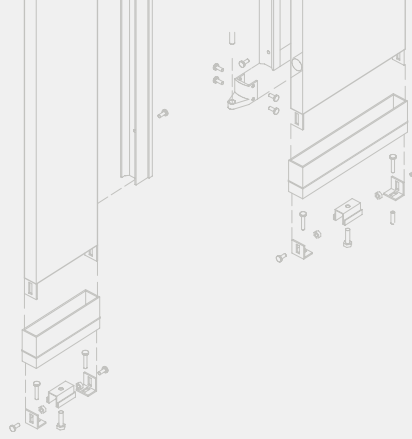

## HEADRAIL BRACED

Headrail braced compartments are a great choice for virtually any facility. These units are especially recommended in heavy-use areas such as schools, institutions and industrial settings. The anti-grip top rail deters boisterous activity while ensuring a rigid and secure installation.



## CEILING HUNG

Ceiling hung units present a clean, contemporary appearance. They permit quick, easy floor maintenance, especially when combined with wall-hung fixtures. Ceiling hung partitions are recommended for modernization where a drop ceiling or open span construction can be used.



## FLOOR MOUNTED

The clean lines of floor mounted units lend an air of spaciousness to these installations. The absence of top structure makes them the ideal choice for high ceiling areas and allows a wide range of complimentary architectural and interior decoration possibilities.



## FLOOR TO CEILING

Floor to ceiling units are extremely strong and resistant to abuse as they are securely connected to the floor, ceiling and walls. This configuration is ideal for high abuse areas and installations that require extra durability.



## STANDARD SERIES

Hadrian's standard series features 58" high doors and panels, which are mounted 12" off the finished floor.

*Available in headrail braced, ceiling hung, floor mounted and floor to ceiling styles.*



## ELITE SERIES

Hadrian's Elite Series offers increased privacy with 64" (1626mm) high doors and panels, mounted just 6" or 9" (229mm) from the finished floor. Continuous channels eliminate all sightline gaps.

*Available in headrail braced, ceiling hung, floor mounted and floor to ceiling styles.*



## ELITE PLUS SYSTEM

Taking the Elite concept a step further, Hadrian's Elite Plus System affords maximum privacy with 72" (1829mm) high doors and panels, mounted just 6" or 9" (229mm) from the finished floor. Continuous channels eliminate all sightline gaps.

*Available in headrail braced, ceiling hung, and door to ceiling styles.*

## SCREENS



### WALL MOUNTED

This simple and economical design features a 48" (1219mm) high screen, which meets International Plumbing Code (IPC) requirements and permits easy maintenance and floor cleaning.



### FLOOR MOUNTED

Features a 58" (1473mm) high screen and floor mounted pilaster for extra support.

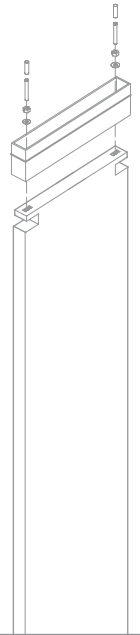

# Powder Coated Tough!

Hadrian utilizes the latest powder coating technology to apply a hard, even and run-free finish. After a thorough cleaning and phosphatizing process, electrical charges ensure that the powder paint adheres uniformly over the entire product surface. The powder is then oven cured to create an attractive, permanent and consistent finish that covers every area of the product and resists impact, abrasions, chemicals, detergents and acids.

Thicker paint application helps to combat rust. Powder coating allows a greater paint thickness to be applied without compromising surface uniformity. Wet paints simply cannot achieve the same thickness without the threat of unsightly runs and surface irregularities.

The flexibility of powder coating allows Hadrian to offer a wide range of exciting finishes, including special effects, anti-graffiti and custom colors.

## ANTI-GRAFFITI

Hadrian's anti-graffiti toilet partitions allow the use of commercial graffiti removers to completely eliminate graffiti without causing damage to the finish. The powder coating retains its original brilliance and no ghost of the graffiti is left behind!

### Proven ASTM D6578 Graffiti Resistance

- Permanent Marker
- Lipstick
- Water Based Ink Marker
- Wax Crayon
- Spray Paint



# Features

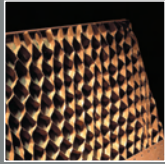

## FULL HONEYCOMB CORE

Doors, panels and pilasters are structurally reinforced with 1" (25mm) cell honeycomb bonded from top to bottom and edge to edge throughout their entire core. The honeycomb reinforcement enhances strength, sound absorption, and overall impact resistance.

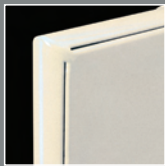

## CLEAN, ATTRACTIVE CORNERS – MITRED, WELDED AND GROUND SMOOTH

Hadrian's "trademark" corners are unmatched for their clean, attractive appearance. The superior strength of Hadrian's full corner weld offers a hygienic seal and prevents parts from loosening and detaching.



## BARRIER-FREE LEVER LATCH

Hadrian's exclusive thumbturn lever conforms to American Disability Act requirements and the Canadian Handicap Code. It can be activated with a short, easy movement and without finger-grip application.



## SAFETY RELEASE LATCH

Both standard and barrier-free latch designs allow access from the exterior in case of emergency. The design is minimal for appearance, easy cleaning, and resistance to vandalism. The "Hadrian" name assists maintenance staff in locating the source for replacement parts.



## METAL HINGE PIN WITH NYLON SLEEVE

The metal core of Hadrian's upper hinge pin provides sturdy support while the self-lubricating nylon sleeve ensures smooth, quiet operation. The threaded pin can be easily removed and reinserted if necessary.

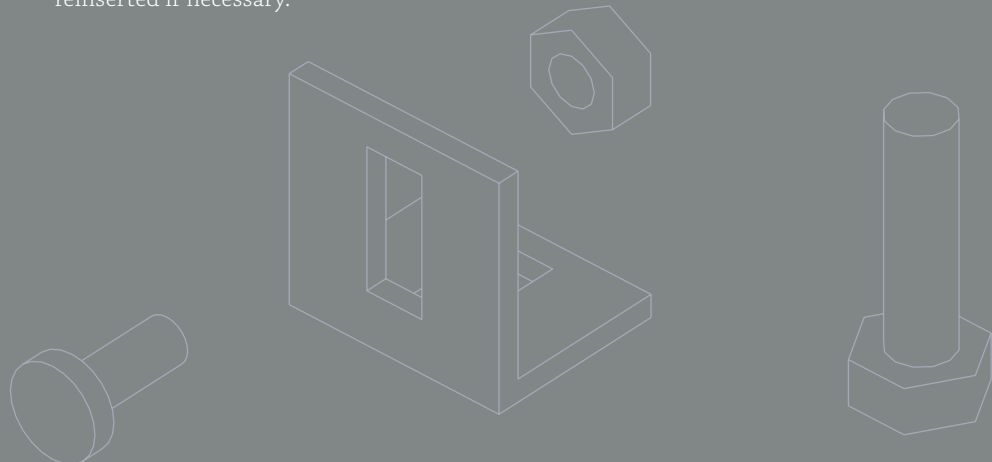

## REINFORCED HEADRAIL BRACED PILASTER TOPS

An added 20-gauge channel creates extra strength and twist-free rigidity to minimize the possibility of damage by handling and shipping.

## ANTI-GRIP TOP RAIL

Extruded aluminum headrail offers maximum strength, rigidity, and a clean line appearance. Its double-ridge anti-grip design deters boisterous activity and consequent damage, while still offering a smooth track for shower curtain hooks.

## LOCKING BAR EDGE MOULDING

All components are tack welded and interlocked under tension with a roll-formed oval crown locking bar for continuous bonding and a permanent, hygienic seal.

## CONCEALED HINGE MOUNTING

Hinges are concealed within the thickness of the door, top and bottom, for sanitary, easy maintenance and modern styling. This sleek design eliminates the need for exposed fasteners on the door face.

## HIGH QUALITY HARDWARE

All brackets and door hardware components are zinc die-cast and triple plated with copper, nickel and chrome to a gleaming finish. Pilaster shoes are a one-piece welded design of polished stainless steel.

## OPTIONS

### THE “NO-SIGHTLINE SOLUTION”

Maximizing privacy, Hadrian’s “No-Sightline Solution” features a full height continuous stop and hinge side filler to completely eliminate all sightline gaps around the door. The full-length rubber bumper on the stop deadens sound and protects against wear. The versatility of the “No-Sightline Solution” means it can be used in new and pre-existing installations. Substitute the heavy-duty continuous hinge on the hinge side for added strength without compromising privacy.



### HEAVY-DUTY CONTINUOUS HINGE

Hadrian’s economically priced continuous hinge is ideal for high-abuse areas where extra strength and durability are a concern. Made with heavy-duty 16-gauge material, the continuous hinge is available in powder coated or brushed stainless steel finishes. A stainless steel hinge pin is standard on both models. As an added value, Hadrian’s continuous hinge also serves as a “no-sightline” feature on the hinge side of the door.



### STAINLESS STEEL HARDWARE PACKAGE

A hardware package with brushed stainless steel wall brackets, hinges and fasteners is available. Standard brackets and hinges are zinc-cast, plated and brush finished to match the stainless steel doors and panels.



Hadrian prides itself on being a professional and friendly company that is easy to deal with. We make it a priority to spend time getting to know our customers and work with them to meet the challenges of their specific market. Our local representatives ensure Architect, Interior Designer, Specification Writer, Government Planner, School Official and End-User sales coverage while also expeditiously addressing field support needs and jobsite concerns.

**QUESTIONS? COMMENTS? CONCERNS?**  
**CALL US – WE WANT TO HEAR FROM YOU!**

# hadrian®

**IN THE U.S.A.:**

**Hadrian Inc.,**  
7420 Clover Avenue,  
Mentor, Ohio, U.S.A. 44060

3602 West Washington St., Suite 200  
Phoenix, Arizona, U.S.A. 85009

Telephone: (440) 942-9118 Fax: (440) 942-9618  
U.S. toll free fax: 1-800-536-1469

**IN CANADA AND AREAS OTHER THAN U.S.A.:**

**Hadrian Manufacturing Inc.,**  
965 Syscon Road,  
Burlington, Ontario, Canada L7L 5S3

Telephone: (905) 333-0300 Fax: (905) 333-1841  
Canada toll free fax: 1-888-817-7701

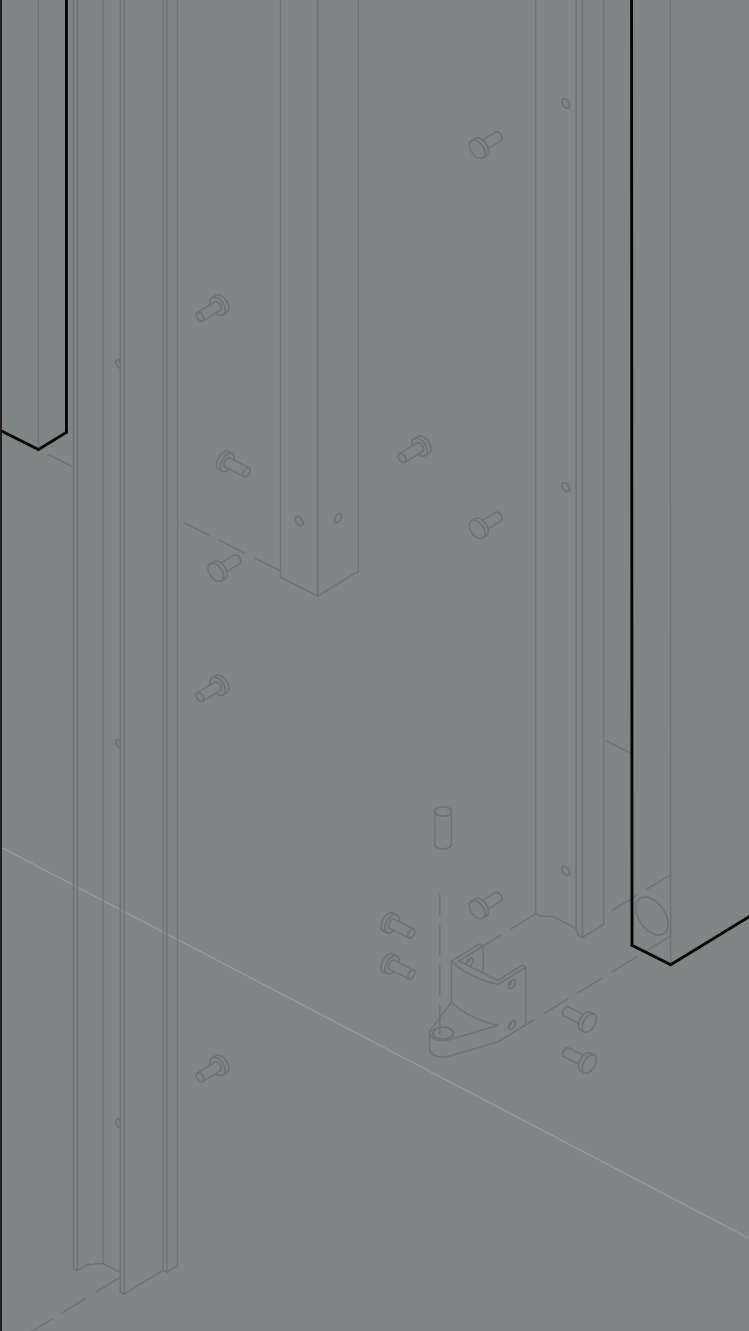

**ALSO SEE US IN:**

**ARCAT®**  
www.arcat.com

**McGraw Hill**  
**CONSTRUCTION Sweets®**  
www.sweets.com

FREE On-line  
Continuing Education  
**@AEC DAILY**  
Increasing Product Reach through Education  
www.aecdaily.com

