

Balcrank

Fluid Dispensing Systems

Automotive | Commercial | Industrial

Diesel Exhaust Fluid (DEF)

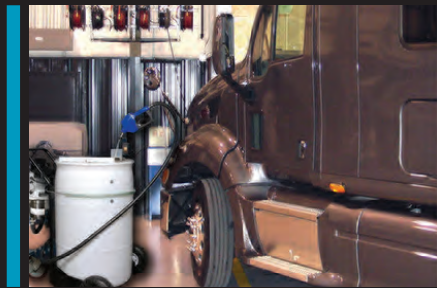

Open Systems Drum and Tote Packages

Lever Pump System

- EPDM seals for maximum chemical compatibility.
- Includes**
- 1300-028 Lever action pump.
- Bung adapter included - securely fasten pump to drum.
- 6'x1" Clear hose, clamp-on.
- Options**
- 3340-011 Manual nozzle.



Drums Not included

MODELS AVAILABLE	DESCRIPTION
1310-005	Lever pump and spout
1310-006	Lever pump and manual nozzle

TECHNICAL DATA	
Delivery Volume	1 pint per stroke (500 cc)
Temp Range	23 °F to 113 °F (-5 °C to 45 °C)
Wetted Materials	Polypropylene, EPDM
Service Bulletin	SB 1117

Stick Pump System

- Integral clip to hang the pump for storage when not in drum - keeps dirt out of pump tube.
- Self priming, self draining - prevents spills
- Ergonomic design, safe to run dry - lightweight, rugged and easy to use.
- Includes**
- 1200-015 Electric Stick Pump, tote length.
- Bung adapter included - securely fasten pump to drum.
- 8560-006, 6' x 3/4" Dispense hose.
- Options**
- 3120-119 DEF turbine meter with metered packages.



MODELS AVAILABLE	DESCRIPTION
1210-007A	Drum Stick Pump Non metered, Manual Nozzle
1210-007B	Drum Stick Pump Non metered, Auto Nozzle

TECHNICAL DATA	
Max delivery rate	10.5 gal/min (39.75 l/min)
Max delivery head	17' (5.18 m)
Wetted Materials	316 SS, PTFE, Viton®, PP, PE, ETFE
Power	110 V AC
Service Bulletin	SB 1108

Tote Packages

- Integral clip to hang the pump for storage when not in drum - keeps dirt out of pump tube.
- Self priming, self draining - prevents spills
- Ergonomic design, safe to run dry - lightweight, rugged and easy to use.
- Includes**
- 1200-016 Electric Stick Pump, tote length.
- Bung adapter included - securely fasten pump to drum.
- 8561-012, 12' x 3/4" Dispense hose.
- Options**
- 3340-012 Auto Nozzle.



Tote Not included

MODELS AVAILABLE	DESCRIPTION
1210-009B	Tote Stick Pump Non metered, Auto Nozzle

TECHNICAL DATA	
Max delivery rate	22 gal/min (83.28 l/min)
Max delivery head	59' (18 m)
Power	120 V AC
Wetted Materials	316 SS, PTFE, Viton, PP, PE, ETFE
Service Bulletin	SB 1109

CLOSED system containers have a valve coupling system that seals the container opening on drums and totes (IBC) to prevent dirt, debris, bugs, etc., from entering the container and contaminating the diesel exhaust fluid. Liquid in container system is sealed and secure, throughout container life cycle.

DEF Packages do not include coupler systems. Order Separately.

You must choose a coupler kit to create a complete system for your distribution needs.

For closed systems, use Reusable Poly Valve (RPV) or Reusable Stainless Valve (RSV) systems accessories. RSV and RPV components are interchangeable.

Closed Systems Drum Packages Electric Diaphragm Pump



Features

- Compact design mounting bracket.
- Heavy-duty cart - easily holds and rolls up to 55 gallon drum.
- Large semi-pneumatic tires - allow for easy maneuvering of cart.
- Large non-marking rear caster - built in break for safe and secure dispensing.

Includes:

- 8570-006, 6' x 3/4" Suction hose.
- 8561-012, 12' x 3/4" Discharge hose.
- 4530-054, Drip tray.
- 4320-007, Drum cart 55 gal for DEF.
- 4530-065, Side mount bracket.

Options:

- 3120-116, Meter DR style for DEF.
- 1200-020, 120 V AC Electric diaphragm pump.
- 1200-021, 12 V DC Electric diaphragm pump.
- 3340-012, Auto nozzle, stainless steel.
- 3340-015, Manual nozzle, polyethylene.

TECHNICAL DATA		
	DATA 120 V AC (1200-020)	DATA 12 V DC (1200-021)
Max. Free Flow	8.5 GPM	9.5 GPM
Working Pressure	23 psi (1.6 bar)	23 psi (1.6 bar)
Power	120 V AC	12 V DC
Wetted Materials (pump)	Stainless Steel, Viton, PPE	Stainless Steel, Viton, PPE
Service Bulletin	SB 1129	SB 1130

MODELS AVAILABLE	DESCRIPTION
1210-046P	120 V AC Non-metered, Manual Nozzle
1210-048P	120 V AC Non-metered, Auto Nozzle
1210-049P	120 V AC Metered, Auto Nozzle
1210-053P	12 V DC Metered, Auto Nozzle

CLOSED system containers have a valve coupling system that seals the container opening on drums and totes (IBC) to prevent dirt, debris, bugs, etc., from entering the container and contaminating the diesel exhaust fluid. Liquid in container system is sealed and secure, throughout container life cycle.

DEF Packages do not include coupler systems. Order Separately.

You must choose a coupler kit to create a complete system for your distribution needs.

For closed systems, use Reusable Poly Valve (RPV) or Reusable Stainless Valve (RSV) systems accessories. RSV and RPV components are interchangeable.

Closed Systems Tote Packages Electric Diaphragm Pump



Features

- Compact design mounting bracket

Includes

- 8570-006, 6' x 3/4" Suction hose.
- 8561-020, 20' x 3/4" Discharge hose.
- 4530-054, Drip tray.
- 4530-065, Side mount bracket.

Options

- 3120-116, Meter DR style for DEF.
- 1200-020, 120 V AC Electric diaphragm pump.
- 1200-021, 12 V DC Electric diaphragm pump.
- 3340-012, Auto nozzle, stainless steel.
- 3340-015, Manual nozzle, polyethylene.

MODELS AVAILABLE	DESCRIPTION
1210-046	120 V AC Non-metered, Manual Nozzle
1210-047	120 V AC Metered, Manual Nozzle
1210-048	120 V AC Non-metered, Auto Nozzle
1210-049	120 V AC Metered, Auto Nozzle
1210-050	12 V DC Non-metered, Manual Nozzle
1210-052	12 V DC Non-metered, Auto Nozzle
1210-053	12 V DC Metered, Auto Nozzle

TECHNICAL DATA

	DATA 120 V AC (1200-020)	DATA 12 V DC (1200-021)
Max. Free Flow	8.5 gal/min (32.18 l/min)	9.5 gal/min (34.07 l/min)
Working Pressure	23 psi (1.6 bar)	23 psi (1.6 bar)
Power	120 V AC	12 V DC
Wetted Materials (pump)	Stainless Steel, Viton, PPE	Stainless Steel, Viton, PPE
Service Bulletin	SB 1129	SB 1130

CLOSED system containers have a valve coupling system that seals the container opening on drums and totes (IBC) to prevent dirt, debris, bugs, etc., from entering the container and contaminating the diesel exhaust fluid. Liquid in container system is sealed and secure, throughout container life cycle.

DEF Packages do not include coupler systems. Order Separately.

You must choose a coupler kit to create a complete system for your distribution needs.

For closed systems, use Reusable Poly Valve (RPV) or Reusable Stainless Valve (RSV) systems accessories. RSV and RPV components are interchangeable.

Closed Systems Drum Packages CF Diaphragm Pump



Features

- Compact design mounting bracket.
- Heavy-duty cart - easily holds and rolls up to 55 gallon drum.
- Large semi-pneumatic tires - allows for easy maneuvering of cart.
- Large non-marking rear caster - built in break for safe and secure dispensing.

Includes

- 1120-025A, CF15 AODD Pump for DEF.
- 8570-006, 6' x 3/4" suction hose.
- 8561-012, 12' x 3/4" discharge hose.
- 4530-054, Drip tray.
- 4320-007, Drum cart 55 Gal for DEF.
- 4530-065, Side mount bracket.
- 3260-060, Filter Reg 1/4" auto drain, mini.

Options

- 3120-116, Meter DR style for DEF.
- 3340-012, Auto nozzle, stainless steel.

TECHNICAL DATA	
Air inlet	3/8" NPSM(F)
Fluid inlet port	1/2" BSPP(F) DEF
Fluid outlet port	1/2" BSPP(F) DEF
Max. Free Flow	14 gal/min (50 l/min)
Air pressure range	45-100 psi (3-7 bar)
Solids in suspension	1/8" (3 mm)
Wetted Materials	PTFE (Teflon) , Viton [®] , Polypropylene, Stainless Steel, Hytrel [®]
Recommended fluids	Diesel exhaust fluid
Recommended Applications	Fluid dispensing, transfer, evacuation and distribution systems
Service Bulletin	SB 1122

MODELS AVAILABLE	DESCRIPTION
1210-054P	CF15 Non-metered, Manual Nozzle
1210-055P	CF15 Metered, Manual Nozzle
1210-056P	CF15 Non-metered, Auto Nozzle
1210-057P	CF15 Metered, Auto Nozzle

CLOSED system containers have a valve coupling system that seals the container opening on drums and totes (IBC) to prevent dirt, debris, bugs, etc., from entering the container and contaminating the diesel exhaust fluid. Liquid in container system is sealed and secure, throughout container life cycle.

Note: Pump packages include all hoses and adapters required for connecting a DEF pump to the air supply and DEF dispense line.

DEF Packages do not include coupler systems.

You must choose a coupler kit to create a complete system for your distribution needs.

For closed systems, use Reusable Poly Valve (RPV) or Reusable Stainless Valve (RSV) systems accessories. RSV and RPV components are interchangeable.

Closed Systems Tote Packages CF Diaphragm Pump



Features

- Compact design mounting bracket
- Includes**
- 1120-025A, CF15 AODD Pump for DEF.
 - 8570-006, 6' x 3/4" Suction hose.
 - 8561-020, 20' x 3/4" Discharge hose.
 - 4530-054, Drip tray.
 - 4530-065, Side mount bracket.
 - 3260-060, Reg 1/4" auto drain, mini.
- Options**
- 3120-116, Meter DR style for DEF.
 - 3340-018, Manual nozzle, polyethylene- BSPP.

MODELS AVAILABLE	DESCRIPTION
1210-054P	CF15 Non-metered, Manual Nozzle
1210-055P	CF15 Metered, Manual Nozzle
1210-056P	CF15 Non-metered, Auto Nozzle
1210-057P	CF15 Metered, Auto Nozzle

TECHNICAL DATA

Air inlet	3/8" NPSM(F)
Fluid inlet port	1/2" BSPP(F) DEF
Fluid outlet port	1/2" BSPP(F) DEF
Max. Free Flow	14 gal/min (50 l/min)
Air pressure range	45-100 psi (3-7 bar)
Solids in suspension	1/8" (3 mm)
Wetted Materials	PTFE (Teflon) [®] , Viton [®] , Polypropylene, Stainless Steel, Hytrel [®]
Recommended fluids	Diesel exhaust fluid
Recommended Applications	Fluid dispensing, transfer, evacuation and distribution systems
Service Bulletin	SB 1122

CLOSED system containers have a valve coupling system that seals the container opening on drums and totes (IBC) to prevent dirt, debris, bugs, etc., from entering the container and contaminating the diesel exhaust fluid. Liquid in container system is sealed and secure, throughout container life cycle.

Note: Pump packages include all hoses and adapters required for connecting a DEF pump to the air supply and DEF dispense line.

DEF Packages do not include coupler systems.

You must choose a coupler kit to create a complete system for your fluid distribution needs.

For closed systems, use Reusable Poly Valve (RPV) or Reusable Stainless Valve (RSV) systems accessories. RSV and RPV components are interchangeable.

System Components Electric and AODD Pumps



MODELS AVAILABLE	DESCRIPTION
1200-020	120 V AC Diaphragm pump
1200-021	12 V DC Diaphragm pump



MODELS AVAILABLE	DESCRIPTION
1120-034	CF10 Diaphragm pump
1120-025A	CF15 Diaphragm pump
1120-031A	CF30 Diaphragm pump

TECHNICAL DATA 120 V AC 1200-020 120 V AC Diaphragm pump	
Fluid inlet port	3/4" BSPP(M)
Fluid outlet port	3/4" BSPP(M)
Flow Rate	8.5 gal/min (32.18 l/min)
Working Pressure	23 psi (1.6 bar)
Power	120 V AC
Wetted Materials	Stainless Steel, Viton®, PPE
Service Bulletin	SB 1129
TECHNICAL DATA 12 V DC 1200-021 12 V DC Diaphragm pump	
Fluid inlet port	3/4" BSPP(M)
Fluid outlet port	3/4" BSPP(M)
Flow Rate	9.5 gal/min (34.07 l/min)
Working Pressure	23 psi (1.6 bar)
Power	12 V DC
Wetted Materials	Stainless Steel, Viton®, PPE
Service Bulletin	SB 1130

TECHNICAL DATA CF10 - CF15 Diaphragm pump		
	1120-034 CF10	1120-025A CF15
Air inlet	3/8" NPSM (F)	1/2" BSPP(F)
Fluid inlet port	1/2" BSPP(F) DEF	1/2" BSPP(F) DEF
Fluid outlet port	1/2" BSPP(F) DEF	1/2" BSPP(F) DEF
Max. Free Flow	10 gal/min (38 l/min)	14 gal/min (50 l/min)
Air pressure range	22 to 102 psi (1.5 to 7 bar)	22 to 102 psi (1.5 to 7 bar)
Solids in suspension	1/8" (3 mm)	1/8" (3 mm)
Wetted Materials	PTFE (Teflon), Viton®, Polypropylene, Stainless Steel, Acetal, and Hytrel®	PTFE (Teflon), Viton®, Polypropylene, Stainless Steel, Hytrel®
Service Bulletin	SB 1121	SB 1122
TECHNICAL DATA CF30 Diaphragm pump		
	1120-031A CF30	
Air inlet	3/8" NPSM(F)	
Fluid inlet port	1" BSPP(F) DEF	
Fluid outlet port	1" BSPP(F) DEF	
Max. Free Flow	28 gal/min (100 l/min)	
Air pressure range	22 to 102 psi (1.5 to 7 bar)	
Solids in suspension	3/16" (4 mm)	
Wetted Materials	PTFE (Teflon), Viton®, Polypropylene, Stainless Steel, and Hytrel®	
Service Bulletin	SB 1124	

Hose Reels Signature Series Classic & EV (Extra Volume)

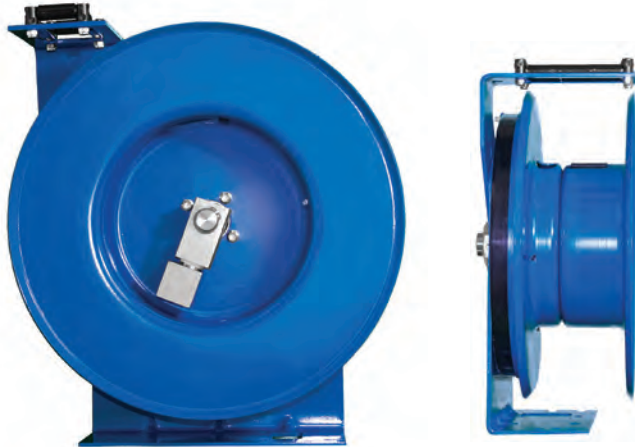

DEF

The Classic Hose Reel has been the standard of reliability for over a decade. Proven performance and reliable operations; all Classic series reels includes hose, hose stop and a 2.5' connecting hose.

The EV reel is for longer hose lengths and higher flow requirements. Includes hose, hose stop and a 2.5' connecting hose.

MODELS AVAILABLE	DESCRIPTION	REPLACEMENT HOSE
SIGNATURE SERIES CLASSIC		
DEF (Diesel Exhaust Fluid) Low pressure 150 psi (10 bar) for delivery of DEF		
2400-006	Bare reel - up to 30' x 3/4" ID hose BSPP(F)	-
2400-007	16' x 3/4" ID BSPP(F) includes 3' inlet hose	8569-016
2400-009	30' x 3/4" ID BSPP(F) includes 3' inlet hose	8569-030
SIGNATURE SERIES EV (EXTRA VOLUME)		
DEF (Diesel Exhaust Fluid) Low pressure 150 psi (10 bar) for delivery of DEF		
2400-010	Bare reel, up to 50' x 3/4" ID hose BSPP(F)	-
2400-011	50' x 3/4" ID BSPP(F) includes 3' inlet hose	8569-050

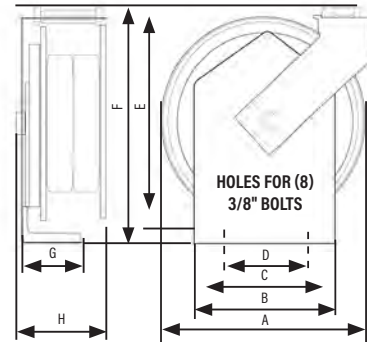

CLASSIC DIMENSIONS SERIES (INCHES)							
A	B	C	D	E	F	G	H
16"	11"	9 1/2"	4"	16"	20"	5"	6-8"

TECHNICAL DATA SIGNATURE SERIES CLASSIC	
Fluid inlet port	3/4" BSPP(F) - bare
Fluid outlet port	3/4" BSPP(F) - bare
Inlet/Outlet thread	3/4" BSPP(F) for 3/4" hoses
Wetted Materials	Stainless steel and Viton [®]
Service Bulletin	SB2023
TECHNICAL DATA SIGNATURE SERIES EV (EXTRA VOLUME)	
Fluid inlet port	3/4" BSPP(F) - cone seal bare
Fluid outlet port	3/4" BSPP(F) - bare
Inlet/Outlet thread	3/4" BSPP(F) for 3/4" hoses
Wetted Materials	Stainless steel, Polypropylene and Viton [®]
Service Bulletin	SB2028

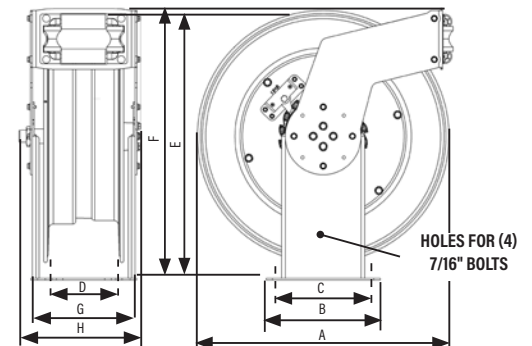

EV (EXTRA VOLUME) DIMENSIONS SERIES (INCHES)							
A	B	C	D	E	F	G	H
22"	8 5/8"	5"	5 1/8"	22"	23 1/2"	9"	9 1/4"

System Components Meters and Nozzles

METERS AND SOLENOIDS						
	MODEL	DESCRIPTION	INLET/OUTLET PORT	FLOW RATE	OPERATING PRESSURE	POWER
	3120-116	DR Style Meter for DEF	1/2" BSPP(F/F) & flange	0.25 - 13.2 gal/min (1 - 50 l/min)	435 psi (30 bar)	2 x 1.5 V alkaline batteries size "AAA"
	3120-119	DEF Turbine Meter	1" BSPP(M/M)	1.3-26.4 gal/min (4.92-99.94 l/min)	145 psi (10 bar)	2 x 1.5 V alkaline batteries size "AAA"
	3120-206	Turbine Meter, pulse-out	1" BSPP(F/F)	83 PPQ	145 psi (10 bar)	24 V AC
	3120-207	Solenoid	3/4" NPT(F/F)	8.4 gal/min (32.71 l/min)	150 psi (10 bar)	24 V AC
NOZZLES						
	MODEL	DESCRIPTION				
	3340-011	Nozzle, manual Polyethylene 3/4" barb (M)				
	3340-018	Nozzle, manual Polyethylene 3/4" BSPP(F)				
	3340-015	Nozzle, manual Polyethylene 1" barb (M)				
	3340-012	Nozzle, automatic shut-off Stainless steel, 3/4" BSPP(F)				
	3340-017	Nozzle, Magnetic, 3/4" BSPP(F)				
	4530-054	Nozzle holder, drip tray				

Coupler Components and Kits

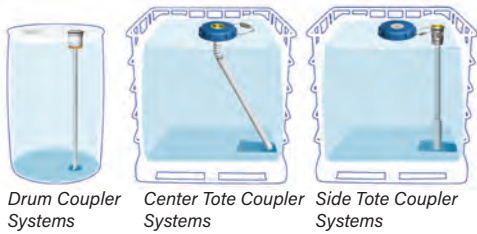

Drum Coupler Systems

Center Tote Coupler Systems



Side Tote Coupler Systems

NOTE: When ordering suction kits ensure you have selected the correct dip tube orientation for your system. DEF Packages do not include coupler systems. You must choose a coupler kit to create a complete system for your fluid distribution needs.

OPEN SYSTEMS COMPONENTS

For open systems, use Drum Quick Pro (DQP) accessories.

DRUM QUICK PRO (DQP)		
	4530-001	Coupler, polyethylene 3/4" barb
	3250-002	Replacement filter, air - used on 4530-001
	4530-002	Insert, polyethylene, 2" ABUT (American Buttress)
	4530-003	Key - DQP series
	4530-006	Dip tube, 55 gal drum mount length
	4530-005	Dip tube, 275 gal tote mount length
	4530-004	Dip tube, 330 gal tote mount length





SUCTION KITS		
	4530-007	Suction Kit, DQP series Includes: coupler, insert, key and 55 gal drum mount length dip tube
	4530-008	Suction Kit, DQP series Includes: coupler, insert, key and 275 gal tote mount length dip tube
	4530-009	Suction Kit, DQP series Includes: coupler, insert, key and 330 gal tote mount length dip tube



CLOSED SYSTEMS





For closed systems, use Reusable Poly Valve (RPV) or Reusable Stainless Valve (RSV) systems accessories. RSV and RPV components are interchangeable





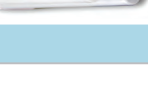



REUSABLE STAINLESS VALVE (RSV)

4 Prong, Green Seal - Preferred and Balcrank recommended

	4530-036	Coupler, Stainless Steel 3/4" barb. For use with 4530-037 only
	4530-048	Coupler, Fill head 1" NPT(M) For use with 4530-037 only
	4530-037	Insert, stainless steel, 2" ABUT (American Buttress)
	4530-038	Key, stainless steel, RSV/RPV

REUSABLE POLY VALVE (RPV)		
	4530-057	Coupler, RSV/RPV, Poly - 3/4" barb
	4530-063	Insert, polyethylene, 2" ABUT (American Buttress) (M)
	4530-058	Key - Poly, RSV/RPV

RSV/RPV DIP TUBES		
	4530-041	Dip tube, 55 gal drum mount length
	4530-044	Dip tube, 275 gal tote - center mount length
	4530-040	Dip tube, 275 gal tote - side mount length
	4530-043	Dip tube, 330 gal tote - center mount length
	4530-039	Dip tube, 330 gal tote - side mount length

SUCTION KITS		
	4530-042	Suction Kit, RSV series - includes: coupler 4530-036, insert and 55 gal drum mount length dip tube
	4530-045	Suction Kit, RSV series - includes: coupler 4530-036, insert 2-275 gal tote mount length dip tube
	4530-046	Suction Kit, RSV series - includes: coupler 4530-036, insert and 2-330 gal tote mount length dip tube
	4610-001	Suction Kit, RSV/RPV SS series - includes: coupler 4530-036, DEF Hose 6' x 3/4" ID, Fitting 1" BSPP(F) x 3/4" barb
	4530-059	Suction Kit, RPV Poly series - includes: coupler 4530-057, insert and 55 gal drum dip mount length tube
	4530-060	Suction Kit, RPV Poly series - includes: coupler 4530-057, insert and 2-275 gal tote mount length dip tube
	4530-061	Suction Kit, RPV Poly series - includes: coupler 4530-057, insert and 2-330 gal tote mount length dip tube
	4610-003	Suction Kit, RPV Poly series - includes: coupler 4530-057, DEF Hose 6' x 3/4" ID, Fitting 1" BSPP(F) x 3/4" barb

COUPLER KIT ACCESSORIES		
	4530-066	Center cap, tote 6" dia. x 2.5" ID ABUT (American Buttress)
	6210-001	Funnel with spout. 1 pt. 1/2" spout

System Components Stick Pumps, Hoses, and Hose Accessories



1200-015



1300-028



1200-016

MODELS AVAILABLE	DESCRIPTION
1200-015	Electric Stick pump drum style
1200-016	Electric Stick pump tote style

TECHNICAL DATA		
	MODEL 1200-015	MODEL 1200-016
Max delivery rate	10.5 gal/min (39.75 l/min)	22 gal/min (83.28 l/min)
Max delivery head	17' (5.18 m)	59' (18 m)
Wetted materials	316 SS, PTFE, Viton®, PP, PE, ETFE	
Operating voltage	110 V AC	120 V AC
Service Bulletin	SB 1108	SB 1109

MODELS AVAILABLE	DESCRIPTION
1300-028	Hand Pump, Manual lever

TECHNICAL DATA	
All polypropylene construction, includes a 2" bung adaptor	
Delivery Volume	1 pint per stroke (500 cc)
Temp Range	23 °F to 113 °F (-5 °C to 45 °C)
Wetted Materials	Polypropylene, EPDM
Service Bulletin	SB 1117

HOSE - SUCTION - BEFORE PUMP



- 8570-003, 3' x 3/4" ID Cut-end
- 8570-006, 6' x 3/4" ID Cut-end
- 8572-006, 6' x 1" ID Cut-end w/ hose clamps

HOSE - DISPENSE - AFTER PUMP

All hoses are specially formulated polyurethane unless otherwise stated



- 8551-006, 6' x 1" ID w/hose clamps and simple spout
- 8560-003, 3' x 3/4" ID w/hose clamps
- 8560-012, 12' x 3/4" ID w/hose clamps
- 8561-003, 3' x 3/4" ID Swivel 3/4" BSPP(M) cut end requires a hose clamp NOT included Order #832760
- 8561-006, 6' x 3/4" ID Swivel 3/4" BSPP(M) cut end requires a hose clamp NOT included Order #832760
- 8561-012, 12' x 3/4" ID Swivel 3/4" BSPP(M) cut end requires a hose clamp NOT included Order #832760
- 8561-016, 16' x 3/4" ID Swivel 3/4" BSPP(M) cut end requires a hose clamp NOT included Order #832760
- 8561-020, 20' x 3/4" ID Swivel 3/4" BSPP(M) cut end requires a hose clamp NOT included Order #832760
- 8561-030, 30' x 3/4" ID Swivel 3/4" BSPP(M) cut end requires a hose clamp NOT included Order #832760
- 8562-003, 3' x 3/4" ID Swivel 3/4" BSPP(M) - Straight 3/4" BSPP(M)
- 8569-016, 16' x 3/4" ID Swivel 3/4" BSPP(M/M)
- 8569-020, 20' x 3/4" ID Swivel 3/4" BSPP(M/M)
- 8569-030, 30' x 3/4" ID Swivel 3/4" BSPP(M/M)
- 8569-050, 50' x 3/4" ID Swivel 3/4" BSPP(M/M)

HOSE ACCESSORIES



- 2230-033 Hose bend restrictors - 12" black poly



- 2230-032 Stainless steel hose clamp 3/4"

System Accessories

ADAPTERS-ELBOW			ADAPTERS-ELBOW			
	3270-162	Poly Hose elbow, 1" BSPP(M) to 3/4" barb		3270-171	3/4" Stainless steel /Viton® bonded seal	
	3270-176	Poly Hose elbow, 1" NPT(M) to 3/4" barb		3270-169	1" Stainless steel /Viton® bonded seal	
	3270-175	Stainless steel elbow, 1" BSPP(M) X 3/4" BSPP(F) 90 DEG	FILTERS			
ADAPTERS - HOSE BARB				3250-001	Filter, in-line 10 micron - 3/4" NPT (filter included)	
	3270-163	Poly Hose barb, 1" BSPP(M) to 3/4" barb		3250-002	Replacement filter for 3250-001 in-line filter, 10 micron	
	3270-165	Poly Hose barb, 1" NPT(M) to 3/4" barb				
	3270-166	Poly Hose barb, 3/4" NPT(M) to 3/4" barb		BRACKETS		
		3270-177		Poly Hose barb, 1/2" NPT(M) to 3/4" barb		4530-064
3270-164		Stainless steel swivel 3/4" BSPP(M) to 3/4" barb		4411-016		Conventional AODD Wall Mount Bracket
ADAPTERS - COUPLERS (F/F)				DOLLY BASES AND DRUM CARTS		
	3270-173	Poly coupler, 1" NPT(F) to 1" BSPP(F)			4320-007	Drum Cart, 55-gal heavy duty
	3270-167	Stainless steel coupler, 1" BSPP(F) to 1" BSPP(F)	<ul style="list-style-type: none"> • Heavy-duty cart - easily holds and rolls up to 55 gallon drum • Large semi-pneumatic tires - Allows for easy maneuvering of cart • Large non-marking rear caster - built in break for safe and secure dispensing 			
	3270-168	Stainless steel coupler, reducer - 1" BSPP(F) to 3/4" BSPP(F)				4310-004
ADAPTERS - HEX NIPPLE				ADAPTERS - SWIVEL UNION		
	3270-172	Stainless steel Adapter, 3/4" NPT(M) to 3/4" BSPP(M)				
	3270-174	Stainless steel swivel, 1" BSPP(F) to 3/4" BSPP(M)				
	3270-161	Poly swivel, 1" BSPP(M) x 1" BSPP(F)				

Repair Kits for DEF Pumps

CF10		
PUMP MODELS	KIT NUMBER	DESCRIPTION
CF10 AODD PUMPS - 1120-034		
1120-034	833206	Air valve kit
1120-034	833207	Stroke sensor kit
1120-034	833208	Check Ball kit
1120-034	833209	Ball Seats, O-rings, ball guides
1120-034	833338	Diaphragms kit
1120-034	833332	Bushing, seal, push rod
CF15		
PUMP MODELS	KIT NUMBER	DESCRIPTION
CF15 AODD PUMPS - 1120-025A		
1120-025A	833206	Air valve kit
1120-025A	833207	Stroke sensor kit
1120-025A	833208	Check Ball kit
1120-025A	833209	Ball Seats, O-rings, ball guides
1120-025A	833210	Bushing, seal, push rod (Prior to 2/1/2013)
1120-025A	833332	Bushing, seal, push rod (After to 2/1/2013)
1120-025A	833211	Diaphragms kit (Prior to 2/1/2013)
1120-025A	833338	Diaphragms kit (After to 2/1/2013)
1120-025A	833341	Retrofit Kit (Updates pumps prior to 2/1/2013)
CF30		
PUMP MODELS	KIT NUMBER	DESCRIPTION
CF30 AODD PUMPS - 1120-031A		
1120-031A	833212	Air valve kit
1120-031A	833207	Stroke sensor kit
1120-031A	833233	Check Ball kit
1120-031A	833234	Ball Seats, O-rings, ball guides
1120-031A	833235	Bushing, seal, push rod (Prior to 2/1/2013)
1120-031A	833335	Bushing, seal, push rod (After to 2/1/2013)
1120-031A	833339	Diaphragms kit (After to 2/1/2013)
1120-031A	833342	Retrofit Kit (Updates pumps prior to 2/1/2013)
ELECTRIC DIAPHRAGM PUMPS		
PUMP MODELS	KIT NUMBER	DESCRIPTION
ALUMINUM AODD PUMPS - 1200-020 120V AC, 1200-021 120V DC		
1200-020, 1200-021	833415	Bypass valve kit
1200-020, 1200-021	833416	Pump head kit
1200-020, 1200-021	833417	Fan cover kit
1200-020	833418	Electric connection kit
1200-021	833419	Electric connection kit for 12V pump

