

display cube



bib|o
model  shelving & display
systems
by **escato**[®]

display cube



the display cube is a truly different way of featuring books, magazines, art objects or even children's toys. all four sides provide openings available in two different heights for each level. up to five levels are available in order to accommodate a wide variety of displays. finished tops are available in metal and high pressure laminate with pvc edges. available in fifteen standard colors. ideal to display magnetic pieces on surfaces as well.

biblmodel offers a collection of unique display pieces designed and engineered to be flexible, reconfigurable and mobile. these features allow for change in spaces that require multiple uses, or simple re-arrangement, to suit the aesthetics and function of the space.

please visit our website (www.biblmodel.com) to learn more about our full product line.

display cube

unit dimensions

width: 30"

height and weight: see chart

depth: 30"

shelf dimensions

width: 20"

height: 12" or 15"

depth: 10"

construction

levels: 1, 2, 3, 4 or 5



shelves: 4, 8, 12, 16, 20

steel gauge: 20

casters: 4" diameter

color options

201 arctic white	213 black coal semi-matte	355 plum
101 light grey	212 black glossy	359 clover
230 ivory	345 berry	421 chrome
203 tan	347 tangerine	206 gravel grey
235 cocoa	349 marigold	315 navy blue

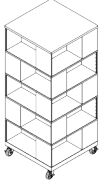
levels	shelves	unit height		unit weight		
		12"	15"	12"	15"	
1	4	20" 3.ST.201210.1	23" 3.ST.201510.1	62 lb	91 lb	
2	8	33" 3.ST.201210.2	39" 3.ST.201510.2	101 lb	137 lb	
3	12	46" 3.ST.201210.3	55" 3.ST.201510.3	150 lb	183 lb	
4	16	59" 3.ST.201210.4	71" 3.ST.201510.4	202 lb	229 lb	
5	20	72" 3.ST.201210.5	87" 3.ST.201510.5	228 lb	275 lb	



3.ST.201210.1

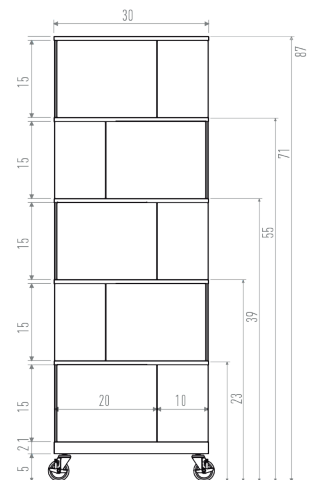
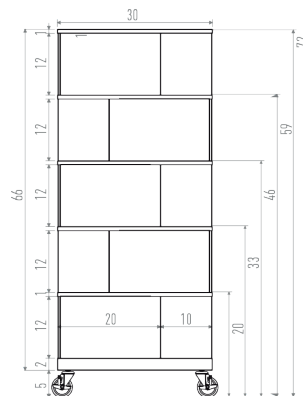
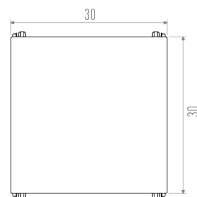

display cube with laminated top

unit dimensions

width: 30"

height and weight: see chart

depth: 30"

shelf dimensions

width: 20"

height: 12" or 13"

depth: 10"

construction

levels: 1, 2, 3, 4 or 5



shelves: 4, 8, 12, 16, 20

steel gauge: 20

casters: 4" diameter

color options

201 arctic white	213 black coal semi-matte	355 plum
101 light grey	212 black glossy	359 clover
230 ivory	345 berry	421 chrome
203 tan	347 tangerine	206 gravel grey
235 cocoa	349 marigold	315 navy blue

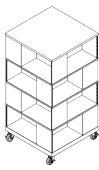
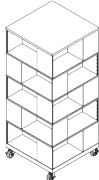
levels	shelves	unit height		unit weight		
		12"	15"	12"	15"	
1	4	21" 3.LT.201210.1		83 lb		
2	8	122.5" 3.LT.201210.2		123 lb		
3	12	47" 3.LT.201210.3		162 lb		
4	16	60" 3.LT.201210.4		201 lb		
5	20	73" 3.LT.201210.5		240 lb		

lamine top color options



3.LT.201210.1

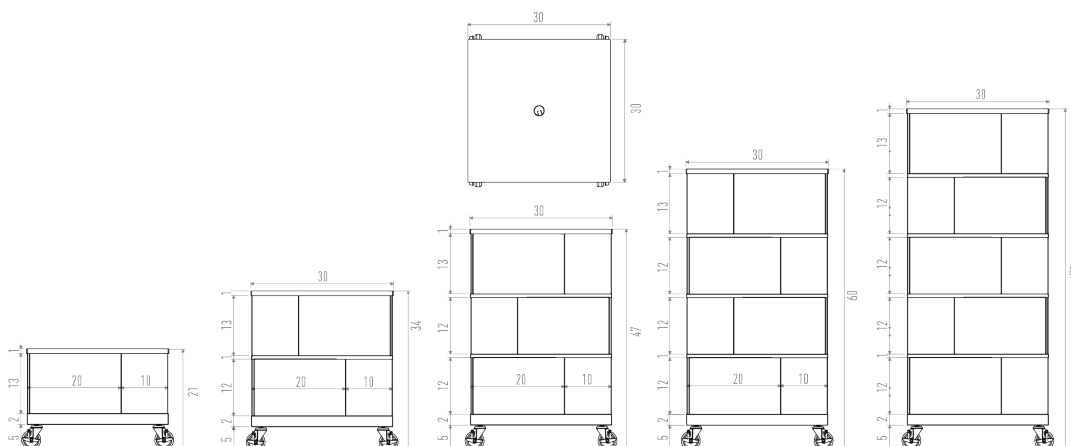

display cube with 4-divider top

unit dimensions

width: 30"

height and weight: see chart

depth: 30"

shelf dimensions

width: 20"

height: 12" or 15"

depth: 10"

construction

levels: 1 or 2



shelves: 4 or 8

compartments:

4 (14.7" x 14.7" x 9)

steel gauge: 20

casters: 4" diameter

levels	shelves	unit height		unit weight		
		12"	15"	12"	15"	
1	4	20" 3.ST.201210.1	23" 3.ST.201510.1	62 lb	91 lb	
2	8	33"	39" 3.ST.201510.2	101 lb	137 lb	

color options

201 arctic white	213 black coal semi-matte	355 plum
101 light grey	212 black glossy	359 clover
230 ivory	345 berry	421 chrome
203 tan	347 tangerine	206 gravel grey
235 cocoa	349 marigold	315 navy blue

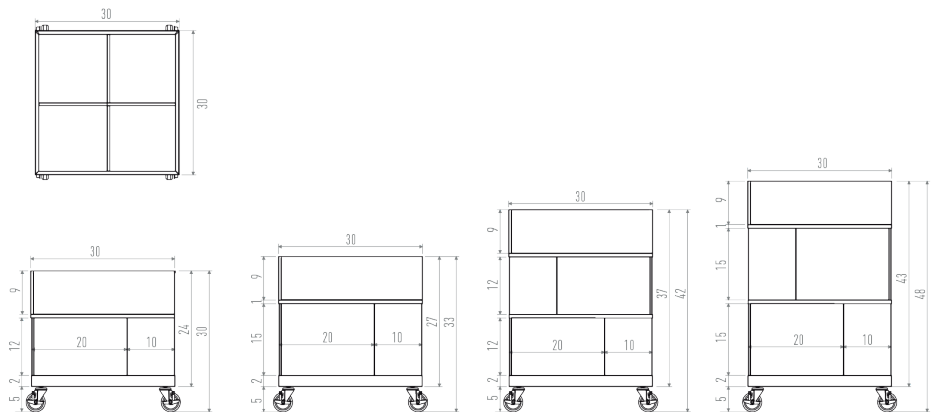

3.4D.201210.2

12"



15"



12"



3.LT.201210.1

3.LT.201210.2

3.LT.201210.3

3.LT.201210.4

3.LT.201210.5

12"



3.4D.201210.1

3.4D.201210.2

15"



3.4D.201510.1

3.4D.201510.2

display cube product codes

	1 level	2 levels	3 levels	4 levels	5 levels
	12"				
20"w steel top	3.ST.201210.1	3.ST.201210.2	3.ST.201210.3	3.ST.201210.4	3.ST.201210.5
30"w steel top	3.ST.301210.1	3.ST.301210.2	3.ST.301210.3	3.ST.301210.4	3.ST.301210.5
20"w steel top w/4 divisions	3.4D.201210.1	3.4D.201210.2			
30"w steel top w/4 divisions	3.4D.301210.1	3.4D.301210.2			
20"w laminated top	3.LT.201210.1	3.LT.201210.2	3.LT.201210.3	3.LT.201210.4	3.LT.201210.5
30"w laminated top	3.LT.301210.1	3.LT.301210.2	3.LT.301210.3	3.LT.301210.4	3.LT.301210.5

	15"				
20"w steel top	3.ST.201510.1	3.ST.201510.2	3.ST.2012510.3	3.ST.201510.4	3.ST.201510.5
30"w steel top	3.ST.301510.1	3.ST.301510.2	3.ST.3012510.3	3.ST.301510.4	3.ST.301510.5
20"w steel top w/4 divisions	3.4D.201510.1	3.4D.201510.2			
30"w steel top w/4 divisions	3.4D.301510.1	3.4D.301510.2			
20"w laminated top	3.LT.201510.1	3.LT.201510.2	3.LT.201510.3	3.LT.201510.4	3.LT.201510.5
30"w laminated top	3.LT.301510.1	3.LT.301510.2	3.LT.301510.3	3.LT.301510.4	3.LT.301510.5