



Policies & Services	3
Introduction to Estey	4
2.5" Weld Frame	
About the 2.5" Weld Frame System	5
Shelving Units	6-12
Frames & Frame Accessories	13
Base Shelves	14-15
Shelves, Brackets, Dividers, Shims	16
Periodical, Sloped, Storage and Integral Back Shelves	18
Storage, Reference and Specialty Shelves	19
Cabinets, Trays & Accessories	20
Newspaper Rack, Wall Hung Columns & Accessories	21
Book Supports, Fillers, End Brackets	22
Backstops, Base Filler Closures	23
Canopy Tops & Accessories	24
Gussets & Fillers	25
End Panels and Backs	26
Designer Series	
Display Units & Divider Units	27-31
Uprights & Accessories	32
Shelves, Dividers, Brackets, Struts	33
Cabinets, Trays, Newspaper Rack & Accessories	34
Specialty Shelves	35-36
Book Supports, Fillers, Backstops	37
Wall Hung Columns, Miscellaneous Accessories	38
Canopy Tops, Brackets, Signage, Gussets	39
End Panels & Backs	40
2" Weld Frame	
About the 2" Weld Frame System	41
Shelving Units	42-48
Frames & Frame Accessories	49
Base Shelves	50-51
Shelves, Brackets, Dividers, Shims	52
Periodical, Sloped, Storage and Integral Back Shelves	54
Storage, Reference and Specialty Shelves	55
Cabinets, Trays & Accessories	56
Newspaper Rack, Wall Hung Columns & Accessories	57
Book Supports, Fillers, End Brackets	58
Backstops, Base Filler Closures	59
Canopy Tops & Accessories	60
Gussets & Fillers	61
End Panels and Backs	62
A-Frame	
Shelving Units	63
Accessories	64

POLICY AND SERVICES

PRICING: All prices are F.O.B. Tennsco Corp's Facility in Dickson, Tennessee. All orders are subject to final acceptance at the Home Office, Dickson, Tennessee. Prices subject to change without notice. Tennsco has the right to make product design changes at any time. Tennsco's prices do not include sales, use, excise or similar taxes. Consequently, in addition to the prices specified herein, the amount of any present or future sales, use, excise or similar tax applicable to the manufacture, sale, purchase or use of the goods sold hereunder shall be paid by Buyer. In lieu thereof, Buyer shall provide Seller with a tax exemption certificate acceptable to the applicable taxing authorities.

TERMS OF PAYMENT: Terms are Net 30 Days from date of shipment. A service charge of 1 1/2% per month will be charged for overdue invoices.

MINIMUM ORDERS: Minimum order is \$15.00.

SPECIFICATIONS: Tennsco reserves the right to change any product specifications contained in this price list.

FREIGHT CHARGES: All shipments will be made freight collect unless otherwise specified. If freight is prepared, it will be added to the invoice or billed separately, depending on arrangements. On shipments by parcel post, the postage will be added to the invoice. All routing will be done solely by the Home Office. If purchaser does not accept delivery of merchandise when ready for shipment, storage fees will be charged to the purchaser.

WEIGHT: Weights shown are approximate.

FREIGHT CLAIMS: Claims for shortages must be made in writing to the Home Office within 5 business days from receipt of shipment. Claims for damaged or lost material must be filed with the carrier.

CAUTION: When you give delivering carrier a clear receipt for a shipment in which there is damaged merchandise or a shortage, the carrier is relieved of further responsibility. Claims for damage or shortage must be filed by you with the delivering carrier. Tennsco will not accept return of merchandise damaged in transit. Your claim is with the delivering carrier.

PARTIAL SHIPMENTS: Tennsco reserves the right to make delivery in installments unless otherwise expressly stated herein. All such installments shall be separately invoiced and paid for when due, without regard to subsequent deliveries. Delay in delivery of all installments shall not relieve Buyer of its obligations to accept remaining deliveries.

SHIPPING TIME: Shipping dates are estimates only, based on standard manufacturing times. Tennsco makes every effort to meet shipping date requests, but will not be held liable for missed shipping dates. Once items are shipped, Tennsco is not responsible for delays caused by the delivering carrier. This includes, but is not limited to, delays in installation proceedings due to slow delivery by carrier.

CANCELLATIONS & RETURNS: Orders for "Special" items are not subject to change or cancellation. Special colors and textured colors cannot be returned. All returns are subject to approval. No return merchandise will be accepted without written consent of the General Office, Dickson, Tennessee. All returned shipments are subject to a handling charge of 25% plus all transportation charges incurred by Tennsco unless Tennsco is at fault. Once production of "Special" items has begun, cancellation of order is subject to Tennsco approval. A 15% surcharge will be assessed to approved cancelled items.

CODE RESTRICTIONS: Local building codes vary. It is the purchaser's responsibility to determine that product installation is in accordance with local requirements.

LIMITED WARRANTY

Tennsco warrants goods purchased hereunder to be free of defects in materials and workmanship for a period of one (1) year from the date of shipment, hereunder. Tennsco's warranty shall not apply in the event goods are damaged as a result of misuse, abuse, neglect, accident, improper application, modification or repair by persons not authorized by Seller, where goods are damaged during shipment. UNLESS CONSIDERED UNENFORCEABLE OR UNLAWFUL UNDER APPLICABLE LAW:

- a. ALL IMPLIED WARRANTIES, INCLUDING BUT NOT LIMITED TO WARRANTIES OR MERCHANTABILITY AND FITNESS FOR A PARTICULAR PURPOSE ARE HEREBY EXCLUDED.
- b. BUYERS REMEDY, IF ANY, FOR ANY DEFECTIVE GOODS SHALL BE LIMITED TO A REFUND BY SELLER OR REPLACEMENT OF THE GOODS AT SELLER'S OPTION AND SHALL IN NO EVENT INCLUDE DAMAGES OF ANY KIND, WHETHER INCIDENTAL, CONSEQUENTIAL OR OTHERWISE.

NO GOODS ACCEPTED FOR RETURN WITHOUT PRIOR APPROVAL. Seller shall have the right to inspect any goods claimed to be defective at Buyer's place of business or require Buyer to return the goods to Seller for inspection on Seller's premises. Transportation charges covering returned goods will be borne by Seller only if such goods are proven to be defective, are covered by this warranty and are returned within the warranty period stated above.



Cantilever Library Shelving

Estey Cantilever Library Shelving is designed to be functional, versatile and aesthetically beautiful. Cantilever Library Shelving offers a 2" Weld Frame option and a 2.5" Weld Frame option.

Designer Series Shelving

European styling was the inspiration behind the Estey Designer Series Library Shelving.



A-Frame Display Shelving

A-Frame Display Shelving offers a clean, modern style, perfect for any library environment.

NOTE: MOST PRODUCTS AVAILABLE IN 24"W AT AN UPCHARGE OF 25%.

THE 2.5" WELD FRAME SYSTEM

Estey Weld Frame construction eliminates the need for sway bracing and separate starter/adder units.

All Units Feature:

- Upright slot spacing 1" on centers in a 6" repeat pattern for easy shelf alignment.
- Upright posts have 8 right angle bends for added strength.
- Six-point leveling system per double-face section; four-point leveling system per single face section (adjustable levelers provided on both base units).
- Base shelves available in one-piece pan, or in multiple-piece construction with kickplate(see below).
- Electrostatically applied/baked-on epoxy/polyester powder coated finish.

Basic Shelving Components:

- Welded frames
- Base brackets
- Base shelf
- Adjustable shelves and brackets
- Kickplate(s) (black powder coat finish)

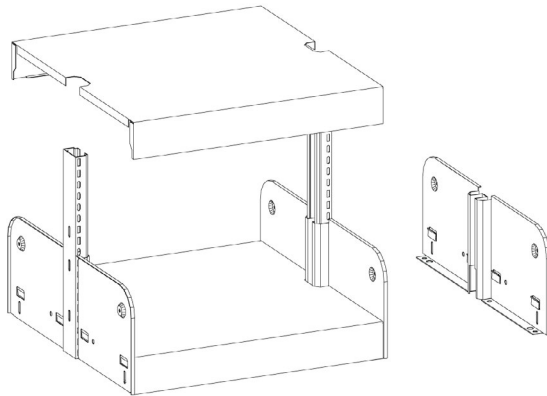

FIXED BASE SHELF

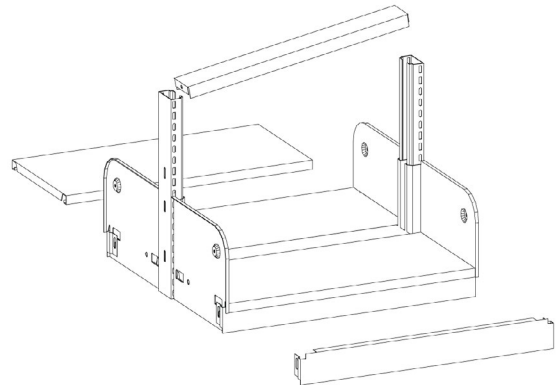

**ADJUSTABLE (KICKPLATE)
BASE SHELF**

NOTE: All shelf depths in this catalog are expressed in nominal sizes. Base shelf dimensions will actually be greater than those shown; all other shelf sizes will be 1" less. Contact factory for specific dimensions.

NOTE: MOST PRODUCTS AVAILABLE IN 24"W AT AN UPCHARGE OF 25%.

SINGLE FACE*

*All single face shelving must be wall anchored.



WF41080



WF61080

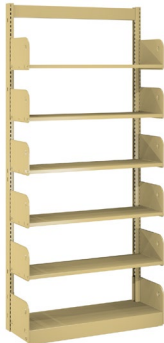

WF71080



WF81080



WF91080

FIXED BASE			ADJUSTABLE BASE			SHELF DEPTH	BASE DEPTH
CAT. NO.	WT.	PRICE	CAT. NO.	WT.	PRICE		
42" HIGH, 3 LEVELS							
WF41080	41	284.00	WA41080	41	282.00	8"	8"
WF41082	44	289.00	WA41082	44	284.00	8"	10"
WF41090	44	296.00	WA41090	44	295.00	9"	9"
WF41091	46	297.00	WA41091	45	292.00	9"	10"
WF41100	47	302.00	WA41100	47	297.00	10"	10"
WF41102	49	306.00	WA41102	48	300.00	10"	12"
WF41120	52	315.00	WA41120	51	310.00	12"	12"
66" HIGH, 5 LEVELS							
WF61080	59	370.00	WA61080	60	369.00	8"	8"
WF61082	63	376.00	WA61082	62	370.00	8"	10"
WF61090	63	393.00	WA61090	64	392.00	9"	9"
WF61091	66	394.00	WA61091	65	389.00	9"	10"
WF61100	69	401.00	WA61100	68	396.00	10"	10"
WF61102	70	405.00	WA61102	69	398.00	10"	12"
WF61120	76	425.00	WA61120	75	420.00	12"	12"
78" HIGH, 6 LEVELS							
WF71080	70	417.00	WA71080	70	415.00	8"	8"
WF71082	73	423.00	WA71082	72	415.00	8"	10"
WF71090	75	444.00	WA71090	76	443.00	9"	9"
WF71091	77	448.00	WA71091	76	440.00	9"	10"
WF71100	81	455.00	WA71100	80	447.00	10"	10"
WF71102	82	459.00	WA71102	81	452.00	10"	12"
WF71120	90	483.00	WA71120	89	478.00	12"	12"
84" HIGH, 7 LEVELS							
WF81080	77	454.00	WA81080	77	452.00	8"	8"
WF81082	80	460.00	WA81082	79	452.00	8"	10"
WF81090	82	485.00	WA81090	83	484.00	9"	9"
WF81091	85	486.00	WA81091	84	485.00	9"	10"
WF81100	89	498.00	WA81100	88	491.00	10"	10"
WF81102	90	502.00	WA81102	90	495.00	10"	12"
WF81120	100	531.00	WA81120	99	526.00	12"	12"
90" HIGH, 7 LEVELS							
WF91080	78	458.00	WA91080	78	458.00	8"	8"
WF91082	81	467.00	WA91082	80	458.00	8"	10"
WF91090	83	492.00	WA91090	84	491.00	9"	9"
WF91091	86	493.00	WA91091	85	487.00	9"	10"
WF91100	90	505.00	WA91100	89	497.00	10"	10"
WF91102	91	509.00	WA91102	91	502.00	10"	12"
WF91120	101	538.00	WA91120	100	531.00	12"	12"

30" wide units are available at the price listed. 24" wide units are available at a 25% upcharge. Contact factory for weights. For 24" units, add "2" to end of catalog number (e.g. WF810802); for 30" units, add "3" (e.g. WF810803).

2.5" Weld Frame

NOTE: MOST PRODUCTS AVAILABLE IN 24"W AT AN UPCHARGE OF 25%.

DOUBLE FACE

FIXED BASE			ADJUSTABLE BASE			SHELF DEPTH	BASE DEPTH
CAT. NO.	WT.	PRICE	CAT. NO.	WT.	PRICE		
42" HIGH, 3 LEVELS							
WF42080	60	372.00	WA42080	64	384.00	8"	16"
WF42082	65	391.00	WA42082	67	398.00	8"	20"
WF42090	65	397.00	WA42090	68	413.00	9"	18"
WF42091	68	410.00	WA42091	71	417.00	9"	20"
WF42100	71	417.00	WA42100	74	423.00	10"	20"
WF42102	74	429.00	WA42102	76	434.00	10"	24"
WF42120	80	448.00	WA42120	83	454.00	12"	24"
66" HIGH, 5 LEVELS							
WF62080	92	524.00	WA62080	95	537.00	8"	16"
WF62082	97	545.00	WA62082	99	551.00	8"	20"
WF62090	100	573.00	WA62090	103	585.00	9"	18"
WF62091	103	582.00	WA62091	105	592.00	9"	20"
WF62100	109	596.00	WA62100	111	602.00	10"	20"
WF62102	112	608.00	WA62102	114	613.00	10"	24"
WF62120	124	647.00	WA62120	126	654.00	12"	24"
78" HIGH, 6 LEVELS							
WF72080	109	604.00	WA72080	113	616.00	8"	16"
WF72082	114	626.00	WA72082	117	630.00	8"	20"
WF72090	119	658.00	WA72090	122	674.00	9"	18"
WF72091	122	670.00	WA72091	124	678.00	9"	20"
WF72100	129	690.00	WA72100	132	694.00	10"	20"
WF72102	132	702.00	WA72102	134	709.00	10"	24"
WF72120	148	750.00	WA72120	150	754.00	12"	24"
84" HIGH, 7 LEVELS							
WF82080	123	674.00	WA82080	126	686.00	8"	16"
WF82082	128	696.00	WA82082	130	700.00	8"	20"
WF82090	134	738.00	WA82090	137	753.00	9"	18"
WF82091	137	756.00	WA82091	139	757.00	9"	20"
WF82100	146	772.00	WA82100	148	776.00	10"	20"
WF82102	149	784.00	WA82102	151	787.00	10"	24"
WF82120	167	842.00	WA82120	169	846.00	12"	24"
90" HIGH, 7 LEVELS							
WF92080	124	680.00	WA92080	127	693.00	8"	16"
WF92082	129	703.00	WA92082	131	707.00	8"	20"
WF92090	135	745.00	WA92090	138	759.00	9"	18"
WF92091	138	757.00	WA92091	140	764.00	9"	20"
WF92100	147	779.00	WA92100	149	783.00	10"	20"
WF92102	150	791.00	WA92102	152	794.00	10"	24"
WF92120	168	849.00	WA92120	170	852.00	12"	24"

30" wide units are available at the price listed. 24" wide units are available at a 25% upcharge. Contact factory for weights.
For 24" units, add "2" to end of catalog number (e.g. WF820802); for 30" units, add "3" (e.g. WF820803).



WF42080



WF62080



WF72080



WF82080



WF92080

2.5" Weld Frame

NOTE: MOST PRODUCTS AVAILABLE IN 24"W AT AN UPCHARGE OF 25%.

SINGLE FACE*

*All single face shelving must be wall anchored.



WBDF41080



WBDF61080

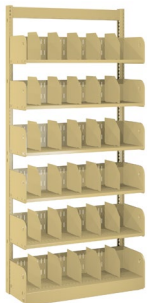

WBDF71080



WBDF81080



WBDF91080

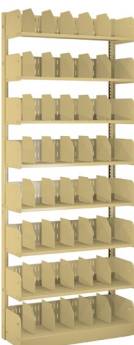

WBDF01080

FIXED BASE			ADJUSTABLE BASE			SHELF DEPTH	BASE DEPTH
CAT. NO.	WT.	PRICE	CAT. NO.	WT.	PRICE		
42" HIGH, 3 LEVELS							
WBDF41100	62	385.00	WBDA41100	63	393.00	10"	10"
WBDF41102	63	392.00	WBDA41102	64	398.00	10"	12"
WBDF41103	64	398.00	WBDA41103	65	407.00	10"	13"
WBDF41120	66	404.00	WBDA41120	67	410.00	12"	12"
WBDF41130	69	420.00	WBDA41130	70	427.00	13"	13"
WBDF41133	73	445.00	WBDA41133	73	493.00	13"	16"
66" HIGH, 5 LEVELS							
WBDF61100	95	555.00	WBDA61100	96	563.00	10"	10"
WBDF61102	96	563.00	WBDA61102	97	568.00	10"	12"
WBDF61103	97	568.00	WBDA61103	98	577.00	10"	13"
WBDF61120	102	586.00	WBDA61120	103	593.00	12"	12"
WBDF61130	106	611.00	WBDA61130	107	618.00	13"	13"
WBDF61133	111	636.00	WBDA61133	111	646.00	13"	16"
78" HIGH, 6 LEVELS							
WBDF71100	113	644.00	WBDA71100	114	650.00	10"	10"
WBDF71102	114	650.00	WBDA71102	115	656.00	10"	12"
WBDF71103	115	657.00	WBDA71103	116	665.00	10"	13"
WBDF71120	122	680.00	WBDA71120	123	686.00	12"	12"
WBDF71130	127	709.00	WBDA71130	128	717.00	13"	13"
WBDF71133	131	735.00	WBDA71133	131	745.00	13"	16"
84" HIGH, 7 LEVELS							
WBDF81100	127	722.00	WBDA81100	128	729.00	10"	10"
WBDF81102	129	728.00	WBDA81102	129	735.00	10"	12"
WBDF81103	130	735.00	WBDA81103	130	744.00	10"	13"
WBDF81120	138	765.00	WBDA81120	139	770.00	12"	12"
WBDF81130	143	798.00	WBDA81130	144	806.00	13"	13"
WBDF81133	148	824.00	WBDA81133	148	834.00	13"	16"
90" HIGH, 7 LEVELS							
WBDF91100	128	728.00	WBDA91100	129	736.00	10"	10"
WBDF91102	130	735.00	WBDA91102	130	741.00	10"	12"
WBDF91103	131	741.00	WBDA91103	131	750.00	10"	13"
WBDF91120	139	771.00	WBDA91120	140	777.00	12"	12"
WBDF91130	144	805.00	WBDA91130	145	813.00	13"	13"
WBDF91133	149	830.00	WBDA91133	149	840.00	13"	16"
93" HIGH, 8 LEVELS							
WBDF01100	144	876.00	WBDA01100	144	884.00	10"	10"
WBDF01102	145	882.00	WBDA01102	146	889.00	10"	12"
WBDF01103	146	889.00	WBDA01103	146	898.00	10"	13"
WBDF01120	156	925.00	WBDA01120	156	930.00	12"	12"
WBDF01130	162	962.00	WBDA01130	163	970.00	13"	13"
WBDF01133	166	988.00	WBDA01133	166	998.00	13"	16"

30" wide units are available at the price listed. 24" wide units are available at a 25% upcharge. Contact factory for weights. For 24" units, add "2" to end of catalog number (e.g. WBDF811002); for 30" units, add "3" (e.g. WBDF811003).

All units come with 5 dividers per shelf. Dividers are adjustable on 1" centers.

NOTE: MOST PRODUCTS AVAILABLE IN 24"W AT AN UPCHARGE OF 25%.

DOUBLE FACE

FIXED BASE			ADJUSTABLE BASE			SHELF DEPTH	BASE DEPTH
CAT. NO.	WT.	PRICE	CAT. NO.	WT.	PRICE		
42" HIGH, 3 LEVELS							
WBDF42100	106	611.00	WBDA42100	107	627.00	10"	20"
WBDF42102	109	625.00	WBDA42102	110	640.00	10"	24"
WBDF42103	111	642.00	WBDA42103	112	654.00	10"	26"
WBDF42120	115	648.00	WBDA42120	116	665.00	12"	24"
WBDF42130	120	683.00	WBDA42130	121	695.00	13"	26"
WBDF42133	128	730.00	WBDA42133	129	747.00	13"	32"
66" HIGH, 5 LEVELS							
WBDF62100	167	930.00	WBDA62100	169	947.00	10"	20"
WBDF62102	170	946.00	WBDA62102	171	960.00	10"	24"
WBDF62103	172	961.00	WBDA62103	173	973.00	10"	26"
WBDF62120	183	993.00	WBDA62120	184	1,010.00	12"	24"
WBDF62130	191	1,038.00	WBDA62130	192	1,057.00	13"	26"
WBDF62133	199	1,097.00	WBDA62133	206	1,143.00	13"	32"
78" HIGH, 6 LEVELS							
WBDF72100	199	1,093.00	WBDA72100	201	1,110.00	10"	20"
WBDF72102	203	1,109.00	WBDA72102	204	1,123.00	10"	24"
WBDF72103	204	1,124.00	WBDA72103	206	1,137.00	10"	26"
WBDF72120	218	1,169.00	WBDA72120	219	1,183.00	12"	24"
WBDF72130	227	1,229.00	WBDA72130	229	1,241.00	13"	26"
WBDF72133	236	1,277.00	WBDA72133	237	1,293.00	13"	32"
84" HIGH, 7 LEVELS							
WBDF82100	228	1,247.00	WBDA82100	229	1,264.00	10"	20"
WBDF82102	231	1,262.00	WBDA82102	232	1,278.00	10"	24"
WBDF82103	233	1,278.00	WBDA82103	234	1,291.00	10"	26"
WBDF82120	249	1,334.00	WBDA82120	249	1,340.00	12"	24"
WBDF82130	260	1,403.00	WBDA82130	262	1,415.00	13"	26"
WBDF82133	268	1,451.00	WBDA82133	270	1,467.00	13"	32"
90" HIGH, 7 LEVELS							
WBDF92100	229	1,253.00	WBDA92100	230	1,271.00	10"	20"
WBDF92102	232	1,269.00	WBDA92102	233	1,284.00	10"	24"
WBDF92103	234	1,284.00	WBDA92103	235	1,298.00	10"	26"
WBDF92120	250	1,341.00	WBDA92120	251	1,355.00	12"	24"
WBDF92130	261	1,410.00	WBDA92130	263	1,422.00	13"	26"
WBDF92133	269	1,457.00	WBDA92133	271	1,474.00	13"	32"
93" HIGH, 8 LEVELS							
WBDF02100	258	1,476.00	WBDA02100	259	1,493.00	10"	20"
WBDF02102	261	1,492.00	WBDA02102	262	1,506.00	10"	24"
WBDF02103	263	1,507.00	WBDA02103	264	1,520.00	10"	26"
WBDF02120	283	1,575.00	WBDA02120	284	1,590.00	12"	24"
WBDF02130	293	1,637.00	WBDA02130	296	1,665.00	13"	26"
WBDF02133	303	1,701.00	WBDA02133	304	1,717.00	13"	32"

30" wide units are available at the price listed. 24" wide units are available at a 25% upcharge. Contact factory for weights. For 24" units, add "2" to end of catalog number (e.g. WBDF821002); for 30" units, add "3" (e.g. WBDF821003).

All units come with 5 dividers per shelf. Dividers are adjustable on 1" centers.



WBDF42100



WBDF62100

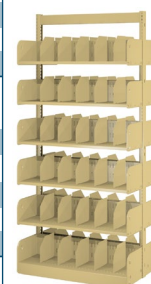

WBDF72100



WBDF82100

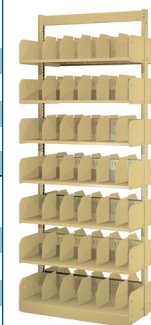

WBDF92100



WBDF102100

2.5" Weld Frame

NOTE: MOST PRODUCTS AVAILABLE IN 24"W AT AN UPCHARGE OF 25%.

SINGLE FACE*

*All single face shelving must be wall anchored.

2.5" Weld Frame



WFIB41080

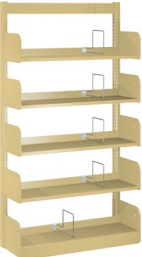

WFIB61080

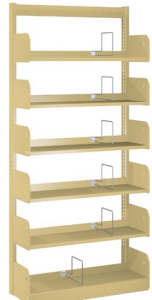

WFIB71080

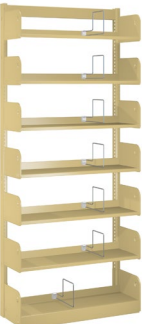

WFIB81080

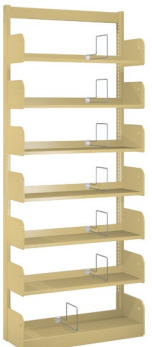

WFIB91080

FIXED BASE			ADJUSTABLE BASE			SHELF DEPTH	BASE DEPTH
CAT. NO.	WT.	PRICE	CAT. NO.	WT.	PRICE		
42" HIGH, 3 LEVELS							
WFIB41080	42	330.00	WAIB41080	42	326.00	8"	8"
WFIB41082	44	326.00	WAIB41082	44	326.00	8"	10"
WFIB41090	44	332.00	WAIB41090	45	335.00	9"	9"
WFIB41091	45	333.00	WAIB41091	46	333.00	9"	10"
WFIB41100	47	338.00	WAIB41100	47	338.00	10"	10"
WFIB41102	48	346.00	WAIB41102	49	346.00	10"	12"
WFIB41120	52	364.00	WAIB41120	53	365.00	12"	12"
66" HIGH, 5 LEVELS							
WFIB61080	62	452.00	WAIB61080	62	448.00	8"	8"
WFIB61082	64	450.00	WAIB61082	64	448.00	8"	10"
WFIB61090	65	461.00	WAIB61090	66	464.00	9"	9"
WFIB61091	67	462.00	WAIB61091	67	461.00	9"	10"
WFIB61100	70	471.00	WAIB61100	70	472.00	10"	10"
WFIB61102	71	479.00	WAIB61102	72	479.00	10"	12"
WFIB61120	78	516.00	WAIB61120	79	516.00	12"	12"
78" HIGH, 6 LEVELS							
WFIB71080	73	516.00	WAIB71080	73	513.00	8"	8"
WFIB71082	75	515.00	WAIB71082	76	513.00	8"	10"
WFIB71090	78	528.00	WAIB71090	79	532.00	9"	9"
WFIB71091	79	529.00	WAIB71091	79	529.00	9"	10"
WFIB71100	83	542.00	WAIB71100	83	516.00	10"	10"
WFIB71102	84	549.00	WAIB71102	85	551.00	10"	12"
WFIB71120	93	595.00	WAIB71120	94	596.00	12"	12"
84" HIGH, 7 LEVELS							
WFIB81080	81	571.00	WAIB81080	81	566.00	8"	8"
WFIB81082	83	567.00	WAIB81082	83	566.00	8"	10"
WFIB81090	86	586.00	WAIB81090	87	588.00	9"	9"
WFIB81091	87	594.00	WAIB81091	88	586.00	9"	10"
WFIB81100	92	602.00	WAIB81100	92	601.00	10"	10"
WFIB81102	93	609.00	WAIB81102	94	610.00	10"	12"
WFIB81120	104	664.00	WAIB81120	104	665.00	12"	12"
90" HIGH, 7 LEVELS							
WFIB91080	82	577.00	WAIB91080	82	574.00	8"	8"
WFIB91082	84	576.00	WAIB91082	84	573.00	8"	10"
WFIB91090	87	593.00	WAIB91090	88	595.00	9"	9"
WFIB91091	88	594.00	WAIB91091	89	593.00	9"	10"
WFIB91100	93	609.00	WAIB91100	93	609.00	10"	10"
WFIB91102	94	616.00	WAIB91102	95	617.00	10"	12"
WFIB91120	105	668.00	WAIB91120	105	672.00	12"	12"

Units come with one wire divider per shelf level.

30" wide units are available at the price listed. 24" wide units are available at a 25% upcharge. Contact factory for weights.

For 24" units, add "2" to end of catalog number (e.g. WFIB810802); for 30" units, add "3" (e.g. WFIB810803).

CAT. NO.	W	D	H	WT.	PRICE
EXTRA DIVIDERS					
EWD-1	3/16	8	6 1/2	0.4	10.80
EWD-2	3/16	12	6 1/2	0.6	12.20

NOTE: MOST PRODUCTS AVAILABLE IN 24"W AT AN UPCHARGE OF 25%.

DOUBLE FACE

FIXED BASE			ADJUSTABLE BASE			SHELF DEPTH	BASE DEPTH
CAT. NO.	WT.	PRICE	CAT. NO.	WT.	PRICE		
42" HIGH, 3 LEVELS							
WFIB42080	66	500.00	WAIB42080	67	481.00	8"	16"
WFIB42082	69	493.00	WAIB42082	71	494.00	8"	20"
WFIB42090	70	502.00	WAIB42090	71	501.00	9"	18"
WFIB42091	72	506.00	WAIB42091	74	507.00	9"	20"
WFIB42100	75	515.00	WAIB42100	77	516.00	10"	20"
WFIB42102	79	532.00	WAIB42102	80	537.00	10"	24"
WFIB42120	86	568.00	WAIB42120	87	573.00	12"	24"
66" HIGH, 5 LEVELS							
WFIB62080	100	724.00	WAIB62080	102	705.00	8"	16"
WFIB62082	104	717.00	WAIB62082	105	718.00	8"	20"
WFIB62090	108	739.00	WAIB62090	109	738.00	9"	18"
WFIB62091	110	744.00	WAIB62091	112	743.00	9"	20"
WFIB62100	116	761.00	WAIB62100	118	762.00	10"	20"
WFIB62102	120	778.00	WAIB62102	121	783.00	10"	24"
WFIB62120	134	852.00	WAIB62120	135	852.00	12"	24"
78" HIGH, 6 LEVELS							
WFIB72080	119	839.00	WAIB72080	121	820.00	8"	16"
WFIB72082	123	833.00	WAIB72082	125	834.00	8"	20"
WFIB72090	129	861.00	WAIB72090	130	860.00	9"	18"
WFIB72091	130	866.00	WAIB72091	132	867.00	9"	20"
WFIB72100	138	892.00	WAIB72100	140	894.00	10"	20"
WFIB72102	142	905.00	WAIB72102	143	910.00	10"	24"
WFIB72120	159	997.00	WAIB72120	160	997.00	12"	24"
84" HIGH, 7 LEVELS							
WFIB82080	135	944.00	WAIB82080	136	926.00	8"	16"
WFIB82082	138	937.00	WAIB82082	140	939.00	8"	20"
WFIB82090	145	972.00	WAIB82090	146	972.00	9"	18"
WFIB82091	147	977.00	WAIB82091	149	979.00	9"	20"
WFIB82100	156	1,005.00	WAIB82100	158	1,006.00	10"	20"
WFIB82102	160	1,026.00	WAIB82102	161	1,029.00	10"	24"
WFIB82120	181	1,132.00	WAIB82120	182	1,137.00	12"	24"
90" HIGH, 7 LEVELS							
WFIB92080	136	950.00	WAIB92080	137	932.00	8"	16"
WFIB92082	139	944.00	WAIB92082	141	946.00	8"	20"
WFIB92090	146	979.00	WAIB92090	147	979.00	9"	18"
WFIB92091	148	983.00	WAIB92091	150	986.00	9"	20"
WFIB92100	157	1,016.00	WAIB92100	159	1,017.00	10"	20"
WFIB92102	161	1,028.00	WAIB92102	162	1,036.00	10"	24"
WFIB92120	182	1,134.00	WAIB92120	183	1,138.00	12"	24"

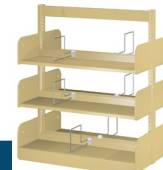

WFIB42080

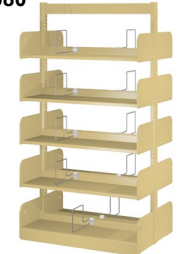

WFIB62080

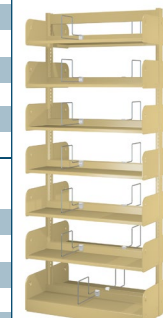

WFIB72080

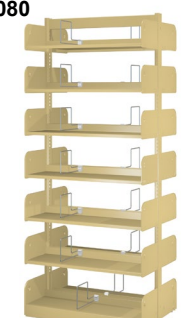

WFIB82080

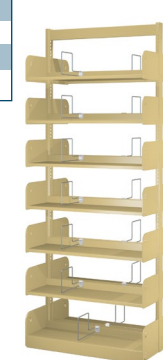

WFIB92080

2.5" Weld Frame

Units come with one wire divider per shelf level.

30" wide units are available at the price listed. 24" wide units are available at a 25% upcharge. Contact factory for weights.

For 24" units, add "2" to end of catalog number (e.g. WFIB820802); for 30" units, add "3" (e.g. WFIB820803).

CAT. NO.	W	D	H	WT.	PRICE
EXTRA DIVIDERS					
EWD-1	3/16	8	6 1/2	0.4	10.80
EWD-2	3/16	12	6 1/2	0.6	12.20

NOTE: MOST PRODUCTS AVAILABLE IN 24"W AT AN UPCHARGE OF 25%.

PERIODICAL DISPLAY UNITS

Pivoting periodical shelving with flat storage shelf.
With 12" storage shelves & 12" fixed base single face or 24" fixed base double face.



WP61120

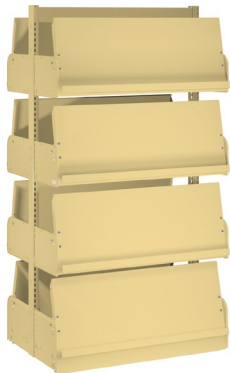

WP62120

24" wide units are available at a 25% upcharge. Contact factory for weights.

CAT. NO.	SLOPING SHELVES	STORAGE LEVELS	W	D	H	WT.	PRICE
SINGLE FACE*							
WP411203†	3	3	30	12	42	68.0	455.00
WP611203	4	4	30	12	66	88.0	565.00
WP711203	5	5	30	12	78	107.0	668.00
WP811203	5	5	30	12	84	108.0	672.00
WP911203	6	6	30	12	90	124.0	767.00
WP41120†	3	3	36	12	42	77.0	455.00
WP61120	4	4	36	12	66	100.0	565.00
WP71120	5	5	36	12	78	122.0	668.00
WP81120	5	5	36	12	84	122.0	672.00
WP91120	6	6	36	12	90	141.0	768.00
DOUBLE FACE							
WP421203†	6	6	30	24	42	114.0	717.00
WP621203	8	8	30	24	66	150.0	916.00
WP721203	10	10	30	24	78	183.0	1,108.00
WP821203	10	10	30	24	84	184.0	1,112.00
WP921203**	12	12	30	24	90	216.0	1,296.00
WP42120†	6	6	36	24	42	130.0	716.00
WP62120	8	8	36	24	66	171.0	915.00
WP72120	10	10	36	24	78	211.0	1,108.00
WP82120	10	10	36	24	84	211.0	1,112.00
WP92120**	12	12	36	24	90	248.0	1,296.00

† A canopy top will not fit on 42" high units.

*All single face shelving must be wall anchored.

**Overhead top bracing recommended.

DISPLAY SHELF UNITS

Ideal for displaying various periodicals, new books or other media items. Lower shelves are sloped 10° for better visualization



WFDS636



WFDD636

CAT. NO.	SLOPING SHELVES	STORAGE LEVELS	W	D	H	WT.	PRICE
SINGLE FACE*							
WFDS436	0	3	36	17	42	64.0	493.00
WFDS636	2	3	36	17	66	98.0	699.00
WFDS836	3	4	36	17	84	127.0	824.00
WFDS936**	3	4	36	17	90	130.0	838.00
DOUBLE FACE							
WFDD436	0	6	36	31	42	111.0	806.00
WFDD636	4	6	36	31	66	174.0	1,200.00
WFDD836	6	8	36	31	84	226.0	1,433.00
WFDD936**	6	8	36	31	90	235.0	1,429.00

*All single face shelving must be wall anchored.

**Overhead top bracing recommended.

30" wide units are available at the price listed. 24" wide units are available at a 25% upcharge. Contact factory for weights.

NOTE: MOST PRODUCTS AVAILABLE IN 24"W AT AN UPCHARGE OF 25%.

WELDED FRAMES

CAT. NO.	DESCRIPTION	W	D	H	WT.	PRICE
W4230		30	2 1/2	42	14.2	114.00
W5430		30	2 1/2	54	16.0	139.00
W6630		30	2 1/2	66	19.4	134.00
W7830		30	2 1/2	78	22.0	148.00
W8430		30	2 1/2	84	23.0	151.00
W9030		30	2 1/2	90	24.0	158.00
W9330		30	2 1/2	93	25.0	230.00
W4236		36	2 1/2	42	15.3	114.00
W5436		36	2 1/2	54	15.5	139.00
W6636		36	2 1/2	66	20.0	134.00
W7836		36	2 1/2	78	24.0	148.00
W8436		36	2 1/2	84	24.0	151.00
W9036		36	2 1/2	90	25.0	158.00
W9336		36	2 1/2	93	26.0	230.00
W10836		36	2 1/2	108	27.0	221.00
W11236		36	2 1/2	112	27.0	270.00
SEISMIC SWAY BRACES						
SSBR6030A	For 66" and 78" frames	30	1	58	4.5	64.00
SSBR7330A	For 84", 90" and 93" frames	30	1	73	5.9	73.00
SSBR6036A	For 66" and 78" frames	36	1	58	4.5	64.00
SSBR7336A	For 84", 90" and 93" frames	36	1	73	5.9	73.00

24" wide units are available at a 25% upcharge. Contact factory for weights. For 24" units, add "2" to end of catalog number (e.g. W42302)
Special widths or heights are available. Contact factory for pricing.



WELDED FRAMES

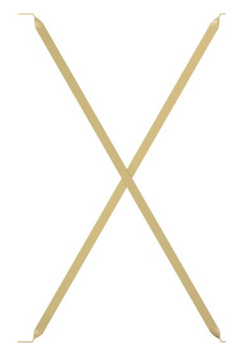

SEISMIC SWAY BRACES

SEISMIC WELDED FRAMES

CAT. NO.	W	D	H	WT.	PRICE
SWF7830	30	2 1/2	78	27.0	239.00
SWF8430	30	2 1/2	84	31.0	245.00
SWF9030	30	2 1/2	90	32.0	245.00
SWF7836	36	2 1/2	78	29.0	239.00
SWF8436	36	2 1/2	84	31.0	245.00
SWF9036	36	2 1/2	90	32.0	245.00

Eliminates the need for sway braces.



WELDED FRAME EXTENDER

CAT. NO.	W	D	H	WT.	PRICE
WFEXT3618	36	2 1/2	18	9.2	152.00
WFEXT3624	36	2 1/2	24	11.2	142.00
WFEXT3630	36	2 1/2	30	13.9	159.00
WFEXT36xx	36	2 1/2	Varies	Varies	Contact Factory



Add to existing frames for more space. Available in a variety of sizes with a 12" minimum. Contact factory for pricing and weights on sizes not shown.

2.5" Weld Frame

NOTE: MOST PRODUCTS AVAILABLE IN 24"W AT AN UPCHARGE OF 25%.

CLOSED BASE SHELVES - SINGLE FACE

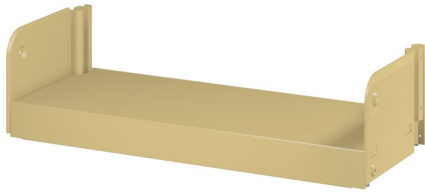

Comes complete with base brackets. Kickplates for adjustable base shelves are furnished with black powder coat finish. If 30" shelves are desired, change the number "36" to "30" (e.g. WA3013A or WB3013A). Call factory for weights on 30" shelves.

CAT. NO.	W	D	H	WT.	PRICE
FOR FIXED BASE SHELVES					
WB3608A	36	8	3 5/16	12.2	100.00
WB3609A	36	9	3 5/16	13.1	103.00
WB3610A	36	10	3 5/16	15.4	106.00
WB3612A	36	12	3 5/16	16.6	110.00
WB3613A	36	13	3 5/16	17.4	124.00
WB3616A	36	16	3 5/16	20.0	140.00
FOR ADJUSTABLE BASE SHELVES					
WA3608A	36	8	3 5/16	12.4	101.00
WA3609A	36	9	3 5/16	13.9	104.00
WA3610A	36	10	3 5/16	14.6	102.00
WA3612A	36	12	3 5/16	16.0	106.00
WA3613A	36	13	3 5/16	16.9	121.00
WA3616A	36	16	3 5/16	19.0	172.00

CLOSED BASE SHELVES - DOUBLE FACE

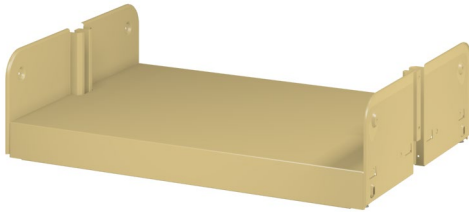

Comes complete with base brackets. Kickplates for adjustable base shelves are furnished with black powder coat finish. If 30" shelves are desired, change the number "36" to "30" (e.g. WA3013A or WB3013A). Call factory for weights on 30" shelves.

CAT. NO.	W	D	H	WT.	PRICE
FOR FIXED BASE SHELVES					
WB3616DA	36	16	3 5/16	18.0	123.00
WB3618A	36	18	3 5/16	19.9	130.00
WB3620A	36	20	3 5/16	23.0	142.00
WB3624A	36	24	3 5/16	26.0	154.00
WB3626A	36	26	3 5/16	28.0	181.00
WB3632A	36	32	3 5/16	33.0	208.00
FOR ADJUSTABLE BASE SHELVES					
WA3616DA	36	16	3 5/16	21.0	137.00
WA3618A	36	18	3 5/16	23.0	147.00
WA3620A	36	20	3 5/16	25.0	151.00
WA3624A	36	24	3 5/16	28.0	163.00
WA3626A	36	26	3 5/16	30.0	189.00
WA3632A	36	32	3 5/16	35.0	211.00

CLOSED BASE SHELVES WITH INTEGRAL BACK AND DIVIDERS - SINGLE FACE

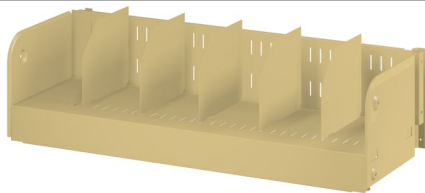

Slotted on 1" centers for dividers, with 5" backstop. Five adjustable dividers provided per shelf. Kickplates for adjustable base shelves are furnished with black powder coat finish. If 30" shelves are desired, change the number "36" to "30" (e.g. TBDF3010 or TBDA3010). Call factory for weights on 30" shelves.

CAT. NO.	W	D	H	WT.	PRICE
FOR FIXED BASE SHELVES					
TBDF3610	36	10	3 5/16	18.3	119.00
TBDF3612	36	12	3 5/16	19.5	125.00
TBDF3613	36	13	3 5/16	20.0	129.00
TBDF3616	36	16	3 5/16	25.0	163.00
FOR ADJUSTABLE BASE SHELVES					
TBDA3610	36	10	3 5/16	18.9	128.00
TBDA3612	36	12	3 5/16	20.0	133.00
TBDA3613	36	13	3 5/16	21.0	141.00
TBDA3616	36	16	3 5/16	25.0	207.00

CLOSED BASE SHELVES WITH INTEGRAL BACK AND DIVIDERS - DOUBLE FACE

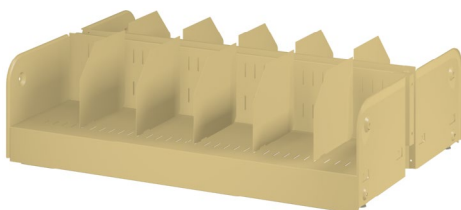

Slotted on 1" centers for dividers, with 5" backstop. Five adjustable dividers provided per shelf. Kickplates for adjustable base shelves are furnished with black powder coat finish. If 30" shelves are desired, change the number "36" to "30" (e.g. TBDF3010 or TBDA3010). Call factory for weights on 30" shelves.

CAT. NO.	W	D	H	WT.	PRICE
FOR FIXED BASE SHELVES					
TBDF3620	36	20	3 5/16	34.0	194.00
TBDF3624	36	24	3 5/16	37.0	208.00
TBDF3626	36	26	3 5/16	39.0	220.00
TBDF3632	36	32	3 5/16	47.0	279.00
FOR ADJUSTABLE BASE SHELVES					
TBDA3620	36	20	3 5/16	35.0	213.00
TBDA3624	36	24	3 5/16	38.0	227.00
TBDA3626	36	26	3 5/16	40.0	239.00
TBDA3632	36	32	3 5/16	48.0	291.00

NOTE: MOST PRODUCTS AVAILABLE IN 24"W AT AN UPCHARGE OF 25%.

INTEGRAL BACK BASE SHELVES - SINGLE FACE

CAT. NO.	W	D	H	WT.	PRICE
WIBBS3008A	30	8	3 5/16	10.2	111.00
WIBBS3009A	30	9	3 5/16	10.8	107.00
WIBBS3010A	30	10	3 5/16	12.0	108.00
WIBBS3012A	30	12	3 5/16	13.2	116.00
WIBBS3013A	30	13	3 5/16	14.2	127.00
WIBBS3016A	30	16	3 5/16	16.4	140.00
WIBBS3608A	36	8	3 5/16	11.2	111.00
WIBBS3609A	36	9	3 5/16	11.9	107.00
WIBBS3610A	36	10	3 5/16	13.2	108.00
WIBBS3612A	36	12	3 5/16	14.6	116.00
WIBBS3613A	36	13	3 5/16	15.5	127.00
WIBBS3616A	36	16	3 5/16	18.2	140.00
DIVIDER ONLY					
EWD-1	3/16	8	6 1/2	0.4	10.80
EWD-2	3/16	12	6 1/2	0.6	12.20

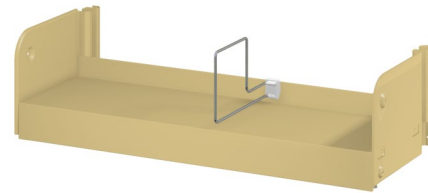

Includes one wire divider per opening and a 2" built-in backstop.
If adjustable base is required, change "WIBBS" to "WIBBSA" when ordering (e.g. WIBBSAwdddA).
Call factory for adjustable base pricing and weights.

INTEGRAL BACK BASE SHELVES - DOUBLE FACE

CAT. NO.	W	D	H	WT.	PRICE
WIBBS3018A	30	18	3 5/16	19.6	169.00
WIBBS3020A	30	20	3 5/16	21.0	173.00
WIBBS3024A	30	24	3 5/16	25.0	190.00
WIBBS3026A	30	26	3 5/16	26.0	216.00
WIBBS3032A	30	32	3 5/16	31.0	232.00
WIBBS3618A	36	18	3 5/16	22.0	169.00
WIBBS3620A	36	20	3 5/16	24.0	173.00
WIBBS3624A	36	24	3 5/16	27.0	190.00
WIBBS3626A	36	26	3 5/16	29.0	216.00
WIBBS3632A	36	32	3 5/16	34.0	232.00
DIVIDER ONLY					
EWD-1	3/16	8	6 1/2	0.4	10.80
EWD-2	3/16	12	6 1/2	0.6	12.20

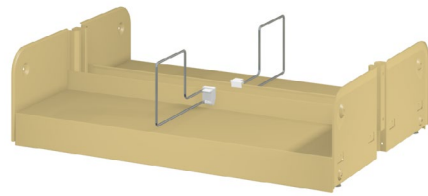

Includes one wire divider per opening and a 2" built-in backstop.
If adjustable base is required, change "WIBBS" to "WIBBSA" when ordering (e.g. WIBBSAwdddA).
Call factory for adjustable base pricing and weights.

SLOPING BASE SHELVES - SINGLE FACE

CAT. NO.	W	D	H	WT.	PRICE
WSB3009A	30	9	3 7/8	14.0	112.00
WSB3010A	30	10	3 7/8	14.3	111.00
WSB3012A	30	12	3 7/8	15.2	113.00
WSB3609A	36	9	3 7/8	13.5	114.00
WSB3610A	36	10	3 7/8	15.0	111.00
WSB3612A	36	12	3 7/8	15.2	113.00
VIDEO SLOPING BASE SHELVES (6 DIVIDERS INCLUDED)					
VC3012A	30	12	3 7/8	18.7	145.00
VC3612A	36	12	3 7/8	19.7	145.00

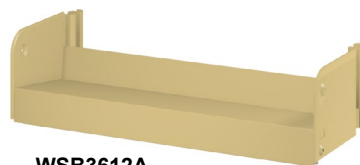

WSB3612A

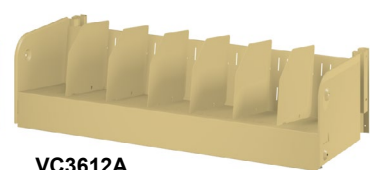

VC3612A

Sloping Base Shelves and Video Sloping Base Shelves are sloped at 9°, aiding visually those items displayed on the bottom shelf. Video Sloping Base Shelves are slotted on 1" centers for dividers, with 5" integral backstop; six adjustable dividers are provided.

SLOPING BASE SHELVES - DOUBLE FACE

CAT. NO.	W	D	H	WT.	PRICE
WSB3018A	30	18	3 7/8	24.0	181.00
WSB3020A	30	20	3 7/8	25.0	185.00
WSB3024A	30	24	3 7/8	31.0	193.00
WSB3618A	36	18	3 7/8	23.0	181.00
WSB3620A	36	20	3 7/8	26.0	185.00
WSB3624A	36	24	3 7/8	31.0	193.00
VIDEO SLOPING BASE SHELVES (12 DIVIDERS INCLUDED)					
VC3012DA	30	24	3 7/8	38.0	259.00
VC3612DA	36	24	3 7/8	40.0	259.00

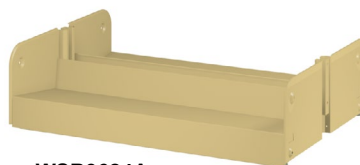

WSB3624A

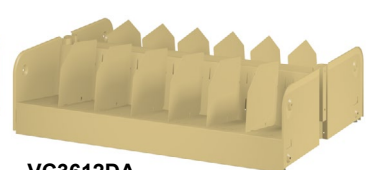

VC3612DA

Sloping Base Shelves and Video Sloping Base Shelves are sloped at 9°, aiding visually those items displayed on the bottom shelf. Video Sloping Base Shelves are slotted on 1" centers for dividers, with 5" integral backstop; twelve adjustable dividers are provided.

NOTE: MOST PRODUCTS AVAILABLE IN 24"W AT AN UPCHARGE OF 25%.

ADJUSTABLE SHELVES

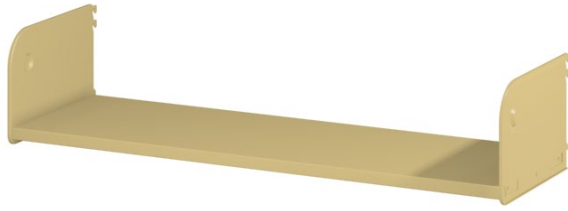

Includes shelf brackets. Can be furnished in additional widths or depths; contact factory for pricing.

CAT. NO.	W	D	H	WT.	PRICE
BL3008A	30	8	13/16	5.9	33.00
BL3009A	30	9	13/16	6.6	38.00
BL3010A	30	10	13/16	7.2	40.00
BL3011A	30	11	13/16	7.9	42.00
BL3012A	30	12	13/16	8.6	45.00
BL3013A	30	13	13/16	9.2	56.00
BL3014A	30	14	13/16	9.9	58.00
BL3016A	30	16	13/16	11.2	63.00
BL3608A	36	8	13/16	6.7	33.00
BL3609A	36	9	13/16	7.5	38.00
BL3610A	36	10	13/16	8.2	40.00
BL3611A	36	11	13/16	9.0	42.00
BL3612A	36	12	13/16	9.8	45.00
BL3613A	36	13	13/16	10.5	56.00
BL3614A	36	14	13/16	11.3	57.00
BL3616A	36	16	13/16	12.8	63.00

ADJUSTABLE DIVIDER SHELVES

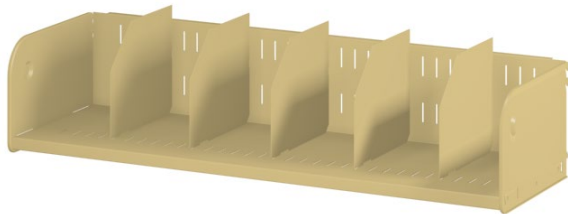

Slotted on 1" centers to accommodate dividers. Includes 5" back, brackets and 5 adjustable dividers per shelf.

CAT. NO.	W	D	H	WT.	PRICE
BDA3010A	30	10	13/16	12.8	75.00
BDA3011A	30	11	13/16	13.5	78.00
BDA3012A	30	12	13/16	14.2	81.00
BDA3013A	30	13	13/16	14.8	85.00
BDA3016A	30	16	13/16	17.9	108.00
BDA3610A	36	10	13/16	14.1	75.00
BDA3611A	36	11	13/16	14.9	78.00
BDA3612A	36	12	13/16	15.7	81.00
BDA3613A	36	13	13/16	16.4	85.00
BDA3616A	36	16	13/16	20.0	108.00

SHELF BRACKETS



LEFT BRACKET



RIGHT BRACKET

Attaches shelves to unit uprights. ***NOTE:** Listed catalog numbers are for left bracket only; for right bracket, change the suffix "L" to "R".

CAT. NO.	W	D	H	WT.	PRICE
ASBRK08L*	1/4	8	7 1/2	1.0	5.70
ASBRK09L*	1/4	9	7 1/2	1.1	6.20
ASBRK10L*	1/4	10	7 1/2	1.2	6.40
ASBRK11L*	1/4	11	7 1/2	1.4	7.20
ASBRK12L*	1/4	12	7 1/2	1.5	7.80
ASBRK13L*	1/4	13	7 1/2	1.6	8.90
ASBRK14L*	1/4	14	7 1/2	1.8	9.20
ASBRK16L*	1/4	16	7 1/2	2.0	11.00

DIVIDERS

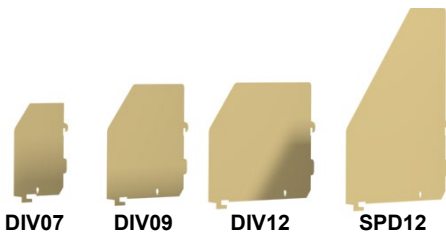

DIV07

DIV09

DIV12

SPD12

CAT. NO.	USE WITH	D	H	WT.	PRICE
DIV07	7" - 9" Shelves	7	6	0.4	2.40
DIV09	10" through 13"	9	7 1/2	0.7	3.30
DIV12	14" through 16"	12	7 1/2	1.0	5.20
SPD12	14" through 16"	9	12	1.6	12.10

SHIMS



Used to aid in the leveling of fixed base units. Zinc finish.

CAT. NO.	W	D	H	WT.	PRICE
SHIM	2	2 1/2	1/16	0.1	1.20

THIS PAGE LEFT BLANK INTENTIONALLY

THIS PAGE LEFT BLANK INTENTIONALLY

THIS PAGE LEFT BLANK INTENTIONALLY

THIS PAGE LEFT BLANK INTENTIONALLY



NOTE: MOST PRODUCTS AVAILABLE IN 24"W AT AN UPCHARGE OF 25%.

HINGED PERIODICAL DISPLAY SHELVES



PERIODICAL DISPLAY SHELF

Sloped for display. 14" high periodical surface.

*Includes continuous label holder.

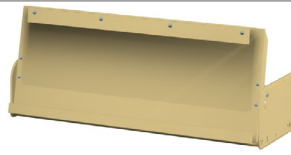

PERIODICAL DISPLAY SHELF WITH PLEXIGLASS COVER

CAT. NO.	W	D	H	WT.	PRICE
PDS3012A	30	12	14	15.5	90.00
PDS3612A	36	12	14	18.0	90.00
PDS3012ACLH*	30	12	14	14.9	110.00
PDS3612ACLH*	36	12	14	18.0	110.00
WITH PLEXIGLASS COVER					
PDSCA30	30	12	14	22.0	217.00
PDSCA	36	12	14	23.0	217.00

FIXED SLOPED DISPLAY SHELVES



SLOPED DISPLAY SHELF

Sloped for display. 12" periodical surface.

*Includes continuous label holder.

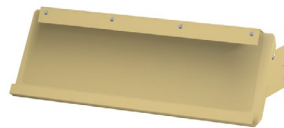

SLOPED DISPLAY SHELF WITH PLEXIGLASS COVER

CAT. NO.	W	D	H	WT.	PRICE
SDS3012A	30	12	12	7.3	77.00
SDS3612A	36	12	12	9.6	77.00
SDS3012ACLH*	30	12	12	13.1	124.00
SDS3612ACLH*	36	12	12	9.2	117.00
WITH PLEXIGLASS COVER					
SDSCA30	30	12	12	11.8	215.00
SDSCA	36	12	12	11.8	215.00

INTEGRAL BACK SHELVES

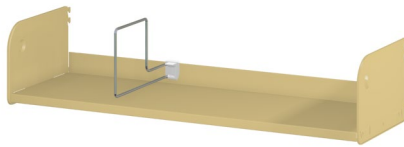

Built-in 2" backstop keeps items organized. Includes brackets and one wire divider per shelf. For 30" shelf, change "BLIB36" to "BLIB30" (e.g. BLIB3016A).

CAT. NO.	W	D	H	WT.	PRICE
BLIB3608A	36	8	13/16	7.5	51.00
BLIB3609A	36	9	13/16	8.3	54.00
BLIB3610A	36	10	13/16	9.0	57.00
BLIB3611A	36	11	13/16	9.8	61.00
BLIB3612A	36	12	13/16	10.8	66.00
BLIB3613A	36	13	13/16	11.5	74.00
BLIB3616A	36	16	13/16	13.8	85.00

SLOPED INTEGRAL BACK SHELVES

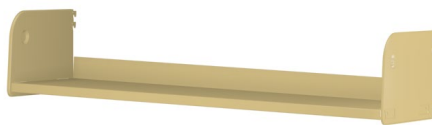

Shelves have a 7° slope.

Built-in 2" backstop keeps items from falling off sloped shelf. For 30" shelf, change "SIBS36" to "SIBS30" (e.g. SIBS3016A).

CAT. NO.	W	D	H	WT.	PRICE
SIBS3608A	36	8	13/16	7.4	42.00
SIBS3609A	36	9	13/16	8.1	45.00
SIBS3610A	36	10	13/16	8.8	49.00
SIBS3611A	36	11	13/16	9.7	53.00
SIBS3612A	36	12	13/16	10.4	56.00

MULTIPURPOSE DISPLAY SHELVES



AS SLOPING DISPLAY SHELF



AS INTEGRAL BACK SHELF

Two-positional shelf allows you to have either a sloping display shelf or (reversed) an integral back shelf. Ideal for displaying video tapes, audio cassettes, art books, etc.

CAT. NO.	TYPE	W	D	H	WT.	PRICE
MP3610A	No Dividers	36	10	8	10.2	69.00
MPD3610A	With Dividers	36	10	8	12.4	83.00

Divider shelves come with 6 dividers.

MULTIPURPOSE BASE SHELVES



SINGLE ENTRY



DOUBLE ENTRY

Two-positional shelf can be used as either a sloping display shelf or (reversed) an integral back shelf. Divider shelves come with 6 dividers.

CAT. NO.	TYPE	W	D	H	WT.	PRICE
SINGLE ENTRY						
MPB3610A	No Dividers	36	10	8	15.6	114.00
MPDB3610A	With Dividers	36	10	8	17.8	128.00
DOUBLE ENTRY						
MPB3620A	No Dividers	36	20	8	38.0	203.00
MPDB3620A	With Dividers	36	20	8	42.0	232.00

NOTE: MOST PRODUCTS AVAILABLE IN 24"W AT AN UPCHARGE OF 25%.

STORAGE SHELVES

CAT. NO.	W	D	H	WT.	PRICE
IN3610A	36	10	13/16	6.9	36.00
IN3612A	36	12	13/16	8.1	39.00
IN3613A	36	13	13/16	8.6	48.00
IN3614A	36	14	13/16	9.5	50.00
IN3616A	36	16	13/16	10.5	53.00
IN3618A	36	18	13/16	11.7	63.00
IN3619A	36	19	13/16	12.4	66.00



Used with sloped display shelves (at left on page 16), or any place where a flat shelf is desired. For 30" shelf, change "IN36" to "IN30" (e.g. IN3010A)

FACE-OUT DISPLAY SHELF

CAT. NO.	W	D	H	WT.	PRICE
FODSA	36	2 3/4	5 9/16	6.2	65.00

Used to display compact discs and DVDs. Shelf has a 7° slope.



VIDEO CASSETTE/PAPERBACK BOOK SHELF

CAT. NO.	W	D	H	WT.	PRICE
VCS3007A	30	6	7 1/2	11.5	67.00
VCS3008A	30	7	7 1/2	10.6	72.00
VCS3607A	36	6	7 1/2	10.8	67.00
VCS3608A	36	7	7 1/2	11.5	72.00
DIV07	(DIVIDER ONLY)			0.4	2.40

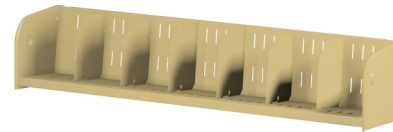

Slopes to allow convenient viewing of spines on paperbacks and video cassettes. Six adjustable dividers included per shelf.

SLIDING REFERENCE SHELVES*

*Brackets included.

CAT. NO.	W	D	H	WT.	PRICE
SRS3008A	30	8	3	9.2	212.00
SRS3009A	30	9	3	8.2	183.00
SRS3010A	30	10	3	13.1	209.00
SRS3012A	30	12	3	15.6	196.00
SRS3608A	36	8	3	9.2	212.00
SRS3609A	36	9	3	8.2	183.00
SRS3610A	36	10	3	14.0	209.00
SRS3612A	36	12	3	16.6	196.00

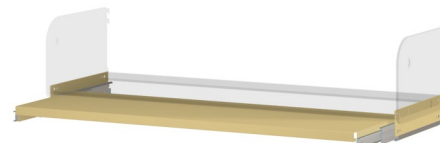

Used with sloped display shelves (at left on page 16), or any place where a flat shelf is desired. For 30" shelf, change "IN36" to "IN30" (e.g. IN3010A)

DOUBLE TIER VIDEO CASSETTE & AUDIO CASSETTE SHELVES

CAT. NO.	W	D	H	WT.	PRICE
VIDEO CASSETTE SHELF					
VCDT3014	30	14	12	20.0	204.00
VCDT3614	36	14	12	20.0	204.00
AUDIO CASSETTE/MICROFILM SHELF					
SPMF30A	30	10	7 1/2	12.1	235.00
SPMF36A	36	10	7 1/2	12.1	235.00



VCDT3014



SPMF30A

Double Tier Video Cassette Shelf is used with compact discs, video cassettes, or paperbacks. Sloped; 36" wide shelf holds 60 videotapes or 160 compact discs. **Audio Cassette Shelf** stores microfilm or audio cassettes. Capacity: 100 cassettes (36" wide shelf).

ZIG-ZAG SHELF

CAT. NO.	W	D	H	WT.	PRICE
ZZ3008A	30	7	5 13/16	10.1	100.00
ZZ3608A	36	7	5 13/16	10.9	100.00
INSERT ONLY					
ZZPD	36	18	5	3.8	60.00

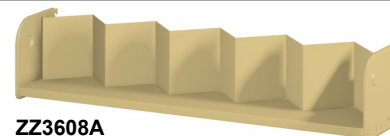

ZZ3608A

Adjustable shelf with paperback insert. Ideal for displaying audio cassette or paperback books.

NOTE: MOST PRODUCTS AVAILABLE IN 24"W AT AN UPCHARGE OF 25%.

CABINETS



Cabinet Only

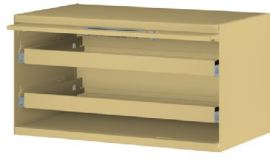

Cabinet With 2 Pull-Out Frames

All welded construction. Ideal for storing valuable items that need to be secured. Includes flipper door and lock with two keys.

CAT. NO.	W	D	H	WT.	PRICE
CABINET ONLY					
FDCB36L	36	17 5/8	15 1/2	53.0	1,248.00
CABINET WITH 1 PULL-OUT FRAME					
CBFD36LFA	36	17 5/8	15 1/2	63.0	1,248.00
CABINET WITH 2 PULL-OUT FRAMES					
CBFD36L2FA	36	17 5/8	15 1/2	73.0	1,248.00
FRAME ONLY					
FRAME36A	36	16	2	10.1	517.00

MEDIA HANGER RACK



Consists of brackets with hanger rod for clear-view plastic media bags.

CAT. NO.	W	D	H	WT.	PRICE
HB30A	30	6 1/2	4 1/4	2.1	84.00
HB36A	36	6 1/2	4 1/4	2.1	84.00

WORK SHELF AND BRACKETS



WORK SHELF WITH BRACKETS

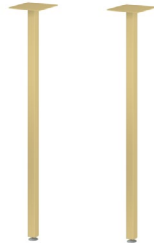

LEGS

CAT. NO.	W	D	H	WT.	PRICE
LC54A	36	24	27 1/2	30.0	1,003.00
LCL (Legs Only, Per Pair)				3.0	109.00
LCBRK24L (Left Bracket Only)				3.6	118.00
LCBRK24R (Right Bracket Only)				3.6	118.00

24" deep plastic shelf laminate supported by two steel triangular brackets for work surface with shelving range. Must state desired finish of work shelf.

METAL TRAYS

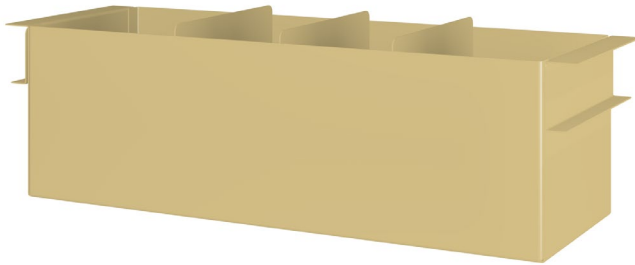

Handy metal trays store a wide variety of media. Use alone or in conjunction with Estey cabinets.

CAT. NO.	W	D	H	WT.	PRICE
FOR COMPACT DISCS					
TRCD514A	5 1/16	14 3/8	4 1/2	4.4	273.00
CDD-1 (Divider Only)				0.2	27.00
FOR AUDIOCASSETTES					
TRAC414A	4 7/16	14 3/8	3 1/8	3.3	386.00
ACD-1 (Divider Only)				0.2	36.00
FOR VHS TAPES					
TRVHS714A	7 5/8	14 3/8	3 1/8	5.1	299.00
VHSD-1 (Divider Only)				0.3	28.00
FOR 3x5 CARDS					
TRCRD3X5A	5 3/16	14 3/8	3 1/8	3.9	433.00
CRDD-1 (Divider Only)				0.2	56.00

METAL BROWSING BOX

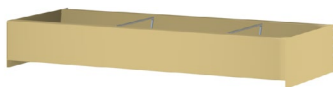

BROWSING BOX



DIVIDER

Ideal for storing all media items. Includes 2 wire dividers.

CAT. NO.	W	D	H	WT.	PRICE
BRB3005A	30	14 1/2	5 1/2	13.5	233.00
BRB3605A	36	14 1/2	5 1/2	15.3	243.00
BRBWD (Divider Only)				0.1	8.70

PULL-OUT BROWSING BOX

A pull out browsing box mounted on full extension ball-bearing suspensions. Ideal for storing all media items. XBRB3611A includes 2 wire dividers; XDBRB3611A includes 4 plate type dividers.

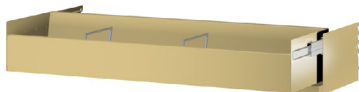

XBRB43611A



XHDBRB3611A

NOTE: The original XBRB3611A, with full-height front, is still available for a list price of \$400.00 and a weight of 30 lbs. Contact factory for further details.

CAT. NO.	W	D	H	WT.	PRICE
WITH SLIDING DIVIDER					
XBRB43611A	36	11 1/2	5 1/2	29.0	477.00
TXBWD (Divider Only)				0.3	10.40
WITH PLATE-TYPE DIVIDER and 3" FRONT					
XHDBRB3611A	36	11 1/2	5 1/2	31.0	661.00
BRBDIVA (Divider Only)				0.4	4.90

2.5" Weld Frame

NOTE: MOST PRODUCTS AVAILABLE IN 24"W AT AN UPCHARGE OF 25%.

NEWSPAPER RACK

CAT. NO.	TYPE	W	D	H	WT.	PRICE
NPR6	6 Holders	36	12	14	9.6	951.00
NPR10	10 Holders	36	12	22	15.2	1,403.00

Displays newspapers. Newspaper sticks included.



WALL HUNG COLUMNS

CAT. NO.	W	D	H	WT.	PRICE
PILWCH24	1 1/2	1	24	2.4	48.00
PILWCH30	1 1/2	1	30	2.4	48.00
PILWCH42	1 1/2	1	42	3.1	48.00
PILWCH54	1 1/2	1	54	3.8	51.00
PILWCH60	1 1/2	1	60	3.8	53.00
PILWCH66	1 1/2	1	66	3.8	61.00
PILWCH72	1 1/2	1	72	4.5	56.00
PILWCH78	1 1/2	1	78	4.5	58.00
PILWCH84	1 1/2	1	84	4.8	59.00
PILWCH90	1 1/2	1	90	5.2	61.00



Slotted strip attaches to wall. Designed to accept all components or accessory items. Special heights available. Hardware not included because of various wall construction.

CARD HOLDERS

CAT. NO.	W	D	H	WT.	PRICE
SINGLE CARD HOLDER					
SCH-B	5 1/4	—	3 1/8	0.1	2.80
DOUBLE CARD HOLDER					
DCH-B	10 1/4	—	3 1/8	0.2	5.10
ALUMINUM HOLDER					
SCH-CA	5 5/8	—	3 1/2	0.1	3.30



SCH-B



DCH-B

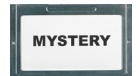

SCH-CA

For 3" x 5" cards. Used on end panels. Attaches with double-sided tape. Steel holders are finished in black powder coat paint.

TRANSVERSE OVERHEAD TOP TIE BRACING

CAT. NO.	W	D	H	WT.	PRICE
FOR WELD FRAME					
OTBW9	96	2	7/8	5.7	36.00

Channel construction top tie furnished in 8 foot lengths. Recommended for added stabilization when bases and shelves are of equal depths.

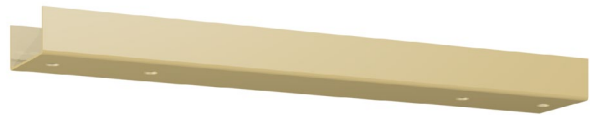

SHELF LABEL HOLDER

CAT. NO.	W	D	H	WT.	PRICE
SLH	5 1/2	2	3 3/4	0.1	1.10

Plastic clip-on holder 5/8" x 5" card. (Paper not included)



WALL CLIP

CAT. NO.	W	D	H	WT.	PRICE
WCLIP	3	2	1	0.2	1.10

Used to attach single face units to the wall for support. Wall hardware not included.



RANGE FINDER

CAT. NO.	W	D	H	WT.	PRICE
RFP6	—	6 3/4	3 1/8	0.2	5.00

For use on end panels or uprights for identification of range contents. Attaches with double-sided tape. Holds two 3" x 5" cards. Finished in black.



NOTE: MOST PRODUCTS AVAILABLE IN 24"W AT AN UPCHARGE OF 25%.

STEEL BOOK SUPPORTS



CAT. NO.	W	D	H	WT.	PRICE
WITH CORK BACKING					
BSN6	4 9/16	5 1/2	6	0.6	6.80
BSN9	4 9/16	5 1/2	9	1.1	8.20
WITH MAGNETIC STRIP					
BSM6	4 9/16	5 1/2	6	1.0	6.80
BSM9	4 9/16	5 1/2	9	1.1	8.20

Unattached book support used on surface of shelves. Furnished with cork backing or a magnetic strip, as specified above.

HOOK-ON BOOK SUPPORTS

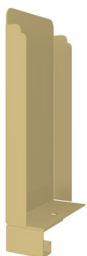

CAT. NO.	W	D	H	WT.	PRICE
LOBS6	4 9/16	1 3/4	6	0.6	9.30
LOBS9	4 9/16	1 3/4	9	1.2	10.20

Hooks onto return flange of adjustable shelves for rigid support.

WIRE BOOK SUPPORTS



6-INCH "V" SUPPORT



7-INCH "W" SUPPORT



9-INCH "V" SUPPORT



9-INCH "W" SUPPORT

CAT. NO.	TYPE	W	D	H	WT.	PRICE
WBS6	"V"	3/16	—	6	0.2	4.40
WBS9	"V"	3/16	—	9	0.3	4.90
WBSW7	"W"	3/16	—	7	0.3	5.80
WBSW9	"W"	3/16	—	9	0.4	6.80

Heavy spring wire book support. Attaches to underside of shelf. Easily adjustable.

SHELF FILLER

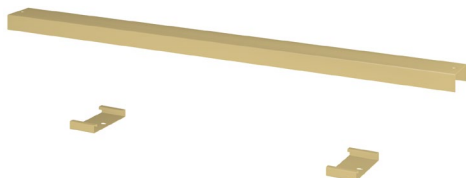

CAT. NO.	W	D	H	WT.	PRICE
SHFIL30	27	2 5/8	1	2.3	34.00
SHFIL36	33	2 5/8	1	2.6	34.00

Fills the space between adjustable shelves on double sided units, providing a continuous surface. Attaches with two clips that fasten to underside of shelves.

SLOPED ADJUSTABLE END BRACKET



LEFT BRACKET



RIGHT BRACKET

CAT. NO.	W	D	H	WT.	PRICE
SASBRK08LJ*	1/4	8	7 1/2	1.1	6.50
SASBRK09LJ*	1/4	9	7 1/2	1.2	6.90
SASBRK10LJ*	1/4	10	7 1/2	1.3	7.90
SASBRK11LJ*	1/4	11	7 1/2	1.5	8.70
SASBRK12LJ*	1/4	12	7 1/2	1.6	9.10
SASBRK13LJ*	1/4	13	7 1/2	1.7	9.70
SASBRK14LJ*	1/4	14	7 1/2	1.9	14.30

Creates 7 degrees of slope for an adjustable shelf. *NOTE: Listed catalog numbers are for left bracket only; for right bracket, change the suffix "LJ" to "RJ".

NOTE: MOST PRODUCTS AVAILABLE IN 24"W AT AN UPCHARGE OF 25%.

BASE FILLER CLOSURES

CAT. NO.	W	D	H	WT.	PRICE
FOR WELD FRAME					
BFC30	30	2 3/4	1	2.0	9.50
BFC36	36	2 3/4	1	1.6	9.50

Use to fill space between uprights when an adjustable base is used.



BFC36

CAT. NO.	W	D	H	WT.	PRICE
FOR MOBILE CARRIAGE					
BCC30	30	2 1/2	1 3/4	2.1	22.00
BCC36	36	2 1/2	1 3/4	2.5	22.00

Use to fill space between uprights when adjustable shelves are used on bottom of unit.

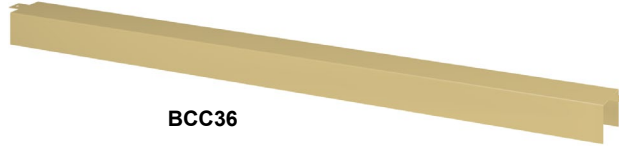

BCC36

ADJUSTABLE BACKSTOP

CAT. NO.	W	D	H	WT.	PRICE
ABS36	36	7/16	2	1.5	15.50

Individual backstop designed to engage in upright slots for adjustability.



REVERSIBLE BACKSTOP – WIRE DIVIDER

CAT. NO.	W	D	H	WT.	PRICE
BACK STOP					
RBS30	30	7/16	2	1.2	8.40
RBS36	36	7/16	2	1.3	8.40
WIRE DIVIDER					
BSWBS	—	8 1/2	4	0.2	4.10

One side is a regular backstop. The other side is a sliding support backstop (when used with wire divider sold above).

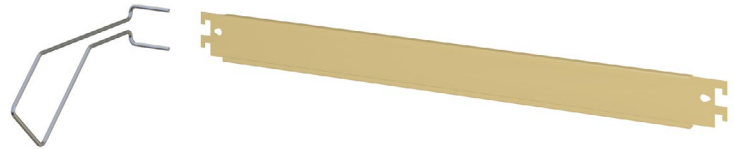

OFFSET CENTER BACKSTOP – LARGE PROFILE

CAT. NO.	W	D	H	WT.	PRICE
CBS30	30	3/8	3 9/32	1.7	26.00
CBS36	36	3/8	3 9/32	2.1	26.00

Works as a backstop for each side of a double entry unit, eliminating the need for an individual backstop for each side.



OFFSET CENTER BACKSTOP – SMALL PROFILE

CAT. NO.	W	D	H	WT.	PRICE
CBSS30	30	7/16	2	1.4	11.70
CBSS36	36	7/16	2	1.6	11.70

Works as a backstop for each side of a double entry unit, eliminating the need for an individual backstop for each side.



FLOOR ANCHOR

CAT. NO.	W	D	H	WT.	PRICE
FLRANCH3	1	3	5/8	0.1	2.40

Used to anchor weld frame units to the floor. For use with weld frame base brackets only. Zinc plated

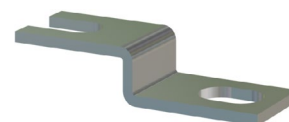

NOTE: MOST PRODUCTS AVAILABLE IN 24"W AT AN UPCHARGE OF 25%.

STEEL CANOPY TOPS

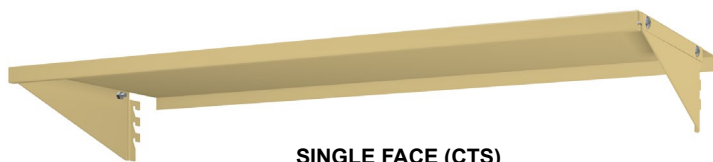

SINGLE FACE (CTS)

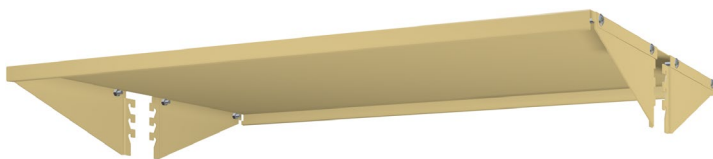

DOUBLE FACE (CTD)

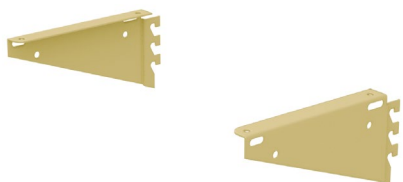

BRACKETS WITH HARDWARE

Keeps dust off your valuable materials. Includes attaching brackets.

*Attaching bracket is also used to secure steel end panels (see page 24). Each pair consists of one left and one right bracket.

CAT. NO.	W	D	H	WT.	PRICE
SINGLE FACE					
CTS3008	30	8	—	5.4	45.00
CTS3009	30	9	—	5.9	47.00
CTS3010	30	10	—	6.4	45.00
CTS3012	30	12	—	7.6	49.00
CTS3013	30	13	—	8.2	57.00
CTS3016	30	16	—	9.7	68.00
CTS3608	36	8	—	6.3	45.00
CTS3609	36	9	—	6.8	46.00
CTS3610	36	10	—	7.4	45.00
CTS3612	36	12	—	8.5	49.00
CTS3613	36	13	—	9.4	57.00
CTS3616	36	16	—	11.6	73.00
DOUBLE FACE					
CTD3016	30	16	—	9.3	75.00
CTD3018	30	18	—	10.2	81.00
CTD3020	30	20	—	11.3	78.00
CTD3024	30	24	—	13.5	86.00
CTD3026	30	26	—	14.8	102.00
CTD3032	30	32	—	17.9	128.00
CTD3616	36	16	—	10.8	76.00
CTD3618	36	18	—	11.8	81.00
CTD3620	36	20	—	13.0	78.00
CTD3624	36	24	—	15.6	86.00
CTD3626	36	26	—	16.9	103.00
CTD3632	36	32	—	20.0	135.00

CANOPY BRACKETS FOR WOOD TOPS

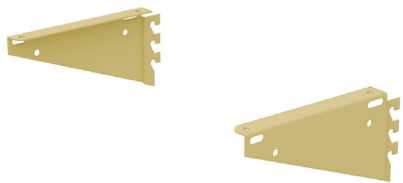

BRACKETS ONLY

Used when wood or hard plastic canopy tops are used. For single face units, use 1 pair. For double face units, use 2 pairs. Each pair consists of one left and one right bracket. Wood top and hardware not included.

CAT. NO.	DEPTH	WT.	PRICE
BRACKETS ONLY			
CTIB08S (1 Pair)	8	1.0	14.20
CTIB09S (1 Pair)	9	1.1	14.80
CTIB10S (1 Pair)	10	1.2	11.80
CTIB12S (1 Pair)	12	1.6	13.00
CTIB13S (1 Pair)	13	1.8	17.40
CTIB16S (1 Pair)	16	2.2	23.40
CTIB18S (1 Pair)	18	2.6	24.20

CANOPY SIGNAGE

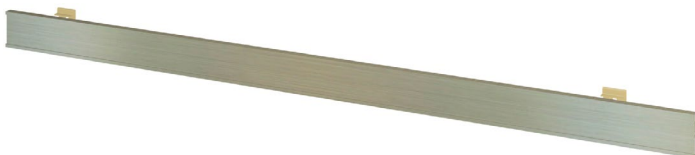

Easily identify special items or sections with this customizable label holder. Three attachment clips provided.

CAT. NO.	W	D	H	WT.	PRICE
CPSGN36	35 1/4	—	1 3/4	1.5	123.00

Material in aluminum. Cannot be painted.

NOTE: MOST PRODUCTS AVAILABLE IN 24"W AT AN UPCHARGE OF 25%.

FIXED BASE/ADJUSTABLE BASE REINFORCING GUSSETS

CAT. NO.	W	D	H	WT.	PRICE
SINGLE FACE					
GS08-1AL (left)	1/16	8	39 7/8	5.0	58.00
GS08-1AR (right)	1/16	8	39 7/8	5.0	58.00
GS09-1AL (left)	1/16	9	39 7/8	5.4	62.00
GS09-1AR (right)	1/16	9	39 7/8	5.4	62.00
GS10-1AL (left)	1/16	10	39 7/8	5.4	65.00
GS10-1AR (right)	1/16	10	39 7/8	5.4	65.00
GS12-1AL (left)	1/16	12	39 7/8	6.2	66.00
GS12-1AR (right)	1/16	12	39 7/8	6.2	72.00
GS13-1AL (left)	1/16	13	39 7/8	9.1	75.00
GS13-1AR (right)	1/16	13	39 7/8	9.1	75.00
GS16-1AL (left)	1/16	16	39 7/8	7.8	85.00
GS16-1AR (right)	1/16	16	39 7/8	7.8	85.00
DOUBLE FACE					
GD08-1A	1/16	16	39 7/8	8.2	71.00
GD09-1A	1/16	18	39 7/8	6.6	77.00
GD10-1A	1/16	20	39 7/8	8.8	83.00
GD12-1A	1/16	24	39 7/8	10.1	90.00
GD13-1A	1/16	26	39 7/8	13.6	103.00
GD16-1A	1/16	32	39 7/8	13.9	123.00

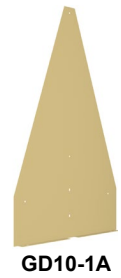

Used when fixed base shelving units are to be mounted on mobile carriage bases or when additional stabilization is required. Also available for adjustable base shelving units; to order, add "J" to end of catalog number and call factory for pricing and weights (e.g. GS2-16LJA).

MOBILE CARRIAGE REINFORCING GUSSETS

CAT. NO.	W	D	H	WT.	PRICE
SINGLE FACE					
GS08CAL (left)	1/16	8	39 7/8	3.8	53.00
GS08CAR (right)	1/16	8	39 7/8	3.8	53.00
GS09CAL (left)	1/16	9	39 7/8	4.3	57.00
GS09CAR (right)	1/16	9	39 7/8	4.3	57.00
GS10CAL (left)	1/16	10	39 7/8	4.5	64.00
GS10CAR (right)	1/16	10	39 7/8	4.5	64.00
GS12CAL (left)	1/16	12	39 7/8	5.1	70.00
GS12CAR (right)	1/16	12	39 7/8	5.1	70.00
GS13CAL (left)	1/16	13	39 7/8	5.8	69.00
GS13CAR (right)	1/16	13	39 7/8	5.8	69.00
GS16CAL (left)	1/16	16	39 7/8	6.4	78.00
GS16CAR (right)	1/16	16	39 7/8	6.4	78.00
DOUBLE FACE					
GD08CA	1/16	16	39 7/8	6.1	71.00
GD09CA	1/16	18	39 7/8	7.4	77.00
GD10CA	1/16	20	39 7/8	8.3	84.00
GD12CA	1/16	24	39 7/8	8.7	93.00
GD13CA	1/16	26	39 7/8	10.1	102.00
GD16CA	1/16	32	39 7/8	11.2	122.00

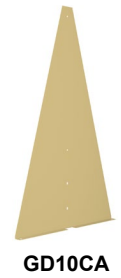
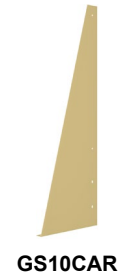

Used when adjustable shelves (in lieu of a base shelf and base bracket) are used as a base and are to be mounted on mobile carriage tracks only.

CORNER FILLERS

CAT. NO.	HEIGHTS	DEPTHS	WT.	PRICE
SCFhhddA	42" to 93"	8" to 32"		CALL FACTORY

Used to make a corner for units placed at right angles to each other. Available in all heights and depths. Specify height and depth (hhdd) when ordering.

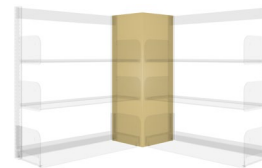

INTERMEDIATE WALL FILLERS

CAT. NO.	HEIGHTS	DEPTHS	WT.	PRICE
DCFhhddA	42" to 93"	8" to 32"		CALL FACTORY

Used to fill a void where two single faced units are joined at a right angle with a double faced unit. Available for all base shelf depths and frame heights. Specify height and depth (hhdd) when ordering.

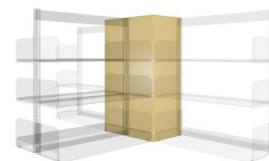

NOTE: MOST PRODUCTS AVAILABLE IN 24"W AT AN UPCHARGE OF 25%.

END PANELS

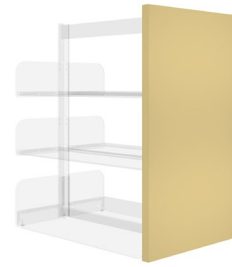

SINGLE FACE

CAT. NO.	BASE DEPTH	HEIGHT	WT.	PRICE
WSP4208A	8	42	11.0	122.00
WSP4209A	9	42	11.5	124.00
WSP4210A	10	42	12.0	128.00
WSP4212A	12	42	13.1	133.00
WSP4213A	13	42	13.6	136.00
WSP4216A	16	42	15.2	158.00
WSP6608A	8	66	21.0	158.00
WSP6609A	9	66	22.0	162.00
WSP6610A	10	66	23.0	173.00
WSP6612A	12	66	25.0	175.00
WSP6613A	13	66	26.0	174.00
WSP6616A	16	66	28.0	206.00
WSP7808A	8	78	20.0	174.00
WSP7809A	9	78	21.0	180.00
WSP7810A	10	78	22.0	185.00
WSP7812A	12	78	24.0	190.00
WSP7813A	13	78	25.0	194.00
WSP7816A	16	78	28.0	218.00
WSP8408A	8	84	22.0	184.00
WSP8409A	9	84	23.0	190.00
WSP8410A	10	84	24.0	195.00
WSP8412A	12	84	26.0	200.00
WSP8413A	13	84	27.0	212.00
WSP8416A	16	84	30.0	221.00
WSP9008A	8	90	23.0	192.00
WSP9009A	9	90	24.0	198.00
WSP9010A	10	90	25.0	197.00
WSP9012A	12	90	31.0	216.00
WSP9013A	13	90	29.0	222.00
WSP9016A	16	90	32.0	232.00
WSP9308A	8	93	29.0	230.00
WSP9309A	9	93	30.0	235.00
WSP9310A	10	93	31.0	242.00
WSP9312A	12	93	34.0	254.00
WSP9313A	13	93	35.0	261.00
WSP9316A	16	93	39.0	280.00

DOUBLE FACE

CAT. NO.	BASE DEPTH	HEIGHT	WT.	PRICE
WDP4216A	16	42	14.7	229.00
WDP4218A	18	42	15.6	233.00
WDP4220A	20	42	16.8	240.00
WDP4224A	24	42	18.9	247.00
WDP4226A	26	42	20.0	268.00
WDP4232A	32	42	23.0	285.00
WDP6616A	16	66	23.0	288.00
WDP6618A	18	66	24.0	296.00
WDP6620A	20	66	26.0	281.00
WDP6624A	24	66	29.0	336.00
WDP6626A	26	66	31.0	345.00
WDP6632A	32	66	36.0	372.00
WDP7816A	16	78	37.0	313.00
WDP7818A	18	78	29.0	322.00
WDP7820A	20	78	31.0	335.00
WDP7824A	24	78	45.0	325.00
WDP7826A	26	78	36.0	377.00
WDP7832A	32	78	49.0	408.00
WDP8416A	16	84	29.0	331.00
WDP8418A	18	84	31.0	342.00
WDP8420A	20	84	46.0	355.00
WDP8424A	24	84	37.0	378.00
WDP8426A	26	84	39.0	400.00
WDP8432A	32	84	45.0	433.00
WDP9016A	16	90	31.0	341.00
WDP9018A	18	90	33.0	352.00
WDP9020A	20	90	34.0	355.00
WDP9024A	24	90	52.0	391.00
WDP9026A	26	90	42.0	413.00
WDP9032A	32	90	48.0	454.00
WDP9316A	16	93	47.0	359.00
WDP9318A	18	93	50.0	370.00
WDP9320A	20	93	36.0	384.00
WDP9324A	24	93	41.0	414.00
WDP9326A	26	93	60.0	427.00
WDP9332A	32	93	68.0	467.00

Optional attaching brackets available for added stability; see page 22.

STEEL BACKS

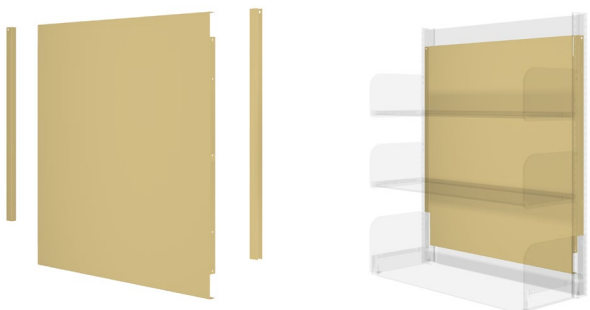

CAT. NO.	W	D	H	WT.	PRICE
WNB3042A	30	1	42	17.9	181.00
WNB3066A	30	1	66	30.0	283.00
WNB3078A	30	1	78	36.0	319.00
WNB3084A	30	1	84	39.0	331.00
WNB3090A	30	1	90	42.0	352.00
WNB3642A	36	1	42	21.0	181.00
WNB3666A	36	1	66	35.0	283.00
WNB3678A	36	1	78	42.0	319.00
WNB3684A	36	1	84	46.0	332.00
WNB3690A	36	1	90	49.0	352.00

24" wide backs are available at a 25% upcharge. Contact factory for weights.

PERIODICAL DISPLAY UNITS

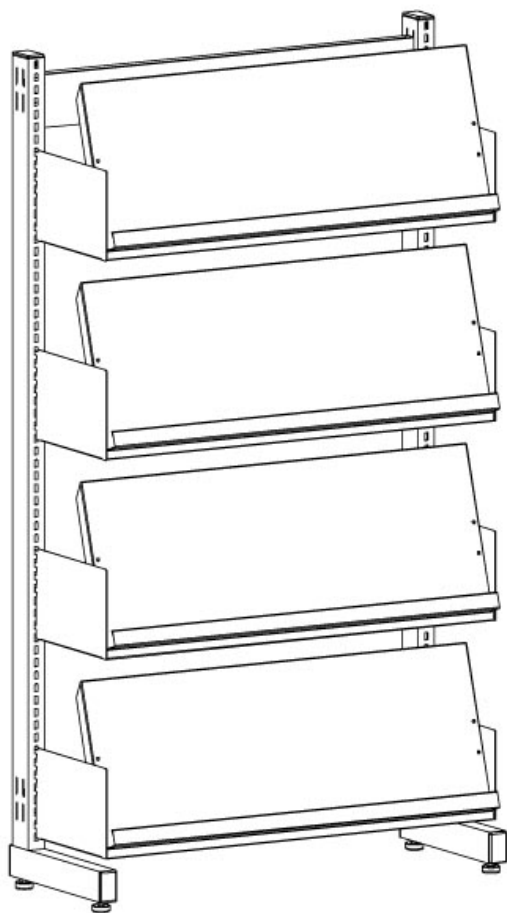

DP61120S

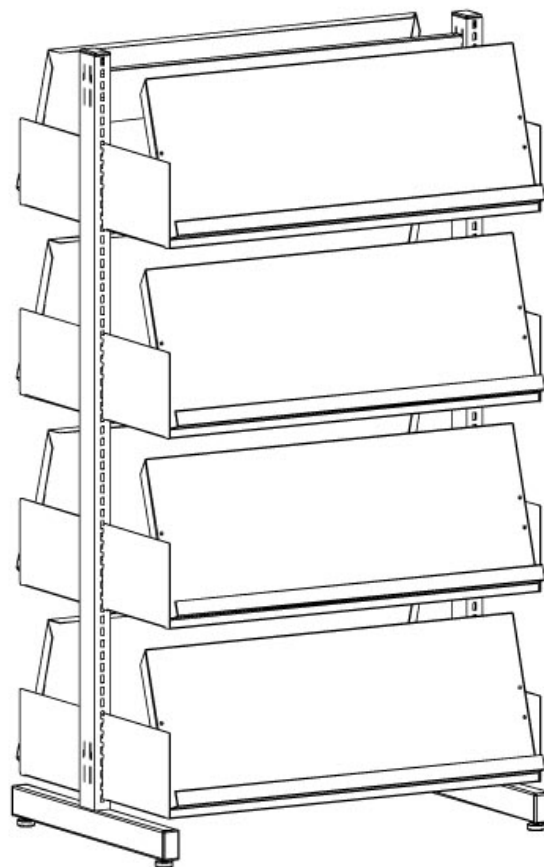

DP62120S

Designer Series

STARTER UNITS			ADDER UNITS			SLOPING SHELVES	STORAGE LEVELS	W	D	H
CAT. NO.	WT.	PRICE	CAT. NO.	WT.	PRICE					
SINGLE FACE*										
DP41120S3	80	952.00	DP41120A3	70	770.00	3	3	30	12	42
DP61120S3	105	1,176.00	DP61120A3	90	962.00	4	4	30	12	66
DP71120S3	125	1,365.00	DP71120A3	109	1,136.00	5	5	30	12	78
DP81120S3	144	1,508.00	DP81120A3	126	1,286.00	6	6	30	12	84
DP91120S3	146	1,554.00	DP91120A3	127	1,309.00	6	6	30	12	90
DP41120S	89	952.00	DP41120A	79	770.00	3	3	36	12	42
DP61120S	116	1,176.00	DP61120A	101	962.00	4	4	36	12	66
DP71120S	139	1,365.00	DP71120A	122	1,136.00	5	5	36	12	78
DP81120S	160	1,508.00	DP81120A	142	1,286.00	6	6	36	12	84
DP91120S	162	1,554.00	DP91120A	143	1,309.00	6	6	36	12	90
DOUBLE FACE										
DP42120S3	130	1,438.00	DP42120A3	119	1,251.00	6	6	30	24	42
DP62120S3	172	1,809.00	DP62120A3	156	1,595.00	8	8	30	24	66
DP72120S3	207	2,157.00	DP72120A3	189	1,927.00	10	10	30	24	78
DP82120S3	243	2,496.00	DP82120A3	223	2,255.00	12	12	30	24	84
DP92120S3	245	2,510.00	DP92120A3	224	2,262.00	12	12	30	24	90
DP42120S	146	1,438.00	DP42120A	135	1,251.00	6	6	36	24	42
DP62120S	193	1,809.00	DP62120A	177	1,595.00	8	8	36	24	66
DP72120S	233	2,157.00	DP72120A	215	1,927.00	10	10	36	24	78
DP82120S	274	2,496.00	DP82120A	254	2,255.00	12	12	36	24	84
DP92120S**	276	2,510.00	DP92120A**	255	2,262.00	12	12	36	24	90

* All single face shelving must be wall anchored.

** Overhead top bracing recommended.

NOTE: Canopy tops will not fit on 42" high units.

24" units are also available at a 25% upcharge. Contact factory for weights.
For 24" units, add "2" to the end of catalog number (e.g. DP62120S2)

SINGLE FACE*

*All single face shelving must be wall anchored.
Sway braces not included on single face units.



ED41080S

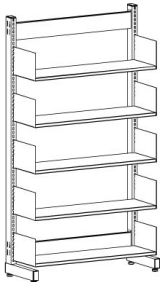

ED61080S

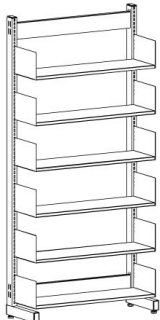

ED71080S

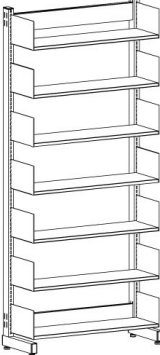

ED81080S

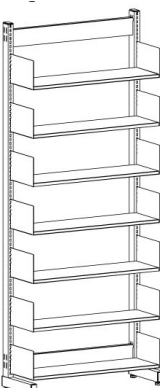

ED91080S

STARTER UNITS			ADDER UNITS			SHELF DEPTH	BASE DEPTH
CAT. NO.	WT.	PRICE	CAT. NO.	WT.	PRICE		
42" HIGH, 3 LEVELS							
ED41080S	53	585.00	ED41080A	44	409.00	8"	8"
ED41082S	56	603.00	ED41082A	46	424.00	8"	10"
ED41090S	56	635.00	ED41090A	46	452.00	9"	9"
ED41091S	57	619.00	ED41091A	47	440.00	9"	10"
ED41100S	59	596.00	ED41100A	49	423.00	10"	10"
ED41102S	61	606.00	ED41102A	50	430.00	10"	12"
ED41120S	63	615.00	ED41120A	52	439.00	12"	12"
66" HIGH, 5 LEVELS							
ED61080S	76	736.00	ED61080A	62	534.00	8"	8"
ED61082S	79	756.00	ED61082A	64	545.00	8"	10"
ED61090S	80	802.00	ED61090A	66	587.00	9"	9"
ED61091S	81	788.00	ED61091A	67	577.00	9"	10"
ED61100S	85	763.00	ED61100A	70	552.00	10"	10"
ED61102S	86	774.00	ED61102A	72	559.00	10"	12"
ED61120S	90	781.00	ED61120A	76	572.00	12"	12"
78" HIGH, 6 LEVELS							
ED71080S	88	812.00	ED71080A	72	593.00	8"	8"
ED71082S	90	830.00	ED71082A	74	603.00	8"	10"
ED71090S	93	886.00	ED71090A	76	654.00	9"	9"
ED71091S	94	870.00	ED71091A	77	643.00	9"	10"
ED71100S	98	839.00	ED71100A	81	612.00	10"	10"
ED71102S	100	838.00	ED71102A	83	614.00	10"	12"
ED71120S	105	861.00	ED71120A	88	637.00	12"	12"
84" HIGH, 7 LEVELS							
ED81080S	97	869.00	ED81080A	80	644.00	8"	8"
ED81082S	100	887.00	ED81082A	82	654.00	8"	10"
ED81090S	103	949.00	ED81090A	85	712.00	9"	9"
ED81091S	104	935.00	ED81091A	86	702.00	9"	10"
ED81100S	109	898.00	ED81100A	91	665.00	10"	10"
ED81102S	110	879.00	ED81102A	92	657.00	10"	12"
ED81120S	116	895.00	ED81120A	98	679.00	12"	12"
90" HIGH, 7 LEVELS							
ED91080S	99	885.00	ED91080A	81	652.00	8"	8"
ED91082S	102	901.00	ED91082A	83	661.00	8"	10"
ED91090S	105	933.00	ED91090A	86	704.00	9"	9"
ED91091S	106	949.00	ED91091A	87	709.00	9"	10"
ED91100S	111	912.00	ED91100A	92	672.00	10"	10"
ED91102S	113	925.00	ED91102A	93	680.00	10"	12"
ED91120S	119	941.00	ED91120A	99	702.00	12"	12"

30" wide units are available at the price listed. 24" wide units are available at a 25% upcharge. Contact factory for weights.
For 24" units, add "2" to end of catalog number (e.g. ED81080S2); for 30" units, add "3" (e.g. ED81080S3).

DOUBLE FACE



ED42080S

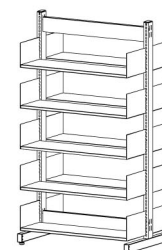

ED62080S

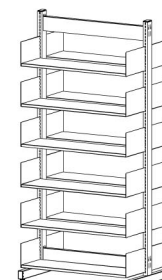

ED72080S

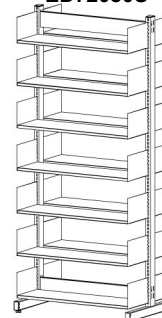

ED82080S

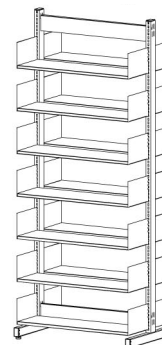

ED92080S

STARTER UNITS			ADDER UNITS			SHELF DEPTH	BASE DEPTH
CAT. NO.	WT.	PRICE	CAT. NO.	WT.	PRICE		
42" HIGH, 3 LEVELS							
ED42080S	77	744.00	ED42080A	66	559.00	8"	16"
ED42082S	81	740.00	ED42082A	70	559.00	8"	20"
ED42090S	82	780.00	ED42090A	71	601.00	9"	18"
ED42091S	84	772.00	ED42091A	73	591.00	9"	20"
ED42100S	87	736.00	ED42100A	76	560.00	10"	20"
ED42102S	90	768.00	ED42102A	78	581.00	10"	24"
ED42120S	94	776.00	ED42120A	82	594.00	12"	24"
66" HIGH, 5 LEVELS							
ED62080S	114	983.00	ED62080A	99	765.00	8"	16"
ED62082S	119	970.00	ED62082A	103	761.00	8"	20"
ED62090S	122	1,051.00	ED62090A	106	839.00	9"	18"
ED62091S	124	1,034.00	ED62091A	108	825.00	9"	20"
ED62100S	131	974.00	ED62100A	115	770.00	10"	20"
ED62102S	134	993.00	ED62102A	118	784.00	10"	24"
ED62120S	142	1,030.00	ED62120A	126	821.00	12"	24"
78" HIGH, 6 LEVELS							
ED72080S	133	1,104.00	ED72080A	116	870.00	8"	16"
ED72082S	137	1,084.00	ED72082A	119	861.00	8"	20"
ED72090S	142	1,186.00	ED72090A	124	959.00	9"	18"
ED72091S	144	1,164.00	ED72091A	126	941.00	9"	20"
ED72100S	152	1,102.00	ED72100A	134	879.00	10"	20"
ED72102S	155	1,125.00	ED72102A	136	895.00	10"	24"
ED72120S	165	1,160.00	ED72120A	146	936.00	12"	24"
84" HIGH, 7 LEVELS							
ED82080S	149	1,203.00	ED82080A	131	963.00	8"	16"
ED82082S	154	1,199.00	ED82082A	134	962.00	8"	20"
ED82090S	160	1,301.00	ED82090A	141	1,068.00	9"	18"
ED82091S	162	1,295.00	ED82091A	143	1,058.00	9"	20"
ED82100S	172	1,220.00	ED82100A	152	984.00	10"	20"
ED82102S	175	1,238.00	ED82102A	155	997.00	10"	24"
ED82120S	187	1,282.00	ED82120A	167	1,047.00	12"	24"
90" HIGH, 7 LEVELS							
ED92080S	152	1,219.00	ED92080A	132	971.00	8"	16"
ED92082S	158	1,215.00	ED92082A	137	970.00	8"	20"
ED92090S	162	1,315.00	ED92090A	142	1,075.00	9"	18"
ED92091S	166	1,311.00	ED92091A	145	1,066.00	9"	20"
ED92100S	176	1,236.00	ED92100A	155	992.00	10"	20"
ED92102S	178	1,252.00	ED92102A	157	1,004.00	10"	24"
ED92120S	190	1,307.00	ED92120A	169	1,059.00	12"	24"

30" wide units are available at the price listed. 24" wide units are available at a 25% upcharge. Contact factory for weights.
For 24" units, add "2" to end of catalog number (e.g. ED82080S2); for 30" units, add "3" (e.g. ED82080S3).

SINGLE FACE*

*All single face shelving must be wall anchored.
Sway braces not included on single face units.



DD41100S

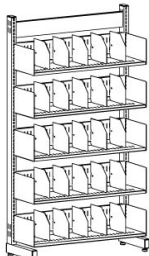

DD61100S

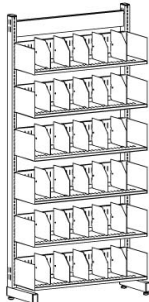

DD71100S

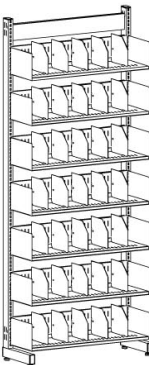

DD91100S

STARTER UNITS			ADDER UNITS			SHELF DEPTH	BASE DEPTH
CAT. NO.	WT.	PRICE	CAT. NO.	WT.	PRICE		
42" HIGH, 3 LEVELS							
DD41100S	75	778.00	DD41100A	65	599.00	10"	10"
DD41102S	77	770.00	DD41102A	67	589.00	10"	12"
DD41103S	80	782.00	DD41103A	69	601.00	10"	13"
DD41120S	80	743.00	DD41120A	70	561.00	12"	12"
DD41130S	82	751.00	DD41130A	72	570.00	13"	13"
DD41133S	88	782.00	DD41133A	77	607.00	13"	16"
66" HIGH, 5 LEVELS							
DD61100S	112	1,049.00	DD61100A	98	837.00	10"	10"
DD61102S	114	1,041.00	DD61102A	100	827.00	10"	12"
DD61103S	117	1,053.00	DD61103A	102	839.00	10"	13"
DD61120S	119	987.00	DD61120A	105	772.00	12"	12"
DD61130S	123	1,001.00	DD61130A	108	786.00	13"	13"
DD61133S	128	1,045.00	DD61133A	113	831.00	13"	16"
78" HIGH, 6 LEVELS							
DD71100S	131	1,181.00	DD71100A	114	955.00	10"	10"
DD71102S	133	1,174.00	DD71102A	116	944.00	10"	12"
DD71103S	135	1,186.00	DD71103A	118	956.00	10"	13"
DD71120S	139	1,106.00	DD71120A	122	876.00	12"	12"
DD71130S	144	1,122.00	DD71130A	127	893.00	13"	13"
DD71133S	149	1,155.00	DD71133A	131	931.00	13"	16"
84" HIGH, 7 LEVELS							
DD81100S	147	1,298.00	DD81100A	129	1,064.00	10"	10"
DD81102S	149	1,260.00	DD81102A	131	1,039.00	10"	12"
DD81103S	152	1,302.00	DD81103A	134	1,066.00	10"	13"
DD81120S	157	1,178.00	DD81120A	139	957.00	12"	12"
DD81130S	162	1,228.00	DD81130A	144	992.00	13"	13"
DD81133S	167	1,232.00	DD81133A	149	1,016.00	13"	16"
90" HIGH, 7 LEVELS							
DD91100S	149	1,312.00	DD91100A	131	1,071.00	10"	10"
DD91102S	151	1,306.00	DD91102A	132	1,062.00	10"	12"
DD91103S	154	1,390.00	DD91103A	135	1,110.00	10"	13"
DD91120S	159	1,224.00	DD91120A	140	980.00	12"	12"
DD91130S	164	1,316.00	DD91130A	145	1,036.00	13"	13"
DD91133S	170	1,254.00	DD91133A	150	1,027.00	13"	16"

30" wide units are available at the price listed. 24" wide units are available at a 25% upcharge. Contact factory for weights.
For 24" units, add "2" to end of catalog number (e.g. DD81100S2); for 30" units, add "3" (e.g. DD81100S3).

All divider units come with 5 dividers per shelf. Dividers are adjustable on 1" centers.

DOUBLE FACE



DD42100S

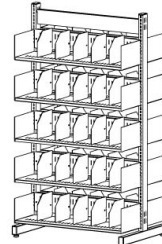

DD62100S

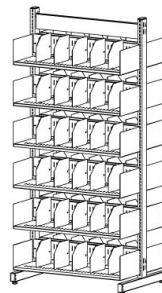

DD72100S

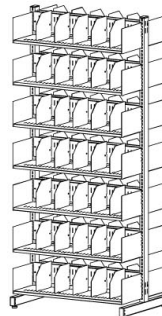

DD82100S

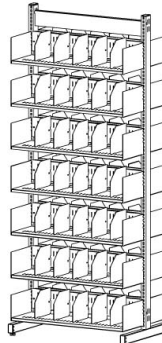

DD92100S

STARTER UNITS			ADDER UNITS			SHELF DEPTH	BASE DEPTH
CAT. NO.	WT.	PRICE	CAT. NO.	WT.	PRICE		
42" HIGH, 3 LEVELS							
DD42100S	120	1,090.00	DD42100A	109	908.00	10"	20"
DD42102S	123	1,075.00	DD42102A	112	887.00	10"	24"
DD42103S	128	1,133.00	DD42103A	116	929.00	10"	26"
DD42120S	128	1,009.00	DD42120A	117	827.00	12"	24"
DD42130S	133	1,071.00	DD42130A	121	867.00	13"	26"
DD42133S	142	1,166.00	DD42133A	130	958.00	13"	32"
66" HIGH, 5 LEVELS							
DD62100S	186	1,556.00	DD62100A	170	1,346.00	10"	20"
DD62102S	190	1,539.00	DD62102A	173	1,324.00	10"	24"
DD62103S	195	1,607.00	DD62103A	178	1,371.00	10"	26"
DD62120S	200	1,430.00	DD62120A	184	1,215.00	12"	24"
DD62130S	208	1,502.00	DD62130A	191	1,265.00	13"	26"
DD62133S	218	1,596.00	DD62133A	200	1,357.00	13"	32"
78" HIGH, 6 LEVELS							
DD72100S	218	1,787.00	DD72100A	200	1,564.00	10"	20"
DD72102S	221	1,774.00	DD72102A	203	1,544.00	10"	24"
DD72103S	226	1,846.00	DD72103A	207	1,593.00	10"	26"
DD72120S	234	1,638.00	DD72120A	216	1,408.00	12"	24"
DD72130S	243	1,719.00	DD72130A	224	1,466.00	13"	26"
DD72133S	251	1,814.00	DD72133A	233	1,557.00	13"	32"
84" HIGH, 7 LEVELS							
DD82100S	249	2,020.00	DD82100A	229	1,783.00	10"	20"
DD82102S	253	2,001.00	DD82102A	233	1,760.00	10"	24"
DD82103S	258	2,063.00	DD82103A	238	1,804.00	10"	26"
DD82120S	269	1,837.00	DD82120A	249	1,597.00	12"	24"
DD82130S	279	1,915.00	DD82130A	259	1,655.00	13"	26"
DD82133S	289	2,007.00	DD82133A	268	1,746.00	13"	32"
90" HIGH, 7 LEVELS							
DD92100S	253	2,036.00	DD92100A	232	1,791.00	10"	20"
DD92102S	255	2,015.00	DD92102A	234	1,767.00	10"	24"
DD92103S	260	2,079.00	DD92103A	239	1,812.00	10"	26"
DD92120S	271	1,851.00	DD92120A	250	1,604.00	12"	24"
DD92130S	281	1,931.00	DD92130A	260	1,663.00	13"	26"
DD92133S	291	2,025.00	DD92133A	269	1,755.00	13"	32"

30" wide units are available at the price listed. 24" wide units are available at a 25% upcharge. Contact factory for weights. For 24" units, add "2" to end of catalog number (e.g. DD82100S2); for 30" units, add "3" (e.g. DD82100S3).

All divider units come with 5 dividers per shelf. Dividers are adjustable on 1" centers.

UPRIGHTS

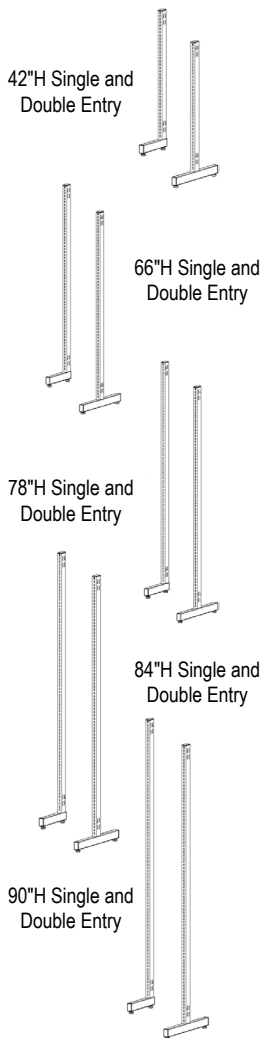

Uprights are sold individually.
For seismic application, contact factory.

SINGLE ENTRY				DOUBLE ENTRY			
CAT. NO.	WT.	DEPTH	PRICE	CAT. NO.	WT.	DEPTH	PRICE
42" HIGH							
EDSUPT4208	9.3	8"	165.00	EDDUPT4208	10.6	16"	180.00
EDSUPT4209	9.5	9"	178.00	EDDUPT4209	10.8	18"	174.00
EDSUPT4210	9.7	10"	173.00	EDDUPT4210	11.0	20"	176.00
EDSUPT4211	9.9	11"	182.00	EDDUPT4211	11.1	22"	176.00
EDSUPT4212	10.1	12"	176.00	EDDUPT4212	11.3	24"	182.00
EDSUPT4213	10.2	13"	176.00	EDDUPT4213	11.5	26"	199.00
EDSUPT4216	10.9	16"	169.00	EDDUPT4216	12.1	32"	202.00
66" HIGH							
EDSUPT6608	13.6	8"	197.00	EDDUPT6608	14.9	16"	212.00
EDSUPT6609	13.8	9"	210.00	EDDUPT6609	15.3	18"	206.00
EDSUPT6610	14.0	10"	206.00	EDDUPT6610	15.6	20"	204.00
EDSUPT6611	14.2	11"	215.00	EDDUPT6611	16.0	22"	208.00
EDSUPT6612	14.4	12"	209.00	EDDUPT6612	16.4	24"	209.00
EDSUPT6613	14.6	13"	209.00	EDDUPT6613	16.8	26"	231.00
EDSUPT6616	15.2	16"	209.00	EDDUPT6616	17.9	32"	234.00
78" HIGH							
EDSUPT7808	15.9	8"	213.00	EDDUPT7808	17.2	16"	229.00
EDSUPT7809	16.1	9"	226.00	EDDUPT7809	17.4	18"	222.00
EDSUPT7810	16.3	10"	221.00	EDDUPT7810	17.6	20"	217.00
EDSUPT7811	16.5	11"	230.00	EDDUPT7811	17.8	22"	223.00
EDSUPT7812	16.7	12"	224.00	EDDUPT7812	18.0	24"	224.00
EDSUPT7813	16.9	13"	224.00	EDDUPT7813	18.1	26"	248.00
EDSUPT7816	17.5	16"	218.00	EDDUPT7816	18.3	32"	251.00
84" HIGH							
EDSUPT8408	17.0	8"	220.00	EDDUPT8408	18.3	16"	235.00
EDSUPT8409	17.2	9"	232.00	EDDUPT8409	18.7	18"	228.00
EDSUPT8410	17.4	10"	228.00	EDDUPT8410	18.9	20"	231.00
EDSUPT8411	17.6	11"	237.00	EDDUPT8411	19.1	22"	230.00
EDSUPT8412	17.8	12"	216.00	EDDUPT8412	19.8	24"	235.00
EDSUPT8413	18.0	13"	231.00	EDDUPT8413	20.0	26"	254.00
EDSUPT8416	18.6	16"	211.00	EDDUPT8416	21.0	32"	256.00
90" HIGH							
EDSUPT9008	18.1	8"	228.00	EDDUPT9008	19.4	16"	243.00
EDSUPT9009	18.3	9"	224.00	EDDUPT9009	19.7	18"	235.00
EDSUPT9010	18.5	10"	235.00	EDDUPT9010	21.0	20"	239.00
EDSUPT9011	18.7	11"	244.00	EDDUPT9011	21.0	22"	233.00
EDSUPT9012	18.9	12"	239.00	EDDUPT9012	21.0	24"	242.00
EDSUPT9013	19.0	13"	275.00	EDDUPT9013	21.0	26"	262.00
EDSUPT9016	19.7	16"	222.00	EDDUPT9016	22.0	32"	265.00

UPRIGHT EXTENDER



Add to existing frames for more space. Available in a variety of sizes with a 12" minimum. Contact factory for pricing & weights on sizes not shown.

CAT. NO.	W	D	H	WT.	PRICE
DUPTTEXT18A	—	2 1/2	18	3.7	148.00
DUPTTEXT24A	—	2 1/2	24	4.6	153.00
DUPTTEXT30A	—	2 1/2	30	5.6	158.00
DUPTTEXTxxA	—	2 1/2	Varies	Varies	Call Factory

SEISMIC SWAY BRACES

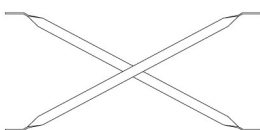

CAT. NO.	DESCRIPTION	W	D	H	WT.	PRICE
SSBR6030A	For 66" and 78" frames	30	1	58	4.5	64.00
SSBR7330A	For 84", 90" and 93" frames	30	1	73	5.9	73.00
SSBR6036A	For 66" and 78" frames	36	1	58	4.5	64.00
SSBR7336A	For 84", 90" and 93" frames	36	1	73	5.9	73.00

Provides support for uprights. Sway braces come in pairs and include two tumbuckles with hooklegs.

FLOOR ANCHOR

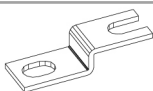

Used to aid in the leveling of fixed base units. Zinc finish.

CAT. NO.	W	D	H	WT.	PRICE
DFLRANCH3	1	3	5/8	0.1	2.40

ADJUSTABLE SHELVES



CAT. NO.	W	D	H	WT.	PRICE
ED3008A	30	8	13/16	6.3	43.00
ED3009A	30	9	13/16	6.9	48.00
ED3010A	30	10	13/16	7.6	45.00
ED3011A	30	11	13/16	8.4	48.00
ED3012A	30	12	13/16	8.4	50.00
ED3013A	30	13	13/16	9.9	59.00
ED3014A	30	14	13/16	10.5	98.00
ED3016A	30	16	13/16	11.9	107.00

CAT. NO.	W	D	H	WT.	PRICE
ED3608A	36	8	13/16	7.1	44.00
ED3609A	36	9	13/16	7.8	52.00
ED3610A	36	10	13/16	8.6	45.00
ED3611A	36	11	13/16	9.5	48.00
ED3612A	36	12	13/16	9.6	50.00
ED3613A	36	13	13/16	11.1	59.00
ED3614A	36	14	13/16	11.8	98.00
ED3616A	36	16	13/16	13.4	107.00

Includes shelf brackets. Can be furnished in additional widths or depths; contact factory for pricing.

ADJUSTABLE DIVIDER SHELVES

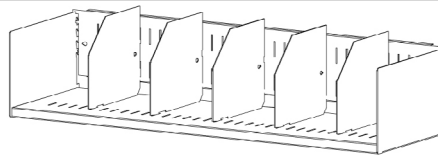

CAT. NO.	W	D	H	WT.	PRICE
DDS3010A	30	10	13/16	12.8	82.00
DDS3011A	30	11	13/16	14.4	84.00
DDS3012A	30	12	13/16	14.9	89.00
DDS3013A	30	13	13/16	14.6	92.00
DDS3016A	30	16	13/16	20.0	138.00

CAT. NO.	W	D	H	WT.	PRICE
DDS3610A	36	10	13/16	14.1	103.00
DDS3611A	36	11	13/16	15.9	84.00
DDS3612A	36	12	13/16	15.4	89.00
DDS3613A	36	13	13/16	16.1	92.00
DDS3616A	36	16	13/16	20.0	136.00

Slotted on 1" centers to accommodate dividers. Includes 5" back, brackets and 5 dividers per shelf.

DIVIDERS

CAT. NO.	USE WITH	D	H	WT.	PRICE
DIV07	7"- 9" Shelves	7	6	0.4	2.40
DIV09	10" through 13"	9	7 1/2	0.7	3.30
DIV12	14" through 16"	12	7 1/2	1.0	5.20
SPD12	14" through 16"	9	12	1.6	12.10



DIV07



DIV09

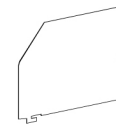

DIV12



SPD12

SHELF BRACKETS

CAT. NO.	W	D	H	WT.	PRICE
DSBRK08L*	1/4	8	7 1/2	1.1	7.80
DSBRK09L*	1/4	9	7 1/2	1.2	8.30
DSBRK10L*	1/4	10	7 1/2	1.3	7.20
DSBRK11L*	1/4	11	7 1/2	1.5	6.80
DSBRK12L*	1/4	12	7 1/2	1.3	7.50
DSBRK13L*	1/4	13	7 1/2	1.8	10.10
DSBRK14L*	1/4	14	7 1/2	1.9	29.00
DSBRK16L*	1/4	16	7 1/2	2.2	31.00

LEFT BRACKET*

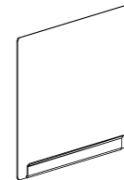

RIGHT BRACKET

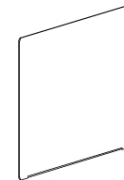

Attaches shelves to unit uprights. *NOTE: Listed catalog numbers are for left bracket only; for right bracket, change the suffix "L" to "R".

TOP AND BOTTOM STRUTS

CAT. NO.	W	D	H	WT.	PRICE
DSTRUT24	24	1	4 3/8	4.5	70.00
DSTRUT30	30	1	4 3/8	6.0	56.00
DSTRUT36	36	1	4 3/8	6.5	56.00



Used to connect two uprights.

CABINETS

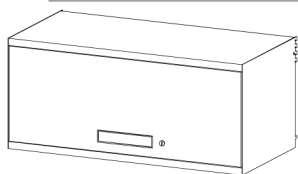

CABINET ONLY

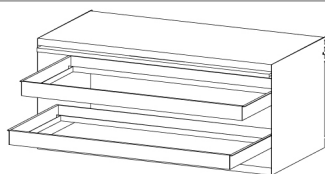

CABINET WITH 2 PULL-OUT FRAMES

All welded construction. Ideal for storing valuable items that need to be secured. Includes flipper door and lock with two keys.

CAT. NO.	W	D	H	WT.	PRICE
CABINET ONLY					
FDCB36L	36	17 5/8	15 1/2	53.0	1,248.00
CABINET WITH 1 PULL-OUT FRAME					
CBFD36LFA	36	17 5/8	15 1/2	63.0	1,248.00
CABINET WITH 2 PULL-OUT FRAMES					
CBFD36L2FA	36	17 5/8	15 1/2	73.0	1,248.00
FRAME ONLY					
FRAME36A	36	16	2	10.1	517.00

MEDIA HANGER RACK



Consists of brackets with hanger rod for clear-view plastic media bags.

CAT. NO.	W	D	H	WT.	PRICE
HB30A	30	6 1/2	4 1/4	2.1	84.00
HB36A	36	6 1/2	4 1/4	2.1	84.00

WORK SHELF AND BRACKETS

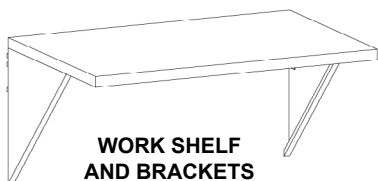

WORK SHELF AND BRACKETS

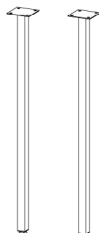

LEGS

CAT. NO.	W	D	H	WT.	PRICE
LC54A	36	24	27 1/2	30.0	1,003.00
LCL (Legs Only, Per Pair)				3.0	109.00
LCBRK24L (Left Bracket Only)				3.6	118.00
LCBRK24R (Right Bracket Only)				3.6	118.00

24" deep plastic shelf supported by two steel triangular brackets for work surface with shelving range. Must state desired finish of work shelf.

METAL TRAYS

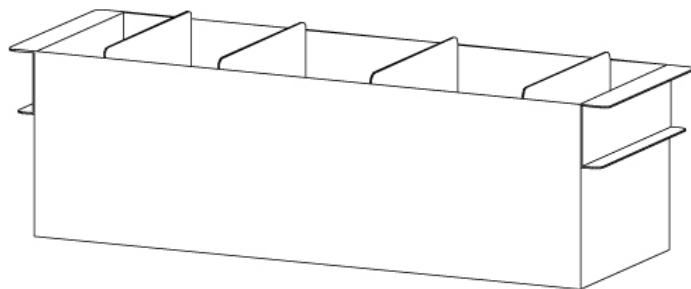

Handy metal trays store a wide variety of media. Use alone or in conjunction with Estey cabinets.

CAT. NO.	W	D	H	WT.	PRICE
FOR COMPACT DISCS					
TRCD514A	5 1/16	14 3/8	4 1/2	4.4	273.00
CDD-1 (Divider Only)				0.2	27.00
FOR AUDIOCASSETTES					
TRAC414A	4 7/16	14 3/8	3 1/8	3.3	386.00
ACD-1 (Divider Only)				0.2	36.00
FOR VHS TAPES					
TRVHS714A	7 5/8	14 3/8	3 1/8	5.1	299.00
VHSD-1 (Divider Only)				0.3	28.00
FOR MICRO FICHE					
TRMF614A	6 3/16	14 3/8	3 1/2	5.6	346.00
MFD-1 (Divider Only)				0.3	43.00
FOR 3x5 CARDS					
TRCRD3X5A	5 3/16	14 3/8	3 1/2	3.9	433.00
CRDD-1 (Divider Only)				0.2	56.00

PRINCETON FILE



KDPRBOXA

KDPRBOX1PA
(with Plexiglass Front)

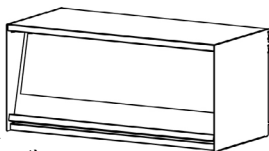

CAT. NO.	W	D	H	WT.	PRICE
KDPRBOXA	36	16	16	41.0	525.00
KDPRBOX1PA	36	16	16	47.0	690.00

Displays periodicals while allowing for storage of back issues.

NEWSPAPER RACK

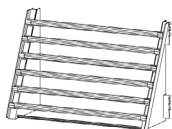

CAT. NO.	TYPE	W	D	H	WT.	PRICE
NPR6	6 Holders	36	12	14	9.6	951.00
NPR10	10 Holders	36	12	22	15.2	1,403.00

Displays newspapers. Newspaper sticks included.

HINGED PERIODICAL DISPLAY SHELVES

CAT. NO.	W	D	H	WT.	PRICE
DPDS3012A	30	12	14	15.9	159.00
DPDS3612A	36	12	14	18.4	159.00
DPDS3012ACLH*	30	12	14	15.3	179.00
DPDS3012ACLH*	36	12	14	18.4	179.00
WITH PLEXIGLASS COVER					
DPDSCA30	30	12	14	22.0	285.00
DPDSCA	36	12	14	23.0	285.00

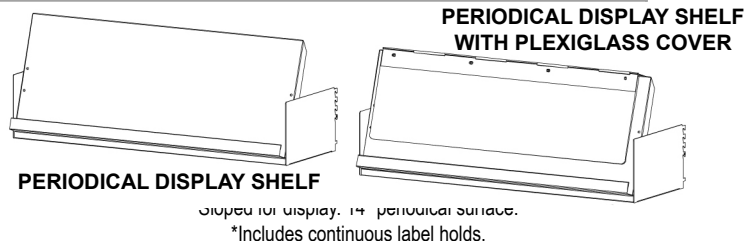

FIXED SLOPED DISPLAY SHELVES

CAT. NO.	W	D	H	WT.	PRICE
SDS3012A	30	12	12	7.3	77.00
SDS3612A	36	12	12	9.6	77.00
SDS3012ACLH*	30	12	12	13.1	124.00
SDS3012ACLH*	36	12	12	9.2	124.00
WITH PLEXIGLASS COVER					
SDSCA30	30	12	12	11.8	215.00
SDSCA	36	12	12	11.8	215.00

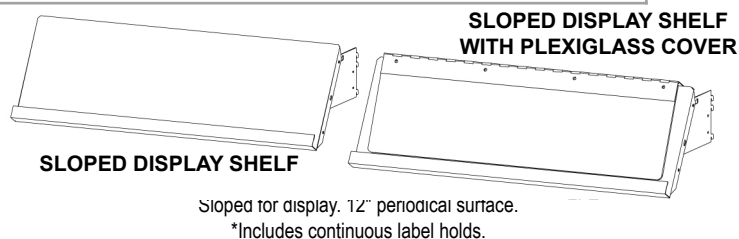

STORAGE SHELVES

CAT. NO.	W	D	H	WT.	PRICE
DIN3610A	36	10	13/16	7.0	71.00
DIN3612A	36	12	13/16	8.2	77.00
DIN3613A	36	13	13/16	8.7	81.00
DIN3614A	36	14	13/16	9.6	84.00
DIN3616A	36	16	13/16	10.6	93.00
DIN3618A	36	18	13/16	11.8	127.00
DIN3619A	36	19	13/16	12.5	128.00

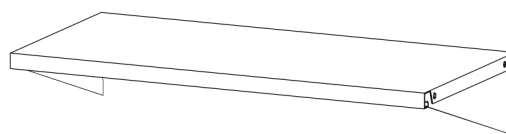

Used with sloped display shelves or any place where a flat shelf is desired. For 30" shelf, change "DIN36" to "DIN30" (e.g. DIN3010A).

INTEGRAL BACK SHELVES

CAT. NO.	W	D	H	WT.	PRICE
DBLIB3608A	36	8	13/16	7.8	55.00
DBLIB3609A	36	9	13/16	8.5	60.00
DBLIB3610A	36	10	13/16	9.1	58.00
DBLIB3611A	36	11	13/16	10.1	60.00
DBLIB3612A	36	12	13/16	10.4	65.00
DBLIB3613A	36	13	13/16	11.7	76.00
DBLIB3616A	36	16	13/16	13.9	125.00

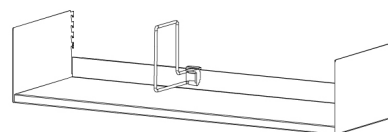

Built-in 2" backstop keeps items organized. Includes brackets and one wire divider per shelf. For 30" shelf, change "DBLIB36" to "DBLIB30" (e.g. DBLIB3016A).

METAL BROWSING BOX

CAT. NO.	W	D	H	WT.	PRICE
HDBRB3611A	30	15 1/16	5 1/2	16.3	390.00
HDBRB3614A	36	15 1/16	5 1/2	20.0	429.00
BRBWD (Divider Only)				0.1	8.70

Ideal for storing all media items. Includes 2 wire dividers.

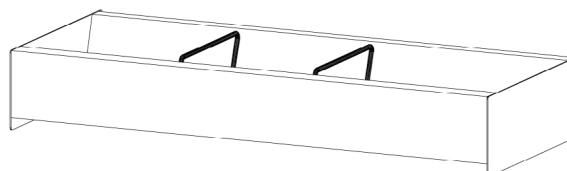

PULL-OUT BROWSING BOX

CAT. NO.	W	D	H	WT.	PRICE
XHDBRB3611A	30	12	5 1/2	31.1	661.00
XHDBRB3614A	36	15 1/16	5 1/2	37.0	690.00

24" and 30" sizes also available; call factory for pricing and weights.



Ideal for storing all media items in a high capacity environment. Multiple boxes can be placed on top of one another while retaining accessibility to stored items.

SLIDING REFERENCE SHELVES

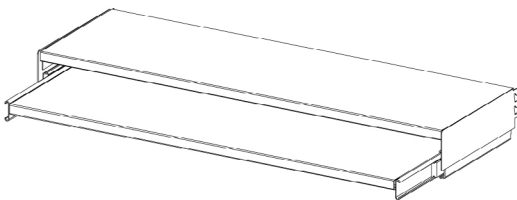

Sturdy full extension slides attach to underside of adjustable shelf.
Use two reference shelves for double face units.

CAT. NO.	W	D	H	WT.	PRICE
DSRS3008A	30	8	3	13.7	303.00
DSRS3009A	30	9	3	16.0	273.00
DSRS3010A	30	10	3	19.6	303.00
DSRS3012A	30	12	3	23.0	297.00
DSRS3608A	36	8	3	15.1	303.00
DSRS3609A	36	9	3	17.7	273.00
DSRS3610A	36	10	3	13.5	303.00
DSRS3612A	36	12	3	8.0	298.00

ZIG-ZAG SHELF

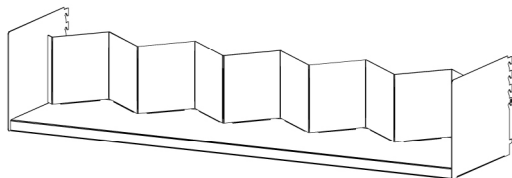

Adjustable shelf with paperback insert. Ideal for displaying audio cassette or paperback books.

CAT. NO.	W	D	H	WT.	PRICE
DZZ3008A	30	7	5 13/16	10.4	104.00
DZZ3608A	36	7	5 13/16	11.2	105.00
INSERT ONLY					
ZZPD	36	18	5	3.8	60.00

DOUBLE TIER BROWSING BOX

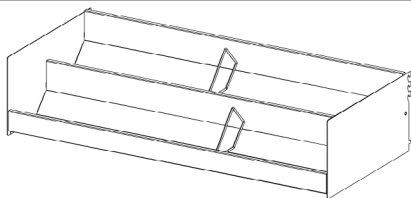

CAT. NO.	W	D	H	WT.	PRICE
DTBRB36A	36	16	8	21.0	447.00
WIRE DIVIDER					
DTWD	—	—	—	.2	5.70

Two levels of storage for all media items.
Holds 168 cassette tapes, 56 VHS videotapes or 156 compact discs

VIDEO CASSETTE/PAPERBACK BOOK SHELF

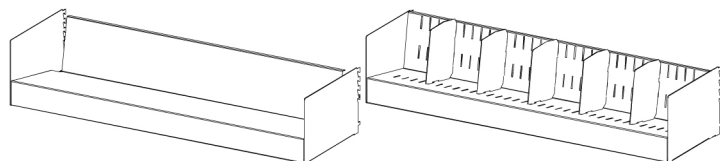

**WITH NO
DIVIDER SLOTS**

**WITH SLOTS AND
FIVE DIVIDERS**

Slopes to allow convenient viewing of spines on paperbacks and video cassettes.
30" w size also available; call factory for pricing.

CAT. NO.	W	D	H	WT.	PRICE
WITH NO SLOTS FOR DIVIDERS					
DVCS3609A	36	9	7 1/2	9.9	83.00
DVCS3610A	36	10	7 1/2	10.2	85.00
DVCS3612A	36	12	7 1/2	12.2	93.00
WITH SLOTS AND FIVE DIVIDERS					
DDVCS3609A	36	9	7 1/2	11.9	95.00
DDVCS3610A	36	10	7 1/2	12.6	95.00
DDVCS3612A	36	12	7 1/2	15.7	110.00
DIVIDER ONLY					
DIV07	(for 9" deep shelves only)			0.4	2.40
DIV09	(for 10" & 12" deep shelves only)			0.7	3.30

MICROFILM/AUDIO CASSETTE SHELF



CAT. NO.	W	D	H	WT.	PRICE
DSPMF30A	30	10	7 1/2	12.3	235.00
DSPMF36A	36	10	7 1/2	12.3	235.00

For storing microfilm or audio cassettes. Capacity: 100 cassettes (36" w shelf).

DOUBLE TIER VIDEO CASSETTE SHELF

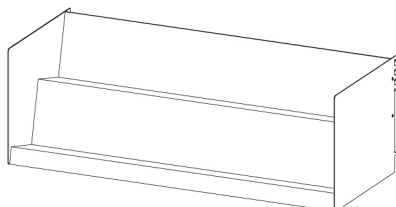

CAT. NO.	W	D	H	WT.	PRICE
VCDT3014	30	14	12	20.0	204.00
VCDT3614	36	14	12	20.0	204.00

Use with compact discs, video cassettes or paperbacks. Sloped; 36" wide shelf holds 60 VHS videotapes or 160 compact discs.

BOOK SUPPORTS

CAT. NO.	W	D	H	WT.	PRICE
WITH CORK BACKING					
BSN6	4 9/16	5 1/2	6	0.6	6.80
BSN9	4 9/16	5 1/2	9	1.1	8.20
WITH MAGNETIC STRIP					
BSM6	4 9/16	5 1/2	6	1.0	6.80
BSM9	4 9/16	5 1/2	9	1.1	8.20

Unattached book support used on surface of shelves.
Furnished with cork backing or a magnetic strip, as specified above.

CAT. NO.	W	D	H	WT.	PRICE
LOBS6	4 9/16	1 3/4	6	0.6	9.30
LOBS9	4 9/16	1 3/4	9	1.2	10.20

Hooks onto return flange of adjustable shelves for rigid support.

CAT. NO.	TYPE	W	D	H	WT.	PRICE
WBS6	"V"	3/16	—	6	0.2	4.40
WBS9	"V"	3/16	—	9	0.3	4.90
WBSW7	"W"	3/16	—	7	0.3	5.80
WBSW9	"W"	3/16	—	9	0.4	6.80

Heavy spring wire book support. Attaches to underside of shelf. Easily adjustable.

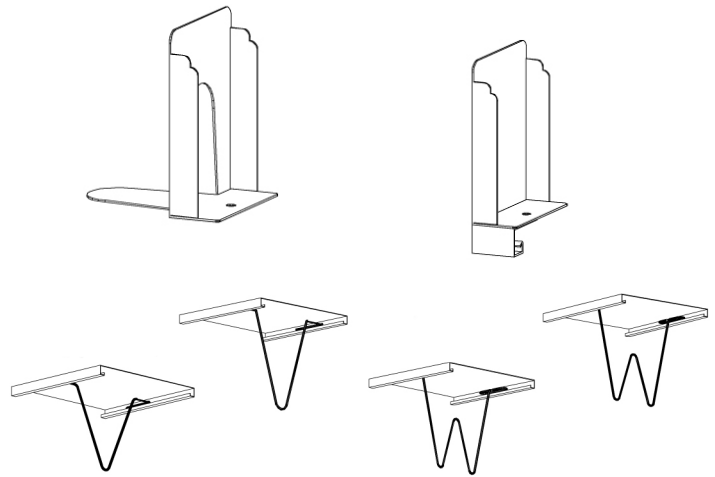

NOTE: Dividers are shown attached to shelves for clarification purposes only; shelves must be ordered separately

SHELF FILLER

CAT. NO.	W	D	H	WT.	PRICE
SHFIL30	27	2	1	2.3	34.00
SHFIL36	33	2	1	2.6	34.00

Fills the space between adjustable shelves on double sided units, providing a continuous surface. Attaches with two clips that fasten to underside of shelves.

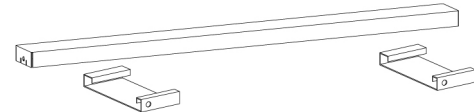

REVERSIBLE BACKSTOP – WIRE DIVIDER

CAT. NO.	W	D	H	WT.	PRICE
BACK STOP					
RBS30	30	7/16	2	1.2	8.40
RBS36	36	7/16	2	1.3	8.40
WIRE DIVIDER					
BSWBS	—	8 1/2	4	0.2	4.10

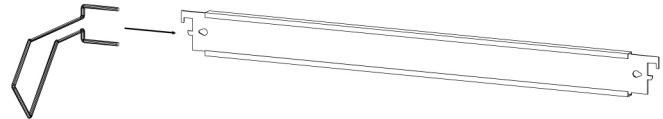

One side is a regular backstop. The other side is a sliding support backstop (when used with wire divider sold above).

OFFSET CENTER BACKSTOP – LARGE PROFILE

CAT. NO.	W	D	H	WT.	PRICE
CBS30	30	3/8	3 9/32	1.7	26.00
CBS36	36	3/8	3 9/32	2.1	26.00

Works as a backstop for each side of a double entry unit, eliminating the need for an individual backstop for each side.

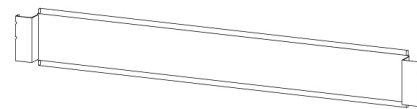

OFFSET CENTER BACKSTOP – SMALL PROFILE

CAT. NO.	W	D	H	WT.	PRICE
CBSS30	30	7/16	2	1.4	11.70
CBSS36	36	7/16	2	1.6	11.70

Works as a backstop for each side of a double entry unit, eliminating the need for an individual backstop for each side.

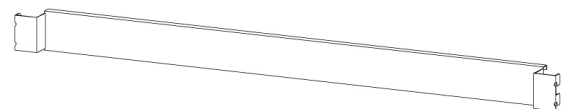

KICK PLATE

CAT. NO.	W	D	H	WT.	PRICE
DKP24A	24	2 1/2	1	0.9	24.00
DKP30A	30	2 1/2	1	1.0	19.40
DKP36A	36	2 1/2	1	1.4	19.40

Prevents items from rolling beneath shelves.

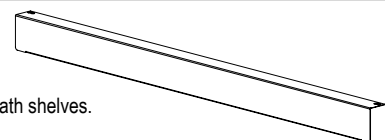

WALL HUNG COLUMNS



Slotted strip attaches to wall. Designed to accept all components or accessory items. Special heights available. Hardware not included because of various wall construction.

CAT. NO.	W	D	H	WT.	PRICE
DPILWCH24	1 1/2	1	24	1.4	51.00
DPILWCH30	1 1/2	1	30	1.8	52.00
DPILWCH42	1 1/2	1	42	2.5	55.00
DPILWCH54	1 1/2	1	54	3.2	59.00
DPILWCH60	1 1/2	1	60	3.6	61.00
DPILWCH66	1 1/2	1	66	3.9	63.00
DPILWCH72	1 1/2	1	72	4.3	65.00
DPILWCH78	1 1/2	1	78	4.6	66.00
DPILWCH84	1 1/2	1	84	5.0	68.00
DPILWCH90	1 1/2	1	90	5.3	69.00

CARD HOLDERS

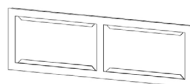

For 3" x 5" cards. Used on end panels. Attaches with double-sided tape. Steel holders are finished in black powder coat paint.

CAT. NO.	W	D	H	WT.	PRICE
SINGLE CARD HOLDER					
SCH-B	5 1/4	—	3 1/8	0.1	2.80
DOUBLE CARD HOLDER					
DCH-B	10 1/4	—	3 1/8	0.2	5.10
ALUMINUM HOLDER					
SCH-CA	5 5/8	—	3 1/2	0.1	3.30

TRANSVERSE OVERHEAD TOP TIE BRACING

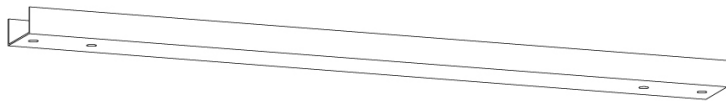

CAT. NO.	W	D	H	WT.	PRICE
OTBW9	96	2	7/8	5.7	36.00

Channel construction top tie furnished in 8 foot lengths. Recommended for added stabilization when bases and shelves are of equal depths.

SHELF LABEL HOLDER



Plastic clip-on holder 5/8" x 5" card. (Paper not included)

CAT. NO.	W	D	H	WT.	PRICE
SLH	5 1/2	2	3 3/4	0.1	1.10

WALL CLIP

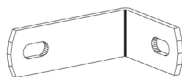

Used to attach single face units to the wall for support. Wall hardware not included.

CAT. NO.	W	D	H	WT.	PRICE
WCLIP	3	2	1	0.2	1.10

RANGE FINDER

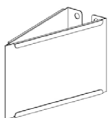

For use on end panels or uprights for identification of range contents. Attaches with double-sided tape. Holds two 3" x 5" cards. Finished in black.

CAT. NO.	W	D	H	WT.	PRICE
RFP6	—	6 3/4	3 1/8	0.2	5.00

WALL FILLERS

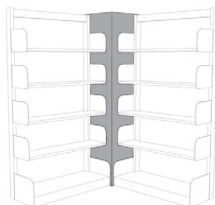

SCFhddA

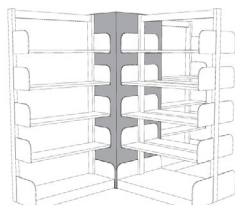

DCFhddA

Specify height and depth (hdd) when ordering.

CAT. NO.	HEIGHTS	DEPTHS	WT.	PRICE
CORNER FILLER*				
SCFhddA	42" to 93"	8" to 32"		CALL FACTORY
INTERMEDIATE WALL FILLER**				
DCFhddA	42" to 93"	8" to 32"		CALL FACTORY

*Used to make a corner for units placed at right angles to each other. Available in all heights and depths.

**Used to fill a void where two single faced units are joined at a right angle with a double faced unit. Available for all base shelf depths and frame heights.

SINGLE FACE STEEL CANOPY TOPS

CAT. NO.	W	D	H	WT.	PRICE
SINGLE FACE					
DCTS3008	30	8	—	7.1	100.00
DCTS3009	30	9	—	7.5	103.00
DCTS3010	30	10	—	8.0	102.00
DCTS3012	30	12	—	8.8	108.00
DCTS3013	30	13	—	9.5	112.00
DCTS3016	30	16	—	11.3	124.00
DCTS3608	36	8	—	8.2	100.00
DCTS3609	36	9	—	8.7	106.00
DCTS3610	36	10	—	9.3	102.00
DCTS3612	36	12	—	10.3	108.00
DCTS3613	36	13	—	11.0	112.00
DCTS3616	36	16	—	13.1	124.00

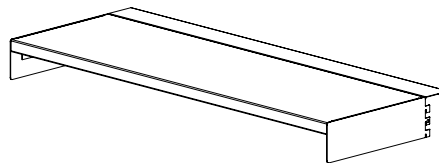

DOUBLE FACE STEEL CANOPY TOPS

CAT. NO.	W	D	H	WT.	PRICE
DOUBLE FACE					
DCTD3016	30	16	—	13.2	168.00
DCTD3018	30	18	—	14.0	176.00
DCTD3020	30	20	—	15.0	173.00
DCTD3024	30	24	—	16.6	185.00
DCTD3026	30	26	—	18.0	193.00
DCTD3032	30	32	—	22.0	218.00
DCTD3616	36	16	—	15.1	168.00
DCTD3618	36	18	—	16.1	181.00
DCTD3620	36	20	—	17.3	173.00
DCTD3624	36	24	—	19.3	185.00
DCTD3626	36	26	—	21.0	193.00
DCTD3632	36	32	—	25.0	218.00

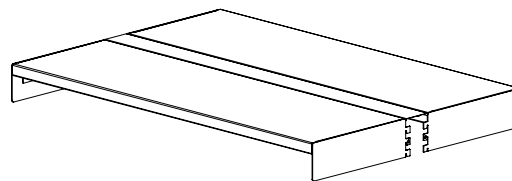

Keeps dust off your valuable materials. Includes attaching brackets.

WOOD TOP CANOPY BRACKETS

CAT. NO.	W	D	H	WT.	PRICE
CANOPY BRACKETS FOR WOOD/PLASTIC TOP					
DCTIB08S(1 Pair)	—	8	—	1.2	48.00
DCTIB12S(1 Pair)	—	12	—	1.9	58.00

For single face units, use one pair. For double face units, use two pair.

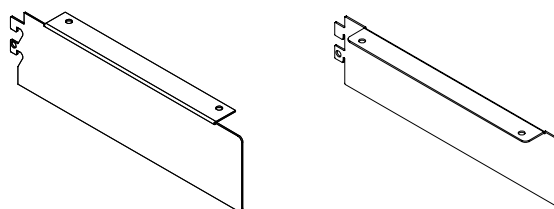

*Attaching bracket is also used to secure steel end panels (see page 16). Each pair consists of one left and one right bracket.

CANOPY SIGNAGE

CAT. NO.	W	D	H	WT.	PRICE
CPSGN36	35 1/4	—	1 3/4	1.5	123.00

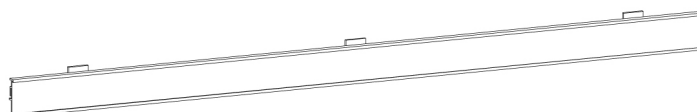

Easily identify special items or sections with this customizable label holder. Three attachment clips provided.

END PANELS



SINGLE FACE

CAT. NO.	BASE DEPTH	HEIGHT	WT.	PRICE
DSP4208LA	8	42	9.2	141.00
DSP4209LA	9	42	9.8	144.00
DSP4210LA	10	42	10.4	146.00
DSP4212LA	12	42	11.5	154.00
DSP4213LA	13	42	12.3	158.00
DSP4216LA	16	42	14.4	170.00
DSP6608LA	8	66	13.8	164.00
DSP6609LA	9	66	14.7	169.00
DSP6610LA	10	66	15.7	172.00
DSP6612LA	12	66	18.0	183.00
DSP6613LA	13	66	18.6	189.00
DSP6616LA	16	66	21.0	206.00
DSP7808LA	8	78	16.1	175.00
DSP7809LA	9	78	17.2	181.00
DSP7810LA	10	78	18.3	196.00
DSP7812LA	12	78	21.0	197.00
DSP7813LA	13	78	22.0	204.00
DSP7816LA	16	78	25.0	224.00
DSP8408LA	8	84	17.3	181.00
DSP8409LA	9	84	18.4	186.00
DSP8410LA	10	84	18.4	193.00
DSP8412LA	12	84	22.0	205.00
DSP8413LA	13	84	23.0	212.00
DSP8416LA	16	84	27.0	233.00
DSP9008LA	8	90	18.4	186.00
DSP9009LA	9	90	19.7	193.00
DSP9010LA	10	90	21.0	196.00
DSP9012LA	12	90	24.0	213.00
DSP9013LA	13	90	25.0	219.00
DSP9016LA	16	90	29.0	242.00

DOUBLE FACE

CAT. NO.	BASE DEPTH	HEIGHT	WT.	PRICE
DDP4216A	16	42	16.4	215.00
DDP4218A	18	42	17.6	222.00
DDP4220A	20	42	15.9	223.00
DDP4224A	24	42	21.0	237.00
DDP4226A	26	42	21.0	250.00
DDP4232A	32	42	28.0	280.00
DDP6616A	16	66	23.0	251.00
DDP6618A	18	66	25.0	261.00
DDP6620A	20	66	27.0	260.00
DDP6624A	24	66	29.0	284.00
DDP6626A	26	66	32.0	302.00
DDP6632A	32	66	40.0	342.00
DDP7816A	16	78	27.0	268.00
DDP7818A	18	78	29.0	279.00
DDP7820A	20	78	31.0	289.00
DDP7824A	24	78	35.0	284.00
DDP7826A	26	78	38.0	327.00
DDP7832A	32	78	44.0	372.00
DDP8416A	16	84	28.0	275.00
DDP8418A	18	84	31.0	287.00
DDP8420A	20	84	34.0	299.00
DDP8424A	24	84	38.0	322.00
DDP8426A	26	84	40.0	340.00
DDP8432A	32	84	49.0	386.00
DDP9016A	16	90	30.0	284.00
DDP9018A	18	90	33.0	294.00
DDP9020A	20	90	35.0	300.00
DDP9024A	24	90	40.0	332.00
DDP9026A	26	90	43.0	352.00
DDP9032A	32	90	52.0	401.00

*NOTE: Listed catalog numbers are for left panels only; for right panel, change the suffix "LA" to "RA". Additional sizes available; call factory for pricing and weights.

Additional sizes available; call factory for pricing and weights.

STEEL BACKS

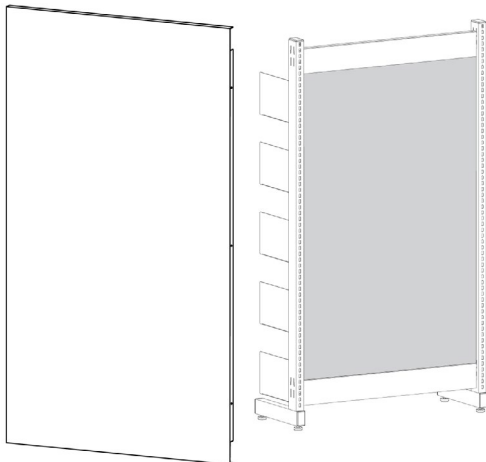

CAT. NO.	W	D	H	WT.	PRICE
DNB3042A	30	1	42	12.3	163.00
DNB3066A	30	1	66	22.0	222.00
DNB3078A	30	1	78	25.0	254.00
DNB3084A	30	1	84	21.0	266.00
DNB3090A	30	1	90	30.0	283.00
DNB3642A	36	1	42	22.0	158.00
DNB3666A	36	1	66	14.7	220.00
DNB3678A	36	1	78	36.0	252.00
DNB3684A	36	1	84	36.0	266.00
DNB3690A	36	1	90	36.0	283.00

24" wide backs are also available. Please contact factory for pricing and weights.

NOTE: MOST PRODUCTS AVAILABLE IN 24"W AT AN UPCHARGE OF 25%.

THE 2" WELD FRAME SYSTEM

Estey Weld Frame construction eliminates the need for sway bracing and separate starter/adder units.

2" Weld Frame

All Units Feature:

- Upright slot spacing 1" on centers in a 6" repeat pattern for easy shelf alignment.
- Upright posts have 8 right angle bends for added strength.
- Six-point leveling system per double-face section; four-point leveling system per single face section (adjustable levelers provided on both base units).
- Base shelves available in one-piece pan, or in multiple-piece construction with kickplate(see below).
- Electrostatically applied/baked-on powder epoxy/polyester powder coated finish.

Basic Shelving Components:

- Welded frames
- Base brackets
- Base shelf
- Adjustable shelves and brackets
- Kickplate(s) (black powder coat finish)

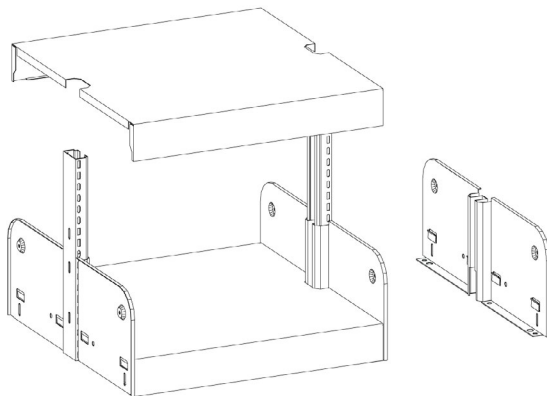

FIXED BASE SHELF

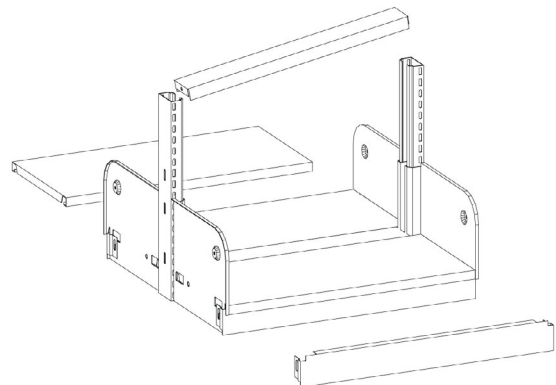

**ADJUSTABLE (KICKPLATE)
BASE SHELF**

NOTE: All shelf depths in this catalog are expressed in nominal sizes. Base shelf dimensions will actually be greater than those shown; all other shelf sizes will be 1" less. Contact factory for specific dimensions.

NOTE: MOST PRODUCTS AVAILABLE IN 24"W AT AN UPCHARGE OF 25%.

SINGLE FACE*

*All single face shelving must be wall anchored.



W2F41080



W2F61080

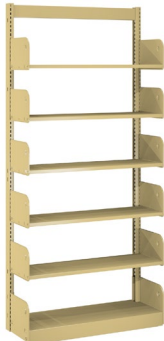

W2F71080



W2F81080



W2F91080

FIXED BASE			ADJUSTABLE BASE			SHELF DEPTH	BASE DEPTH
CAT. NO.	WT.	PRICE	CAT. NO.	WT.	PRICE		
42" HIGH, 3 LEVELS							
W2F41080	42	284.00	W2A41080	42	283.00	8"	8"
W2F41082	44	289.00	W2A41082	44	283.00	8"	10"
W2F41090	44	296.00	W2A41090	45	296.00	9"	9"
W2F41091	46	299.00	W2A41091	46	294.00	9"	10"
W2F41100	47	302.00	W2A41100	47	297.00	10"	10"
W2F41102	48	306.00	W2A41102	49	301.00	10"	12"
W2F41120	51	315.00	W2A41120	52	311.00	12"	12"
66" HIGH, 5 LEVELS							
W2F61080	60	370.00	W2A61080	60	370.00	8"	8"
W2F61082	62	376.00	W2A61082	62	371.00	8"	10"
W2F61090	64	393.00	W2A61090	64	392.00	9"	9"
W2F61091	65	396.00	W2A61091	65	391.00	9"	10"
W2F61100	68	401.00	W2A61100	68	397.00	10"	10"
W2F61102	69	405.00	W2A61102	70	401.00	10"	12"
W2F61120	75	425.00	W2A61120	76	420.00	12"	12"
78" HIGH, 6 LEVELS							
W2F71080	69	416.00	W2A71080	69	415.00	8"	8"
W2F71082	71	423.00	W2A71082	71	418.00	8"	10"
W2F71090	73	441.00	W2A71090	74	443.00	9"	9"
W2F71091	75	448.00	W2A71091	75	443.00	9"	10"
W2F71100	79	455.00	W2A71100	79	450.00	10"	10"
W2F71102	80	459.00	W2A71102	80	454.00	10"	12"
W2F71120	88	483.00	W2A71120	88	479.00	12"	12"
84" HIGH, 7 LEVELS							
W2F81080	77	453.00	W2A81080	77	452.00	8"	8"
W2F81082	79	460.00	W2A81082	79	455.00	8"	10"
W2F81090	82	485.00	W2A81090	83	484.00	9"	9"
W2F81091	83	490.00	W2A81091	84	485.00	9"	10"
W2F81100	88	498.00	W2A81100	88	493.00	10"	10"
W2F81102	89	502.00	W2A81102	90	497.00	10"	12"
W2F81120	98	531.00	W2A81120	99	526.00	12"	12"
90" HIGH, 7 LEVELS							
W2F91080	78	460.00	W2A91080	78	458.00	8"	8"
W2F91082	80	467.00	W2A91082	80	462.00	8"	10"
W2F91090	84	492.00	W2A91090	84	491.00	9"	9"
W2F91091	85	497.00	W2A91091	85	492.00	9"	10"
W2F91100	90	505.00	W2A91100	90	500.00	10"	10"
W2F91102	91	509.00	W2A91102	91	505.00	10"	12"
W2F91120	100	538.00	W2A91120	100	533.00	12"	12"

30" wide units are available at the price listed. 24" wide units are available at a 25% upcharge. Contact factory for weights.
For 24" units, add "2" to end of catalog number (e.g. W2F810802); for 30" units, add "3" (e.g. W2F810803).

NOTE: MOST PRODUCTS AVAILABLE IN 24"W AT AN UPCHARGE OF 25%.

DOUBLE FACE



W2F42080



W2F62080

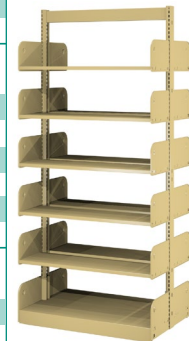

W2F72080



W2F82080



W2F92080

2" Weld Frame

FIXED BASE			ADJUSTABLE BASE			SHELF DEPTH	BASE DEPTH
CAT. NO.	WT.	PRICE	CAT. NO.	WT.	PRICE		
42" HIGH, 3 LEVELS							
W2F42080	61	372.00	W2A42080	64	384.00	8"	16"
W2F42082	65	391.00	W2A42082	68	399.00	8"	20"
W2F42090	66	397.00	W2A42090	69	413.00	9"	18"
W2F42091	68	411.00	W2A42091	71	419.00	9"	20"
W2F42100	71	417.00	W2A42100	74	424.00	10"	20"
W2F42102	74	429.00	W2A42102	78	446.00	10"	24"
W2F42120	80	448.00	W2A42120	83	456.00	12"	24"
66" HIGH, 5 LEVELS							
W2F62080	93	524.00	W2A62080	96	537.00	8"	16"
W2F62082	96	545.00	W2A62082	99	552.00	8"	20"
W2F62090	100	569.00	W2A62090	103	585.00	9"	18"
W2F62091	102	585.00	W2A62091	105	592.00	9"	20"
W2F62100	108	596.00	W2A62100	112	604.00	10"	20"
W2F62102	112	608.00	W2A62102	114	616.00	10"	24"
W2F62120	124	647.00	W2A62120	127	654.00	12"	24"
78" HIGH, 6 LEVELS							
W2F72080	108	604.00	W2A72080	112	617.00	8"	16"
W2F72082	112	626.00	W2A72082	115	634.00	8"	20"
W2F72090	118	658.00	W2A72090	120	674.00	9"	18"
W2F72091	119	676.00	W2A72091	123	683.00	9"	20"
W2F72100	127	690.00	W2A72100	130	697.00	10"	20"
W2F72102	130	702.00	W2A72102	133	709.00	10"	24"
W2F72120	146	750.00	W2A72120	149	757.00	12"	24"
84" HIGH, 7 LEVELS							
W2F82080	123	674.00	W2A82080	126	686.00	8"	16"
W2F82082	113	629.00	W2A82082	130	703.00	8"	20"
W2F82090	134	738.00	W2A82090	136	754.00	9"	18"
W2F82091	135	756.00	W2A82091	139	763.00	9"	20"
W2F82100	145	772.00	W2A82100	148	780.00	10"	20"
W2F82102	148	784.00	W2A82102	151	792.00	10"	24"
W2F82120	166	842.00	W2A82120	169	849.00	12"	24"
90" HIGH, 7 LEVELS							
W2F92080	124	680.00	W2A92080	127	693.00	8"	16"
W2F92082	128	703.00	W2A92082	131	710.00	8"	20"
W2F92090	135	745.00	W2A92090	138	759.00	9"	18"
W2F92091	137	763.00	W2A92091	140	770.00	9"	20"
W2F92100	146	779.00	W2A92100	151	796.00	10"	20"
W2F92102	149	791.00	W2A92102	152	799.00	10"	24"
W2F92120	168	849.00	W2A92120	171	856.00	12"	24"

30" wide units are available at the price listed. 24" wide units are available at a 25% upcharge. Contact factory for weights. For 24" units, add "2" to end of catalog number (e.g. W2F820802); for 30" units, add "3" (e.g. W2F820803).

NOTE: MOST PRODUCTS AVAILABLE IN 24"W AT AN UPCHARGE OF 25%.

SINGLE FACE*

*All single face shelving must be wall anchored.



W2BDF41080



W2BDF61080



W2BDF71080



W2BDF81080



W2BDF91080

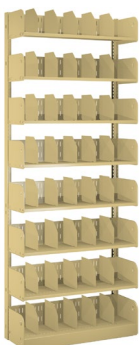

W2BDF01080

FIXED BASE			ADJUSTABLE BASE			SHELF DEPTH	BASE DEPTH
CAT. NO.	WT.	PRICE	CAT. NO.	WT.	PRICE		
42" HIGH, 3 LEVELS							
W2BDF41100	63	386.00	W2BDA41100	63	394.00	10"	10"
W2BDF41102	64	392.00	W2BDA41102	65	399.00	10"	12"
W2BDF41103	65	398.00	W2BDA41103	66	407.00	10"	12"
W2BDF41120	67	404.00	W2BDA41120	68	410.00	12"	12"
W2BDF41130	70	420.00	W2BDA41130	70	427.00	13"	13"
W2BDF41133	79	451.00	W2BDA41133	74	455.00	13"	16"
66" HIGH, 5 LEVELS							
W2BDF61100	96	557.00	W2BDA61100	96	564.00	10"	10"
W2BDF61102	97	563.00	W2BDA61102	98	569.00	10"	12"
W2BDF61103	98	568.00	W2BDA61103	98	577.00	10"	13"
W2BDF61120	103	586.00	W2BDA61120	104	593.00	12"	12"
W2BDF61130	107	611.00	W2BDA61130	108	618.00	13"	13"
W2BDF61133	116	641.00	W2BDA61133	111	646.00	13"	16"
78" HIGH, 6 LEVELS							
W2BDF71100	112	646.00	W2BDA71100	113	654.00	10"	10"
W2BDF71102	113	652.00	W2BDA71102	114	659.00	10"	12"
W2BDF71103	114	664.00	W2BDA71103	115	665.00	10"	13"
W2BDF71120	121	681.00	W2BDA71120	122	688.00	12"	12"
W2BDF71130	126	644.00	W2BDA71130	127	717.00	13"	13"
W2BDF71133	135	651.00	W2BDA71133	130	745.00	13"	16"
84" HIGH, 7 LEVELS							
W2BDF81100	127	725.00	W2BDA81100	128	732.00	10"	10"
W2BDF81102	129	731.00	W2BDA81102	129	737.00	10"	12"
W2BDF81103	130	735.00	W2BDA81103	130	744.00	10"	13"
W2BDF81120	138	765.00	W2BDA81120	139	772.00	12"	12"
W2BDF81130	143	798.00	W2BDA81130	144	806.00	13"	13"
W2BDF81133	153	829.00	W2BDA81133	148	834.00	13"	16"
90" HIGH, 7 LEVELS							
W2BDF91100	129	732.00	W2BDA91100	130	739.00	10"	10"
W2BDF91102	130	738.00	W2BDA91102	131	744.00	10"	12"
W2BDF91103	131	741.00	W2BDA91103	132	750.00	10"	13"
W2BDF91120	139	772.00	W2BDA91120	140	779.00	12"	12"
W2BDF91130	145	805.00	W2BDA91130	146	813.00	13"	13"
W2BDF91133	154	836.00	W2BDA91133	149	840.00	13"	16"
93" HIGH, 8 LEVELS							
W2BDF01100	144	879.00	W2BDA01100	144	886.00	10"	10"
W2BDF01102	145	885.00	W2BDA01102	146	891.00	10"	12"
W2BDF01103	146	889.00	W2BDA01103	146	898.00	10"	13"
W2BDF01120	156	925.00	W2BDA01120	156	932.00	12"	12"
W2BDF01130	162	962.00	W2BDA01130	163	970.00	13"	13"
W2BDF01133	171	993.00	W2BDA01133	175	1,051.00	13"	16"

30" wide units are available at the price listed. 24" wide units are available at a 25% upcharge. Contact factory for weights. For 24" units, add "2" to end of catalog number (e.g. W2BDF811002); for 30" units, add "3" (e.g. W2BDF811003).

All units come with 5 dividers per shelf. Dividers are adjustable on 1" centers.

2" Weld Frame

NOTE: MOST PRODUCTS AVAILABLE IN 24"W AT AN UPCHARGE OF 25%.

DOUBLE FACE



W2BDF42080



W2BDF62080



W2BDF72080



W2BDF82080



W2BDF92080



W2BDF102080

FIXED BASE			ADJUSTABLE BASE			SHELF DEPTH	BASE DEPTH
CAT. NO.	WT.	PRICE	CAT. NO.	WT.	PRICE		
42" HIGH, 3 LEVELS							
W2BDF42100	106	611.00	W2BDA42100	108	628.00	10"	20"
W2BDF42102	110	625.00	W2BDA42102	111	642.00	10"	24"
W2BDF42103	112	642.00	W2BDA42103	113	654.00	10"	26"
W2BDF42120	116	648.00	W2BDA42120	117	665.00	12"	24"
W2BDF42130	121	683.00	W2BDA42130	122	695.00	13"	26"
W2BDF42133	129	730.00	W2BDA42133	127	728.00	13"	32"
66" HIGH, 5 LEVELS							
W2BDF62100	168	932.00	W2BDA62100	169	949.00	10"	20"
W2BDF62102	171	946.00	W2BDA62102	172	963.00	10"	24"
W2BDF62103	173	961.00	W2BDA62103	174	973.00	10"	26"
W2BDF62120	183	993.00	W2BDA62120	184	1,010.00	12"	24"
W2BDF62130	191	1,045.00	W2BDA62130	192	1,057.00	13"	26"
W2BDF62133	199	1,092.00	W2BDA62133	206	1,143.00	13"	32"
78" HIGH, 6 LEVELS							
W2BDF72100	198	1,097.00	W2BDA72100	200	1,114.00	10"	20"
W2BDF72102	202	1,111.00	W2BDA72102	203	1,128.00	10"	24"
W2BDF72103	203	1,155.00	W2BDA72103	205	1,137.00	10"	26"
W2BDF72120	217	1,169.00	W2BDA72120	218	1,186.00	12"	24"
W2BDF72130	226	1,094.00	W2BDA72130	228	1,241.00	13"	26"
W2BDF72133	235	1,110.00	W2BDA72133	236	1,293.00	13"	32"
84" HIGH, 7 LEVELS							
W2BDF82100	228	1,250.00	W2BDA82100	229	1,267.00	10"	20"
W2BDF82102	231	1,264.00	W2BDA82102	232	1,281.00	10"	24"
W2BDF82103	233	1,278.00	W2BDA82103	234	1,291.00	10"	26"
W2BDF82120	249	1,334.00	W2BDA82120	249	1,341.00	12"	24"
W2BDF82130	260	1,403.00	W2BDA82130	262	1,415.00	13"	26"
W2BDF82133	268	1,451.00	W2BDA82133	270	1,467.00	13"	32"
90" HIGH, 7 LEVELS							
W2BDF92100	229	1,257.00	W2BDA92100	231	1,274.00	10"	20"
W2BDF92102	232	1,271.00	W2BDA92102	233	1,288.00	10"	24"
W2BDF92103	234	1,284.00	W2BDA92103	235	1,298.00	10"	26"
W2BDF92120	251	1,341.00	W2BDA92120	252	1,358.00	12"	24"
W2BDF92130	262	1,410.00	W2BDA92130	263	1,422.00	13"	26"
W2BDF92133	270	1,457.00	W2BDA92133	271	1,474.00	13"	32"
93" HIGH, 8 LEVELS							
W2BDF02100	258	1,480.00	W2BDA02100	259	1,497.00	10"	20"
W2BDF02102	261	1,494.00	W2BDA02102	262	1,511.00	10"	24"
W2BDF02103	263	1,507.00	W2BDA02103	264	1,520.00	10"	26"
W2BDF02120	283	1,575.00	W2BDA02120	284	1,592.00	12"	24"
W2BDF02130	291	1,603.00	W2BDA02130	296	1,665.00	13"	26"
W2BDF02133	303	1,701.00	W2BDA02133	304	1,717.00	13"	32"

30" wide units are available at the price listed. 24" wide units are available at a 25% upcharge. Contact factory for weights. For 24" units, add "2" to end of catalog number (e.g. W2BDF821002); for 30" units, add "3" (e.g. W2BDF821003).

All units come with 5 dividers per shelf. Dividers are adjustable on 1" centers.

2" Weld Frame

NOTE: MOST PRODUCTS AVAILABLE IN 24"W AT AN UPCHARGE OF 25%.

SINGLE FACE*

*All single face shelving must be wall anchored.

2" Weld Frame



W2FIB41080

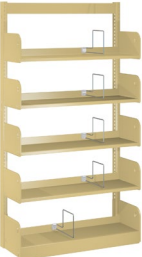

W2FIB61080

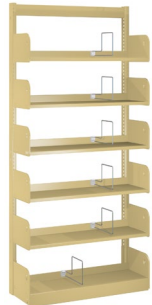

W2FIB71080

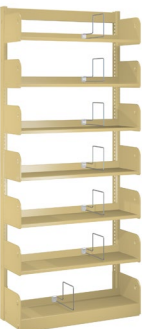

W2FIB81080

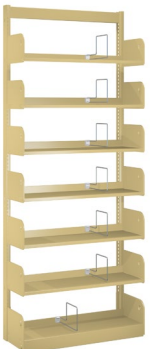

W2FIB91080

FIXED BASE			ADJUSTABLE BASE			SHELF DEPTH	BASE DEPTH
CAT. NO.	WT.	PRICE	CAT. NO.	WT.	PRICE		
42" HIGH, 3 LEVELS							
W2FIB41080	43	329.00	W2AIB41080	43	326.00	8"	8"
W2FIB41082	45	327.00	W2AIB41082	45	327.00	8"	10"
W2FIB41090	45	332.00	W2AIB41090	46	335.00	9"	9"
W2FIB41091	46	333.00	W2AIB41091	47	333.00	9"	10"
W2FIB41100	48	338.00	W2AIB41100	48	338.00	10"	10"
W2FIB41102	49	346.00	W2AIB41102	50	346.00	10"	12"
W2FIB41120	52	364.00	W2AIB41120	53	365.00	12"	12"
66" HIGH, 5 LEVELS							
W2FIB61080	62	452.00	W2AIB61080	62	448.00	8"	8"
W2FIB61082	64	450.00	W2AIB61082	65	449.00	8"	10"
W2FIB61090	66	461.00	W2AIB61090	67	464.00	9"	9"
W2FIB61091	67	462.00	W2AIB61091	68	461.00	9"	10"
W2FIB61100	70	471.00	W2AIB61100	71	471.00	10"	10"
W2FIB61102	72	479.00	W2AIB61102	72	479.00	10"	12"
W2FIB61120	78	516.00	W2AIB61120	79	516.00	12"	12"
78" HIGH, 6 LEVELS							
W2FIB71080	72	517.00	W2AIB71080	72	513.00	8"	8"
W2FIB71082	74	515.00	W2AIB71082	75	515.00	8"	10"
W2FIB71090	77	529.00	W2AIB71090	78	532.00	9"	9"
W2FIB71091	78	530.00	W2AIB71091	78	530.00	9"	10"
W2FIB71100	82	542.00	W2AIB71100	82	542.00	10"	10"
W2FIB71102	83	549.00	W2AIB71102	84	550.00	10"	12"
W2FIB71120	92	595.00	W2AIB71120	93	596.00	12"	12"
84" HIGH, 7 LEVELS							
W2FIB81080	81	571.00	W2AIB81080	81	566.00	8"	8"
W2FIB81082	83	569.00	W2AIB81082	83	569.00	8"	10"
W2FIB81090	86	586.00	W2AIB81090	87	588.00	9"	9"
W2FIB81091	87	587.00	W2AIB81091	88	587.00	9"	10"
W2FIB81100	92	602.00	W2AIB81100	92	601.00	10"	10"
W2FIB81102	93	609.00	W2AIB81102	94	610.00	10"	12"
W2FIB81120	104	664.00	W2AIB81120	104	665.00	12"	12"
90" HIGH, 7 LEVELS							
W2FIB91080	82	578.00	W2AIB91080	83	574.00	8"	8"
W2FIB91082	84	576.00	W2AIB91082	85	576.00	8"	10"
W2FIB91090	87	593.00	W2AIB91090	89	595.00	9"	9"
W2FIB91091	88	594.00	W2AIB91091	89	594.00	9"	10"
W2FIB91100	93	609.00	W2AIB91100	94	608.00	10"	10"
W2FIB91102	95	616.00	W2AIB91102	95	617.00	10"	12"
W2FIB91120	105	671.00	W2AIB91120	106	672.00	12"	12"

Units come with one wire divider per shelf level.

30" wide units are available at the price listed. 24" wide units are available at a 25% upcharge. Contact factory for weights.

For 24" units, add "2" to end of catalog number (e.g. W2FIB810802); for 30" units, add "3" (e.g. W2FIB810803).

CAT. NO.	W	D	H	WT.	PRICE
EXTRA DIVIDERS					
EWD-1	3/16	8	6 1/2	0.4	10.80
EWD-2	3/16	12	6 1/2	0.6	12.20

NOTE: MOST PRODUCTS AVAILABLE IN 24"W AT AN UPCHARGE OF 25%.

DOUBLE FACE

FIXED BASE			ADJUSTABLE BASE			SHELF DEPTH	BASE DEPTH
CAT. NO.	WT.	PRICE	CAT. NO.	WT.	PRICE		
42" HIGH, 3 LEVELS							
W2FIB42080	66	500.00	W2AIB42080	68	481.00	8"	16"
W2FIB42082	70	493.00	W2AIB42082	71	494.00	8"	20"
W2FIB42090	71	501.00	W2AIB42090	72	501.00	9"	18"
W2FIB42091	73	505.00	W2AIB42091	74	506.00	9"	20"
W2FIB42100	76	515.00	W2AIB42100	77	516.00	10"	20"
W2FIB42102	80	532.00	W2AIB42102	81	537.00	10"	24"
W2FIB42120	87	568.00	W2AIB42120	88	573.00	12"	24"
66" HIGH, 5 LEVELS							
W2FIB62080	101	724.00	W2AIB62080	102	705.00	8"	16"
W2FIB62082	104	718.00	W2AIB62082	106	719.00	8"	20"
W2FIB62090	109	738.00	W2AIB62090	110	738.00	9"	18"
W2FIB62091	110	742.00	W2AIB62091	112	743.00	9"	20"
W2FIB62100	117	761.00	W2AIB62100	118	762.00	10"	20"
W2FIB62102	120	778.00	W2AIB62102	121	783.00	10"	24"
W2FIB62120	134	852.00	W2AIB62120	135	857.00	12"	24"
78" HIGH, 6 LEVELS							
W2FIB72080	118	839.00	W2AIB72080	120	820.00	8"	16"
W2FIB72082	122	834.00	W2AIB72082	124	835.00	8"	20"
W2FIB72090	128	860.00	W2AIB72090	129	860.00	9"	18"
W2FIB72091	129	864.00	W2AIB72091	131	865.00	9"	20"
W2FIB72100	137	888.00	W2AIB72100	139	889.00	10"	20"
W2FIB72102	141	905.00	W2AIB72102	142	910.00	10"	24"
W2FIB72120	158	997.00	W2AIB72120	159	1,002.00	12"	24"
84" HIGH, 7 LEVELS							
W2FIB82080	135	944.00	W2AIB82080	136	926.00	8"	16"
W2FIB82082	138	940.00	W2AIB82082	140	941.00	8"	20"
W2FIB82090	145	972.00	W2AIB82090	146	972.00	9"	18"
W2FIB82091	147	976.00	W2AIB82091	149	977.00	9"	20"
W2FIB82100	156	1,005.00	W2AIB82100	158	1,006.00	10"	20"
W2FIB82102	160	1,021.00	W2AIB82102	161	1,026.00	10"	24"
W2FIB82120	181	1,132.00	W2AIB82120	182	1,137.00	12"	24"
90" HIGH, 7 LEVELS							
W2FIB92080	136	950.00	W2AIB92080	137	932.00	8"	16"
W2FIB92082	139	947.00	W2AIB92082	141	948.00	8"	20"
W2FIB92090	147	979.00	W2AIB92090	148	979.00	9"	18"
W2FIB92091	149	983.00	W2AIB92091	150	984.00	9"	20"
W2FIB92100	158	1,012.00	W2AIB92100	159	1,013.00	10"	20"
W2FIB92102	161	1,028.00	W2AIB92102	162	1,033.00	10"	24"
W2FIB92120	182	1,139.00	W2AIB92120	183	1,144.00	12"	24"

Units come with one wire divider per shelf level.

30" wide units are available at the price listed. 24" wide units are available at a 25% upcharge. Contact factory for weights.

For 24" units, add "2" to end of catalog number (e.g. W2FIB8208002); for 30" units, add "3" (e.g. W2FIB8208003).

CAT. NO.	W	D	H	WT.	PRICE
EXTRA DIVIDERS					
EWD-1	3/16	8	6 1/2	0.4	10.80
EWD-2	3/16	12	6 1/2	0.6	12.20

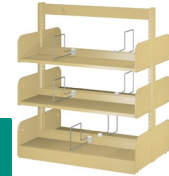

W2FIB42080

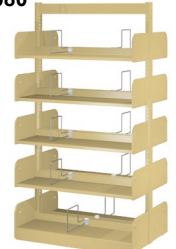

W2FIB62080

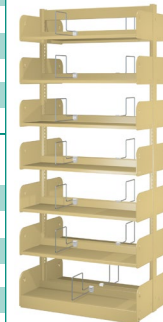

W2FIB72080

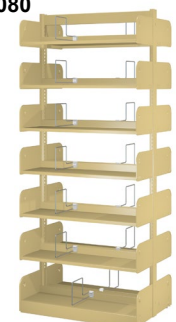

W2FIB82080

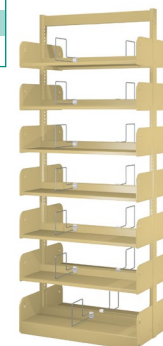

W2FIB92080

2" Weld Frame

NOTE: MOST PRODUCTS AVAILABLE IN 24"W AT AN UPCHARGE OF 25%.

PERIODICAL DISPLAY UNITS

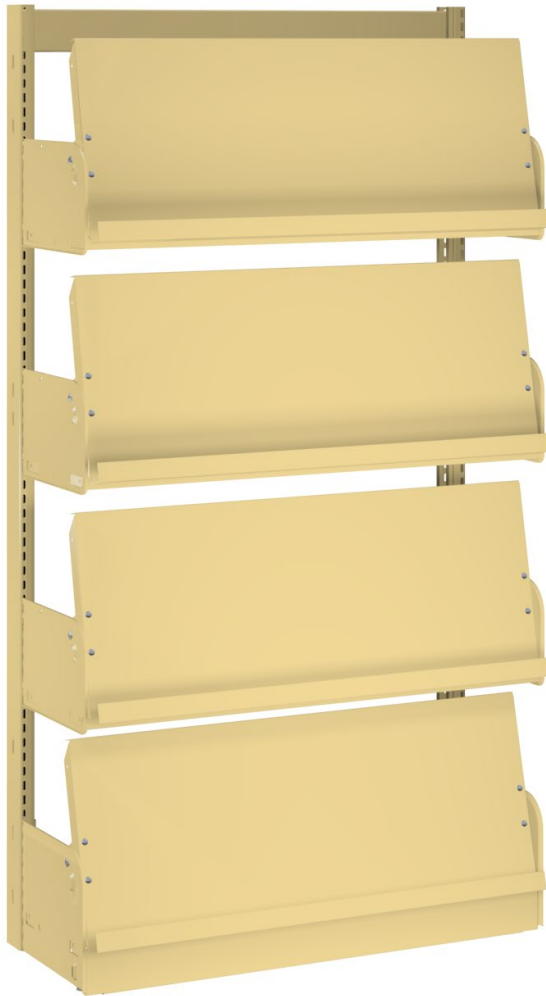

W2P61120



W2P62120

2" Weld Frame

Pivoting periodical shelving with flat storage shelf.
With 12" storage shelves & 12" fixed base single face or 24" fixed base double face.

Adjustable base units available.
24" wide units are also available at a 25% upcharge.
Contact factory for weights.

CAT. NO.	SLOPING SHELVES	STORAGE LEVELS	W	D	H	WT.	PRICE
SINGLE FACE*							
W2P411203†	3	3	30	12	42	67.0	455.00
W2P611203	4	4	30	12	66	87.0	564.00
W2P711203	5	5	30	12	78	106.0	668.00
W2P811203	5	5	30	12	84	107.0	672.00
W2P911203	6	6	30	12	90	123.0	768.00
W2P41120†	3	3	36	12	42	76.0	455.00
W2P61120	4	4	36	12	66	99.0	564.00
W2P71120	5	5	36	12	78	120.0	668.00
W2P81120	5	5	36	12	84	121.0	672.00
W2P91120	6	6	36	12	90	140.0	768.00
DOUBLE FACE							
W2P421203†	6	6	30	24	42	114.0	708.00
W2P621203	8	8	30	24	66	149.0	907.00
W2P721203	10	10	30	24	78	183.0	1,100.00
W2P821203	10	10	30	24	84	215.0	1,282.00
W2P921203**	12	12	30	24	90	216.0	1,298.00
W2P42120†	6	6	36	24	42	130.0	708.00
W2P62120	8	8	36	24	66	171.0	907.00
W2P72120	10	10	36	24	78	209.0	1,098.00
W2P82120	10	10	36	24	84	246.0	1,282.00
W2P92120**	12	12	36	24	90	248.0	1,289.00

† A canopy top will not fit on 42" high units.

*All single face shelving must be wall anchored.

**Overhead top bracing recommended.

NOTE: MOST PRODUCTS AVAILABLE IN 24"W AT AN UPCHARGE OF 25%.

WELDED FRAMES

CAT. NO.	DESCRIPTION	W	D	H	WT.	PRICE
W2-4230		30	2	42	15.0	114.00
W2-5430		30	2	54	17.0	139.00
W2-6630		30	2	66	19.0	134.00
W2-7830		30	2	78	22.0	148.00
W2-8430		30	2	84	23.0	151.00
W2-9030		30	2	90	24.0	158.00
W2-9330		30	2	93	25.0	230.00
W2-4236		36	2	42	16.0	114.00
W2-5436		36	2	54	18.0	139.00
W2-6636		36	2	66	20.5	134.00
W2-7836		36	2	78	23.0	148.00
W2-8436		36	2	84	24.0	151.00
W2-9036		36	2	90	25.5	158.00
W2-9336		36	2	93	26.0	230.00
W2-10836		36	2	108	29.0	221.00
W2-11236		36	2	112	30.0	270.00
SEISMIC SWAY BRACES						
SSBR6030A	For 66" and 78" frames	30	1	58	4.5	64.00
SSBR7330A	For 84", 90" and 93" frames	30	1	73	5.9	73.00
SSBR6036A	For 66" and 78" frames	36	1	58	4.5	64.00
SSBR7336A	For 84", 90" and 93" frames	36	1	73	5.9	73.00

Special widths or heights are available. Contact factory for pricing.



WELDED FRAMES



SEISMIC SWAY BRACES

SEISMIC WELDED FRAMES

CAT. NO.	W	D	H	WT.	PRICE
SW2-7830	30	2	78	30.0	239.00
SW2-8430	30	2	84	31.0	245.00
SW2-9030	30	2	90	32.0	245.00
SW2-7836	36	2	78	32.0	239.00
SW2-8436	36	2	84	33.0	245.00
SW2-9036	36	2	90	35.0	245.00

Eliminates the need for sway braces.



WELDED FRAME EXTENDER

CAT. NO.	W	D	H	WT.	PRICE
WFEXT2-3618	36	2	18	9.2	152.00
WFEXT2-3624	36	2	24	11.2	142.00
WFEXT2-3630	36	2	30	13.9	159.00
WFEXT2-36xx	36	2	Varies	Varies	Contact Factory



Add to existing frames for more space. Available in a variety of sizes with a 12" minimum. Contact factory for pricing and weights on sizes not shown.

NOTE: MOST PRODUCTS AVAILABLE IN 24"W AT AN UPCHARGE OF 25%.

CLOSED BASE SHELVES - SINGLE FACE

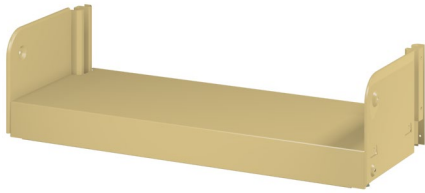

Comes complete with base brackets. Kickplates for adjustable base shelves are furnished with black powder coat finish. If 30" shelves are desired, change the number "36" to "30" (e.g. WA2-3013A or WB2-3013A). Call factory for weights on 30" shelves.

CAT. NO.	W	D	H	WT.	PRICE
FOR FIXED BASE SHELVES					
WB2-3608A	36	8	3 5/16	12.3	100.00
WB2-3609A	36	9	3 5/16	13.0	103.00
WB2-3610A	36	10	3 5/16	14.3	106.00
WB2-3612A	36	12	3 5/16	15.5	110.00
WB2-3613A	36	13	3 5/16	16.4	123.00
WB2-3616A	36	16	3 5/16	24.0	140.00
FOR ADJUSTABLE BASE SHELVES					
WA2-3608A	36	8	3 5/16	12.2	101.00
WA2-3609A	36	9	3 5/16	13.7	104.00
WA2-3610A	36	10	3 5/16	14.4	102.00
WA2-3612A	36	12	3 5/16	15.8	106.00
WA2-3613A	36	13	3 5/16	16.7	121.00
WA2-3616A	36	16	3 5/16	18.8	133.00

CLOSED BASE SHELVES - DOUBLE FACE

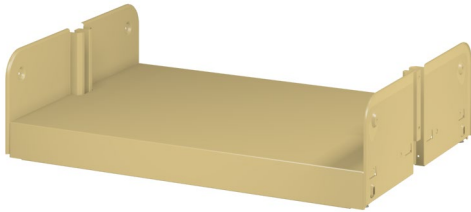

Comes complete with base brackets. Kickplates for adjustable base shelves are furnished with black powder coat finish. If 30" shelves are desired, change the number "36" to "30" (e.g. WA2-3013A or WB2-3013A). Call factory for weights on 30" shelves.

CAT. NO.	W	D	H	WT.	PRICE
FOR FIXED BASE SHELVES					
WB2-3616DA	36	16	3 5/16	18.2	123.00
WB2-3618A	36	18	3 5/16	19.8	130.00
WB2-3620A	36	20	3 5/16	22.0	142.00
WB2-3624A	36	24	3 5/16	25.0	154.00
WB2-3626A	36	26	3 5/16	27.0	181.00
WB2-3632A	36	32	3 5/16	32.0	208.00
FOR ADJUSTABLE BASE SHELVES					
WA2-3616DA	36	16	3 5/16	21.0	137.00
WA2-3618A	36	18	3 5/16	23.0	147.00
WA2-3620A	36	20	3 5/16	25.0	151.00
WA2-3624A	36	24	3 5/16	28.0	163.00
WA2-3626A	36	26	3 5/16	30.0	189.00
WA2-3632A	36	32	3 5/16	35.0	211.00

CLOSED BASE SHELVES WITH INTEGRAL BACK AND DIVIDERS - SINGLE FACE

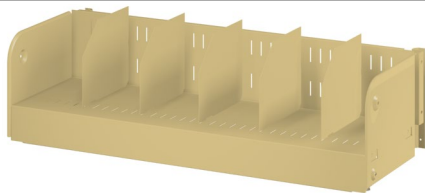

Slotted on 1" centers for dividers, with 5" backstop. Five adjustable dividers provided per shelf. Kickplates for adjustable base shelves are furnished with black powder coat finish. If 30" shelves are desired, change the number "36" to "30" (e.g. TBDF2-3010 or TBDA2-3010). Call factory for weights on 30" shelves.

CAT. NO.	W	D	H	WT.	PRICE
FOR FIXED BASE SHELVES					
TBDF2-3610	36	10	3 5/16	18.3	119.00
TBDF2-3612	36	12	3 5/16	19.5	125.00
TBDF2-3613	36	13	3 5/16	20.0	131.00
TBDF2-3616	36	16	3 5/16	25.0	163.00
FOR ADJUSTABLE BASE SHELVES					
TBDA2-3610	36	10	3 5/16	18.9	128.00
TBDA2-3612	36	12	3 5/16	20.0	132.00
TBDA2-3613	36	13	3 5/16	21.0	141.00
TBDA2-3616	36	16	3 5/16	25.0	168.00

CLOSED BASE SHELVES WITH INTEGRAL BACK AND DIVIDERS - DOUBLE FACE

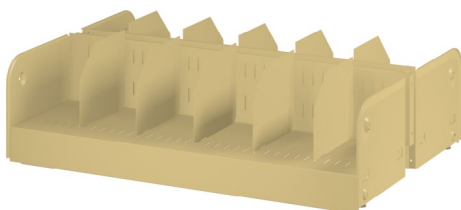

Slotted on 1" centers for dividers, with 5" backstop. Five adjustable dividers provided per shelf. Kickplates for adjustable base shelves are furnished with black powder coat finish. If 30" shelves are desired, change the number "36" to "30" (e.g. TBDF2-3010 or TBDA2-3010). Call factory for weights on 30" shelves.

CAT. NO.	W	D	H	WT.	PRICE
FOR FIXED BASE SHELVES					
TBDF2-3620	36	20	3 5/16	34.0	194.00
TBDF2-3624	36	24	3 5/16	37.0	208.00
TBDF2-3626	36	26	3 5/16	39.0	225.00
TBDF2-3632	36	32	3 5/16	47.0	273.00
FOR ADJUSTABLE BASE SHELVES					
TBDA2-3620	36	20	3 5/16	35.0	213.00
TBDA2-3624	36	24	3 5/16	38.0	227.00
TBDA2-3626	36	26	3 5/16	40.0	239.00
TBDA2-3632	36	32	3 5/16	48.0	291.00

NOTE: MOST PRODUCTS AVAILABLE IN 24"W AT AN UPCHARGE OF 25%.

INTEGRAL BACK BASE SHELVES - SINGLE FACE

CAT. NO.	W	D	H	WT.	PRICE
WIBBS2-3008A	30	8	3 5/16	10.2	111.00
WIBBS2-3009A	30	9	3 5/16	10.8	107.00
WIBBS2-3010A	30	10	3 5/16	12.0	108.00
WIBBS2-3012A	30	12	3 5/16	13.2	116.00
WIBBS2-3013A	30	13	3 5/16	14.6	127.00
WIBBS2-3016A	30	16	3 5/16	22.0	140.00
WIBBS2-3608A	36	8	3 5/16	11.2	111.00
WIBBS2-3609A	36	9	3 5/16	11.9	107.00
WIBBS2-3610A	36	10	3 5/16	13.2	108.00
WIBBS2-3612A	36	12	3 5/16	14.6	116.00
WIBBS2-3613A	36	13	3 5/16	15.5	127.00
WIBBS2-3616A	36	16	3 5/16	23.0	140.00
DIVIDER ONLY					
EWD-1	3/16	8	6 1/2	0.4	10.80
EWD-2	3/16	12	6 1/2	0.6	12.20

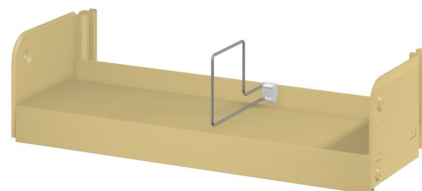

Includes one wire divider per opening and a 2" built-in backstop.
If adjustable base is required, change "WIBBS" to "WIBBSA" when ordering (e.g. WIBBSA2-wvddA).
Call factory for adjustable base pricing and weights.

INTEGRAL BACK BASE SHELVES - DOUBLE FACE

CAT. NO.	W	D	H	WT.	PRICE
WIBBS2-3018A	30	18	3 5/16	19.6	169.00
WIBBS2-3020A	30	20	3 5/16	21.0	173.00
WIBBS2-3024A	30	24	3 5/16	25.0	190.00
WIBBS2-3026A	30	26	3 5/16	26.0	216.00
WIBBS2-3032A	30	32	3 5/16	31.0	239.00
WIBBS2-3618A	36	18	3 5/16	22.0	169.00
WIBBS2-3620A	36	20	3 5/16	24.0	173.00
WIBBS2-3624A	36	24	3 5/16	27.0	190.00
WIBBS2-3626A	36	26	3 5/16	29.0	216.00
WIBBS2-3632A	36	32	3 5/16	34.0	239.00
DIVIDER ONLY					
EWD-1	3/16	8	6 1/2	0.4	10.80
EWD-2	3/16	12	6 1/2	0.6	12.20

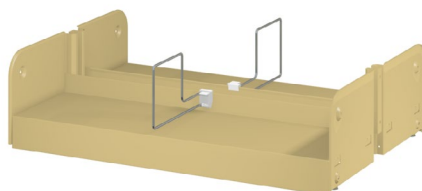

Includes one wire divider per opening and a 2" built-in backstop.
If adjustable base is required, change "WIBBS" to "WIBBSA" when ordering (e.g. WIBBSA2-wvddA).
Call factory for adjustable base pricing and weights.

SLOPING BASE SHELVES - SINGLE FACE

CAT. NO.	W	D	H	WT.	PRICE
WSB2-3009A	30	9	3 7/8	11.6	112.00
WSB2-3010A	30	10	3 7/8	14.3	111.00
WSB2-3012A	30	12	3 7/8	15.6	113.00
WSB2-3609A	36	9	3 7/8	11.1	112.00
WSB2-3610A	36	10	3 7/8	15.0	111.00
WSB2-3612A	36	12	3 7/8	15.6	113.00
VIDEO SLOPING BASE SHELVES (6 DIVIDERS INCLUDED)					
VC2-3012A	30	12	3 7/8	19.1	145.00
VC2-3612A	36	12	3 7/8	20.0	145.00

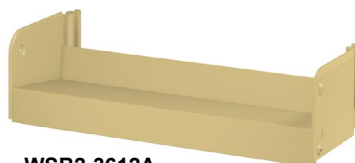

WSB2-3612A

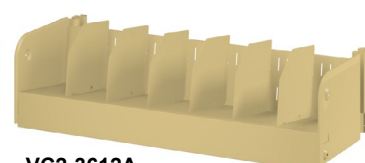

VC2-3612A

Sloping Base Shelves and Video Sloping Base Shelves are sloped at 9°, aiding visually those items displayed on the bottom shelf. Video Sloping Base Shelves are slotted on 1" centers for dividers, with 5" integral backstop; six adjustable dividers are provided.

SLOPING BASE SHELVES - DOUBLE FACE

CAT. NO.	W	D	H	WT.	PRICE
WSB2-3018A	30	18	3 7/8	24.0	181.00
WSB2-3020A	30	20	3 7/8	24.0	185.00
WSB2-3024A	30	24	3 7/8	31.0	194.00
WSB2-3618A	36	18	3 7/8	23.0	181.00
WSB2-3620A	36	20	3 7/8	26.0	185.00
WSB2-3624A	36	24	3 7/8	31.0	193.00
VIDEO SLOPING BASE SHELVES (12 DIVIDERS INCLUDED)					
VC2-3012DA	30	24	3 7/8	38.0	259.00
VC2-3612DA	36	24	3 7/8	40.0	259.00

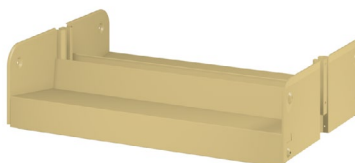

WSB2-3624A



VC2-3612DA

Sloping Base Shelves and Video Sloping Base Shelves are sloped at 9°, aiding visually those items displayed on the bottom shelf. Video Sloping Base Shelves are slotted on 1" centers for dividers, with 5" integral backstop; twelve adjustable dividers are provided.

NOTE: MOST PRODUCTS AVAILABLE IN 24"W AT AN UPCHARGE OF 25%.

ADJUSTABLE SHELVES

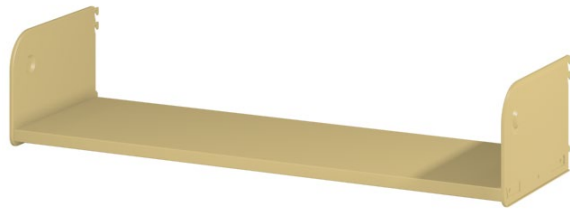

Includes shelf brackets. Can be furnished in additional widths or depths; contact factory for pricing.

CAT. NO.	W	D	H	WT.	PRICE
BL3008A	30	8	13/16	5.9	33.00
BL3009A	30	9	13/16	6.6	38.00
BL3010A	30	10	13/16	7.2	40.00
BL3011A	30	11	13/16	7.9	42.00
BL3012A	30	12	13/16	8.6	45.00
BL3013A	30	13	13/16	9.2	56.00
BL3014A	30	14	13/16	9.9	58.00
BL3016A	30	16	13/16	11.2	63.00
BL3608A	36	8	13/16	6.7	33.00
BL3609A	36	9	13/16	7.5	38.00
BL3610A	36	10	13/16	8.2	40.00
BL3611A	36	11	13/16	9.0	42.00
BL3612A	36	12	13/16	9.8	45.00
BL3613A	36	13	13/16	10.5	56.00
BL3614A	36	14	13/16	11.3	57.00
BL3616A	36	16	13/16	12.8	63.00

ADJUSTABLE DIVIDER SHELVES

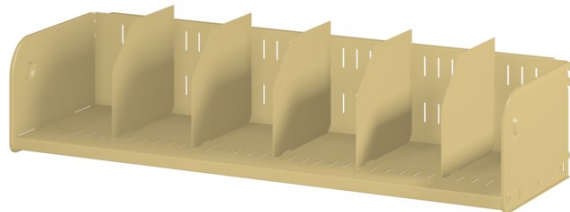

Slotted on 1" centers to accommodate dividers. Includes 5" back, brackets and 5 adjustable dividers per shelf.

CAT. NO.	W	D	H	WT.	PRICE
BDA3010A	30	10	13/16	12.8	75.00
BDA3011A	30	11	13/16	13.5	78.00
BDA3012A	30	12	13/16	14.2	81.00
BDA3013A	30	13	13/16	14.8	85.00
BDA3016A	30	16	13/16	17.9	108.00
BDA3610A	36	10	13/16	14.1	75.00
BDA3611A	36	11	13/16	14.9	78.00
BDA3612A	36	12	13/16	15.7	81.00
BDA3613A	36	13	13/16	16.4	85.00
BDA3616A	36	16	13/16	20.0	108.00

SHELF BRACKETS



LEFT BRACKET



RIGHT BRACKET

Attaches shelves to unit uprights. ***NOTE:** Listed catalog numbers are for left bracket only; for right bracket, change the suffix "L" to "R".

CAT. NO.	W	D	H	WT.	PRICE
ASBRK08L*	1/4	8	7 1/2	1.0	5.70
ASBRK09L*	1/4	9	7 1/2	1.1	6.20
ASBRK10L*	1/4	10	7 1/2	1.2	6.40
ASBRK11L*	1/4	11	7 1/2	1.4	7.20
ASBRK12L*	1/4	12	7 1/2	1.5	7.80
ASBRK13L*	1/4	13	7 1/2	1.6	8.90
ASBRK14L*	1/4	14	7 1/2	1.8	9.20
ASBRK16L*	1/4	16	7 1/2	2.0	11.00

DIVIDERS

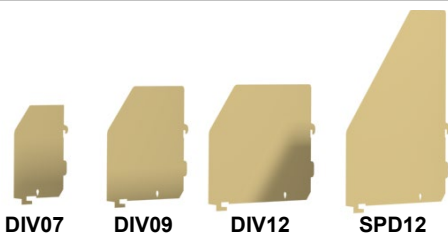

DIV07

DIV09

DIV12

SPD12

CAT. NO.	USE WITH	D	H	WT.	PRICE
DIV07	7"-9" Shelves	7	6	0.4	2.40
DIV09	10" through 13"	9	7 1/2	0.7	3.30
DIV12	14" through 16"	12	7 1/2	1.0	5.20
SPD12	14" through 16"	9	12	1.6	12.10

SHIMS



Used to aid in the leveling of fixed base units. Zinc finish.

CAT. NO.	W	D	H	WT.	PRICE
SHIM	2	2 1/2	1/16	0.1	1.20

THIS PAGE LEFT BLANK INTENTIONALLY

THIS PAGE LEFT BLANK INTENTIONALLY

THIS PAGE LEFT BLANK INTENTIONALLY

THIS PAGE LEFT BLANK INTENTIONALLY



NOTE: MOST PRODUCTS AVAILABLE IN 24"W AT AN UPCHARGE OF 25%.

HINGED PERIODICAL DISPLAY SHELVES



PERIODICAL DISPLAY SHELF

Sloped for display. 14" high periodical surface.

*Includes continuous label holder.

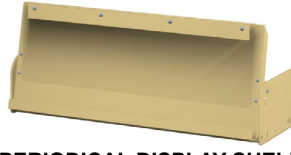

PERIODICAL DISPLAY SHELF WITH PLEXIGLASS COVER

CAT. NO.	W	D	H	WT.	PRICE
PDS3012A	30	12	14	15.5	90.00
PDS3612A	36	12	14	18.0	90.00
PDS3012ACLH*	30	12	14	14.9	110.00
PDS3612ACLH*	36	12	14	18.0	110.00
WITH PLEXIGLASS COVER					
PDSCA30	30	12	14	22.0	217.00
PDSCA	36	12	14	23.0	217.00

FIXED SLOPED DISPLAY SHELVES



SLOPED DISPLAY SHELF

Sloped for display. 12" periodical surface.

*Includes continuous label holder.

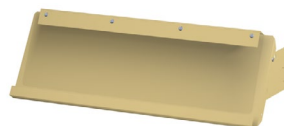

SLOPED DISPLAY SHELF WITH PLEXIGLASS COVER

CAT. NO.	W	D	H	WT.	PRICE
SDS3012A	30	12	12	7.3	77.00
SDS3612A	36	12	12	9.6	77.00
SDS3012ACLH*	30	12	12	13.1	124.00
SDS3612ACLH*	36	12	12	9.2	117.00
WITH PLEXIGLASS COVER					
SDSCA30	30	12	12	11.8	215.00
SDSCA	36	12	12	11.8	215.00

INTEGRAL BACK SHELVES

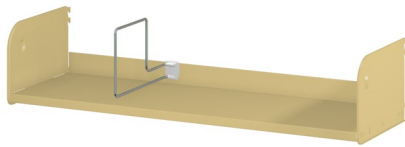

Built-in 2" backstop keeps items organized. Includes brackets and one wire divider per shelf. For 30" shelf, change "BLIB36" to "BLIB30" (e.g. BLIB3016A).

CAT. NO.	W	D	H	WT.	PRICE
BLIB3608A	36	8	13/16	7.5	51.00
BLIB3609A	36	9	13/16	8.3	54.00
BLIB3610A	36	10	13/16	9.0	57.00
BLIB3611A	36	11	13/16	9.8	61.00
BLIB3612A	36	12	13/16	10.8	66.00
BLIB3613A	36	13	13/16	11.5	74.00
BLIB3616A	36	16	13/16	13.8	85.00

SLOPED INTEGRAL BACK SHELVES

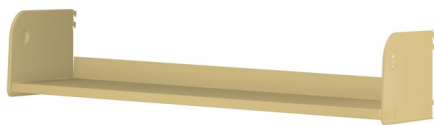

Shelves have a 7° slope.

Built-in 2" backstop keeps items from falling off sloped shelf. For 30" shelf, change "SIBS36" to "SIBS30" (e.g. SIBS3016A).

CAT. NO.	W	D	H	WT.	PRICE
SIBS3608A	36	8	13/16	7.4	42.00
SIBS3609A	36	9	13/16	8.1	45.00
SIBS3610A	36	10	13/16	8.8	49.00
SIBS3611A	36	11	13/16	9.7	53.00
SIBS3612A	36	12	13/16	10.4	56.00

MULTIPURPOSE DISPLAY SHELVES



AS SLOPING DISPLAY SHELF

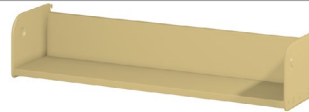

AS INTEGRAL BACK SHELF

Two-positional shelf allows you to have either a sloping display shelf or (reversed) an integral back shelf. Ideal for displaying video tapes, audio cassettes, art books, etc.

CAT. NO.	TYPE	W	D	H	WT.	PRICE
MP3610A	No Dividers	36	10	8	10.2	69.00
MPD3610A	With Dividers	36	10	8	12.4	83.00

Divider shelves come with 6 dividers.

MULTIPURPOSE BASE SHELVES



SINGLE ENTRY



DOUBLE ENTRY

Two-positional shelf can be used as either a sloping display shelf or (reversed) an integral back shelf. Divider shelves come with 6 dividers.

CAT. NO.	TYPE	W	D	H	WT.	PRICE
SINGLE ENTRY						
MPB2-3610A	No Dividers	36	10	8	15.6	114.00
MPDB2-3610A	With Dividers	36	10	8	17.8	128.00
DOUBLE ENTRY						
MPB2-3620A	No Dividers	36	20	8	38.0	203.00
MPDB2-3620A	With Dividers	36	20	8	42.0	232.00

NOTE: MOST PRODUCTS AVAILABLE IN 24"W AT AN UPCHARGE OF 25%.

STORAGE SHELVES

CAT. NO.	W	D	H	WT.	PRICE
IN3610A	36	10	13/16	6.9	36.00
IN3612A	36	12	13/16	8.1	39.00
IN3613A	36	13	13/16	8.6	48.00
IN3614A	36	14	13/16	9.5	50.00
IN3616A	36	16	13/16	10.5	53.00
IN3618A	36	18	13/16	11.7	63.00
IN3619A	36	19	13/16	12.4	66.00



Used with sloped display shelves (at left on page 16), or any place where a flat shelf is desired. For 30" shelf, change "IN36" to "IN30" (e.g. IN3010A)

FACE-OUT DISPLAY SHELF

CAT. NO.	W	D	H	WT.	PRICE
FODSA	36	2 3/4	5 9/16	6.2	65.00

Used to display compact discs and DVDs. Shelf has a 7° slope.



VIDEO CASSETTE/PAPERBACK BOOK SHELF

CAT. NO.	W	D	H	WT.	PRICE
VCS3007A	30	6	7 1/2	11.5	67.00
VCS3008A	30	7	7 1/2	10.6	72.00
VCS3607A	36	6	7 1/2	10.8	67.00
VCS3608A	36	7	7 1/2	11.5	72.00
DIV07	(DIVIDER ONLY)			0.4	2.40

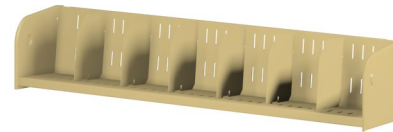

Slopes to allow convenient viewing of spines on paperbacks and video cassettes. Six adjustable dividers included per shelf.

SLIDING REFERENCE SHELVES*

*Brackets included.

CAT. NO.	W	D	H	WT.	PRICE
SRS3008A	30	8	3	9.2	212.00
SRS3009A	30	9	3	8.2	183.00
SRS3010A	30	10	3	13.1	209.00
SRS3012A	30	12	3	15.6	196.00
SRS3608A	36	8	3	9.2	212.00
SRS3609A	36	9	3	8.2	183.00
SRS3610A	36	10	3	14.0	209.00
SRS3612A	36	12	3	16.6	196.00

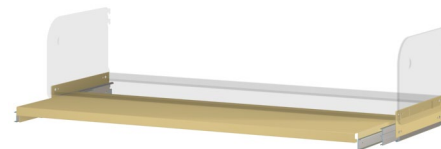

Sturdy full extension slides attach to underside of adjustable shelf. Use two reference shelves for double face units.

DOUBLE TIER VIDEO CASSETTE & AUDIO CASSETTE SHELVES

CAT. NO.	W	D	H	WT.	PRICE
VIDEO CASSETTE SHELF					
VCDT3014	30	14	12	20.0	204.00
VCDT3614	36	14	12	20.0	204.00
AUDIO CASSETTE/MICROFILM SHELF					
SPMF30A	30	10	7 1/2	12.1	235.00
SPMF36A	36	10	7 1/2	12.1	235.00



VCDT3014



SPMF30A

Double Tier Video Cassette Shelf is used with compact discs, video cassettes, or paperbacks. Sloped; 36" wide shelf holds 60 videotapes or 160 compact discs. **Audio Cassette Shelf** stores microfilm or audio cassettes. Capacity: 100 cassettes (36" wide shelf).

ZIG-ZAG SHELF

CAT. NO.	W	D	H	WT.	PRICE
ZZ3008A	30	7	5 13/16	10.1	100.00
ZZ3608A	36	7	5 13/16	10.9	100.00
INSERT ONLY					
ZZPD	36	18	5	3.8	60.00

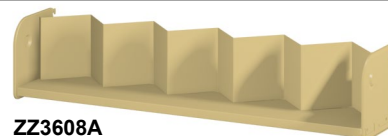

ZZ3608A

Adjustable shelf with paperback insert. Ideal for displaying audio cassette or paperback books.

NOTE: MOST PRODUCTS AVAILABLE IN 24"W AT AN UPCHARGE OF 25%.

CABINETS



Cabinet Only

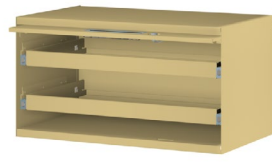

Cabinet With 2 Pull-Out Frames

All welded construction. Ideal for storing valuable items that need to be secured. Includes flipper door and lock with two keys.

CAT. NO.	W	D	H	WT.	PRICE
CABINET ONLY					
FDCB36L	36	17 5/8	15 1/2	53.0	1,248.00
CABINET WITH 1 PULL-OUT FRAME					
CBFD36LFA	36	17 5/8	15 1/2	63.0	1,248.00
CABINET WITH 2 PULL-OUT FRAMES					
CBFD36L2FA	36	17 5/8	15 1/2	73.0	1,248.00
FRAME ONLY					
FRAME36A	36	16	2	10.1	517.00

MEDIA HANGER RACK



Consists of brackets with hanger rod for clear-view plastic media bags.

CAT. NO.	W	D	H	WT.	PRICE
HB30A	30	6 1/2	4 1/4	2.1	84.00
HB36A	36	6 1/2	4 1/4	2.1	84.00

WORK SHELF AND BRACKETS



WORK SHELF WITH BRACKETS

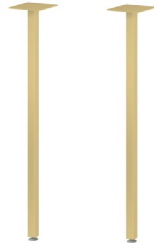

LEGS

CAT. NO.	W	D	H	WT.	PRICE
LC54A	36	24	27 1/2	30.0	1,003.00
LCL (Legs Only, Per Pair)				3.0	109.00
LCBRK24L (Left Bracket Only)				3.6	118.00
LCBRK24R (Right Bracket Only)				3.6	118.00

24" deep plastic laminate shelf supported by two steel triangular brackets for work surface with shelving range. Must state desired finish of work shelf.

METAL TRAYS

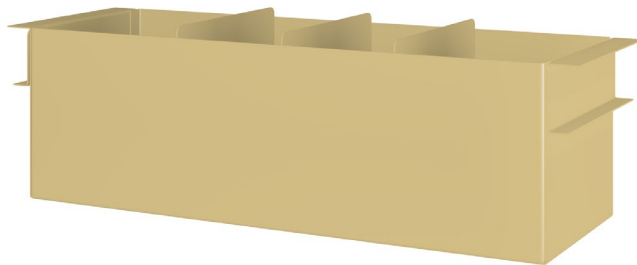

Handy metal trays store a wide variety of media. Use alone or in conjunction with Estey cabinets.

CAT. NO.	W	D	H	WT.	PRICE
FOR COMPACT DISCS					
TRCD514A	5 1/16	14 3/8	4 1/2	4.4	273.00
CDD-1 (Divider Only)				0.2	27.00
FOR AUDIOCASSETTES					
TRAC414A	4 7/16	14 3/8	3 1/8	3.3	386.00
ACD-1 (Divider Only)				0.2	36.00
FOR VHS TAPES					
TRVHS714A	7 5/8	14 3/8	3 1/8	5.1	299.00
VHSD-1 (Divider Only)				0.3	28.00
FOR 3x5 CARDS					
TRCRD3X5A	5 3/16	14 3/8	3 1/8	3.9	433.00
CRDD-1 (Divider Only)				0.2	56.00

METAL BROWSING BOX

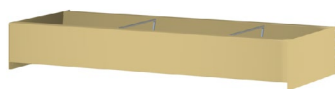

BROWSING BOX



DIVIDER

Ideal for storing all media items. Includes 2 wire dividers.

CAT. NO.	W	D	H	WT.	PRICE
BRB3005A	30	14 1/2	5 1/2	13.5	233.00
BRB3605A	36	14 1/2	5 1/2	15.3	243.00
BRBWD (Divider Only)				0.1	8.70

PULL-OUT BROWSING BOX

A pull out browsing box mounted on full extension ball-bearing suspensions. Ideal for storing all media items. XBRB3611A includes 2 wire dividers; XDBRB3611A includes 4 plate type dividers.

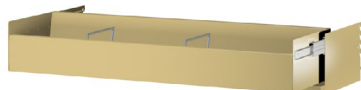

XBRB43611A



XHDBRB3611A

NOTE: The original XBRB3611A, with full-height front, is still available for a list price of \$400.00 and a weight of 30 lbs. Contact factory for further details.

CAT. NO.	W	D	H	WT.	PRICE
WITH SLIDING DIVIDER					
XBRB43611A	36	11 1/2	5 1/2	29.0	477.00
TXBWD (Divider Only)				0.3	10.40
WITH PLATE-TYPE DIVIDER and 3" FRONT					
XHDBRB3611A	36	11 1/2	5 1/2	31.0	661.00
BRBDIVA (Divider Only)				0.4	4.90

2" Weld Frame

NOTE: MOST PRODUCTS AVAILABLE IN 24"W AT AN UPCHARGE OF 25%.

NEWSPAPER RACK

CAT. NO.	TYPE	W	D	H	WT.	PRICE
NPR6	6 Holders	36	12	14	9.6	951.00
NPR10	10 Holders	36	12	22	15.2	1,403.00

Displays newspapers. Newspaper sticks included.



WALL HUNG COLUMNS

CAT. NO.	W	D	H	WT.	PRICE
PILWCH24	1 1/2	1	24	2.4	48.00
PILWCH30	1 1/2	1	30	2.4	48.00
PILWCH42	1 1/2	1	42	3.1	48.00
PILWCH54	1 1/2	1	54	3.8	51.00
PILWCH60	1 1/2	1	60	3.8	53.00
PILWCH66	1 1/2	1	66	3.8	61.00
PILWCH72	1 1/2	1	72	4.5	56.00
PILWCH78	1 1/2	1	78	4.5	58.00
PILWCH84	1 1/2	1	84	4.8	59.00
PILWCH90	1 1/2	1	90	5.2	61.00



Slotted strip attaches to wall. Designed to accept all components or accessory items. Special heights available. Hardware not included because of various wall construction.

CARD HOLDERS

CAT. NO.	W	D	H	WT.	PRICE
SINGLE CARD HOLDER					
SCH-B	5 1/4	—	3 1/8	0.1	2.80
DOUBLE CARD HOLDER					
DCH-B	10 1/4	—	3 1/8	0.2	5.10
ALUMINUM HOLDER					
SCH-CA	5 5/8	—	3 1/2	0.1	3.30



SCH-B



DCH-B

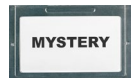

SCH-CA

For 3" x 5" cards. Used on end panels. Attaches with double-sided tape. Steel holders are finished in black powder coat paint.

TRANSVERSE OVERHEAD TOP TIE BRACING

CAT. NO.	W	D	H	WT.	PRICE
FOR WELD FRAME					
OTBW9	96	2	7/8	5.7	36.00

Channel construction top tie furnished in 8 foot lengths. Recommended for added stabilization when bases and shelves are of equal depths.

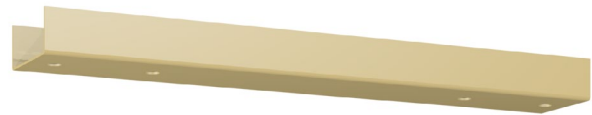

SHELF LABEL HOLDER

CAT. NO.	W	D	H	WT.	PRICE
SLH	5 1/2	2	3 3/4	0.1	1.10

Plastic clip-on holder 5/8" x 5" card. (Paper not included)



WALL CLIP

CAT. NO.	W	D	H	WT.	PRICE
WCLIP	3	2	1	0.2	1.10

Used to attach single face units to the wall for support. Wall hardware not included.



RANGE FINDER

CAT. NO.	W	D	H	WT.	PRICE
RFP6	—	6 3/4	3 1/8	0.2	5.00

For use on end panels or uprights for identification of range contents. Attaches with double-sided tape. Holds two 3" x 5" cards. Finished in black.



NOTE: MOST PRODUCTS AVAILABLE IN 24"W AT AN UPCHARGE OF 25%.

STEEL BOOK SUPPORTS



CAT. NO.	W	D	H	WT.	PRICE
WITH CORK BACKING					
BSN6	4 9/16	5 1/2	6	0.6	6.80
BSN9	4 9/16	5 1/2	9	1.1	8.20
WITH MAGNETIC STRIP					
BSM6	4 9/16	5 1/2	6	1.0	6.80
BSM9	4 9/16	5 1/2	9	1.1	8.20

Unattached book support used on surface of shelves. Furnished with cork backing or a magnetic strip, as specified above.

HOOK-ON BOOK SUPPORTS

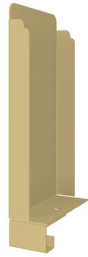

CAT. NO.	W	D	H	WT.	PRICE
LOBS6	4 9/16	1 3/4	6	0.6	9.30
LOBS9	4 9/16	1 3/4	9	1.2	10.20

Hooks onto return flange of adjustable shelves for rigid support.

WIRE BOOK SUPPORTS



6-INCH "V" SUPPORT



7-INCH "W" SUPPORT



9-INCH "V" SUPPORT



9-INCH "W" SUPPORT

CAT. NO.	TYPE	W	D	H	WT.	PRICE
WBS6	"V"	3/16	—	6	0.2	4.40
WBS9	"V"	3/16	—	9	0.3	4.90
WBSW7	"W"	3/16	—	7	0.3	5.80
WBSW9	"W"	3/16	—	9	0.4	6.80

Heavy spring wire book support. Attaches to underside of shelf. Easily adjustable.

SHELF FILLER

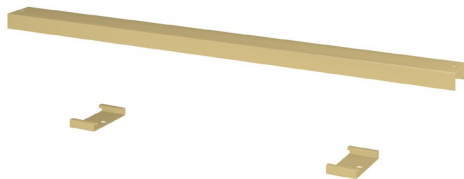

CAT. NO.	W	D	H	WT.	PRICE
SHFIL2-30	27	2	1	2.3	34.00
SHFIL2-36	33	2	1	2.6	34.00

Fills the space between adjustable shelves on double sided units, providing a continuous surface. Attaches with two clips that fasten to underside of shelves.

SLOPED ADJUSTABLE END BRACKET



LEFT BRACKET



RIGHT BRACKET

CAT. NO.	W	D	H	WT.	PRICE
SASBRK08LJ*	1/4	8	7 1/2	1.1	6.50
SASBRK09LJ*	1/4	9	7 1/2	1.2	6.90
SASBRK10LJ*	1/4	10	7 1/2	1.3	7.90
SASBRK11LJ*	1/4	11	7 1/2	1.5	8.70
SASBRK12LJ*	1/4	12	7 1/2	1.6	9.10
SASBRK13LJ*	1/4	13	7 1/2	1.7	9.70
SASBRK14LJ*	1/4	14	7 1/2	1.9	14.30

Creates 7 degrees of slope for an adjustable shelf. *NOTE: Listed catalog numbers are for left bracket only; for right bracket, change the suffix "LJ" to "RJ".

NOTE: MOST PRODUCTS AVAILABLE IN 24"W AT AN UPCHARGE OF 25%.

BASE FILLER CLOSURES

CAT. NO.	W	D	H	WT.	PRICE
FOR WELD FRAME					
BFC2-30	30	2	1	2.0	9.50
BFC2-36	36	2	1	1.6	9.50

Use to fill space between uprights when an adjustable base is used.

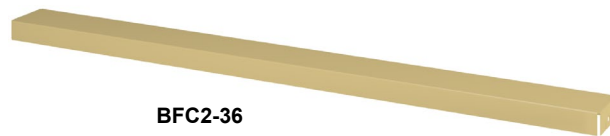

BFC2-36

CAT. NO.	W	D	H	WT.	PRICE
FOR MOBILE CARRIAGE					
BCC30-2	30	2	1 3/4	2.1	19.60
BCC36-2	36	2	1 3/4	2.5	22.00

Use to fill space between uprights when adjustable shelves are used on bottom of unit.

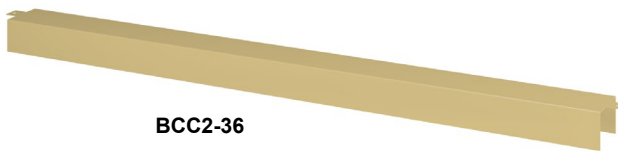

BCC2-36

ADJUSTABLE BACKSTOP

CAT. NO.	W	D	H	WT.	PRICE
ABS36	36	7/16	2	1.5	15.50

Individual backstop designed to engage in upright slots for adjustability.



REVERSIBLE BACKSTOP – WIRE DIVIDER

CAT. NO.	W	D	H	WT.	PRICE
BACK STOP					
RBS30	30	7/16	2	1.2	8.40
RBS36	36	7/16	2	1.3	8.40
WIRE DIVIDER					
BSWBS	—	8 1/2	4	0.2	4.10

One side is a regular backstop. The other side is a sliding support backstop (when used with wire divider sold above).



OFFSET CENTER BACKSTOP – LARGE PROFILE

CAT. NO.	W	D	H	WT.	PRICE
CBS30	30	3/8	3 9/32	1.7	26.00
CBS36	36	3/8	3 9/32	2.1	26.00

Works as a backstop for each side of a double entry unit, eliminating the need for an individual backstop for each side.

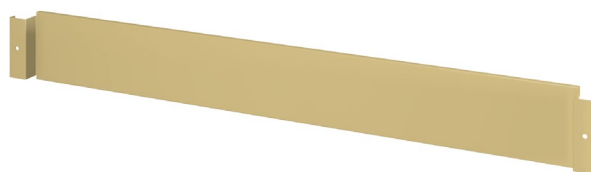

OFFSET CENTER BACKSTOP – SMALL PROFILE

CAT. NO.	W	D	H	WT.	PRICE
CBSS30	30	7/16	2	1.4	11.70
CBSS36	36	7/16	2	1.6	11.70

Works as a backstop for each side of a double entry unit, eliminating the need for an individual backstop for each side.



FLOOR ANCHOR

CAT. NO.	W	D	H	WT.	PRICE
FLRANCH3	1	3	5/8	0.1	2.40

Used to anchor weld frame units to the floor. For use with weld frame base brackets only. Zinc plated

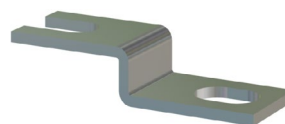

NOTE: MOST PRODUCTS AVAILABLE IN 24"W AT AN UPCHARGE OF 25%.

STEEL CANOPY TOPS



SINGLE FACE (CTS2)

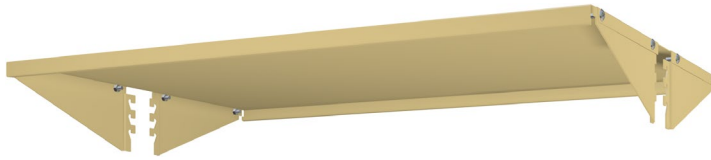

DOUBLE FACE (CTD)

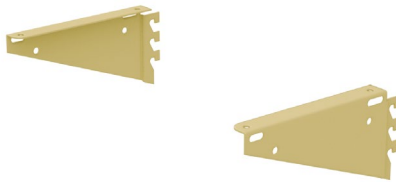

BRACKETS WITH HARDWARE

Keeps dust off your valuable materials. Includes attaching brackets.

*Attaching bracket is also used to secure steel end panels (see page 24). Each pair consists of one left and one right bracket.

CAT. NO.	W	D	H	WT.	PRICE
SINGLE FACE					
CTS2-3008	30	8	—	6.0	44.00
CTS2-3009	30	9	—	6.5	47.00
CTS2-3010	30	10	—	7.0	45.00
CTS2-3012	30	12	—	8.2	49.00
CTS2-3013	30	13	—	8.9	57.00
CTS2-3016	30	16	—	10.4	68.00
CTS2-3608	36	8	—	6.9	44.00
CTS2-3609	36	9	—	7.5	46.00
CTS2-3610	36	10	—	8.1	45.00
CTS2-3612	36	12	—	9.5	49.00
CTS2-3613	36	13	—	10.2	57.00
CTS2-3616	36	16	—	12.1	73.00
DOUBLE FACE					
CTD3016	30	16	—	9.3	75.00
CTD3018	30	18	—	10.2	81.00
CTD3020	30	20	—	11.3	78.00
CTD3024	30	24	—	13.5	86.00
CTD3026	30	26	—	14.8	102.00
CTD3032	30	32	—	17.9	128.00
CTD3616	36	16	—	10.8	76.00
CTD3618	36	18	—	11.8	81.00
CTD3620	36	20	—	13.0	78.00
CTD3624	36	24	—	15.6	86.00
CTD3626	36	26	—	16.9	103.00
CTD3632	36	32	—	20.0	135.00
BRACKETS WITH HARDWARE					
CTB08S	—	8	—	1.2	14.50
CTB09S	—	9	—	1.3	15.10
CTB10S	—	10	—	1.4	12.50
CTB12S	—	12	—	1.8	13.50
CTB13S	—	13	—	2.0	17.10
CTB16S	—	16	—	2.4	22.00

CANOPY BRACKETS FOR WOOD TOPS

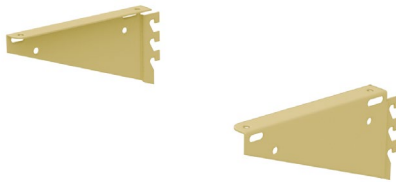

BRACKETS ONLY

Used when wood or hard plastic canopy tops are used. For single face units, use 1 pair. For double face units, use 2 pairs. Each pair consists of one left and one right bracket. Wood top and hardware not included.

CAT. NO.	DEPTH	WT.	PRICE
BRACKETS ONLY			
CTIB08S (1 Pair)	8	1.0	14.20
CTIB09S (1 Pair)	9	1.1	14.80
CTIB10S (1 Pair)	10	1.2	11.80
CTIB12S (1 Pair)	12	1.6	13.00
CTIB13S (1 Pair)	13	1.8	17.40
CTIB16S (1 Pair)	16	2.2	23.40
CTIB18S (1 Pair)	18	2.6	24.20

CANOPY SIGNAGE



Easily identify special items or sections with this customizable label holder. Three attachment clips provided.

CAT. NO.	W	D	H	WT.	PRICE
CPSGN36	35 1/4	—	1 3/4	1.5	123.00

Material in aluminum. Cannot be painted.

NOTE: MOST PRODUCTS AVAILABLE IN 24"W AT AN UPCHARGE OF 25%.

FIXED BASE/ADJUSTABLE BASE REINFORCING GUSSETS

CAT. NO.	W	D	H	WT.	PRICE
SINGLE FACE					
GS2-08AL (left)	1/16	8	39 7/8	5.0	54.00
GS2-08AR (right)	1/16	8	39 7/8	5.0	54.00
GS2-09AL (left)	1/16	9	39 7/8	6.3	62.00
GS2-09AR (right)	1/16	9	39 7/8	6.3	62.00
GS2-10AL (left)	1/16	10	39 7/8	6.2	65.00
GS2-10AR (right)	1/16	10	39 7/8	6.2	65.00
GS2-12AL (left)	1/16	12	39 7/8	6.2	72.00
GS2-12AR (right)	1/16	12	39 7/8	6.2	72.00
GS2-13AL (left)	1/16	13	39 7/8	8.5	75.00
GS2-13AR (right)	1/16	13	39 7/8	8.5	75.00
GS2-16AL (left)	1/16	16	39 7/8	7.8	85.00
GS2-16AR (right)	1/16	16	39 7/8	7.8	78.00
DOUBLE FACE					
GD2-081A	1/16	16	39 7/8	8.2	64.00
GD2-091A	1/16	18	39 7/8	6.6	70.00
GD2-101A	1/16	20	39 7/8	8.7	83.00
GD2-121A	1/16	24	39 7/8	9.7	90.00
GD2-131A	1/16	26	39 7/8	13.6	94.00
GD2-161A	1/16	32	39 7/8	13.9	122.00

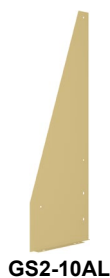

GS2-10AL



GS2-10AR



GD2-101A

Used when fixed base shelving units are to be mounted on mobile carriage bases or when additional stabilization is required. Also available for adjustable base shelving units; to order, add "J" to end of catalog number and call factory for pricing and weights. (e.g. GS2-16LJA)

MOBILE CARRIAGE REINFORCING GUSSETS

CAT. NO.	W	D	H	WT.	PRICE
SINGLE FACE					
GS2-08CAL (left)	1/16	8	39 7/8	5.5	53.00
GS2-08CAR (right)	1/16	8	39 7/8	5.5	53.00
GS2-09CAL (left)	1/16	9	39 7/8	6.1	57.00
GS2-09CAR (right)	1/16	9	39 7/8	6.1	57.00
GS2-10CAL (left)	1/16	10	39 7/8	6.6	64.00
GS2-10CAR (right)	1/16	10	39 7/8	6.6	64.00
GS2-12CAL (left)	1/16	12	39 7/8	5.1	70.00
GS2-12CAR (right)	1/16	12	39 7/8	5.1	70.00
GS2-13CAL (left)	1/16	13	39 7/8	8.4	69.00
GS2-13CAR (right)	1/16	13	39 7/8	8.4	69.00
GS2-16CAL (left)	1/16	16	39 7/8	10.1	78.00
GS2-16CAR (right)	1/16	16	39 7/8	10.1	78.00
DOUBLE FACE					
GD2-08CA	1/16	16	39 7/8	6.7	70.00
GD2-09CA	1/16	18	39 7/8	7.4	77.00
GD2-10CA	1/16	20	39 7/8	8.3	83.00
GD2-12CA	1/16	24	39 7/8	8.7	93.00
GD2-13CA	1/16	26	39 7/8	10.4	102.00
GD2-16CA	1/16	32	39 7/8	12.6	121.00

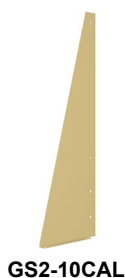

GS2-10CAL



GS2-10CAR



GD2-10CA

Used when adjustable shelves (in lieu of a base shelf and base bracket) are used as a base and are to be mounted on mobile carriage tracks only.

CORNER FILLERS

CAT. NO.	HEIGHTS	DEPTHS	WT.	PRICE
SCF2-hhddA	42" to 93"	8" to 32"		CALL FACTORY

Used to make a corner for units placed at right angles to each other. Available in all heights and depths. Specify height and depth (hhdd) when ordering.

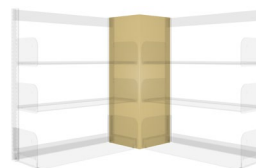

INTERMEDIATE WALL FILLERS

CAT. NO.	HEIGHTS	DEPTHS	WT.	PRICE
DCF2-hhddA	42" to 93"	8" to 32"		CALL FACTORY

Used to fill a void where two single faced units are joined at a right angle with a double faced unit. Available for all base shelf depths and frame heights. Specify height and depth (hhdd) when ordering.

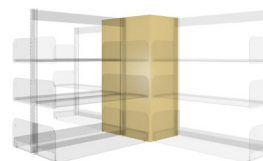

NOTE: MOST PRODUCTS AVAILABLE IN 24"W AT AN UPCHARGE OF 25%.

END PANELS

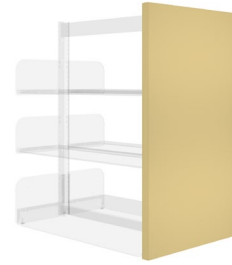

SINGLE FACE

CAT. NO.	BASE DEPTH	HEIGHT	WT.	PRICE
WSP2-4208A	8	42	13.5	122.00
WSP2-4209A	9	42	12.5	124.00
WSP2-4210A	10	42	13.1	128.00
WSP2-4212A	12	42	14.5	133.00
WSP2-4213A	13	42	14.9	137.00
WSP2-4216A	16	42	16.7	158.00
WSP2-6608A	8	66	18.5	158.00
WSP2-6609A	9	66	19.5	162.00
WSP2-6610A	10	66	21.0	167.00
WSP2-6612A	12	66	25.0	175.00
WSP2-6613A	13	66	23.0	180.00
WSP2-6616A	16	66	26.0	205.00
WSP2-7808A	8	78	22.0	174.00
WSP2-7809A	9	78	23.0	180.00
WSP2-7810A	10	78	24.0	185.00
WSP2-7812A	12	78	27.0	195.00
WSP2-7813A	13	78	27.0	201.00
WSP2-7816A	16	78	31.0	218.00
WSP2-8408A	8	84	24.0	184.00
WSP2-8409A	9	84	25.0	190.00
WSP2-8410A	10	84	26.0	195.00
WSP2-8412A	12	84	26.0	200.00
WSP2-8413A	13	84	30.0	212.00
WSP2-8416A	16	84	33.0	221.00
WSP2-9008A	8	90	25.0	192.00
WSP2-9009A	9	90	27.0	198.00
WSP2-9010A	10	90	27.0	204.00
WSP2-9012A	12	90	31.0	216.00
WSP2-9013A	13	90	32.0	222.00
WSP2-9016A	16	90	36.0	232.00
WSP2-9308A	8	93	26.0	230.00
WSP2-9309A	9	93	27.0	235.00
WSP2-9310A	10	93	29.0	242.00
WSP2-9312A	12	93	31.0	254.00
WSP2-9313A	13	93	33.0	261.00
WSP2-9316A	16	93	37.0	280.00

DOUBLE FACE

CAT. NO.	BASE DEPTH	HEIGHT	WT.	PRICE
WDP2-4216A	16	42	21.0	229.00
WDP2-4218A	18	42	22.0	233.00
WDP2-4220A	20	42	24.0	240.00
WDP2-4224A	24	42	24.0	248.00
WDP2-4226A	26	42	28.0	268.00
WDP2-4232A	32	42	23.0	285.00
WDP2-6616A	16	66	30.0	289.00
WDP2-6618A	18	66	24.0	296.00
WDP2-6620A	20	66	34.0	307.00
WDP2-6624A	24	66	38.0	336.00
WDP2-6626A	26	66	40.0	345.00
WDP2-6632A	32	66	46.0	372.00
WDP2-7816A	16	78	35.0	313.00
WDP2-7818A	18	78	37.0	322.00
WDP2-7820A	20	78	39.0	335.00
WDP2-7824A	24	78	45.0	352.00
WDP2-7826A	26	78	46.0	377.00
WDP2-7832A	32	78	53.0	408.00
WDP2-8416A	16	84	37.0	331.00
WDP2-8418A	18	84	39.0	342.00
WDP2-8420A	20	84	33.0	355.00
WDP2-8424A	24	84	37.0	379.00
WDP2-8426A	26	84	49.0	400.00
WDP2-8432A	32	84	57.0	433.00
WDP2-9016A	16	90	41.0	341.00
WDP2-9018A	18	90	42.0	352.00
WDP2-9020A	20	90	46.0	355.00
WDP2-9024A	24	90	52.0	391.00
WDP2-9026A	26	90	52.0	413.00
WDP2-9032A	32	90	60.0	454.00
WDP2-9316A	16	93	40.0	359.00
WDP2-9318A	18	93	43.0	370.00
WDP2-9320A	20	93	46.0	384.00
WDP2-9324A	24	93	54.0	414.00
WDP2-9326A	26	93	54.0	427.00
WDP2-9332A	32	93	62.0	467.00

Optional attaching brackets available for added stability; see page 22.

STEEL BACKS

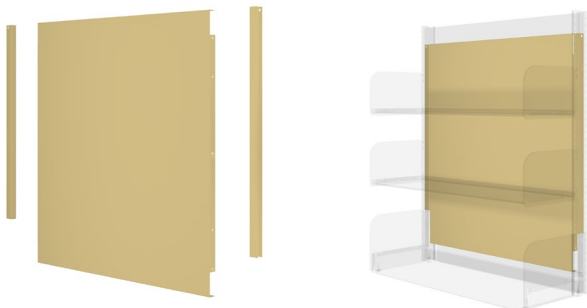

CAT. NO.	W	D	H	WT.	PRICE
WNB3042A	30	1	42	17.9	181.00
WNB3066A	30	1	66	30.0	283.00
WNB3078A	30	1	78	36.0	319.00
WNB3084A	30	1	84	39.0	331.00
WNB3090A	30	1	90	42.0	352.00
WNB3642A	36	1	42	21.0	181.00
WNB3666A	36	1	66	35.0	283.00
WNB3678A	36	1	78	42.0	319.00
WNB3684A	36	1	84	46.0	332.00
WNB3690A	36	1	90	49.0	352.00

24" wide backs are available at a 25% upcharge. Contact factory for weights.

2" Weld Frame

Single Face

CAT. NO.	W	D	H	WT.	PRICE
STARTER UNITS					
DSS4236S	36	13	42	63	801.00
DSS5436S	36	14	54	76	781.00
DSS6636S	36	16	66	93	921.00

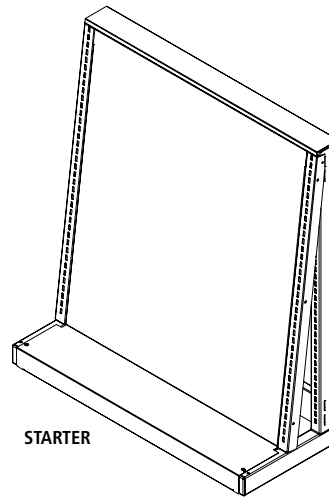

STARTER

DSS5436S

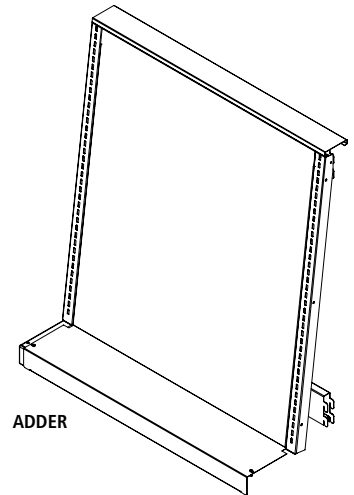

ADDER

DSS5436A

CAT. NO.	W	D	H	WT.	PRICE
ADDER UNITS					
DSS4236A	36	13	42	50	589.00
DSS5436A	36	14	54	61	586.00
DSS6636A	36	16	66	71	672.00

Upright assembly gives the shelving a clean, contemporary look and added strength without compromising aisle space or storage capacity.

NOTE: Assemblies do NOT include accessories. Add accessories to create a functional shelving unit.

Double Face

CAT. NO.	W	D	H	WT.	PRICE
STARTER UNITS					
DSD4236S	36	26	42	101	1,080.00
DSD5436S	36	28	54	125	1,196.00
DSD6636S	36	32	66	149	1,280.00

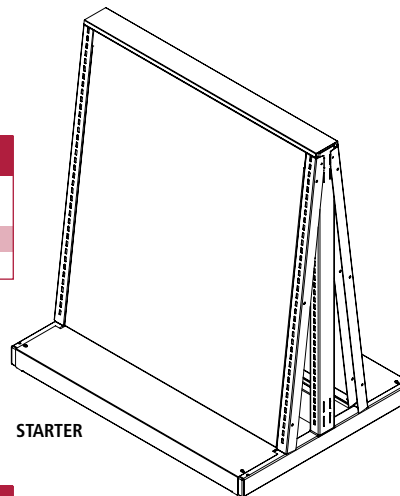

STARTER

DSD5436S

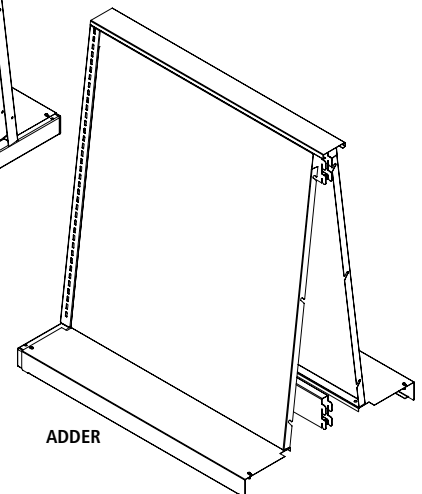

ADDER

DSD5436A

CAT. NO.	W	D	H	WT.	PRICE
ADDER UNITS					
DSD4236A	36	26	42	82	820.00
DSD5436A	36	28	54	104	891.00
DSD6636A	36	32	66	121	965.00

Upright assembly gives the shelving a clean, contemporary look and added strength without compromising aisle space or storage capacity.

NOTE: Assemblies do NOT include accessories. Add accessories to create a functional shelving unit.

DIVIDER BROWSER SHELF

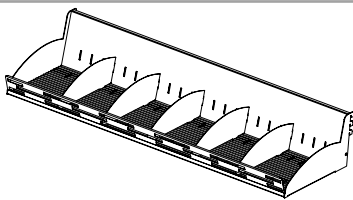

CAT. NO.	W	D	H	WT.	PRICE
BRS3611A	36	12	6	13.4	254.00
EXTRA DIVIDER					
BRSDIV11	3/64	10	3 3/64	0.4	3.90

Ideal for storing a wide variety of media items. Shelf includes 5 dividers and an attractive front profile.

MAGAZINE SHELF

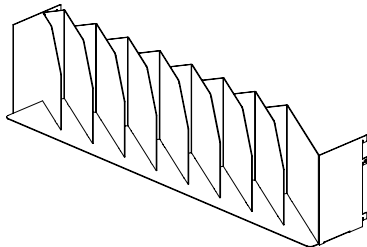

CAT. NO.	W	D	H	WT.	PRICE
DSDMS36LF	36	7	8	18.3	395.00

Perfect for any retail environment, our magazine shelf includes 8 fixed dividers to showcase your periodicals.

MEDIA/PAPERBACK SHELF

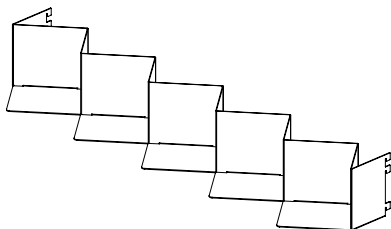

CAT. NO.	W	D	H	WT.	PRICE
DSDAV36	36	8	5	7.2	144.00

Our zig-zag design is the perfect solution when displaying Blu-rays, DVDs, CDs, audio books, paperbacks and more.

FLAT SHELVES

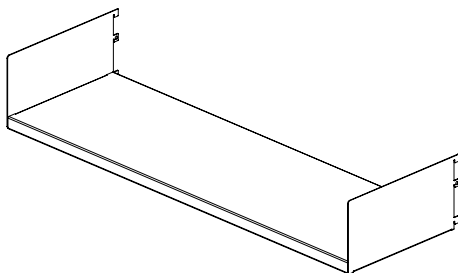

CAT. NO.	W	D	H	WT.	PRICE
ED3608A	36	8	6	7.1	44.00
ED3609A	36	9	6	7.8	52.00
ED3610A	36	10	6	8.6	45.00
ED3611A	36	11	6	9.5	48.00
ED3612A	36	12	6	10.2	50.00

Display hard backed books and other media with our attractive, adjustable shelf.

CASTER KITS

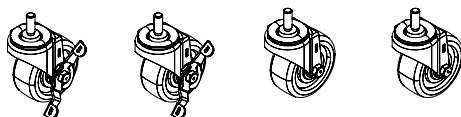

DSCK-S

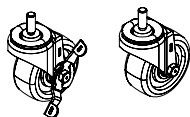

DSCK-A

CAT. NO.	W	D	H	WT.	PRICE
CASTER KIT FOR STARTER UNIT					
DSCK-S	2 with brakes, 2 without brakes			4.0	210.00

CAT. NO.	W	D	H	WT.	PRICE
CASTER KIT FOR ADDER UNIT					
DSCK-A	1 with brake, 1 without brake			2.0	110.00

Adding 3" diameter swivel casters to your A-Frame Display Shelving System allows you to adapt your library space as your needs evolve.

NOTE: A-Frame display shelving does not support ANY other accessories, aside from those listed above.