

SIII SERIES

Multiple upgrades were forged into one







360-375W



● SIII SERIES

Seraphim redefined the high-efficiency module series by integrating 166mm silicon wafers with multi-busbar and half-cut cell technologies. Seraphim panel combined creative technology effectively and extremely improved the module efficiency and power output.

● KEY FEATURES

-  Less mismatch to get more power
-  Less power loss by minimizing the shading impact
-  Competitive low light performance
-  3 times EL test to ensure best quality
-  Ideal choice for utility and commercial scale projects by reduced BoS and improved ROI
-  **PVEL** Outstanding reliability proven by PVEL for stringent environment condition:
 - Sand, acid, salt and hail stones
 - 2400 Pa wind load and 5400 Pa snow load
 - Anti-PID

● QUALITY SYSTEM

ISO9001 / ISO14001 / ISO45001

● PRODUCT CERTIFICATION



● INSURANCE



● WARRANTY

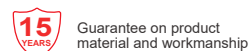
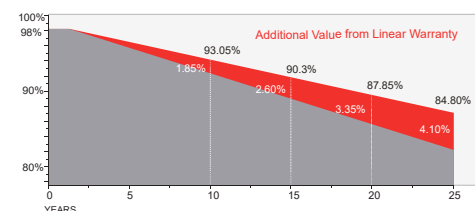

Electrical Characteristics

Module Type	SRP-360-BMB-HV		SRP-365-BMB-HV		SRP-370-BMB-HV		SRP-375-BMB-HV	
	STC	NOCT	STC	NOCT	STC	NOCT	STC	NOCT
Maximum Power at STC (Pmp)	360	271	365	275	370	277	375	282
Open Circuit Voltage (Voc)	41.2	38.5	41.4	38.6	41.6	38.8	41.8	39.0
Short Circuit Current (Isc)	11.16	9.02	11.26	9.10	11.34	9.17	11.41	9.22
Maximum Power Voltage (Vmp)	34.2	31.8	34.4	31.9	34.6	32.0	34.8	32.3
Maximum Power Current (Imp)	10.53	8.53	10.62	8.61	10.70	8.66	10.78	8.74
Module Efficiency at STC(ηm)	19.76		20.04		20.31		20.59	
Power Tolerance	(0, +3%)							
Maximum System Voltage	1500V DC							
Maximum Series Fuse Rating	20 A							

STC: Irradiance 1000 W/m² module temperature 25°C AM=1.5
Power measurement tolerance: +/-3%

Temperature Characteristics

Pmax Temperature Coefficient	-0.35 %/°C
Voc Temperature Coefficient	-0.27 %/°C
Isc Temperature Coefficient	+0.05 %/°C
Operating Temperature	-40 ~ +85 °C
Nominal Operating Cell Temperature (NOCT)	45±2 °C

Mechanical Specifications

External Dimensions	1755 x 1038 x 35 mm
Weight	19.5 kg
Solar Cells	PERC Mono 166 x 83mm (120 pcs)
Front Glass	3.2mm AR coating tempered glass, low iron
Frame	Anodized aluminium alloy
Junction Box	IP68, 3 diodes
Output Cables	4.0mm ² , 250mm(+)/350mm(-) or Customized Length
Mechanical Load	Front side 5400Pa/ Rear side 2400Pa

Packing Configuration

	1755 x 1038 x 35 mm	
Container	20'GP	40'HQ
Pieces per Pallet	31+4*	31+2*
Pallets per Container	6	24
Pieces per Container	210	792

* 31+2 and 31+4 pieces per pallet is the special package which only suits for container transport.
For details, please consult SERAPHIM.

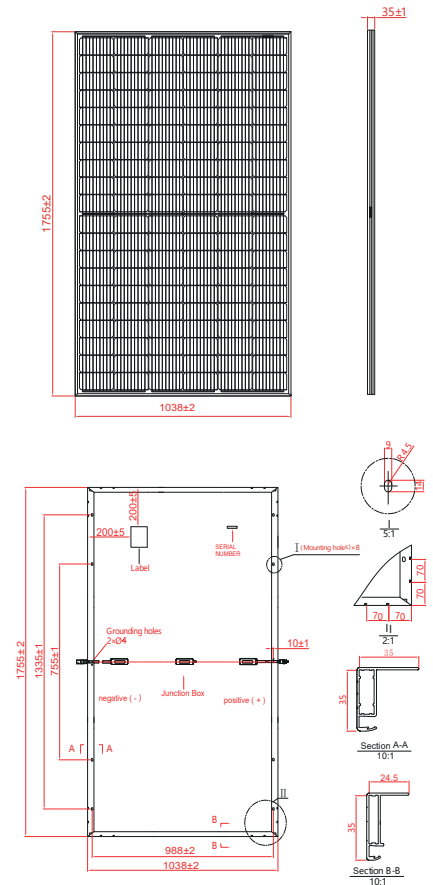

I-V Curve

