

YAMAHA

GOLF CAR

**OWNER'S/
OPERATORS
MANUAL**

**G8A
G8E**

INTRODUCTION

Congratulations on your purchase of your new Yamaha.

This manual will provide you with a good basic understanding of the operation, and maintenance of this machine. If you have any questions regarding the operation or maintenance of your machine, please consult a Yamaha dealer.

**SERVICE DEPT
LEISURE VEHICLES & O.P.E.
OPERATIONS
YAMAHA MOTOR CO., LTD.**

**G8-A, G8-E
OWNER'S MANUAL
©1993 by Yamaha Motor
Manufacturing Corporation
of America
1st edition, April 1993
All rights reserved. Any reprinting
or unauthorized use without the
written permission of
Yamaha Motor Manufacturing
Corporation of America
is expressly prohibited.
Printed in Japan
P/N LIT-19626-00-58**

WARNING

PLEASE READ AND UNDERSTAND THIS MANUAL COMPLETELY BEFORE OPERATING THE MACHINE.

NOTE: _____

- Yamaha continually seeks advancements in product design and quality. Therefore, while this manual contains the most current product information available at the time of printing, there may be minor discrepancies between your machine and this manual. If there is any question concerning this manual, please consult your Yamaha dealer.
 - This manual should be considered a permanent part of this machine and should remain with this machine when resold.
-

Particularly important information is distinguished in this manual by the following notations.



The Safety Alert Symbol means **ATTENTION! BECOME ALERT! YOUR SAFETY IS INVOLVED!**

NOTE:

A NOTE provides key information to make procedures easier or clearer.

IMPORTANT

A IMPORTANT indicates special precautions that must be taken to avoid damage to the machine.

WARNING

Failure to follow WARNING instructions could result in severe injury or death to the machine operator, a bystander, or a person inspecting or repairing the machine.

CONTENTS

WARRANTY	1
LOCATION OF IMPORTANT LABELS	2
SAFETY INFORMATION	3
MACHINE IDENTIFICATION	4
CONTROL FUNCTION	5
PRE-OPERATION CHECK	6
OPERATION	7
PERIODIC MAINTENANCE	8
STORAGE	9
SPECIFICATIONS	10
WIRING DIAGRAM	11

YAMAHA MOTOR MANUFACTURING CORPORATION OF AMERICA

G8 GOLF CAR LIMITED WARRANTY

1

Yamaha Motor Manufacturing Corporation of America hereby warrants that any new G8 (gas and electric models) Yamaha Golf Car purchased from an authorized Yamaha dealer in the continental United States, will be free from defects in material and workmanship for the period of time stated herein, subject to the stated limitations.

THE PERIOD OF WARRANTY for any G8 (gas and electric models) will be three years from date of purchase.

The first year of warranty shall cover the entire car except for batteries, battery chargers, tires and rims, which are warranted by their respective manufacturers.

The second year of warranty shall cover the engine assembly, clutch, transmission, axles, electrical system, frame, suspension components, electric motor, control cables, and steering gear.

Parts excluded from the second year of warranty include the body parts, seats, mats, bumper assembly, bag carrier, scorecard holder, and trim.

The third year of warranty shall cover the engine assembly, clutch, transmission, axles, frame, suspension components, steering gear, and electronic speed controller (on G8-E).

Parts excluded from the third year of warranty include the second year exclusions and the electrical system (except electronic speed controller), electric motor, and control cables.

DURING THE PERIOD OF WARRANTY any authorized Yamaha Golf Car Dealer will, free of charge, repair or replace, at Yamaha's option, any part adjudged defective by Yamaha due to faulty workmanship or material from the factory. Parts used in warranty repairs will be warranted for the balance of the machine's warranty period. All parts replaced under warranty become property of Yamaha Motor Manufacturing Corporation of America.

GENERAL EXCLUSIONS from this warranty shall include any failures caused by:

- a. Abnormal strain, neglect, or abuse, including lack of proper maintenance, and use contrary to the owner's manual instructions.
- b. Accident or collision damage.
- c. Installation of parts or accessories that are not original equipment.
- d. Fading, rust, or deterioration due to exposure or ordinary wear and tear.
- e. Modification or alteration that affects the car's condition, operation, performance, or durability, or which makes the car serve a purpose other than use as a two-person, golf course vehicle.

SPECIFIC EXCLUSIONS from this warranty shall include any parts replaced due to normal wear or routine maintenance, including oil, air filter elements, brake shoes, spark plugs, starter, and clutch drive belts. Any charges incurred in transporting a golf car to and from an authorized Yamaha Golf Car Dealer for service or in performing field service is also excluded from this warranty.

THE CUSTOMER'S RESPONSIBILITY under this warranty shall be to:

1. Operate and maintain the golf car as specified in the appropriate Owner's Manual;
2. Give notice to an authorized Yamaha dealer of any and all apparent defects within ten (10) days after discovery, and make the machine available at that time for inspection and repairs by the dealer's authorized representative.

WARRANTY TRANSFER: To transfer any remaining warranty from the original purchaser to any subsequent purchaser, it is imperative that the machine be inspected and registered for warranty by an authorized Yamaha Golf Car Dealer. In order for this warranty to remain in effect, this inspection and registration must take place within ten (10) days after transfer. An inspection and registration fee will be charged for this service.

YAMAHA MOTOR MANUFACTURING CORPORATION OF AMERICA MAKES NO OTHER WARRANTY OF ANY KIND, EXPRESSED OR IMPLIED. ALL IMPLIED WARRANTIES OF MERCHANTABILITY AND FITNESS FOR A PARTICULAR PURPOSE WHICH EXCEED THE OBLIGATIONS AND TIME LIMITS STATED IN THIS WARRANTY ARE HEREBY DISCLAIMED BY YAMAHA MOTOR MANUFACTURING CORPORATION OF AMERICA AND EXCLUDED FROM THIS WARRANTY.

SOME STATES DO NOT ALLOW LIMITATIONS ON HOW LONG AN IMPLIED WARRANTY LASTS, SO THE ABOVE LIMITATION MAY NOT APPLY TO YOU. ALSO EXCLUDED FROM THIS WARRANTY ARE ANY INCIDENTAL OR CONSEQUENTIAL DAMAGES INCLUDING LOSS OF USE. SOME STATES DO NOT ALLOW THE EXCLUSION OR LIMITATION OF INCIDENTAL OR CONSEQUENTIAL DAMAGES, SO THE ABOVE EXCLUSION MAY NOT APPLY TO YOU.

THIS WARRANTY GIVES YOU SPECIFIC LEGAL RIGHTS, AND YOU MAY ALSO HAVE OTHER RIGHTS WHICH VARY FROM STATE TO STATE.

YAMAHA MOTOR MANUFACTURING
CORPORATION OF AMERICA
Newnan, Georgia 30265-1320, U.S.A.

LOCATION OF IMPORTANT LABELS

Please read the following labels carefully before operating this machine.

NOTE: _____
 Maintain or replace safety and instruction labels, as necessary.

2

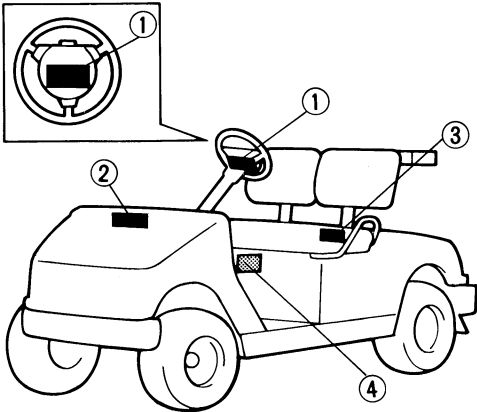

①

OPERATING INSTRUCTIONS

- READ WARNING LABEL ON THE INSTRUMENT PANEL BEFORE OPERATING.
- BE SURE OCCUPANTS ARE SEATED.
- SELECT FORWARD OR REVERSE BEFORE TURNING MAIN SWITCH TO "ON".
- THIS VEHICLE STARTS AUTOMATICALLY WHEN ACCELERATOR PEDAL IS DEPRESSED. RELEASE THE PEDAL AND APPLY BRAKE TO STOP
- VARY THE SPEED OF THE VEHICLE TO MATCH THE TERRAIN.
- BRING THE VEHICLE TO A COMPLETE STOP BEFORE REVERSING DIRECTION.
- DRIVE WITH EXTRA CARE IN CONGESTED AREAS AND WHEN OPERATING IN REVERSE.
- ALWAYS SET PARKING BRAKE SECURELY AND TURN MAIN SWITCH TO "OFF" BEFORE LEAVING THE VEHICLE.
- PARKING BRAKE WILL RELEASE WHEN ACCELERATOR PEDAL IS DEPRESSED.
- DO NOT EXCEED THE FACTORY SPEED SETTING OF 12 MPH UNDER ANY CIRCUMSTANCES.
- READ THE OWNER'S MANUAL FOR FURTHER INFORMATION.

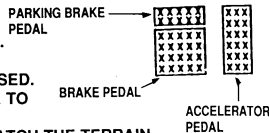

ATTENTION

- THIS VEHICLE WAS NOT MANUFACTURED FOR USE ON PUBLIC STREETS AND DOES NOT COMPLY WITH FEDERAL MOTOR VEHICLE SAFETY STANDARDS APPLICABLE TO PASSENGER CARS.

②

⚠ WARNING

FAILURE TO FOLLOW THESE INSTRUCTIONS CAN RESULT IN SEVERE PERSONAL INJURY OR DEATH.

- OPERATION BY AUTHORIZED ADULTS ONLY AND ONLY IN DESIGNATED AREAS.
- THIS VEHICLE IS RESTRICTED TO TWO OCCUPANTS.
- DO NOT START THE VEHICLE UNTIL ALL OCCUPANTS ARE SEATED.
- REMAIN SEATED AND HOLD ON WHEN IN MOTION.
- KEEP ENTIRE BODY INSIDE VEHICLE.
- DRIVE SLOWLY IN TURNS.
- DRIVE SLOWLY STRAIGHT UP AND DOWN SLOPES.
- SET PARKING BRAKE BEFORE LEAVING VEHICLE.
- TURN MAIN SWITCH TO "OFF" AND REMOVE KEY WHEN NOT IN USE.
- READ OPERATING INSTRUCTIONS ON STEERING WHEEL BEFORE OPERATION.

2

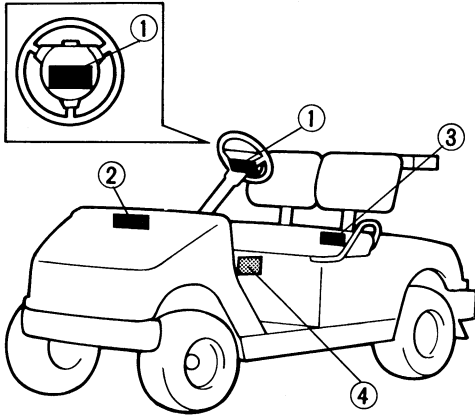

③ for G8-A

GASOLINE RECOMMENDATION REGULAR UNLEADED ONLY

NOTICE : MOTOR OIL FOR ENGINE

- SHOULD BE 10W-30 API SERVICE SE OR SF.
- CHECK OIL LEVEL PERIODI ALLY ACCORDING TO OWNER'S MANUAL.

④ for G8-E

BATTERY INSTALLATION AND WIRE LEAD CONNECTION

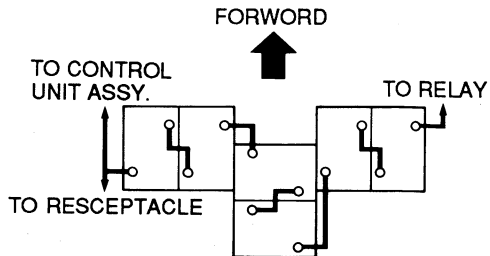

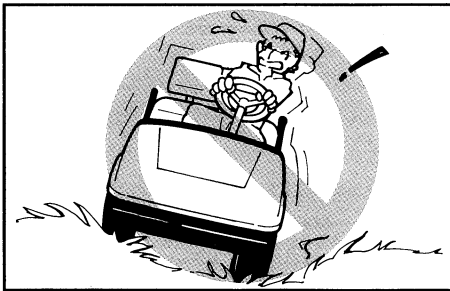
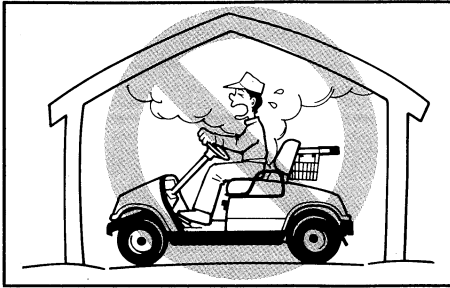

⚠ SAFETY INFORMATION

Yamaha golf car are designed to be simple to operate. However, be sure to observe the following:

- Read all warning and instruction labels on the vehicle before operating.
- Bring the car to a complete stop before changing directions.
- Do not depress the accelerator pedal before turning on the main switch.
- Avoid starting or stopping abruptly; it's hard on the turf.
- Avoid turning the steering wheel too sharply at high speed, an accident may result.
- Keep your hands on the wheel and your eyes on the path ahead.
- Always drive straight up or straight down inclines; never at an angle.
- When backing up, do so slowly, and watch where you are going.
- Park the car on a level surface as much as possible.
- Do not leave car unattended unless the main switch is in the "OFF" position or key is removed, and the parking brake is on.

Accidental movement of the accelerator pedal may cause it to coast down an incline.

- Never allow more than two people to ride in the car.
- Do not hold the vehicle on any hill/incline with the accelerator.
Use the brake.
- If the golf car is rented or loaned, be sure the operator understands the controls and has read the warning and instruction labels before operating.

MACHINE IDENTIFICATION

The machine serial number is stamped in the location shown.

A G8-A

B G8-E

The engine model number is stamped in the location shown.

(For G8-A)

NOTE: _____
The first three digits of these numbers are for model identification; the remaining digits are the unit production number. Keep a record of these numbers for reference when ordering parts from a Yamaha dealer.

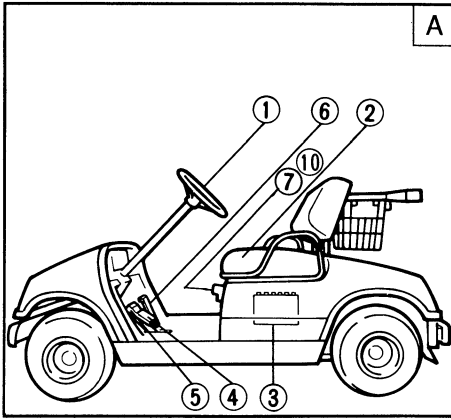

CONTROL FUNCTION

DESCRIPTION

- ① Steering wheel
- ② Seat
- ③ Battery
- ④ Brake pedal
- ⑤ Parking brake pedal
- ⑥ Accelerator pedal
- ⑦ Drive select lever
- ⑧ Main switch
- ⑨ OIL warning light (for G8-A)
- ⑩ Choke knob (for G8-A)
- ⑪ Front cowl
- ⑫ Front tire
- ⑬ Front bumper
- ⑭ Rear cowl
- ⑮ Rear bumper
- ⑯ Rear tire
- ⑰ Fuel cap (For G8-A)
- ⑱ Receptacle (For G8-E)

5

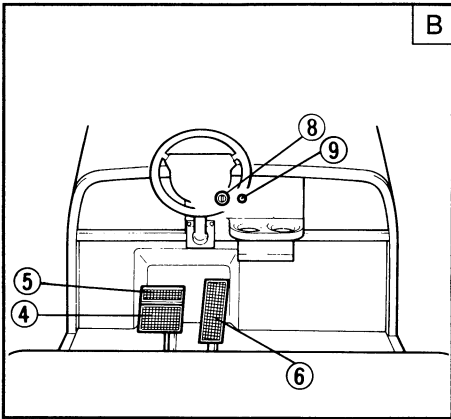

- A Side View
- B Control panel View
- C Front View
- D Rear View

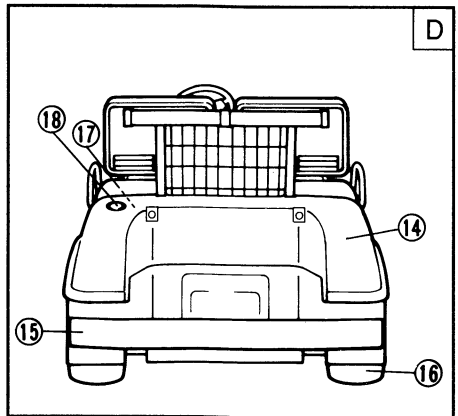
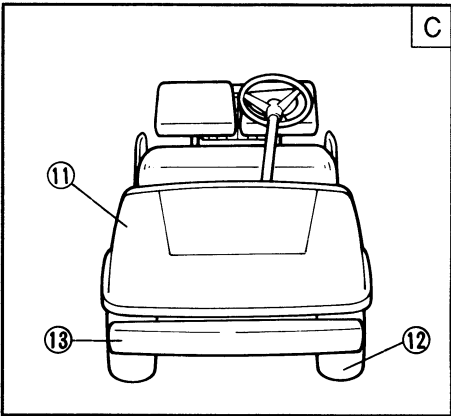

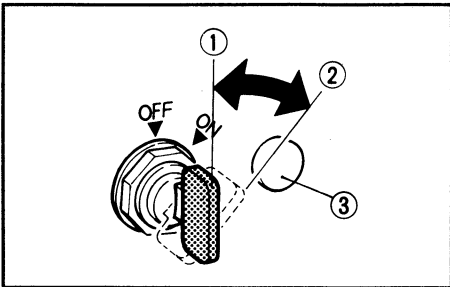
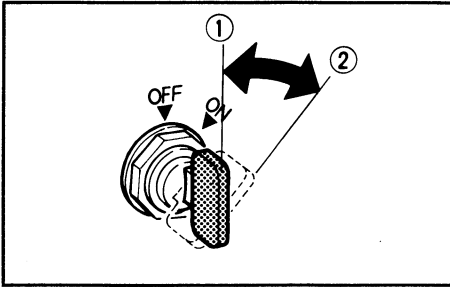
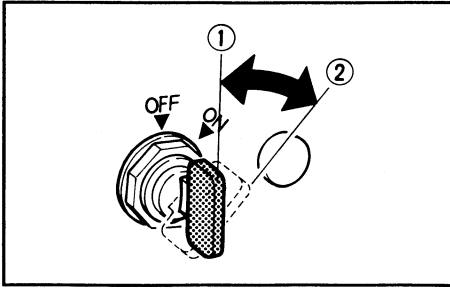

MAIN SWITCH

The main switch controls the following items.

OFF:

Ignition circuit is switched off.

The key can be removed only in this position.

ON:

Ignition circuit is switched on.

The engine can be started.

① "OFF"

② "ON"

For G8-E

OFF:

Electrical circuits are switched off.

The key can be removed only in this position.

ON:

Electrical circuits are switched on.

① "OFF"

② "ON"

OIL WARNING LIGHT

(For G8-A)

When the oil level falls below the lower level, this light comes on. If the light comes on, stop the engine as soon as it is safe to do so. Add engine oil. (See page 6-2)

IMPORTANT:

- Do not run the machine until you know the engine has enough engine oil.
- Do not overfill the engine oil.

① "OFF"

② "ON"

③ OIL WARNING LIGHT

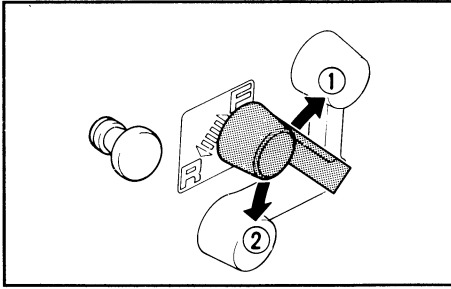

DRIVE SELECT LEVER

Use this lever to change the direction of machine.

Lever position	Machine movement
① "F"	FORWARD
② "R"	REVERSE

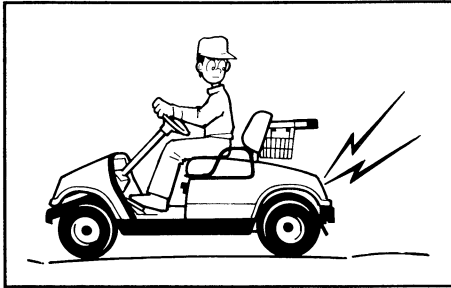

NOTE:

The back-up buzzer will beep when the drive select lever is turned to "R".

5

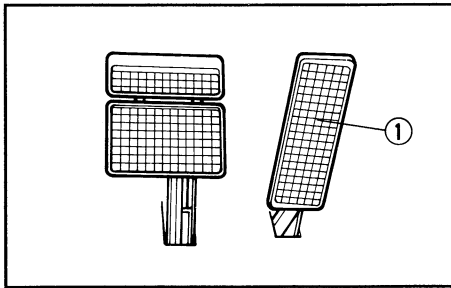

ACCELERATOR PEDAL

The accelerator pedal controls the machine speed.

	Machine speed
Depress	Increase
Release	Decrease

① Accelerator pedal

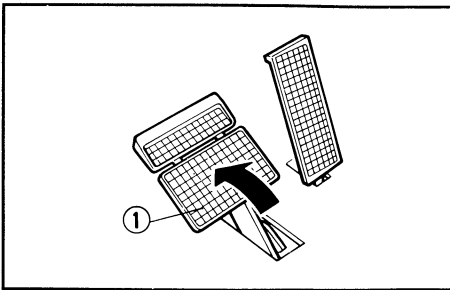

BRAKE PEDAL

Press down on the brake pedal to stop the machine.

- ① Brake pedal

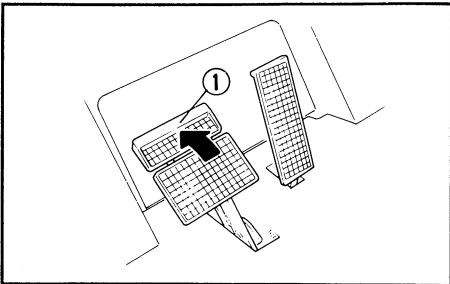

PARKING BRAKE PEDAL

Use the parking brake pedal when parking the machine.

- ① Parking brake pedal

NOTE:

Release the parking brake by depressing the accelerator pedal.

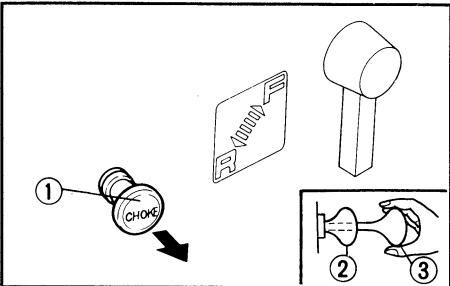

CHOKE KNOB (FOR G8-A)

Pull the choke knob when starting and warming up a cold engine.

- ① Choke knob
- ② Warm engine starting
- ③ Cold engine starting

IMPORTANT:

The choke knob should be returned to the original position after the engine warms up.

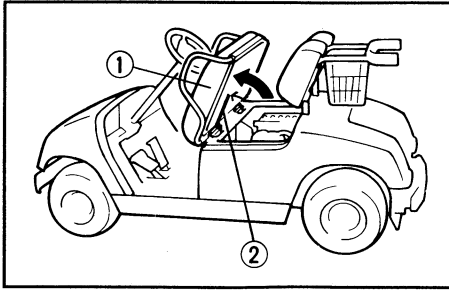

SEAT

Open the seat and lock it by seat stopper for servicing.

- ① Seat
- ② Seat stopper

⚠ WARNING

Apply the parking brake before opening the seat. Otherwise the car could unexpectedly move.

PRE-OPERATION CHECKS

⚠ WARNING

- Pre-operation checks should be made each time the machine is used.
- Be sure the main switch key is removed before checking to prevent accidental starting.
- (FOR G8-A)
During inspection or repair, avoid touching the engine and muffler while they are still hot with any part of your body or clothing.

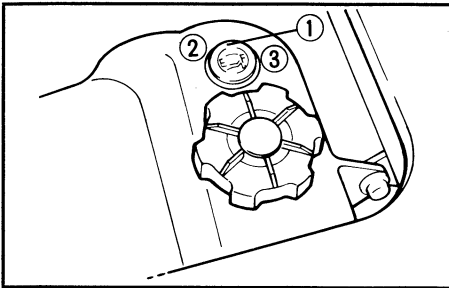

FUEL

(FOR G8-A)

Open the seat.

Make sure there is sufficient fuel in the tank.

Recommended fuel:

Unleaded gasoling

Fuel tank capacity:

23.0 L

(5.1 Imp gal, 6.1 US gal)

- ① Fuel level gauge
- ② "F" Full
- ③ "E" Empty

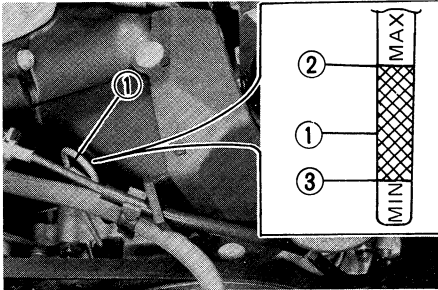

⚠ WARNING

- Handle fuel with care; it is highly flammable.
- Never add fuel to a running engine or hot engine until the engine has been allowed to cool for several minutes after running.
- Use an approved fuel container.
- Fill fuel tank outdoors with extreme care.
Never remove the fuel cap indoors. Never fill the fuel tank indoors.
- Retighten gasoline cap securely and wipe up spilled fuel.

ENGINE OIL (FOR G8-A)

(See page 8-6 ~ 8-8 for more details)

Make sure the engine oil is between upper and lower levels. Add oil as necessary.

- ① Oil level gauge
- ② Upper level
- ③ Lower level

Recommended oil:

YAMALUBE 4-cycle oil or
10W-30

Engine oil quantity:

Total:

1.1 L

(0.97 Imp qt, 1.16 US qt)

NOTE: _____

Recommended engine oil classification: API Service "SE" or "SF".

IMPORTANT: _____

- Be sure to avoid getting oil on the starter belt.
 - Be sure no foreign material enters the crankcase.
 - Do not overfill the engine oil.
-

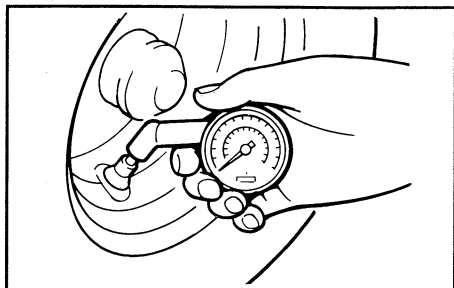

WHEEL AND TIRE

Tire Air Pressure

Check the tire condition before operating the machine.

Tire pressure:

For G8-A:

88 ~ 108 kPa

(0.9 ~ 1.1 kgf/cm², 13 ~ 16 psi)

For G8-E:

108 ~ 127 kPa

(1.1 ~ 1.3 kgf/cm², 16 ~ 18 psi)

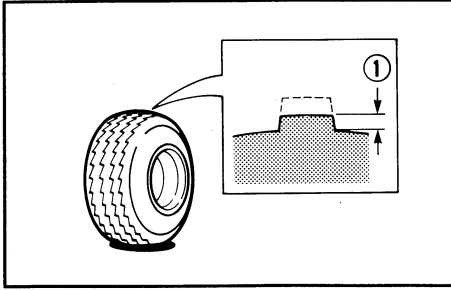

Tire Wear Limit

When tire groove wears down to 1 mm (0.04 in), replace the tire.

① Wear limit

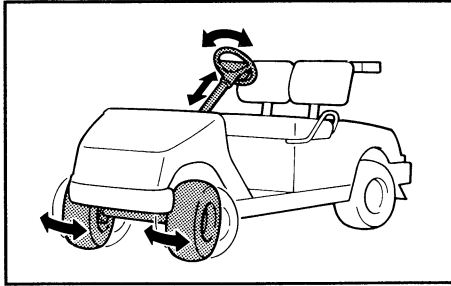

STEERING SYSTEM

1. Check the following for free play:
 - Move the steering wheel up and down, and back and forth.
 - Turn the steering wheel slightly to the right and left.
2. If you feel excessive free play, consult a Yamaha dealer.

6

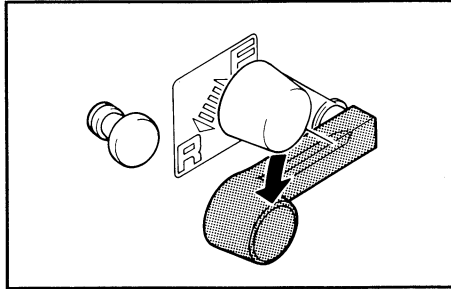

BACK-UP BUZZER

Check the back-up buzzer.

NOTE: _____
 Turn the drive select lever to "REVERSE". The buzzer should sound.

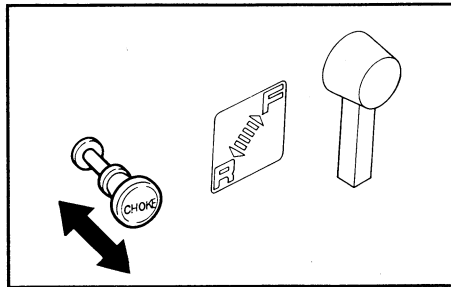

CHOKE (FOR G8-A)

Check the choke operation.

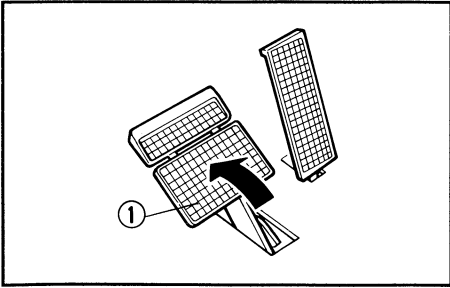

BRAKE PEDAL

Check the brake pedal for proper operation.

- ① Brake pedal

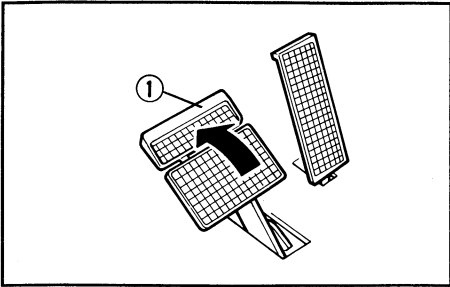

PARKING BRAKE PEDAL

Check the parking brake pedal for proper operation.

- ① Parking brake pedal

NOTE:

Release the parking brake by depressing the accelerator pedal.

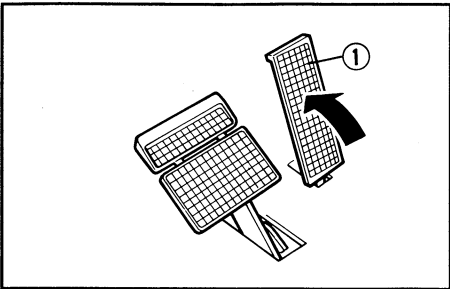

ACCELERATOR PEDAL

Check the accelerator pedal for proper operation.

- ① Accelerator pedal

⚠ WARNING

Be sure to check for smooth operation of the accelerator pedal while the main switch is in the "OFF" position.

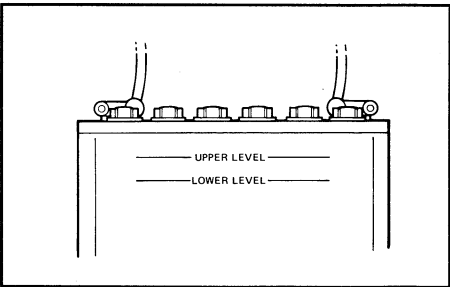

BATTERY

(For G8-A)

1. Open the seat.
2. Check the fluid level and top-up if necessary.
Use only distilled water if refilling is necessary.

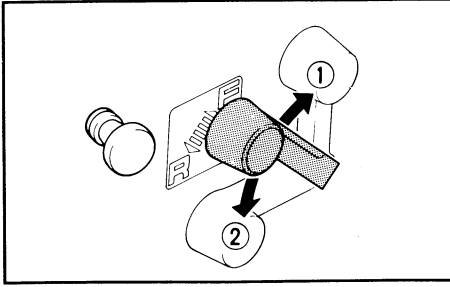

OPERATION

DRIVING

1. Turn the drive select lever to "F" or "R" to move the machine.

- ① Forward
- ② Reverse

IMPORTANT:

Do not shift from "F" forward to "R" reverse while the machine is moving.

7

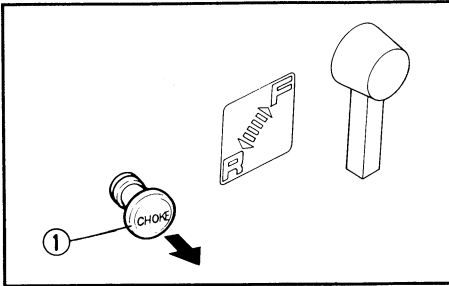

2. Fully pull the choke knob and hold it.
(For G8-A)

- ① Choke knob

IMPORTANT:

- The choke knob should be returned to the original position after the engine warms up.
- The choke is not required when the engine is warm.

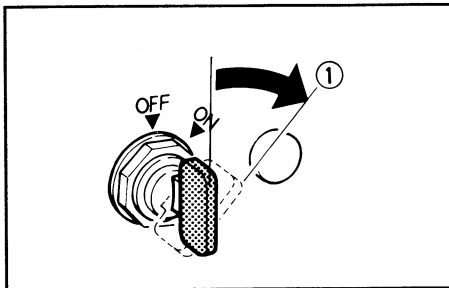

3. Turn the main switch to "ON".

- ① "ON"

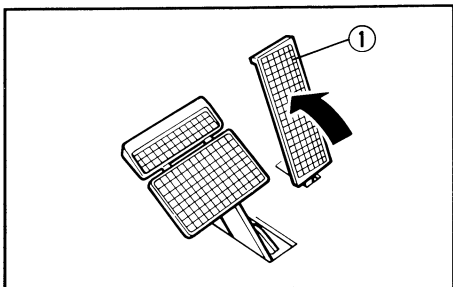

4. Slowly depress the accelerator pedal. The machine will start to move. Do not depress it the pedal too sharply.

① Accelerator pedal

⚠ WARNING

- To avoid moving unexpectedly, do not depress the accelerator pedal before turning on the main switch.
- Avoid turning the steering wheel too sharply at high speed. An accident may result.

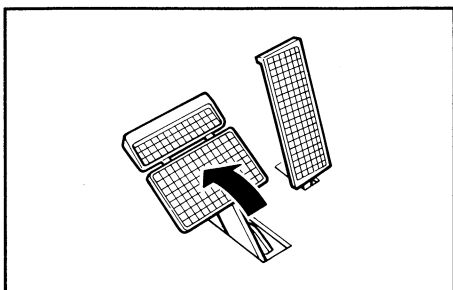

5. Press down on the brake pedal to stop the machine.

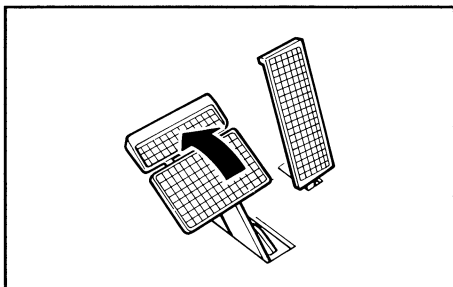

6. Apply the parking brake pedal.

NOTE: _____

Release the parking brake by depressing the accelerator pedal.

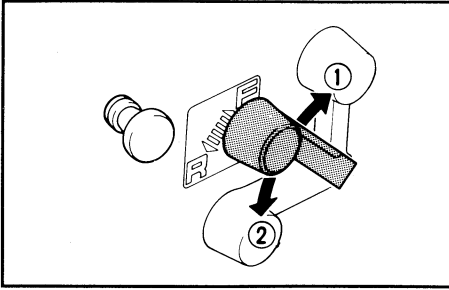

STARTING ON A SLOPE

1. Turn the drive select lever to "F" or "R".

- ① Forward
- ② Reverse

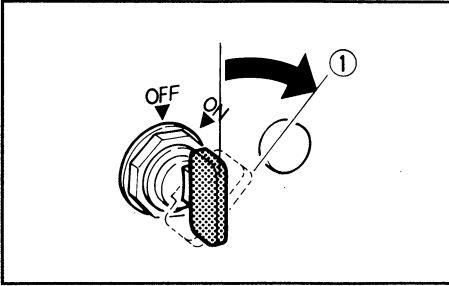

2. Turn the main switch to "ON".

- ① "ON"

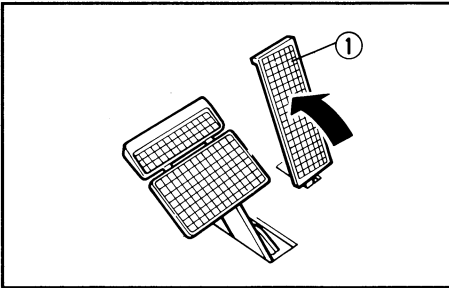

3. Depress the accelerator pedal.

- ① Accelerator pedal

⚠ WARNING

Only drive straight up or down on a slope. Never drive across the face of slope.

NOTE: _____

The parking brake is automatically released when the accelerator pedal is depressed.

PERIODIC MAINTENANCE

MAINTENANCE CHART

Regular maintenance is most important for the best performance and safe operation.

- Checking or Adjusting ● Lubricating or Replacing

FOR G8-A

Item	Remarks	Every						Page
		Pre-Operation	20 Rounds 20 hours 100 miles 160 kms (1 month)	125 rds 125 hrs 600 mls 1000 kms (6months)	250 rds 250 hrs 1200 mls 2000 kms (1 year)	500 rds 500 hrs 2500 mls 4000 kms (2 yrs)	1000 rds 1000 hrs 5000 mls 8000 kms (4 yrs)	
Engine	Adjustment: Valve clearance (cold) [Intake: 0.1 mm (0.004 in), Exhaust: 0.1 mm (0.004 in)]						○	*
	Check tightness of cylinder head						○	*
	Check condition of air filter foam cover.			○				8-9
	Wash the air filter cover with soap and water and allow it to dry.				○			8-9
	Check condition of air filter element assy. Replace element.			○	●			8-9
	Check spark plug for condition of electrodes. Plug gap: 0.7 ~ 0.8 mm (0.028 ~ 0.031 in)			○	●			8-6
	Adjustment: Engine bracket tensioner. [Free play: 2 mm (0.08 in)]				○			*
	Check engine oil level	○	○					8-6
	Replace oil: Oil amount: 1.1 L (1.16 US qt/0.97 Imp qt) Oil type: SAE 10W30 type SE or SF motor oil (If temperature does not go below 2°C (35°F): SAE 20W40)				●			8-7
	Check oil delivery hose and check-valve. Replace hose.					○	●	*
	Check compression pressure.						○	*

- * It is recommended that these items be serviced by a Yamaha dealer or other qualified mechanic.
● This manual does not contain information regarding this procedure. It is contained in the Service Manual.

FOR G8-A

Item	Remarks	Every						Page
		Pre-Operation	20 Rounds 20 hours 100 miles 160 kms (1 month)	125 rds 125 hrs 600 mls 1000 kms (6 months)	250 rds 250 hrs 1200 mls 2000 kms (1 year)	500 rds 500 hrs 2500 mls 4000 kms (2 yrs)	1000 rds 1000 hrs 5000 mls 8000 kms (4 yrs)	
Fuel system	Adjustment: Throttle cable [Free play: 0.5 mm (0.02 in)]				○			*
	Adjustment: Choke cable [Free play: 1 mm (0.04 in)]				○			*
	Check operation of cables.	○						
	Check carburetor for dirt, or wear.					○		*
	Check fuel lines for fuel leakage. Replace fuel hose.	○					●	*
	Check fuel filter for clogging. Replace filter.				○		●	*
	Check fuel level.	○						6-1
Primary and secondary sheaves	Check drive belt for slippage, wear, or scratches.				○			*
	Grease primary and secondary sheaves. Grease amount: 2 ~ 3 shots (manual grease gun), 2 ~ 3 seconds (automatic grease gun) Grease type: Molybdenum disulfide grease				●			*
	Check for operation and wear of sliding sheave.				○			*
	Check for wear of ramp shoes on secondary spring seat. Wear limit: 1.0 mm (0.04 in)				○			*
	Check for operation and installation of speed limiter.				○			*
Transmission case	Check for operation of forward-reverse shifting.		○					
	Check for damage of shifting cable, replace.				○		●	
	Check gear box oil level and leakage.				○			8-20
	Replace gear box oil. Oil amount: 0.8 L (0.70 Imp qt, 0.85 US qt) Oil type: SAE90 gear oil						●	*
Battery	Check electrolyte level.	○	○					8-12
	Check specific gravity of electrolyte.				○			8-14

8

FOR G8-E

Item	Remarks	Every							Page
		Pre-Operation	20 Rounds 20 hours 100 miles 160 kms (1 month)	125 rds 125 hrs 600 mls 1000 kms (6 months)	250 rds 250 hrs 1200 mls 2000 kms (1 year)	500 rds 500 hrs 2500 mls 4000 kms (2 yrs)	1000 rds 1000 hrs 5000 mls 8000 kms (4 yrs)		
Batteries	Charge.	○							8-15
	Check electrolyte level.		○						8-14
	Clean tops and terminals, check for corrosion.		○						
	Check for loose or broken connections.		○						
	Check the specific gravity of electrolyte.		○						8-14
Solenoid relay	Check solenoid contacts.			○					*
Traction motor	Check for loose or broken connections.		○						*
	Check brush and commutator.						○		*
Wiring	Check all wire insulation for cracks and/or worn spots.			○					*
Transmission case	Check gear box oil level and leakage.			○					8-20
	Replace gear box oil. Oil capacity: 0.3 L (0.26 Imp qt, 0.32 US qt) Oil type: SAE 90 gear oil						●		*

- * It is recommended that these items be serviced by a Yamaha dealer or other qualified mechanic.
- This manual does not contain information regarding this procedure. It is contained in the Service Manual.

FOR G8-A & G8-E

Item	Remarks	Every						Page
		Pre-Operation	20 Rounds 20 hours 100 miles 160 kms (1 month)	125 rds 125 hrs 600 mls 1000 kms (6 months)	250 rds 250 hrs 1200 mls 2000 kms (1 year)	500 rds 500 hrs 2500 mls 4000 kms (2 yrs)	1000 rds 1000 hrs 5000 mls 8000 kms (4 yrs)	
Brakes	Check operation and adjust if necessary.	○						
	Adjustment: Brake wire end play. [0.1 ~ 0.5 mm (0.004 ~ 0.02 in)]				○			*
	Check for wear or damage parking brake ratchet and stopper.				○			*
	Check shoe lining thickness. Wear limit: 1.0 mm (0.04 in)				○			*
Steering	Check operation and adjust if necessary.	○						6-4
	Check gear box for grease leakage. Grease amount: 90 CC (3.17 Imp oz, 3.04 US oz) Grease type: Multi type grease						○	*
	Adjustment: Wheel alignment [Toe-in: Unloaded G8-A 6±5 mm (0.24±0.20 in) G8-E 6±5 mm (0.24±0.20 in) Fully loaded 0 mm (0 in)]				○			*
	Check kingpin play.				○			*
	Check seal, cap of kingpin for damage.				○			*
	Lubricase kingpin.				●			*
	Wheel	Check tire pressure and correct if necessary. Front and rear: G8-A 88 ~ 108 kPa (0.9 ~ 1.1 kgf/cm², 13 ~ 16 psi) G8-E 108 ~ 127 kPa (1.1 ~ 1.3 kgf/cm², 16 ~ 18 psi)	○					
Check tire groove depth or far damage. Wear limit: 1.0 mm (0.04 in)					○			6-4
Check tire surface for damage, cracks, or hard objects embedded.		○			○			

8

Item	Remarks	Every						Page
		Pre-Operation	20 Rounds 20 hours 100 miles 160 kms (1 month)	125 rds 125 hrs 600 mls 1000 kms (6 months)	250 rds 250 hrs 1200 mls 2000 kms (1 year)	500 rds 500 hrs 2500 mls 4000 kms (2 yrs)	1000 rds 1000 hrs 5000 mls 8000 kms (4 yrs)	
	Check tightness of wheel nut.				○			
	Check wheel rims for damage.				○			
	Check for play front wheel bearing.				○			
	Check for play rear axle bearing.				○			*
	Check rear axle for cracks, or distortion.				○			*
Body & Chassis	Check body and chassis for damage.				○			*
	Check tightness of all bolts, nuts and screws.				○			*
	Check shocks absorber for oil leakage.				○			*
	Check coil spring for cracks, or damage.				○			*
Starter	Check starter V-belt for damage, tension and tightness.				○			*
	Check brushes for wear. Wear limit: 16 mm (0.63 in)					○		*
	Check commutator for dirt.					○		*
Accelerator stop switch	Check operation, and adjust if necessary.				○			*
Back-up buzzer	Check operation	○						
<p>IMPORTANT: Keep high pressure water away from all electric parts; solenoid and connector.</p>								

- * It is recommended that these items be serviced by a Yamaha dealer or other qualified mechanic.
- This manual does not contain information regarding this procedure. It is contained in the Service Manual.

MAINTENANCE FOR G8-A

SPARK PLUG INSPECTION

You should periodically remove and inspect the spark plug.

1. Check for discoloration and remove the carbon.

Standard electrode color:
Tan Color

2. Check the spark plug type and gap.

Standard Spark Plug:

BR4ES

Spark Plug Gap:

0.7 ~ 0.8 mm

(0.028 ~ 0.031 in)

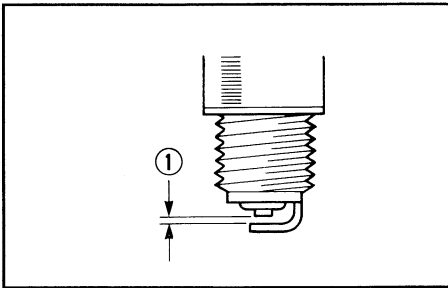

- ① Gap

3. Install the spark plug.

Spark Plug Torque:

20 Nm (2.0 m·kg, 14.5 ft·lb)

ENGINE OIL

Oil level checking

1. Warm the engine for several minutes.

Place the machine on a level surface, then stop the engine.

2. Open the seat.

MAINTENANCE FOR G8-A

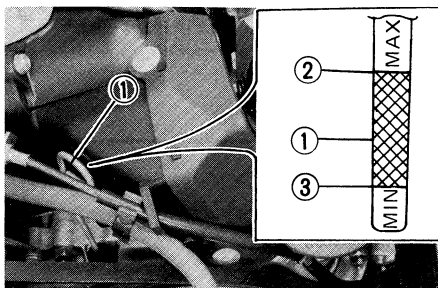

3. Make sure the engine oil is between the upper and lower levels. Add oil as necessary.

IMPORTANT:

- Do not overfill the engine oil.
- Be sure to avoid getting oil on the starter belt.
- Be sure no foreign material enters the crankcase.
- Be sure the oil warning light does not illuminate when the main switch is "ON" position.

- ① Level gauge
- ② Upper
- ③ Lower

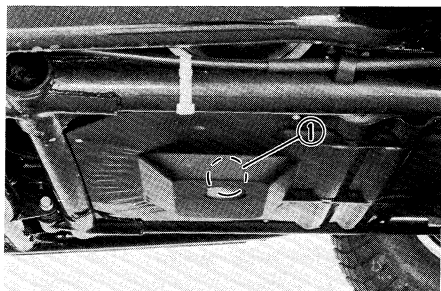

Engine oil replacement

1. Proceed with the "OIL LEVEL CHECKING" items.
2. Place an oil pan under the engine. Remove the oil drain plug and let the oil drain completely.

- ① Drain plug
3. Check the drain plug gasket. If damaged, replace it.
4. Install the drain plug.

Drain plug torque:
35 Nm (3.5 m·kg, 25 ft·lb)

MAINTENANCE FOR G8-A

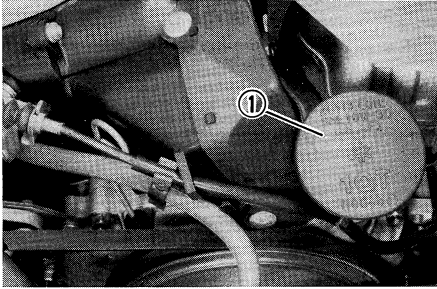

5. Add oil through the oil filler hole.

① Oil filler hole.

Recommended oil:

YAMALUBE 4-cycle oil or
10W-30

Engine oil quantity:

Total:

1.1 L

(0.97 Imp qt, 1.16 US qt)

NOTE: _____

Recommended engine oil classification:
API Servic "SE" or "SF".

IMPORTANT: _____

- Do not overfill the engine oil.
 - Be sure to avoid getting oil on the starter belt.
 - Be sure no foreign material enters the crankcase.
 - Be sure the oil warning light does not illuminate when the main switch is "ON" position.
-

6. After replacement of engine oil. Be sure to check for oil leaks.

MAINTENANCE FOR G8-A

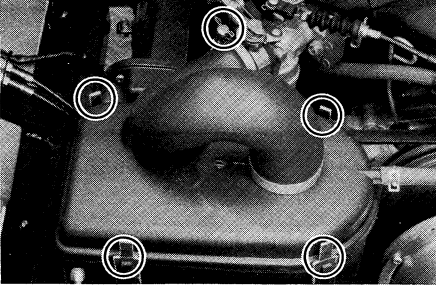

AIR FILTER

1. Remove the air filter cover and element assembly.

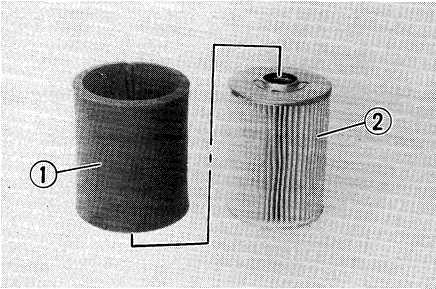

2. Remove the foam element from the paper element.

- ① Foam element
- ② Paper element

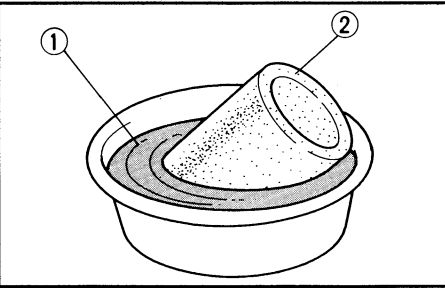

3. Wash the foam element in soap and water. Allow it to dry.

- ① Soap and water
- ② Element cover

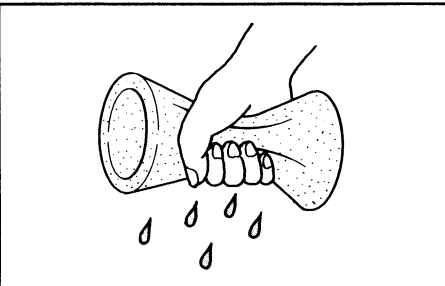

IMPORTANT: _____
Do not wring out the foam element.
This could cause it to tear.

4. Check the paper element.
If damaged, replace it.

MAINTENANCE FOR G8-A

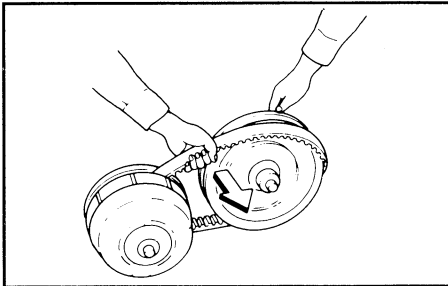
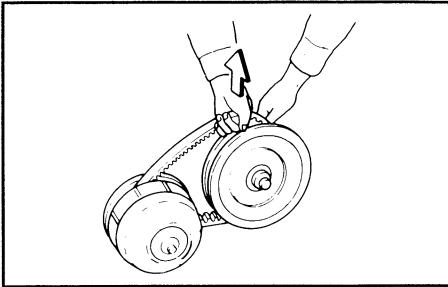
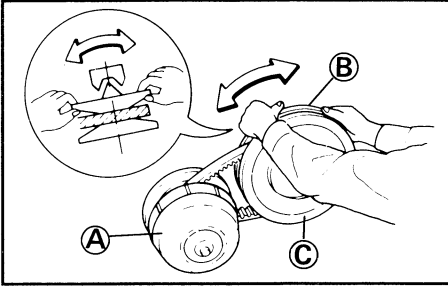

DRIVE BELT

Remove the drive belt.

- Set the drive select lever to neutral position.
- Pull out the primary sliding sheave (A).
- Rotate the secondary sliding sheave (B) clockwise and push it.
- Pull up on the drive belt, and push it outward over the edge of the secondary fixed sheave (C).
- Remove the drive belt from the secondary sheave and primary sheave.

8

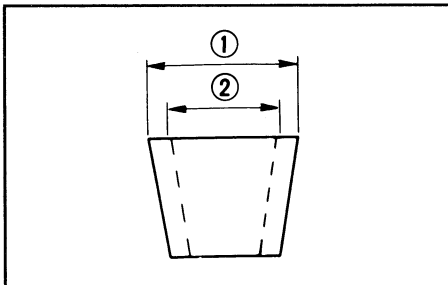

INSPECTION

Check wear and damage.

If worn beyond the wear limit or damaged, replace the belt with a new one.

- ① New: 31.0 mm (1.22 in)
- ② Wear limit: 27 mm (1.06 in)

MAINTENANCE FOR G8-A

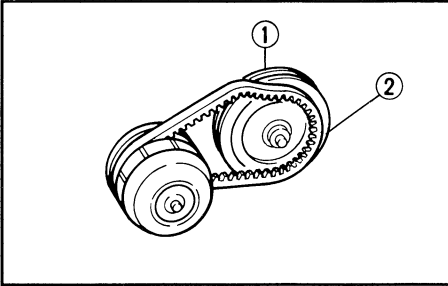

Install the drive belt

- Set the drive select lever to neutral position.
- Install the drive belt over the primary sheave.
- Rotate the secondary sliding sheave clockwise and push it so that it separates from fixed sheave.
- Install the drive belt between secondary sliding and fixed sheave.

- ① Secondary sliding sheave
- ② Secondary fixed sheave

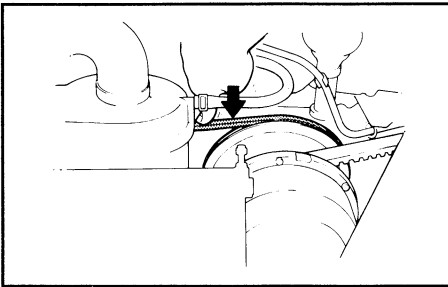
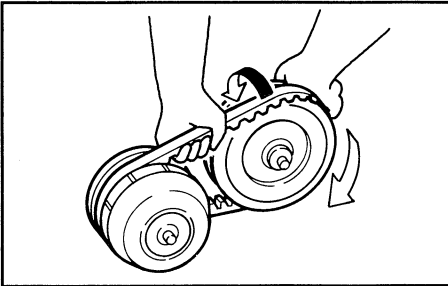

STARTER GENERATOR BELT

Check for damage, and replace it if damaged.

Belt adjustment

Check the belt tension by applying a force of 10 kg (22.05 lb) at its center.

Starter-generator belt tension:

New belt (preset tension)

8 mm/10 kg (0.31 in/22.05 lb)

Normal

10 mm/10 kg (0.39 in/22.05 lb)

MAINTENANCE FOR G8-A

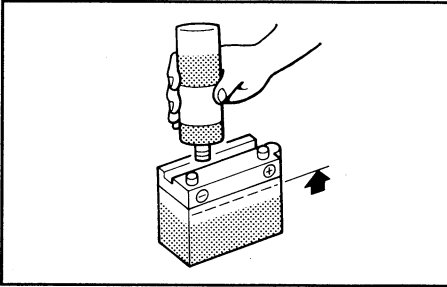

BATTERY

1. Check the fluid level and top up if necessary. Use only distilled water if refilling is necessary.

IMPORTANT

Normal tap water contains minerals which are harmful to a battery; therefore, refill only with distilled water.

⚠ WARNING

Battery electrolyte is poisonous and dangerous, causing severe burns, etc. It contains sulfuric acid. Avoid contact with skin, eyes or clothing. Antidote: EXTERNAL-Flush with water. INTERNAL-Drink large quantities of water or milk. Follow with milk of magnesia, beaten egg or vegetable oil. Call physician immediately.

EYES: Flush with water for 15 minutes and get prompt medical attention.

Batteries produce explosive gases. Keep sparks, flame, cigarettes, etc., away.

Never smoke or make and brake connections at the battery while charging.

Ventilate when charging or using in enclosed space. Always shield eyes when working near batteries.

KEEP OUT OF REACH OF CHILDREN.

MAINTENANCE FOR G8-E



BATTERY

Battery care

⚠ WARNING

Battery electrolyte is poisonous and dangerous, causing severe burns, etc. It contains sulfuric acid. Avoid contact with skin, eyes or clothing. Antidote: **EXTERNAL**-Flush with water. **INTERNAL**-Drink large quantities of water or milk. Follow with milk of magnesia, beaten egg or vegetable oil. Call physician immediately. **EYES:** Flush with water for 15 minutes and get prompt medical attention.

Batteries produce explosive gases. Keep sparks, flame, cigarettes, etc., away.

Never smoke or make and brake connections at the battery while charging.

Ventilate when charging or using in enclosed space. Always shield eyes when working near batteries.

KEEP OUT OF REACH OF CHILDREN.

1. Clean the batteries
2. Check the fluid level.
Fill to manufacturer's recommended level is necessary.

MAINTENANCE FOR G8-E

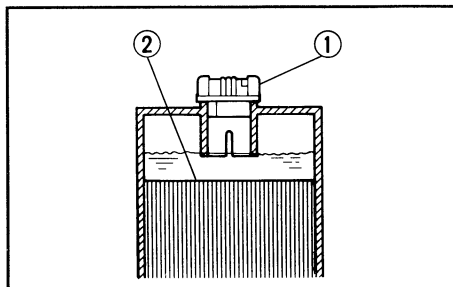

IMPORTANT:

Normal tap water contains minerals which are harmful to a battery; therefore, refill only with distilled water.

- ① Battery cap
- ② Plates

3. Check the specific gravity of the battery fluid.

If any low readings are found, consult a Yamaha.

4. Specific gravity.

Temperature		Satisfactory uncorrected hydrometer reading
°F	°C	
120	48.9	1.244
110	43.3	1.248
100	37.8	1.252
90	32.2	1.256
80	26.7	1.260
70	21.1	1.264
60	15.6	1.268
50	10.0	1.272
40	4.4	1.276
30	-1.1	1.280

8

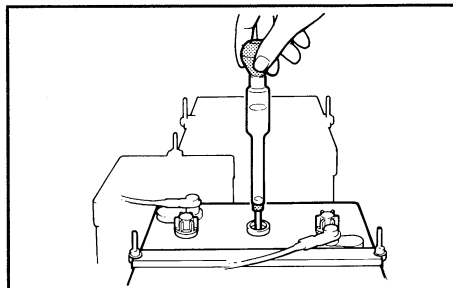
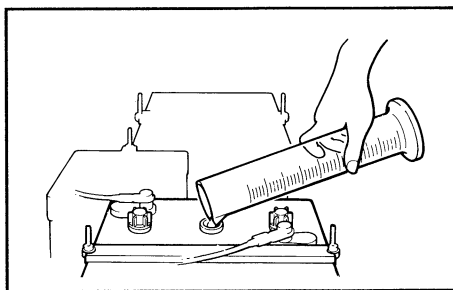

MAINTENANCE FOR G8-E

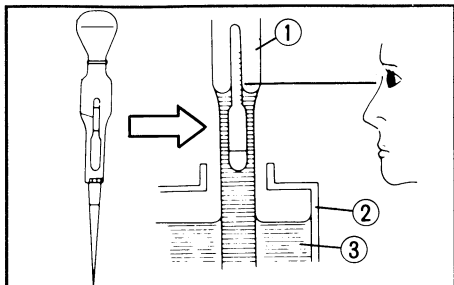

Check the specific gravity with the hydrometer. Be sure to read as illustrated.

- ① Hydrometer
- ② Battery
- ③ Fluid

Battery charging

⚠ WARNING

- Keep fire and sparks away from the batteries while they are being charged. (Explosive gases are formed during charging)
- Never charge the batteries in a closed area.

Choose a well-ventilated area.

IMPORTANT:

Take care that the batteries are not over charged. This will shorten their life.

NOTE:

Charge the batteries after each day of use, or periodically during extended storage.

1. Turn the main switch to the "OFF" position.

- ① "OFF"

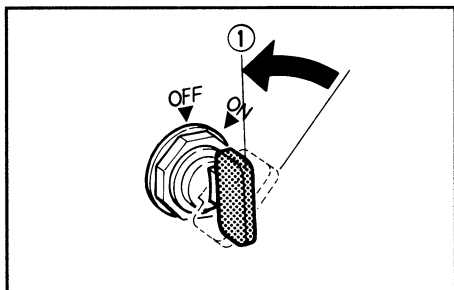

MAINTENANCE FOR G8-E

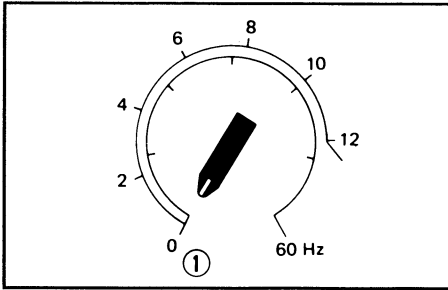

2. Turn off the charger timer switch to the "0 Hr" position.

① "OFF"

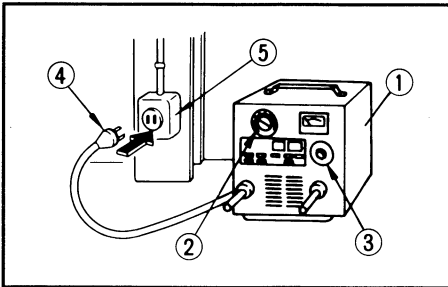

3. Connect the AC plug of the battery charger to a wall socket.

① Battery charger

② Timer

③ Pilot lamp

④ AC plug

⑤ Wall socket

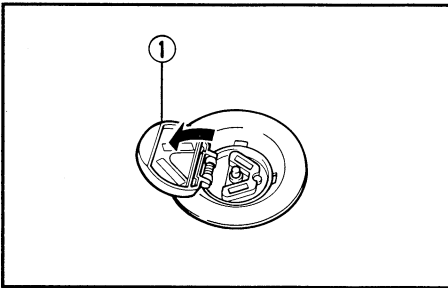

4. Open the socket cap.

① Socket cap

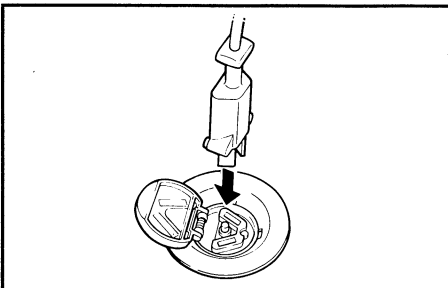

5. Insert the charger plug into the charging receptacle.

⚠ WARNING

Do not unplug the charger from the socket until the charger is turned off. Unplugging an operating charger will cause sparks.

MAINTENANCE FOR G8-E

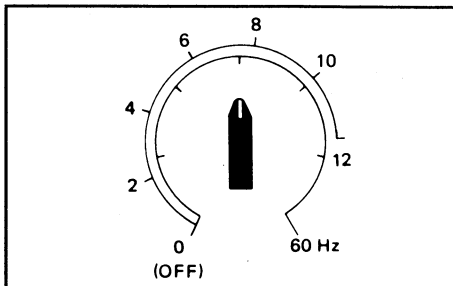

6. Set the timer to the desired charging time.

The charger will turn on for the indicated number of hours.

Golf Car Use	Charging Time
9 holes or less	7 hours
18 holes or more ..	12 hours or more
Commerical Use	
Less than 1 hour ..	7 hours
More than 1 hour ..	12 hours or more

7. If the specific gravity does not increase after charging, the batteries are aging and should be charged according to the finish rate chart.

Finish rate on Charger Ammeter	Timer setting
1 ~ 4 Amps	12 Hrs
6 ~ 8 Amps	10 Hrs
10 ~ 12 Amps	8 Hrs
15 Amps +	6 Hrs

NOTE: _____
 Ambient temperatures of 38°C (100°F) or higher will cause high finish rates. Be careful to overcharge the batteries. Cold temperatures will require longer charging times.

MAINTENANCE FOR G8-E

8. Catch-up and storage charge recommendations.

State of charge (Specific Gravity)	Charge
1.260 to 1.280	None needed
1.240 to 1.260	4 Hours
1.220 to 1.240	8 Hours
Below 1.220	12 Hours

Battery installation

1. Install the battery hold down plates as shown.

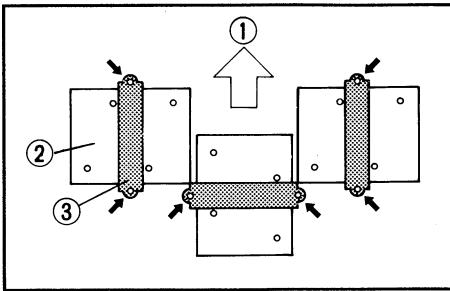

- ① Forward
- ② Battery
- ③ Battery fitting plate

2. Connect the wire leads as shown.
Each wire lead has same length.

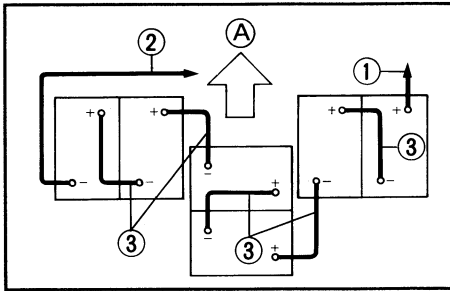

- Ⓐ Forward
- ① to relay
- ② to controller

8

MAINTENANCE FOR G8-E

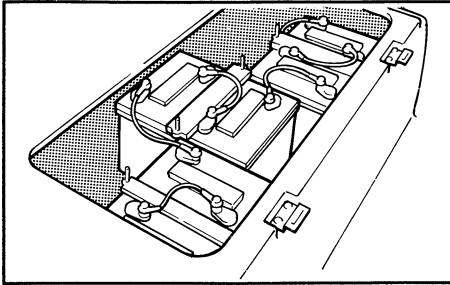

⚠ WARNING

When installing batteries, be careful to avoid short-circuiting by:

- Careful place battery cables and holddowns.
- Avoid touching wrenches to any metal part of the car (ground).

IMPORTANT:

Do not overtighten the battery holddown nuts. Excessive force will damage the battery casing.

FUSE REPLACEMENT

⚠ WARNING

Be sure to use the specified fuse. A wrong fuse will cause electrical system damage and A FIRE HAZARD.

IMPORTANT:

Be sure the main switch is turned off to prevent accidental short-circuiting

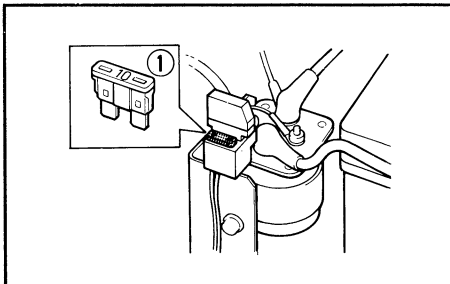

① Fuse case

Fuse

10A

MAINTENANCE FOR G8-A & G8-E

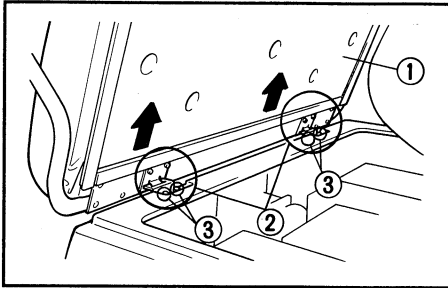

GEAR BOX OIL Oil level checking

1. Place the vehicle on a level surface.
2. Open the seat, and remove the seat.
3. Remove the seat hinges.

- ① Seat
- ② Seat hinge
- ③ Bolt

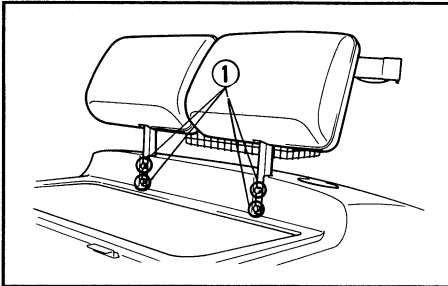

4. Remove the back support.

- ① Bolt

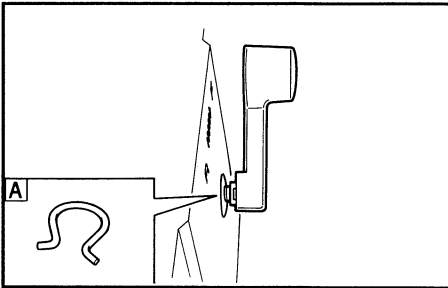

5. Remove the drive select lever.

- A Set spring

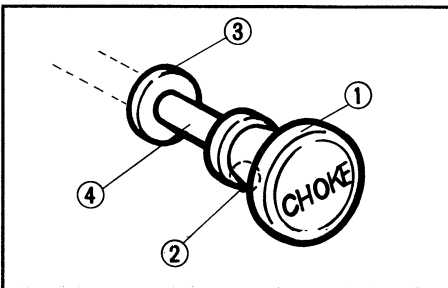

6. Remove the choke knob and choke cable. (For G8-A)

- ① Choke knob
- ② Screw
- ③ Nut
- ④ Choke cable

MAINTENANCE FOR G8-A & G8-E

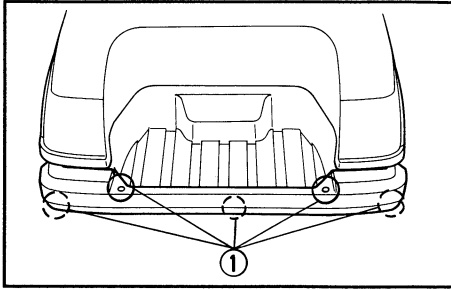

7. Remove the blind rivet with rear bumper cover.

① Blind rivet

8. Remove the rear bumper cover.

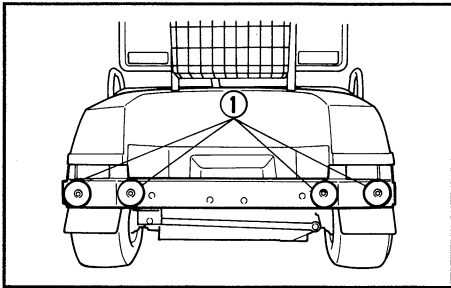

9. Remove the rear bumper.

① Bolt

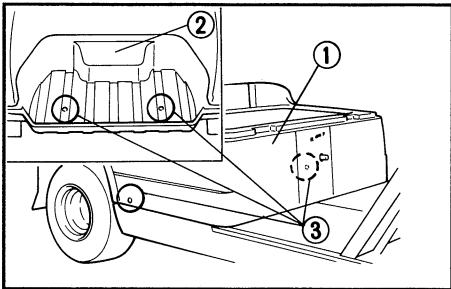

10. Remove the blind rivet with rear cowling and rear floor cover.

① Rear cowling

② Rear floor cover

③ Blind rivet

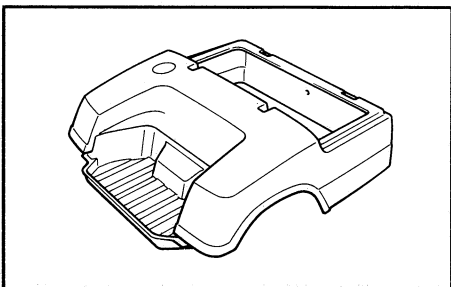

11. Remove the rear cowling.

MAINTENANCE FOR G8-A & G8-E

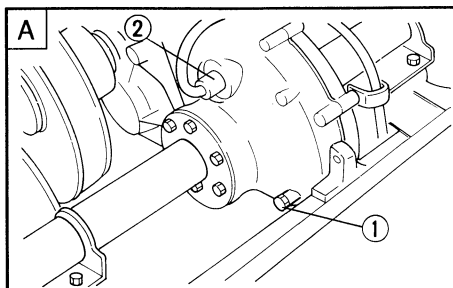

12. Remove the oil level plug ①, and vent cap ② (G8-A only).

A G8-A

B G8-E

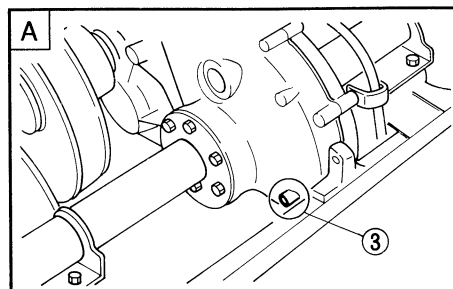
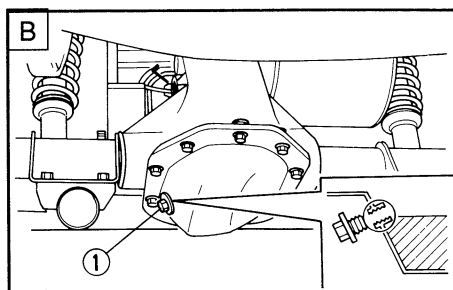

13. Oil should flow from the level plug hole ③.

If not, add oil until it begins to flow out from the level plug hole.

A G8-A

B G8-E

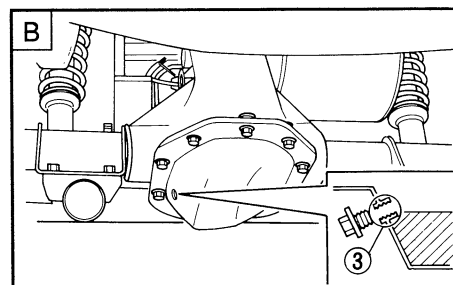

Recommended oil:

SAE 90 gear oil

Oil quantity (Total):

G8-A:

0.8 L (0.70 Imp qt, 0.85 US qt)

G8-E:

0.3 L (0.26 Imp qt, 0.32 US qt)

MAINTENANCE FOR G8-A & G8-E

IMPORTANT:

Do not allow foreign material to enter the gear box.

14. Reinstall the oil level plug, and vent cap.

Oil level plug tightening torque:

G8-A:

15 Nm (1.5 m·kg, 11 ft·lb)

G8-E;

44 Nm (4.4 m·kg, 32 lf·lb)

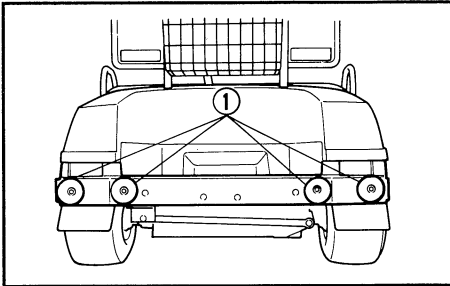

15. Install the rear cowling, rear bumper and rear bumper cover.

Bolt ① (Rear bumper) tightening

torque:

23 Nm (2.3 m·kg, 17 ft·lb)

NOTE:

Always use a new blind rivet.

16. Install the drive select lever.

17. Install the choke cable and choke knob. (For G8-A)

MAINTENANCE FOR G8-A & G8-E

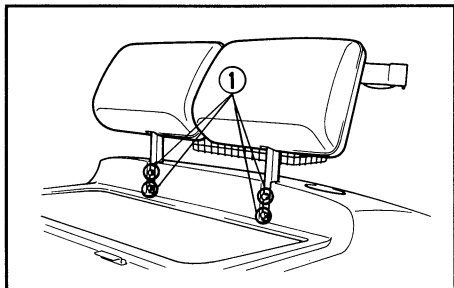

18. Install the back support.

Bolt ① (Back support) tightening torque:
33 Nm (3.3 m·kg, 24 ft·lb)

① Bolt

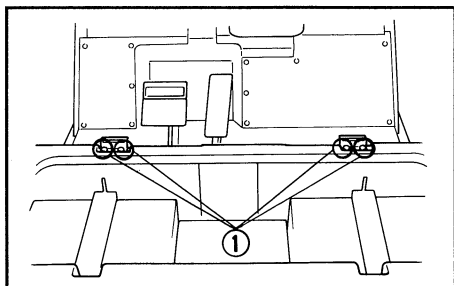

19. Install the seat hinges.

Bolt ① (Seat hinge) tightening torque:
8 Nm (0.8 m·kg, 5.8 ft·lb)

① Bolt

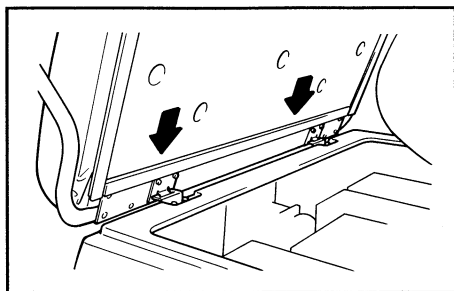

20. Install the seat.

Oil replacement;

Please consult a Yamaha dealer or other qualified mechanic.

MAINTENANCE FOR G8-A & G8-E

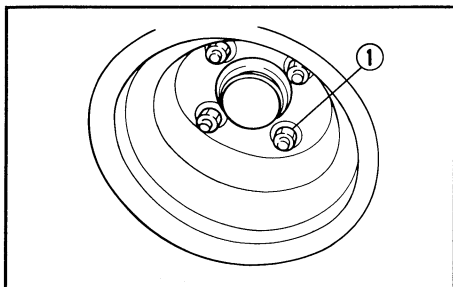

FRONT AND REAR WHEEL Replacement

1. Loosen the wheel nuts.

① Nut

NOTE: _____

Check the tire before loosening the nuts.

2. Raise the wheel using a jack and tire chocks.

3. Remove the wheel.

4. Reverse the removal steps when installing.

Wheel Nut Tightening Torque:

Front; 80 Nm
(8.0 m·kg, 58 ft·lb)

Rear; 80 Nm
(8.0 m·kg, 58 ft·lb)

NOTE: _____

Tightening the wheel nuts after lowering the wheel.

BRAKES

Brake adjustment:

Brakes are self-adjusting.

Before the initial start on a new car, press down the brake pedal several times to make sure that brakes function.

⚠ WARNING _____

If the brakes do not adjust properly, consult a Yamaha dealer.

You could have an accident if the brakes are not operating correctly.

TROUBLESHOOTING

Engine won't start (FOR G8-A)

1. Fuel system

No fuel supplied to combustion chamber.

- No fuel in tank...Supply fuel
- Clogged fuel line...Clean fuel line. Consult dealer.
- Foreign matter in fuel cock...Clean fuel cock. Consult dealer.
- Clogged carburetor...Clean carburetor. Consult dealer.

2. Electrical system

Poor spark

- Spark plug dirty with carbon or wet...Remove carbon or wipe spark plug dry
- Faulty ignition system...Consult dealer.

STORAGE

Long term storage of your machine will require some preventive procedures to guard against deterioration.

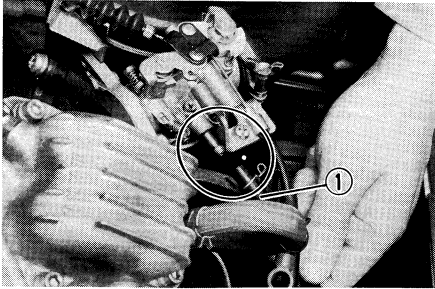

DRAIN THE FUEL (FOR G8-A)

1. Fill the fuel tank.
2. Drain the carburetor float bowl.

① Fuel line

ENGINE (FOR G8-A)

With the key removed and the spark plug lead disconnected, turn the clutch by hand until compression is felt. This puts the valves in the closed position.

CHASSIS

1. Increase the tire pressure to 137 kPa (1.4 kg/cm², 20 psi).
2. Clean exterior of the machine and apply a rust inhibitor.
3. Store the machine in a dry, well-ventilated place, with a cover placed over it.

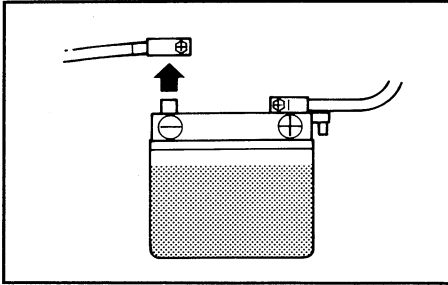

BATTERY FOR G8-A

Remove the battery and charge it. Store it in a dry place and recharge it once a month. Do not store the battery in an excessively warm or cold place (less than 0°C (30°F) or more than 30°C (90°F)).

⚠ WARNING

- **Disconnect the negative lead first, then positive lead from the battery.**
- **Connect the positive lead first, then negative lead to the battery when installing the battery.**

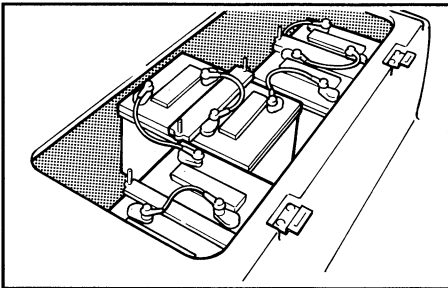

BATTERY FOR G8-E

1. Clean the tops of the batteries.
2. Check fluid level.
3. Charge the batteries.
4. Recharge once a month.

SPECIFICATIONS

General specifications

Items	G8-A	G8-E
Dimensions:		
Overall Length	2,405 mm (94.7 in)	
Overall Width	1,200 mm (47.2 in)	
Overall Height (Steering height)	1,222 mm (48.1 in)	
Height of Floor	300 mm (11.8 in)	
Wheelbase	1,625 mm (64.0 in)	
Tread:		
Front	900 mm (35.4 in)	
Rear	980 mm (38.6 in)	
Min. Ground Clearance	97 mm (3.8 in)	
Weight:		
Dry Weight (Without battery)	305 kg (672 lb)	252 kg (556 lb)
Performance:		
Maximum Loading Limit	250 kg (551 lb)	210 kg (463 lb)
Maximum Speed	19 km/h (12 mph)	←
Starter Generator Red Zone	4,000 r/min	—
Motor Red Zone	—	5,500 r/min
Cranking Speed	Apprx. 800 r/min	
Minimum Turning Radius	3,000 mm (118.1 in)	←
Seating Capacity	2 persons	←
Hill Climbing Ability	27° (50% grade) on pavement	20° (36% grade) on pavement

Maintenance specifications

ENGINE

Items	G8-A
Description:	
Engine Type	4-stroke, Gasoline, OHV
Number of Cylinder	Single
Displacement	285 cm ³
Bore × Stroke	73 × 68 mm (2.87 × 2.68 in)
Compression Ratio	8.1 : 1
Cooling System	Forced air cooled
Starting System	Starter
Ignition System	TCI
Spark Plug Type	BR4ES (NGK)
Spark Plug Gap	0.7 ~ 0.8 mm (0.028 ~ 0.031 in)
Lubrication System	Wet sump

CHASSIS

Items	G8-A
Transmission:	
Type	V-belt automatic centrifugal engagement
V-belt Width and Outer Line Length	31 × 1,010 mm (1.22 × 39.76 in)
V-belt Wear Limit	27 mm (1.06 in)
Differential/Reduction Gear:	
Differential Type	Bevel gear
Lubricant/Capacity	SAE 90 gear oil/ 0.8 L (0.70 Imp qt, 0.85 US qt)
Governor:	
Type	Oil bath flyweight
Factory Speed Setting	19 km/h (12 mph)

10

ELECTRIC

Items	G8-A
Battery:	BCI Group 24, RC: minimum 75 min. CCA: minimum 400A

CHASSIS

Items	G8-E
Differential/Reduction Gear: Differential Type Oil Type/Capacity	Bevel gear SAE 90 Gear oil/ 0.3 L (0.26 Imp qt, 0.32 US qt)
Battery:	BCI GROUP GC-2H

CHASSIS

Items	G8-A/G8-E
Steering System: Type Steering Angle (L.H.) (R.H.) Lubricant/Capacity	Worm and pin 1.5 turn 1.5 turn Grease/0.09 L (3.17 Imp oz, 3.04 US oz)
Brakes: Brakes System Type of Brake Linkage Adjustment (Brake cable end play)	Mechanical brake linkage to individual drum brakes on each rear wheel with self-adjusting brake shoe. Dual internal expanding shoe. Leading/Trailing shoes (self-adjusting) 0.1 ~ 0.5 mm (0.004 ~ 0.02 in)
Parking Brake: Type	Foot type; Parking brake with automatic release.
Release Timing (Bolt heads round parallel to arm)	1 mm (0.04 in)
Wheel: Tire Size: Front Rear Rim Size: Tire Pressure: Front/Rear FOR G8-A FOR G8-E	 18 × 8.50 – 8.00/4 PR 18 × 8.50 – 8.00/4 PR 7.00 – 1 – 8.00 88 ~ 108 kPa (0.9 ~ 1.1 kgf/cm ² , 13 ~ 16 psi) 108 ~ 127 kPa (1.1 ~ 1.3 kgf/cm ² , 16 ~ 18 psi)

WIRING DIAGRAM FOR G8-A

- ① Ignition coil
- ② Buzzer
- ③ Back switch
- ④ Accelerator switch
- ⑤ Main switch
- ⑥ PILOT LAMP (12V, 3.4W)
- ⑦ Battery
- ⑧ Fuse (10A)
- ⑨ Relay
- ⑩ Starter generator
- ⑪ Voltage regulator
- ⑫ Oil level gauge
- ⑬ Rotor
- ⑭ Pick up
- ⑮ Ignitor

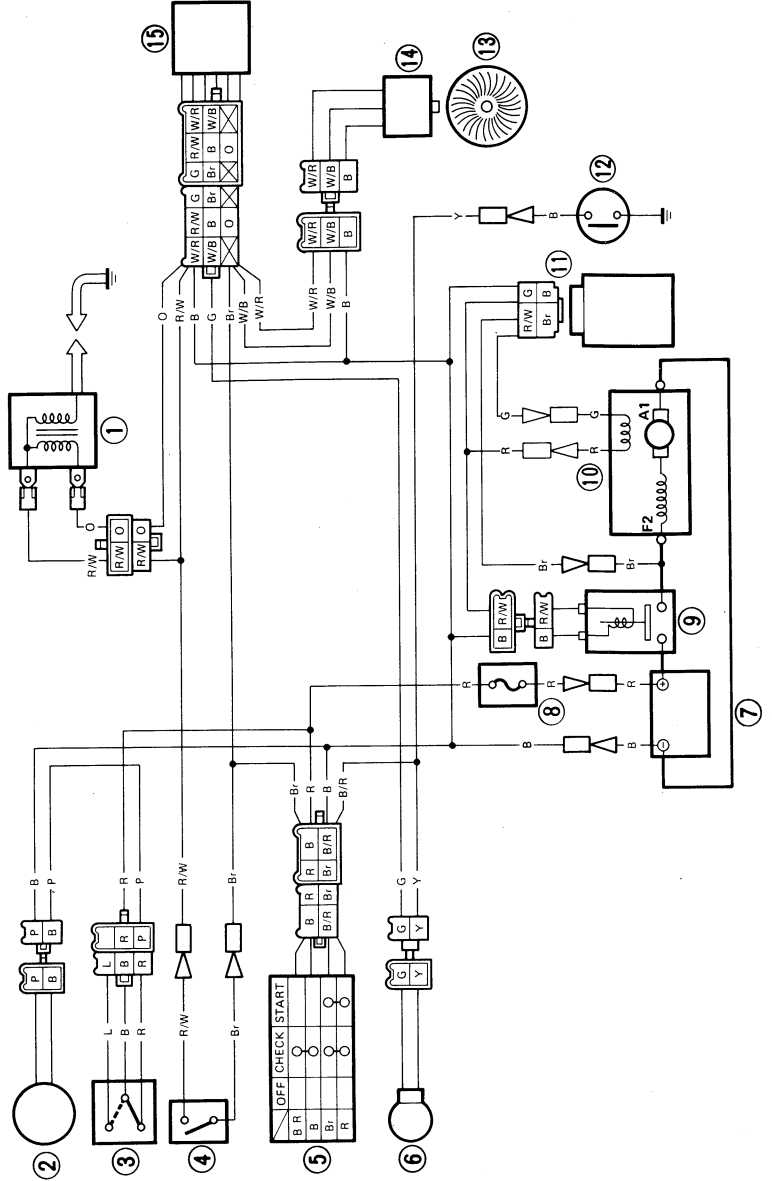

COLOR CODE

- B..... Black
- Y..... Yellow
- G..... Green
- R..... Red
- P..... Pink
- O..... Orange
- Br..... Brown
- B/R..... Black/Red
- R/W..... Red/White

WIRING DIAGRAM FOR G8-E

- ① Back switch
- ② Buzzer
- ③ Accelerator switch
- ④ Diode (B)
- ⑤ Diode (A)
- ⑥ Main switch
- ⑦ Fuse (10A)
- ⑧ Battery
- ⑨ Receptacle
- ⑩ Throttle sensor
- ⑪ Controller
- ⑫ Motor
- ⑬ Shift switch
- ⑭ Limit switch

COLOR CODE

- B Black
- L Blue
- G Green
- R Red
- Br Brown
- W White
- B/R Black/Red
- Y/B Yellow/Black
- R/Y Red/Yellow
- R/W Red/White
- W/R White/Red
- P Pink

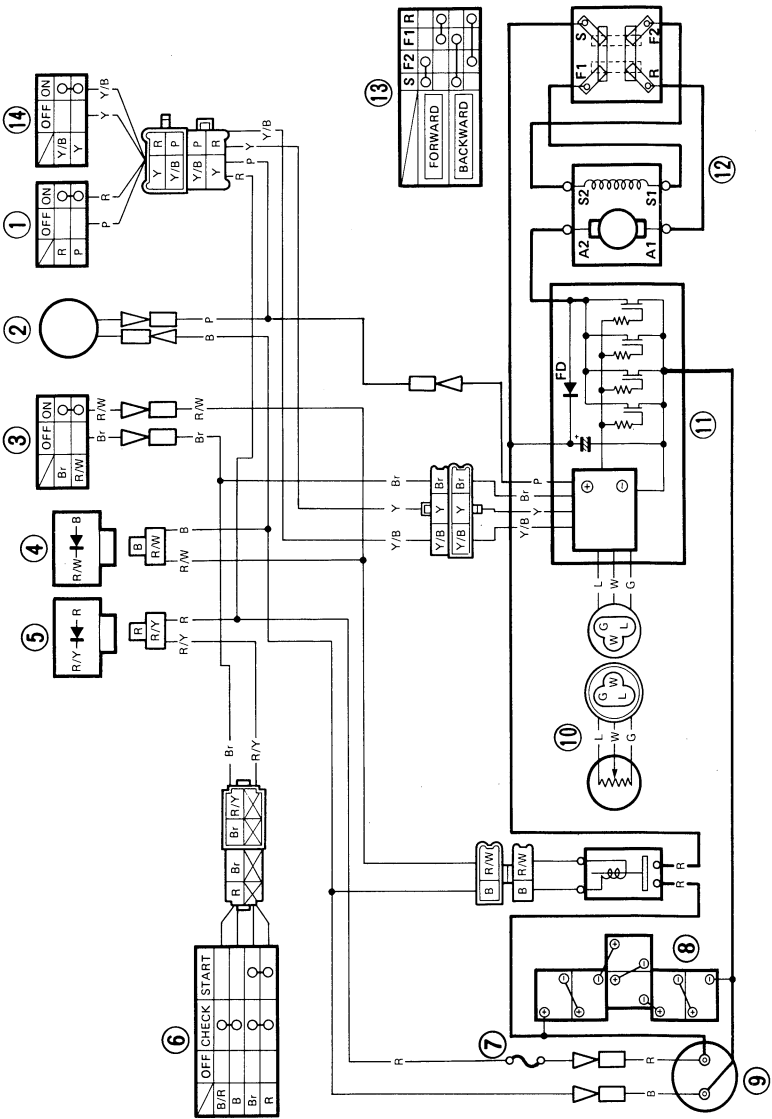

— MEMO —

YAMAHA
GENUINE
Parts & Accessories

01/10/01
1PC - G8A/E O/M

LIT196260058



Yamaha Motor Corp., USA
Cypress, California

YAMAHA YAMAHA YAMAHA YAMAHA YAMAHA YAMAHA YAMAHA YAMAHA YAMAHA YAMAHA YAMAHA YAMAHA YAMAHA YAMAHA YAMAHA YAMAHA
YAMAHA YAMAHA YAMAHA YAMAHA YAMAHA YAMAHA YAMAHA YAMAHA YAMAHA YAMAHA YAMAHA YAMAHA YAMAHA YAMAHA YAMAHA YAMAHA
YAMAHA YAMAHA YAMAHA YAMAHA YAMAHA YAMAHA YAMAHA YAMAHA YAMAHA YAMAHA YAMAHA YAMAHA YAMAHA YAMAHA YAMAHA YAMAHA
YAMAHA YAMAHA YAMAHA YAMAHA YAMAHA YAMAHA YAMAHA YAMAHA YAMAHA YAMAHA YAMAHA YAMAHA YAMAHA YAMAHA YAMAHA YAMAHA

YAMAHA

YAMAHA MOTOR
MANUFACTURING CORP.
OF AMERICA