

# Orion

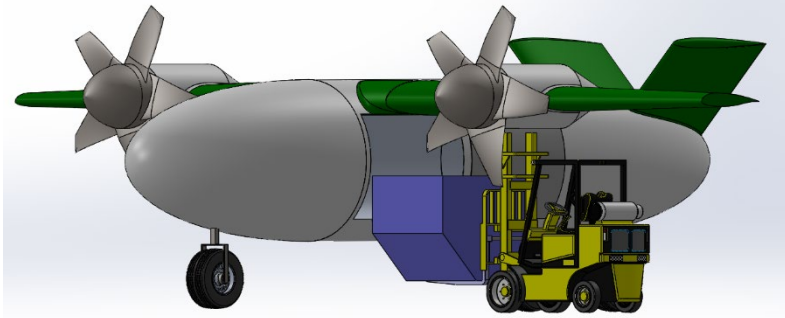

## Submitted in Response to the Real World Design Challenge

Submitted by

### Rancho RamJets

Team Member Names

Name	Grade	Age	email	Phone Number
Rebecca Hopps (Lead)	12	18	rebecca.269530@nv.ccsd.net	(702) 485-9186
Maranata Gebre	11	16	maranata.293626@nv.ccsd.net	(702) 497-4536
Andrew Palmberg	11	16	andrew.320801@nv.ccsd.net	(702) 764-9397
Jacob Johnson	11	16	jacob.311493@nv.ccsd.net	(702) 913-5358
Jordan Tran	10	15	jordan.360173@nv.ccsd.net	(702) 482-0716
Samuel Gonzalez	10	15	samuel.365225@nv.ccsd.net	(702) 559-2379
Biniam Gebre	9	15	biniam.387562@nv.ccsd.net	(702) 493-3968

### Rancho High School

1900 Searles Avenue - Las Vegas, Nevada 89101

United States of America

April 1, 2023

Coach Name	Address	Phone	Email
Darlene Follins	3528 Herring Gull Lane North Las Vegas, NV 89084	(702) 799-7000 ext 4315	follidj@nv.ccsd.net
Kimberly Hopps (assistant)	4992 Michael Jay Way Las Vegas, NV 89149	(775) 843-2056	nvhopperly@gmail.com

### Team/Coach Validating Signatures:

Participating students/team members completed Formative Surveys:

# Table of Contents

- Executive Summary..... 1
- Specification Table ..... 2
- 1. Team Engagement..... 3
  - 1.1 Team Formation and Project Operation ..... 3
  - 1.2 Acquiring and Engaging Mentors ..... 4
  - 1.3 State the Project Goal ..... 5
  - 1.4 Tool Setup/Learning/Validation ..... 5
  - 1.5 Impact on STEM ..... 6
- 2. System Design ..... 7
  - 2.1 Engineering Design Process ..... 7
  - 2.2 Project Plan..... 8
  - 2.3 Subsystems ..... 9
  - 2.4 Lessons Learned .....36
  - 2.5 Component and Complete Flight Vehicle Weight and Balance.....37
  - 2.6 Final Design Drawings .....41
- 3. Missions .....42
  - 3.1 Concept of Operations .....42
  - 3.2 Flight Profile Analysis .....47
  - 3.3. Safety Requirements.....47
- 4. Business Case .....61
  - 4.1 Comparison to Traditional Methods.....61
  - 4.2 Cost/Benefit Analysis and Justification .....67
- 5. Conclusion .....68
- 6. References .....69
- Works Cited.....69



## List of Figures

Figure 1: Engineering Design Process .....	7
Figure 2: Gantt Chart .....	8
Figure 3: VTOL Conceptual Sketch.....	10
Figure 4: Fixed Wing Conceptual Sketch .....	10
Figure 5: Fuselage Structure.....	10
Figure 6: Aircraft Preliminary Sketch .....	12
Figure 7: Wing Stress Simulation .....	15
Figure 8: Propeller .....	17
Figure 9: Empennage Comparison.....	18
Figure 10: Omni-wheels .....	19
Figure 11: PDU .....	19
Figure 12: Control Panel .....	19
Figure 13: Tricycle Landing Gear .....	19
Figure 14: Landing Gear Model.....	19
Figure 15: Material Model .....	21
Figure 16: Beechcraft Air King 200.....	21
Figure 17: GCS .....	23
Figure 18: Multiplexer.....	24
Figure 19: Control Room Layout .....	26
Figure 20: GCS Layout .....	28
Figure 21: Hangar GCS .....	28
Figure 22: Warehouse Design.....	35
Figure 23: Center of Gravity Models.....	37
Figure 24: Truck Internal Baffles .....	38
Figure 25: Orion Internal Baffles .....	38
Figure 26: CG Position.....	40
Figure 27: CG Front View .....	40
Figure 28: Final Orion Drawings.....	41
Figure 29: Pre-Day Checklist .....	42
Figure 30: Orion Loading .....	42
Figure 31: Truck Unloading.....	42

Figure 32: Communication with other Aircraft.....	43
Figure 33: Flight Characteristics.....	45
Figure 34: Post Mission Checklist .....	45
Figure 35: Flight Documentation .....	46
Figure 36: Mission Debrief .....	46
Figure 37: Routine Maintenance Checklist.....	47
Figure 38: Fuel Storage .....	47
Figure 39: Cooperative Obstacles Decision Making .....	49
Figure 40: Obstacle Avoidance Procedure .....	50
Figure 41: Lights .....	51
Figure 42: Sensor Ranges and FOV .....	52
Figure 43: Rural Airport Communication Failure Procedures.....	52
Figure 44: Emergency Flowchart .....	61

## List of Tables

Table 1: Airframe Preliminary Down Selection .....	9
Table 2: Wing Type.....	11
Table 3: Airfoil Types .....	14
Table 4: Airfoil Comparison .....	15
Table 5: Empennage Airfoil Comparison .....	16
Table 6: Propeller Airfoil Comparison.....	16
Table 7: Material Comparison .....	21
Table 8: Component List.....	22
Table 9: Sensors.....	31
Table 10: GCS Components .....	31
Table 11: C3 Personnel .....	32
Table 12: Ground Personnel .....	33
Table 13: PPE.....	34
Table 14: Hangar Items.....	36
Table 15: CG x-axis .....	39
Table 16: CG y-axis .....	39
Table 17: CG z-axis .....	40
Table 18: Flight Characteristics.....	44
Table 19: Fuel Consumption .....	47

Table 20: Sensor Components.....	51
Table 21: FAA Exceptions.....	54
Table 22: FAA Part 23.....	55
Table 23: FAA Part 25.....	55
Table 24: FAA Part 121.....	56
Table 25: FAA Part 135.....	57
Table 26: Risk Score Calculations.....	58
Table 27: Assessing Risk Values .....	59
Table 28: Transportation Type Fuel Usage Comparison .....	62
Table 29: Transportation Type Fuel Price Comparison .....	62
Table 30: Total Personnel Costs .....	63
Table 31: Total Operational Costs Comparison.....	64
Table 32: Orion and Truck Emissions Rate .....	65
Table 33: Orion and Crewed Aircraft Emissions Comparison .....	66

## Executive Summary

In recent years, delivery services such as Amazon and FedEx have grown immensely, especially following the COVID-19 Pandemic. The delivery industry is expected to grow from 167.54 billion USD to 432.32 billion USD by 2030. However, this growth in delivery comes with increased amounts of common pollutants such as carbon dioxide, sulfur dioxide, and other greenhouse gases. In 2021, shipping services made up for 3% of the annual greenhouse gas emissions within the US. A change needs to be made to safely preserve our environment and to create quicker, more efficient package deliveries.

Conventionally, delivery services over long distances require piloted planes or trucks that let out tons of pollution each year. In response to this, the RamJets have created a unique, safe, and more eco-friendly option for delivering packages over long distances. This solution has a shortened transit time than traditional air cargo transportation with similar costs and carbon emissions to ground transportation. The RamJet's Unmanned Aerial Vehicle (UAV), the Orion, is an innovative design capable of traveling at subsonic speeds delivering cargo to rural airports while following all Federal Aviation Administration (FAA) standards set upon traditional crewed systems.

The requirements to travel 300 nautical miles and reach heights of 20,000 feet, created a great challenge for the RamJets in aircraft design. The RamJets would go through three design phases, going through multiple downselection processes, to create an effective response to the challenge. The RamJets would utilize a mix of Occam's razor as well as meeting given challenge criteria to efficiently design Orion. A typical fixed-wing design was chosen due to its ability to reach the given altitude and distances. Then, RamJets chose a turboprop power plant due to its ability to easily travel to 20,000 feet above sea level and subsonic speeds, creating quick and efficient package transport. The remaining components were selected or modeled to work with these choices; design choices would need to meet ideal speed levels provided by the engine. The team created a functional aircraft, capable of carrying 4,000 lbs and promptly created a CAD model.

In addition to this, the RamJets safety and Concept of Operations (CONOPS) team was challenged with creating an effective safety system that followed FAA regulations for traditional manned aircraft. Orion needed proper avionics controls that would allow a pilot to control the aircraft while being hundreds of miles away. With this, the team needed proper obstacle avoidance, as well as a cockpit view, for the pilot in command. Multiple sensors and First Person View (FPV) cameras allowed the aircraft to have a 360° view of its surroundings. A working warehouse and Ground Control Station (GCS) was designed, capable of controlling all systems on the aircraft with a proper GCS for the pilot. To get Orion into the air, flight plans are pre-set within the flight controller, and Simultaneous Localization and Mapping (SLAM) is used to map out the flight before, during, and after it takes place. The team had to create a flight plan to ensure all FAA regulations were met.

The RamJets had to ensure the business case allowed for a cost-effective delivery when compared to typical trucking and manned cargo aircraft. Without the need to calculate fixed cost, the team calculated operating costs, such as fuel and labor, to create a cost-effective alternative to typical delivery. The business case also compared the Orion to the alternative delivery methods using carbon emissions and transit time. Furthermore, a flight profile analysis was created to view ascent, cruise, and descent fuel burns. With an overall reduced labor and fuel cost, Orion is an affordable option that delivers packages fast and efficiently.

Thus, Orion is a more fuel-efficient and environmentally friendly alternative compared to other options; it operates safely in national airspace while being unmanned. The newest opponent in the delivery field has arrived, and will pave the path to the future for larger, more efficient, UAVs within the delivery field.

## Specification Table

Criteria	Value	Met (yes/no)	Section #, page #
Aircraft			
Takeoff weight including full cargo (4,000 lbs)	11,471.99 lbs		2.5, 37
Wingspan (fixed wing) or max width (other)	49.22 ft		2.3.1, 9
Cargo contained in 2 LD3 unit load devices		Yes	2.3.1, 9
Cargo total of 4,000 lbs		Yes	2.3.1, 9
Takeoff distance (must be less than 3,000 ft with full cargo)	2,845 ft		2.3.1, 9
Range of 300 nm with 45 min of fuel reserve for normal cruise		Yes	2.3.1, 9
UAS Command, Control, and Communication			
Redundant systems		Yes	2.3/3.3.1, 9/47
Aircraft has transponder to identify itself and provide current speed, heading, and altitude		Yes	3.3.1, 47
Aircraft continuous monitor by personnel at airfield		Yes	2.3.2, 52
Aircraft capable of receiving new commands while in flight and modify flight pattern accordingly		Yes	2.3.2, 52
Detect and Avoid (DAA)			
Aircraft must detect static and dynamic obstacles		Yes	3.3.1, 47
		Yes	3.3.1, 47
DAA system architecture must fit with C3 capabilities		Yes	3.3.1, 47
Lost Link Protocol			
Aircraft must have protocols in case of partial loss of communications		Yes	3.3.2, 52
Aircraft must have protocols in case of total loss of communications		yes	3.3.2, 52

# 1. Team Engagement

## 1.1 Team Formation and Project Operation

Rancho High School's Real World Design Challenge (RWDC) Team is an extracurricular school club. Recruitment of new team members began at the beginning of the school year to allow time for members to learn necessary information, such as reviewing previous year's submissions and developing the skills for Computer-Aided Design (CAD) modeling on SolidWorks, to begin the challenge immediately following the project statement's release.

**Rebecca Hopps (Team Lead, Design Engineer)** is a fourth-year member of the team in the Aerospace Engineering program and has experience with each aspect of RWDC. She is responsible for managing the overall project and ensuring the team's progress is on track with the timeline delineated in section 2.2 Project Plan. Rebecca's previous experience leading engineering efforts such as UAV modeling and C3 component selection in addition to her experience with CONOPS—specifically in-flight logistics and maintenance planning, and business case development have given her a solid foundation of the challenge, modeling software, and Excel functionality.

**Maranata Gebre (Project Manager, Systems, Safety, and Business Engineer)** is a third-year member of the team in the Aerospace Engineering program who is tasked with ensuring the team is meeting established goals and deadlines. Prior to RWDC, she had virtually no background in engineering but has developed significant skills in research, team leadership, and technical writing through her years on the team. Her interaction with mentors in the STEM field has inspired her to work harder. Her experience, work ethic, and unique perspective made her the perfect candidate for team leadership and the systems design aspect of the challenge.

**Andrew Palmberg (Lead Engineer, Design Engineer)** is a second-year member of the team in the Aerospace Engineering and Aviation Technology programs. He has significant experience in leadership roles and working with others from being an Eagle Scout. His knowledge gained through working on the engineering section of last year's challenge gave him the skills required to lead RamJet's engineering section.

**Jordan Tran (Lead Systems Engineer)** is a second-year member of the team enrolled in the Aerospace Engineering program. Seeing a surge in rocket development inspired Jordan to pursue a career in Aerospace Engineering. RWDC allows him to learn from professionals in that field and have a better understanding of his passion. His drive to learn about the design of components and his experience from being last year's lead system engineer made him the prime candidate for leading the RamJets' system design.



**Jacob Johnson (Lead Design Engineer)** is a first-year member of the team in the Aerospace Engineering program with an aptitude for the technical aspects of the challenge. Despite this being his first year on the RWDC team, Jacob's knowledge of engineering and physics concepts as well as excellent research and CAD modeling skills allow him to lead the UAV model development and design.

**Samuel Gonzalez (System and Safety Engineer)** is a first-year member of the team enrolled in the Aerospace Engineering and Aviation Maintenance programs. He is part of multiple activities at Rancho such as the magnet ambassadors, speech and debate, and chess club. He is also working on other projects, such as designing a sugar-powered rocket. Samuel utilized this experience to assist the team in research, technical writing, and the selection of safety and communications systems.

**Biniam Gebre (Business Development Lead)** is a first-year member of the team and is in the Aerospace Engineering program. He is a hard-working individual who brings his skills and talents gleaned from other clubs, such as robotics and REP (Research Education Program), to RWDC. RWDC enables him to learn from more experienced members of the team, and the mentors of the challenge to expand his knowledge on various types of systems and business concepts.

## 1.2 Acquiring and Engaging Mentors

Before the end of the previous school year, the team reached out to mentors from the 2022 RWDC team to secure their assistance for this challenge. Las Vegas, Nevada, is the primary home for all United States Air Force (USAF) and Great Britain's Royal Air Force (RAF) Medium Altitude Long Endurance, Unmanned Aerial Systems (MALE UAS) global activities. As such, the military mentors are critical assets in the aviation and mission elements of this project. From previous experience, the team identified that strong mentors would be needed in engineering and design, Concept of Operations (CONOPS), and business to ensure the team received guidance for all parts of the challenge. The Team Lead made sure to incorporate mentorship from individuals, both familiar with the RWDC as well as technical business concepts.

Kimberly Hopps, Director of Financial Planning and Analysis at NV Energy with 19 -years of experience primarily focused on business performance management and the financial aspects of electric generating stations, assisted the team on business case components.

Mrs. Hopps and MAcr (Master Air Crewman) Eric McCabe, the UAV Pilot and Mission Analysis Mentor, helped the team understand how engineering, CONOPS, and business case were dependent on one another.

The team utilized alumni from previous years; UAV modelers Jhonathan Ascension-Martinez and Carl Fernandez. They provided key insight and advice for the team using past experiences in RWDC as well as new engineering knowledge from college. Their expertise in SolidWorks also made them the perfect choices to aid and teach members of the team in CAD modeling.

### 1.3 State the Project Goal

The RamJets have been invited to provide an in-depth proposal to deliver packages safely and efficiently to rural areas using Unmanned Aerial Systems (UAS). Requirements included creating an UAV that can transport 4,000 lbs of packages evenly distributed within two LD3 unit load devices (ULD). The UAV must travel from a major airport to a smaller airport located 300 nautical miles (NM) away. Because of the smaller airport's limitations, the UAV must be capable of takeoff within 3,000 ft with full cargo. The UAV must also have a cruise altitude of 20,000 ft and operate on standard aviation fuel including a 45-minute fuel reserve contingency.

The UAV must comply with the safety standards from the FAA and include proper communications devices to ensure safe operations in national airspace. All components associated with the operation and control of the UAV must be included in the written discussion of the notebook.

There must be a written comparison of the performance of the RamJet's UAV to other standard package delivery methods; crewed cargo planes and 18-wheeled semi-trailers (trucking) on metrics such as cost, time and carbon emissions. Cost-benefit analysis must be completed throughout the design process to ensure the UAV is the best solution to meet challenge requirements.

### 1.4 Tool Setup/Learning/Validation

The team expanded on learning from previous challenges and included more virtual meetings than in previous years. The team utilized the knowledge and experience from returning team members, but valued the new perspectives brought by new members to select the use of these tools.

**Airfoil Tools** were used to find accurate information about airfoils the RamJets would be utilizing. Its easy accessibility allowed the team to create the airfoils in SolidWorks as well as get data regarding them which significantly contributed to the airfoil down selection processes.

**Google Drive** was used for organizing files effectively to benefit the success of the team. It allows all who are in the shared drive to view and edit documents at the same time. This also allowed the mentors to view the files so that they could review the information. During the challenge, the team encountered issues with organization and finding documents within the

drive. This was solved by creating specific folders and names for documents that made it easier to organize.

**Google Docs** allowed the team to create drafts for the engineering notebook. Its online sharing functionality allowed the team to collaborate simultaneously and create edits in real-time, while performing research on subjects assigned

**Microsoft Word** was used for the final version of the RamJets notebook. There were formatting difficulties when transferring Google Docs to Microsoft Word, but this was solved by allocating more time to creating the word document and editing the submission.

**Google Spreadsheets** were used for the CONOPS and business case. This application allowed the team to visualize and calculate necessary components. Team members have developed significant skills with advanced formulas and formatting options as well as spreadsheet organization. There was a steep learning curve for new members in using advanced spreadsheet formulas.

**SolidWorks** is the CAD program the team used to model the UAV. Due to the team's overall limited experience with SolidWorks, designing the UAV was a slow process. However, with the help of previous members, as well as utilizing other resources such as YouTube, the team was able to become familiar with the application.

**iMessage and Google Meet** were used as communication tools for the team to plan meetings and to discuss the project. Because of the limited access for in-person meetings, due to after-school club rules requiring a teacher to be present, the team needed to find a way to gather and complete assignments online. Google Meet was the primary way of contacting mentors and for having virtual work-meetings. Additionally, the team had regular Saturday meetings with the mentors to present the progress made throughout the week, ask questions and receive guidance.

## 1.5 Impact on STEM

Prior to RWDC, each of the RamJets had a minimal idea of what a STEM career would entail. Most of the team is enrolled in the Aerospace Engineering program, which is a 4-year course that teaches students the fundamental concepts of aerospace engineering as well as basic skills with engineering software such as Solidworks. Besides this, team members are enrolled in many honors, advanced placement, and advanced study courses. Despite this, the team still felt their understanding of a STEM career was lacking.

Due to its focus on real-world design, the RamJets were provided with a unique opportunity to explore a practical application of some of the skills and knowledge that was studied in their

engineering program. RWDC has developed the student’s problem-solving abilities, critical thinking, teamwork, and other skills essential to future endeavors.

The mentors offered real-world professional and technical experience from their fields ensuring that the RamJets’ design, operations and business plan were as realistic as possible. Not only did the mentorship inspire the RamJets to further investigate STEM fields for themselves, but it also allowed the team to understand how their own classes would apply to the different STEM fields. Students in other classes with the team members were greatly interested in the undertaking of a large-scale engineering project. In addition, teachers were curious and fascinated about the challenge and wanted to help in any way.

## 2. System Design

### 2.1 Engineering Design Process

One of the team's first considerations was how to approach and complete each step of the challenge. After deliberation and help from mentors, the team created a process that allowed the UAS to be designed efficiently and be relevant to the challenge statement. The RamJets mentors believed it was essential to stress the iterative nature of the engineering process because it demonstrated that the team was constantly reevaluating the design to ensure the best possible UAS. The following are chronological stages to the process.

Figure 1: Engineering Design Process

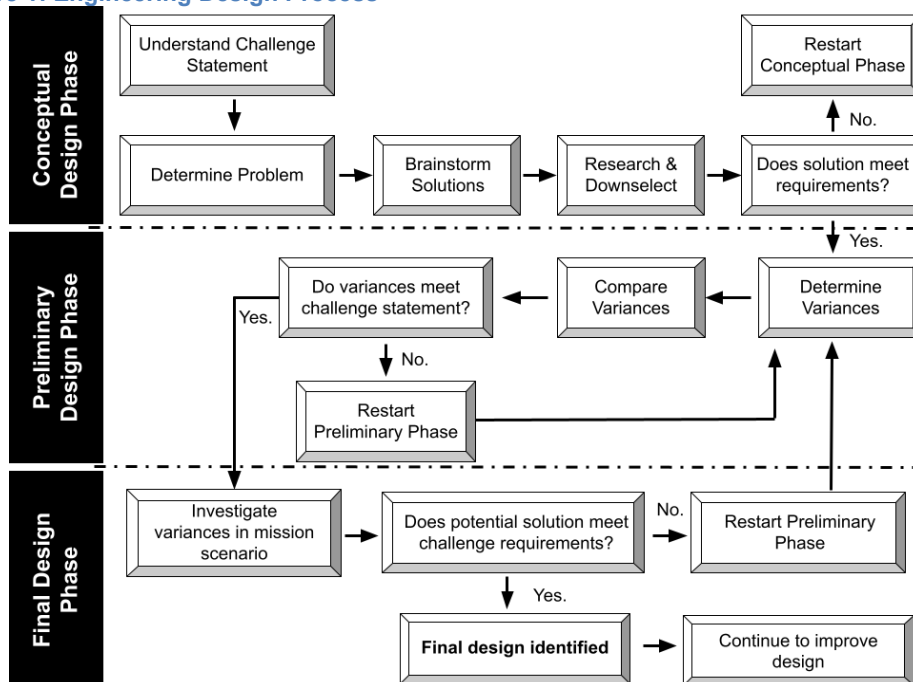

**Stage 1: Conceptual Design Phase**

To understand the challenge, the team thoroughly read and highlighted goals in the challenge statement. With these goals in mind, the team created a list of ideas that were compared to the challenge's requirements using spreadsheets. If the idea(s) could meet the challenge criteria, it would move on to the preliminary design phase.

**Stage 2: Preliminary Design Phase**

During the preliminary phase, the team visualized and compared potential variants from the solutions determined in the conceptual phase; to identify the most optimal design. The team then visualized these concepts through sketches to compare them even further.

**Stage 3: Final Design Phase**

During the last stage, the final design was compared to the mission statement. The team then searched for potential improvements, if discovered, the engineering design process was restarted to polish the final design.

**2.2 Project Plan**

Figure 2: Gantt Chart  
**PROJECT TIMELINE**

PROJECT TITLE	RWDC National Challenge	COMPANY NAME	Rancho Ramjets
PROJECT MANAGER	Rebecca Hopps & Maranata Gebre	DATE	1/1/23

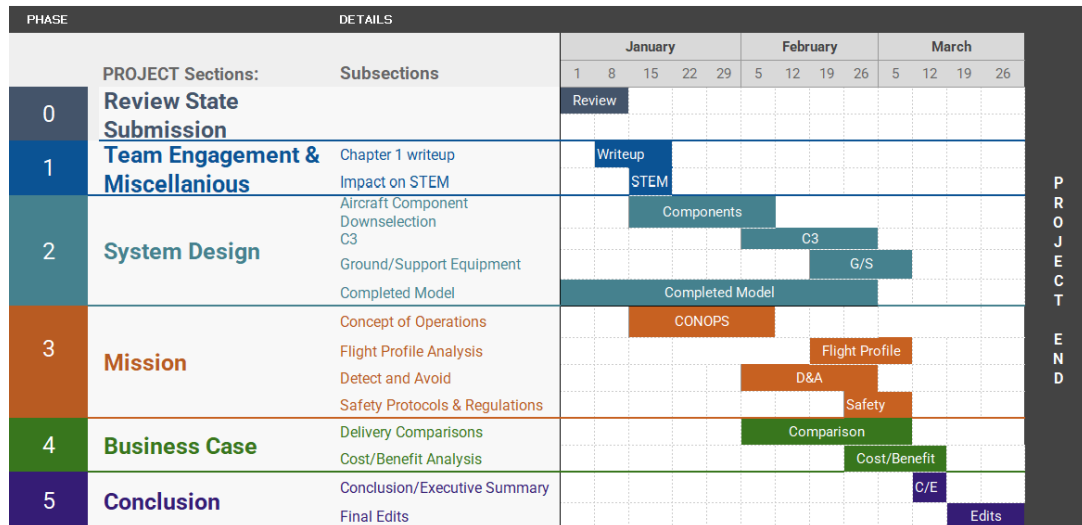

The team developed a clear schedule for assignments to ensure productivity. At the beginning of the challenge, review of the state notebook commenced to identify issues that needed to be addressed in the national challenge. From there, each chapter was separated into the main subsections as key milestones for completion. Milestone dates

were set based on prior experience and relevance to the completion of the project. For example, chapter two was worked on first because the information found in that section was instrumental in other sections. Figure 2: Gantt Chart does not demonstrate the iterative process used in all aspects of design which meant that despite working on one specific aspect of the notebook all other parts were also being considered. For example, when deciding on the sensors and materials used on Orion; quality, price, and compatibility with the CONOPS section were considered.

## 2.3 Subsystems

### 2.3.1 Air Vehicle

**Airframe Downselection Part One: Conceptual Design:** The RamJets followed the engineering design process covered in 2.1 Engineering Design Process to decide the finalized airframe type.

The challenge statement requires the aircraft to be able to:

- carry 4,000 lbs
- fly at a cruise altitude of 20,000 ft
- take off and land, fully loaded, on a 3,000 ft runway
- fly 300 nautical miles (NM) with additional fuel tanks
- carry an extra 45 minutes worth of fuel
- carry two LD3 ULDs

Every requirement that an airframe meets is marked with a green 'Y'. Requirements that are not met are marked with a light red 'N' and eliminated from further consideration using AND Gate Boolean logic, where if one requirement is not met the design is eliminated from evaluation. Requirements that are marked with a gray 'X' represent conditions that are no longer under consideration.

**Table 1: Airframe Preliminary Down Selection**

Airframe	4,000 lbs	20,000 ft Cruise	3000 ft Runway	300 nm	45 min Fuel	Two LD3s
Fixed Wing	Y	Y	Y	Y	Y	Y
Helicopter	Y	N	X	X	X	X
Multicopter	Y	N	X	X	X	X
Hybrid-Fixed Wing	Y	Y	Y	Y	Y	Y
Lighter than air	Y	N	X	X	X	X

The hybrid-fixed wing and the fixed wing airframe types met all essential requirements, so they advanced to preliminary design.

Figure 3: VTOL Conceptual Sketch

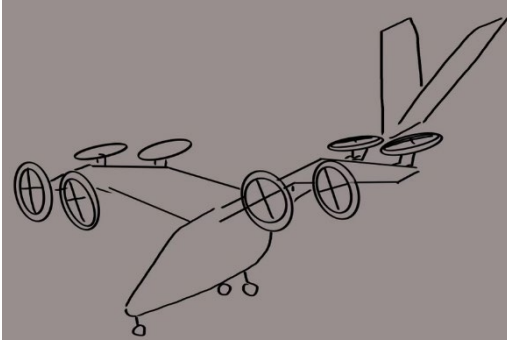
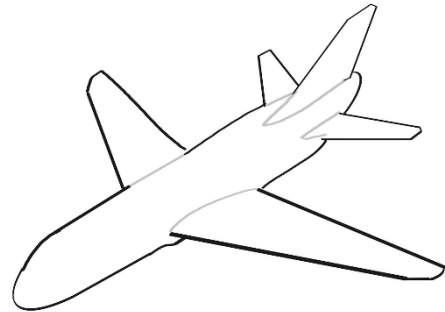

Figure 4: Fixed Wing Conceptual Sketch



**Preliminary design:** The main difference between the two designs is that hybrid-fixed wing aircraft have vertical take-off and landing (VTOL) capabilities, while fixed wing aircraft only possess conventional flight. Based on the challenge, VTOL is not necessary and adds more complexity to the design through the addition of more moving parts. Thus, hybrid-fixed wing was eliminated and the team selected fixed wing as the airframe for their UAV.

**Detailed Design:** The team considered the specifications of Orion including the size, type, and material of each part.

**Fuselage:** The three options considered for the fuselage were truss, monocoque, and semi-monocoque. Truss is used in small, lightweight aircraft and is usually made out of steel (4 Common Types of Airplane Fuselages, 2021). A monocoque fuselage structural design is lightweight and stiff. This bending aspect makes the monocoque framing structurally unsatisfactory (Howe, 2014). A semi-monocoque fuselage provides great structural integrity while still being lightweight due to being made of a series of beams. This leads to greater fuel efficiency (Monocoque and Semi-Monocoque Structures, 2017).

Figure 5: Fuselage Structure

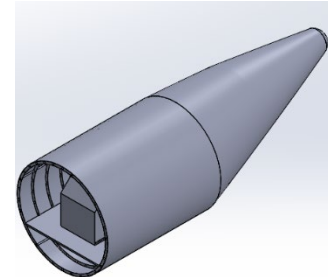

Thus, the team decided upon a semi-monocoque fuselage because of its lightweight characteristics, allowing for greater fuel efficiency while still having a strong base.

**Wing Shape:** Wing shape significantly affects the flight characteristics of an aircraft, and must be selected according to an aircraft's specifications and criteria. The main determining factors are the following specifications:

1. Landing Distance Requirement
2. Occam's Razor - methodology where the simplest solution is the best solution

3. Airspeed
4. Stable structure at  $\pm 10^\circ$  angle of attack (AOA)

Table 2: Wing Type gives the type of wings that were considered along with reasons for elimination.

Table 2: Wing Type

Wing Type	3k ft Runway	Occam's Razor	Suited for 285 NM/h	Stable structure at $\pm 10^\circ$ AOA
Rectangular	Y	Y	N	X
Elliptical	Y	Y	N	X
Tapered	Y	Y	Y	Y
Delta	N	X	X	X
Trapezoidal	Y	Y	N	X
Ogive	Y	Y	N	X
Swept Back	Y	Y	N	X
Forward Swept	Y	Y	Y	N
Variable Sweep	Y	N	X	X

The team originally decided to utilize a swept-back wing, but the powerplant was changed which affected the speeds that Orion could achieve. The main benefits of the swept back wing's high efficiency are only applicable at transonic speeds which far exceed Orion's maximum speed capabilities. Switching to a wing with a smaller side profile also allowed the team to consider loading LD3s into the aircraft from the side via forklift.

Thus, the team decided to utilize a tapered wing due to its greater aerodynamic efficiency when compared to a rectangular airfoil while still maintaining structural stability at all angles of attack (Wainfan, 2020). The tapered wing is also superior to the swept wing because it maintains its flight characteristics at higher AOAs, allowing Orion to climb to cruise altitude much faster.

**Aspect Ratio:** A medium aspect ratio was decided upon as it couples the improved lifting capabilities of a high aspect ratio and lower susceptibility to in-flight flex loads of a low aspect ratio wing (Nassise). Light aircraft that have a medium aspect ratio average around 7-9 (Aspect Ratio, 2022). Because of this, the team chose the high-end value of nine for a medium aspect ratio.



**Wing Configurations:** The team also had to decide between a low wing, a high wing, or a mid-wing. Mid wing cuts into the fuselage leaving less room for cargo and was promptly eliminated. To decide between a low or high wing, the team spoke with a former expert in the air force, Rob Balmer. A high wing aircraft is more stable during flight as it's easier to balance the center of gravity (CG) (Masters, 2021). In addition to this, a high wing is more common amongst cargo aircraft and produces less ground effect when compared to low wing aircraft, decreasing landing distance (Herbert, n.d.). Therefore, Orion would utilize a high wing due to its increased stability.

**Figure 6: Aircraft Preliminary Sketch**

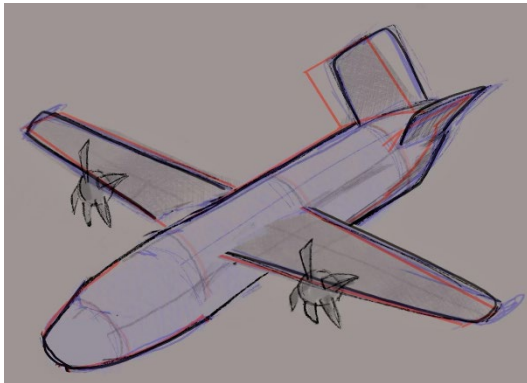

straight wing aircraft.

**Wingspan:** The taper ratio of an aircraft is the ratio from the root chord to the tip chord. This element is vital when looking at an aircraft's aerodynamics as a lower taper ratio provides efficiency, but increases stall characteristics. The team decided to use a taper ratio of 0.4 as this is the taper ratio for most commercial airliners (How to Calculate Taper Ratio, 2017). This was used along with calculations for the wing area to calculate the chord length at the root and the tip. When the team originally calculated the coefficient of lift, only the lift provided by the wings was included. Because of this, the wings were unnecessarily large. To fix this, the team used principles of vector addition to find the vertical component of the thrust vector that Orion would be using. Once found, the total size of Orion greatly decreased and thus decreased the weight. These calculations gave Orion a wingspan of 49.22 ft or 15 m.

Given a high wing would be used, the team had to decide whether or not to use an anhedral wing. The team found that anhedral wings are restrictive amongst cargo aircraft as they provide less room for loading as well as creating more complexity within the design. An anhedral wing also creates more drag for given levels of lift and increases roll characteristics of a plane (Anhedral Wing Elements, 2013). This led to the RamJets deciding upon a

### Wing Area Calculation:

Equation Used: Modern Lift Equation

$A$  = Wing Surface Area

$F_L$  = Force of Lift = Weight – Vertical Component of Thrust = 10,717.4lbs

$CL$  = Coefficient of Lift  $\Rightarrow$  Angle of Ascent  $\Rightarrow \tan^{-1}\left(\frac{20000}{316800}\right) \approx 2.75^\circ \Rightarrow$

Airfoiltools.com  $\Rightarrow$  .8603

$\rho$  = Air Density at Altitude (standard day)  $\Rightarrow$  .001267

Velocity  $\approx$  513ft/sec

$$\text{Modern Lift Equation} \Rightarrow F_L = \frac{CL A \rho V^2}{2} \Rightarrow A = \frac{2(10717.4)}{(.8603)(.001267)(513)^2} \approx 27\text{m}^2$$

### Chord Length Calculations:

$AR$  = Aspect Ratio = 9

$TR$  = Taper Ratio = .4

$C_{tip}$  = Chord Length of Wing Tip

$C_{root}$  = Chord Length of Wing Root

$$AR = \frac{\text{Wingspan}^2}{\text{Wing Area}} \Rightarrow 9 = \frac{x^2}{27} \Rightarrow 243 = x^2 \Rightarrow x = \sqrt{243} \approx 15\text{m}$$

$$TR = \frac{C_{tip}}{C_{root}} = .4 \Rightarrow C_{tip} = .4C_{root}$$

$$\text{Wing Length} = \frac{\text{Wingspan} - \text{Fuselage Diameter}}{2} = 6.45\text{m}$$

$$\text{Area of a Trapezoidal Wing} = \frac{1}{2}(6.45)(C_{tip} + C_{root}) = 13.5$$

$$3.75(1.4C_{root}) = 13.5 \Rightarrow 5.25C_{root} = 13.5 \Rightarrow C_{root} = 2.4\text{m}$$

$$C_{tip} = .4C_{root} = .4(2.4) = .95\text{m}$$

**Flaps/Slats Vs Air brake:** The team decided to only use flaps and slats due to air brakes being primarily used to slow aircraft down upon descent. This would be important if the

aircraft was attempting to rapidly descend from the 20,000 ft cruising altitude. However, the aircraft already has an additional 5 minutes to descend than required, and the addition of airbrakes would increase the required maintenance due to the addition of moving components. Flaps are used to increase the lift during landing without increasing airspeed and slats are used to provide more lift during a steep takeoff. While Orion is capable of taking off and landing, flaps and slats are required to land within the 3,000 ft runway (Flaps and Slats, n.d.). Airbrakes were not added due to providing unneeded benefits, while flaps and slats were added to allow Orion to meet criteria. Additionally, Orion utilizes a constant-speed propeller, later mentioned in this section, that can act as an airbrake.

**Airfoil:** The possible selections of airfoils were symmetrical, flat bottom, and non-symmetrical. A symmetrical airfoil is mainly used for rotary-based aircraft as well as lightweight aerobic aircraft as the pressure balance on a symmetrical airfoil allows for greater performance of lightweight aircraft and not cargo aircraft, (Exploring the Aerodynamics of Symmetrical Airfoil, n.d.) eliminating it from the downselection process. Flat-bottom airfoils produce the highest amount of drag out of all the airfoils (Flat Bottomed vs. Semi-Symmetrical vs. Symmetrical Airfoils, n.d.) and were therefore eliminated from the downselection.

The non-symmetrical airfoil options include high camber, mid-camber, and negative camber. A negative camber airfoil was eliminated due to the negative value added to the lift coefficient which overall decreases the aircraft's lift (Negative Camber - The Anatomy of the Airfoil, 2022). Because the team decided to use flaps and slats to provide more lift on take-off, a high camber was unnecessary and too complex. Thus, a mid-camber airfoil was selected due to the optimal lift-drag ratio. The table below shows the advantages and disadvantages of different airfoil types.

**Table 3: Airfoil Types**

Airfoil type	Design	Lift efficiency	Stall Characteristics	Design Complexity
Symmetrical	Same shape above/below chord line.	More beneficial for high speeds	Higher stall speed	Simple design
Non-Symmetrical	Types: High/low or mid camber	More lift at lower AOA	Stalls at relatively low speeds. Responds well to turbulence.	High complexity
Flat-Bottom	One side of the airfoil is flat. Made for small maneuverable aircraft.	Less lift at similar AOA as others.	Stalls at very low speeds.	Low complexity

Because the wing is tapered, the RamJets had to consider whether the airfoil would consist of two different airfoils tapered down or a single airfoil tapered down. Based on Occam's Razor, a single airfoil tapered down was to be used. The team then proceeded to look into airfoils that provided a high coefficient of lift over the coefficient of drag (Cl/Cd) for a low AOA. The team analyzed three candidates: the NASA/Langley LS(1)-0417MOD, the NN7 MK20, and the EPPLER 556. The table below shows the Cl/Cd ratio of each airfoil at differing AOA. A higher Cl/Cd gives the aircraft more lift and less drag. The Figure 7: Wing Stress Simulation depicts the wing's stress simulation.

Figure 7: Wing Stress Simulation

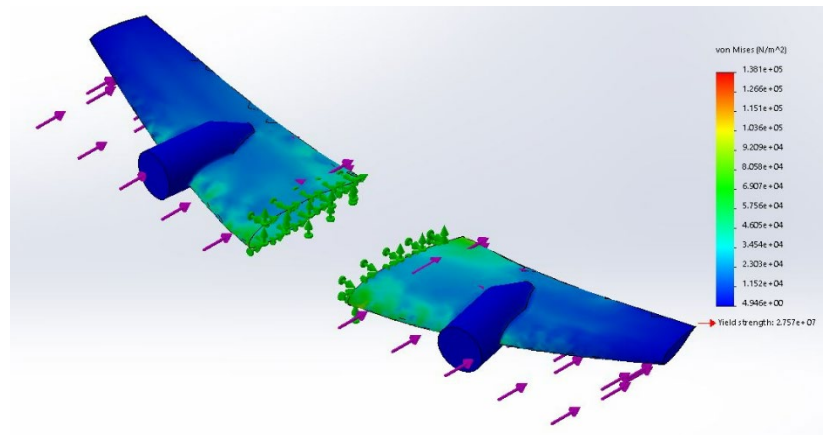

Table 4: Airfoil Comparison

Airfoil	Max Cl/Cd	Max Chord Thickness
NASA/Langley LS(1)-0417MOD	112.6 at $\alpha=2.5^\circ$	17%
NN7 MK20	127.2 at $\alpha=5.75^\circ$	16.9%
EPPLER 556	116.4 at $\alpha=5.5^\circ$	16%

The NASA/Langley LS(1)-0417MOD is better when compared to the other airfoils due to its higher Cl/Cd. The thickness of the airfoil increases the lift (Factors Affecting Lift, n.d.) as well as increasing the strength of the airfoil at the downside of increased weight. With this information, the team decided upon the NASA/Langley LS(1)-0417MOD as the airfoil.

**Empennage Airfoil:** When deciding the airfoil for the empennage, the team looked into symmetrical airfoils as they are more commonly used. Given the team is using a V-tail empennage (detailed later in the section), the goal of the empennage airfoil would be to achieve a smaller surface area than that of a horizontal or vertical wing (Empennage General Design). The overall lack of V-tail aircraft made the team only able to consider horizontal tailed empennage. To consider this airfoil, the team took heavy inspiration from current day aircraft such as the Cessna Citation and the Fokker F27 due to their relative size correlation. This narrowed the airfoil options down to NACA 0008, NACA 0010, and NACA 63A-014; all of which

being symmetrical airfoils used for the empennage of their respective aircrafts. Table 5: Empennage Airfoil Comparison shows the statistics of the possible selected airfoils.

Using the data shown in the table below, the RamJets selected the NACA 63A-014 due to its high  $Cl/Cd$  at a low angle of attack as well as its high chord thickness, increasing strength of the empennage. This strength is greatly needed due to concerns that V-tail empennages commonly break making up for the increased weight of the airfoil.

**Table 5: Empennage Airfoil Comparison**

Airfoil	Max $Cl/Cd$	Max Chord Thickness
NACA 0008	68.3 at $\alpha=6.75^\circ$	8%
NACA 0010	70.2 at $\alpha=9.75^\circ$	10%
NACA 63A-014	72.8 at $\alpha=4.75^\circ$	15%

**Propeller (prop) Airfoil:** When looking for a blade airfoil, the team decided to look for an airfoil with the best  $Cl/Cd$  ratio with a high chord thickness to provide strength for the prop. It was decided the best airfoil would be flat bottom or symmetrical as it simplifies angle measurements on the propeller and simplifies design. The team immediately looked into Clark Y and NACA 4412 airfoils as they are most commonly used in prop aircraft (APC Propellers, n.d.). The R.A.F.6 airfoil was also researched. The below shows the three prop airfoils selected along with their  $Cl/Cd$  and max chord thickness.

**Table 6: Propeller Airfoil Comparison**

Airfoil	Max $Cl/Cd$	Max Chord Thickness
Clark Y	114.8 at $\alpha=6.75^\circ$	11.7%
NACA 4412	129.4 at $\alpha=5.25^\circ$	12%
R.A.F.6	104.8 at $\alpha=7.5^\circ$	10%

From this information, the R.A.F.6 airfoil was immediately eliminated due to its low  $Cl/Cd$  at a high AOA and its low chord thickness. This left the team to pick between the Clark Y and the NACA 4412. The NACA 4412 was decided upon due to its clear advantage of having the highest  $Cl/Cd$  at the lowest AOA as well as the highest chord thickness. The NACA 4412's flat bottom approach is able to prevent ground effect from occurring when compared to a high-cambered airfoil (Ockfen & Matveev, 2009). This prevents the aircraft from gliding which aids landing on a 3000 ft runway.

**Propeller Location:** Next, the team had to decide on prop location. This came down to deciding between a twin prop and a single prop. Twin props provide faster cruising speeds, while single props decrease manufacturing and fuel costs (Advantages of twin engine versus single engine for turbo-prop airplanes, n.d.). A twin engine adds redundancy in case of engine failure, and is more commonly seen in cargo aircraft due to increased power capabilities, thereby decreasing flight time. Furthermore, twin engines reduce the weight of the nose, creating a more balanced CG. However, a twin engine creates more weight and fuel burn. With all of these factors combined, the RamJets decided upon a twin engine due to its safety factors, cruising speed, and flight stability advantages.

There are mainly three types of propellers to choose from: fixed pitch, constant speed, and ground-adjustable propeller. The ground adjustable propeller was eliminated because the challenge assumes consistent standard atmospheric conditions, thus the prop would never have to be adjusted. As altitude increases, a constant-speed propeller is capable of changing pitch during flight to match the standard atmospheric conditions as altitude increases. Additionally, constant speed propellers are able to reverse thrust, acting as airbrakes. Fixed-pitch propellers are better suited for single-engine, low-altitude, low-speed aircraft. Despite the increased complexity, a constant-speed propeller was chosen as it benefits Orion by including the ability to adjust blade pitch, maximizing fuel efficiency by better matching Orion's altitude throughout flight (Aircraft Propeller Basics, 2020).

The amount of rotor blades significantly affects efficiency. Additional blades increase lift, but also increase weight and maintenance of Orion.

The number of blades heavily relies on engine power as more blades allow Orion to properly utilize engine horsepower. However, too many blades increase drag and can cause the engine to lose power (Advantages of more than 4 propeller blades, n.d.). The team selected five propeller blades because this number

decreases the noise produced by the UAV, decreases harmonic motion—vibrations on the propeller—and increases fuel efficiency due to the decreased weight by having fewer propellers (Are more propeller blades better?, 2018).

Aluminum alloy blades were decided upon as they are strong, light, easy to repair, and commonly used in aircraft (Aircraft Propeller Basics, 2020).

**Winglets:** Winglets are located at the tip of each wing and improve the performance of aircraft by reducing wingtip vortices, decreasing drag by approximately 5% and fuel usage by

Figure 8: Propeller

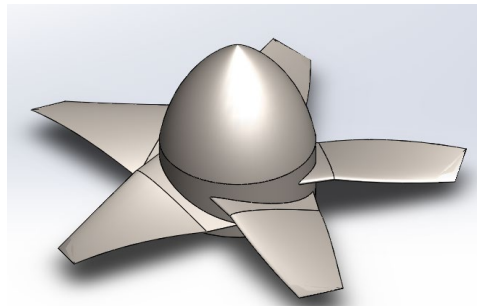

about 6.5% because the engines would not work as hard (Winglets, n.d.). However, winglets add weight to the aircraft, and for most planes—excluding airliners—the extra weight negatively impacts the aircraft more than the decrease in induced drag. (Why Winglets Are Typically Only Found On Larger Aircraft, 2022). Thus, the team chose to not use winglets.

**Side vs. Rear Cargo Access:** The location of the cargo access on Orion determines how LD3s are loaded. Rear access is conventional in large cargo aircraft but takes up space near the empennage. The biggest benefit to side access is the variety of ways to load cargo, ranging from a simple forklift to large omni-bearing powered container loaders. Operational costs significantly decrease by using a commercial forklift to load the containers as complex machinery is not needed. Given the importance of this decision the team evaluated the potential benefits in operational adaptability of side cargo access. A side access creates a simpler design and loading of LD3s, but if the cargo door is located under the wing, Orion would need to allow necessary room for the forklift to load the containers, demonstrated in 2.6 Final Design Drawings. Rear access creates great complexity in the design of the empennage. Thus, using Occam's razor, side access was decided upon.

**Empennage:** The empennage options considered by the team were T-shape, V-tail, Upside Down V-tail, Conventional, and H-style. Upside-down V-tail was eliminated as it requires a heavier structure to support the tail. H tail was eliminated due to its poor flight characteristics when damaged. T-shape was eliminated because if the rudder were to break, the entire empennage would break. If the team

Figure 9: Empennage Comparison

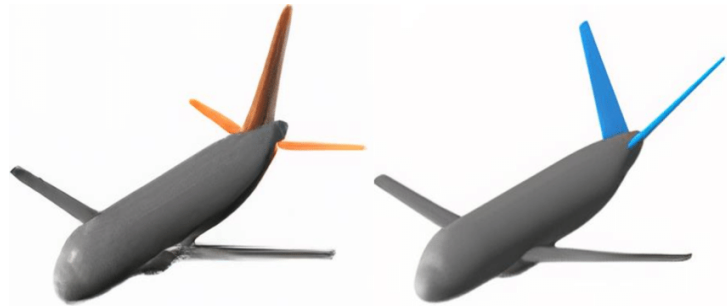

used a T-shaped empennage, the tail would need to be reinforced to reduce the risk of breaking and thus increase tail weight. Conventional and V-tail empennages are good options aerodynamically; however, V-tail is

lighter than a conventional style; increases efficiency; and helps reduce ground effect, aiding in landing. (To 'V' or not to 'V', 2017). V- tail empennages are not seen in the commercial industry due to being unable to deal with strong cross-sectional winds. However, the challenge statement assumes no weather conditions, rendering the V-tail the best option.

**Locking Mechanisms:** The side cargo access door is opened and shut using hydraulics. To learn how cargo is moved and strapped down, the team spoke to an industry

professional at the international shipping company DHL. The team learned that inside aircraft, all types of cargo are moved via a power drive unit (PDU). A PDU is a system of omni-wheels, motors, and a control panel, which move all types of

Figure 10: Omni-wheels



Figure 11: PDU



containers and aviation-grade pallets. Omni-wheels can roll in one direction and have smaller cylindrical parts that allow ULDs to move longitudinally relative to the aircraft. An example of an omni-wheel is shown in Figure 10: Omni-wheels. Using an array of said wheels, or a PDU, where half of them are facing parallel

to the chord line of the wings and half are perpendicular, the array of wheels can move the LD3s anywhere in the cargo hold. Additionally, clamps are used to tightly lock onto the bottom of the cargo. To lock the cargo in place, the team selected floor latches as shown in figure blank, due to requiring less floor space, allowing for a smaller fuselage. Compared to ratchet straps, floor latches reduce operating costs as it takes significantly less time to latch. To move the LD3s, the operator will use a control panel with the necessary joystick and switches to control the PDU as shown in Figure 12: Control Panel. The figure below shows the loading of the LD3. The red figure is Orion's door while the blue figure is the LD3. The final image has eliminated parts of Orion to show the door and cargo loading.

Figure 12: Control Panel



Figure 14: Landing Gear Model

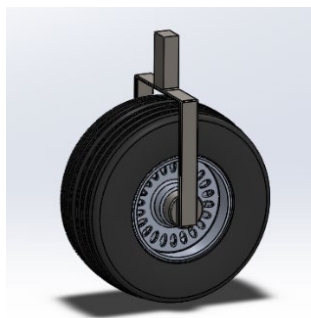

**Landing Gear:** The two main types of landing gear used on the

ground are tail wheel and tricycle. Tail wheel landing gear is commonly used for landing on undesirable terrain. (Tricycle Gear or Taildragger?, 2021). Given that tricycle landing gear is more commonly seen among commercial aircraft, the team decided upon a tricycle landing gear. From there, the team evaluated the landing gear specifications and if they needed

to be retractable. By not being retractable, the landing gear would be simpler to design and easier to maintain. However, it would

Figure 13: Tricycle Landing Gear

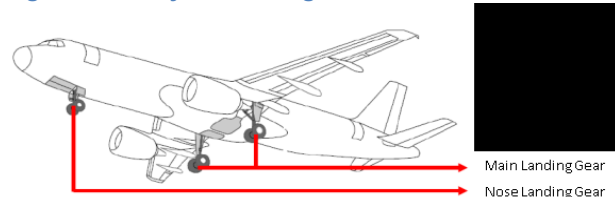



significantly increase drag which was more important than a simpler design. Thus, The RamJets utilize a retractable tricycle design due to increased flight performance.

**Engine:** The RamJets decided that the main considerations for an engine would be its reliability, power output, and overall efficiency. Because the team had already decided to use a turboprop, the search was limited to turboprop engines and turboshaft engines that could be converted to turboprops which are commonly used on cargo vehicles similar in size to Orion. Therefore, the team decided to pick between a family of PT6A engines and CT7 engines.

The team looked further into more specific engines of each family. The final contenders were the PT6A-42 and the CT7-8 engine. The PT6A-42 engine provides 850 shaft horsepower (shp) (Pratt & Whitney PT6A-42, n.d.) and is generally used in medium sized planes with twin engines. The CT7-8 engine produces around 2,500 to 3,000 shp and is generally used on helicopters. Because of this, the CT7-8 engine is a turboshaft engine that would need to be converted to a turboprop engine. The added horsepower of the CT7-8 engine was deemed excessive; it would consume a greater amount of fuel than the PT6A-42 engine. Because of this, the team's consensus was to use two PT6A-42 engines.

**Materials:** The materials Orion would be constructed with were considered under the criteria of cost, strength-weight ratio, density, and ultimate tensile strength. The selection of materials for the design was based on maximizing the strength of Orion, while also minimizing cost and weight. Minimizing weight was a priority for Orion to increase efficiency. So, the team researched materials commonly used in airplanes: magnesium, aluminum, and carbon fiber.

**Magnesium:** Magnesium is the best material in terms of weight compared to aluminum and carbon fiber. Magnesium has a better strength-weight ratio than aluminum. However, it has the lowest tensile strength compared to the other materials (Selecting the right lightweight metal, 2022). Because of the lack of strength and larger cost per kilogram, magnesium was eliminated.

**Aluminum:** Aluminum is more economical than magnesium and carbon fiber. It's reasonable in terms of ultimate tensile strength in comparison to magnesium, however, it's the heaviest metal in the entire down selection. While it may lack in its strength-weight ratio, aluminum's properties of malleability and desirable tensile strength make it a commonly used material in the aviation industry. (How Strong Is Aluminum?, 2018).

**Carbon Fiber:** Carbon fiber outperforms aluminum and magnesium in terms of tensile strength. Carbon fiber is made of long strands of polyacrylonitrile molecules held together by carbon atoms (Vaidyanathan, 2022), creating a great strength-weight ratio in comparison to its density. However, carbon fiber is more expensive per kilogram when compared to other options.

Carbon fiber also has undesirable burn characteristics despite its high melting point, leaving it susceptible to potential burns when the engine is at high temperatures (Aviation Stack Exchange, n.d.).

The majority of Orion was decided to be made of carbon fiber. Due to its low heat tolerance, the casing and structure around the engines would need to be made from aluminum. Thus, the team decided upon a mix of aluminum and carbon fiber to be used for Orion.

**Table 7: Material Comparison**

Materials	Tensile Strength (KSI)	Density (grams/cc)	Strength-Weight Ratio (KSI/g/cc)	Cost (\$/kg)
Magnesium	37.71	1.74	21.7	3.31
Aluminum	45	2.7	16.7	2.33
Carbon Fiber	500	1.8	263.2	24.2

**Material Breakdown:** Now the team had to create the model with its specific material breakdown. The specific materials the team would use include a 1060 aluminum alloy, carbon-fiber reinforced polymers (CFRP), and other miscellaneous materials found in the landing gear, engine, and other components such as rubber or steel. The model helped the team calculate Orion’s CG and allowed calculations for better fuel efficiency to be run. Each components’ weight was calculated using *Volume (in<sup>3</sup>) \* Density (lbs/in<sup>3</sup>) = Weight (lbs)*. Solidworks provided the volume and density of each component shown below:

**Figure 15: Material Model**

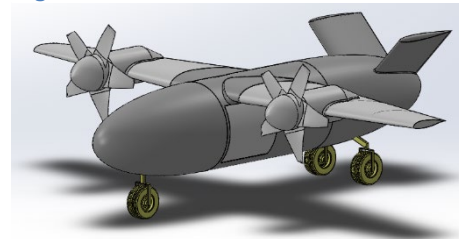

- **Aluminum 1060 Alloy (White):**  $18,926.8284 \times 0.0965 = 1,826.4389$  lbs (828.459 kg)
- **CFRP (Grey):**  $50,627.01 \times 0.065 = 3,290.7556$  lbs (1492.661 kg)
- **Miscellaneous (Gold):** 1,533.9755 lbs (695.800 kg)
- **Total Weight:**  $2,632.4389 + 3,290.7556 + 727.9755 = 6,651.19$  (3016.929 kg)

**Landing Distance Calculations:** The exact calculations for the landing distance were too complex to derive a meaningful figure. Therefore, to ensure Orion landed within the 3,000-ft

**Figure 16: Beechcraft Air King 200**



runway, the team researched similar planes and their landing distances. The challenge statement selected the Cessna 408 which offers a landing distance of 3,010 ft, however, has a weight of 19,000 lbs. This weight is about 8,000 lbs heavier than Orion. The team decided it

was best to investigate aircraft utilizing the same engine with relatively similar weight and wingspan. The team was brought to Beechcraft Air King 200 as seen in Figure 16: Beechcraft Air King 200. This aircraft has two PT6A-42 engines like Orion, and a max takeoff/landing weight of 12,500 lbs with a wingspan of 16.61 m. These numbers are very similar to Orion’s weight and wingspan. The Beechcraft Air King 200 has a landing distance of 2,845 ft (King Air B200 Private Jet Charter, n.d.) and would put Orion within the 3,000 ft runway requirement. Furthermore, the Beechcraft Air King 200 utilizes a low wing increasing ground effect and thus increases landing distance. Therefore, Orion’s landing distance would be shorter than 2,845 ft (The Pros and Cons of Low Wing vs High Wing Aircraft, 2022).

**Components:** Description of components can be found previously in 2.3.1 Air Vehicle as well as section 3.3.1 Detect and Avoid.

**Table 8: Component List**

Component	Quantity	Component	Quantity
Propeller Blade	10	Main Gear Taxi Cam	1
Landing Gear	3	PICOSAR Radar	3
PT6A-42 Engine	2	Red Strobe Light	3
Floor Latches	8	White Strobe Light	2
Ball Bearing Mat	1	Green Strobe Light	1
LiDARUAV LR	3	Audio Warning	2
CMXHD Cam	4	-	-

**2.3.2 Command, Control, and Communications (C3) Selection**

While automation in aviation is becoming more common, there are still accidents involving an aircraft’s computers that pose a hazard to the aircraft and crew onboard (Automation in Aviation: Humans vs. Computers, 2021). Therefore, it was essential to create a system where trained pilots can constantly monitor the state of the flight.

**Ground Control Station:** GCS of the UAS is the cockpit where pilots operate Orion. Furthermore, it allows the pilots to access exact positional data of Orion and look through the FPV cameras which ensures a safe taxi at the rural airport. The GCS requires a system of computers, technology on the aircraft, and communication and connection software between the UAV and the pilot on the ground within the GCS (Ground Control Station (GCS), 2022). To design the system, the RamJets researched a model GCS that most fixed wing UAV use.

Figure 17: GCS

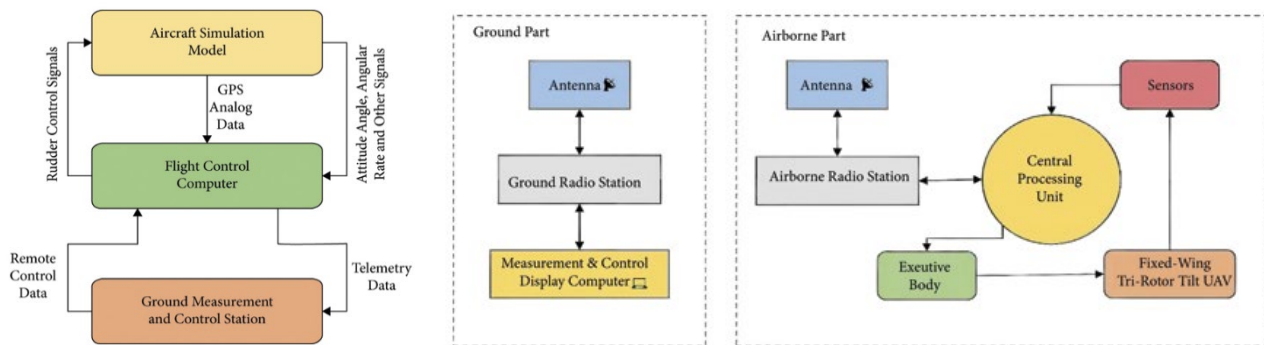

Using this model, the RamJets found specific equipment to best meet this system (Israr, Alkhamash, & Hadjouni, 2021).

**FMU & Autopilot Systems:** The Flight Management Unit (FMU) is a system that acts as Orion’s main “computer”. It guides Orion along its pre-set flight path towards the rural airport, and handles autonomous navigation via various sensors, such as GPS, accelerometers, and airspeed sensors, and barometers. (What Does a Flight Management System (FMS) Do?, n.d.). A FMU also provides precise positional data for pilots to accurately monitor Orion along its flight path. The presence of redundant systems regarding Orion’s positional data is crucial for detecting and avoiding obstacles in the flight path. Further details of redundant systems can be found later in 2.3.2 Command, Control, and Communications (C3) Selection.

As Orion is fully reliant on the FMU to handle autonomous flight and communication between the GCS, it is imperative to include redundant systems that ensure the functionality of the flight controller. The team chose the **Holybro PixHawk 5X** (Holybro Pixhawk 5X, n.d.) as the FMU as it includes an autopilot software system, the PixHawk5X, has redundancy in key components, and multiple inputs for extra sensors. The PixHawk has three power rails providing a triple redundant power system. It has three Inertial Measurement Unit (IMU) sensors and two barometer sensors. Furthermore, multiple input and output interfaces allow for communications

with the GCS such as radio and telemetry, which eliminates the need for a multiplexer on Orion. Obstacle detection sensors will be wired to the sensor inputs to allow the PixHawk 5X to autonomously avoid non-cooperative obstacles. Additionally, the PX4 is an open-ended autopilot software system, which allows the pilot to have direct control over the UAV when necessary (Human-in-the-Loop flight mode).

**Multiplexing/Demultiplexing:** Multiplexing is a method of condensing data into a datum, thus making data easier to send. Demultiplexing is the opposite, where the multiplexed datum is separated. A demultiplexer at the GCS is needed to decompress the datum from the PixHawk, allowing the pilots access to the information on their monitors. The GCS also contains a multiplexer to dispatch commands from the pilots to Orion. Orion needs a demultiplexer to separate the datum sent from the pilots. The team decided to use the **DG406DYZ** as the multiplexer and demultiplexer because of

Figure 18: Multiplexer

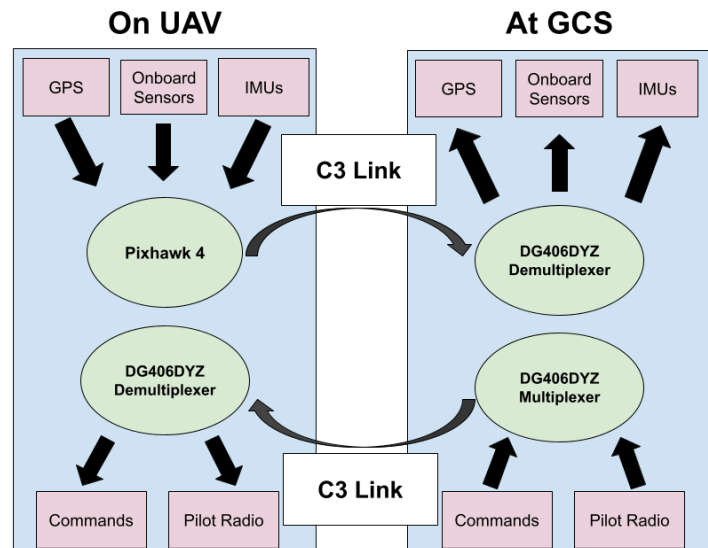

its sixteen outputs, matching the sixteen inputs of the multiplexer in the PixHawk 5X (DG406DYZ, n.d.). The Figure 18: Multiplexer demonstrates how the PixHawk 5X works with the demultiplexer on the ground, and how commands from the pilot are separated in Orion.

**Line Of Sight (LOS) Communications:** Providing video feed, positional data, and sensor data of Orion is crucial to the mission, as the Safety Pilot (SP) requires a forward-facing view of the aircraft for the entire flight profile, and a physical view of the aircraft's surroundings while in transit. As detailed by the FAA in 14 CFR 91.113 (b), each person operating the aircraft must see and avoid other aircraft. Additionally, the pilots need to be able to send commands and information to the aircraft. Thus, a near-instantaneous two-way communications link is needed to perform operations. The RamJets decided to utilize Ground Data Terminals (GDT) and Air Data Terminals (ADT) as the LOS link for pilots to provide the GCS to UAV communications link. Utilizing radio frequency (RF), this system achieves short latency times as compared to Satellite Communications (SATCOM) systems. Two ADTs will be located underneath the airplane, one at the rear, and another at the front, allowing clear links to their respective GDT. The rear ADT faces the GDT at the major airport, and the front ADT faces the

GDT at the rural airport. Through this, a constant communications link is achieved as Orion travels to the rural airport. However, GDTs are unable to cover the full 300 NM of the flight. To resolve this issue, a GDT will be placed at each airport. A Handover Procedure between both terminals is essential to ensure the pilot always has a steady data link with the aircraft. This requires the GDT to have a range greater than the midpoint of the mission, 150 NM. The handover procedure will be discussed in greater detail later in this section.

The **Mantis II GDT** has an operating range of 250 NM, 100 NM more than the midpoint of the flight, allowing the pilot to conduct the handover between the 50 NM and 250 NM points. Having a large handover range ensures the safety pilot has ample time to switch to the GDT located at the rural airport when First-Person View (FPV) camera data from the GDT is shown on the monitor. The system is able to transfer data at up to 40Mbps; enough to transmit video feed, sensor data, telemetry, and more.

The **AT-23 Dual Axis Directional Antenna** was selected as the ADT as it broadcasts at the same frequency as the Mantis II. Attached to the antenna are DC motors and servos, allowing the antenna to turn itself 180 degrees relative to the longitudinal axis. This is crucial in case an antenna fails in broadcasting its signal which the procedure is discussed in 3.3.3 Integration with Manned Aircraft.

**Transceiver:** A transceiver is a radio that sends and receives communications. This is needed to communicate with Air Traffic Control (ATC) and operate within LOS communications. Four viable frequencies were found: High Frequency (HF), Very High Frequency (VHF), Ultra High frequency (UHF), and SATCOM. 95% of ATC communications use VHF. Using this frequency allows the operational pilot (OP) to converse with ATC. Therefore, the pilots will use a transceiver in the VHF spectrum.

To communicate with other aircraft via radio, the UAV and GCS each have their own transceiver, as shown in 3.1.2 Flight to Smaller Airport. The **IC-A220 VHF Air Band Transceiver** was selected for its compatibility with ATC frequency. A transceiver along with a microphone and speaker allow the pilot to communicate with ATC at the major airport. While another transceiver, at the rural airport, will be connected by fiber optics or the internet cloud, demonstrated later in this section; letting the OP communicate with ATC at the rural airport. However, communicating with other aircraft and ATC at the rural airport requires the pilot's message to be multiplexed, therefore, an intercom station is needed to capture the message itself so it may be sent to the multiplexer. The **U3802 Radio Interface Module** was decided upon due to being cost effective, containing a headset jack, and two output systems. The entire

communication process with ATC at the rural airport along with other aircraft is delineated in 3.1.2.

Figure 19: Control Room Layout

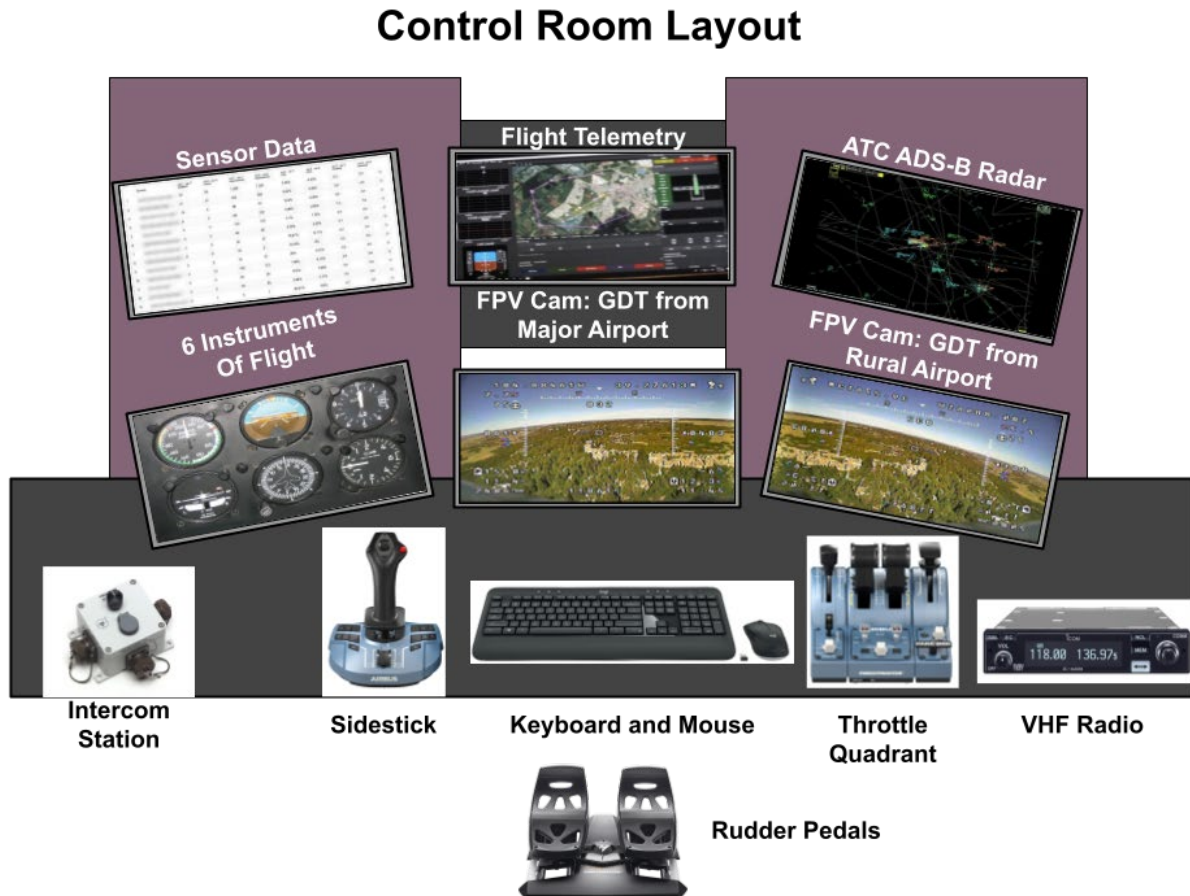

**GCS Layout:** The team researched the structures for GCS among UAV operations and found common design characteristics, leading to a successful design approach. The RamJets determined a total of six monitors would be used: two monitors for real-time video feed from cameras on Orion, one monitor using the link from the GDT at the GCS, and another monitor would display from the GDT at the rural airport. One monitor displays ADS-B radar from ATC; the remaining three monitors display information received from the aircraft, such as telemetry data and fuel status. To perform takeoff and landing, the OP will use an airbus side stick, throttle quadrant, and rudder pedals. Any adjustments to the flight, and changes to secondary control surfaces, will be done via keyboard and mouse. The structure for the monitor layout located at the GCS in the major airport is demonstrated in Figure 19: Control Room Layout.

**Ground Control System:** As described earlier, the entire C3 system is near instantaneous, allowing the pilots to control Orion, communicate with other aircraft, and achieve other operations at rapid speeds. Therefore, a second control room at the rural airport is

unnecessary. By utilizing only one GCS, fixed costs of outfitting two locations with a GCS and personnel costs to have an OP at each location are eliminated, decreasing overall costs. A GDT at the rural airport and communications systems between airports allow the pilots to have data on all aspects of the flight envelope at both airfields. A handover procedure, done by the OP, occurs and transmits data back to the major airport utilizing communication systems described in section 2.3.3 Ground/Support Equipment.

**Communication Between Airports:** The communications link connecting the major airport GCS to the Rural Airport Communication Systems (RACS) is critical as the pilots rely on RACS for data of the UAV at the later point of the flight. Therefore, the RamJets created a triple redundant link by using three different transmission methods, which are:

1. Fiber optics, providing point-to-point communication by transferring information using light rather than electrical signals to transmit data, thus operating at the speed of light (How do fiber-optic cables transmit data?, n.d.). The team decided to use **Global Cloud Xchange**, a company that has an extensive global point-to-point fiber optic network, to gain access to the network by utilizing the private line (Global Cloud Xchange, n.d.).
2. The IP router allows Internet access from an **Internet Service Provider (ISP)** (Modem vs Router: What's the Difference, 2022). By configuring to share the same internet connection, placing an IP router at both airfields creates another mode of connection between the GCS and the rural airport (Sharing Internet between Two Houses, 2022).
3. The third and final method of communication utilizes **wireless broadband** provided by a cell phone provider.

Having three different communication links ensures redundancy and a secure link between both airports.

**Handover Procedure:** At the start of each flight, five of the six monitors present data from the GDT at the major airport. However, as the UAV approaches the rural airport, the communications link with the GDT at the major airport will be lost. Therefore, the pilot needs to determine when a connection has been established with the rural airport. The monitor located at the bottom-right of the control room continuously displays the video feed from the rural airport GDT, even if a connection has not been established. Once a connection has been established and video is presented on that monitor, around the 50 NM point of the flight, the OP changes over the GCS to UAV communication link from the major airport GDT link via the triple-redundant RACS and the rural airport GDT. Therefore, any commands or information that need to be sent to Orion will be transmitted through RACS and the rural airport GDT. This process is



repeated during the return flight, except when the pilot undertakes a handover procedure to display information from the major airport GDT.

The entirety of the Ground Control System is demonstrated in Figure 20: GCS Layout.

Figure 20: GCS Layout

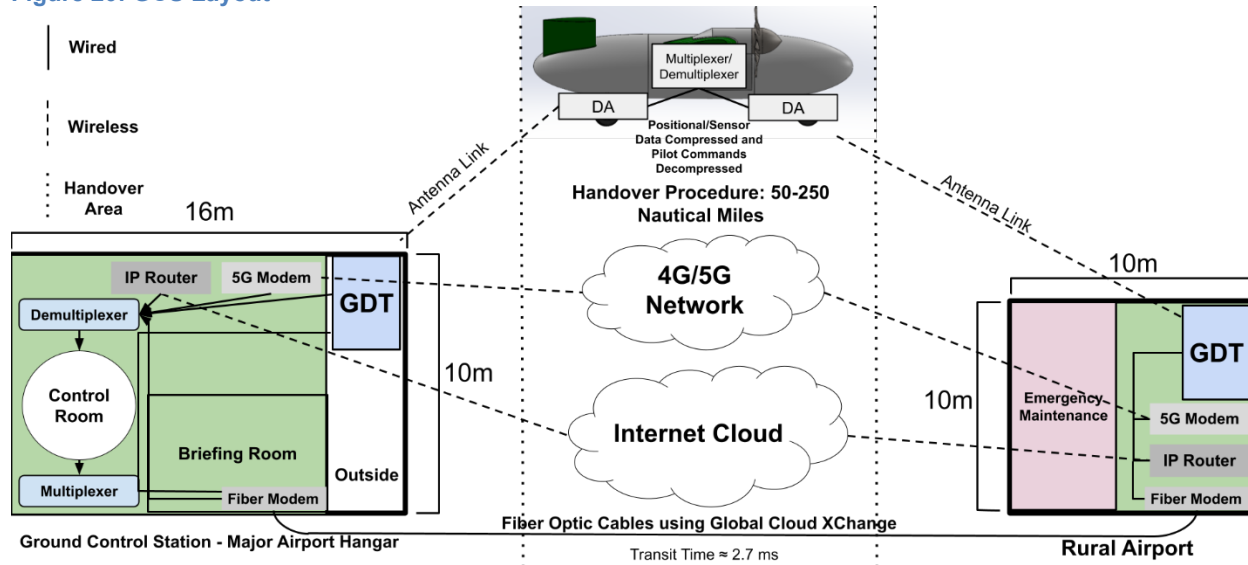

Further detail of the GCS is found in Figure 21: Hangar GCS. Debriefs, which are described in 3.1.4 Post-Mission, take place in the briefing room.

Figure 21: Hangar GCS

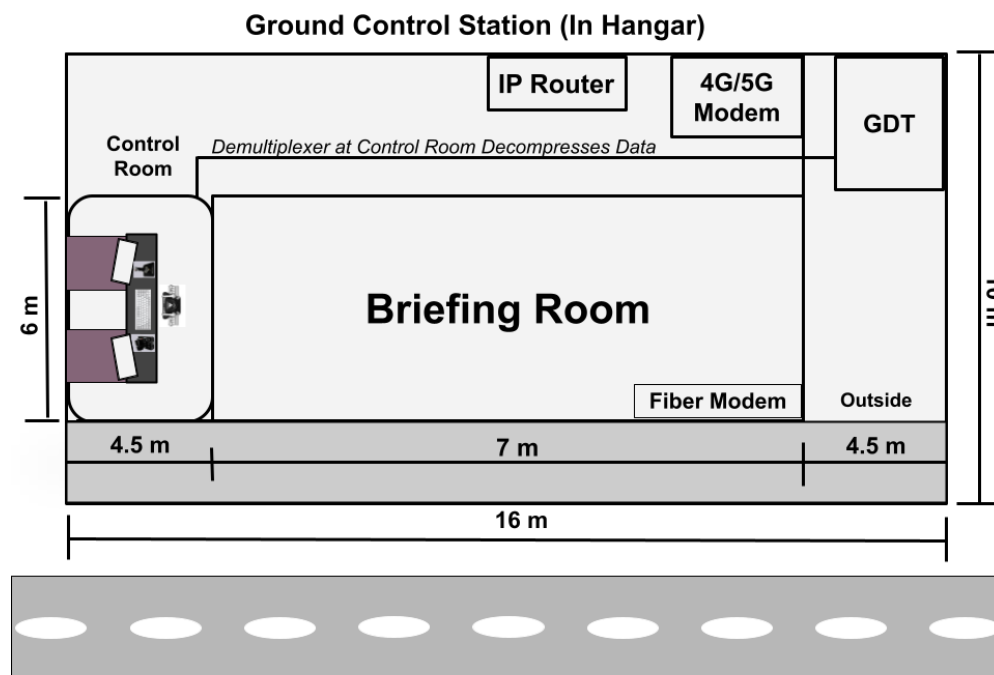

Sensors will be employed throughout the operation primarily detecting obstacles during flight and informing the pilots of the performance of Orion. The team decided to conduct independent research on detection sensors for obstacles and anomalies.

### **Obstacle Detection Sensors**

As the aircraft is flying at approximately 140 m/s, a minimum range requirement of 1.5 kilometers ensures the OP has over 10 seconds to adjust. Furthermore, the field of view (FOV) needs to be greater than 60 degrees to avoid the monopolization of the twelve sensor inputs on the flight controller. The following sensors were researched:

**Sound Navigation and Ranging (SONAR):** SONAR transmits sound waves, and as they bounce off objects and back into the sonar transducer it measures the time for the sound waves to come back from the object and thus calculates the distance. SONAR is primarily used for underwater navigation and ocean exploration. In the air, the speed of sound is much slower than the speed of light and has a larger latency. SONAR would prove dysfunctional at detecting obstacles when flying, and thus, sonar was out of the team's consideration.

**Infrared (IR):** IR sensors use the thermal signature of lifeforms and obstacles, such as planes, to detect their presence (How far can I see?, n.d.). However, there is little information on the market concerning the range of these sensors. Furthermore, they are not compatible with SLAM, a machine learning software detailed in 3.3.1 Detect and Avoid. Thus, the IR sensor was eliminated.

**Light Detection and Ranging (LiDAR):** LiDAR is a remote sensing technology where light from lasers are utilized to acquire the distance from objects by measuring the time it takes for the light to bounce back. Latency is minimal as the sensor receives information at the speed of light. These measurements are then collected as a point cloud and are used to create a 3D representation of the surroundings, creating a smooth integration with SLAM (What is UAV LiDAR?, 2022). Therefore, LiDAR was chosen as a detection sensor on Orion.

**Radio Detection and Ranging (RADAR):** RADAR sends out electromagnetic waves to detect and locate the object's position and velocity. As the wave travels to the object, it reflects back to the radar itself to measure the distance between them. By using electromagnetic waves, the distance is covered at the speed of light. It has a very large range and is compatible with SLAM. As a result, RADAR will be used on the UAV.

**First-Person View (FPV) Camera:** Cameras are crucial to the mission to increase awareness of the aircraft during flight. Moreover, the pilot needs visual awareness after landing to taxi. Thus, an FPV camera is needed on the UAV.

LiDAR, RADAR, and FPV Cameras were to be employed on Orion, 3.3.1 Detect and Avoid delineates the final selection process of these sensors.

### **Performance Sensors**

The pilots must be informed of any anomalies ahead of time to lower the risk of an emergency during the flight. Furthermore, sensors that measure performance ensure the aircraft is not operating beyond its limit and degrading rapidly. These sensors must be digital, as the information is sent through the C3 link to be displayed on monitors for pilots to observe. The following sensors will be utilized on the UAV:

**Tachometer:** A tachometer measures the number of revolutions per minute (RPM) of the engine's crankshaft. By knowing the RPM, the pilots can measure the engine's performance while also being able to safely increase the throttle without overworking the engines. Two tachometers are needed as there are two engines on Orion.

**Oil Level Sensor:** Measures the level of fuel on Orion. Pilots utilize this information to find the amount of fuel left in the flight, especially useful in emergency situations. Furthermore, an oil leak will be detected ahead of time, allowing pilots time to coordinate a solution.

**Temperature Sensor:** Quantifies the temperature of fluids in the aircraft, such as coolant, fuel, and hydraulic fluid. Temperature sensors are necessary to prevent the engines from overheating.

**Fuel and Manifold Pressure Sensor:** Calculates the pressure of fuel and manifolds, a system of pipes that transfers liquid or gas primarily in the engine. The purpose of this sensor is to measure the right amount of fuel to air combination so the engines operate as efficiently as possible. This is important because constant speed propellers are used on Orion. This sensor and the tachometer provides the pilots with insight of the engine power and advises throttle settings.

**Position Sensors:** Orion will employ additional altimeters and digital airspeed sensors to provide further redundancy in the case gyroscopic sensors on the PX4 fail. Position sensors are crucial to the mission because they allow the pilots to track Orion through its flight path and ensure there are no deviations, to which ATC must be communicated on.

Quantity and cost of the performance sensors are detailed below, while obstacle detection sensors will be delineated further in 3.3.1 Detect and Avoid.

**Table 9: Sensors**

Sensor	Qty	Unit cost	Total cost
Mechanical Tachometer	2	\$300	\$600
Oil Level Sensor	1	\$30	\$30
Temperature Sensor	1	\$30	\$30
Fuel and Manifold Pressure Kit	1	\$1,200	\$1200
Digital Altimeter	1	\$300	\$300
Digital AirSpeed Sensor	1	\$50	\$50
Digital Variometer	1	\$50	\$50
Total	8	-	\$2,260

A list of all C3 components is shown below.

**Table 10: GCS Components**

Component	Qty	Cost Per Unit	Total Cost
Pixhawk 5X	1	\$150	\$150
Icom IC-A220 VHF Transceiver	2	\$1300	\$2,600
ICOM IC-A220 Transceiver, Microphone and Speaker Bundle	1	\$1700	\$1,700
U3802 Intercom Station	1	\$300	\$300
Mantis II Ground Data Terminal	2	-	-
AT-23 Directional Antenna	2	-	-
Logitech Keyboard and Mouse	1	\$50	\$50
Sidestick and Throttle Quadrant	1	\$180	\$180
S80UA UHD Monitors	6	\$400	\$2,400
DG406DYX Demultiplexer/Multiplexer	3	\$8	\$24
Internet Service Provider	1	\$55/ Month	\$55/ Month
Global Cloud Xchange Fiber Optic	1	-	-
Total	18		\$7,459

**C3 Personnel Selection:** A list of tasks that must be completed throughout the mission was created to determine the type and number of personnel needed. These tasks are detailed in 3.1 Concept of Operations.

The **Operational Pilot (OP)** is required to monitor Orion’s position, avoid potential hazards, plan flight path for future missions, coordinate with Range Safety/Aircraft Launch & Recovery/Maintenance Personnel (RSALRMs) during pre-flight inspection, and conduct the handover procedure. The OP is required to constantly monitor Orion’s position to avoid potential hazards, and ensure a proactive response is developed in the event of Orion’s autonomous avoidance systems failing (Human-on-the-Loop). Coordination with RSALRMs is detailed in 3.1.1 Pre-Mission, while the handover procedure is detailed in the previous section. If an emergency occurs, the OP will continue controlling Orion, this is further detailed in 3.3.4. A single OP is needed as there is one control station to operate Orion from. The OP works roughly two hours from 0525 to 0725. Preliminary checks are to be done with RSALRMs before the mission and should not take longer than half an hour. The flight has a duration of 55 minutes and additional time will be used for flight planning.

The **Safety Pilot (SP)** serves as the co-pilot of the flight and resides next to the OP. The SP is responsible for assisting the OP in handling communications with ATC and other aircraft using VHF radio, detailed in 3.1.2 Flight to Smaller Airport. Furthermore, they control the warning systems during an emergency. A single SP is needed for two hours to support the OP for the full duration of the flight, including taxiing.

Further discussion of ground support personnel is detailed in 2.3.3 Ground/Support Equipment.

Table 11: C3 Personnel presents the quantity and cost of personnel involved in C3.

**Table 11: C3 Personnel**

C3 Personnel	Qty	Hours	Hourly Wage	Daily Wage
Operational Pilot	1	2	\$35	\$70
Safety Pilot	1	2	\$35	\$70
Total				\$140

### 2.3.3 Ground/Support Equipment

#### Ground Support Personnel Selection:

**Package Handler (PH):** Loads, unloads, and secures the containers. The loading of containers involves placing them onto PDUs in Orion via forklift. Then, a control panel, integrated into the aircraft, controls the PDU, and moves the LD3 containers into designated locations in the aircraft’s cargo hold. Latches and clamps are then used, to further secure the

containers. One PH will be at each airport and take less than an hour to load and unload the containers. (AKE Container LD3, n.d.).

**RSALRM:** Responsible for refueling and inspecting Orion; flight documentation; and completion of pre-mission and post-mission checklists, and risk analysis described in chapter 3: Missions. Two RSALRMs will be located at each airport to decrease time of maintenance, provide an accurate risk analysis, and be able to refuel Orion, as two people are needed to fuel an aircraft (Aircraft Refueling NATOPS Manual, 2014). RSALRMs at the rural airport will not drive to and from the major airport unless major repairs are needed.

The quantity and price of ground personnel is found below.

**Table 12: Ground Personnel**

Ground Personnel	Qty	Hours	Hourly Wage	Daily Wage
RSALRM	4	3	\$35	\$420
Package Handlers	2	1	\$15	\$30
Total	8	-	-	\$450

**Personal Protective Equipment (PPE):** The RamJets initially researched regulations concerning the specific types of PPE needed. For example, OSHA regulation 1910.132 requires certain protective equipment to be provided to employees depending on the work environment. These equipment types are eyewear, footwear, bodywear, headwear, earwear, and handwear. These move onto the preliminary phase to be further evaluated.

The following details the PPE each personnel need to wear based on OSHA’s hazard assessment, airport safety regulations, and ANSI regulations:

All ground personnel will wear RF equipped ear defenders to communicate with each other and to provide hearing protection from the aircraft. They will also need goggles due to the presence of chemicals, such as gasoline, and head protection as being underneath the aircraft increases the risk of being underneath falling objects. Work boots with impact protection are needed as the PH handles heavy objects and the RSALRM works on the aircraft. Class II ANSI safety vests must be worn at all times when outside of the warehouse. Additionally, work gloves will be provided for added grip strength when working with tools and hand protection. With these specifications in mind; eyewear, footwear, bodywear, headwear, earwear, and handwear proceed to the final selection where market research is performed based on safety, comfort, price, and longevity.

The following PPE were chosen:

**Headwear:** Workers use the Pyramex Hard Hat for head protection as it is OSHA-approved by exceeding ANSI Z89.1 (OSHA & ANSI Hard Hat Requirements, n.d.). It has been tested for impact, penetration, flammability, electrical insulation, marking, and humidity. Furthermore, this universal hard hat provides comfort and is compatible with earwear.

**Eyewear:** The eyewear chosen was the DeWalt Concealer because it meets ANSI Z87.1 standards and is impact-resistant. They are anti-fog and anti-scratch, ensuring the worker's vision is clear.

**Earwear:** BJKing's Bluetooth ear defenders were chosen as the mode of communication between workers; it is certified in CE EN352-1, which tests safety and durability (EN 352 Explained - Hearing Protection Standard, 2019), and ANSI S3.19 standards. Wireless ear defenders were chosen to allow personnel to work with both hands while communicating with their coworkers. As Orion may produce around 90 decibels (dB), the NRR 29dB noise reduction allows the workers to always be in an environment of 79dB which is lower than the 85dB limit set by OSHA.

**Handwear:** Workers use DeWalt's heavy utility performance working gloves because of their padded protection and grip support, providing personnel the needed protection to handle cargo and perform maintenance.

**Bodywear:** The GSS 1005/1006 HiVis lime green safety vest meets ANSI standard 107-2015, which is the high visibility standard for safety vests. Being lightweight and breathable, personnel can work in comfort.

**Footwear:** Reebok's Metguard Work Boots are ANSI/ASTM I75 and C75 Approved, and offer impact compression, protection, and are slip-resistant. There are extra PPE to ensure redundancy. The quantity and price of each PPE is found below.

**Table 13: PPE**

Equipment	Quantity	Cost Per Unit	Total Cost
Hard Hats	8	\$10	\$80
Safety Vests	10	\$9	\$90
Safety Goggles	8	\$10	\$80
HardHat Earmuffs	10	\$64	\$640
Work Gloves	10	\$20	\$200
Work Boots	10	\$120	\$1,200
Total	52	-	\$2,232

**Warehouse Safety Design:** As noted by OSHA, PPE should not be the only consideration with worker safety; the work environment itself should be as safe as possible. Therefore, oily waste containers, tool storage, PPE lockers, and safety data sheets were added to the warehouse to create a workplace that is organized and encourages safety. PPE locker placement was considered to further encourage safety. The PPE locker for the PH is located beside the exit, as they

frequently exit and enter the warehouse. The PPE lockers for the RSLARMs are located near the tool chest, first aid, and fire prevention, as they constantly retrieve tools. The warehouse design is detailed in Figure 22: Warehouse Design. Additionally, an emergency power supply will be in the hangar to prevent any electrical outages from hindering the safety of the mission.

**Figure 22: Warehouse Design**

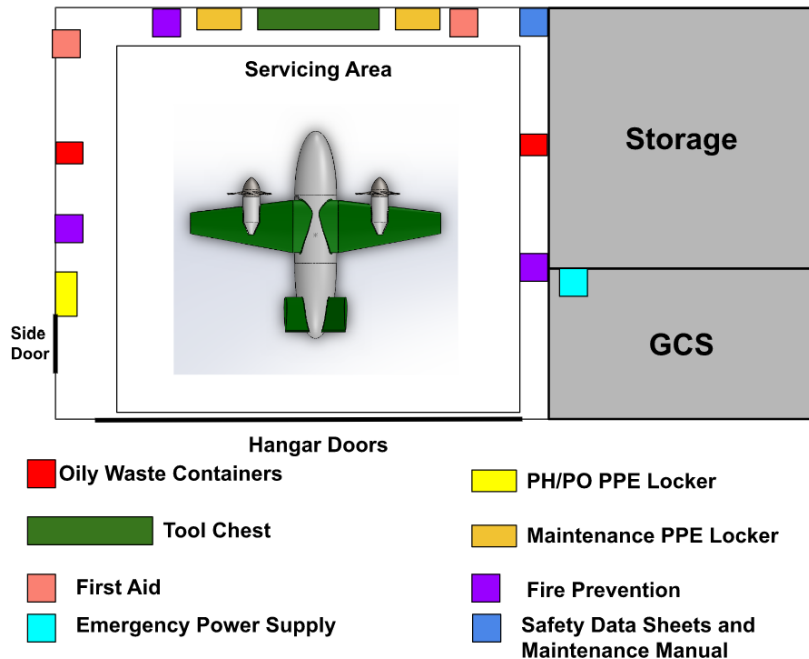

**Servicing and Ground Handling:** A pushback tractor will be utilized to tow Orion into the hangar. Maintenance tools will be found in a container near Orion. If major repairs are required, RSALRMs are able to use bulk CFRP, as detailed in 2.3.1, and spare parts of the plane located in the storage section of the hangar. Fueling Orion, along with tests for fuel contamination (detailed in 3.1.1 Pre-Mission), start an hour before flight. The table below details the quantity and prices of items in the hangar.



Table 14: Hangar Items

Item	Quantity	Cost Per Unit	Total Cost
PPE Locker	4	\$110	\$440
Oily Waste Containers	3	\$80	\$240
Tool Chest	1	\$170	\$170
Fire Extinguishers	3	\$50	\$150
Fire Blankets	3	\$16	\$48
First Aid Kit	2	\$35	\$70
Emergency power supply	1	\$220	\$220
Total	17	-	\$1,338

## 2.4 Lessons Learned

**SMARTER goals:** The RamJets set SMARTER goals to increase efficiency and reduce time. “S” in SMARTER goals stands for specific short-term goals. “M” stands for measurable goals that can be quantified in the notebook’s context. “A” stands for achievable tasks where large assignments are broken into small tasks. “R” stands for relevant, realistic, and resourced tasks meant to impress more weight on certain goals. And “T” stands for time sensitivity when completing tasks. In many scenarios, the team found the importance of time management and that satisfying deadlines was a must. This became more important towards the end of the challenge when the business case was unable to be completed because the final flight characteristics were not finalized. Additionally, models and calculations of the flight characteristics throughout the notebook needed to be updated several times as parts of the plane were edited. Finally, the “E” and “R” are for evaluating and reviewing what has been accomplished and making any necessary improvements. The team reassessed the state notebook submission and outlined improvements that needed to be made.

**Meetings:** The RamJets hosted many meetings throughout the course of this project and saw the significance of organization and proper accountability in completing assigned goals. When the team needed additional time to meet goals, they were able to organize meetings outside of regular attendance. Some of these meetings would take place at outside locations like libraries. Along with normal club meetings, the team also held mentor meetings where the RamJets realized the importance of preparing questions and planning to properly utilize the mentor’s time.

**Engineering Design Process:** The creation of a unique and custom Engineering Design Process in 2.1 as a basis for selecting and creating the UAS allowed the team to work more efficiently on the project. Instead of using an Engineering Design Process from another party that roughly outlines what the challenge calls for, the RamJets created a process that was tailored to their own needs and goals to guide them through System Design. This allowed the efficient creation of Orion.

**Occam's Razor:** Occam's Razor is a concept where the simplest solution is often the best solution (Duignan, n.d.). Many times, throughout the challenge, the RamJets looked for every possible and innovative solution. However, these often cause incredible struggles, consuming large amounts of time, and increasing the difficulty of the challenge. It was only after the team realized that the closest fit to the challenge was not necessarily the most innovative or “the best” design, that the RamJets were able to progress quicker. A notable use of Occam’s Razor is seen in the wing down selection of 2.3.1 Air Vehicle, where a variable swept wing meets all challenge requirements, but is unnecessary due to its complexity.

## 2.5 Component and Complete Flight Vehicle Weight and Balance

**Weight Breakdown:** The empty weight of Orion found in the material breakdown is 6,651.19 lbs (3016.929 kg). With an additional 4,000 lbs for cargo and 820.8 lbs for fuel weight, mentioned in 3.2 Flight Profile Analysis, Orion’s flight weight is 11,471.99 lbs (5052.65 kg). Sensors are properly placed along the aircraft to provide equal weight distribution on each side. The computing devices of Orion weigh 74 grams and have insignificant changes to the CG.

Figure 23: Center of Gravity Models

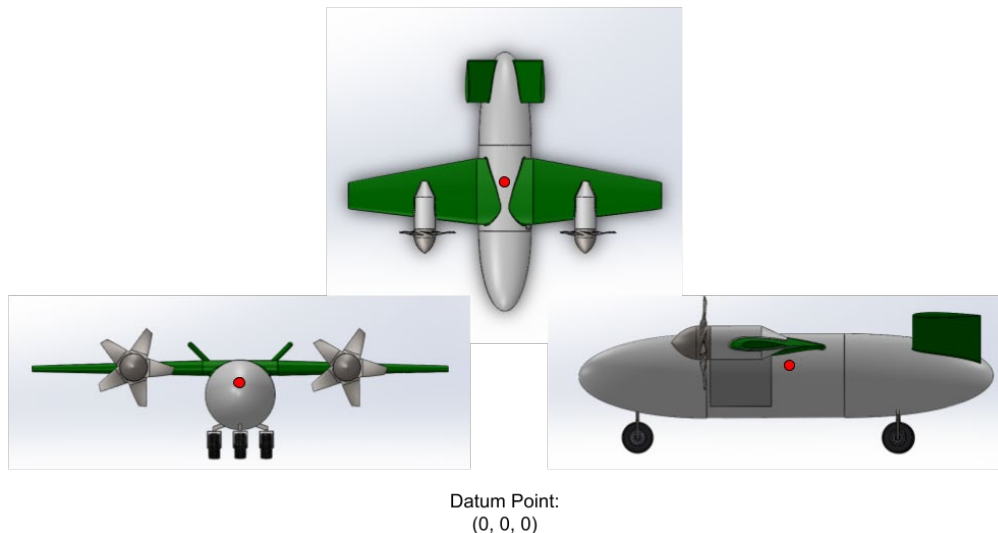

Figure 23: Center of Gravity Models shows the top, front, and side view of Orion along with the CG calculated by SolidWorks. The red circle represents the datum point, the CG without cargo or fuel is located at  $X = 0, Y = 0, Z = 0$ .

**Variability:** Before the team calculated the operational CG, a sense of variability was taken into consideration. When a plane is in flight, the fuel and the cargo needs to remain stationary to not affect the CG. To keep cargo stationary, as mentioned in section 2.3.1 Air Vehicle, Orion features latches and clamps. These methods keep the cargo from moving, and thus keep the CG stationary. The team researched ways in which tanker trucks operate to keep their liquid cargo stationary and found the best solution was internal baffles as seen Figure 24: Truck Internal Baffles. Thus, to decrease fuel variability, Orion features internal baffles in its wings' fuel storage compartments. A sectional view is seen below.

Figure 24: Truck Internal Baffles

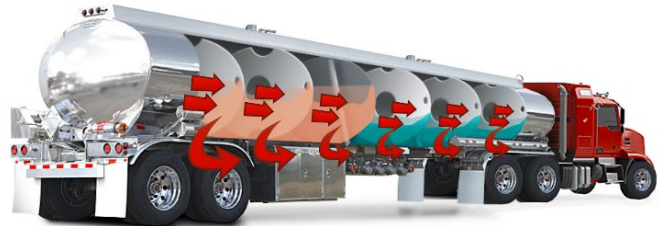
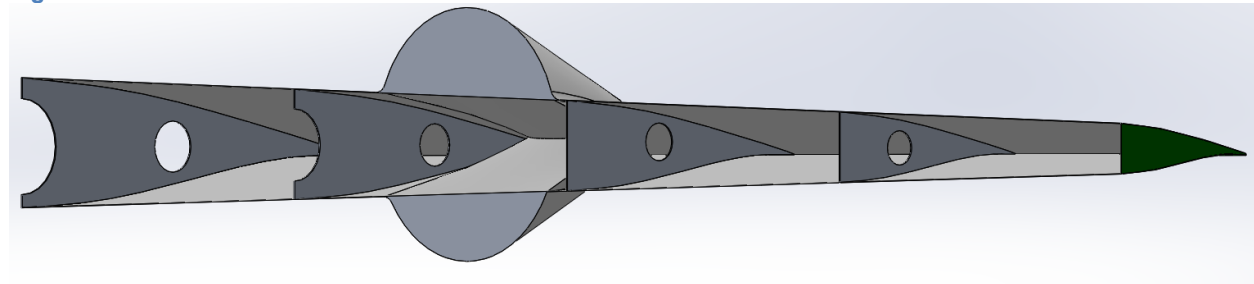

Figure 25: Orion Internal Baffles



**Calculations:** To properly calculate the CG, a calculation on each axis would need to be done. Given the landing gears retract into the plane, they were calculated as such. The diagram follows a standard axis where down and to the left produces negative values, and up and to the right produces positive values. The landing gears are shown for visual purposes only. The calculation for CG is:  $CG = \text{NetMoment}/\text{NetWeight}$

**Table 15: CG x-axis**

Component	Weight (lbs)	Distance from Datum Point (inches - x axis)	Moment
Engine with Propeller (2x)	1,475.720	-99.40	-146,686.568
Nose	248.380	-156.06	-38,762.183
Fuselage (With Cargo)	5,654.314	-5.75	-32,512.306
Empennage	1,388.058	169.69	235,539.579
Wings (With Fuel)	1,887.270	-19.01	-35,877.003
Door	155.270	-50.08	-7,775.922
Landing Gear Front	241.760	-141.13	-34,119.589
Landing Gear Back (2x)	457.770	100.60	46,051.662
<b>Total</b>	<b>11,508.542</b>		<b>-14,142.328</b>

$$CG (x-axis) = NetMoment \div NetWeight = -14,142.328 \div 11,508.542 = -1.229 \text{ inches}$$

**Table 16: CG y-axis**

Component	Weight (lbs)	Distance from Datum Point (inches - y axis)	Moment
Engine with Propeller (2x)	1,475.720	22.57	33,307.000
Nose	248.380	-16.80	-4,172.784
Fuselage (With Cargo)	5,654.314	-16.80	-94,992.475
Empennage	1,388.058	-16.80	-23,319.370
Wings (With Fuel)	1,887.270	22.57	42,595.684
Door	155.270	-16.80	-2,608.536
Landing Gear Front	241.760	-42.51	-10,277.218
Landing Gear Back (2x)	457.770	-42.51	-19,459.802
<b>Total</b>	<b>11,508.542</b>		<b>-78,927.507</b>

$$CG (y-axis) = NetMoment \div NetWeight = -78,927.507 \div 11,508.542 = -6.858 \text{ inches}$$

Figure 26: CG Position

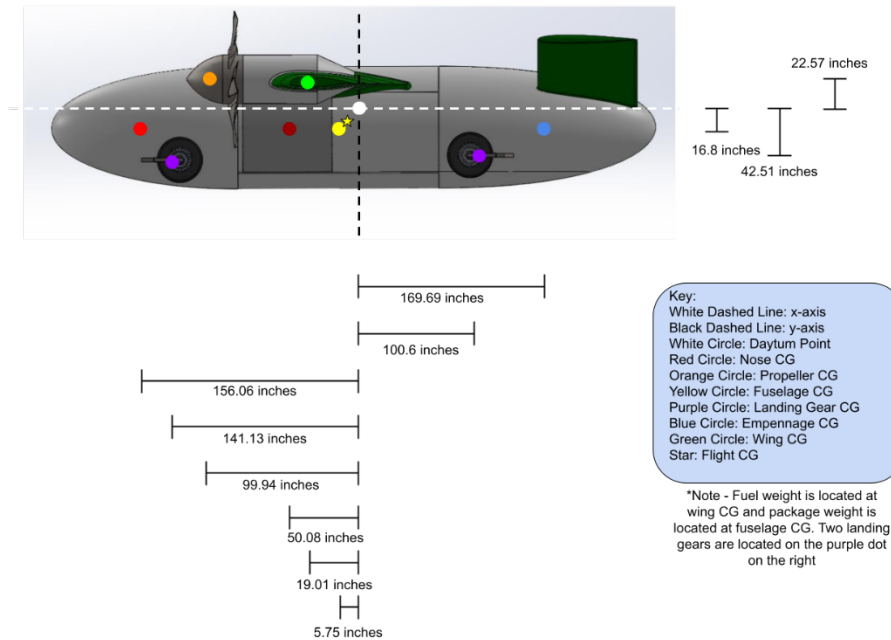

Finally, the z-axis had to be taken into consideration. The only factor that would change the z component of the CG would be the door since everything else would simply cancel out due to symmetry.

Table 17: CG z-axis

Component	Weight (lbs)	Distance from Datum Point (inches - z axis)	Moment
Fuselage (With Cargo)	5,654.314	-2.49	-14,079.242
Door	155.270	43.98	6,828.775
<b>Total</b>	<b>5,809.584</b>		<b>-7,250.467</b>

$$CG (z\text{-axis}) = NetMoment \div NetWeight = -7,250.4676 \div 5,809.584 = -1.248 \text{ inches}$$

Figure 27: CG Front View

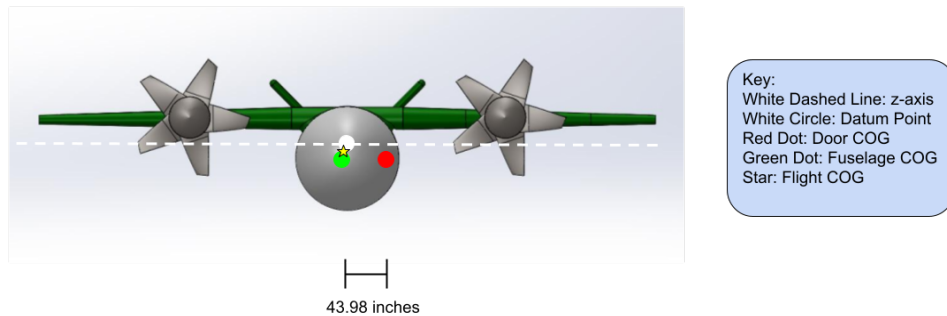

Given all of these calculations, Orion's operational CG is  $X = -1.229$ ,  $Y = -6.858$ ,  $Z = -1.248$ .

## 2.6 Final Design Drawings

The Figure 28: Final Orion Drawings depicts a top, front, and side view along with the isometric view of Orion along with dimensions all in inches.

Figure 28: Final Orion Drawings

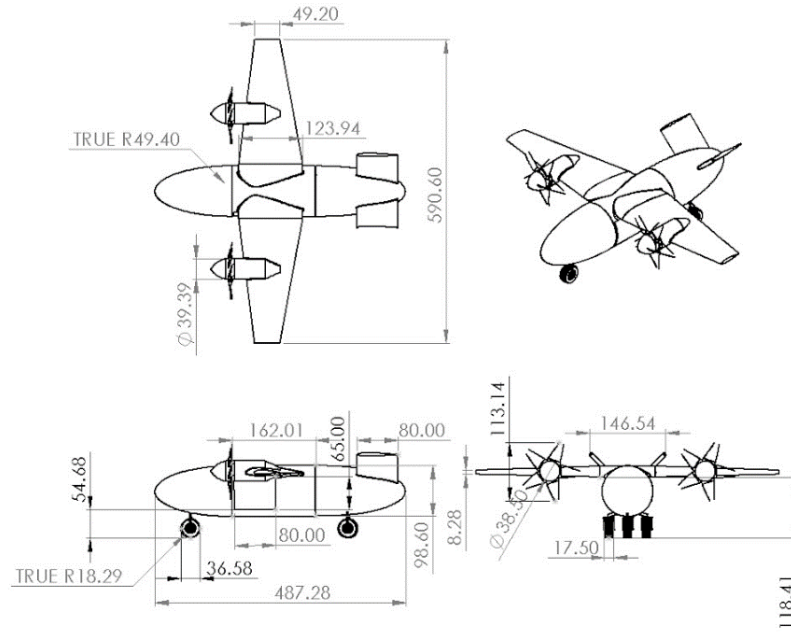

Given the dimensions above, the forklift required to load the LD3's is capable of fitting under the wing with room to raise and lower the cargo. Orion's height from the ground to the bottom most point of the wing is 118.41 inches, and the standard height of a lowered forklift capable of loading the weight requirement is 110-115 inches (Forklift Dimensions: What Size Do You Need?, 2023). The bottom of the door is 54.68 inches off the ground, thus, a forklift with a lowered height would be able to load the LD3s. The required LD3-AKN has a height of 64 inches and a length of 79 inches (LD3 AKE Dimensional Drawings, n.d.). Orion's door provides a 65 inch by 80 inch opening, allowing the LD3 room to be placed within the fuselage. Given the LD3-AKN already utilizes a palletized base, no extra room for the forklift forks is required.

# 3. Missions

## 3.1 Concept of Operations

### 3.1.1 Pre-Mission

**Flight Planning and Path Confirmation:** The OP sends the flight plan to ATC ten days in advance to allow the ATM time for confirmation. At 0500 hours, RSALRMs use programs and notices to check for any restrictions in the flight path. Notice to Air Missions (NOTAMS), contain information concerning flight operations of other aircraft found on the ForeFlight app. Foreflight utilizes geofencing, which creates virtual boundaries in a 3D map. In case an obstacle is obstructing the flight path of the UAV, the OP applies the boundaries by adjusting the flight path of the PixHawk 5X and communicating the change to ATC. During this time period, the ForeFlight app is used by the OP to employ NOTAMS and alert on weather conditions. The OP should not take more than 15 minutes to complete the flight path confirmation.

**LD3 Loading and Pre-Day Inspection:** To minimize personnel costs and time, a pre-mission schedule was created for ground personnel. At 0400 hours, the prepackaged LD3 containers arrive at the airport to be transported by Orion. The usage of LD3-AKN is required because of the increase of forklift

Figure 29: Pre-Day Checklist

- | Pre-Day Checklist        |  |
|--------------------------|--|
| <input type="checkbox"/> | NOTAM Check                                      |
| <input type="checkbox"/> | No Visible Aircraft Damage                       |
| <input type="checkbox"/> | No Visible Engine Damage                         |
| <input type="checkbox"/> | No Visible Fuel System Damage                    |
| <input type="checkbox"/> | Load fuel  |
| <input type="checkbox"/> | <input type="checkbox"/> Check for Contamination |
| <input type="checkbox"/> | Accuracy of Sensor Data                          |
| <input type="checkbox"/> | Monitor Connection                               |
| <input type="checkbox"/> | Emergency systems                                |
| <input type="checkbox"/> | Weather Check                                    |
| <input type="checkbox"/> | Flight Path Confirmation                         |
| <input type="checkbox"/> | Risk Analysis Assessment                         |
| <input type="checkbox"/> | Ground Data Terminal Connection                  |
| <input type="checkbox"/> | Air Data Terminal Sturdiness                     |

Figure 31: Truck Unloading



capabilities because of the palletized design. The team decided to create a loading dock section where the vehicles transporting the containers will arrive. They are palletized so a forklift may collect them from the truck and transfer them to the aircraft. As mentioned in 2.3.1 Air Vehicle, the containers are loaded through the side of Orion under the left wing. RSALRMs start the Pre-Day inspection at 0515 hours and notify the OP upon completion by 0545 hours to allow enough time to power the aircraft and handle ATC communications. If an issue is found that may harm the safety of the mission, the RSALRMs are to discuss with the pilots and conclude if the mission may proceed or if repairs need to be done. If repairs are

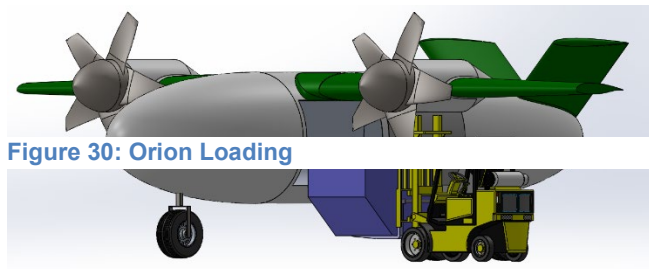

Figure 30: Orion Loading

deemed necessary, the mission may be delayed or canceled for the day until Orion is safe to fly again. The checklist RSALRMs use is detailed in Figure 29: Pre-Day Checklist. At 0545 hours, after Orion is cleared for operation by RSALRMs, the PH will use a forklift to load the LD3s. Then, PDUs controlled by a panel in the aircraft put the containers in position. Final checks of the package’s security to the aircraft are completed by the PH.

Then, at 0600 hours, Orion is to take off to provide ample time for a possible emergency return flight.

Additionally, no hazardous materials, nor pressurized containers are allowed to be transferred to Orion. The aircraft isn’t pressurized, thus said products are a liability because they could potentially explode as the aircraft climbs in altitude (Transportation of Hazardous Materials, n.d.).

### 3.1.2 Flight to Smaller Airport

**Takeoff:** A request for taxi is sent to ATC, to which the OP starts the taxi once given permission. After taxiing and permission for takeoff has been given, the OP performs the takeoff and engages the PixHawk 5X autopilot system a few seconds later, to which ATC is made aware the aircraft is autonomous. The C3 link, involving the GDT at both airports and communication links to the GCS at the major airport, ensure the OP and SP can constantly monitor the state of the flight. The PixHawk 5X remains in control of Orion through transit flight with the Human-on-the-Loop and follows the flight path; procedures to handle any obstacles encountered are detailed in 3.3.1 Detect and Avoid.

Figure 32: Communication with other Aircraft

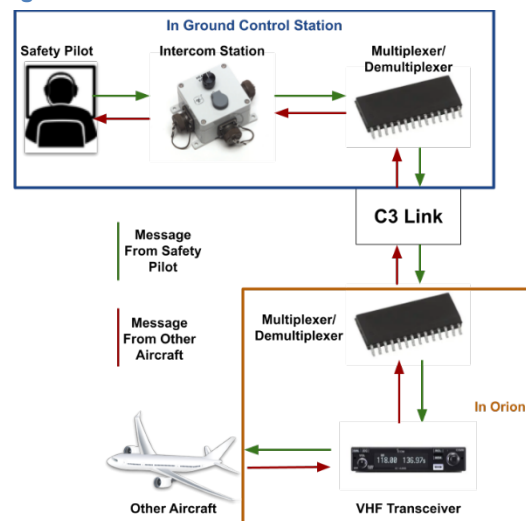

#### Communicating with Other Aircraft: The

SP needs to always communicate with other aircraft during the flight to aid in collision avoidance. A VHF transceiver on Orion and an intercom station on the GCS are employed to accomplish this task. The process is denoted in Figure 32: Communication with other Aircraft. C3 links are near-instantaneous, as detailed in 2.3.2 Command, Control, and Communications (C3) Selection, so the SP can receive a response from other aircraft in the same amount of time as a manned aircraft. Furthermore, using an ADS-B in transponder, Orion receives the location of aircraft in its vicinity, and through ADS-B out, sends information of its location to nearby aircraft.



**Communicating with ATC:** A VHF transceiver, microphone, and speaker will be provided to the SP to communicate with the nearby ATC tower at the major airport. However, the VHF transceiver cannot broadcast 300 NM to the rural airport ATC. There are no pilots at the rural airport, so the systems required for communicating with ATC at the smaller airport are different than communication at the major airport. The process is very similar to communicating with other aircraft, except the fiber optics, 4/5G Network, or internet cloud are used to send the information to the demultiplexer at the rural airport. Then it is sent to the VHF transceiver at the rural airport, which broadcasts the SP's message to ATC. The message from ATC is returned to the SP utilizing the same systems.

**Controlling the Aircraft:** In a manned aircraft, the pilots can directly control the aircraft and look at flight data. However, a connection is required to operate the aircraft when the pilots are remote. This connection must be two-way, where Orion receives commands from the OP and the pilots are able to obtain flight data from the UAV. Similar to communicating with ATC and other aircraft, the command sent from the pilot is inputted into a multiplexer to transmit to Orion via the C3 link. The information is demultiplexed by the FMU, the PixHawk 5X. The PixHawk 5X applies the commands to the aircraft's control surfaces. The pilots are able to check whether the instruction was made to the aircraft through the FPV camera, telemetry data, and instruments of flight on the monitors.

**Flight Characteristics:** Reaching cruise altitude is prioritized as the aircraft will be most fuel efficient, decreasing the total fuel cost of the mission. Therefore, the aircraft maintains a relatively steep vertical speed of approximately 2000 ft/min. However, as altitude increases and the air thins, the UAV shifts its ascent, and maintains a more level vertical speed. This is due to the fact that the engine receives less air, and thus decreases engine power. After 10 minutes, the UAV would reach a cruise altitude of 20,000 ft. During cruise altitude, the lift produced by the wing is enough to counteract gravity as it flies. All statistics regarding the ascent, cruise, and descent are given in Table 18: Flight Characteristics. Additionally, Figure 33: Flight Characteristics details the different phases of flight and exact vertical speed.

Table 18: Flight Characteristics

	Fuel Burn (lbs)	Time (minutes)	Speed (mph)	Distance (NM)
<b>Ascent</b>	85	10	360	60
<b>Cruise</b>	95.4	29.46	375	160
<b>Descent</b>	55	14.55	380	80
<b>Total</b>	472	55	-	300

Figure 33: Flight Characteristics

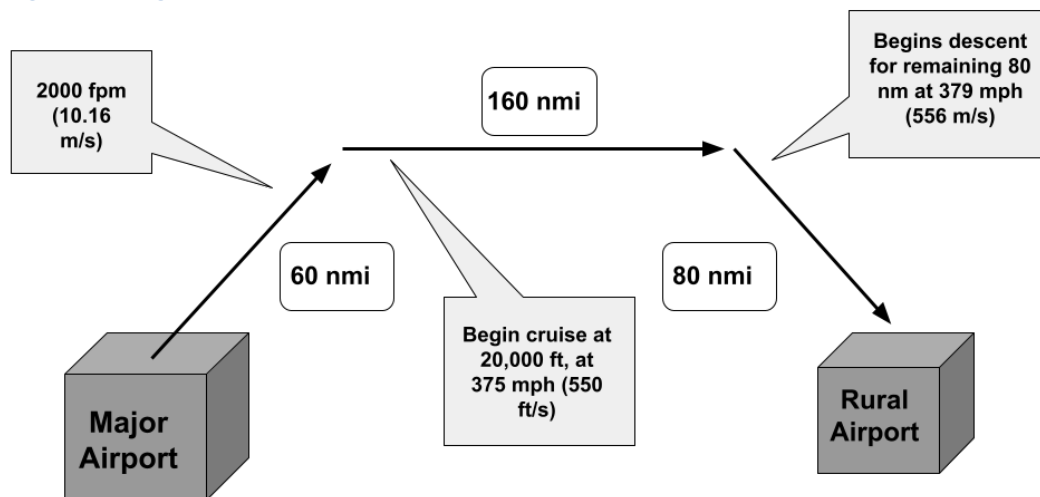

### 3.1.3 Arrival at Smaller Airport

**Descent:** Prior to entering Class D airspace, the OP must communicate with ATC to be cleared to land. If authorization is not received to land at the rural airport, the OP deviates from entering Class D airspace and the aircraft is put in a holding pattern at the current altitude until authorization has been given. When proper clearance and permission to land is given, the SP checks the landing gears and other control surfaces of Orion from the **MEGGITT Ground Maneuvering Camera**, then the OP manually lands the aircraft. This camera is used to help taxis off the runway.

**Flight Characteristics:** As the UAV uses a large amount of fuel while climbing to cruising altitude, the aircraft employs a slow descent across an 80 NM span towards the rural airport. This allows the aircraft to increase airspeed slightly without increasing fuel consumption. More details of the fuel consumption across the entire flight are detailed in 3.1.2 Flight to Smaller Airport.

### 3.1.4 Post-Mission

**Rural Airport Operations:** At 0655 hours, once the UAV is at the designated area, the OP shuts the engines and blinks the strobe lights to indicate to surrounding personnel the

Figure 34: Post Mission Checklist

Post Mission Checklist	
<input type="checkbox"/>	Damage to brakes
<input type="checkbox"/>	Check Hydraulic fluids
<input type="checkbox"/>	Check fuel levels
<input type="checkbox"/>	Damage to landing gears
<input type="checkbox"/>	Damage to FPV Camera and Gimbal Mount
<input type="checkbox"/>	Clean Camera Lens
<input type="checkbox"/>	Engine damage
<input type="checkbox"/>	Emergency systems working
<input type="checkbox"/>	Damage to PDU

aircraft is unpowered and safe to be around. The PH uses PDUs and a forklift to bring the LD3s out of the aircraft and to the appointed drop-off location at the rural airport. The RSALRMs then follow the checklist in Figure 34: Post Mission Checklist and, upon completion at 0725 hours, notify the OP and the PH.

Although not in the challenge, the Orion will be more than capable of conducting the return flight.

**Maintenance at Rural Airport:** If the RSALRMs at the rural airport notice any damage to the UAV while completing the checklist, they are to report to ATC, to personnel at the major airport. If the specialist determines the damage is not severe enough to prevent a flight back to the major airport, Orion returns to the base where repairs will be made. If deemed necessary, new parts for Orion may be transported from the hangar at the major airport to the minor airport. These parts will be installed on Orion by

Figure 35: Flight Documentation

Flight Documentation:	
<input type="checkbox"/>	Total Flight: __hrs __mins
<input type="checkbox"/>	Outbound Flight: __hrs __mins
<input type="checkbox"/>	Return Flight: __hrs __mins
<input type="checkbox"/>	Start of Flight: _____
<input type="checkbox"/>	Arrival at Rural Airport: _____
<input type="checkbox"/>	Arrival at Major Airport: _____
<input type="checkbox"/>	Anomalies During Flight: _____
<input type="checkbox"/>	Date of Flight: _____

RSALRMs. If repairs are in the length of days, the other two RSALRMs at the major airport will travel to the smaller airport to assist, this travel time will take around seven hours. While the challenge does not consider return flight characteristics, Orion can complete the return flight. If the RSALRMs at the rural airport notice any damage to the UAV while completing the checklist, they are to report to ATC, to personnel at the major airport. If the specialist determines the damage is not severe enough to prevent a flight back to the major airport, Orion returns to the base where repairs will be made. If deemed necessary, new parts for Orion may be transported from the hangar at the major airport to the minor airport. These parts will be installed on Orion by RSALRMs. If repairs are in the length of days, the other two RSALRMs at the major airport will travel to the smaller airport to assist, this travel time will take around seven hours. While the challenge does not consider return flight characteristics, Orion can complete the return flight.

**Mission Debrief:** To ensure smooth conductivity of operations and aircraft performance, a mission debrief will take place at the end of each mission, that is after Orion has returned to

Figure 36: Mission Debrief

Mission Debrief Discussion:	
<input type="checkbox"/>	Review Any Obstacles Encountered and Procedures Taken
<input type="checkbox"/>	Review Communication Throughout the Flight
<input type="checkbox"/>	Review Mission Roles
<input type="checkbox"/>	Review Safety of the Flight
<input type="checkbox"/>	Review Checklists
<input type="checkbox"/>	<input type="checkbox"/> Additions to Checklist
<input type="checkbox"/>	Review Anomalies Throughout Flight

the major airport. The debrief will be held at 0700 hours by all personnel at the major airport in the GCS after the aircraft has landed. As the two RSALRMs at the smaller airport are unable to physically attend the debrief, they are to join through an online meeting and send the completed post-mission checklist to the OP. Figure 36: Mission Debrief delineates the topics of discussion.

In addition, documentation of each flight, found in Figure 35: Flight Documentation, must be done during the debrief.

**Routine Maintenance Checks:** Performed in the hangar every 400 flight hours, Orion will undergo checks like A and B checks. RSALRMs will perform these checks and will use the checklist in Figure 37: Routine Maintenance Checklist to guide their inspection.

Figure 37: Routine Maintenance Checklist

Routine Maintenance Checklist	
<input type="checkbox"/>	Damage to Interior of Aircraft
<input type="checkbox"/>	Lubrication
<input type="checkbox"/>	Landing Gears
<input type="checkbox"/>	Nose Gears
<input type="checkbox"/>	Detailed Inspection of Engines
<input type="checkbox"/>	Check for Corrosions
<input type="checkbox"/>	Replace Camera Mount and Sensors if Loose
<input type="checkbox"/>	Detailed Inspection of Wings

### 3.2 Flight Profile Analysis

In Section 2.5 Component and Complete Flight Vehicle Weight and Balance, the gross weight was calculated to be 11,508.5421lbs, which includes the weight of the required cargo. With a wing area of 27 m<sup>2</sup>, the aircraft is able to maintain a lift force greater than gravity, as mentioned in 2.3.1 Air Vehicle. In sections 3.1.2 Flight to Smaller Airport and 3.1.3 Arrival at Smaller Airport, the net fuel burn was found to be approximately 472 lbs.

Figure 38: Fuel Storage

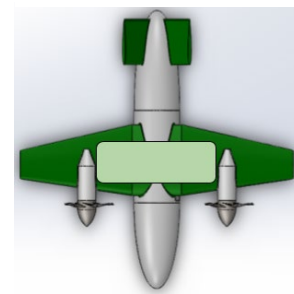

Since one gallon of jet fuel A weighs 6.75lbs, this is approximately 78.7 gallons of fuel. Due to the challenge statement requiring the aircraft to have 45 minutes of extra fuel, the aircraft will need an additional 396.3lbs or 58.7 gallons of fuel in reserve. Additionally, taxiing takes a total of 15 minutes (Weiner, 2022). With a fuel burn approximately 10% of normal operation (Which Part of a Flight Uses the Most Fuel?, 2022), an additional 13.2lbs or 1.96 gallons of fuel is required. The net fuel stored on Orion for a full flight is approximately 881.5lbs or 130.6 gallons or 17.5 cubic ft, which is far less than the interior volume of the wings. Fuel may be stored in the wings without affecting the CG due to the internal structure, as shown in Figure 38: Fuel Storage. Section 2.3.1 Air Vehicle details the calculations that prove Orion can land within the required 3000ft.

Table 19: Fuel Consumption

	Fuel Consumed (lbs)
Taxi	13.2
Flight	472
Reserve	396.3
Total	881.5

### 3.3. Safety Requirements

#### 3.3.1 Detect and Avoid

**Cooperative Obstacles:** Cooperative Obstacles are aircraft in the vicinity of the UAV who are in direct communication with ATC. The UAV needs to detect other

aircraft and determine their exact position to accurately avoid them. Furthermore, a warning system to the OP is required to ensure the UAV is adjusting accordingly. Thus, it was determined that the aircraft would have a Traffic Collision Avoidance System (TCAS).

**TCAS System:** TCAS avoids collisions in the air by one aircraft dispatching interrogations to another aircraft's transponder. There are two types of TCAS:

**TCAS I:** Alerts pilot of a possible air-to-air collision.

**TCAS II:** Alerts pilot of possible air-to-air collision and provides steps on how to avoid collision.

The PX4 autopilot system is unable to determine how Orion should maneuver away from obstacles. Therefore, for Orion to operate autonomously, TCAS II, through the use of an ADS-B In transponder, was used to detect and avoid cooperative obstacles using instructions given by the system. The Garmin TCAS II system was the most viable solution as it is able to issue warnings to the OP and UAV by itself. The system has three components:

The **GTS 8000** uses the aircraft's range, bearing, relative altitude, and closure rate to plot each target's location, and predict potential traffic conflicts while displaying the information to the OP; it is the computer of the TCAS system.

The **GRA 5500** is a radar altimeter that is accurate enough to be integrated in a TCAS II system. Though IMU's are onboard, an extra altimeter provides redundancy and is already integrated. Patented technology allows for a simpler installation and eliminates the need for large lengths of antenna cabling seen in analog altimeters. Additionally, it can operate without interaction from the OP.

The **GTX 3000** is an ADS-B Transponder. This transponder communicates and receives information about an aircraft's location and altitude using GPS (Automatic Dependent Surveillance - Broadcast (ADS-B), n.d.). The FAA mandates Mode S on aircraft flying above 18,000 feet and Mode C within 26 NM of a Class B airport. The GTX 3000 is able to interrogate in Modes C and S, removing the need of having an additional transponder on the aircraft. A 1090MHz extended squitter, mandated by the FAA in section § 91.227 for aircraft flying above 18,000 ft, transmits Orion's telemetry and flight characteristics directly to ATC once per second. An ADS-B transponder detects other aircraft up to 250 NM away, allowing time for the pilots to coordinate the avoidance.

**Avoidance:** If an aircraft and the UAV were to be in close contact with one another, the onboard anti-collision system, TCAS II, would collect the data from the ADS-B transponder, and provide a solution. A confirmation would be sent to the OP through the near-instantaneous C3

link, where the OP uses their own judgment and guidance from ATC to determine whether or not the solution TCAS presented is the safest.

Furthermore, the SP will communicate with the other aircraft to determine which aircraft will perform the adjustment or if both need to maneuver. TCAS systems are able to communicate with each other, therefore, if the other aircraft cannot communicate through radio but has a TCAS system, they will be notified by Orion’s TCAS which direction Orion is adjusting. If the OP determines the maneuver is best, they will accept the solution on the monitor and the information would be sent to the aircraft via near-instantaneous C3 link, where the PX4 on Orion performs the steer. If the OP does not approve of the solution they must adjust the aircraft accordingly using flight telemetry, sensors, and ADS-B-In data.

Figure 39: Cooperative Obstacles Decision Making denotes the decision-making process for avoiding cooperative obstacles:

Figure 39: Cooperative Obstacles Decision Making

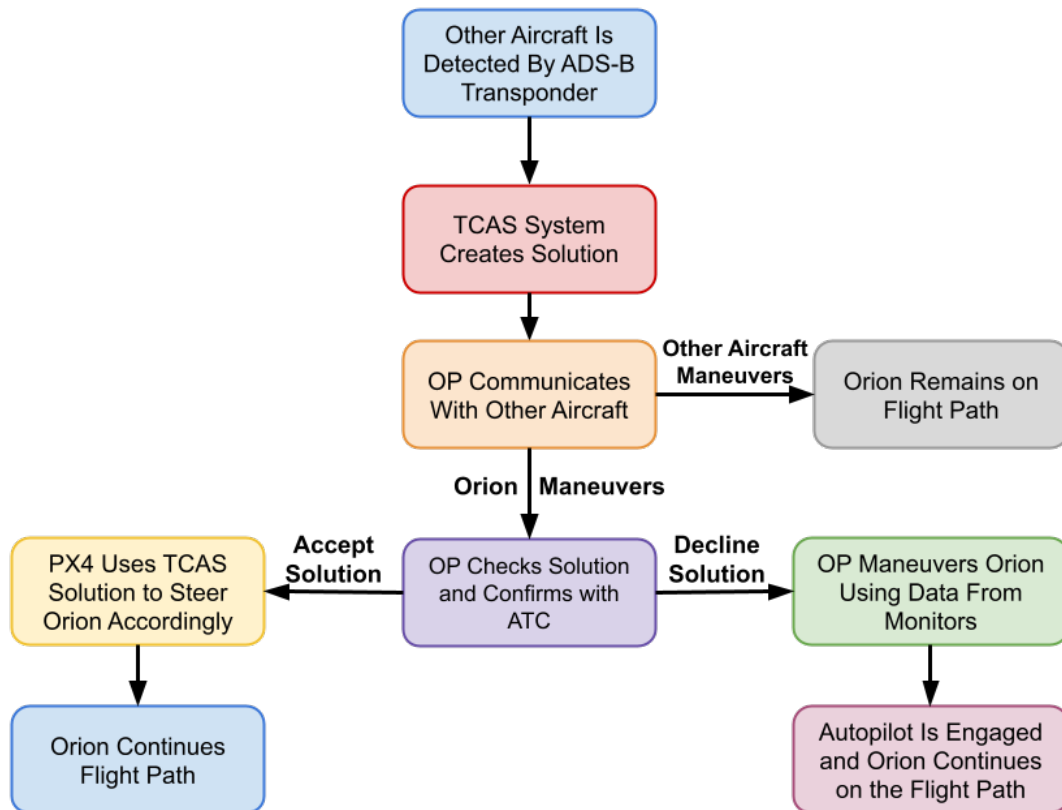

**Non-Cooperative Obstacles:** Non-cooperative obstacles are any obstacles that the ATM or the OP of the UAV cannot communicate with. The aircraft must be able to detect these obstacles from an ample distance, and the UAV must have 360-degree awareness to avoid any possible collision.

**Machine Learning:** SLAM constructs a real-time 3-D map of an unknown environment while at the same time, continuously locating the position of the UAV within it. This data is displayed to the OP to ensure they are aware of non-cooperative obstacles surrounding the aircraft. SLAM utilizes sensors, the range of these sensors will correspond to the range of the map SLAM creates. Additionally, any maneuvers to avoid an obstacle in the flight are remembered. Although the flight controller performs the adjustment, information from SLAM is applied if the same obstacle is in the flight path. Utilizing machine learning provides Orion with a detailed awareness of its surroundings and an additional avoidance feature.

**Sensor Selection:** In 2.3.2, it was found LiDAR, RADAR, and FPV Cameras were most applicable to the challenge. The following sensors were selected:

The **LiDARUAV LR** is a LiDAR sensor with a maximum range of 1.5 km, giving the OP over 10 seconds to perform risk mitigation and either accept the autopilot system or steer the UAV safely. A high point density of 600,000 pts/sec and an integrated image sensor data system enables development of highly detailed maps to input into SLAM. Furthermore, it has a horizontal FOV of 70° and a vertical FOV of 40°, large enough to provide 360-degree awareness. Five of these sensors will be located around the UAV to provide maximal coverage.

The **CMXHD FPV Camera** is lodged into the UAV to improve the sturdiness of the camera. A relatively large horizontal FOV of 88° and vertical FOV of 57° indicates four cameras are necessary to provide nearly all-around video coverage. Furthermore, the 1080p HD video quality ensures the OP has a clear view of the surroundings.

The **PICOSAR Radar** is a radar system that includes an antenna and processor. It has a range of around ten nautical miles while only weighing ten kilograms and using 300W of power. Additionally, the use of many transceiver modules on the fixed-array antenna provides redundancy in the case of failure of one or more transceivers. The team recognizes

Figure 40: Obstacle Avoidance Procedure

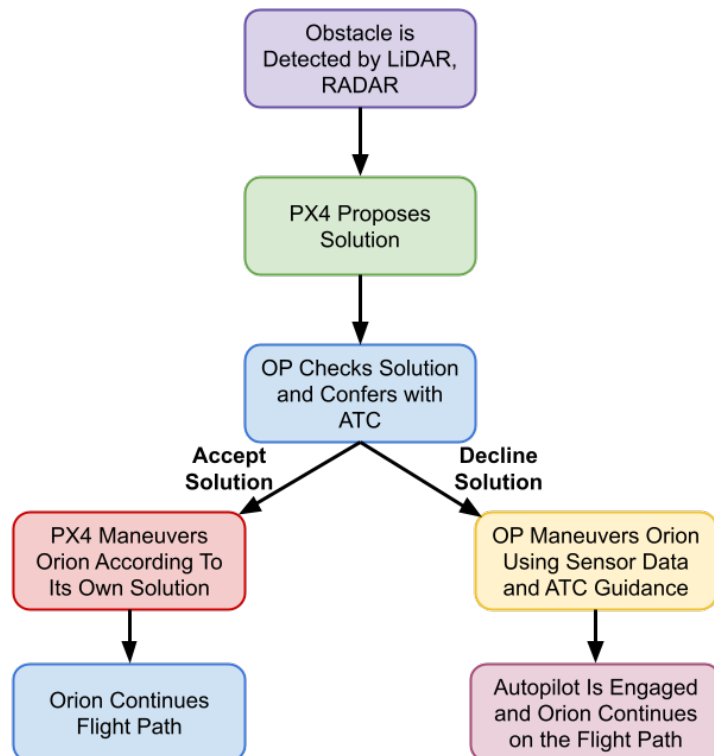

there are larger radar sensors out on the market with larger ranges, but extra range is not necessary due to its large mass. Utilizing this radar sensor, the OP will already have approximately 140 seconds to avoid a collision.

**Avoidance:** The sensors will send the data to the PixHawk 5X, where if an obstacle is detected it will propose a solution. Like TCAS, this solution will be approved by the OP by sending it through the C3 link. When the OP sees the solution on the monitors, they will have already been alerted that an obstacle is in Orion’s flight path from the sensor data. If the OP approves, the PixHawk 5X will perform the adjustment. If not, the OP will use sensor data and ATC information to find the best solution and maneuver accordingly.

Figure 40: Obstacle Avoidance Procedure demonstrates the avoidance procedure.

**Lights:** Without any lights installed, the UAV is a hazard anywhere it flies, as visibility is necessary to fly safely. A red light is placed on the left wing and a green light on the right wing to assist the pilot in determining the orientation of the aircraft. Beacon lights, and taxi lights (14 CFR 91.209) were installed on the aircraft to show the aircraft is operational and to help the pilot steer the aircraft during taxi.

Figure 41: Lights demonstrates the location of the lights on the UAV.

Figure 41: Lights

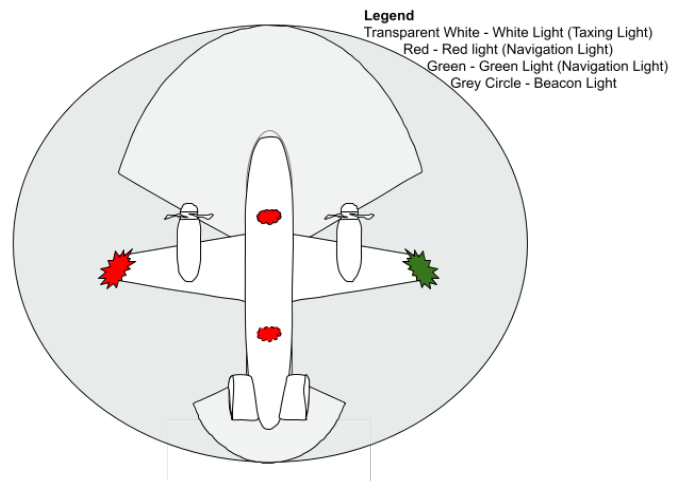

The quantity of sensors selected is shown in Table 20: Sensor Components.

Table 20: Sensor Components

Component	Quantity
LiDARUAV LR	3
CMXHD Cam	3
PICOSAR Radar	3
Strobe Light System	6
Audio Warning System	2

**Sensor Placement:** The placement of sensors is crucial for their efficiency and durability. Creating a 360-FOV allows the UAV to detect all obstacles in its surroundings. Figure 42: Sensor Ranges and FOV details the ranges and FOV of each sensor on the UAV.



### 3.3.2 Lost Link Protocol

#### Rural Airport

#### Communication Systems

**Failure:** Orion and the GCS can lose signals in many ways during the mission. Therefore, the Ramjets designed protocols upon signal loss. Figure 43: Rural Airport Communication Failure Procedures demonstrates these protocols.

As noted in 2.3.2 Command,

Control, and Communications (C3) Selection, after the handover procedure occurs, Orion transfers data to the GDT at the rural airport; fiber optic cables, internet networks, and 4/5G networks create three communication pathways to the GCS at the major airport. The OP knows

Figure 43: Rural Airport Communication Failure Procedures

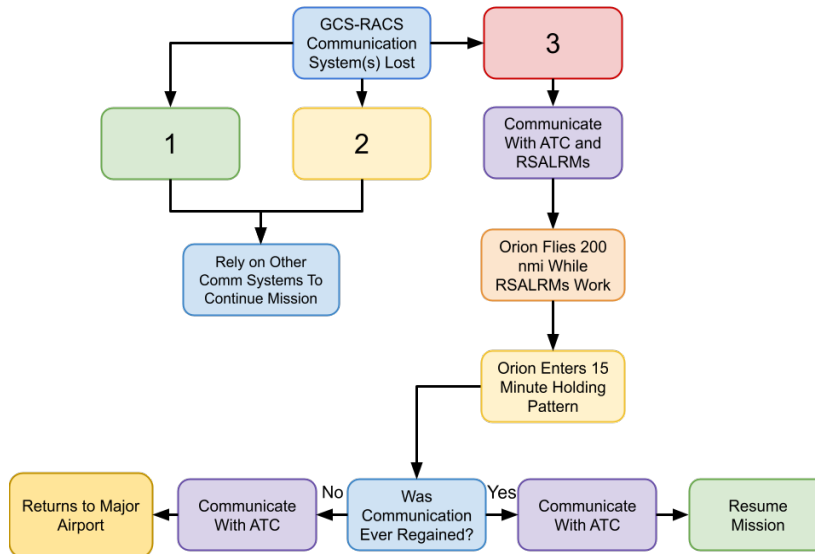

from Orion using the major airport GDT link until around the 250 NM point of the flight, providing the RSALRMs over thirty minutes to attempt to regain communication. Additionally, as Orion has 45 minutes of fuel reserves, it will enter into a fifteen-minute holding pattern to provide additional time to try regaining communication. If communication is regained, the handover procedure occurs, and Orion continues the mission. If communication is not regained, Orion returns to the major airport.

Figure 42: Sensor Ranges and FOV

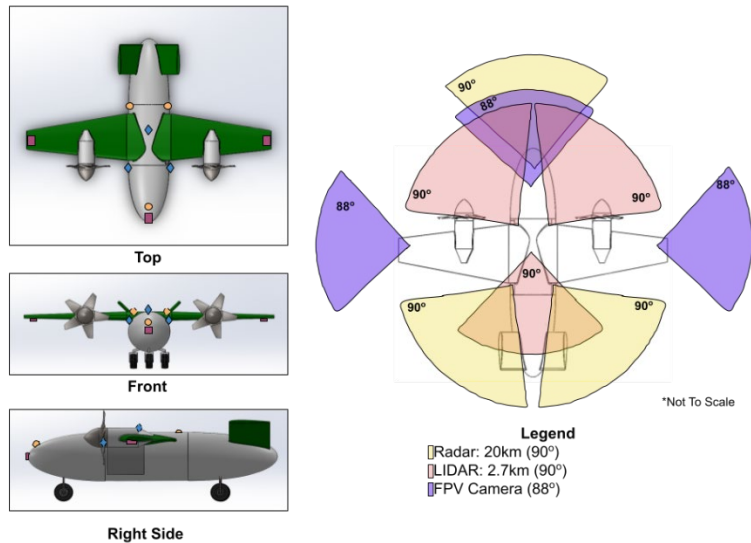

if the communication systems are working or not since FPV feed from the rural airport is displayed around the 50 NM point of the flight. If the FPV feed is not displayed, RSALRMs at both airports will be notified and work in conjunction to try resolving the issue. Orion will continue the mission and the pilots will continue to receive information

**Rural Airport Antenna Link Failure:** Communication during the flight may also be lost due to antenna failure, where the rural airport GDT is unable to connect to the ADT. RSALRMs are unable to check this connection until Orion is 50 NM into the flight, therefore, failure in this connection is more likely to occur than the connection between the ADT and the major airport GDT. However, if failure in the major airport GDT does occur the procedure is demonstrated in 3.3.4 Regulations and Additional Safety. There are two procedures for antenna failure in the rural airport GDT. First, as the GDT and ADT broadcast on a range of frequencies, if these frequencies do not match, the RSALRMs adjust the frequencies. If connection is not re-established and the GDT terminal is determined functional by the RSALRMs, then the ADT is most likely the cause of failure. The OP will command the other ADT to swivel to the GDT at the rural airport for a few seconds and swivel back. If a connection is found, then the ADT would switch back to the rural airport GDT. If not, the ADT would remain connected to the major airport GDT while RSALRMs work on the issue. Protocols are similar to the previous section, where Orion continues to the 250 NM point of the flight where it enters a holding pattern and waits for the RSALRMs. If a connection is found, Orion continues the mission, if not, Orion returns to the major airport.

**Complete Communications Loss:** In the event all communication between Orion and the GCS is suddenly lost, Orion will autonomously enter into a fifteen-minute holding pattern. All aircraft in the vicinity will be notified of the lost communication of a UAS through distress code 7400 sent by the ADS-B transponder. Simultaneously, the SP communicates with ATC at the major airport of the communication loss. If communication is regained within fifteen minutes, Orion continues standard operation towards the rural airport. If communication is not regained Orion will follow the emergency crash point procedure detailed in 3.3.4:

1. Distress code 7400
2. 15-minute holding pattern
3. Crash Point Procedure

**Radio Communications Failure:** If all VHF transceivers were to fail and communications with ATC is completely lost, Orion sends out distress code 7600 to all aircraft in the vicinity. Orion will continue along its scheduled flight path to the rural airport because there is no communication with ATC there must be no deviations to the reported flight path. The SP will continue to attempt to regain communications with ATC, and upon reconnection, inform ATC of all updates to the flight path and progress.

### 3.3.3 Integration with Manned Aircraft

**Part 107 Exemption:** Orion is unable to comply with FAA Part 107 because it is only applied to aircraft that are less than 55 lbs. However, exemptions may be requested that allow the aircraft to fly in National Airspace (NAS). The FAA details the conditions needed to request an exemption in Section 44807, the table below displays how the UAS meets these requirements:

**Table 21: FAA Exceptions**

Requirements	Meets Criteria?	Reason
Concept of Operations	✓	3.1
Operations Manual	✓	Chapters 2 and 3
Emergency Procedures	✓	3.3.4
Checklists	✓	3.1.1, 3.1.4
Maintenance Manual	✓	2.3.3
Training Program	✓	Personnel Given in Challenge Are Trained
Flight History	✓	3.1.4
Safety Risk Analysis	✓	3.3.4

Orion meets all conditions needed for Part 107 exemption and, therefore, may be integrated into the National Airspace.

**Deconfliction:** All pre-set flight plans are sent to the ATM for review prior to the flight, and adjustments are made in accordance which reduces the chances of overlapping flight paths of other aircraft. Communication is established with the ATM through VHF radios, which allows procedures to directly be stated from the ATM. The OP and SP need to communicate with other aircraft at all times during the flight to aid in the avoidance of collisions. A VHF transceiver on Orion and an intercom station on the GCS are employed to accomplish this task. As the C3 link is near-instantaneous, communication with other aircraft would be at the same speed as a traditional manned aircraft, ensuring the OP is able to send and receive messages from the other aircraft in a timely manner.

Furthermore, the UAV flies using Rules of the Air as a method to integrate with crewed aircraft, especially for aircraft using VFR. Orion may also be flown using VFR, as Orion possesses multiple FPV cameras and has a near-instantaneous connection with the GCS, and IFR through its multiple sensors as detailed in section 3.3.1 Detect and Avoid. Pilots utilize radar

from ATC to determine the position of other manned aircraft ahead of time, to provide ample time for the pilots to configure the flight path, communicate with ATC, and communicate with the other pilot before maneuvering. Furthermore, TCAS I alerts the OP of a collision through the information provided by the ADS-B transponder, and TCAS II instructs the pilot on methods to avoid.

### 3.3.4 Regulations and Additional Safety

The Ramjets researched FAA regulations in relation to crewed aircraft and compared it to UAS capabilities. From this, the team created safety procedures that would best align to the mission procedures for the UAV and comply with FAA regulations. UAS compliance to crewed aircraft procedures are detailed in the tables below.

Table 22: FAA Part 23

FAA Part 23	In Compliance?
<p><b>§ 23.2100</b> Weight and center of gravity of the UAV provides safe operation. Calculations must include empty weight and loading calculations</p>	<p>In Compliance. The UAV's weight and balance in regard to empty weight, cargo, and sensors have been calculated (shown in 2.5 Component and Complete Flight Vehicle Weight and Balance) to not affect the operation of the UAV.</p>
<p><b>§ 23.2135</b> The aircraft must be maneuverable without the use of exceptional piloting skill or alertness, and land without causing serious damage.</p>	<p>In Compliance. The UAV is semi-autonomous, where the flight path has already been pre-determined and incorporated into the UAV. The OP is only required to adjust the flight path when necessary or take manual control during emergency situations. Furthermore, Orion safely lands via LOS operations.</p>

Table 23: FAA Part 25

FAA Part 25	In Compliance?
<p><b>§ 25.143</b> The airplane must be safely controlled and maneuverable during takeoff, climb, level flight, descent, and landing.</p>	<p>In Compliance. Proper sensor, camera, and GCS systems allow the pilot to safely control the UAV during all stages of flight. Detection systems allow the avoidance of any possible crewed aircraft.</p>
<p><b>§ 25.235</b> The shock absorbing mechanism may not damage the structure of the airplane when the airplane is taxied.</p>	<p>In Compliance. The aircraft is equipped with shock absorbing landing gears that allow the pilot to easily taxi, without impairing the structure of the aircraft.</p>

<p style="text-align: center;"><b>§ 25.251</b></p> <p>The airplane must be demonstrated in flight to be free from any vibration and buffeting that would prevent continued safe flight.</p>	<p>In Compliance. The UAV utilizes five propeller blades on each prop and a V shape empennage in order to help eliminate harmonic motion and vibrations that may occur.</p>
<p style="text-align: center;"><b>§ 25.253</b></p> <p>Allowing for pilot reaction time after effective inherent or artificial speed warning occurs, it must be shown that the airplane can be recovered to a normal altitude without exceptional pilot skill or exceeding structural limitations</p>	<p>In Compliance. The UAV consists of a delay of 2.3 ms, allowing for a quick enough reaction time for the pilot to make any needed maneuvers in order to restore altitude. The weight and balance has been calculated to not exceed structural limitations.</p>
<p style="text-align: center;"><b>§ 25.671</b></p> <p>The airplane must be capable of continued safe flight and landing after any of the following failures or jamming in the flight control system and surfaces (including trim, lift, drag, and feel systems) without requiring exceptional piloting skill or strength.</p>	<p>In Compliance. The UAV is equipped with the proper GCS systems to where if any failure or jamming were to occur amongst the trim, lift, drag, and/or fuel systems, the OP and SP could safely perform landing.</p>
<p style="text-align: center;"><b>§ 25.875</b></p> <p>Each part of the airplane near the propeller tips must be strong and stiff enough to withstand the effects of the induced vibration and ice thrown off the propeller.</p>	<p>In Compliance. The propeller was made to reduce any possible vibrations along with there being no glass around propeller tips. Any other material surrounding the propeller consists of aluminum.</p>

Table 24: FAA Part 121

FAA Part 121	In Compliance?
<p style="text-align: center;"><b>§ 121.123</b></p> <p>Supplemental operations must have competent personnel, adequate facilities, and equipment. This should allow for proper servicing, maintenance, and preventative maintenance</p>	<p>In Compliance. All Ground Support Personnel are certified, competent personnel given PPE, proper equipment approved by NIOSH and OSHA, and safety data sheets (SDS), data sheets containing information about substances and products in relation to the working conditions. The aircraft, is preliminarily checked for any issues and given maintenance by RSLARM's when needed</p>

<p align="center"><b>§ 121.125</b></p> <p>There must be proper monitoring of the progress of the flight, and the pilot in command must be provided with all information necessary for the safety of the flight</p>	<p>In Compliance. The progression of the flight is constantly monitored by the OP since the positional data of the UAV, FPV camera, data of nearby aircraft, and environment is shown through the monitors present in the GCS. This allows for the OP to know all data necessary to adjust the flight paths as needed to maintain the safety of the flight.</p>
<p align="center"><b>§ 121.159</b></p> <p>No holder may have a single engine airplane.</p>	<p>In Compliance. The UAV has two engines.</p>
<p align="center"><b>§ 121.283</b></p> <p>There must be methods to prevent ice accumulation in the engine air induction system</p>	<p>Not in compliance. The UAV does not have a system to prevent ice accumulation in the engine air induction system</p>
<p align="center"><b>§ 121.385</b></p> <p>The minimum pilot crew is two pilots, and the certificate holder shall designate one pilot as pilot in command and the other second in command.</p>	<p>In compliance. There will be an Operational and Safety Pilot in the GCS monitoring Orion at all times. The OP will be in command.</p>

Table 25: FAA Part 135

FAA Part 135	In Compliance?
<p align="center"><b>§ 135.228 (a)</b></p> <p>no pilots may use any airport inadequate for the proposed operation.</p>	<p>In compliance. The UAV is adequate for takeoff and landing at both the rural and minor airport</p>
<p align="center"><b>135.415</b></p> <p>The pilot should report any failures, malfunctions, or defects in aircraft</p>	<p>In compliance. It is stated that the OP is to report anything wrong with the aircraft.</p>

**Part 121:** Though Orion would be classified as a Part 135 aircraft because operations are on-demand, such as having a payload of less than 7,500 lbs and having a zero-passenger configuration, Part 121 offers more stringent requirements for air travel because it encompasses larger aircraft. Therefore, Part 121 certified aircraft are safer than those that are Part 135 certified. Orion's operations meet requirements for Part 121, demonstrating the overall safety of the mission.

**Safety Assurance:** RSALRMs, ATMs, and the OP complete pre-mission, mission, and post-mission checklists stated in 3.1 Concept of Operations. Furthermore, RSALRMs inspect and maintain the UAV before each flight. These procedures reduce the possibility of mishaps during takeoff, cruising, and landing. Additionally, at the start of every month, a meeting takes place in which all personnel re-establish safety regulations, enforcing proper PPE is worn, and discuss steps to improve methods in the workplace to avoid accidents that may occur.

**Safety Risk Management:** The RamJets have categorized safety in terms of system, mission, and effect on the environment. The risk assessment must be employed before each mission to identify hazards concerning the safety of the system, mission, and environment. Several re-evaluations have been made throughout the flight period. Each hazard is tested on two scales:

**Likelihood of hazard: ( 1 = Unlikely, 5 = Frequent)**

**Severity of hazard: (1 = Negligible, 4 = Catastrophic )**

The definitions of likelihood and potential severity were influenced by the FAA's risk assessment. The values in Table 26: Risk Score Calculations and Table 27: Assessing Risk Values details the assignment of values.

**Table 26: Risk Score Calculations**

Incident Likelihood		Potential Severity	
Value	Definition	Value	Definition
5	Frequent	1	Negligible: Less than minor equipment damage or injury
4	Likely		
3	Occasional	2	Moderate: Minor property and environmental damage. Minor equipment damage or minor injury
2	Seldom	3	Critical: Serious Injury, extensive property damage (< than \$100,000) or moderate equipment damage
1	Unlikely	4	Catastrophic: Death, permanent disability, extensive property damage (> than \$100,000), extensive environmental damage or extensive equipment damage

While completing the pre-mission checklist, RSALRMs calculate the Risk Value:

**Risk Score Calculation: (Likelihood) \* (Severity) = Risk Score**

For example, the likelihood of both engines failing is unlikely and the potential severity could be catastrophic, therefore, the risk score would be four.

The following table demonstrates the procedures taken for a range of risk values.

**Table 27: Assessing Risk Values**

Risk Level	Risk Value	Procedure
Extremely High	12	Must resolve the issue immediately. RSALRMs are to repair and document repairs made, along with the cause of the risk and methods to mitigate the issue from recurring. Both pilots will evaluate the risk level after repairs in conjunction with the RSALRMs to determine if the UAV is safe to fly.
High Risk	8-11	Must resolve the issue at once. Like an extremely high-risk level, RSALRMs are to document the issue and discuss ways to prevent the issue from recurring. Both pilots will evaluate the risk level after repairs in conjunction with the RSALRMs to determine if Orion is safe to fly.
Medium Risk	6-7	Continue operation, must discuss methods to lower or negate risk during mission debrief. If a solution is found, RSALRMs are to remain after the mission to fix the aircraft. If not, methods to mitigate the risk will be discussed during the debrief.
Low Risk	5	Continue Operation

The table above demonstrates how personnel determine the level of significance in addressing a potential risk. If low, then personnel would not address the issue immediately. For instance, although the consequences of a multi-engine failure is catastrophic, the chances that one would occur is very unlikely. Thus, the operation can continue regardless of the potential risk.

In the event repairs need to be made and the mission is delayed, all personnel will work full hours. RSALRMs will work on repairs and documentation, package handlers will standby and unload or load the LD3 containers depending on the amount of damage from the fuselage and landing gear. Pilots continue to communicate with ATC when the aircraft is ready to fly and change the flight path, if necessary, as the flight time changes. Pilots will also work in conjunction with the RSALRMs to determine the new risk level after repairs have been made.

**One Engine Out Condition:** Engine failure during the flight is one of the largest safety concerns of the operation. However, as Orion has two engines, the risk level of one engine failing compared to both differs drastically. Utilizing the risk matrix, the risk score was calculated for a one-engine out condition;

**Likelihood: Seldom (2) \* Severity: Moderate (2)**

**Risk Score = 4**

It is seldom that an engine fails during the flight as any engine issues would most likely be found during the pre-mission inspection by the RSALRMs. Orion’s design ensures that if an engine fails during the flight, it can continue the mission and land at the rural airport. The calculations below prove Orion’s ability to safely fly after a two engine out condition and can



thus safely fly after a one engine out condition. Therefore, the severity of an engine failure would bring at most minor equipment damage, bringing a total risk score of four.

**Two Engine Out Condition:** The risk matrix was calculated for two engines.

**Likelihood: Unlikely (1) \* Severity: Catastrophic (4)**

**Risk Score = 4**

It is unlikely both engines fail during the same flight. If this does occur, the severity would be critical, because Orion would need to glide to a rough landing performed by the OP. To find how far Orion could glide with no engine, the team had to find the glide ratio of Orion. The Beechcraft Air King 200 (Previously compared to Orion in 2.3.1 Air Vehicle) features a glide ratio of approximately 15:1 and was used to calculate Orion. This means that for every 15 miles Orion flies, Orion would lose 1 mile of altitude. After both engine failures, Orion could fly for 57 miles from the 20,000 ft cruising altitude, allowing enough time for a safe emergency landing.

Before the failure, the pilots would already notice an issue with the engines based on data from the tachometer and temperature gauge on the engines. Measures may be taken by the OP to try and avoid a complete engine failure, however, if failure is inevitable ATC would be notified in advance, and a distress code 7700 to alert all other aircraft in the vicinity. If one engine fails, the OP controls Orion for the remainder of the flight.

**Emergency Landings:** The OP must follow certain procedures to ensure safety in emergency situations. For any emergency during the flight, the OP will use Figure 44: Emergency Flowchart and apply the procedures as deemed necessary. If a RTH protocol is deemed necessary by the OP, ATC is reported of the adjustments the OP has made to the flight path of the PixHawk 5X. However, in the situation where the UAV is severely hindered, such as when two engines fail, the OP utilizes a landing trajectory optimization system where the geometry position scheme of the UAV and the balanced glide is utilized to land safely. As Orion descends, the aircraft's audio warning system will release an alarm of about 100 dB to ensure any civilians below are alerted of the aircraft.

**Crash Point Procedure:** In the event of a total loss of communication on takeoff, Orion continues to a point 50 NM from the airport, so Orion is in range of the GDT's at both airports. If there is still no connection with either GDT, Orion enters into the 15-minute holding pattern. If at the end of the holding pattern there is still no connection, the UAV diverts to a predetermined safe zone while repair actions continue for the duration of the fuel. Once fuel is exhausted, Orion will follow the crash-landing procedure outlined above. On landing, if Orion loses connectivity with the rural GDT, it will retrace a route to regain visibility to both GDTs at the 250 NM point of the flight. If connection to the major airport is regained it will maintain control while

repairs to the communication system are made. If this is unachievable, the above procedure will take place.

Figure 44: Emergency Flowchart

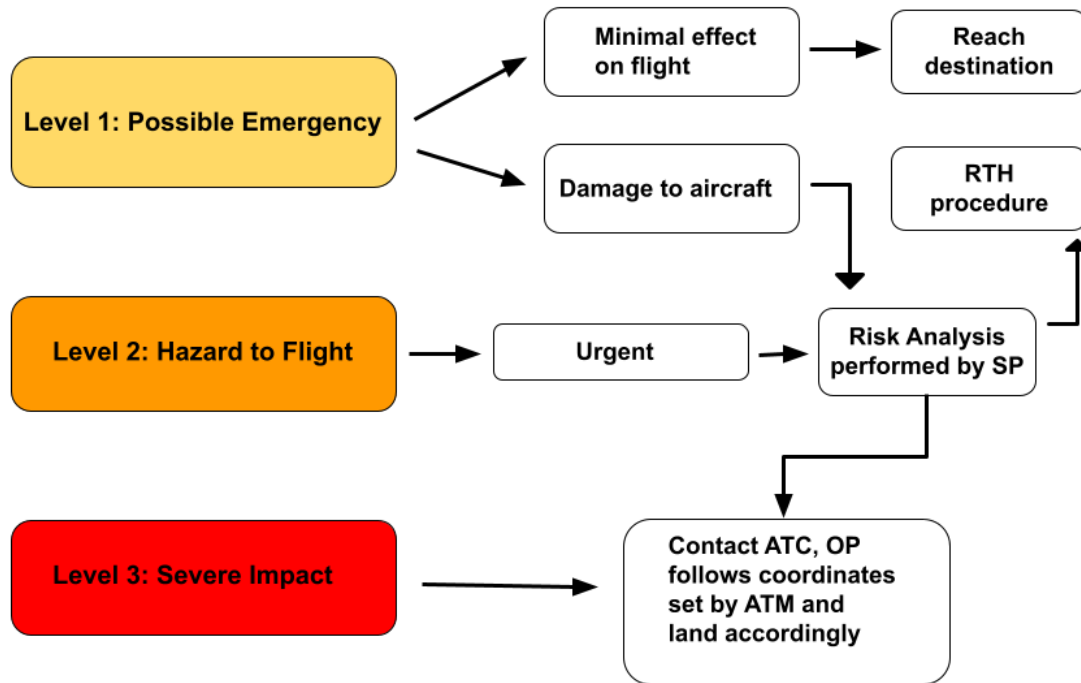

## 4. Business Case

The RamJets have designed Orion, a UAV capable of transporting grouped packages between airfields hundreds of miles away with superior performance compared to alternative methods, specifically trucking and crewed cargo aircrafts. The fixed costs for construction and ongoing operations of the UAS and ground facilities depend on the scale of conversion and will not be discussed here, but the per-flight operating costs and performance characteristics can be compared to existing methods of package transportation. This comparison will show that Orion delivers packages for low costs and emissions experienced with trucking, in a fraction of the time, achieving faster delivery than crewed air transportation.

### 4.1 Comparison to Traditional Methods

The RamJets have designed Orion, a UAV capable of transporting grouped packages between airfields hundreds of miles away and can accomplish this in a fraction of the time it takes 18-wheeled trucks (“Trucking”) and with significantly lower costs than the current method of air transportation via manned aircraft. The fixed costs for construction and ongoing operations of the UAS and ground facilities depend on the scale of conversion and will not be discussed here, but the per flight operating costs and performance characteristics can be compared to

existing methods of package transportation. This comparison will show that Orion delivers packages for similar costs and emissions compared to trucking and significantly improved costs and emissions compared to manned aircraft.

#### 4.1.1 Operating Cost Comparison

The RamJets compared the operating costs of Orion, Crewed Cargo operations, and Truck delivery by analyzing fuel costs and personnel costs individually. The team considered possible delays, and standardized the comparison between the modes of transportation by focusing on key variables that are different between options.

**Fuel Costs:** Orion is powered by twin Pratt and Whitney PT6A-42 engines and consumes a gallon of standard aviation fuel for every 4.38 miles flown. Orion’s fuel costs are calculated based on the \$3.08 price per gallon of aviation fuel depicted in the detailed background of the challenge. The table below details the comparison between all methods of delivery including an adjustment to account for fuel used by idling trucks during delays detailed in 4.1.2 Performance Comparison to Truck.

Table 28: Transportation Type Fuel Usage Comparison

Transportation Type	Mileage (mi)	Fuel Efficiency	Mission Total (gal)	Idling Delay (hrs)	Idling Fuel Consumption (gal/hrs)	Adjustment for Idling Delays (gal)	Total Gallons Used
Orion	345	4.38	78.77	-	-	-	78.77
Truck *	400	6.50	61.54	2.60	0.64	1.66	63.20
Manned Aircraft *	345	0.62	556.45	-	-	-	556.45

Table 29: Transportation Type Fuel Price Comparison

Transportation Type	Total Gallons Used	Cost per Gallon *	Total Adjusted Mission Cost
Orion	78.77	\$ 3.08	\$ 242.60
Truck *	63.20	\$ 2.41	\$ 152.06
Manned Aircraft *	556.45	\$ 3.08	\$ 1,713.87

\* Calculated from costs included in challenge documents

**Comparison to Cargo Truck Delivery:** According to the challenge, the Cargo Truck burns 61.5 gallons (6.5 mpg) assuming that the truck is driving consistently for 7.15 hours. However, trucks typically experience a delay of 4 hours per 7 hours of consistent driving, as described in more detail in 4.1.2 Performance Comparison to Truck. Based on the data contained in Dr. David Correll’s research delays of 2.6 hours (65% of 4 hrs) will result in higher fuel consumption through idling (Dills, Dock delays no. 1 barrier to truckers’ efficient hours utilization, 2021) and would burn an additional 1.66 gallons as cargo trucks burn an average of 0.64 gallons per hour while idling (Idle Fuel Consumption for Selected Gasoline and Diesel Vehicles, 2015). The additional fuel usage for idling delays adds approximately \$4 per one-way trip. Orion does not experience the same delays as trucks and finishes the mission in 55 minutes. Even with the additional fuel from idling, trucks generally have a lower fuel

consumption leading to a lower fuel cost due to both fuel efficiency and the costs of diesel compared to standard aviation fuel.

**Comparison to Crewed Aircraft:** Delays resulting in additional fuel consumption for crewed and uncrewed aircraft are uncommon, do not occur often on a regular mission, and were not included for fuel cost calculations. The crewed aircraft utilized by the challenge uses 176 gallons per hour (Cessna Skycourier Specifications, n.d.). Orion’s fuel efficiency is 4.38 miles per gallon while the crewed aircraft has a fuel efficiency of 0.62 miles per gallon, which is more than seven times less fuel efficient than Orion. The fuel used in each aircraft is the same, so the crewed aircraft’s higher fuel usage results in a higher total cost of fuel per mission.

**Personnel:**

**Cargo Loading/Unloading Personnel:** Orion’s operations utilize ground crew including RSALRM’s and Package Handlers. A breakdown of these ground crew personnel costs can be found in 2.3.3 Ground/Support Equipment. However, all methods of transportation will include similar costs for loading and unloading personnel. Therefore, the costs of these personnel are not included in the cost analysis.

**Differences in Amount of Operators:** Within Cargo Truck and Crewed aircraft, the operator is physically present in the vehicle, eliminating the need for an additional operator. However, Orion is piloted from a GCS, and to reduce risk of a potential emergency such as loss of communications, an OP and SP are included to ensure communication and safety within all aspects of the flight. This leads to Orion having higher personnel costs than Crewed aircraft, but still falling below the costs for Cargo truck delivery, as truck drivers are paid per mile. Total personnel costs can be found below.

**Table 30: Total Personnel Costs**

Personnel Name	Job Description	Quantity of Personnel	Duration	UOM	Pay Rate	Mission Payment
<b>Orion</b>						
Operational Pilot	Adjusts, monitors, and guides UAV. Controlling Orion during an emergency.	1	2	hour	\$35.00	\$ 70.00
Safety Pilot	Communicates with ATC and other aircraft. Always assist OP in guiding the flight, including emergency situations.	1	2	hour	\$35.00	\$ 70.00
Total Cost						\$ 140.00
<b>Cargo Truck Delivery</b>						
Truck Driver	Drives truck for delivery	1	400	miles	\$0.60	\$ 240.00
<b>Crewed Aircraft Operations</b>						
Operational Pilot	Adjusts, monitors, and guides aircraft to its destination	1	2.4	hour	\$35.00	\$ 85.05

Total operating costs for all three systems of delivery are shown in the table below.

**Table 31: Total Operational Costs Comparison**

Transportation Type	Total Fuel Cost Per Mission (\$)	Total Personnel Cost per Mission (\$)	Total Operating Costs (\$)
Orion	\$ 242.60	140.00	382.60
Truck *	\$ 152.06	240.00	392.06
Crewed Aircraft *	\$ 1,713.87	85.05	1,798.92

After considering both fuel costs and total personnel costs over the span of one mission, the RamJets found that Orion has fewer operating expenses than the two alternatives of transportation. This is primarily due to the lower personnel costs of Orion in comparison to Truck delivery, and less fuel costs of Orion in comparison to Crewed aircraft.

#### 4.1.2 Performance Comparison to Truck

To fairly assess the comparison between Cargo Trucks and Orion, the RamJets decided to consider factors that are present during a standard day of delivery, such as delays leading to idling. Furthermore, the team analyzed several non-financial factors that compared Orion and traditional Cargo Trucks.

**Time Difference:** Orion completes the 300 NM trip in 55 minutes, almost eight times faster than the truck’s delivery time. Additionally, trucks are highly reliant on clear traffic to operate efficiently. If there is any construction, accidents, or other obstacles that cause a delay in traffic, the time it takes to complete the mission can change significantly. Additionally, truck drivers are subject to certain safety regulations that limit the amount of time they drive to eleven hours, with a ten-hour break (Hours of Service Regulations, 2022).

Research conducted by Dr. David Correll found long-haul truckers average only 6.5 to 7 hours of driving per day. This is due to traffic delays, difficulty locating parking during breaks, and bottlenecks relating to shippers or receivers. Because drivers are allowed 11 driving hours before mandatory rest, this statistic leads to an assumed 4 hour delay per day (Dills, Dock delays no. 1 barrier to truckers' efficient hours utilization, 2021). As extended delays are likely, an obstruction causing a delay of just under four hours would increase the total time needed to complete the mission to more than 21 hours because of driving regulations. As 35% of this assumed delay is related to the shippers or receivers, only 65% of the four hours of idling time were added to fuel costs, included in section 4.1.1, and emissions values. Pilots are limited, by regulation, to ten hours of flight time between breaks for a two-pilot operation (14 CFR 91.1059(b)(2)). Once this flight time is reached, there is a required ten-hour break. However, Orion flies for under an hour, eliminating the need for this break. Pilots are limited, by regulation,

to ten hours of flight time between breaks for a two-pilot operation. Once this flight time is reached, there is a required ten-hour break. However, Orion flies for under an hour, eliminating the need for this break.

**Emissions:** Orion’s fuel has an emission rating of 18.36 lbs of carbon dioxide (CO<sub>2</sub>) per gallon, while the typical transport truck uses diesel, with a slightly higher emission rating of 22.44 lbs of CO<sub>2</sub> per gallon (Carbon Dioxide Emissions Coefficients, 2022). The Environmental Protection Agency found trucks consume up to 0.64 gallons of diesel fuel for each hour idling (Long-Duration Truck Engine Idling, n.d.). As previously described, idling delays in trucking equating to 2.6 hours or 1.66 gallons of fuel. Trucks also travel a greater distance as there is no direct route but have better fuel efficiency.

Though diesel has higher carbon emissions per gallon, and trucks drive a larger distance with additional fuel used during idling delays, trucks have slightly lower emissions than Orion, as described in Table 32: Orion and Truck Emissions Rate. All emission calculations were done with standard day conditions while including expected traffic delays.

**Table 32: Orion and Truck Emissions Rate**

Transportation Type	Mission Total	Adjustment for Idling/Delays	Total Gallons Used	Emissions Rate (CO <sub>2</sub> per Gallon)	Total Emissions
Orion	78.77	-	78.77	18.36	1,446.16
Truck *	61.54	1.66	63.20	22.44	1,418.26

**Light and Noise Pollution:** Many truck drivers operate at night due to the lower traffic and road work allowing them to cover required distances faster and less expensively (Holtzman, 2018). However, by operating at night, drivers are required to use headlights that only worsen the already immense amount of light pollution. Furthermore, compared to all other road vehicles, large commercial trucks cause the most noise pollution (Effects of Heavy Truck Volumes on Noise, 2010). Since airports are pre-existing structures with high amounts of noise and light pollutants, Orion operating out of an airport would bring no additional noise or light pollution.

**Accidents:** In 2020, there were over 400,000 recorded crashes involving large trucks, equating to roughly 15% of all truck drivers being involved in an accident throughout the year (How often do truck drivers crash?, n.d.). In 2022, out of roughly 110,000 commercial pilots, only 6 had accidents meaning fewer than 0.01% of all pilots were involved in a plane crash (Calder, 2023). Within air transport, 53% of all crashes were caused by human error and 21% were by mechanical error. Besides taking off and landing, Orion operates semi-autonomously where the OP serves only to monitor and take control of the UAV if necessary, thereby

minimizing the risk of human-based crashes (Aviation and Plane Crash Statistics, 2022). By utilizing a UAS, there is a lower risk of accidents.

Orion is \$9.46 (2.5%) lower in operating costs (fuel and labor) than cargo truck transportation. The emissions from Orion are slightly higher than cargo trucks, producing 27.9 lbs (1.9%) more carbon emissions per trip. Orion is at least eight times faster, results in less light and noise pollution, and leads to fewer accidents than cargo truck deliveries while improving the congestion on roadways.

#### 4.1.3 Performance Comparison to Cargo Aircraft

**Time Difference:** The difference in time needed to complete the flight between Orion and the crewed aircraft alternative is significant. The crewed aircraft travels 300 NM in one hour and 26 minutes, while Orion completes the same journey in only 55 minutes, which is 56% percent less time.

**Design Differences:** The most notable change between a crewed and uncrewed aircraft is that uncrewed does not need a fully formed cockpit or pressurized cabin. This allows Orion to be designed more efficiently and eliminates the need to implement a cabin pressurization device. While not having a pressurized cabin can limit the types of cargo that can be transported, excluding these features and crew decreased the weight and complexity of the design in comparison to a crewed alternative.

**Emissions:** There is no difference in emissions per gallon between the crewed alternative and Orion as they both use the same fuel. They operate with emissions of 18.36 lbs of CO<sub>2</sub> per gallon (Carbon Dioxide Emissions Coefficients, 2022). However, the crewed alternative has a significantly lower mpg when compared to Orion, thereby increasing total emissions by 8,770.3 lbs (606.5%) of CO<sub>2</sub> per trip. The table below shows the comparison of emissions and fuel usages of both methods of delivery.

Table 33: Orion and Crewed Aircraft Emissions Comparison

Transportation Type	Mission Total	Adjustment for Idling/Delays	Total Gallons Used	Emissions Rate (CO <sub>2</sub> per Gallon)	Total Emissions
Orion	78.77	-	78.77	18.36	1,446.16
Crewed Aircraft *	556.45	-	556.45	18.36	10,216.45

**Cause of Accidents:** In 2022, 53% of all plane crashes were caused by human error and only 21% were found to be because of mechanical error. By operating Orion semi-autonomously with an OP only there to monitor, and take control of the UAV if necessary, during takeoff and landing the risk of a human-based accident occurring is minimized. Additionally, while there are risks associated with autonomous operations, the team found that because of the negligible latency, and because there are pilots monitoring the flight, those risks are

mitigated. There are multiple redundant systems in place to prevent a communication system failure, all together lowering the possibility of an accident occurring. In the event of an emergency, there are numerous automatic safety procedures in place as detailed in section 3.3. Safety Requirements.

## 4.2 Cost/Benefit Analysis and Justification

**Single-engine vs Multi-engine:** A major design decision was selecting single or twin engines. Unlike a single engine, utilizing two engines provides an additional safety aspect where if an engine is lost during the flight, the overall safety of the mission would not be hindered. However, a twin-engine design increases drag and overall weight of Orion, slightly increasing total fuel consumption by 2.2 gallons, or \$6.86 per trip, compared to a single engine. Despite twin engines bringing on more operating costs, they increase the speed of the aircraft, decreasing flight time. This leads to less fuel burn overall (What are the advantages of twin engine versus single engine for turbo-prop airplanes?, n.d.). It was decided that the additional safety aspect of a one-engine out condition provides a larger benefit than the weight reduced from a single engine and the minor decrease in fuel consumption.

**Single Control Room:** Having a single control room for the entire operation rather than a control room at each airport reduces the number of personnel by two pilots. The reduction equates to \$210 of personnel savings per flight. However, a single control room would increase the potential risk of losing communication between airports. Without a set communication link between airports, the data collected by the GDT at the rural airport cannot be sent to the OP located at the major airport. The team decided to implement a single control room, but reduce the possibility of such a risk by implementing three communication links that transmit the data of the UAV between the two airports at near instantaneous speeds.

**Ratchet straps vs Floor Latches:** Originally, the RamJets had decided upon using straps to secure the LD3's within the aircraft. However, this requires a 30-degree angle for the straps to secure the LD3, requiring a larger UAV. Conversely, floor latches do not need additional room to secure the containers. This led to the reduction of the size of Orion, decreasing fuel consumption of the flight. Implementing floor latches increased the initial costs, but overall improved operational efficiency and greatly reduced the size of Orion and thus reduced fuel costs.

**V-Tail:** A V-Tail empennage was utilized because it has a lighter weight when compared to a conventional aircraft tail. A typical empennage consists of two elevators and a rudder, providing additional stability. A conventional empennage is seen in three quarters of today's



aircraft as it provides greater structural stability compared to a V-tail. However, the biggest advantage provided by the V-tail is that two tails serve the same function as the typical three tails, thus decreasing weight substantially (Tail Designs, n.d.). Since a V-Tail is used, Orion weighs much less leading to reduced fuel costs.

**Flaps/Slats/Airbrake:** Another design choice within the aircraft was whether to employ flaps and slats or an airbrake to increase the aircraft's drag. Without an airbrake, Orion may suffer a decrease in speed upon descent, more descent fuel burn, and increased landing distances (Speedbrakes for the Aviation Industry, n.d.). However, it was decided that an airbrake was unnecessary due to additional moving components increasing cost of maintenance and manufacturing. Additionally, Orion is already able to land within the 3,000 ft runway. Furthermore, unlike airbrakes, flaps and slats increase lift on takeoff and thus decrease fuel costs by even more (Brain, Lamb, & Adkins, n.d.)

**Constant Speed Propeller:** A constant speed propeller changes pitch throughout flight to maximize efficiency at each stage. Although this type of propeller increases the complexity of the design, it creates a more efficient aircraft and thus a reduced fuel cost. In addition to this, a constant speed propeller also acts as an airbrake allowing the RamJets to decrease descent fuel burn and thus decrease fuel costs.

**Requiring LD3-AKN:** Although attraction from potential customers may slightly decrease by requiring them to deliver cargo in the LD3-AKN, the team does not have to consider the process of transferring cargo to LD3s. Therefore, package handling time will decrease, which allows for a shorter mission time and lowered personnel costs.

## 5. Conclusion

The RamJets have created a UAV capable of delivering packages across hundreds of miles while being fuel efficient and environmentally friendly, offering a better alternative to everyday ground and air cargo transport. Orion revolutionizes the aeronautical and delivery industries, inspiring future companies for years to come.

Orion— semi-autonomous and remotely monitored —reduces delivery time, fuel consumption, increases safety, and increases efficiency. The UAV offers advantages for delivering packages from simple loading using floor latches to the complex design of the safety systems within the plane. It is designed to include tapered wings and turboprops to generate the greatest possible fuel efficiency. Not only were greenhouse gas pollutants taken into consideration, the RamJets also designed the UAV to reduce noise and light pollution. Orion was specifically designed to fit the everyday needs of the delivery industry. Using military

technology, Orion operates with sensors that work in tandem with SLAM technology for active obstacle avoidance and provides redundancy. To ensure safety, and integration within the National Airspace, the UAS also fits within FAA regulations relevant to UAVs, along with manned aircraft regulations relevant to the challenge.

The comprehensive CONOPS allows the UAV to safely perform semi-autonomous flight and communicate with all other aircraft in the region. The 20-millisecond delay allows for pilots to immediately respond to any developments to the flight path or Orion. The warehouse was specifically designed to meet OSHA regulations to create a safe and reliable piloting environment, where both ground support personnel and pilots can work without interruption. The 360-degree view of the aircraft provides the pilot with an additional safety aspect not present in traditional crewed aircraft. Personnel work diligently to complete the necessary pre-flight, thru-flight, post-flight checklists, emergency protocols and risk-assessment analysis.

Orion's specific route within its mission allows for a consistent and safe flow of packages. From the simple loading of the LD3-AKN utilizing the aircraft's PDU to the landing and routine checks of the aircraft, Orion is efficient and safe at all stages in flight. The RamJets have considered all stages of flight in case of the very unlikely event of computing devices failing or engine failure.

The RamJets' effective innovation has opened a new world in delivery systems. The RamJets have developed a UAS that fits all requirements and constraints provided by RWDC. Orion is efficient and safe, leading to an optimal design that will be seen in the commercial aviation field for years to come.

## 6. References

### Works Cited

(n.d.). Retrieved from Aviation Stack Exchange:

<https://aviation.stackexchange.com/questions/35493/are-carbon-fiber-composite-aircraft-at-greater-risk-from-lightning>

*4 Common Types of Airplane Fuselages.* (2021, June 30). Retrieved from Monroe Aerospace:

<https://monroeaerospace.com/blog/4-common-types-of-airplane-fuselages/>

*Advantages of more than 4 propeller blades.* (n.d.). Retrieved from

<https://aviation.stackexchange.com/questions/23009/what-are-the-advantages-of-more-than-4-propeller-blades>

*Advantages of twin engine versus single engine for turbo-prop airplanes.* (n.d.). Retrieved from Viking Air: <https://www.vikingair.com/twin-otter-series-400/twin-otter-answers/what-are-advantages-twin-engine-versus-single-engine-turbo#:~:text=In%20general%2C%20twin%20engine%20aircraft,for%20peace%20of%20mind%20alone.>

*Aircraft Propeller Basics.* (2020). Retrieved from Southern Wings: <https://www.southernwings.co.nz/aircraft-propeller-basics/#:~:text=The%20propeller%20works%20by%20displacing,or%20forward%20propulsion%20is%20generated.>

*Aircraft Refueling NATOPS Manual.* (2014).

*AKE Container LD3.* (n.d.). Retrieved from VRR: <https://vrr.aero/products/ake-container/>

*Anhedral Wing Elements.* (2013, February 4). Retrieved from <https://www.f1technical.net/forum/viewtopic.php?t=14617>

*Annual Fleet Fuel Study.* (2022, December 13). Retrieved from NACFE: <https://nacfe.org/news/nacfe-releases-new-annual-fleet-fuel-study-benchmarking-tool/>

*APC Propellers.* (n.d.). Retrieved from APC Propellers: <https://www.apcprop.com/>

*Are more propeller blades better?* (2018, August 28). Retrieved from <https://hartzellprop.com/are-more-propeller-blades-better/>

*Aspect Ratio.* (2022). Retrieved from [http://www.pilotfriend.com/training/flight\\_training/aero/aspect.htm](http://www.pilotfriend.com/training/flight_training/aero/aspect.htm)

*Automatic Dependent Surveillance - Broadcast (ADS-B).* (n.d.). Retrieved from Federal Aviation Administration:

[https://www.faa.gov/about/office\\_org/headquarters\\_offices/avs/offices/afx/afs/afs400/afs410/ads-](https://www.faa.gov/about/office_org/headquarters_offices/avs/offices/afx/afs/afs400/afs410/ads-)

[b#:~:text=Automatic%20Dependent%20Surveillance%E2%80%93Broadcast%20\(ADS,interface%20between%20aircraft%20and%20ATC](https://www.faa.gov/about/office_org/headquarters_offices/avs/offices/afx/afs/afs400/afs410/ads-b#:~:text=Automatic%20Dependent%20Surveillance%E2%80%93Broadcast%20(ADS,interface%20between%20aircraft%20and%20ATC)

*Automation in Aviation: Humans vs. Computers.* (2021, June 28). Retrieved from <https://medium.com/predict/automation-in-aviation-humans-vs-computers-f3fe9ed62ff0>

*Aviation and Plane Crash Statistics.* (2022). Retrieved from [https://www.psbr.law/aviation\\_accident\\_statistics.html](https://www.psbr.law/aviation_accident_statistics.html)

Brain, M., Lamb, R., & Adkins, B. (n.d.). *How Airplanes Work.* Retrieved from <https://science.howstuffworks.com/transport/flight/modern/airplanes3.htm>

Calder, S. (2023, January 1). *Aviation Safety in 2022*. Retrieved from <https://www.independent.co.uk/travel/news-and-advice/aviation-safety-2022-plane-crash-b2254259.html>

*Carbon Dioxide Emissions Coefficients*. (2022, October 5). Retrieved from [https://www.eia.gov/environment/emissions/co2\\_vol\\_mass.php](https://www.eia.gov/environment/emissions/co2_vol_mass.php)

*Cessna Skycourier Specifications*. (n.d.). Retrieved from <https://altivationaircraft.com/cessna-skycourier-specifications/>

*DG406DYZ*. (n.d.). Retrieved from <https://www.newark.com/intersil/dg406dyz/analogue-multiplexer-demultiplexer/dp/24M1318>

*Dills, Dock delays no. 1 barrier to truckers' efficient hours utilization*. (2021, December 2). Retrieved from Overdrive: <https://www.overdriveonline.com/channel-19/article/15282101/dock-delays-no-1-barrier-to-truckers-efficient-hours-utilization>

Duignan, B. (n.d.). *Occam's Razor*. Retrieved from Britannica: <https://www.britannica.com/topic/Occams-razor>

*Effects of Heavy Truck Volumes on Noise*. (2010, August 3). Retrieved from Center for Environmental Excellence: <https://environment.transportation.org/teri-idea/effects-of-heavy-truck-volumes-on-noise/>

(n.d.). *Empennage General Design*. Retrieved from <https://docplayer.net/51987974-9-empennage-general-design.html>

*EN 352 Explained - Hearing Protection Standard*. (2019, March 26). Retrieved from Wise Work Safe: <https://www.wiseworksafe.com/blog/view/understanding-en-352-hearing-protection-standard>

*Exploring the Aerodynamics of Symmetrical Airfoil*. (n.d.). Retrieved from <https://resources.system-analysis.cadence.com/blog/msa2022-exploring-the-aerodynamics-of-symmetrical-airfoil>

*Factors Affecting Lift*. (n.d.). Retrieved from <https://howthingsfly.si.edu/aerodynamics/factors-affecting-lift#:~:text=What%20Factors%20Affect%20Lift%3F,of%20lift%20a%20wing%20creates.>

*Flaps and Slats*. (n.d.). Retrieved from NASA: <https://www.grc.nasa.gov/www/k-12/VirtualAero/BottleRocket/airplane/flap.html>

*Flat Bottomed vs. Semi-Symmetrical vs. Symmetrical Airfoils*. (n.d.). Retrieved from <https://www.simpleplanes.com/Forums/View/1172990/Flat-Bottomed-vs-Semi-Symmetrical-vs-Symmetrical-Airfoils-In-SP-and-RL>

*Forklift Dimensions: What Size Do You Need?* (2023, February 20). Retrieved from <https://www.bigrentz.com/blog/dimensions-of-forklift>

*Global Cloud Xchange*. (n.d.). Retrieved from <https://www.globalcloudxchange.com/>

*Ground Control Station (GCS)*. (2022). Retrieved from <https://desertrotor.com/product/gcs/>

Herbert, A. (n.d.). *High Wing vs. Low Wing Aircraft*. Retrieved from Airplane Academy: <https://airplaneacademy.com/high-wing-vs-low-wing-aircraft-pros-cons-and-key-differences/>

Holtzman, B. (2018, July 12). *Truck Driving at Night*. Retrieved from <https://www.truckinsure.com/truck-driving-at-night-safety-tips/#:~:text=For%20many%20truckers%2C%20nighttime%20is,less%20roadwork%20and%20beautiful%20views>

*Holybro Pixhawk 5X*. (n.d.). Retrieved from [https://docs.px4.io/main/en/flight\\_controller/pixhawk5x.html](https://docs.px4.io/main/en/flight_controller/pixhawk5x.html)

*Hours of Service Regulations*. (2022, March 28). Retrieved from Federal Motor Carrier Safety Administration: <https://www.fmcsa.dot.gov/regulations/hours-service/summary-hours-service-regulations>

*How do fiber-optic cables transmit data?* (n.d.). Retrieved from Spectrum Enterprise: <https://enterprise.spectrum.com/support/faq/internet/how-do-fiber-optic-cables-transmit-data.html#:~:text=Fiber%2Doptic%20cables%20transmit%20data%20via%20fast%2Dtraveling%20pulses%20of,to%20go%20farther%20without%20attenuation>

*How far can I see?* (n.d.). Retrieved from Teledyne: [https://flir.custhelp.com/app/answers/detail/a\\_id/3480/~:/how-far-can-i-see%3F#:~:text=There%20is%20no%20practical%20limit,water%20vapor%20absorbs%20IR%20energy](https://flir.custhelp.com/app/answers/detail/a_id/3480/~:/how-far-can-i-see%3F#:~:text=There%20is%20no%20practical%20limit,water%20vapor%20absorbs%20IR%20energy)

*How often do truck drivers crash?* (n.d.). Retrieved from <https://www.wagnerreese.com/blog/how-often-do-truckers-crash/#:~:text=According%20to%20the%20National%20Highway,involved%20in%20crashes%20per%20year>

*How Strong Is Aluminum?* (2018, April 21). Retrieved from <https://www.aluminumhandraildirect.com/how-strong-is-aluminum/>

*How to Calculate Taper Ratio*. (2017, August 7). Retrieved from <https://sciencing.com/how-10054262-calculate-taper-ratio.html>

Howe, D. (2014). *Aircraft Loading and Structural Layout*. Sanctum Books.

*Idle Fuel Consumption for Selected Gasoline and Diesel Vehicles.* (2015, February 23). Retrieved from Office of Energy Efficiency & Renewable Energy: <https://www.energy.gov/eere/vehicles/fact-861-february-23-2015-idle-fuel-consumption-selected-gasoline-and-diesel-vehicles>

Israr, A., Alkhamash, E., & Hadjouni, M. (2021, October 16). *Guidance, Navigation, and Control for Fixed-Wing UAV.* Retrieved from <https://www.hindawi.com/journals/mpe/2021/4355253/>

*King Air B200 Private Jet Charter.* (n.d.). Retrieved from Paramount Business Jets: <https://www.paramountbusinessjets.com/private-jet-charter/aircraft/king-air-b200>

*LD3 AKE Dimensional Drawings.* (n.d.). Retrieved from <https://www.uldcontainers.com/ld3.html>

*Long-Duration Truck Engine Idling.* (n.d.). Retrieved from Environmental Protection Agency: [https://archive.epa.gov/reg3artd/archive/web/pdf/truck\\_idling\\_fs.pdf](https://archive.epa.gov/reg3artd/archive/web/pdf/truck_idling_fs.pdf)

Masters, C. (2021, May 31). *High Wing or Low Wing.* Retrieved from <https://flighttrainingcentral.com/2021/05/high-wing-or-low-wing-which-trainer-should-i-choose/>

*Modem vs Router: What's the Difference.* (2022, September 7). Retrieved from Wirecutter: <https://www.nytimes.com/wirecutter/blog/modem-vs-router/>

*Monocoque and Semi-Monocoque Structures.* (2017). Retrieved from <https://technologystudent.com/struct1/monospace3.html>

Nassise, M. (n.d.). *Aspect Ratio.*

*Negative Camber - The Anatomy of the Airfoil.* (2022). Retrieved from <https://www.sciencedirect.com/topics/engineering/negative-camber>

Ockfen, A., & Matveev, K. (2009). Aerodynamic characteristics of NACA 4412 airfoil. *International Journal of Naval Architecture and Ocean Engineering.*

*OSHA & ANSI Hard Hat Requirements.* (n.d.). Retrieved from Graphic Products: <https://www.graphicproducts.com/articles/osha-ansi-hard-hat-requirements/>

*Pratt & Whitney PT6A-42.* (n.d.). Retrieved from Aircraft Database: <https://aircraft-database.com/database/engine-models/pt6a-28>

*Selecting the right lightweight metal.* (2022, August 25). Retrieved from <https://blog.keronite.com/selecting-the-right-lightweight-metal>

*Sharing Internet between Two Houses.* (2022, September 20). Retrieved from <https://azaditpark.com/sharing-internet-between-two-houses/>

*Speedbrakes for the Aviation Industry.* (n.d.). Retrieved from <https://preciseflight.com/general-aviation/speedbrakes/>

*Tail Designs*. (n.d.). Retrieved from <http://what-when-how.com/flight/tail-designs/>

*The Pros and Cons of Low Wing vs High Wing Aircraft*. (2022, November 26). Retrieved from <https://pilotinstitute.com/high-wing-vs-low-wing/#:~:text=The%20critical%20differences%20between%20high,has%20wings%20below%20the%20fuselage>

*To 'V' or not to 'V'*. (2017, November 28). Retrieved from <https://ultralightdesign.wordpress.com/2017/11/28/to-v-or-not-to-v/>

*Transportation of Hazardous Materials*. (n.d.). Retrieved from AOPA: <https://www.aopa.org/training-and-safety/active-pilots/safety-and-technique/operations/transportation-of-hazardous-materials#p>

*Tricycle Gear or Taildragger?* (2021, October 6). Retrieved from <https://www.flyingmag.com/tricyclegear-or-taildragger/#:~:text=As%20mentioned%20above%2C%20a%20taildragger,than%20its%20tricycle%2Dgear%20counterpart.>

Vaidyanathan, V. (2022, July 9). *How Is Carbon Fiber Made?* Retrieved from <https://www.scienceabc.com/eyeopeners/how-is-carbon-fiber-made.html#:~:text=Carbon%20fiber%20is%20a%20graphite,be%20used%20in%20various%20products.>

Wainfan, B. (2020, June 14). *Design Process: Planform Shape*. Retrieved from KitPlanes: <https://www.kitplanes.com/design-process-planform-shape/>

Weiner, M. (2022). *Before the flight: Taxiing – the high art of ground maneuvers*. Retrieved from <https://aeroreport.de/en/good-to-know/before-the-flight-taxiing-the-high-art-of-ground-maneuvers>

*What are the advantages of twin engine versus single engine for turbo-prop airplanes?* (n.d.). Retrieved from <https://www.vikingair.com/twin-otter-series-400/twin-otter-answers/what-are-advantages-twin-engine-versus-single-engine-turbo#:~:text=There%20are%20also%20performance%20and,fueling%20for%20only%20one%20engine>

*What Does a Flight Management System (FMS) Do?* (n.d.). Retrieved from <https://westpalmjetcharter.com/flight-management-system-fms/#:~:text=A%20flight%20management%20system%2C%20or,radio%20in%20order%20to%20navigate.>

*What is UAV LiDAR?* (2022, May 25). Retrieved from <https://www.routescene.com/resources/what-is-uav->

