

BIT 500 - Pure Epoxy



Features and Benefits

Version 26/09/2017

- High bond strength with High load resistance
- Used with all grades of threaded rod and rebar in accordance with TR029
- Ideal for deep embedment installations
- Used in non-cracked and cracked concrete
- Used in dry and wet concrete and also in wood
- Used in flooded holes
- Used for overhead applications
- ETA approved for diamond drilled holes
- Ideal for elevated temperatures - temperature ranges I, II and III
- ETA approved for rebar installations under TR023 and EN1992-1-1:2004 EC2
- Zero shrinkage enables large diameter installations
- **ETA approved for Seismic Loads C2**
- Manual cleaning up to 20mm diameter and embedment depths of 240mm
- Independently tested and approved - anchor life 50 years

Contents

- PAGE 1 - Features and Benefits
- PAGE 2 - Typical characteristic and design resistance performance with 5.8 grade studding and associated installation data
- PAGE 3 - Design Resistance used with various stud strengths, material and rebar.
- PAGE 4 - Characteristic and Design load resistances based on characteristic bond strengths for hef 4d (minimum embedment) to 20d
- PAGE 5 - Bond Strength Factors
- PAGE 6 - Characteristic and Design load resistances for REBAR based on characteristic bond strengths for hef 4d (minimum embedment) to 20d
- PAGE 7 - Bond Strength Factors for REBAR
- PAGE 8 - Material properties for threaded rods and rebar
- PAGE 9, 10, 11 - Post Installed Rebar values
- PAGE 12 - Tension Edge and Spacing reduction factors
- PAGE 13 - Curing Time / Temperature Range
- PAGE 14 - Installation parameters: drilling hole cleaning and installation

Shelf Life and Storage

This product should be stored between +5°C & +25°C.

The Shelf life of the product is 24 months from the manufacture date.

IMPORTANT The information and data given is based on our own experience, research and testing and is believed to be reliable and accurate.

However, as we cannot know the varied uses to which its products may be applied, or the methods of application used, no warranty as to the fitness or suitability of its products is given or implied. It is the users responsibility to determine suitability of use. For further information please contact Our Technical Department.



BIT 500 - Pure Epoxy



Product Description

BIT 500 is a 2 component high strength pure epoxy chemical anchoring resin system. It is designed for deep embedment and large diameter holes due to its zero shrinkage, and longer working times.

For diamond drilled holes, with rebar, and in areas of high chemical exposure eg. Seasalt and swimming pools.

Available in Sizes: 385ml Cartridge or 585ml Cartridge.

Specific Benefits

- Long working times
- High loads possible
- High chemical resistance
- Use with potable water
- Fixing studs in wood
- 24 Month shelf life
- Diamond drilled holes
- Zero shrinkage
- European approved
- Fire approved
- Studs and rebar
- A+ Rating VOC content

Approvals

- ETA Option 1 ETAG 001 for cracked concrete with studs and rebar TR029
- ETA Option 1 ETAG 001 for rebar TR023 : **Approved for Seismic Loads C2**
- F120 Fire Test report • ICC-ES Approval ESR 3853
- BS6920 for use with potable water **WRAS Approved 1309560**
- ETA approved in flooded holes, wet and dry concrete
- Tested according to LEED 2009 EQ c4.1, SCAQMD rule 1168 (2005).

Typical characteristic and design resistance performance with 5.8 grade studding and associated installation data

Stud Ø (mm)	Characteristic Resistance (kN)		Design Resistance (kN)		Recommended Load (kN)		Characteristic distances (mm)			Min Edge and Spacing (mm)	Nominal Embedment (mm)	Hole Diameter concrete (mm)	Hole Diameter fixture (mm)	Max Torque (Nm)
	Tension	Shear	Tension	Shear	Tension	Shear	Edge	Spacing	Edge					
	N_{rk}	V_{rk}	N_{rd}	V_{rd}	N_{rec}	V_{rec}	$C_{cr,N}$	$S_{cr,N}$	$C_{cr,V}$	C_{min} S_{min}				
M8	19.00		12.70		9.07						60			
	19.00	9.00	12.70	7.20	9.07	5.14	80	160	80	40	80	10	9	10
	19.00		12.70		9.07						160			
M10	28.27		15.71		11.22						60			
	30.20	15.00	20.10	12.00	14.36	8.57	100	200	90	50	90	12	12	20
	30.20		20.10		14.36						200			
M12	39.58		21.99		15.71						70			
	43.80	21.00	29.20	16.80	20.86	12.00	120	240	110	60	110	14	14	40
	43.80		29.20		20.86						240			
M16	56.30		31.28		22.34						80			
	81.60	39.00	54.40	31.20	38.86	22.29	160	320	125	80	125	18	18	80
	81.60		54.40		38.86						320			
M20	73.51		35.01		25.00						90			
	127.40	61.00	84.90	48.80	60.64	34.86	200	400	180	100	170	24	22	120
	127.40		84.90		60.64						400			
M24	90.48		43.08		30.77						100			
	183.60	88.00	122.40	70.40	87.43	50.29	240	480	220	120	210	28	26	160
	183.60		122.40		87.43						480			
M27	111.97		53.32		38.08						110			
	238.00	115.00	159.10	92.00	109.52	65.71	270	540	240	135	240	32	30	180
	238.00		159.10		109.52						540			
M30	135.72		64.63		46.16						120			
	292.00	142.50	194.50	114.00	133.33	81.43	300	600	280	150	280	35	32	200
	292.00		194.50		133.33						600			
M33	148.25		70.60		50.43						130			
	342.12	173.50	162.91	138.80	116.36	99.14	330	660	310	165	300	37	36	250
	360.00		240.60		165.20						660			
M36	174.74		83.21		59.43						150			
	396.07	212.50	188.60	170.00	134.72	121.43	360	720	330	180	340	40	38	300
	425.00		283.33		202.38						720			

= steel failure

Table notes : see back page

BIT 500 - Pure Epoxy



Design Resistance used with various stud strengths, material and rebar.

5.8 Grade Steel Studding

Stud Diameter (mm)	Hole Diameter (mm)	Embedment depth h _{ef}																			h _{ef} failure (mm)	F _{d,s} design load (kN)	
		60	70	80	90	100	110	120	130	140	160	200	240	280	320	400	480	540	600	660			720
8	10	12.6	12.7																		61	12.7	
10	12	15.7	18.3	20.1																	77	20.1	
12	14		22.0	25.1	28.3	29.2															93	29.2	
16	18			31.4	35.3	39.2	43.1	47.1	51.0	54.4											139	54.4	
20	24			33.2	37.3	41.5	45.6	49.8	53.9	58.1	66.4	82.9	84.9								205	84.9	
24	28					43.0	47.3	51.6	55.9	60.2	68.8	86.0	103.2	120.4	122.4						285	122.4	
27	32						53.2	58.0	62.9	67.7	77.4	96.7	116.1	135.4	154.7	159.1					329	159.1	
30	35						64.5	69.8	75.2	86.0	107.5	128.9	150.4	171.9	194.5						362	194.5	
33	38							71.4	76.9	87.9	109.9	131.9	153.9	175.9	219.8	240.6					438	240.6	
36	40								77.6	88.7	110.8	133.0	155.2	177.4	221.7	266.0	283.2				511	283.2	
Depth (mm)		60	70	80	90	100	110	120	130	140	160	200	240	280	320	400	480	540	600	660	720		

8.8 Grade Steel Studding

Stud Diameter (mm)	Hole Diameter (mm)	Embedment depth h _{ef}																			h _{ef} failure (mm)	F _{d,s} design load (kN)	
		60	70	80	90	100	110	120	130	140	160	200	240	280	320	400	480	540	600	660			720
8	10	12.6	14.7	16.8	18.8	19.5															93	19.5	
10	12	15.7	18.3	20.9	23.6	26.2	28.8	30.9													118	30.9	
12	14		22.0	25.1	28.3	31.4	34.5	37.7	40.8	44.0	45.0									143	45.0		
16	18			31.4	35.3	39.2	43.1	47.1	51.0	54.9	62.7	78.4	83.7							214	83.7		
20	24			33.2	37.3	41.5	45.6	49.8	53.9	58.1	66.4	82.9	99.5	116.1	130.7					315	130.7		
24	28					43.0	47.3	51.6	55.9	60.2	68.8	86.0	103.2	120.4	137.5	171.9	188.3			438	188.3		
27	32						53.2	58.0	62.9	67.7	77.4	96.7	116.1	135.4	154.7	193.4	232.1	244.8		506	244.8		
30	35						64.5	69.8	75.2	86.0	107.5	128.9	150.4	171.9	214.9	257.9	290.1	299.2		557	299.2		
33	38							71.4	76.9	87.9	109.9	131.9	153.9	175.9	219.8	263.8	296.7	329.7	362.7	370.1	674	370.1	
36	40								77.6	88.7	110.8	133.0	155.2	177.4	221.7	266.0	299.3	332.5	365.8	399.1	786	435.7	
Depth (mm)		60	70	80	90	100	110	120	130	140	160	200	240	280	320	400	480	540	600	660	720		



Design Resistance used with various stud strengths, material and rebar.

10.9 Grade Steel Studding

Stud Diameter (mm)	Hole Diameter (mm)	Embedment depth hef																			hef failure (mm)	F _{d,s} design load (kN)	
		60	70	80	90	100	110	120	130	140	160	200	240	280	320	400	480	540	600	660			720
8	10	12.6	14.7	16.8	18.8	20.9	23.0	25.1	27.2												130	27.2	
10	12	15.7	18.3	20.9	23.6	26.2	28.8	31.4	34.0	36.6	41.9	43.1									165	43.1	
12	14		22.0	25.1	28.3	31.4	34.5	37.7	40.8	44.0	50.3	62.6									199	62.6	
16	18			31.4	35.3	39.2	43.1	47.1	51.0	54.9	62.7	78.4	94.1	109.8	116.6						297	116.6	
20	24			33.2	37.3	41.5	45.6	49.8	53.9	58.1	66.4	82.9	99.5	116.1	132.7	165.9	182.0				439	182.0	
24	28				43.0	47.3	51.6	55.9	60.2	68.8	86.0	103.2	120.4	137.5	171.9	206.3	232.1	257.9	262.2		610	262.2	
27	32					53.2	58.0	62.9	67.7	77.4	96.7	116.1	135.4	154.7	193.4	232.1	261.1	290.1	319.1	341.0	705	341.0	
30	35						64.5	69.8	75.2	86.0	107.5	128.9	150.4	171.9	214.9	257.9	290.1	322.4	354.6	386.8	776	416.7	
33	38							71.4	76.9	87.9	109.9	131.9	153.9	175.9	219.8	263.8	296.7	329.7	362.7	395.7	938	515.5	
36	40								77.6	88.7	110.8	133.0	155.2	177.4	221.7	266.0	299.3	332.5	365.8	399.1	1095	606.9	
Depth (mm)		60	70	80	90	100	110	120	130	140	160	200	240	280	320	400	480	540	600	660	720		

A4-70 Stainless Steel Studding

Stud Diameter (mm)	Hole Diameter (mm)	Embedment depth hef																			hef failure (mm)	F _{d,s} design load (kN)	
		60	70	80	90	100	110	120	130	140	160	200	240	280	320	400	480	540	600	660			720
8	10	12.6	13.7																			65	13.7
10	12	15.7	18.3	20.9	21.7																	83	21.7
12	14		22.0	25.1	28.3	31.6																100	31.6
16	18			31.4	35.3	39.2	43.1	47.1	51.0	54.9	58.8											150	58.8
20	24			33.2	37.3	41.5	45.6	49.8	53.9	58.1	66.4	82.9	91.7									221	91.7
24	28				43.0	47.3	51.6	55.9	60.2	68.8	86.0	103.2	120.4	132.1								307	132.1
27	32					53.2	58.0	62.9	67.7	77.4	80.2											166	80.2
30	35						64.5	69.8	75.2	86.0	98.1											183	98.1
33	38							71.4	76.9	87.9	109.9	121										221	121.3
36	40								77.6	88.7	110.8	133.0	143									258	142.8
Depth (mm)		60	70	80	90	100	110	120	130	140	160	200	240	280	320	400	480	540	600	660	720		

*1 = Tensile strength 500N/mm²



Design Resistance used with various stud strengths, material and rebar.

A4-80 Stainless Steel Studding

Stud Diameter (mm)	Hole Diameter (mm)	Embedment depth h _{ef} (mm)																			h _{ef} failure (mm)	F _{d,s} design load (kN)	
		60	70	80	90	100	110	120	130	140	160	200	240	280	320	400	480	540	600	660			720
8	10	12.6	14.7	15.7																	75	15.7	
10	12		18.3	20.9	23.6	24.8															95	24.8	
12	14		22.0	25.1	28.3	31.4	34.5	36.1													115	36.1	
16	18			31.4	35.3	39.2	43.1	47.1	51.0	54.9	62.7	67.2									171	67.2	
20	24			33.2	37.3	41.5	45.6	49.8	53.9	58.1	66.4	82.9	99.5	104.8							253	104.8	
24	28				43.0	47.3	51.6	55.9	60.2	68.8	86.0	103.2	120.4	132.1							2	307	132.1
27	32					53.2	58.0	62.9	67.7	77.4	80.2										1	166	80.2
30	35						64.5	69.8	75.2	86.0	98.1										1	183	98.1
33	38							71.4	76.9	87.9	109.9	121.3									1	221	121.3
36	40								77.6	88.7	110.8	133.0	142.8								1	258	142.8
Depth (mm)		60	70	80	90	100	110	120	130	140	160	200	240	280	320	400	480	540	600	660	720		

High bond reinforcing bars F_{yk}=500N/mm²

Rebar Diameter (mm)	Hole Diameter (mm)	Embedment depth h _{ef} (mm)																			h _{ef} failure (mm)	F _{d,s} yield load (kN)		
		60	70	80	90	100	110	120	130	140	160	200	240	280	320	400	500	560	640	720			800	
8	10	11.7	13.7	15.6	17.6	19.6	21.5	23.5	25.2														129	25.2
10	12	14.7	17.1	19.6	22.0	24.4	26.9	29.3	31.8	34.2	39.1	39.3											161	39.3
12	15		19.1	21.8	24.5	27.2	30.0	32.7	35.4	38.1	43.6	54.5	56.6										208	56.6
16	20			26.8	30.2	33.5	36.9	40.2	43.6	46.9	53.6	67.0	80.4	93.8	100.6								300	100.6
20	25			28.7	32.3	35.9	39.5	43.1	46.7	50.3	57.5	71.9	86.2	100.5	114.9	143.6							438	157.1
25	30				41.1	45.3	49.4	53.5	57.6	65.8	82.3	98.7	115.2	131.7	164.6	205.7							549	226.0
28	35					50.7	55.3	59.9	64.5	73.7	92.2	110.6	129.0	147.5	184.3	230.4	258.1						668	308.0
32	40							68.5	73.7	84.3	105.3	126.4	147.5	168.5	210.7	263.3	294.9	337.1					763	402.1
36	44								79.2	90.5	113.1	135.7	158.4	181.0	226.0	282.8	316.7	362.0	407.2				902	510.0
40	50									95.8	119.7	143.6	167.6	191.5	239.4	299.2	335.1	383.0	430.9	478.8			1050	628.3
Depth (mm)		60	70	80	90	100	110	120	130	140	160	200	240	280	320	400	500	560	640	720	800			

*1 = Tensile strength 500N/mm²
 *2 = Tensile strength 700N/mm²



Design Resistance used with various stud strengths, material and rebar.

High bond reinforcing bars $F_{yk}=420N/mm^2$

Rebar Diameter (mm)	Hole Diameter (mm)	Embedment depth h_{ef}																			h_{ef} failure (mm)	$F_{d,s}$ yield load (kN)	
		60	70	80	90	100	110	120	130	140	160	200	240	280	320	400	500	560	640	720			800
8	12	9.2	10.8	12.3	13.8	15.4	16.9	18.4													120	18.4	
10	14	11.5	13.4	15.4	17.3	19.2	21.1	23.0	25.0	26.9	28.7										149	28.7	
12	16		14.7	16.8	18.9	20.9	23.0	25.1	27.2	29.3	33.5	41.3									197	41.3	
16	20			21.2	23.9	26.5	29.2	31.8	34.5	37.1	42.5	53.1	73.4								277	73.4	
20	25			22.9	25.8	28.7	31.5	34.4	37.3	40.1	45.8	57.3	68.8	80.2	91.7	114.6					426	114.8	
25	30				33.7	37.0	40.4	43.8	47.1	53.9	67.3	80.8	94.3	107.7	134.7	168.3					490	165.1	
28	35					39.2	42.7	46.3	49.9	57.0	71.2	85.5	99.7	113.9	142.4	178.0	199.4				632	225.0	
32	40						52.9	57.0	65.1	81.4	97.7	113.9	130.2	162.8	203.5	227.9	260.5				722	293.7	
36	44							60.3	68.9	86.2	103.4	120.7	137.9	172.4	215.5	241.3	275.8	310.3			865	372.5	
40	50								76.6	95.8	114.9	134.1	153.2	191.5	239.4	268.1	306.4	344.7	383.0		959	458.9	
Depth (mm)		60	70	80	90	100	110	120	130	140	160	200	240	280	320	400	500	560	640	720	800		

BIT 500 - Pure Epoxy



Characteristic and Design Load resistances based on characteristic bond strengths for hef 4d (minimum embedment) to 20d

Stud Ø (mm)	Non Cracked Concrete						Cracked Concrete						Nominal Embed- ment (mm)												
	Characteristic Resistance (kN)		Design Resistance (kN)		Recommended Load (kN)		Characteristic Resistance (kN)		Design Resistance (kN)		Recommended Load (kN)														
	Tension N _{rk}	Shear V _{rk}	Tension N _{rd}	Shear V _{rd}	Tension N _{rec}	Shear V _{rec}	Tension N _{rk}	Shear V _{rk}	Tension N _{rd}	Shear V _{rd}	Tension N _{rec}	Shear V _{rec}													
M8	22.62	9.00	12.57	7.20	8.98	5.14	Not Applicable	Not Applicable	Not Applicable	Not Applicable	Not Applicable	Not Applicable	60												
	30.16		16.76		11.97								80												
	60.32		33.51		23.94								160												
M10	28.27	15.00	15.71	12.00	11.22	8.57							Not Applicable	Not Applicable	Not Applicable	Not Applicable	Not Applicable	Not Applicable	60						
	42.41		23.56		16.83														90						
	94.25		52.36		37.40														200						
M12	39.58	21.00	21.99	16.80	15.71	12.00													19.79	21.00	11.00	16.80	7.85	12.00	70
	62.20		34.56		24.68														110						
	135.72		75.40		53.86														240						
M16	56.30	39.00	31.28	31.20	22.34	22.29													26.14	39.00	14.52	31.20	10.37	22.29	80
	87.96		48.87		34.91														125						
	225.19		125.11		89.36														320						
M20	73.51	61.00	35.01	48.80	25.00	34.86	33.93	61.00	16.16	48.80	11.54	34.86							90						
	138.86		66.12		47.23		170																		
	326.73		155.58		111.13		400																		
M24	90.48	88.00	43.08	70.40	30.77	50.29	41.47	88.00	19.75	70.40	14.11	50.29	100												
	190.00		90.48		64.63		210																		
	434.29		206.81		147.72		480																		
M27	111.97	115.00	53.32	92.00	38.08	65.71	51.32	115.00	24.44	92.00	17.46	65.71	110												
	244.29		116.33		83.09		240																		
	549.65		261.74		186.96		540																		
M30	135.72	142.50	64.63	114.00	46.16	81.43	62.20	142.50	29.62	114.00	21.16	81.43	120												
	316.67		150.80		107.71		280																		
	678.59		323.14		230.81		600																		
M33	148.25	173.50	70.60	138.80	50.43	99.14	67.39	173.50	32.09	138.80	22.92	99.14	130												
	342.12		162.91		116.37		300																		
	752.66		358.41		256.01		660																		
M36	174.74	212.50	83.21	170.00	59.43	121.43	76.34	212.50	36.35	170.00	25.97	121.43	150												
	396.07		188.60		134.72		340																		
	838.73		399.40		285.28		720																		

Table notes : see back page

BIT 500 - Pure Epoxy



Bond Strength Factors

Influence of concrete strength on combined pull out and concrete cone resistance

Concrete Strength N/mm ² (Mpa)	C15/20	C20/25	C25/30	C30/37	C35/45	C40/50	C45/55	C50/60
f_c =	0.98	1.00	1.02	1.04	1.06	1.08	1.09	1.10

Influence of environmental conditions in non cracked concrete

		M8	M10	M12	M16	M20	M24	M27	M30	M33	M36
Temp I 40°C / 24°C	Dry and Wet	1.00	1.00	1.00	1.00	1.00	1.00	1.00	1.00	1.00	1.00
	Flooded	1.00	0.94	0.87	0.79	0.71	0.65	0.65	0.60	0.57	0.55
Temp II 60°C / 43°C	Dry and Wet	0.65	0.65	0.65	0.65	0.65	0.65	0.65	0.65	0.65	0.65
	Flooded	0.65	0.63	0.61	0.59	0.57	0.54	0.50	0.49	0.46	0.44
Temp III 72°C / 43°C	Dry and Wet	0.57	0.56	0.54	0.53	0.52	0.51	0.50	0.49	0.47	0.46
	Flooded	0.57	0.54	0.52	0.51	0.50	0.49	0.46	0.45	0.43	0.42

Influence of environmental conditions in cracked concrete

		M8	M10	M12	M16	M20	M24	M27	M30	M33	M36
Temp I 40°C / 24°C	Dry and Wet	n/a	n/a	0.50	0.48	0.46	0.45	0.44	0.42	0.41	0.39
	Flooded	n/a	n/a	0.50	0.42	0.38	0.38	0.35	0.30	0.27	0.24
Temp II 60°C / 43°C	Dry and Wet	n/a	n/a	0.32	0.31	0.30	0.29	0.29	0.28	0.27	0.26
	Flooded	n/a	n/a	0.32	0.29	0.28	0.27	0.27	0.25	0.24	0.23
Temp III 72°C / 43°C	Dry and Wet	n/a	n/a	0.27	0.27	0.26	0.25	0.24	0.23	0.23	0.22
	Flooded	n/a	n/a	0.27	0.27	0.26	0.25	0.24	0.23	0.23	0.22

Table notes : see back page

BIT 500 - Pure Epoxy



Characteristic and Design Load resistances for REBAR based on characteristic bond strengths for hef 4d (min embedment) to 20d

Rebar Ø (mm)	Non Cracked Concrete						Cracked Concrete						Nominal Embedment (mm)												
	Characteristic Resistance (kN)		Design Resistance (kN)		Recommended Load (kN)		Characteristic Resistance (kN)		Design Resistance (kN)		Recommended Load (kN)														
	Tension	Shear	Tension	Shear	Tension	Shear	Tension	Shear	Tension	Shear	Tension	Shear													
	N_{rk}	V_{rk}	N_{rd}	V_{rd}	N_{rec}	V_{rec}	N_{rk}	V_{rk}	N_{rd}	V_{rd}	N_{rec}	V_{rec}													
8	21.11	13.95	11.73	9.30	8.38	6.64	Not Applicable	Not Applicable	Not Applicable	Not Applicable	Not Applicable	Not Applicable	60												
	28.15		15.64		11.17								80												
	56.30		31.30		22.34								160												
10	26.39	21.45	14.66	14.30	10.47	10.21							Not Applicable	Not Applicable	Not Applicable	Not Applicable	Not Applicable	Not Applicable	60						
	39.58		21.99		15.71														90						
	87.96		48.87		34.91														200						
12	34.31	31.05	19.06	20.70	13.61	14.79													19.79	31.05	11.00	20.70	7.85	14.79	70
	53.91		29.95		21.39														110						
	117.62		65.35		46.68														240						
16	48.25	55.50	26.81	37.00	19.15	26.43													26.14	55.50	14.52	37.00	10.37	26.43	80
	75.40		41.89		29.92		125																		
	193.02		107.23		76.60		320																		
20	67.86	86.55	32.31	57.70	23.08	41.21	33.93	86.55	16.16	57.70	11.54	41.21							90						
	128.18		61.04		43.60		170																		
	301.59		143.62		102.58		400																		
25	86.39	135.00	41.14	90.00	29.39	64.29	43.20	135.00	20.57	90.00	14.69	64.29	100												
	181.43		86.39		61.71		210																		
	431.97		205.70		146.93		500																		
28	108.37	168.75	51.61	112.50	36.86	80.36	54.19	168.75	25.80	112.50	18.43	80.36	112												
	270.93		129.02		92.15		280																		
	541.86		258.03		184.31		560																		
32	141.55	220.95	67.40	147.30	48.15	105.21	70.77	220.95	33.70	147.30	24.07	105.21	128												
	353.87		168.51		120.36		320																		
	707.74		337.02		240.73		640																		

Table notes : see back page

BIT 500 - Pure Epoxy



Bond Strength Factors - REBAR

Influence of concrete strength on combined pull out and concrete cone resistance

Concrete Strength N/mm ² (MPa)	C15/20	C20/25	C25/30	C30/37	C35/45	C40/50	C45/55	C50/60
f_c =	0.98	1.00	1.02	1.04	1.06	1.08	1.09	1.10
Concrete Strength N/mm ² (MPa)	C55/67	C60/75	C70/85	C80/96	C90/105	-	-	-
f_c =	1.10	1.12	1.13	1.14	1.15	-	-	-

Influence of environmental conditions in non cracked concrete

		Ø 8	Ø 10	Ø 12	Ø 16	Ø 20	Ø 25	Ø 28	Ø 32
Temp I 40°C / 24°C	Dry and Wet	1.00	1.00	1.00	1.00	1.00	1.00	1.00	1.00
	Flooded	1.00	0.94	0.90	0.85	0.80	0.71	0.65	0.63
Temp II 60°C / 43°C	Dry and Wet	0.67	0.65	0.63	0.62	0.61	0.60	0.60	0.59
	Flooded	0.65	0.64	0.61	0.59	0.58	0.56	0.55	0.47
Temp III 72°C / 43°C	Dry and Wet	0.60	0.58	0.57	0.56	0.56	0.55	0.54	0.53
	Flooded	0.58	0.56	0.53	0.50	0.47	0.45	0.43	0.41

Influence of environmental conditions in cracked concrete

		Ø 8	Ø 10	Ø 12	Ø 16	Ø 20	Ø 25	Ø 28	Ø 32
Temp I 40°C / 24°C	Dry and Wet	n/a	n/a	0.55	0.47	0.44	0.43	0.42	0.41
	Flooded	n/a	n/a	0.55	0.42	0.40	0.38	0.36	0.35
Temp II 60°C / 43°C	Dry and Wet	n/a	n/a	0.30	0.28	0.26	0.24	0.23	0.23
	Flooded	n/a	n/a	0.30	0.27	0.25	0.23	0.22	0.22
Temp I 72°C / 43°C	Dry and Wet	n/a	n/a	0.30	0.26	0.25	0.24	0.23	0.22
	Flooded	n/a	n/a	0.30	0.26	0.24	0.23	0.23	0.22

Table notes : see back page

BIT 500 - Pure Epoxy



Material Properties for grades of other threaded rod and rebar

Stud Diameter (mm)	Stud Grade 8.8		Stud Grade 10.9		Stud Grade A4-70		Stud Grade A4-80	
	$N_{rk, s}$ (kN)	$N_{rd, s}$ (kN)	$N_{rk, s}$ (kN)	$N_{rd, s}$ (kN)	$N_{rk, s}$ (kN)	$N_{rd, s}$ (kN)	$N_{rk, s}$ (kN)	$N_{rd, s}$ (kN)
M8	29.2	19.5	38.1	27.2	25.6	13.7	29.2	15.6
M10	46.4	30.9	60.3	43.1	40.6	21.7	46.4	24.8
M12	67.4	44.9	87.7	62.6	59.0	31.6	67.4	36.0
M16	125.6	83.7	163.0	116.4	109.9	58.8	125.7	67.2
M20	196.1	130.7	255.0	182.1	171.5	91.7	196.0	104.8
M24	282.5	188.3	367.0	262.1	247.1	132.1	293.0	132.1
M27	367.0	244.7	477.4	341.0	229.4	80.2	229.4	80.2
M30	448.8	299.2	583.0	416.4	280.6	98.1	280.6	98.1
M33	555.2	370.1	721.8	515.5	347.0	121.3	347.0	121.3
M36	653.6	435.7	849.7	606.9	408.4	142.8	408.4	142.8

Stud Diameter (mm)	Stud Grade 8.8		Stud Grade 10.9		Stud Grade A4-70		Stud Grade A4-80	
	$V_{rk, s}$ (kN)	$V_{rd, s}$ (kN)	$V_{rk, s}$ (kN)	$V_{rd, s}$ (kN)	$V_{rk, s}$ (kN)	$V_{rd, s}$ (kN)	$V_{rk, s}$ (kN)	$V_{rd, s}$ (kN)
M8	14.6	11.7	19.0	12.7	12.8	8.2	14.6	9.4
M10	23.2	18.6	30.2	20.1	20.3	13.0	23.2	14.9
M12	33.7	27.0	43.8	29.2	29.5	18.9	33.7	21.6
M16	62.8	50.2	81.6	54.4	55.0	35.2	62.8	40.3
M20	98.0	78.4	127.4	84.9	85.8	55.0	98.0	62.8
M24	141.2	113.0	183.6	122.4	123.6	79.2	141.2	90.5
M27	183.5	146.8	238.7	191.0	114.7	48.4	114.7	48.4
M30	224.4	179.5	291.5	194.3	140.3	89.9	140.3	89.9
M33	277.6	222.1	360.9	288.7	173.5	111.2	173.5	111.2
M36	326.8	261.4	424.8	283.2	204.2	130.9	204.2	130.9

Rebar Diameter (mm)	Rebar BSt 500 to DIN 488		Rebar BSt 500 to DIN 488	
	$N_{rk, s}$ (kN)	$N_{rd, s}$ (kN)	$V_{rk, s}$ (kN)	$V_{rd, s}$ (kN)
8	28.0	20.0	14.0	9.3
10	43.0	30.7	21.5	14.3
12	62.0	44.3	31.0	20.7
14	85.0	60.7	42.5	28.3
16	111.0	79.3	55.5	37.0
18	140.0	100.0	70.0	46.7
20	173.0	123.6	86.5	57.7
22	209.0	149.3	104.5	69.7
25	270.0	192.9	135.0	90.0
28	339.0	242.1	169.0	112.7
32	442	315.7	221	147.3
36	563.2	443.5	281.6	187.7
40	693.8	546.3	346.9	231.3

Table notes : see back page

BIT 500 - Pure Epoxy



Post installed rebar connections

Minimum anchorage length ¹⁾ and lap splice length for C20/25 and maximum installation length (l_{max})

Rebar		$l_{b,min}$ (mm)	$l_{o,min}$ (mm)	$l_{max,min}$ (mm)
$\varnothing d_s$	$f_{y,k}$ (N/mm ²)			
8mm	500	113	200	1000
10mm	500	142	200	1000
12mm	500	170	200	1200
14mm	500	198	210	1400
16mm	500	227	240	1600
20mm	500	284	300	2000
22mm	500	312	330	2000
24mm	500	340	360	2000
25mm	500	354	375	2000

N/mm² = MPa

1) According to EN 1992-1-1:2004 $l_{b,min}$ (8.6) and $l_{o,min}$ (8.11) for good bond conditions and $a_8 = 1,0$
with maximum yield stress for rebar B500 B and $\gamma_M = 1,15$

Design values of the ultimate bond resistance f_{bd} ¹⁾ in N/mm² for all drilling methods for good conditions

Rebar \varnothing	Concrete Class								
	C12/15	C16/20	C20/25	C25/30	C30/37	C35/45	C40/50	C45/60	C50/60
8mm to 25mm	1.6	2	2.3	2.7	3	3.4	3.7	4	4.3

1) Tabulated values for f_{bd} are valid for good bond condition according to EN1992-1-1:2004. For all other bond conditions multiply the values for f_{bd} by 0.7.

BIT 500 - Pure Epoxy



Post installed rebar connections

Values for pre-calculation of anchoring

Rebar - \varnothing ds	$\alpha_1=\alpha_2=\alpha_3=\alpha_4=\alpha_5=1.0$			α_2 or $\alpha_5=0.7$; $\alpha_1=\alpha_3=\alpha_4=1.0$		
	Anchorage length l_{bd}	Design value N_{rd}	Mortar volume	Anchorage length l_{bd}	Design value N_{rd}	Mortar volume
(mm)	(mm)	(kN)	(ml)	(mm)	(kN)	(ml)
8	113*	6.53	9	113*	9.33	9
	180	10.4	14	150	12.39	11
	250	14.45	19	190	15.69	14
	378	21.85	29	265	21.88	20
10	142*	10.26	13	142*	14.66	13
	220	15.9	20	190	19.61	17
	310	22.4	28	240	24.77	22
	390	28.18	35	280	28.9	25
	473	34.18	43	331	34.17	30
12	170*	14.74	18	170*	21.06	18
	270	23.41	29	230	28.49	24
	370	32.08	39	280	34.68	30
	470	40.75	50	340	42.12	36
	567	49.16	60	397	49.18	42
14	198*	20.03	24	198*	28.61	24
	310	31.36	37	260	37.57	31
	430	43.5	52	330	47.69	40
	550	55.64	66	400	57.81	48
	662	66.97	80	463	66.91	56
16	227*	26.24	31	227*	37.49	31
	360	41.62	49	300	49.55	41
	490	56.65	67	380	62.76	52
	620	71.68	84	450	74.32	61
	756	87.4	103	529	87.37	72
20	284*	41.04	60	284*	58.63	60
	450	65.03	95	380	78.45	81
	610	88.15	129	470	91.03	100
	780	112.72	165	570	117.68	121
	945	136.57	200	662	136.67	140
22	312*	49.6	88	312*	70.85	88
	490	77.89	139	420	95.38	119
	680	108.1	192	520	118.09	147
	860	136.71	243	620	140.8	175
	1040	165.32	294	728	165.32	206
24	340*	58.96	144	340*	84.23	144
	540	93.64	228	450	111.8	190
	740	128.33	312	570	141.21	241
	940	163.01	397	680	168.46	287
	1134	196.65	479	794	196.7	335
25	354*	63.95	133	354*	91.35	133
	560	101.16	211	470	121.29	177
	770	139.09	290	590	152.26	222
	970	175.22	365	710	183.22	267
	1181	213.34	444	827	213.42	311

Example For:

C20/25;
good bond condition;
Rebar Yield Strength
500 N/mm² (500 MPa)

* Minimum anchorage length. The design value is valid for "good bond conditions" according to EN 1992-1-1.

All other condition: multiply value by 0.7. Mortar volume based on equation: $V = 1.2 \cdot (d_o^2 - d_d^2) \cdot \pi \cdot l_b / 4$

BIT 500 - Pure Epoxy



Post installed rebar connections

Values for pre-calculation of overlap joints

Rebar - \emptyset ds	$\alpha_1=\alpha_2=\alpha_3=\alpha_4=\alpha_5=1.0$			α_2 or $\alpha_5=0.7$; $\alpha_1=\alpha_3=\alpha_4=1.0$		
	Anchorage length l_{bd}	Design value N_{rd}	Mortar volume	Anchorage length l_{bd}	Design value N_{rd}	Mortar volume
(mm)	(mm)	(kN)	(ml)	(mm)	(kN)	(ml)
8	200	11.56	15	200	16.52	15
	240	13.87	18	220	18.17	17
	290	16.76	22	230	18.99	17
	378	21.85	29	265	21.88	20
10	200	14.45	18	200	20.64	18
	270	19.51	24	230	23.74	21
	340	24.57	31	270	27.87	24
	400	28.9	36	300	30.97	27
	473	34.18	43	331	34.17	30
12	200	17.34	21	200	24.77	21
	290	25.15	31	250	30.97	26
	380	32.95	40	300	37.16	32
	480	41.62	51	350	43.35	37
14	210	21.24	25	210	30.35	25
	320	32.37	39	270	39.02	33
	440	44.51	53	340	49.13	41
	550	55.64	66	400	57.81	48
	662	66.97	80	463	66.91	56
16	240	27.75	33	240	39.64	33
	370	42.78	50	310	51.2	42
	500	57.81	68	380	62.76	52
	630	72.83	86	460	75.97	62
	756	87.4	103	529	87.37	72
20	300	43.35	64	300	61.93	64
	460	66.48	98	390	80.51	83
	620	89.6	131	480	99.09	102
	780	112.72	165	570	117.68	121
	945	136.57	200	662	136.67	140
22	330	52.46	93	330	74.94	93
	510	81.07	144	430	97.65	122
	680	108.1	192	530	120.36	150
	860	136.71	243	630	143.07	178
	1040	165.32	294	728	165.32	206
24	360	62.43	152	360	89.19	152
	550	95.38	232	470	116.44	198
	750	130.06	317	580	143.69	245
	940	163.01	397	690	170.94	291
	1134	196.65	479	794	196.7	335
25	375	67.74	141	375	96.77	141
	580	104.77	218	490	126.45	184
	780	140.9	293	600	154.84	226
	980	177.03	369	710	183.22	267
	1181	213.34	444	827	213.42	311

Example For:

C20/25;
good bond condition;
Rebar Yield Strength
500 N/mm² (500 MPa)

* Minimum anchorage length. The design value is valid for "good bond conditions" according to EN 1992-1-1.

All other condition: multiply value by 0.7. Mortar volume based on equation: $V = 1.2 \cdot (d_o^2 - d_d^2) \cdot \pi \cdot l_b / 4$

BIT 500 - Pure Epoxy



Post installed rebar schematics

Application examples of post-installed rebar

Figure 1: Overlap joints in slabs and beams.

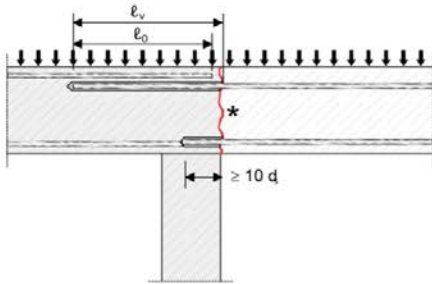

Figure 2: Overlap joint in foundation of a column or wall where the rebars are stressed in tension.

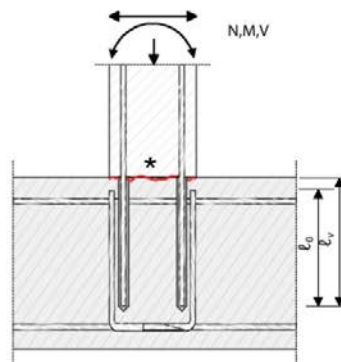

Figure 3: End anchoring of slabs or beams, designed as simply supported.

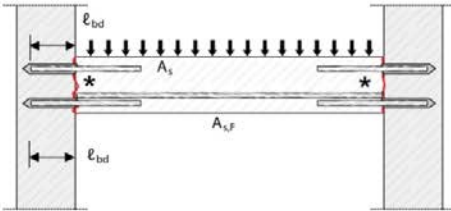

Figure 4: Rebar connection of components stressed primarily in compression. The rebar are stressed in compression.

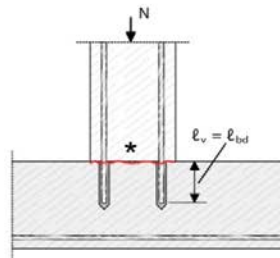
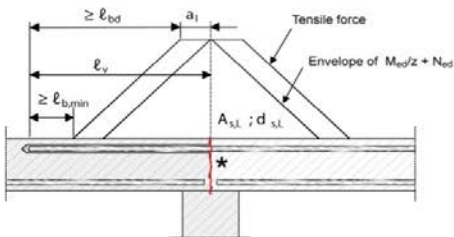

Figure 5: Anchoring of reinforcement to cover the line of acting tensile force.



Note to figure 1 to 5 :

In the figures no transverse reinforcement is plotted, the transverse reinforcement as required by EC 2 shall be present. The shear transfer between old and new concrete shall be designed according to EC2. Description of the bonded-in rebars and overlap joints see Annex 4 and 5.

* Roughened joint

BIT 500 - Pure Epoxy



Effect of Anchor Spacing - Tension

Anchor Spacing (mm)	Stud / Rebar Diameter										
	8	10	12	16	20	24	27	30	33	36	40
40	0.64										
50	0.67	0.63									
60	0.70	0.65	0.63								
70	0.73	0.67	0.64								
80	0.76	0.69	0.66	0.63							
90	0.79	0.72	0.68	0.64							
100	0.82	0.74	0.70	0.65	0.63						
120	0.87	0.79	0.74	0.68	0.65	0.63	0.63				
150	0.96	0.86	0.80	0.73	0.68	0.65	0.64	0.63			
160	1.00	0.88	0.82	0.74	0.70	0.66	0.65	0.63	0.63	0.63	0.63
175		0.92	0.85	0.76	0.71	0.67	0.66	0.64	0.63	0.63	0.63
200		1.00	0.90	0.80	0.74	0.69	0.69	0.66	0.65	0.65	0.65
225			0.95	0.84	0.77	0.72	0.71	0.68	0.67	0.67	0.66
240			1.00	0.86	0.79	0.73	0.72	0.69	0.68	0.68	0.67
250				0.87	0.80	0.74	0.73	0.70	0.69	0.68	0.68
275				0.91	0.83	0.76	0.75	0.72	0.71	0.70	0.69
280				0.92	0.84	0.77	0.76	0.73	0.71	0.70	0.69
300				0.95	0.86	0.79	0.78	0.74	0.73	0.72	0.71
320				1.00	0.88	0.81	0.80	0.76	0.74	0.73	0.72
350					0.92	0.83	0.82	0.78	0.77	0.75	0.73
400					1.00	0.88	0.87	0.82	0.80	0.78	0.76
440						0.92	0.91	0.85	0.83	0.81	0.79
480						1.00	0.94	0.88	0.86	0.84	0.81
540							1.00	0.93	0.91	0.88	0.84
600								1.00	0.96	0.92	0.88
660									1.00	0.96	0.91
720										1.00	0.95
800											1.00

Effect of Edge Distance - Tension

Edge Distance (mm)	Stud / Rebar Diameter										
	8	10	12	16	20	24	27	30	33	36	40
40	0.64										
50	0.73	0.63									
60	0.82	0.70	0.63								
70	0.90	0.77	0.68								
80	1.00	0.84	0.74	0.63							
90		0.91	0.80	0.67							
100		1.00	0.86	0.71	0.63						
110			0.92	0.76	0.66						
120			1.00	0.80	0.70	0.64					
140				0.89	0.77	0.67	0.63	0.63			
160				1.00	0.84	0.72	0.70	0.65	0.63	0.67	
180					0.91	0.78	0.75	0.70	0.66	0.71	0.68
200					1.00	0.84	0.81	0.76	0.71	0.74	0.71
220						0.89	0.86	0.81	0.75	0.78	0.75
240						1.00	0.92	0.86	0.80	0.82	0.78
270							1.00	0.94	0.87	0.87	0.83
300								1.00	0.94	0.93	0.88
330									1.00	0.98	0.93
360										1.00	0.98
400											1.00

Effect of Edge Distance - Shear

Edge (mm)	Stud / Rebar Diameter										
	8	10	12	16	20	24	27	30	33	36	40
40	0.25										
50	0.44	0.30									
60	0.63	0.48	0.30								
70	0.81	0.65	0.44								
80	1.00	0.83	0.58	0.40							
90		1.00	0.72	0.53							
100			0.86	0.67	0.35						
110			1.00	0.80	0.44						
125				1.00	0.58	0.35					
140					0.72	0.46	0.35	0.30			
160					0.91	0.62	0.51	0.35	0.32	0.33	
180					1.00	0.77	0.63	0.46	0.37	0.43	
200						0.92	0.75	0.57	0.46	0.50	0.32
220						1.00	0.88	0.68	0.56	0.56	0.53
240							1.00	0.78	0.65	0.63	0.59
280								1.00	0.84	0.77	0.72
310									1.00	1.00	0.82
330										1.00	0.89
400											1.00

BIT 500 - Pure Epoxy



Minimum Curing Time

Concrete Temperature	Gel - Working Time	Minimum curing time in dry concrete	Minimum curing time in wet concrete
5°C	120 min	3000 min	x 2
15°C	60 min	1200 min	x 2
25°C	25 min	480 min	x 2
35°C	16 min	240 min	x 2
40°C	10 min	150 min	x 2

- Full cure 24 hours

- All specifications based on supplied mixer

Temperature Ranges

Temperature Range	Concrete Service Temperature	Maximum Long Term Concrete Temp	Maximum Short Term Concrete Temp
Range I	-40°C to +40°C	+24°C	+40°C
Range II	-40°C to +60°C	+43°C	+60°C
Range III	-40°C to +72°C	+43°C	+72°C

Service temperature range: Range of ambient temperatures after installation and during the lifetime of the anchor.

Short term temperature: Temperatures within the service temperature range which vary over short intervals, e.g. day/night cycles and freeze/thaw cycles.

Long term temperature: Temperature, within the service temperature range, which will be approximately constant over significant periods of time.

Long term temperatures will include constant or near constant temperatures, such as those experienced in cold stores or next to heating installations.

Physical Properties

	N/mm ² (MPa)	Test Method
Compressive Strength	120	EN 196 Part 1
Flexural Strength	39	EN 196 Part 1
E Modulus	3420	EN 196 Part 1
Density	1.42 kg/dm ³	-
Shrinkage	< 0.4%	-
VOC Content	A+ Rating	

BIT 500 - Pure Epoxy



Installation parameters: drilling hole cleaning and installation

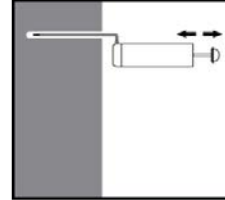
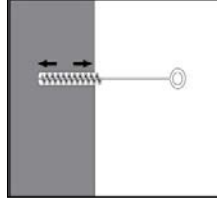
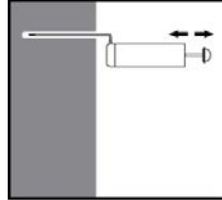
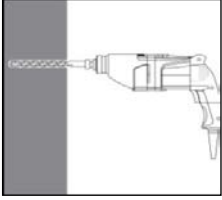

Drill hole in the substrate to the required embedment depth using the appropriately sized carbide drill bit. Bore hole cleaning Just before setting an anchor, the bore hole must be free of dust and debris. The manual pump shall be used for blowing out bore holes up to diameters $d_o \leq 24\text{mm}$ and embedment depths up to $h_{ef} \leq 10d$. Blow out at least 4 times from the back of the bore hole, using an extension if needed. Brush 4 times with the specified brush size (see Table 6) by inserting the steel brush to the back of the hole (if needed with an extension) in a twisting motion and removing it. Blow out again with manual pump at least 4 times.

Compressed air cleaning (CAC) for all bore hole diameters d_o and all bore hole depths

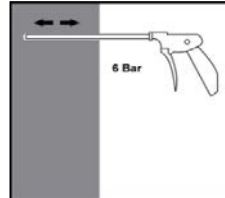
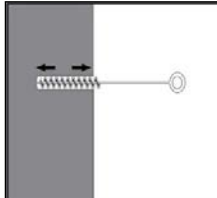
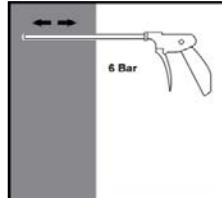

Blow 2 times from the back of the hole (if needed with a nozzle extension) over the whole length with oil-free compressed air (min. 6 bar at $6\text{ m}^3/\text{h}$). Brush 2 times with the specified brush size (see Table 6) by inserting the steel brush to the back of the hole (if needed with an extension) in a twisting motion and removing it.
X 2 Blow out again with compressed air at least 2 times.

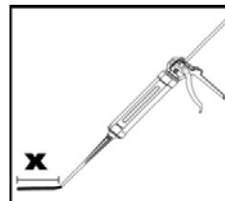
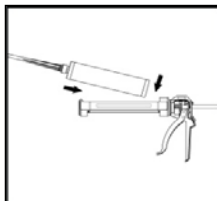
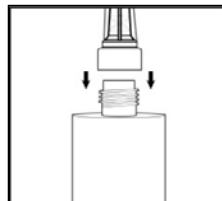
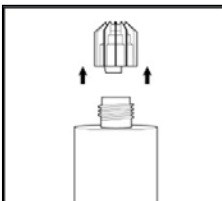

Remove the threaded cap from the cartridge. Tightly attach the mixing nozzle. Do not modify the mixer in any way. Made sure the mixing element is inside the mixer. Use only the supplied mixer. Insert the cartridge into the dispenser gun. Discard the initial trigger pulls of adhesive. Discard the first 10ml of resin.

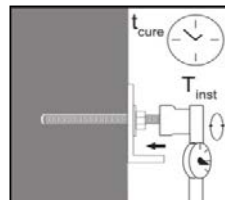
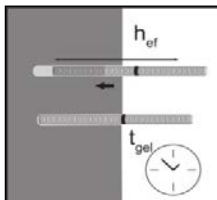
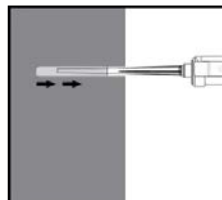

Inject the adhesive starting at the back of the hole, slowly withdrawing the mixer with each trigger pull. Fill holes approximately 2/3 full, to ensure that the annular gap between the anchor and the concrete is completely filled with adhesive along the embedment depth. Before use, verify that the threaded rod is dry and free of contaminants. Install the threaded rod to the required embedment depth during the open gel time t_{gel} has elapsed. The working time t_{gel} is given in Table 7. The anchor can be loaded after the required curing time t_{cure} (see Table 7). The applied torque shall not exceed the values T_{max} given in Table 1.

BIT 500 - Pure Epoxy



Notes

PAGE 2 :

Typical characteristic and design resistance performance with 5.8 grade studding and associated installation data

All data is based on correct installation - see instructions

No influence of edge and spacing

Minimum base material thickness hef +30mm >100mm for M8 to M12 and for M16 to M30 hef +2 d

hef range minimum or 4d whichever is greatest to 20d

Concrete strength C20/25 - f_c cube = 25N/mm² (25MPa)

5.8 grade stud

Temperature range i maximum long term / short term temperature +24/40°C

PAGE 3 :

Design Resistance with various stud strengths, material and rebar.

Note 1 for stainless steel tensile strength is 500N/mm² (500MPa)

Note 2 for stainless steel tensile strength is 700N/mm² (500MPa)

Data shown below the minimum embedment depth is for reference only. Please refer to manufacturer for advice.

PAGE 4 and 6 :

Characteristic and Design Load resistances based on characteristic bond strengths for hef 4d (minimum embedment) to 20d

All data is based on correct installation - see instructions

No influence of edge and spacing

Minimum base material thickness hef +30mm >100mm for M8 to M12 and for M16 to M30 hef +2 d

hef range minimum or 4d whichever is greatest to 20d

Concrete strength C20/25 - f_c cube = 25N/mm² (25MPa)

Temperature range i maximum long term / short term temperature +24/40°C

PAGE 5 & 7 :

Bond Strength Factors

Select concrete strength and environmental condition and apply to bond strength table on page 4

PAGE 8 :

Material Properties for grades of other threaded rod and rebar

All grades shown for information

M30 studding is 8.8 grade instead of 5.8 grade

M30 for A4-70 tensile strength of 500N/mm², (500MPa) instead of 700N/mm² (700MPa)

Safety factor is 1.5 tension and 1.25 shear for all carbon steel

Safety factor is 1.56 for stainless steel, up to M24, M30 and M36 is 2.0

Safety factor is 1.4 tension and 1.5 shear for BSt 500 rebar

Partial Safety Factors Pages 2,3,4,5,6,7:

1.8 for 8mm-16mm rebar and studs

2.1 for 16mm and above rebar and studs