

Write your name here

Surname

BARTON

Other names

MR

Centre Number

--	--	--	--	--

Candidate Number

--	--	--	--	--

Edexcel GCSE

Mathematics A

Paper 2 (Calculator)

Foundation Tier

Monday 4 March 2013 – Morning

Time: 1 hour 45 minutes

Paper Reference

1MA0/2F

You must have: Ruler graduated in centimetres and millimetres, protractor, pair of compasses, pen, HB pencil, eraser, calculator. Tracing paper may be used.

Total Marks



Instructions

- Use **black** ink or ball-point pen.
- **Fill in the boxes** at the top of this page with your name, centre number and candidate number.
- Answer **all** questions.
- Answer the questions in the spaces provided – *there may be more space than you need.*
- **Calculators may be used.**
- If your calculator does not have a π button, take the value of π to be 3.142 unless the question instructs otherwise.

Information

- The total mark for this paper is 100
- The marks for **each** question are shown in brackets – *use this as a guide as to how much time to spend on each question.*
- Questions labelled with an **asterisk** (*) are ones where the quality of your written communication will be assessed.

Advice

- Read each question carefully before you start to answer it.
- Keep an eye on the time.
- Try to answer every question.
- Check your answers if you have time at the end.

Turn over ►

P42058A

©2013 Pearson Education Ltd.

6/7/11/1



P 4 2 0 5 8 A 0 1 3 2

PEARSON

GCSE Mathematics 1MA0

Formulae: Foundation Tier

**You must not write on this formulae page.
Anything you write on this formulae page will gain NO credit.**

Area of trapezium = $\frac{1}{2} (a + b)h$

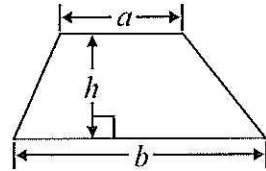

Volume of prism = area of cross section \times length

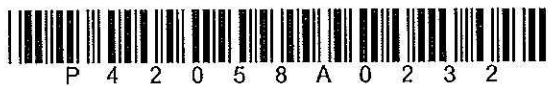
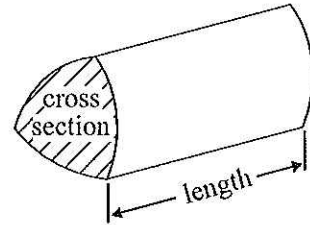

Answer ALL questions.

Write your answers in the spaces provided.

You must write down all stages in your working.

- 1 (a) Write the number seven thousand and twenty five in figures.

7025

(1)

- (b) Write the number 9450 in words.

nine thousand four hundred
and fifty

(1)

- (c) Write the number $28.\overset{+}{5}$ to the nearest whole number.

29

(1)

- (d) Write the number 7380 to the nearest thousand.



7000

(1)

(Total for Question 1 is 4 marks)



P 4 2 0 5 8 A 0 3 3 2

2 Here are some patterns made from triangles.

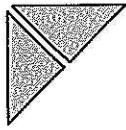

Pattern number
1

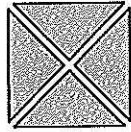

Pattern number
2

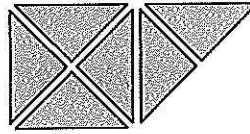

Pattern number
3

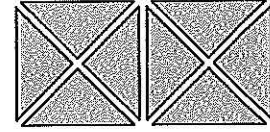

Pattern number
4

(a) Complete the table.

Pattern number	1	2	3	4	5
Number of triangles	2	4	6	8	10

(1)

(b) How many triangles are needed for Pattern number 12?

$$12 \times 2$$

24

(1)

Luke says that Pattern number 40 has 82 triangles.

(c) Luke is wrong.
Explain why.

The number of triangles is

double the pattern number

so there would be 80

(1)

(Total for Question 2 is 3 marks)



3 The diagram shows the temperature in an oven.

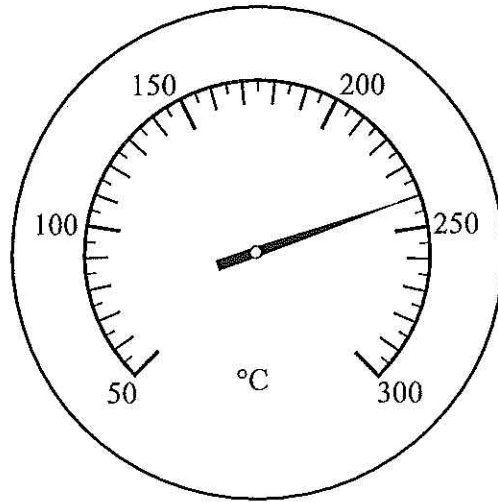

(a) Write down the temperature.

240 °C
(1)

(b) On the diagram below, draw an arrow to show a temperature of 125 °C.

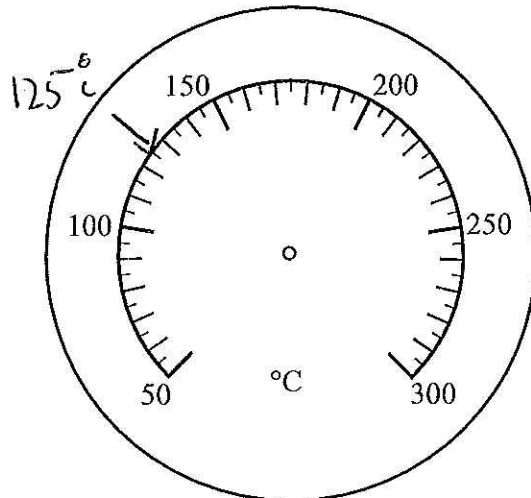

(1)

Lorna switches her oven on at 5.50 pm.

She sets the temperature at 180 °C.

It takes 15 minutes for the oven to reach a temperature of 180 °C.

(c) What time will the oven reach a temperature of 180 °C?

6.05 pm

(1)

(Total for Question 3 is 3 marks)



- 4 The table shows some information about the amounts of time, in minutes, that Dave and Nick spent using their mobile phones on four days last week.

	Time (minutes)	
	Dave	Nick
Thursday	7	6
Friday	6	11
Saturday	17	12
Sunday	28	35

Nick spent less than 10 minutes using his mobile phone on one of these four days.

- (a) Which day?

6 mins

Thursday

(1)

On Sunday Nick spent more time using his mobile phone than Dave.

- (b) How much more time?

$$35 - 28$$

7

minutes

(1)

- *(c) Work out who spent the greater total amount of time using his mobile phone.
You must show all your working.

$$\text{Dave Total} = 7 + 6 + 17 + 28 = 58 \text{ mins}$$

$$\text{Nick Total} = 6 + 11 + 12 + 35 = 64 \text{ mins}$$

Nick spent longer by 6 mins

(3)

(Total for Question 4 is 5 marks)



5 Here is a shape.

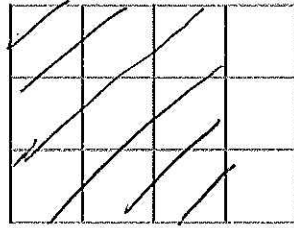

9 squares

Shade $\frac{3}{4}$ of this shape.

$\frac{1}{4}$ $\frac{1}{4}$ $\frac{1}{4}$

(Total for Question 5 is 1 mark)

- 6 72 people are on a bus.
15 people get off the bus.
9 people get on the bus.

How many people are now on the bus?

$$72 - 15 = 57$$

$$57 + 9 = 66$$

66 people

(Total for Question 6 is 2 marks)



7 Mrs Clark shares £20 between Sally, Bethan, Robert and Tom.

Mrs Clark gives £6.65 to Sally.

She shares the rest of the money equally between Bethan, Robert and Tom.

How much money does Mrs Clark give to Bethan?

$$20 - 6.65 = \pounds 13.35$$

$$13.35 \div 3 = \pounds 4.45$$

£ 4.45

(Total for Question 7 is 3 marks)



8 Here are the test marks for the students in Mrs Potter's maths class.

28 36 25 43 18 39 30
 36 27 31 33 14 22 36
 23 12 38 36 40 45 27

(a) Complete the frequency table for these marks.

Mark	Tally	Frequency
10 – 19		3
20 – 29		6
30 – 39		9
40 – 49		3

(3)

(b) Work out the number of these students getting less than 20 marks.

3

(1)

(Total for Question 8 is 4 marks)



- 9 Draw a circle of radius 5 cm.
Use the cross (×) as the centre of your circle.



(Total for Question 9 is 1 mark)



10 Here is a list of numbers.

5 15 30 50 60 90 100 125

From the numbers in the list, write down

(i) two different numbers that add up to an even number

$$5 + 15 = 30$$

(ii) a multiple of 20

$$60 \quad (20 \times 3)$$

(iii) a factor of 45

$$15 \quad (45 = 15 \times 3)$$

(iv) a cube number

$$125 \quad (5 \times 5 \times 5)$$

(Total for Question 10 is 4 marks)



11 George is going to buy exactly 10 ink cartridges.

Ink Cartridges

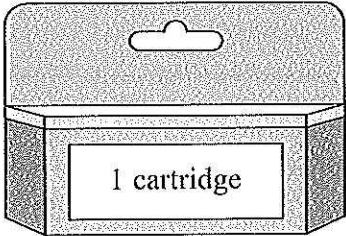

£9.39 per cartridge

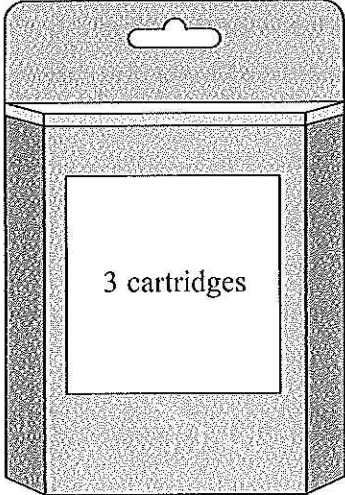

£24.30 for a pack of 3 cartridges

Find the difference in cost between the cheapest way and the most expensive way to buy the 10 ink cartridges.

1 cartridge

$$£9.39 \times 10 = £93.90$$

3 cartridge

$$£24.30 \times 3 = £72.90$$

$$\text{Need 1 more} = £9.39 +$$

$$\underline{\underline{82.29}}$$

$$\text{Difference} = 93.90 - 82.29$$

$$= £11.61$$

(Total for Question 11 is 5 marks)



12 These shapes have been drawn on a grid of centimetre squares.

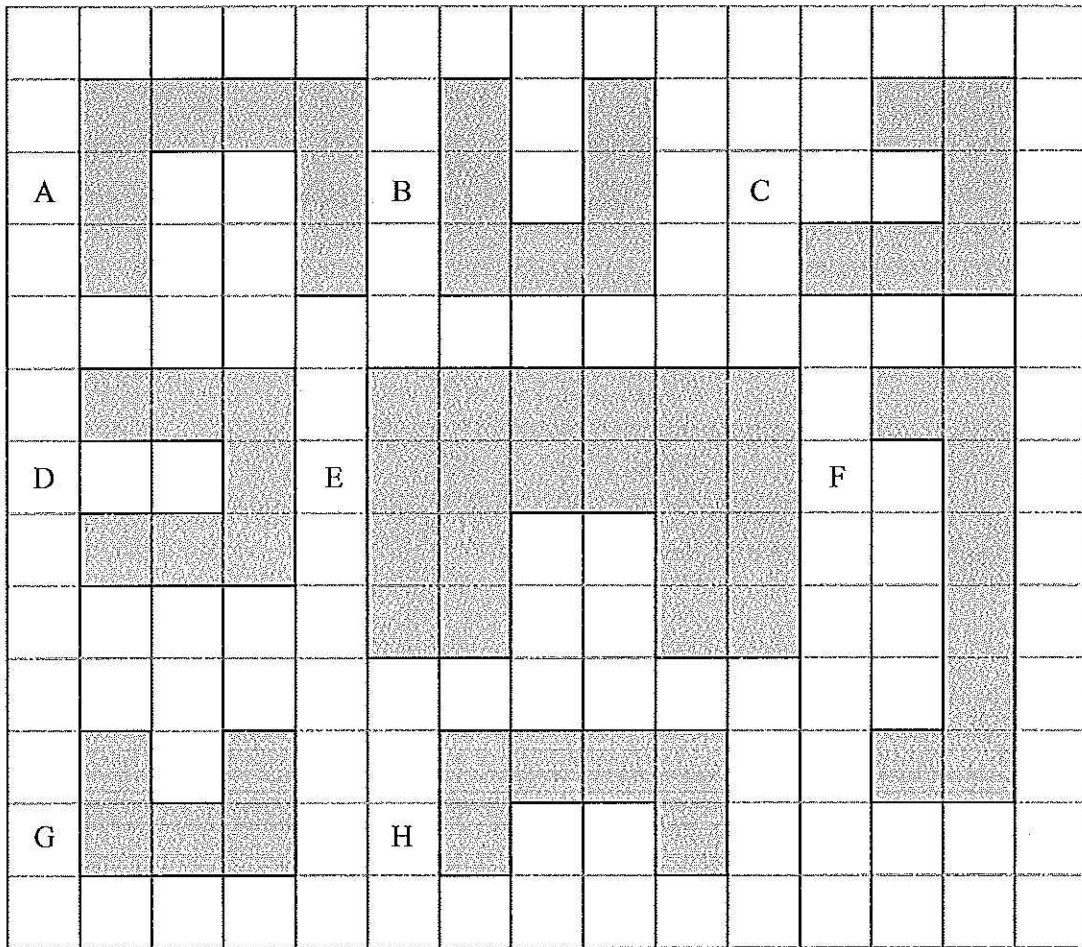

(a) (i) Write down the letters of a pair of shapes that are congruent. \rightarrow Same shape

..... B and D

(ii) Write down the letters of a different pair of shapes that are similar. \rightarrow enlargement

..... G and E

(2)

(b) Find the perimeter of shape D.

..... 16 cm

(1)

(Total for Question 12 is 3 marks)



P 4 2 0 5 8 A 0 1 3 3 2

13 The table shows the temperature every four hours one day in December.

Time	Temperature
2 am	6 °C
6 am	-4 °C
10 am	-2 °C
2 pm	8 °C
6 pm	5 °C
10 pm	-1 °C

(a) Write down the time with the lowest temperature.

-4 °C

6 am
(1)

(b) Work out the difference between the temperature at 2 pm and the temperature at 6 pm.

8 - 5

3 °C
(1)

Between 10 pm and midnight the temperature goes down 5 °C.

(c) Work out the temperature at midnight.

-1 - 5

-6 °C
(2)

(Total for Question 13 is 4 marks)



*14 A factory makes yoghurt in a tank.

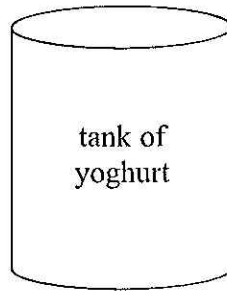

Here are the weights of the ingredients needed to make a tank full of yoghurt.

Milk	80 kg
Skimmed milk powder	2 kg
Sugar	3 kg
Stabiliser	1 kg
Fruit	10 kg

The yoghurt from the tank is put into pots.
Each 1 kg of the yoghurt is used to fill 8 pots.

Is there enough yoghurt in the tank to fill 750 pots?
You must show all your working.

$$\begin{aligned} \text{Total weight of ingredients} \\ = 80 + 2 + 3 + 1 + 10 = 96 \text{ kg} \end{aligned}$$

$$\text{Total pots} = 96 \times 8 = 768$$

We can make 768 pots, so

YES there is enough yoghurt to

make 750

(Total for Question 14 is 4 marks)



- 15 The two-way table shows some information about the numbers of boys, girls and teachers at three schools.

	School A	School B	School C	Total
Boys	85	29	54	168
Girls	93	31	47	171
Teachers	13	5	9	27
Total	191	65	110	366

Complete the two-way table.

$$85 + 29 + 54 = 168$$

$$191 - 85 - 13 = 93$$

$$366 - 171 - 168 = 27$$

$$27 - 13 - 5 = 9$$

$$29 + 31 + 5 = 65$$

$$366 - 65 - 191 = 110$$

(Total for Question 15 is 3 marks)



16 The diagram shows a pyramid.

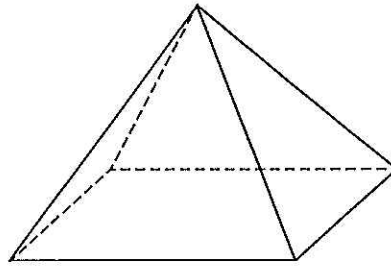

(a) Write down the number of

(i) faces,

5

(ii) edges,

8

(iii) vertices. *corners*

5

(3)

The base of the pyramid is a square.

(b) In the space below, draw a sketch of a net for this pyramid.

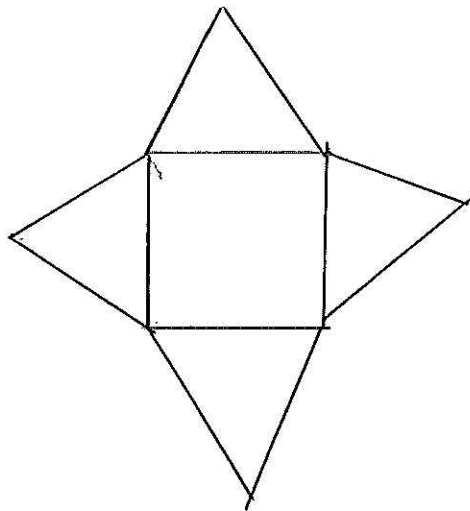

(2)

(Total for Question 16 is 5 marks)



P 4 2 0 5 8 A 0 1 7 3 2

17 (a) (i) Work out $3.2^2 + \sqrt{7.5}$

Write down all the figures from your calculator display.

12.97861279

(ii) Write your answer to (a)(i) correct to 2 significant figures.

12.978

13

(2)

(b) Work out the value of 10^5

100,000

(1)

(Total for Question 17 is 3 marks)

18 $f = 8$

(a) Work out the value of $2f + 7$

$$f = 2 \times (8) + 7$$

23

(2)

$$T = 3g + 5h$$

$$g = -2$$

$$h = 4$$

(b) Work out the value of T .

$$T = 3 \times (-2) + 5 \times (4)$$

14

(2)

(Total for Question 18 is 4 marks)



19 The pie chart shows some information about the time Gill spent working in her garden one month.

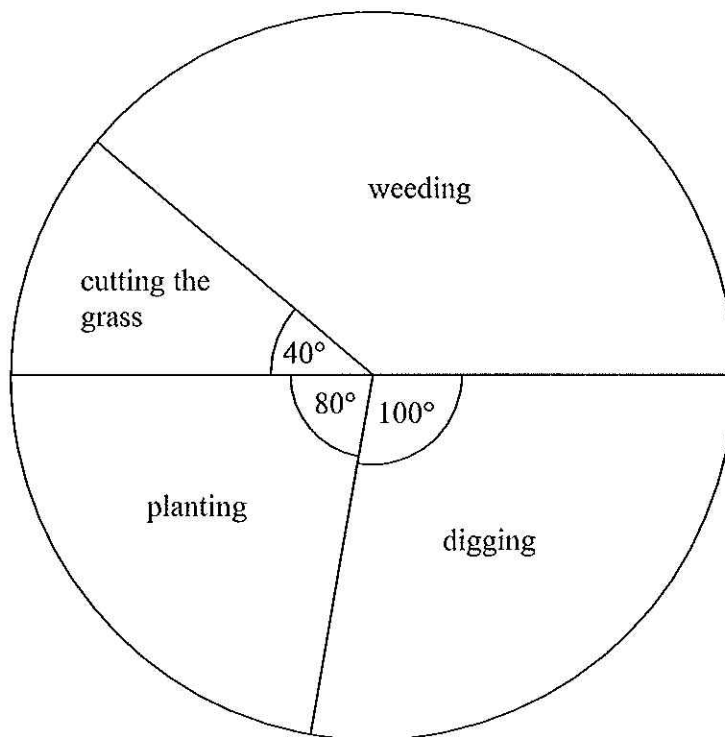

(a) What fraction of the time did Gill spend cutting the grass?

$$\begin{array}{l} \text{Total} \\ \text{degrees} \end{array} \rightarrow \frac{40}{360} = \frac{1}{9}$$

(1)

Gill spent 7 hours weeding.

(b) How much time did Gill spend planting?

$$\begin{aligned} \text{Degrees for weeding} &= 360 - 100 - 80 - 40 \\ &= 140^\circ \end{aligned}$$

$$\begin{array}{l} \text{so } \div 7 \quad \left\{ \begin{array}{l} 140^\circ = 7 \text{ hours} \\ 20^\circ = 1 \text{ hour} \end{array} \right. \quad \downarrow \div 7 \\ \times 4 \quad \left\{ \begin{array}{l} 80^\circ = 4 \text{ hours} \end{array} \right. \quad \downarrow \times 4 \end{array}$$

4 hours
(3)

(Total for Question 19 is 4 marks)



20 The diagram shows the positions of two villages, Beckhampton (*B*) and West Kennett (*W*).

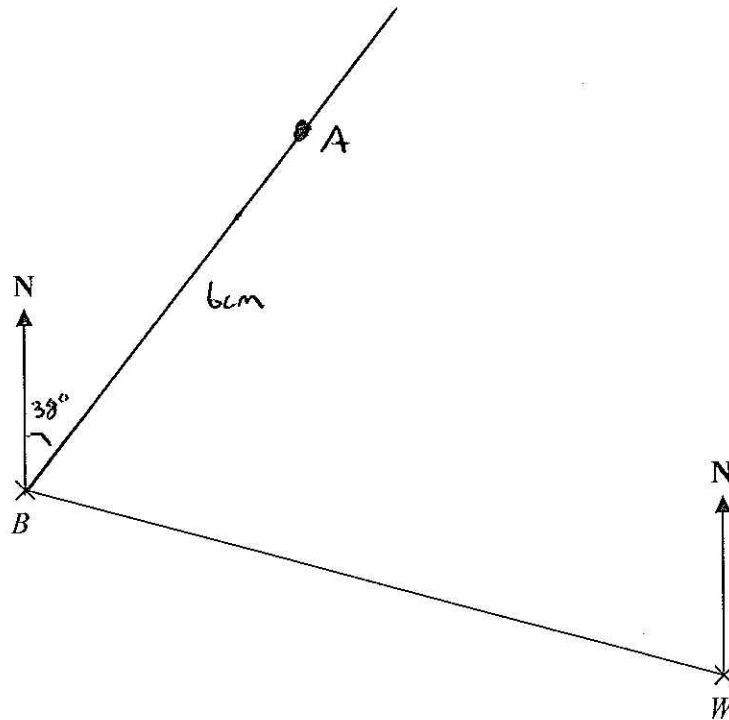

Scale: 4 cm represents 1 km.

(a) Work out the real distance, in km, of Beckhampton from West Kennett.

$$10 \text{ cm} \div 4$$

$$\frac{2.5}{(2)} \text{ km}$$

The village, Avebury (*A*), is on a bearing of 038° from Beckhampton.

On the diagram, *A* is 6 cm from *B*.

(b) On the diagram, mark *A* with a cross (\times).
Label the cross *A*.

(2)

(Total for Question 20 is 4 marks)



21 Simon went for a cycle ride.
He left home at 2 pm.

The travel graph represents part of Simon's cycle ride.

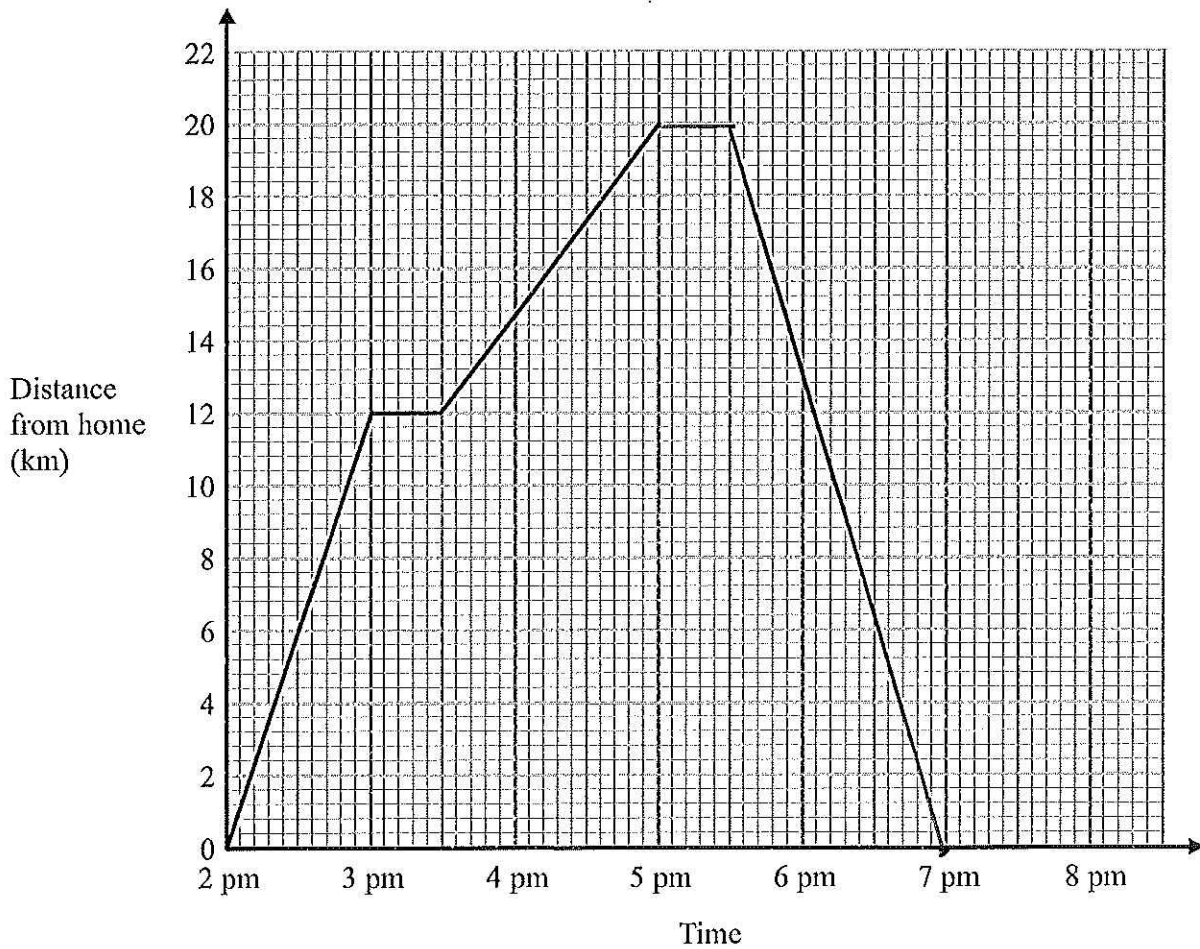

At 3 pm Simon stopped for a rest.

(a) How many minutes did he rest?

FLAT
LINE

30 minutes
(1)

(b) How far was Simon from home at 5 pm?

20 km
(1)

At 5 pm Simon stopped for 30 minutes.

5.30 pm

Then he cycled home at a steady speed.

It took him 1 hour 30 minutes to get home.

7 pm

(c) Complete the travel graph.

(2)

(Total for Question 21 is 4 marks)



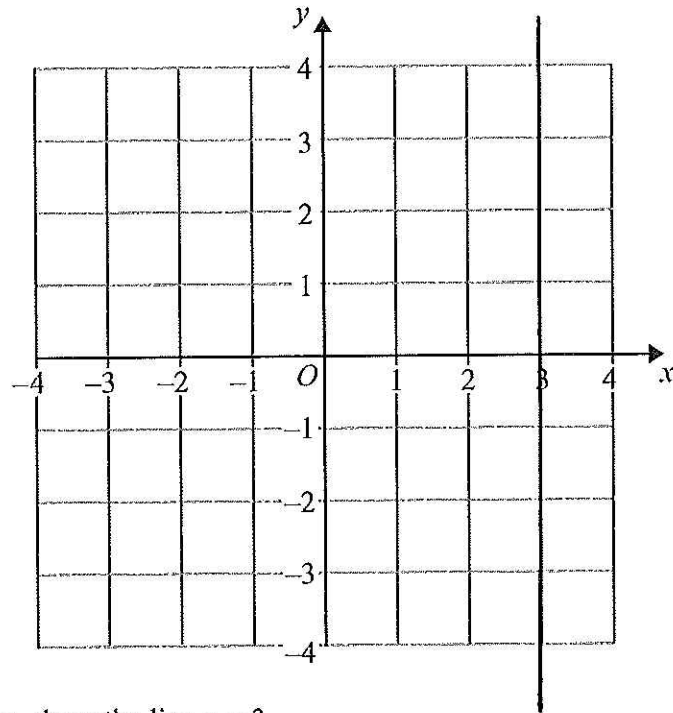

(a) On the grid above, draw the line $x = 3$

(1)

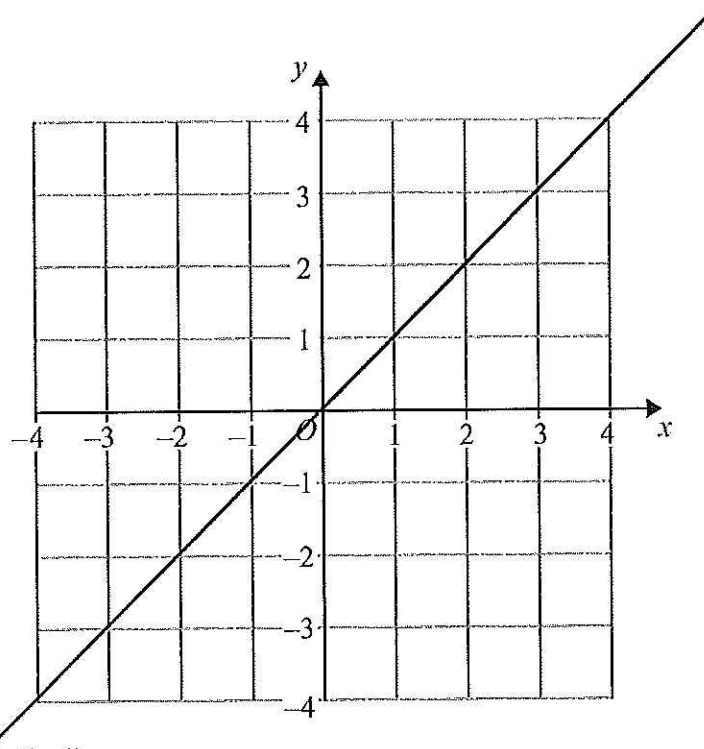

(b) On this grid, draw the line $y = x$

(1)



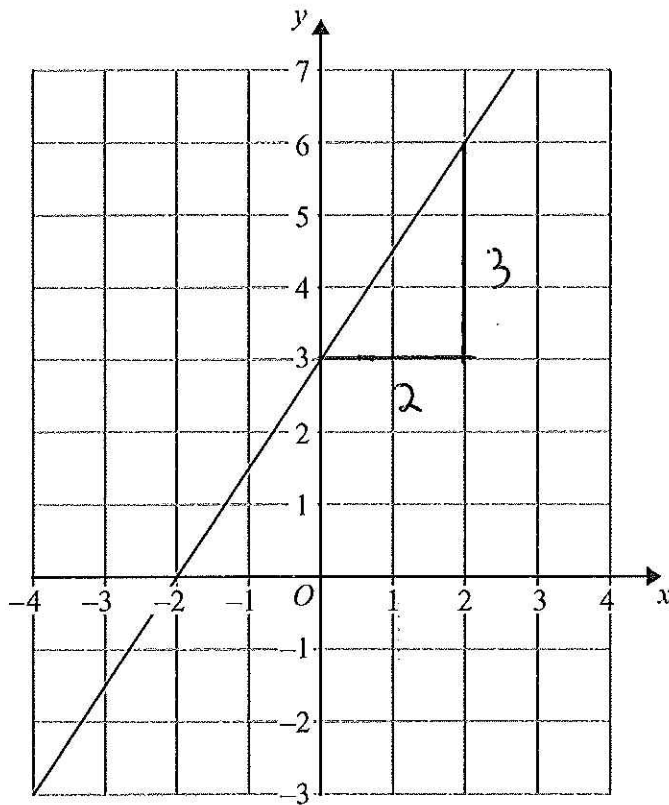

(c) Find the gradient of the straight line drawn on this grid.

$$3 \div 2 = 1.5$$

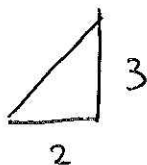

1.5

(2)

(Total for Question 22 is 4 marks)



P 4 2 0 5 8 A 0 2 3 3 2

23 (a) Simplify $n^5 \times n^3$

Add powers

$$n^8$$

(1)

(b) Simplify $n^7 \div n^2$

Subtract powers

$$n^5$$

(1)

(Total for Question 23 is 2 marks)



24 Peter goes for a walk.
He walks 15 miles in 6 hours.

- (a) Work out Peter's average speed.
Give your answer in miles per hour.

$$\text{Speed} = \frac{\text{Dist}}{\text{Time}} = \frac{15}{6}$$

$$15 \div 6$$

$$\underline{2.5} \text{ mph}$$

(2)

5 miles = 8 km.
Sunita says that Peter walked more than 20 km.

- *(b) Is Sunita right?
You must show all your working.

$$\begin{array}{l} \times 3 \quad \downarrow \quad 5 \text{ miles} = 8 \text{ km} \quad \downarrow \quad \times 3 \\ \quad \quad \quad 15 \text{ miles} = 24 \text{ km} \end{array}$$

Yes Sunita is right as
Peter walked 24 km

(2)

(Total for Question 24 is 4 marks)



25 Mr Watkins needs to buy some oil for his central heating.

Mr Watkins can put up to 1500 litres of oil in his oil tank.

There are already 850 litres of oil in the tank.

Mr Watkins is going to fill the tank with oil.

The price of oil is 67.2p per litre.

Mr Watkins gets 5% off the price of the oil.

How much does Mr Watkins pay for the oil he needs to buy?

$$\begin{aligned} \text{To fill tank he needs } & 1500 - 850 \\ & = 650 \text{ litres of oil} \end{aligned}$$

$$\text{Price of oil} = 67.2\text{p}$$

$$\begin{aligned} 5\% \text{ of } 67.2\text{p} &= 67.2 \times 0.05 \\ &= 3.36\text{p} \end{aligned}$$

$$\begin{aligned} \text{Price he pays} &= 67.2 - 3.36 \\ &= 63.84\text{p} \end{aligned}$$

$$\begin{aligned} \text{Total he pays} &= 63.84 \times 650 \\ &= 41,496\text{p} \\ &= \pounds 414.96 \end{aligned}$$

£.....

(Total for Question 25 is 5 marks)



- 26 Here is a four sided spinner.
The spinner is biased.

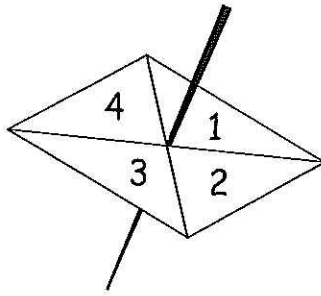

The table shows the probabilities that the spinner will land on 1 or on 3

Number	1	2	3	4
Probability	0.2		0.1	

The probability that the spinner will land on 2 is the same as the probability that the spinner will land on 4

- (a) Work out the probability that the spinner will land on 4

$$\text{Total prob} = 1$$

$$\text{Missing prob} = 1 - 0.2 - 0.1 = 0.7$$

Same prob for each

$$\text{So } 0.7 \div 2 = \textcircled{0.35} \quad \dots\dots\dots (3)$$

Shunya is going to spin the spinner 200 times.

- (b) Work out an estimate for the number of times the spinner will land on 3

$$200 \times 0.1 = 20 \text{ times}$$

.....
(2)

(Total for Question 26 is 5 marks)



27 (a) Expand $3(x + 4)$

$$3x + 12$$

.....
(1)

(b) Expand $x(x^2 + 2)$

$$x^3 + 2x$$

.....
(2)

(c) Factorise $x^2 - 6x$

$$x(x - 6)$$

.....
(1)

(Total for Question 27 is 4 marks)



28 Here is a solid prism.

Diagram NOT accurately drawn

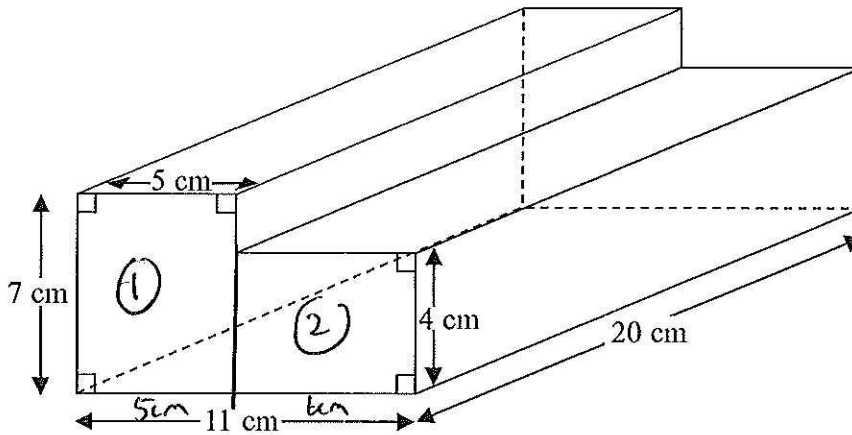

Work out the volume of the prism.

Area of face

$$\textcircled{1} \quad 7 \times 5 = 35 \text{ cm}^2$$

$$\textcircled{2} \quad 6 \times 4 = 24 \text{ cm}^2$$
$$\underline{\quad 59 \text{ cm}^2}$$

$$\text{Volume} = 59 \times 20$$
$$= 1180 \text{ cm}^3$$

..... cm³

(Total for Question 28 is 3 marks)

TOTAL FOR PAPER IS 100 MARKS



BLANK PAGE

