

# GCSE Mathematics

## Practice Tests: Set 1

### Paper 1F (Non-calculator)

Time: 1 hour 30 minutes

You should have: Ruler graduated in centimetres and millimetres, protractor, pair of compasses, pen, HB pencil, eraser.

#### Instructions

- Use **black** ink or ball-point pen.
- **Fill in the boxes** at the top of this page with your name, centre number and candidate number.
- Answer **all** questions.
- Answer the questions in the spaces provided  
– *there may be more space than you need.*
- **Calculators must not be used.**
- Diagrams are NOT accurately drawn, unless otherwise indicated.
- You must **show all your working out.**



#### Information

- The total mark for this paper is 80
- The marks for **each** question are shown in brackets  
– *use this as a guide as to how much time to spend on each question.*

#### Advice

- Read each question carefully before you start to answer it.
- Keep an eye on the time.
- Try to answer every question.
- Check your answers if you have time at the end.

#### Practice Tests: Set 1 Regular (1F) – Version 1.0

This publication may only be reproduced in accordance with Pearson Education Limited copyright policy.  
©2016 Pearson Education Limited.

**Answer ALL questions.**

**Write your answers in the spaces provided.**

**You must write down all the stages in your working.**

1. Write these numbers in order of size.  
Start with the smallest number.

6      -3      9      -5      4

.....

**(Total 1 mark)**

---

2. Change 430 centimetres into metres.

..... metres

**(Total 1 mark)**

---

3. Change 0.3 into a fraction.

.....

**(Total 1 mark)**

---

4. Change 0.7 into a percentage.

..... %

**(Total 1 mark)**

---

5.

Diagram **NOT**  
accurately drawn

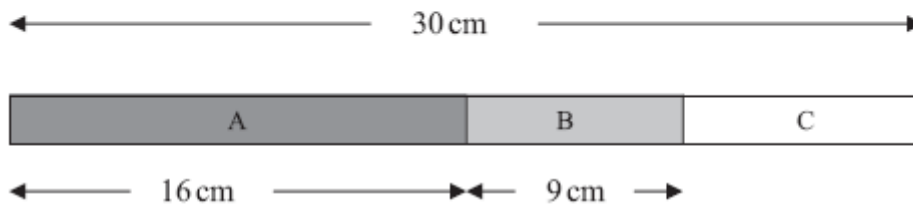

Here is a picture of a stick.  
The stick is in three parts, A, B and C.

The total length of the stick is 30 cm.  
The length of part A is 16 cm.  
The length of part B is 9 cm.

Work out the length of part C.

..... cm

**(Total 2 marks)**

6. Jessica thinks of a number.

She multiplies the number by 3.  
She then subtracts 7.  
Her answer is 5.

What number did Jessica think of?

.....

**(Total 2 marks)**

7. The total cost of these 2 pens is 60p.



Work out the total cost of 5 of these pens.

Give your answer in pounds.

£ .....

**(Total 3 marks)**

---

8. Ann works in a sandwich shop.

The dual bar chart shows information about the sandwiches sold.

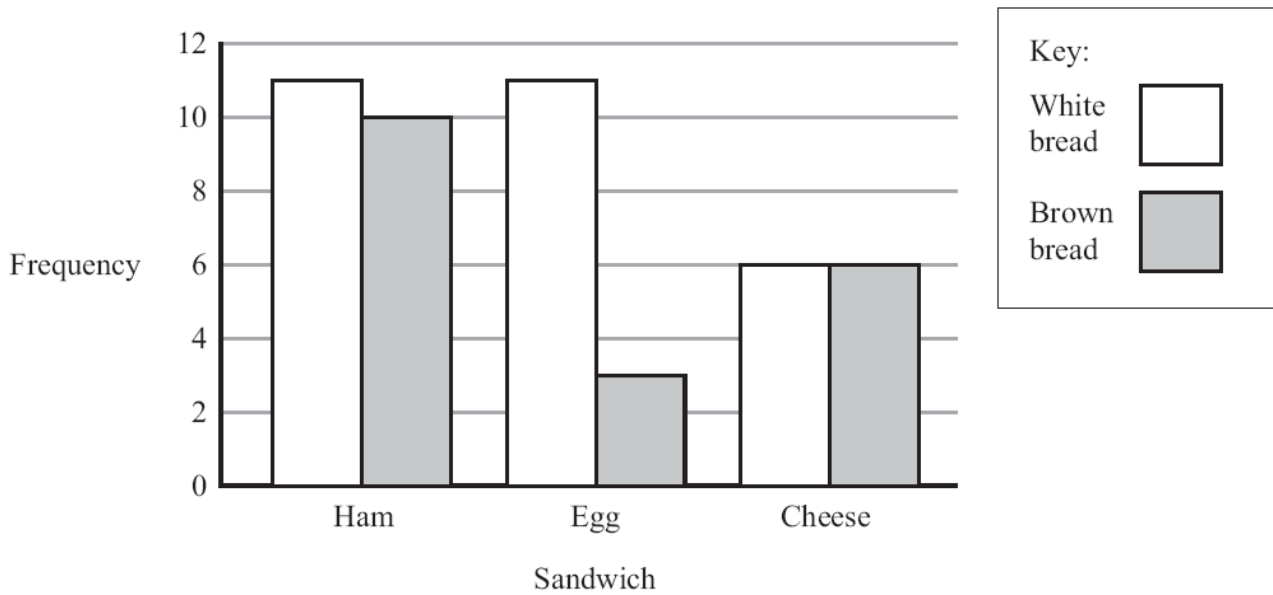

(a) Write down the total number of cheese sandwiches sold.

.....  
**(1)**

More white bread sandwiches were sold than brown bread sandwiches.

(b) Work out how many more white bread sandwiches.

.....  
**(2)**

**(Total 3 marks)**

9. James has 9 cards.  
 Each card has a shape drawn on it.  
 Each shape is a circle or a square or a triangle.

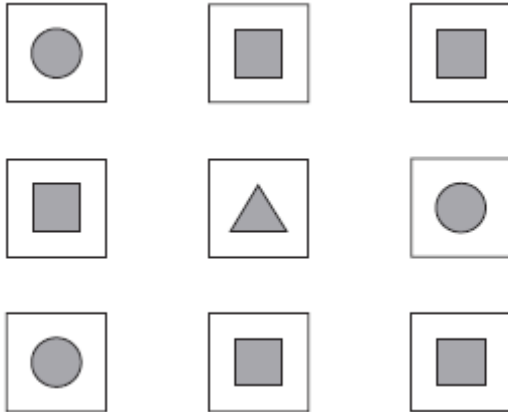

James takes a card at random.

- (i) Which shape is **most** likely to be on the card?

.....

- (ii) What is the probability that James takes a card that has a square on it?

.....

**(Total 3 marks)**

10. David is going to buy a cooker.  
 The cooker has a price of £320.  
 David pays a deposit of 15% of the price of the cooker.

How much money does David pay as a deposit?

£.....

**(Total 2 marks)**

11. (a) Solve  $x + 3 = 12$

$x = \dots\dots\dots$   
(1)

(b) Solve  $\frac{y}{5} = 10$

$y = \dots\dots\dots$   
(1)

**(Total 2 marks)**

---

12. Here is a menu in a café.

| Menu    |             |
|---------|-------------|
| Starter | Main Course |
| Soup    | Chicken     |
| Melon   | Fish        |
|         | Omelette    |

A meal is a starter and a main course.  
One possible meal is Soup and Chicken, (S, C).

Charlie wants to choose a meal.

- (a) Make a list of all the different meals she can have.  
One has been done for you.

(S, C) .....

.....

**(2)**

A meal is chosen at random.

- (b) What is the probability that the meal will be Melon and Chicken?

.....

**(1)**

The café adds fruit juice as another starter.

Charlie says ‘Now there will be one more meal to choose from’.

- (c) Show that Charlie is wrong.

.....

.....

**(1)**

**(Total 4 marks)**



13. The diagram shows a rectangle and a square.

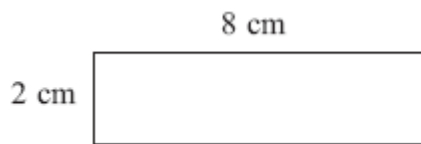

Diagram **NOT**  
accurately drawn

The perimeter of the rectangle is the same as the perimeter of the square.

Work out the length of one side of the square.

..... cm

**(Total 4 marks)**

14. (a) Write 8 45 p.m. as a 24-hour clock time.

.....  
(1)

Seeta did a puzzle in 3 minutes 45 seconds.  
Ninal did the same puzzle in 7 minutes 28 seconds.

Seeta says,

‘I did the puzzle in less than half the time Ninal did the puzzle.’

- (b) Is Seeta right?  
You must show all your working.

(3)

(Total 4 marks)

---

15. Work out  $\frac{3}{4} + \frac{1}{8}$

Give your answer in its simplest form.

.....  
(Total 2 marks)

---

16. Write these numbers in order of size.  
Start with the smallest number.

0.6       $\frac{2}{3}$       65%      0.606

.....  
**(Total 2 marks)**

---

17. One kilogram of cheese costs £5.60.  
Jane buys 200 g of cheese.

Work out how much Jane pays.

£.....

**(Total 3 marks)**

---

18. Mr Brown and his 2 children are going to London by train.

An adult ticket costs £24.

A child ticket costs £12.

Mr Brown has a Family Railcard.

**Family Railcard gives**

$\frac{1}{3}$  off adult tickets

60% off child tickets

Work out the total cost of the tickets when Mr Brown uses his Family Railcard.

£.....

**(Total 4 marks)**

---

**19.** Work out  $4.52 \times 36$

.....  
**(Total 3 marks)**

---

20. On the grid, draw the graph of  $y = 3x + 2$  for values of  $x$  from  $-2$  to  $2$ .

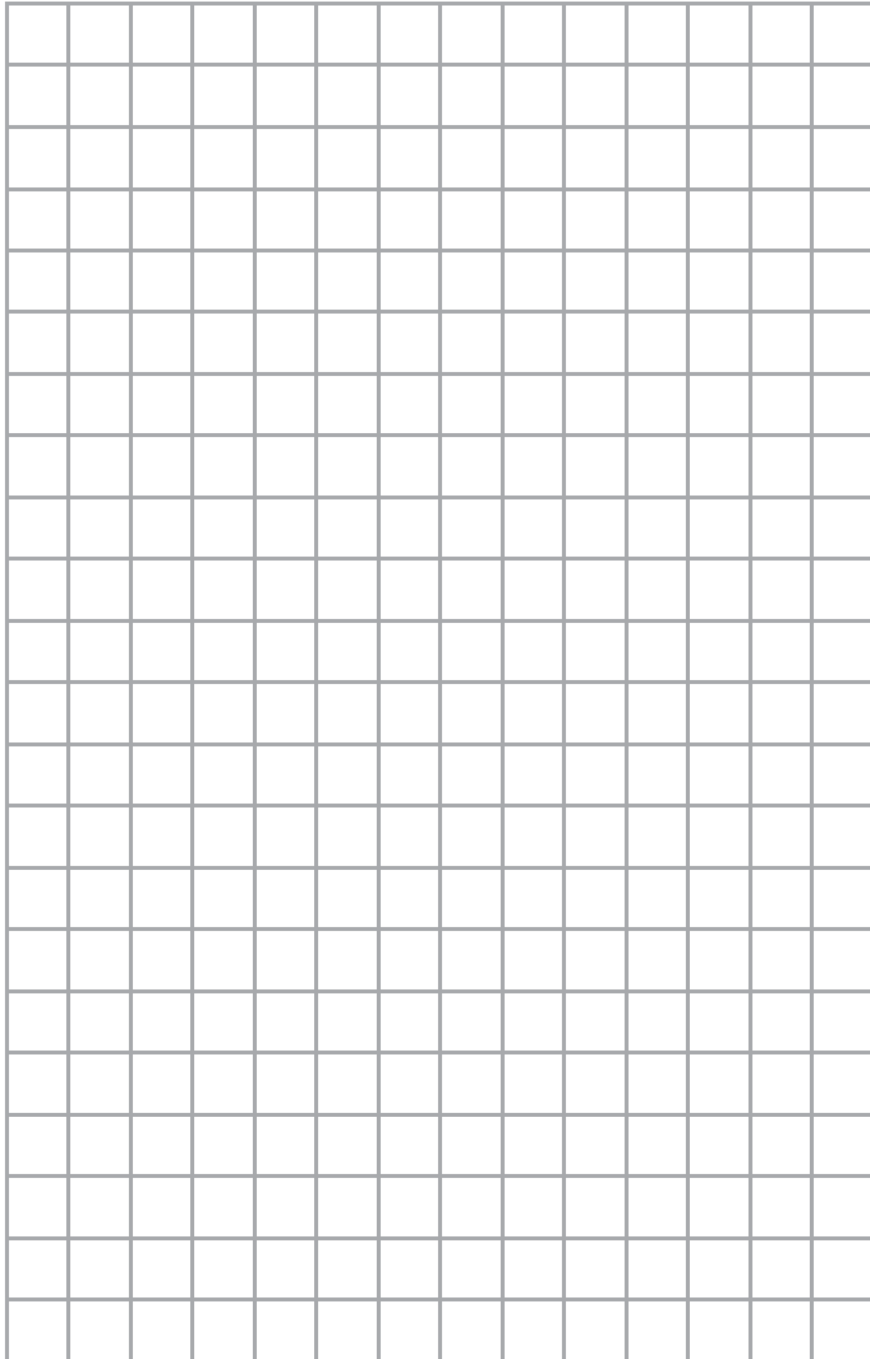

**(Total 4 marks)**

21.

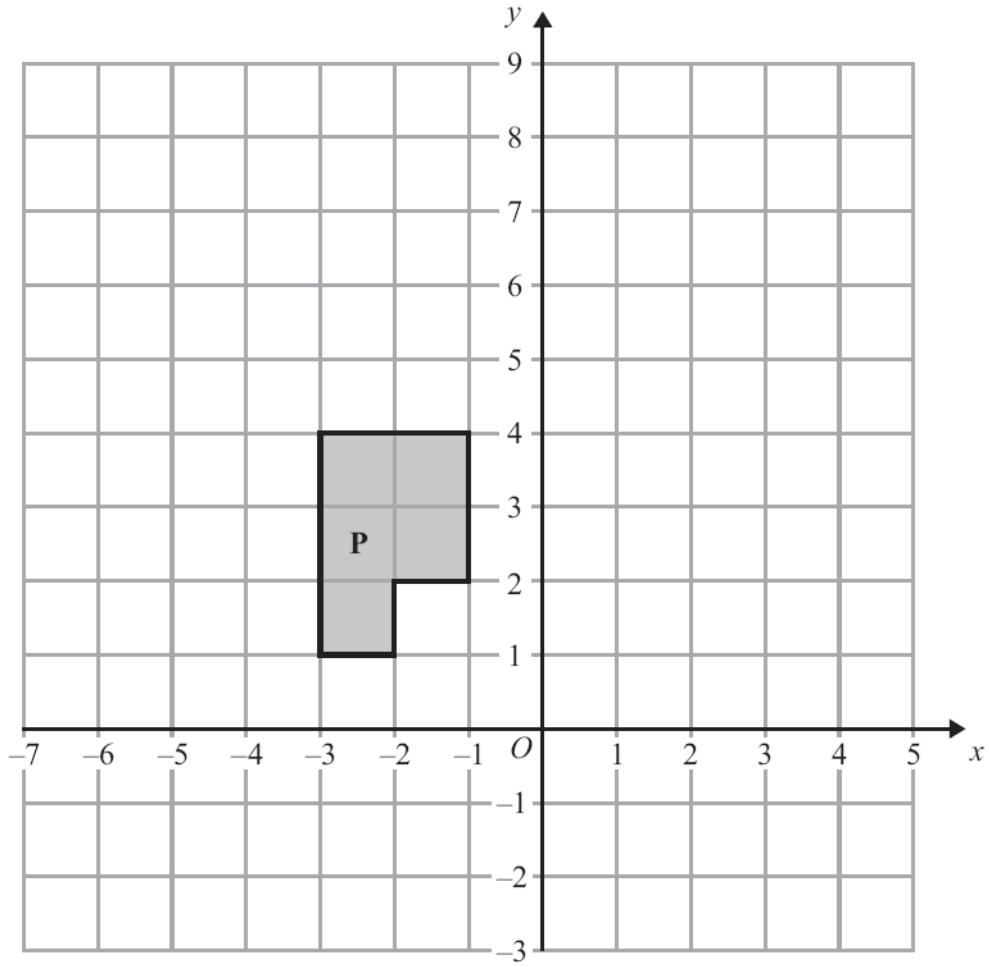

(a) Translate shape P by the vector  $\begin{pmatrix} 5 \\ -2 \end{pmatrix}$ .

(2)

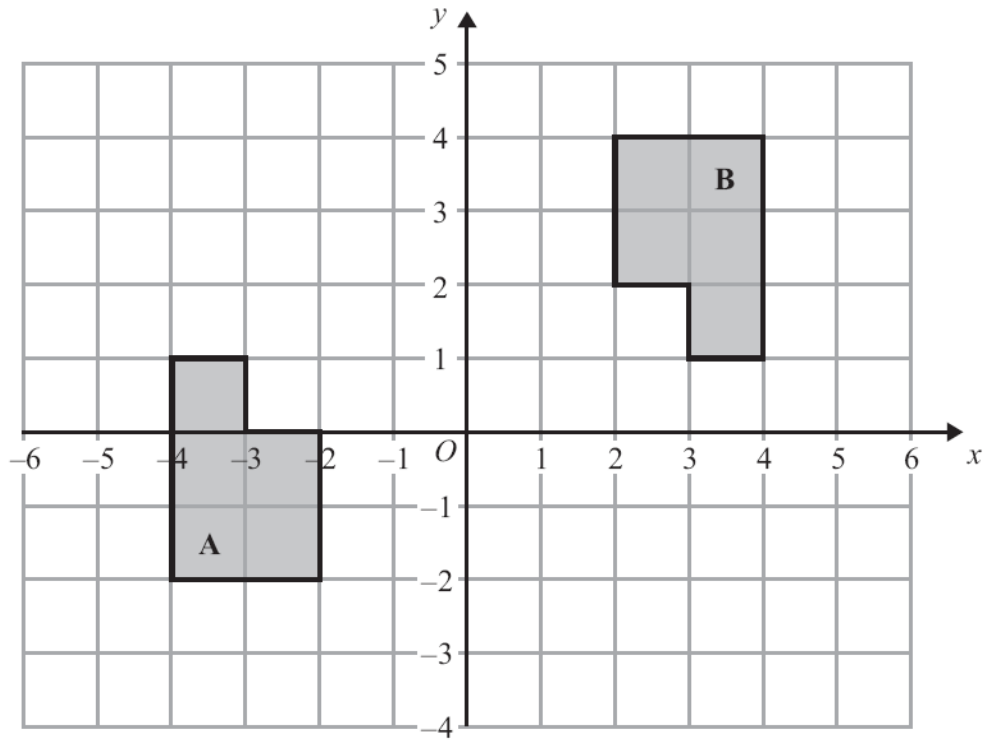

(b) Describe fully the single transformation that maps shape **A** onto shape **B**.

.....  
 .....

(3)

**(Total 5 marks)**

22. (a) Simplify  $\frac{(x+2)^2}{x+2}$

.....  
 (1)

(b) Simplify  $2a^2b \times 3a^3b$

.....  
 (2)

**(Total 3 marks)**



- 23.** Talil is going to make some concrete mix.  
He needs to mix cement, sand and gravel in the ratio 1 : 3 : 5 by weight.

Talil wants to make 180 kg of concrete mix.

Talil has

15 kg of cement

85 kg of sand

100 kg of gravel

Does Talil have enough cement, sand and gravel to make the concrete mix?

**(Total 4 marks)**

---

- 24.** The height,  $H$  cm, of a table is measured as 72 cm correct to the nearest centimetre.

Complete the following statement to show the range of possible values of  $H$ .

.....  $\leq H <$  .....

**(Total 2 marks)**

---



25. Bill uses his van to deliver parcels.  
For each parcel Bill delivers there is a fixed charge plus £1.00 for each mile.

You can use the graph to find the total cost of having a parcel delivered by Bill.

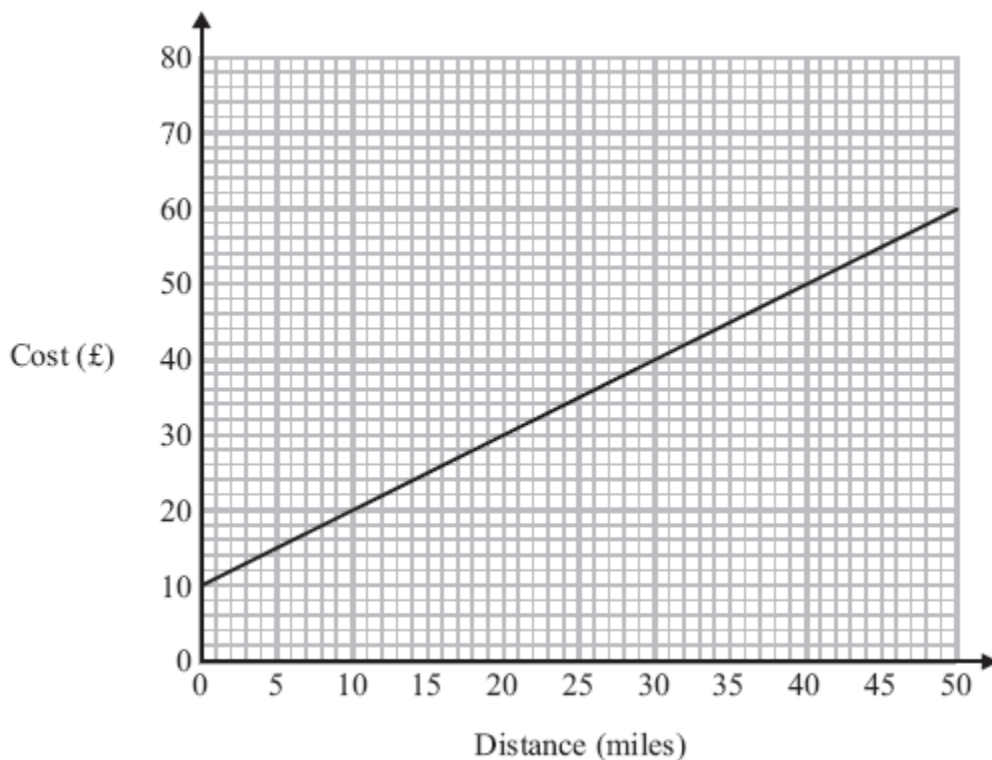

- (a) How much is the fixed charge?

£ .....  
(1)

Ed uses a van to deliver parcels.  
For each parcel Ed delivers it costs £1.50 for each mile.  
There is **no** fixed charge.

- (b) Compare the cost of having a parcel delivered by Bill with the cost of having a parcel delivered by Ed.

(3)

(Total 4 marks)

26. Sasha carried out a survey of 60 students.  
She asked them how many CDs they each have.

This table shows information about the numbers of CDs these students have.

| Number of CDs | 0 – 4 | 5 – 9 | 10 – 14 | 15 – 19 | 20 – 24 |
|---------------|-------|-------|---------|---------|---------|
| Frequency     | 8     | 11    | 9       | 14      | 18      |

- (a) Write down the class interval containing the median.

.....  
**(1)**

- (b) On the grid, draw a frequency polygon to show the information given in the table.

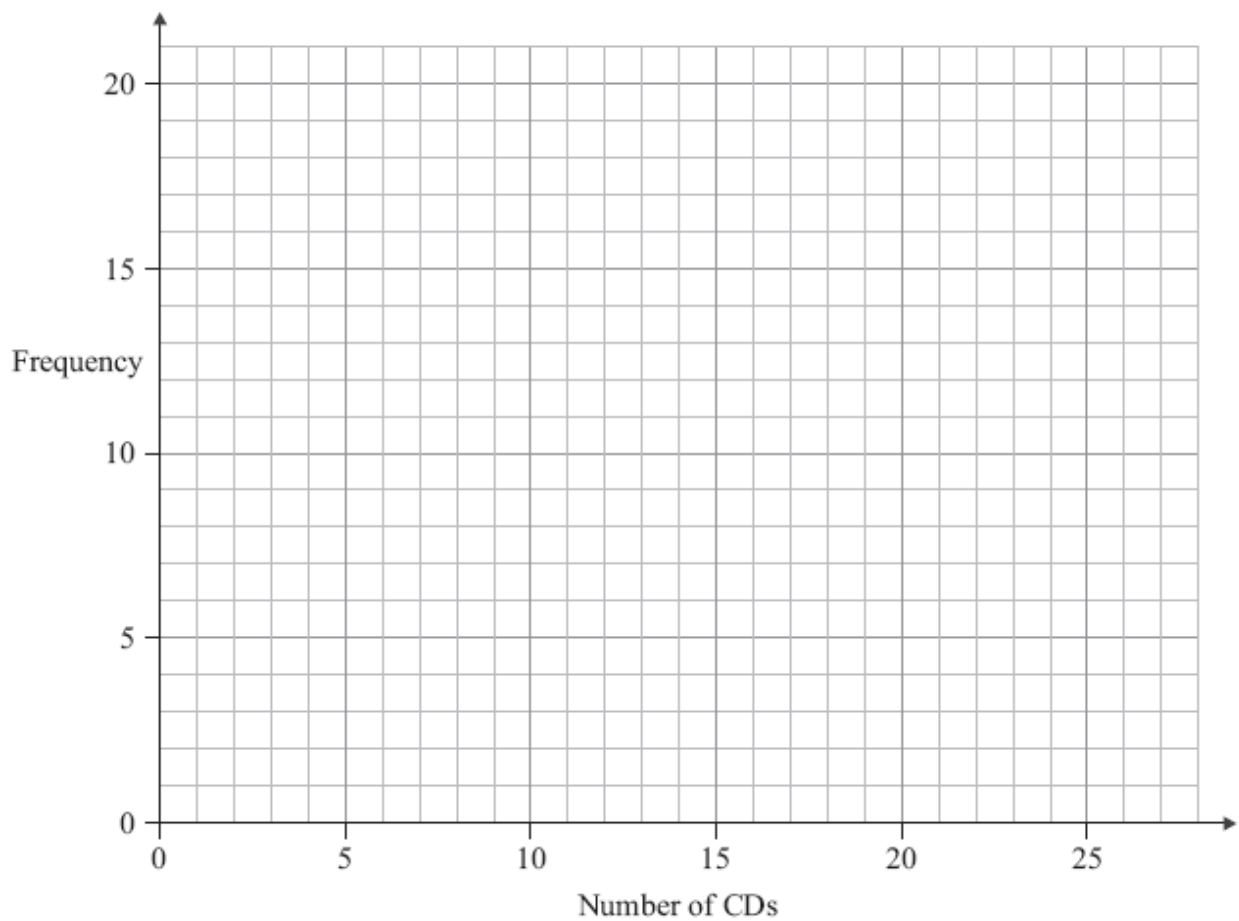

**(2)**

**(Total 3 marks)**

27. Jane has a carton of orange juice.  
The carton is in the shape of a cuboid.

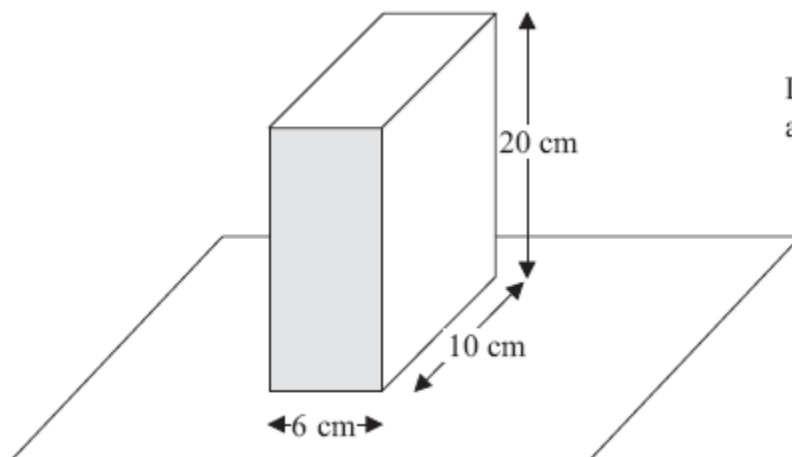

Diagram **NOT**  
accurately drawn

The depth of the orange juice in the carton is 8 cm.

Jane closes the carton.

Then she turns the carton over so that it stands on the shaded face.

Work out the depth, in cm, of the orange juice now.

..... cm

**(Total 3 marks)**

28. The distance from Fulbeck to Ganby is 10 miles.  
The distance from Ganby to Horton is 18 miles.

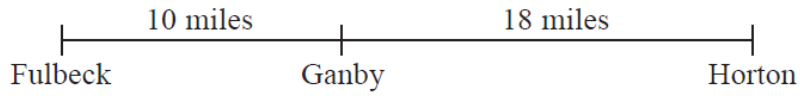

Raksha is going to drive from Fulbeck to Ganby.  
Then she will drive from Ganby to Horton.

Raksha leaves Fulbeck at 10 00.  
She drives from Fulbeck to Ganby at an average speed of 40mph.

Raksha wants to get to Horton at 10 35.

Work out the average speed Raksha must drive at from Ganby to Horton.

.....mph

**(Total 3 marks)**

---

29. (a) Write down the value of  $5^0$

.....  
(1)

(b) Write down the value of  $2^{-1}$

.....  
(1)

**(Total 2 marks)**

---

**TOTAL FOR PAPER IS 80 MARKS**

**BLANK PAGE**