

# BP BendPak®

The Benchmark of Quality



## PRODUCT CATALOG

**Ranger**

**AUTOSTACKER™**

**LITESTIX™**

**GRANDPRIX™**

**COOL BOSS™**

**DANMAR™**

**JACKPAK®**

**QUICKJACK™**

**MAXJAX™**



• BENDPAK •  
**AMERICA'S FAVORITE**  
SINCE 1964  
**CAR LIFT COMPANY**  
• HEAVY METAL •



**Apparel Now Available!**  
Go to [BendPak.com/Apparel](https://BendPak.com/Apparel)

# Table of Contents

4-5	2-Post Clearfloor Lifts
6	2-Post Medium / Heavy Floor Plate Lifts
8-9	2-Post Heavy-Duty Clearfloor Lifts
12	Light-Duty / Medium-Duty Home Garage
13	2-Post / 4-Post Lifts
14	4-Post Light-Duty
16-17	4-Post Medium-Duty
18	4-Post Options / Accessories
20-21	4-Post Heavy-Duty Lifts
22	Alignment Lifts
23	Rolling Bridge Jacks
24-25	Quatra Scissors
27	Portable Column Lift
28-29	Low-Rise & Mid-Rise Lifts
30-31	Portable Lifts & Portable 2-Post Lifts
34-35	Parking & Storage Lifts
36-37	Multi-Platform Parking Lift
39	JackPak Portable Jump Starter
40-41	Pipe Benders / Air Compressors
42-43	Power Units / Wheel Service
44-45	Tire Changers
46-47	Wheel Balancers
48-49	Brake Lathes / Wheel Aligner
50-51	Floor Jacks / Transmission Jacks
52-53	Jack Stands / Motorcycle Lifts
54	Carts & Dollies / Shop Presses
55	Work Benches / Hose Reel
56-57	Oil Drains / Oil Filter Crushers / Spray Wash Cabinets
58	Manual Wheel Service / Rolling Work Seat / Creeper Chair
59	Engine Support / Shop Crane / Inflation Cage / A/C Machine
60-61	Portable Air Coolers
62-63	Manufacturing Superiority



## GENERAL DISCLAIMER

BENDPAK warrants to the original purchaser only that all products shown in this catalog conform to BENDPAK published specifications and are free from defects in material or workmanship. In no event will BENDPAK be liable to you or to anyone else for any decision made or action taken by you or anyone else in reliance on information obtained from this catalog. BENDPAK has exclusive title and ownership rights, including all intellectual property right, throughout the world in all material and content contained on these pages. Materials, design, specifications, images and other content within this catalog are subject to change. BENDPAK does not take responsibility for improper use or any results thereof. BENDPAK products are provided and sold as is without any express or implied warranties including warranties of merchantability or fitness for particular purpose. In no event will BENDPAK be liable for any special, incidental, or consequential damages based on breach of warranty, breach of contract, negligence, strict tort, or any other legal theory. Damages that BENDPAK will not be responsible for include but are not limited to: loss of profits; loss of savings or revenue; loss of use of the product or any associated equipment; cost of capital; cost of any substitute equipment, facilities, or services; downtime; the claims of third parties, including customers; and injury to property. This limitation does not apply to damages caused by breach of the warranty of title and against infringements or to claims for personal injury. Unless modified in a writing signed by both parties, it is understood that BENDPAK published warranties are to be the complete and exclusive agreement between the parties. For complete and full warranty details contact BENDPAK at 1-800-253-2363 or visit [www.bendpak.com](http://www.bendpak.com).

Equipment models shown in this catalog may be available in different voltages upon request.



# 2-Post Clearfloor Lifts

## INFORMATION:

BendPak's all-new AP series of two-post lifts feature a revolutionary design that factors the best qualities of today's two-post lift types into a completely new concept in car lift engineering. The result is a lift unlike any other two-post lift on the market, purposefully designed for extreme use, high loads and operator safety and efficiency. This durable, safe, and reliable car lift features an expandable top beam and BI-METRIC™ arms to suit virtually every vehicle lifting requirement – symmetric or asymmetric.



## AP SERIES™

**10AP**  
Two-Post Lift  
#5175304



**Features column extension for 24" of additional under-clearance height for Euro-style cargo vans**

**10AP-168** #5175305  
Two-Post Lift

**10APX-181** #5175307  
Two-Post Lift

## OPTIONAL ACESORIES:

**WSA-100 Air / Electric Workstation**  
#5210438



**Frame Cradle Pads 60 mm Pin (Set of 4)**  
#5215761



**Replacement Polyurethane Tuf-Pad (Set of 4)**  
#5700227



Fits BendPak 2-Post & 4-Post Lifts  
Four 110V GFI Outlets  
Nickel-Plated Ball Valve Shutoff

Sturdy Steel Construction  
Tactile Rubber Mat Reduces Slippage

Highly Resistant to Gouging  
Oil and Solvent Resistant  
Higher Load Bearing Capacity

Model	10AP #5175304	10AP-168 #5175305	10APX #5175306	10APX-181 #5175307
Lifting Capacity	10,000 lbs.			
Max. Rise	69"		75.5"	
Max. Lifting Height	82.5"		89"	
Min. Height	4"			
Overall Height	145"	168"	157"	181"
Overall Width	135" (Narrow) or 145" (Wide)			
Drive-Thru	97.5" (Narrow) or 107.5" (Wide)			
Front Arm Reach	24.5" (min) 50" (max)			
Rear Arm Reach	32" (min) 59.25" (max)			

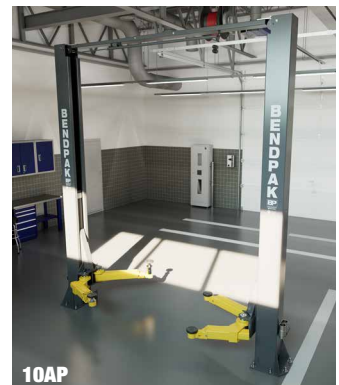

**Variability in Specifications and Features:** All product specifications and features listed in this catalog are for reference only. For a more accurate and comprehensive listing of product specifications and features, visit [www.bendpak.com](http://www.bendpak.com). The contents of this catalog are subject to change.

## SERIES FEATURES:

- Clear-floor convenience
- Bi-Metric™ swing arms
- Low-Pro™ swing-arms
- Automatic arm restraints
- Configurable wide or narrow installation
- Single-piece columns
- Maintenance free load bearings
- Dual Direct-Drive technology
- Single-point safety release
- Dual-Synchro equalization system
- HVLP hydraulic system
- Industrial-grade hydraulic cylinders
- Super-tall lift carriages
- Varying height stackable adapters
- Triple-telescoping arms
- 14-piece standard adapter set
- Drop-end arms provide a lower pad height
- Oversized carriages for superior strength and durability

### 10APX Two-Post Lift

#5175306



Durable powder coat finish

**NEW!**

UHMW polyethylene bearing system

Single point safety release

Expandable top beam

Padded overhead safety shutoff bar

Oversized cable sheave diameter reduces cable fatigue

Automatic arm restraints

Electric / hydraulic HVLP power system

Exclusive Bi-Metric™ arm design

Double-telescoping screw pads

- Heavy-duty 1/2" aircraft quality equalizer cables
- Safety locks every 3"

Four triple-telescoping arm design

Dual hydraulic direct-drive cylinders

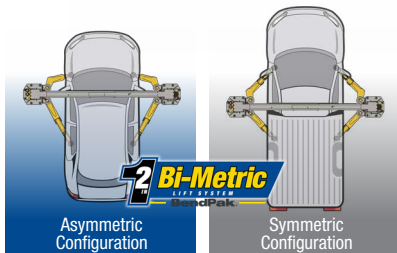

# Medium / Heavy Duty Floor Plate

## SERIES FEATURES:

- Adjustable width design
- Dual hydraulic lifting cylinders
- Single-piece columns
- Single point safety release
- Drop-end arms provide a lower pad height
- Triple-telescoping arms
- Electric / hydraulic system
- Self-lubricating dura-glide UHMW polyethylene bearing system
- Automatic arm restraints
- 4-piece stackable adapter set (XPR-9's)
- Telescoping screw pads
- Durable powder coat finish
- Safety locks in each column spaced every 3-inches
- Open top design
- Large steel base plates
- Heavy-duty 3/8" equalizer cables
- Rugged steel construction

**XPR-9S  
Shorty Floor Plate**  
#5175390



Lifting Capacity - 9,000 lbs.  
Max. Rise - 72"  
Width - 132" or 145" / Height - 113"

**XPR-9S-LP  
Shorty Floor Plate  
Low-Pro™ Arms**  
#5175391



Lifting Capacity - 9,000 lbs.  
Max. Rise - 72"  
Width - 132" or 145" / Height - 113"

**XPR-12FDL  
Heavy-Duty Floor Plate**  
#5175403



**Includes 16-Piece Adapter Set**

Lifting Capacity - 12,000 lbs.  
Max. Rise - 69"  
Width - 155" / Height - 144"

## Low-Pro™ Arms

2-stage low-profile arms featured on LP lift models



**Low-Profile arms found on these models:**

- XPR-9S-LP
- XPR-10S-LP
- XPR-10AS-LP
- XPR-10XLS-LP
- XPR-10AXLS-LP
- XPR-10S-168-LP
- XPR-10AS-168-LP
- XPR-10XLS-181-LP
- XPR-10AXLS-181-LP



**XPR-9S**



**Triple-Telescoping Arms**

# EV Battery Scissor Lift

## ALL NEW EV BATTERY & POWERTRAIN LIFTING SYSTEM

**2,400 LB. CAPACITY**

**BendPak Mobi-EVS EV2400SL**

**Portable EV Battery Lift**

SKU 5175423

- Platform Capacity - 2,400 lbs.
- Max. Platform Height - 75.75"
- Platform Size - 40" x 60"

**4,000 LB. CAPACITY**

**BendPak Mobi-EVS EV4000SL**

**Portable EV Battery Lift**

SKU 5175428

- Platform Capacity - 4,000 lbs.
- Max. Platform Height - 75.75"
- Platform Size - 40" x 60"



**EV BATTERY SERVICE**



**EASY TO USE PENDANT CONTROL**

**WOW!**  
**OVER 6 FT. LIFTING HEIGHT**

**ALL RIGHTS RESERVED**  
**PATENT PENDING**  
**ALL RIGHTS RESERVED**

### OPTIONAL MOBI-EVS ADAPTERS



Universal Deck Mount Kit



Fixture Set



Transmission Support

**DRIVE TRAIN SERVICE**



Multi-Point Support Kit



Telescoping Arm Kit



**FULL LENGTH TOOL TRAYS**

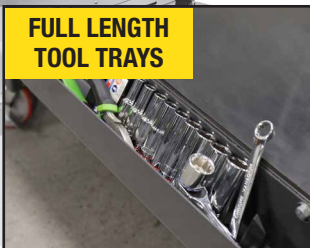

**SEE IT IN ACTION!**



# Heavy-Duty Clearfloor

## SERIES FEATURES:

- Dual-synchro equalization system
- Electric / hydraulic power system
- UHMW polyethylene bearings
- Single-piece columns
- Dual "Direct-Drive" cylinders
- Single point safety release
- Automatic arm restraints
- 8-piece stackable adapter pins
- Oversized column base plates
- Padded safety-shutoff bar
- Safety locks in each column
- Heavy-duty 1/2" equalizer cables
- Powder coat finish
- Rubber door bumpers
- Versatile drop in contact pads with convenient storage
- Triple-telescoping arms
- Extended height top-beam provides greater overhead clearance
- Oversized cable sheave diameter
- Rubber lift pads with stackable adapters

### XPR-12CL Clearfloor

#5175405



**Includes  
16-Piece Adapter Set**

Lifting Capacity - 12,000 lbs.  
Max. Rise - 69"  
Width - 155" / Height - 170"

### XPR-15CL Clearfloor

#5175408



**Includes  
16-Piece Adapter Set**

Lifting Capacity - 15,000 lbs.  
Max. Rise - 69"  
Width - 155" / Height - 170"

### XPR-18CL Clearfloor

#5175409



**Includes  
16-Piece Adapter Set**

Lifting Capacity - 18,000 lbs.  
Max. Rise - 69"  
Width - 155" / Height - 170"

### XPR-12CL-LTA Long-Reach Telescoping Arms

#5175258



**Includes  
16-Piece Adapter Set**

Lifting Capacity - 12,000 lbs.  
Max. Rise - 69"  
Width - 155" / Height - 170"

## 16-Piece Adapter Set



Included on all truck two-post models

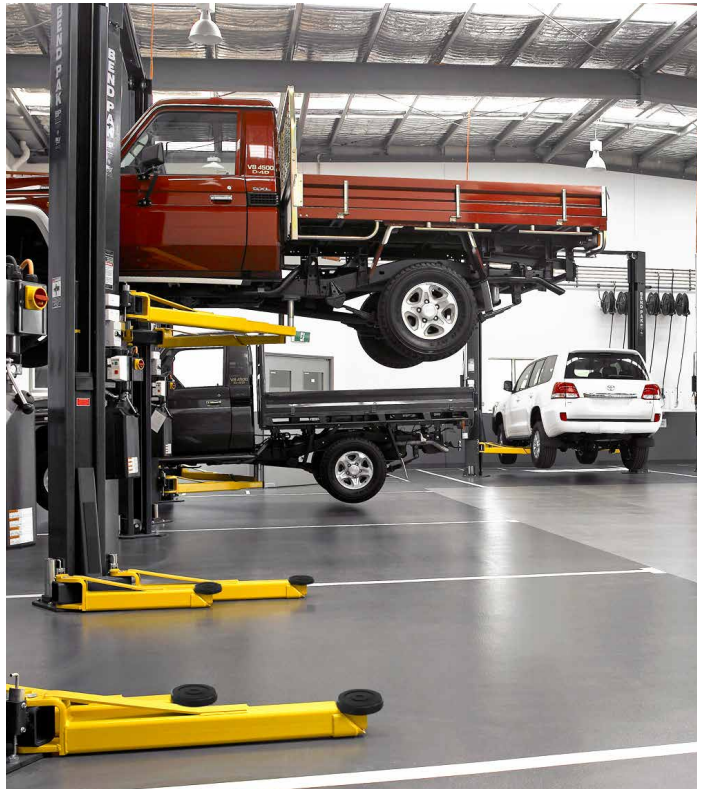



**Variability in Specifications and Features:** All product specifications and features listed in this catalog are for reference only. For a more accurate and comprehensive listing of product specifications and features, visit [www.bendpak.com](http://www.bendpak.com). The contents of this catalog are subject to change.

## ACCESSORIES:



**Frame Cradle Pads**  
#5215761 (set of 4)



**Wide Frame Cradle Pads**  
#5215848 (set of 2)



**Mobile High-Lift Jack Stand**  
#5175001



**Steel Lift Pads**  
#5215763 (set of 4)



**Air / Electric Workstation**  
#5210438

**XPR-15CL**  
(Shown with optional  
air/electric workstation)  
#5175408

Padded overhead safety shutoff bar

Heavy-duty 1/2" aircraft-quality equalizer cables  
Safety locks every 3"

Oversized cable sheave diameter reduces cable fatigue

**XPR-12CL-192** #5175407  
**XPR-15CL-192** #5175410  
**XPR-18CL-192** #5175411  
**XPR-12CL-192-LTA** #5175259  
Features bolt on top extension for added 24" clearance

Automatic arm restraints

Durable rubber lift pads

UHMW polyethylene bearing system

Dual hydraulic direct-drive cylinders

Adapter storage

Oversized A36 steel base plates

Single point safety release

**FREE 16-Piece adapter set comes standard with all Heavy-Duty Lifts**

# WHEN BALANCING SAFETY AND BENDPAK GOES THE

## LONG-REACH ARMS PROVIDE BETTER CENTER-OF-GRAVITY LOADING

When servicing trucks and vans with extremely long wheelbases, longer-reach arms deliver a more stable lifting solution. The lengthy triple-telescoping arms on BendPak's new **ALI Certified XPR-12CL-LTA** extend to 72" long – that's six feet in length and over one foot longer than almost any other lift or brand in its class. And with rugged BendPak dependability combined with a 16-piece adapter set, you'll realize that balancing safety\* and worker productivity has never been so perfectly matched. For more information visit [www.bendpak.com/LTA](http://www.bendpak.com/LTA) or call **1-800-253-2363**.



Stackable adapters come standard



Frame Cradle Pads come standard



36" - 72" arm reach

[www.bendpak.com/LTA](http://www.bendpak.com/LTA) ■ 1-800-253-2363

# D PRODUCTIVITY, DISTANCE.

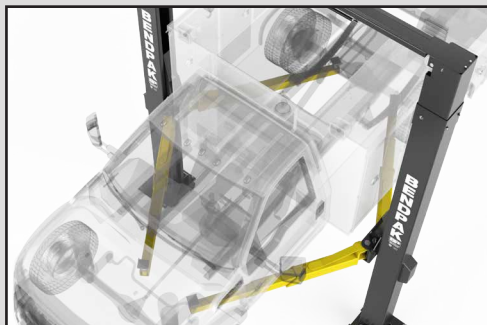

- 12,000-lb. lifting capacity
- Dual direct-drive hydraulic cylinders
- Oversized 53" tall carriage for superior strength and durability

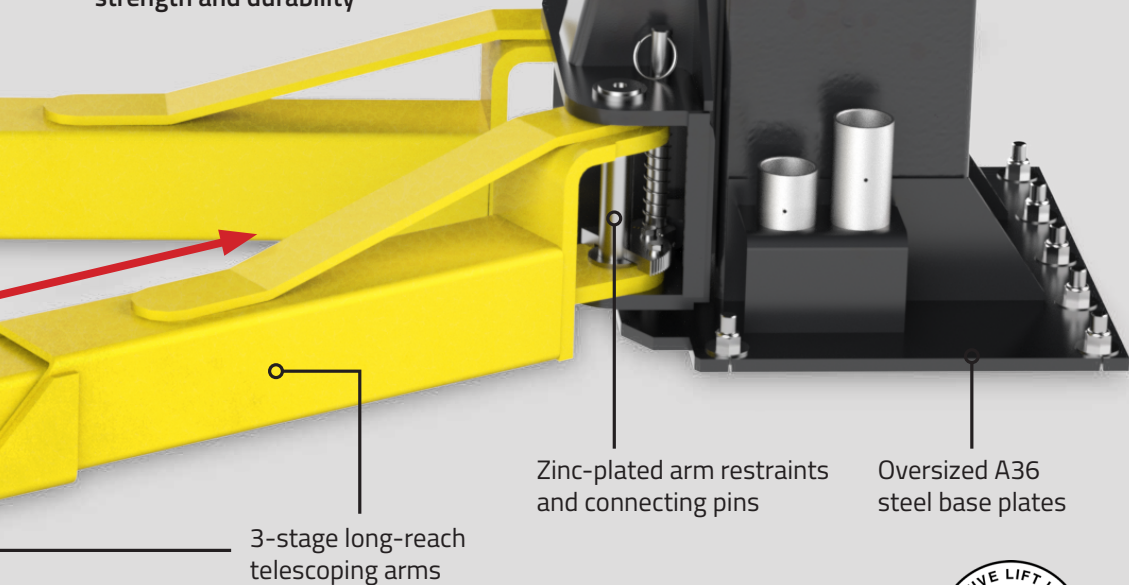

3-stage long-reach telescoping arms

Zinc-plated arm restraints and connecting pins

Oversized A36 steel base plates

\*Always read and follow all safety warnings that accompanied your lifting equipment at the time of purchase. More information regarding vehicle lift safety is available directly from BendPak or from the Automotive Lift Institute.



# Light-Duty / Medium-Duty Home Garage

## GP-7 SERIES FEATURES:

- 7,000-lb lifting capacity
- Telescoping Low-Pro™ arms for sports cars
- Bi-metric asymmetric & symmetric arm configuration
- Lowered arm tube supports
- Automatic arm restraints
- Taller lift carriages
- Single release-point operation
- Automatic safety locks
- Single hidden hydraulic cylinder
- (2) redundant safety cables
- Multiple lock positions
- Powder coat finish

## GP-9 SERIES FEATURES:

- 9,000-lb lifting capacity
- Fastened to the floor or free-standing
- Boxed-steel columns
- 3/4" thick, automatic safety locks
- Welded-steel tread-plate runways
- Stainless steel lifting cables
- Pull out tire stops on both ends of the lift

### GP-7LCS Short Height

#5175995



Lifting Capacity - 7,000 lbs.  
Max. Rise - 58"  
Width - 125" / Height - 106.5"

### GP-7LC Medium Height

#5175996



Lifting Capacity - 7,000 lbs.  
Max. Rise - 68"  
Width - 125" / Height - 118.5"

### GP-7 Tall Height

#5175992



Lifting Capacity - 7,000 lbs.  
Max. Rise - 78"  
Width - 125" / Height - 150"

### GP-9F Standard

#5175254



Lifting Capacity - 9,000 lbs.  
Max. Rise - 70" / Runway Length - 165.5"  
Width - 114.5" / Length - 203"

### GP-9XLT Tall / Long

#51751257



Lifting Capacity - 9,000 lbs.  
Max. Rise - 82" / Runway Length - 189.75"  
Width - 114" / Length - 227"

### GP-7LCS

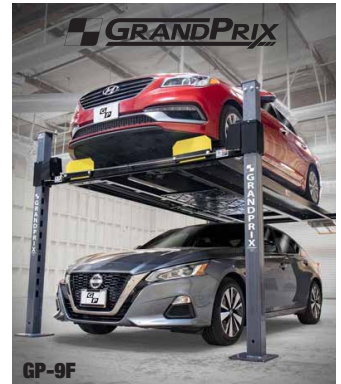
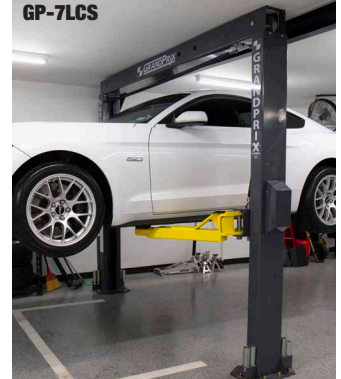

GP-9F

## GP-9 MODELS INCLUDE



Polyethylene Drip Trays

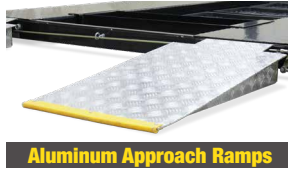

Aluminum Approach Ramps



Mobile Jack Tray



Quick-Mount Casters

# Danmar Series Features & Specifications

## 2-Post / 4-Post Lifts

### DELIVERING QUALITY AND VALUE:

Danmar's car lifts deliver quality you can rely on. But it all starts with surpassing your expectations. Like you, we know that when you put a vehicle up in the air, there are a few things you count on right away. First are safety, quality, and vehicle access. Danmar easily delivers on all three of these. Our design and manufacturing process is based on an effort to have all of our automotive lifts ANSI/ALI certified. Danmar's lifts are built from a history of carefully exceeding the needs of the vehicle repair industry for over 50 years and most importantly always looking for what's next.

### D4-9 PACKAGES INCLUDE:

- D4-9 or D4-9X four-post lift
- Caster kit
- Plastic drip trays (set)
- JP45 sliding jack trays
- Aluminum approach ramps (set)

**DANMAR**

#### D2-8F Two-Post Lift

#5175316



Lifting Capacity - 8,000 lbs.  
Max. Rise - 72"  
Width - 132" or 145" / Height - 113"

#### D2-10C Two-Post Lift

#5175314

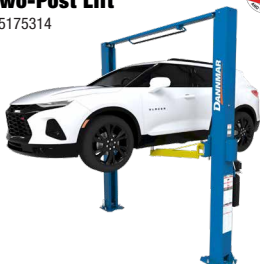

Lifting Capacity - 10,000 lbs.  
Max. Rise - 69"  
Width - 145.25" / Height - 145"

#### D2-10A Two-Post Lift

#5175313



Lifting Capacity - 10,000 lbs.  
Max. Rise - 69"  
Width - 143.5" / Height - 145"

#### D2-12C Heavy Duty Two-Post Lift

#5175312



Lifting Capacity - 12,000 lbs.  
Max. Rise - 69"  
Width - 155.25" / Height - 168.75"

#### D2-15C Heavy-Duty Two-Post Lift

#5175311



Lifting Capacity - 15,000 lbs.  
Max. Rise - 69"  
Width - 155.25" / Height - 168.75"

#### D4-9 Package Four-Post Lift

#5175319



Lifting Capacity - 9,000 lbs.  
Max. Rise - 70" / Runway Length - 165.5"  
Width - 114.5" / Length - 203"

#### D4-9X Package Four-Post Lift

#5175321



Lifting Capacity - 9,000 lbs.  
Max. Rise - 82" / Runway Length - 189.75"  
Width - 114.5" / Length - 227"

#### D4-12 Four Post Lift

#5175317



Lifting Capacity - 12,000 lbs.  
Max. Rise - 68.75" / Runway Length - 194.75"  
Width - 127.5" / Length - 233.5"

#### D4-12A Alignment Four-Post Lift

#5175318



Max. 2 Wheel Align. - 163.5" / Max Rise - 68.75"  
Capacity - 12,000 lbs. / Runway Length - 194.75"  
Width - 127.5" / Length - 233.5"

# 4-Post Light-Duty

## SERIES FEATURES:

- Runways feature non-skid surface
- Single hydraulic cylinder under ramp
- Fully enclosed lifting cables, safety locks and sheaves
- Pneumatic push-button safety release
- Features 1-1/4" sheave axles
- Features heavy-duty 3/8" aircraft cable
- Internal "anti-sway" slider blocks in each column
- Electric / hydraulic power system
- Oversized sheave diameters
- Rugged, self-lubricating cable sheaves
- Multi-position safety locks in columns
- Dual-position power unit locations
- Redundant slack-cable safety latches
- Fully adjustable lock leveling stops
- Drive through ramps option available
- 36" approach ramps available
- Durable powder coat finish
- Rugged steel construction
- High-speed lifting

**HD-7P  
Narrow**  
#517510



Lifting Capacity - 7,000 lbs.  
Max. Rise - 82" / Runway Length - 164"  
Width - 100.25" / Length - 200"

**HD-7W  
Wide**  
#5175120



Lifting Capacity - 7,000 lbs.  
Max. Rise - 82" / Runway Length - 164"  
Width - 110.25" / Length - 200"

**HD-7PXW  
Super-Tall**  
#5175516



Lifting Capacity - 7,000 lbs.  
Max. Rise - 140" / Runway Length - 188"  
Width - 110.25" / Length - 224.5"

**HD-7500BLX  
Boat Lift**  
#5175315



Lifting Capacity - 7,500 lbs.  
Max. Rise - 82" / Runway Length - 188.5"  
Width - 132" / Length - 224"

**HD-75BXT  
Boat Lift**  
#5175251



Lifting Capacity - 7,500 lbs.  
Max. Rise - 82" / Runway Length - 213"  
Width - 134" / Length - 249"

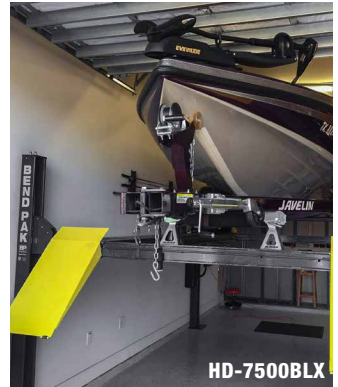

**HD-7500BLX**

## SPECIAL LIFT COLORS

Customize your BendPak lift with the color that best suits your garage or shop interior design. Gunmetal **Gray** comes standard, but for a nominal fee you can choose from optional Classic **Blue**, Graphite **Black** or race-inspired **Seca Red**. Available on select models.



**Classic Blue**



**Graphite Black**



**Seca Red**

# SHIP, DELIVER & INSTALL. WE DO IT ALL.

Shop Planning • Above Ground Lift Installation • Painless Equipment Delivery

## SERVICE IS OUR SPECIALTY

BendPak has a network of installation and service teams throughout the United States authorized to provide installation and support on all of the products we sell. With over 700 service centers, you can rest assured that the products you purchase from BendPak are backed by a nationwide team of qualified service personnel. At BendPak, we've made a commitment to offer unparalleled service and support. More than just a seller, we want to be your automotive equipment partner for life.

## FREE SHIPPING\*

At BendPak, we are dedicated to delivering your purchase as quickly and affordably as possible. All products marked FREE SHIPPING include FREE destination delivery to all direct shipping points within the 48 contiguous United States. For heavy equipment purchases, we offer a range of delivery and pick-up options so you can choose the shipping method that best meets your needs.



**WE SHIP**



**WE DELIVER**

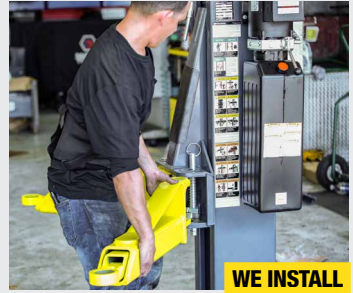

**WE INSTALL**

## EASY TO ORDER – DELIVERED RIGHT TO YOUR DOOR

Ordering lifts or shop equipment from BendPak is fast and easy. Whether for the shop or home, we'll make sure your order is delivered to you as fast and conveniently as possible. And we'll arrange the installation and set-up as well if you wish. Placing an order takes just minutes. Either call and speak to one of our courteous specialists or place your order online and click your way through. If you ever need assistance or advice, our friendly consultants are only a phone call away. We look forward to serving you.

## IF YOU FIND A LOWER PRICE, WE'LL MATCH IT OR BEAT IT - GUARANTEED.

If you find a lower price anywhere on an identical BendPak™ or Ranger™ brand product sold in the United States, show us the lower advertised price at the time of purchase and we will match it on the spot. Or show us the lower price within 14 days of your purchase and we will pay you the difference. We will not match other retailer's mail-in rebates nor will we deduct the value of any gift with purchase.



BendPak reserves the right to verify all information. Our low-price guarantee covers identical BendPak and Ranger branded items with the same model number, features and U.S. warranty. The item must be in stock and available for purchase at the price as advertised. We reserve the right to call and verify that the item is in stock and available for purchase at the price as advertised. Low price guarantee applies only to items shown in this flyer. Taxes, ad errors, closeouts, clearance, liquidation, free product offers, special orders, offers advertised at a specific location and refurbished items are also excluded from this guarantee.

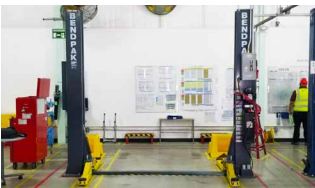

# 4-Post Medium-Duty

## SERIES FEATURES:

- Freestanding or bolt-down design
- Runways feature non-skid surface
- Single hydraulic cylinder under ramp
- Fully enclosed lifting cables, safety locks and sheaves
- Pneumatic push-button safety release
- Features 1-1/4" sheave axles
- Internal "anti-sway" slider blocks in each column
- Features heavy-duty 3/8" aircraft cable
- Longer ramps for low ground clearance vehicles
- Oversized sheave diameters
- Rugged, self-lubricating cable sheaves
- Multi-position safety locks in columns
- Dual-position power unit locations
- Redundant slack-cable safety latches
- Fully adjustable lock leveling stops
- Drive through ramps option available
- 36" approach ramps available
- Perfect for parking, storage and service

### HD-9 Wide Standard

#5175861



Lifting Capacity - 9,000 lbs.  
Max. Rise - 70" / Runway Length - 164"  
Width - 110.25" / Length - 200"

### HD-9ST Narrow Standard

#5175860



Lifting Capacity - 9,000 lbs.  
Max. Rise - 70" / Runway Length - 164"  
Width - 100.25" / Length - 200"

### HD-9STX Narrow Tall Long

#5175862



Lifting Capacity - 9,000 lbs.  
Max. Rise - 82" / Runway Length - 188"  
Width - 100.25" / Length - 224"

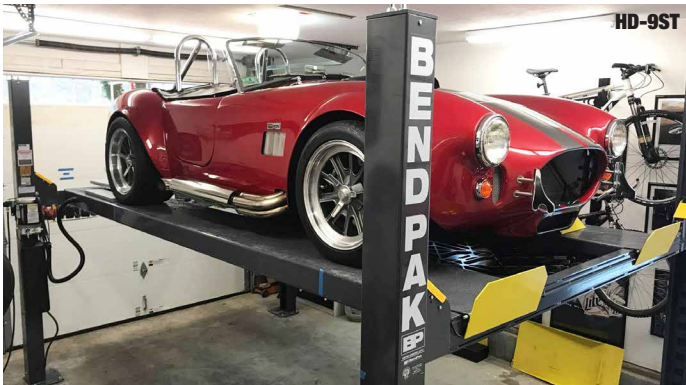

HD-9ST

### HD-9XW Wide Tall Long

#5175863



Lifting Capacity - 9,000 lbs.  
Max. Rise - 82" / Runway Length - 188"  
Width - 110.25" / Length - 224"



HD-9

### HD-9XL Wide Standard Long

#5175859



Lifting Capacity - 9,000 lbs.  
Max. Rise - 70" / Runway Length - 188"  
Width - 110.25" / Length - 224"



**Variability in Specifications and Features:** All product specifications and features listed in this catalog are for reference only. For a more accurate and comprehensive listing of product specifications and features, visit [www.bendpak.com](http://www.bendpak.com). The contents of this catalog are subject to change.

## ACCESSORIES:

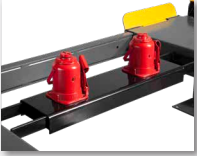

**Jack Platform**  
(Jacks not included)



**Caster Kit**  
#5210997



**RBJ4500 Rolling Bridge Jack**  
#5175988 (ea)

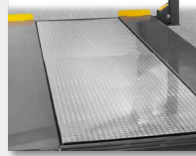

**Aluminum Deck**



**Drip Trays**  
#5700301 (set of 2)

### HD-9SW Double Wide Standard

#5175023



Lifting Capacity - 9,000 lbs.  
Max. Rise - 70" / Runway Length - 164"  
Width - 202" / Length - 200"

### HD-9SWX Double Wide Tall Long

#5175024



Lifting Capacity - 9,000 lbs.  
Max. Rise - 82" / Runway Length - 188"  
Width - 202" / Length - 224"



### HD-9 Series

Oversize self-lubricating cable sheaves

- Push button pneumatic safety release
- Electric/hydraulic power system
- Optional power unit locations

Rugged 1-1/4" roller axles

Independent backup slack-cable safety latches

Optional rolling bridge jacks

Adjustable lock ladders

Longer approach ramps

- Heavy-duty 3/8" aircraft cables
- Multi-position safety locks



See it on the BendPak / Ranger YouTube Page

# Options/Accessories



**Caster Kit** #5210997  
Fits HD-7 & HD-9 Series



**RBJ4500** #5175988  
Rolling Bridge Jack



**JP-45** #5215825  
4,500 lb. Capacity Jack Platform



(Bottle jacks not included)

**JP-6 Telescoping** #5175349  
6,000 lb. Capacity Jack Platform



**WSA-100** #5210438  
Air Electric Workstation

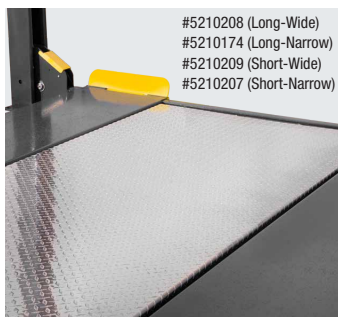

- #5210208 (Long-Wide)
- #5210174 (Long-Narrow)
- #5210209 (Short-Wide)
- #5210207 (Short-Narrow)

**Solid Aluminum Decks**

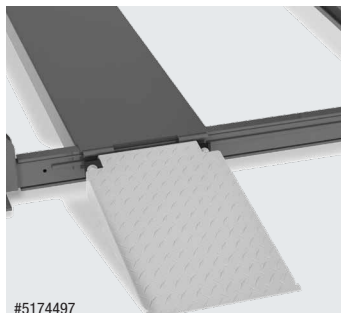

#5174497

**Aluminum Approach Ramps**  
Width - 19.75" / Length - 36.75"

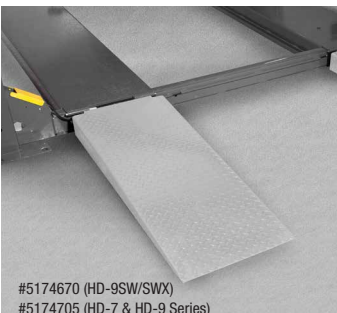

- #5174670 (HD-9SW/SWX)
- #5174705 (HD-7 & HD-9 Series)

**Extended Alum. Approach Ramps**  
Width - 19.75" / Length - 48"

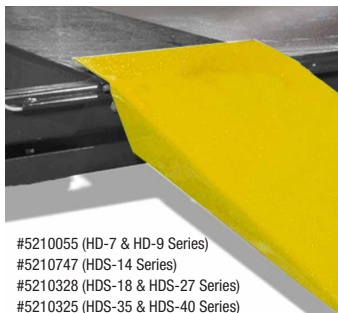

- #5210055 (HD-7 & HD-9 Series)
- #5210747 (HDS-14 Series)
- #5210328 (HDS-18 & HDS-27 Series)
- #5210325 (HDS-35 & HDS-40 Series)

**Extended Steel Approach Ramps**  
Width - 19.75" / Length - 48"



**Caster Kit**



**Solid Aluminum Decks**

# Rechargeable Work Light



## LITESTIX™

By BendPak



**LiteStix LS36MD**  
**Rechargeable**  
**Work Light**

#5150029

The LITESTIX™ LS36SMD is a versatile LED rechargeable portable work light with 36 super-bright LED bulbs that provide brilliant lighting coverage anywhere you need it. Includes a large 1,800 mAh lithium-ion battery that provides up to 3 hours of continuous use, hi and low settings, impact resistant polycarbonate housing, detachable telescoping grip that expands from 49.5" to 79.75", two swivel magnets for quick mounting to work benches, tool boxes or car lift components, and durable stowable hooks for hanging or mounting.

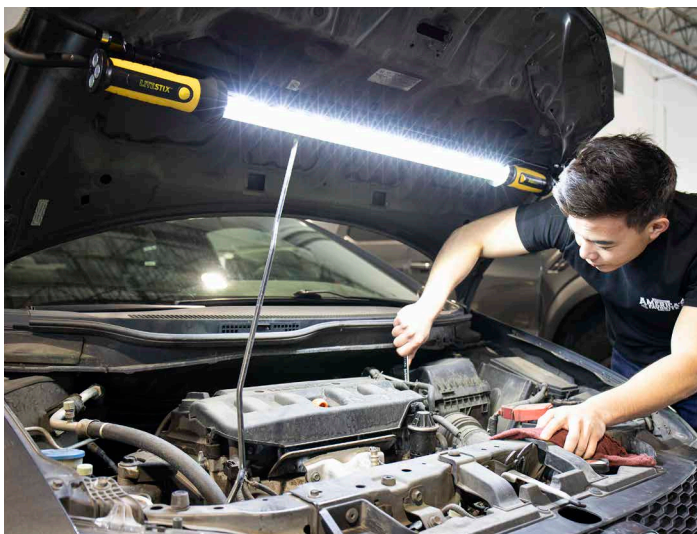

**1200**  
**LUMENS**

EXTENDS FROM BOTH ENDS

HIDEAWAY RECESSED HOOKS

90° ROTATING HANDLES

SHATTER RESISTANT

UP TO 6 HOURS OF  
CONTINUOUS USAGE

6 HRS

STRONG  
MAGNETIC ENDS

TWO ACCESSIBLE  
POWER BUTTONS

RECHARGEABLE  
LITHIUM-ION

HIGH AND LOW  
BRIGHTNESS SETTINGS

# 4-Post Heavy-Duty

## SERIES FEATURES:

- Adjustable runway widths
- Single hydraulic cylinder under ramp
- Fully enclosed lifting cables, safety locks and sheaves
- Pneumatic push-button safety release
- Features heavy-duty aircraft cable
- Runways feature non-skid surface
- Internal "anti-sway" slider blocks in each column
- Longer ramps for low ground clearance vehicles
- Oversized sheave diameters
- Rugged, self-lubricating cable sheaves
- Features heavy-duty sheave axles
- Multi-position safety locks in columns
- Dual-position power unit locations
- Redundant slack-cable safety latches
- Fully adjustable lock leveling stops
- Drive-through ramps option available
- 48" approach ramps available
- Customizable power unit location

### HDS-14 Standard Length

#5175170



Lifting Capacity - 14,000 lbs.  
Max. Rise - 70" / Runway Length - 203"  
Width - 131.75" / Length - 241"

### HDS-14X Extended Length

#5175173



Lifting Capacity - 14,000 lbs.  
Max. Rise - 70" / Runway Length - 233"  
Width - 131.75" / Length - 271"

### HD-14T Super Tall

#5175004



Lifting Capacity - 14,000 lbs.  
Max. Rise - 82" / Runway Length - 195"  
Width - 127.5" / Length - 234"

### HDSO-14P Open Front Standard Length

#5175152



Lifting Capacity - 14,000 lbs.  
Max. Rise - 70" / Runway Length - 199"  
Width - 143" / Length - 244"

### HDS-18E Standard Length

#5175968



Lifting Capacity - 18,000 lbs.  
Max. Rise - 61.25" / Runway Length - 257.5"  
Width - 153.5" / Length - 312.75"

### HDS-27 Standard Length

#5175162



Lifting Capacity - 27,000 lbs.  
Max. Rise - 61.25" / Runway Length - 257.5"  
Width - 153.5" / Length - 312.75"

### HDS-18E



### HDS-27X



**Variability in Specifications and Features:** All product specifications and features listed in this catalog are for reference only. For a more accurate and comprehensive listing of product specifications and features, visit [www.bendpak.com](http://www.bendpak.com). The contents of this catalog are subject to change.

## ACCESSORIES:



**Rolling Bridge Jack**



**DP-30 Rolling Oil Drain**  
#5150509



**Air / Electric Workstation**  
#5210436



**Rolling Bridge Airline Kit**  
#5174010

**HDS-27X  
Extended  
Length**  
#5175164



Lifting Capacity - 27,000 lbs.  
Max. Rise - 61.25" / Runway Length - 317.5"  
Width - 153.5" / Length - 372.75"

**HDS-40  
Standard  
Length**  
#5175176



Lifting Capacity - 40,000 lbs.  
Max. Rise - 61.25" / Runway Length - 244.5"  
Width - 153.5" / Length - 313.75"

**HDS-40X  
Extended Length**  
#5175178



Lifting Capacity - 40,000 lbs.  
Max. Rise - 61.25" / Runway Length - 304.5"  
Width - 153.5" / Length - 373.5"

**HDS-40X** Shown with optional rolling bridge jacks

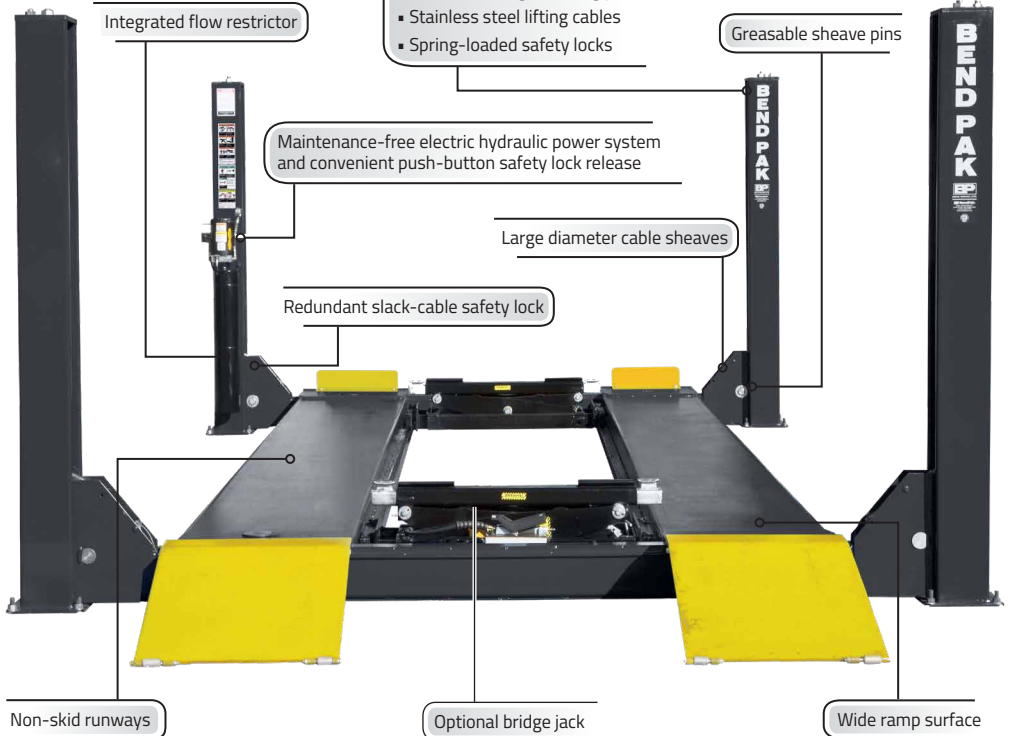

# Alignment Lifts

## SERIES FEATURES:

- Runways adjust to different widths
- Multi auto-level locking positions
- Single hydraulic cylinder
- Fully enclosed lifting cables and sheaves
- Pneumatic push-button safety release
- Heavy-duty aircraft cable
- Runways feature non-skid surface
- Self-lubricating cable sheaves
- Oversized sheave diameter
- Features heavy-duty sheave axles
- Fully adjustable lock stops
- Drive through ramps available
- Rolling bridge airline kit available
- Roll back kit available



Equipped with rear slip plates and galvanized front turn plates

### HD-9AE Alignment Lift

#5175820



Max. 2 Wheel Align. - 160" / Max. Rise - 70"  
Capacity - 9,000 lbs. / Runway Length - 188"  
Width - 127" / Length - 224"

### HDS0-14AX Open Front

#5175153



Max. 2 Wheel Align. - 182" / Max. Rise - 70"  
Capacity - 14,000 lbs. / Runway Length - 199"  
Width - 143" / Length - 243"

### HDS-14LSX Extended Length

#5175171



Max. 2 Wheel Align. - 182" / Max. Rise - 70"  
Capacity - 14,000 lbs. / Runway Length - 199"  
Width - 130" / Length - 241"

### HDS-14LSXE Limo Extended Length

#5175172



Max. 2 Wheel Align. - 212" / Max. Rise - 70"  
Capacity - 14,000 lbs. / Runway Length - 229"  
Width - 130" / Length - 271"



### HDS-18EA Truck Alignment

#5175969



Max. 2 Wheel Align. - 211" / Max. Rise - 59"  
Capacity - 18,000 lbs. / Runway Length - 257.5"  
Width - 153.5" / Length - 312.75"



# Rolling Bridge Jacks

## SERIES FEATURES:

- 4,500 - 25,000 lb. lifting capacity
- Versatile drop in lifting pads
- Multi-piece adapter set standard
- High-pressure hydraulic power unit
- Stackable adapters
- Automatic safety locks
- Three safety-lock positions
- Rubber lifting pads or steel lifting pads come standard or optional
- Optional air-line kit
- Raise 2 or 4 wheels off the runways
- Telescoping roller design allows the runways to be adjusted for different tread widths



### RJ45W Rolling Jack

#5175247



Lifting Capacity - 4,500 lbs.  
Arm Reach - 42" - 57"  
Frame Reach - 35.5" - 46.5"

### RJ6W Rolling Jack

#5175248



Lifting Capacity - 6,000 lbs.  
Arm Reach - 42" - 56"  
Frame Reach - 36.25" - 47.25"

### RJ7W Rolling Jack

#5175249



Lifting Capacity - 7,000 lbs.  
Arm Reach - 42" - 56"  
Frame Reach - 36.25" - 46.5"

### RJ9W Rolling Jack

#5175252



Lifting Capacity - 9,000 lbs.  
Arm Reach - 42" - 56"  
Frame Reach - 45" - 50"

### RBJ15000 Rolling Jack

#5175031



INCLUDES:  
8-Piece Adapter Set

Lifting Capacity - 15,000 lbs.  
Arm Reach - 48.5" - 63.75"  
Frame Reach - 45.75" - 59"

### RBJ18000 Rolling Jack

#5175032



INCLUDES:  
8-Piece Adapter Set

Lifting Capacity - 18,000 lbs.  
Arm Reach - 48.5" - 63.75"  
Frame Reach - 45"

### RBJ25000 Rolling Jack

#5175033



INCLUDES:  
8-Piece Adapter Set

Lifting Capacity - 25,000 lbs.  
Arm Reach - 48.5" - 63.75"  
Frame Reach - 45"

### RJ45W



# Quatra Scissors

## SERIES FEATURES:

- 12,000-lb. lifting capacity
- Extended runway design
- Durable powder coat finish
- Multi-position runway work steps
- Non-skid runways for sure grip
- Electric / hydraulic power system
- Integrated velocity fuses for cylinders
- Power console with simple controls
- Open-center design
- Quad automatic safety locks with pneumatic push-button release
- Lubricated bearing on all pivot points
- Rugged steel legs
- Can be flush mounted or recessed
- Easy to use and understand
- High efficiency hydraulic power unit
- Collapsible front tire stops clear for low vehicle skirts
- Straight up vertical lifting
- Multi-position automatic leveling system
- Easy access to components for servicing

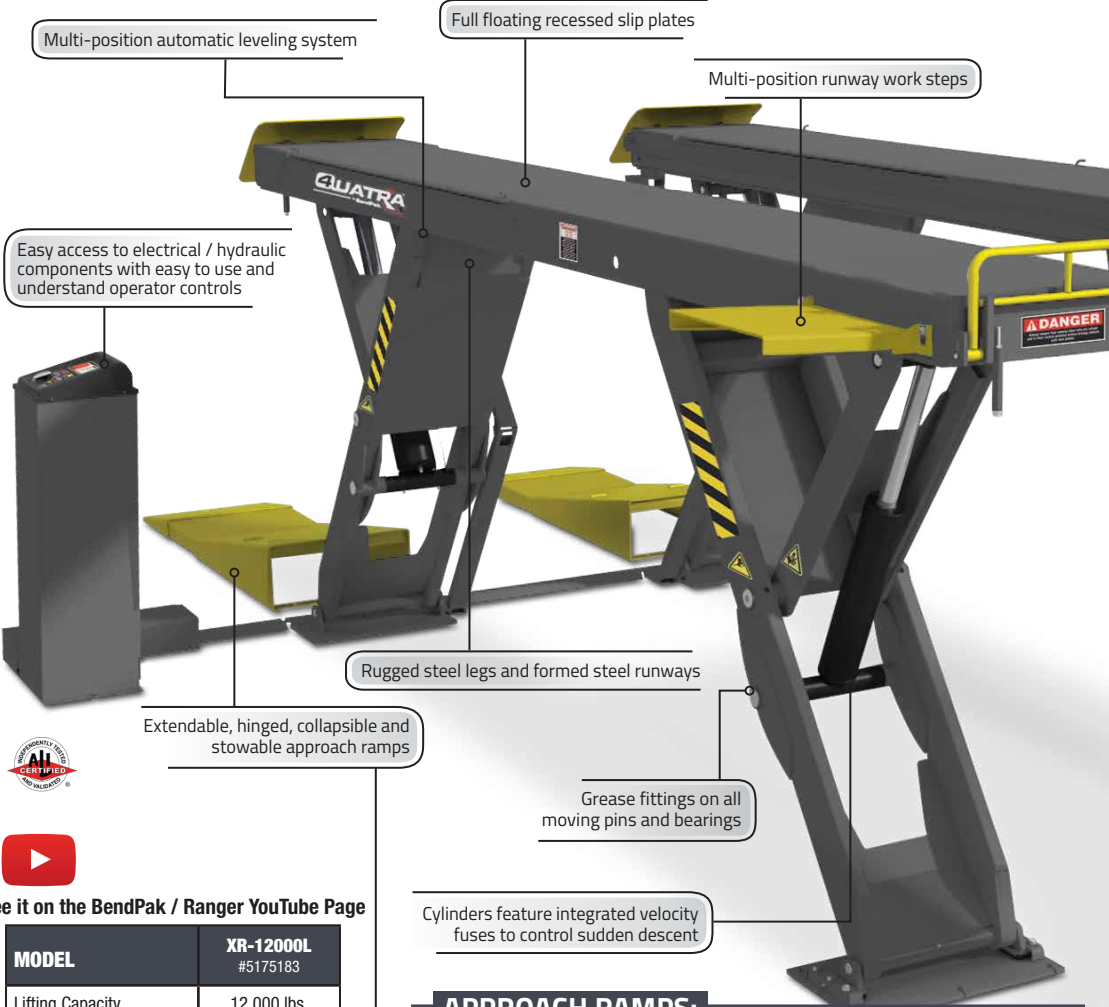

See it on the BendPak / Ranger YouTube Page

MODEL	XR-12000L #5175183
Lifting Capacity	12,000 lbs.
Overall Width	88"
Overall Length	257.75"
Runway Width	24"
Length of Runways	193"
Max. Lifting Height	75"

### APPROACH RAMPS:





**Variability in Specifications and Features:** All product specifications and features listed in this catalog are for reference only. For a more accurate and comprehensive listing of product specifications and features, visit [www.bendpak.com](http://www.bendpak.com). The contents of this catalog are subject to change.

## ACCESSORIES:



**DP-30 Rolling Oil Drain**  
#5150509



**3D Aligner (pg. 49)**  
#5140101



**Rolling Bridge Airline Kit**  
#5174008



#5175987  
**Optional RBI6000 - 6,000 lb. capacity rolling bridge jack**



**XR-12000L**  
#5175183



# ***This is my BendPak***

***There are many,  
but this one's mine.***

*"Keeping my shop working efficiently and safe during endless hours of filming and running a Mopar specialty shop is not easy. That's why I use the best tools and equipment money can buy. I am a true believer in BendPak because they build the best products and offer great service. My BendPak's are one part of my operation that I can truly depend on which allows me to focus on other parts of my business, like resurrecting the best Mopars on the planet."*

*-Mark Worman, Master of all things Mopar  
Owner of Welby's Car Care Center and  
star of TV's "Graveyard Carz"*

**BP BendPak®**

For more information on BendPak's entire product line,  
call 1-800-253-2363 or visit [www.bendpak.com](http://www.bendpak.com)

© 2023 BendPak Inc. All rights reserved.

**B  
E  
N  
D  
P  
A  
K**

**BP**

Always use proper LIFT

BP BendPak

40

**GRAVEYARD  
CARZ**

# Portable Column Lift

## SERIES FEATURES:

- 18,000-lb. individual column capacity
- 108,000-lb. maximum system capacity
- SINGLE, PAIR or TEAM operation
- Three, 30' cables are used, leaving the front or back of the lift clear of cables
- Self-diagnostics and self-calibration
- Control systems feature 24-volt circuitry
- Variable height limit settings
- Two-speed lowering option settings
- Equipped with a warning light and audible alarm for critical warning alerts
- Emergency shutoff on each column
- Key lock enclosure on each column
- Electronics are multi-fuse protected
- Enclosed electric-hydraulic power system
- Pallet-jack style steering wheels
- Extended forks accommodate wide tires and deep wheel configurations
- Multi-width wheel forks with locking pins
- Tandem 8" diameter polyurethane covered steel wheels

### PCL-18B (Set of 4)

#5175292



Column Capacity - 18,000 lbs.  
System Capacity - 72,000 lbs.  
Lifting Height - 71.5"

### PCL-18B (Set of 6)

#5175293



Column Capacity - 18,000 lbs.  
System Capacity - 108,000 lbs.  
Lifting Height - 71.5"

### PCL-18B (Set of 8)

#5175294

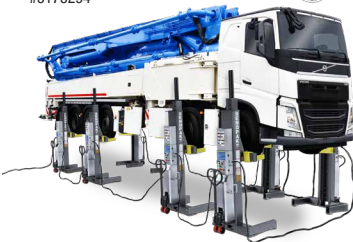

Column Capacity - 18,000 lbs.  
System Capacity - 144,000 lbs.  
Lifting Height - 71.5"

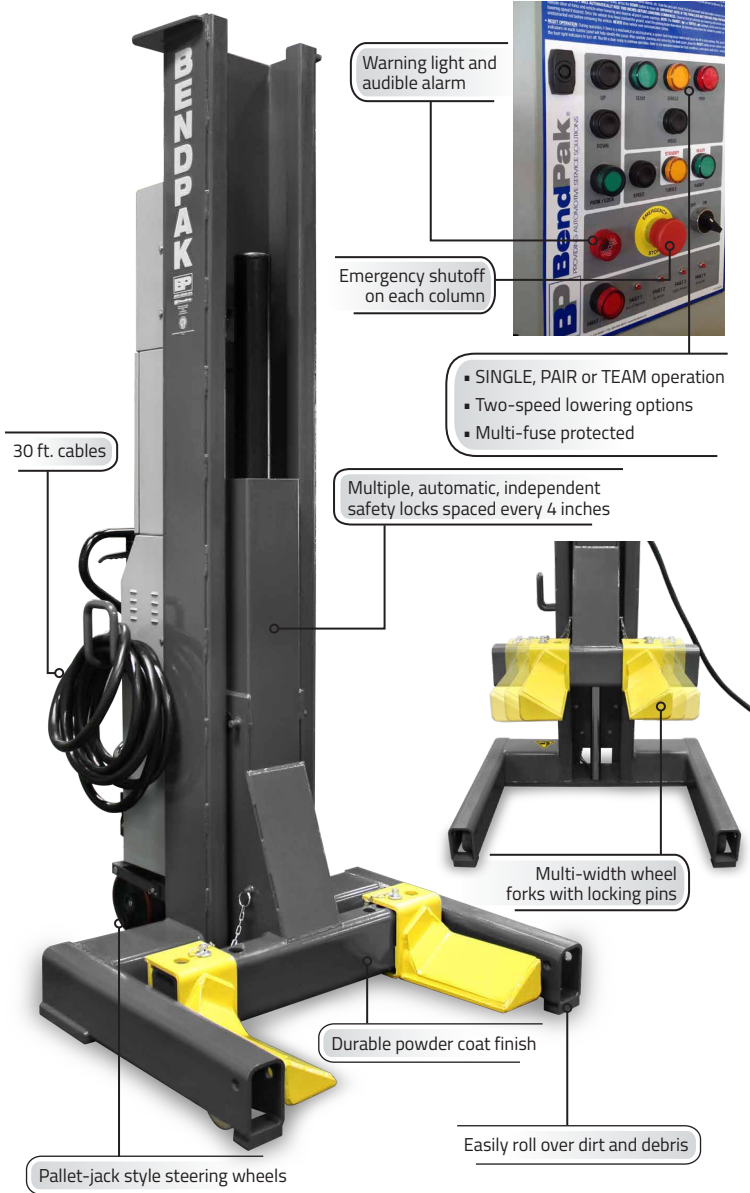

# Low-Rise / Mid-Rise / Full-Rise

## SERIES FEATURES:



**MD-6XP Model**  
Multi-piece Adapter Set



**SP-7X & All Low-Rise Models**  
1.5" Rubber Lift Blocks



**Portable Models**  
Mobile Power Cart

### LR-60 Low-Rise Lift

#5175729



Comes standard  
with rubber lift blocks

Lifting Capacity - 6,000 lbs.  
Lift Pad Dimensions - 18" x 52"  
Height Range - 3.5" - 25"

### LR-60P Low-Rise Portable Lift

#5175728



Comes standard  
with rubber lift blocks

Lifting Capacity - 6,000 lbs.  
Lift Pad Dimensions - 18" x 52"  
Height Range - 3.5" - 25"

### MD-6XP Mid-Rise Portable Lift

#5175730



Comes standard  
with adapter set

Lifting Capacity - 6,000 lbs.  
Adjustable Arms  
Height Range - 4.75" - 47"

### MD-6XP

#5175730



Perfect for light-duty trucks and cars

Durable powder coat finish

Safety lock bar with multiple lock positions

Adjustable arm assemblies

Solid steel torsion bar

Twin hydraulic cylinders

Multi-piece adapter set

Portable motor cart  
serves as tow handle

**Variability in Specifications and Features:** All product specifications and features listed in this catalog are for reference only. For a more accurate and comprehensive listing of product specifications and features, visit [www.bendpak.com](http://www.bendpak.com). The contents of this catalog are subject to change.

## ACCESSORIES:



1.5" Rubber Lift Blocks



3" Rubber Lift Blocks



6" Rubber Lift Blocks



LR-4A Arm Kit  
#5210944

### P9000LT Low-Rise Pit Lift

#5175133



Comes standard  
with rubber lift blocks

Lifting Capacity - 9,000 lbs.  
Lift Pad Dimensions - 24" x 58.5"  
Height Range - 4" - 24"

### P9000LTF Low-Rise Pit Lift Flush Mount

#5175155



Comes standard  
with rubber lift blocks

Lifting Capacity - 9,000 lbs.  
Lift Pad Dimensions - 24" x 58.5"  
Height Range - 4" - 24"

### Optional P-9000 Series Telescoping Arm Kit

#5210194



Capacity / Each arm - 2,250 lbs.  
(4) Lift Arms • (4) Contact pads

### LR10000 Low-Rise Lift

#5175232



Comes standard  
with 8-pc. adapter set

Lifting Capacity - 10,000 lbs.  
Lift Pad Dimensions - 24" x 53"  
Height Range - 4.5" - 23"

### MDS-6LP Mid-Rise Scissor Lift

#5175226



Comes standard  
with rubber lift blocks

Lifting Capacity - 6,000 lbs.  
Lift Pad Dimensions - 19" x 67"  
Height Range - 5" - 44"

### MDS-6LPF Mid-Rise Scissor Flush Mount

#5175227



Comes standard  
with rubber lift blocks

Lifting Capacity - 6,000 lbs.  
Lift Pad Dimensions - 19" x 67"  
Height Range - 5" - 44"

### SP-7XE Full-Rise Scissor Lift

#5175424



Comes standard  
with rubber lift blocks

Capacity - 7,000 lbs.  
Lift Pad Dimensions - 22" x 62.5"  
Height Range - 6.5" - 70.5"

### SP-7XEF Full-Rise Flush Mount Scissor Lift

#5175425



Comes standard  
with rubber lift blocks

Capacity - 7,000 lbs.  
Lift Pad Dimensions - 22" x 62.5"  
Height Range - 6.5" - 70.5"

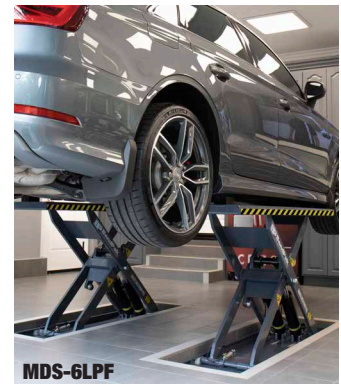

MDS-6LPF

# Portable Lifts

## ACCESSORIES:



**Wall Hanger Set**  
#5210199



**Truck Adapter Kit**  
#5150561



**Frame Extensions**  
#5620291



**ATV Lift Kit**  
#5150006

**3500SLX**  
**3,500-lb. Capacity**  
**Portable Car Lift**

#5175010



**5000TL**  
**5,000-lb Capacity**  
**Portable Car Lift**

#5175630

**5000TLX**  
**5,000-lb. Capacity**  
**Portable Car Lift**

#5175635



Lifting Height - 3" - 21"  
Frame Width - 10.5"  
Frame Length - 62.5"



Lifting Height - 3" - 24"  
Frame Width - 11"  
Frame Length - 70"



Lifting Height - 3" - 24"  
Frame Width - 11"  
Frame Length - 76"

**6000ELX**  
**6,000-lb. Capacity**  
**Portable Car Lift**

#5175650



**7000TL**  
**7,000-lb. Capacity**  
**Portable Car Lift**

#5175640



**7000TLX**  
**7,000-lb. Capacity**  
**Portable Car Lift**

#5175645



Lifting Height - 3.5" - 24.5"  
Frame Width - 12.5"  
Frame Length - 86.75"



Lifting Height - 3.5" - 24.5"  
Frame Width - 12.5"  
Frame Length - 70.75"



Lifting Height - 3.5" - 24.5"  
Frame Width - 12.5"  
Frame Length - 76"

## QuickJack Features

- Extended block trays
- Zero-leak fittings
- Open-center design
- 14-gauge welded steel frames
- Integrated power-assist canisters
- Quick-connect/disconnect hoses
- Includes eight piece set of adjustable rubber lift blocks
- Remote pendant control
- Steel mounted urethane wheels
- Dual-position automatic safety lock bars



**6000ELX**

**QUICKJACK™**

# MaxJax Series Features & Specifications

## Portable 2-Post Lifts

### SERIES FEATURES:

- 6,000-lb Lifting capacity
- Maximum lifting height - 50.5"
- Minimum pad height - 4.5"
- Lock positions - 7 (every 3")
- Overall height - 89.5"
- Drive-thru clearance - 74" - 104"
- Motor - 110 VAC / 50-60 Hz / 1 Ph
- Strong steel construction
- Direct-drive, low-pressure cylinders
- Maintenance-free slide blocks
- Quick-disconnect self-sealing hose connection
- Built-in wheels that allow you to move it easily
- Automatic safety locks
- Optional motorcycle adapters are available

### Motorcycle Adapter



#5215917

### M6K Portable Two-Post Lift Standard Package

#5175331



#### PACKAGE INCLUDES:

M6K Portable Lift With All Standard Accessories

### M6K Portable Two-Post Lift Deluxe Package

#5175335



#### PACKAGE INCLUDES:

M6K Portable Car Lift  
Upright Oil Drain  
Rolling Work Seat

### M6K Portable Two-Post Lift Supreme Package

#5175334



#### PACKAGE INCLUDES:

M6K Portable Car Lift / Upright Oil Drain  
Rolling Work Seat / 5" Tall Adapter Pins Frame  
Cradle Pads

### M6K Portable Two-Post Lift Ultimate Package

#5175333



#### PACKAGE INCLUDES:

M6K Portable Car Lift / Upright Oil Drain  
Adjustable Creeper / 5" Tall Adapter Pins  
Frame Cradle Pads

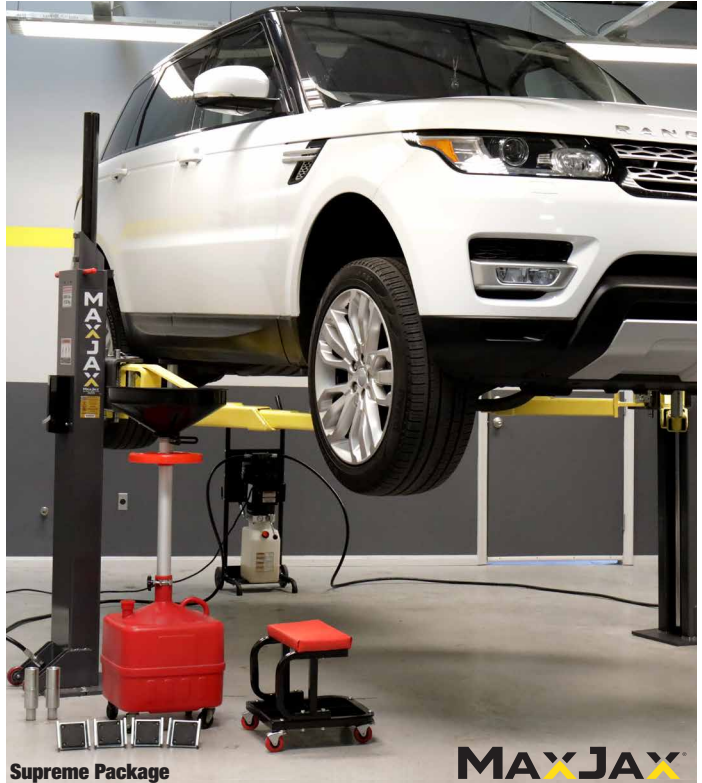

Supreme Package

MAXJAX





**BP BendPak®**





**BENDPAK**

**BP**

**BENDPAK**

**BP**

**PAK**

**BP**

**PAK**

**BP**

# Parking & Storage Lifts

## A6 SERIES FEATURES:

- 6,000-lb. lifting capacity
- Simple push button controls
- Dual, direct drive hydraulic lifting cylinders
- Automatic safety locks engage at six different parking heights
- Minimal footprint fits a typical parking space
- 100% hot-dipped, galvanized steel platform
- Accommodates cars, light trucks and SUVs

## HD-973P SERIES FEATURES:

- Perfect for parking, storage and service
- Perfect for cars, trucks, and SUVs
- 7,000 lb. capacity upper deck
- 9,000 lb. capacity lower deck
- Padded trip bar with limit switch prevents lower vehicle from making contact with upper platform
- Galvanized option available

### A6S Scissors Parking Lift

#5175274



### A6W Extra Wide Scissors Parking Lift

#5175282



## GALVANIZED OPTION AVAILABLE

A6S-G  
A6W-G



Capacity - 6,000 lbs.  
Lifting Height (Top Lock) - 81.25"  
Overall Width - 103" / Length - 143"

Capacity - 6,000 lbs.  
Lifting Height (Top Lock) - 81.25"  
Overall Width - 111" / Length - 144"

### HD-973P Tri-Level Parking Lift

#5175238



Capacity - 7K lbs. Top Deck / 9K lbs. Bot. Deck  
Runway (L) - 188.5" / Overall Height - 161"  
Width - 112" / Length - 242"

### HD-973PX Tri-Level Parking Lift Extended

#5175267



Capacity - 7K lbs. Top Deck / 9K lbs. Bot. Deck  
Runway (L) - 199" / Overall Height - 173"  
Width - 112" / Length - 252.25"

## GALVANIZED OPTION AVAILABLE

HD-973P-G  
HD-973PX-G



### PL-6000DC Two-Post Parking Lift

#5175427



Lifting Capacity - 6,000 lbs.  
Lifting Height - 82.5" / Overall Height - 126.5"  
Width - 100.25" / Length - 148.25"

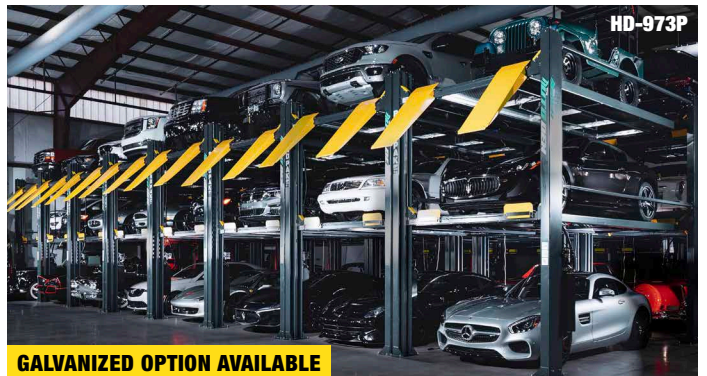

HD-973P

## GALVANIZED OPTION AVAILABLE

**Variability in Specifications and Features:** All product specifications and features listed in this catalog are for reference only. For a more accurate and comprehensive listing of product specifications and features, visit [www.bendpak.com](http://www.bendpak.com). The contents of this catalog are subject to change.

# Double Your Parking

**AGS**

#5175274

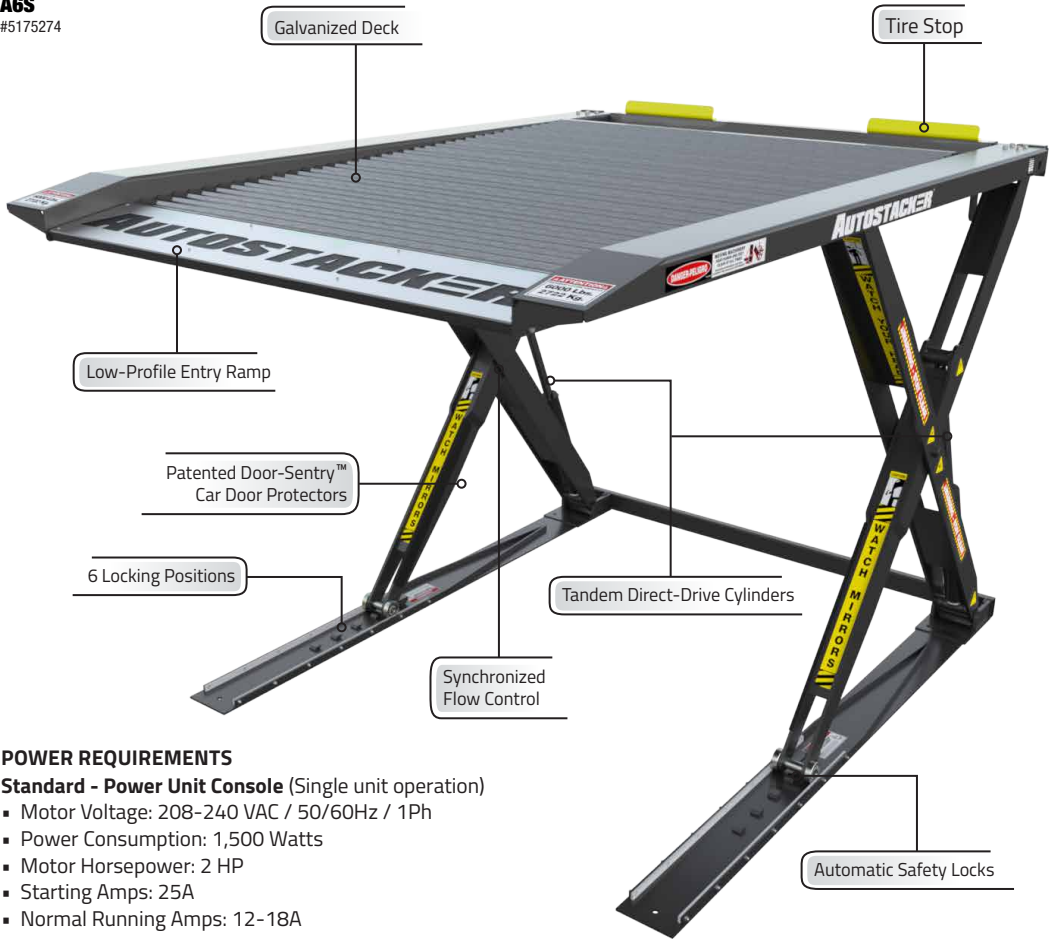

## POWER REQUIREMENTS

**Standard - Power Unit Console** (Single unit operation)

- Motor Voltage: 208-240 VAC / 50/60Hz / 1Ph
- Power Consumption: 1,500 Watts
- Motor Horsepower: 2 HP
- Starting Amps: 25A
- Normal Running Amps: 12-18A

**Optional multi-unit power unit console available** (Operates up to 14 lifts)



 See it on YouTube

**AUTOSTACKER**



# Multi-Platform Parking Lift

## PL-6KT FEATURES:

- 6,000-lb. capacity per deck
- Perfect for cars, light trucks and ATVs
- Rugged I-beam and C-channel construction
- Wide base plate for maximum stability
- Superstructure features durable powder coat finish
- Dual hydraulic cylinders with heavy-duty steel lifting cable
- Heavy-duty steel construction
- Reliable electric-hydraulic power system
- Features heavy-duty 3/8" aircraft cable
- Rugged 1-1/4" roller axes
- Simple controls
- Full-width platform to keep bottom vehicles protected

**PL-6KT**  
Triple Deck  
Platform Lift  
#5175154



- Lifting Capacity / Deck - 6,000 lbs.
- Overall Width - 308"
- Overall Length - 236.5"
- Platform Width - 82"
- Length of Platforms - 152"
- Drive Clearance - 93"
- Max. Rise - 89"

**BendPak.**



**Variability in Specifications and Features:** All product specifications and features listed in this catalog are for reference only. For a more accurate and comprehensive listing of product specifications and features, visit [www.bendpak.com](http://www.bendpak.com). The contents of this catalog are subject to change.

- High-speed lifting
- Oversized sheave diameter reduces cable fatigue
- Multi-position safety locks in each column
- Runways feature non-skid surface
- Independent backup slack-cable safety latches
- Built-in wheel stops



**PL-12000DP**  
Tandem  
Parking Lift  
#5175547



- Lifting Capacity / Deck - 6,000 lbs.
- Overall Width - 221.5"
- Overall Length - 242.5"
- Length of Runway - 183"
- Drive Clearance - 80.5"
- Max. Rise - 82"

**BendPak.**



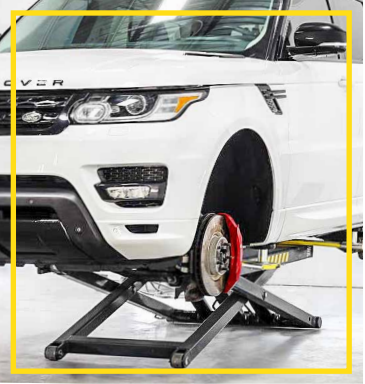
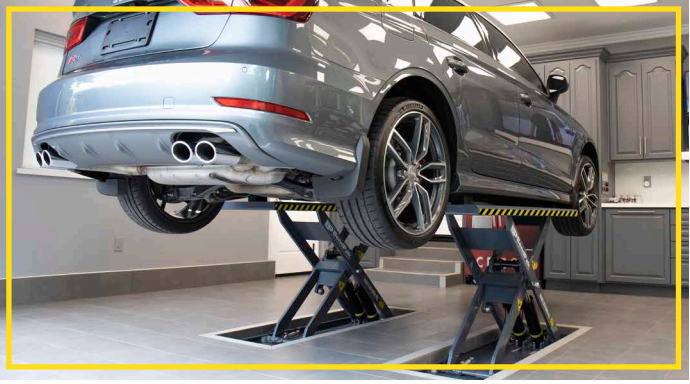

# JACKPAK<sup>®</sup>

ULTRA2500A

The Original **and Still**  
The Best.

## MEGA 2500 AMPS OF POWER!

Up To

**8.5L**  
Gas Engines

Up To

**6.5L**  
Diesel Engines

JackPak Model:  
**ULTRA2500A**

**NEW  
ARRIVAL**



**FREE**  
GPS Asset  
Tracker Included



USB-C / USB-A



**LITHIUM-ION**  
POWER TECHNOLOGY

## THE PERFECT ROADSIDE HELP



**JUMP STARTER**  
2500A



**AIR INFLATOR**  
150PSI



**LED FLASHLIGHT**  
300 Lumen



**POWER BANK**  
22,800mAh

### SPECIFICATIONS:

- Battery Capacity: 76Wh
- Starting Voltage: 12V
- Current: 1200A - 2500A
- Pressure Range:  
10 - 150 psi
- Battery Life:  
1000 Cycles
- Charging Time:  
4.5 - 8 Hours

### FEATURES:

- Built-In Air Compressor
- 5V USB Outlet for Small Electronic Devices
- LED Flashlight/  
Emergency Signal
- Lightweight &  
Compact Design
- Fits Under Seat or  
Glove Compartment

### INCLUDES:

- Jumper Cable Attachment
- Air Hose w/ Heavy-Duty  
Nylon Abrasion Sheathing
- USB-A to USB-C Cable
- Nozzle Adapters
- Carrying Case



Check Out the Full  
JACKPAK Line-up!



# Pipe Benders

## SERIES FEATURES:

- 3-1/3" min. bending radius
- 5" max. bending radius
- Canister style hydraulic filter
- 5 Hp / 208 - 230 VAC motor
- Manual or automatic controls
- Drop-in swaging collars
- Twist lock tooling
- ANSI 92.2 Cylinders
- Quick release bending dies
- Bending heads to within .002"
- Bending and end finishing operation
- Adjustable back gate pressure
- 180° bending capacity
- One piece solid steel barrel
- Direct drive high speed 4 GPM pump
- Tool trays
- Large fluid reservoir
- Filtered hydraulic system
- Oil sight gauges
- 1/2" high pressure hose
- Wide variety of tooling available

**BB-2-DLX-601** #5115150



Bending Controls - Manual  
Clampless Swager - Internal Expander  
Deluxe 302 Tooling Package

**1302BAS-DLX-601** #5115180



Bending Controls - Semi-Automatic  
Clampless Swager - Internal Expander  
Deluxe 302 Tooling Package

**1302BA-DLX-601** #5115121



Bending Controls - Digital Automatic  
Clampless Swager - Internal Expander  
Deluxe 302 Tooling Package

**BB-2-MET-503** #5115120  
**BB-2-MET-601** #5115122



Bending Controls - Manual  
Clampless Swager - Internal Expander  
Deluxe Metric Tooling Package

**1302BAS-MET-503** #5115123  
**1302BAS-MET-601** #5115124



Bending Controls - Semi-Automatic  
Clampless Swager - Internal Expander  
Deluxe Metric Tooling Package

**1302BA-MET-503** #5115126  
**1302BA-MET-601** #5115127



Bending Controls - Digital Automatic  
Clampless Swager - Internal Expander  
Deluxe Metric Tooling Package

**300-1 Die Package**

#5105570



6-Piece Set  
Bends 3" OD Tubing





# Air Compressors

## SERIES FEATURES:

- 80 & 120 Gallon vertical tank
- 2-stage pump
- ASME rated tank
- Electric mag-starter
- Fan-type flywheel
- Fully enclosed belt guard
- Tapered roller bearings
- Forged ductile iron crankshaft
- Corrosion resistant tubing for coolers, separators and valves.
- 100% cast iron Elite pump
- Cast iron cylinders and heads with deep cooling fins
- Forced-air after cooler
- Oil sight gauge
- Automatic pressure switch
- ASME rated overload pressure safety valve
- Pressure gauge with valve
- Oversized replaceable air filters
- Automatic start / stop

### 5 HP MODEL

**TSP-580V-601**

#5179111



Voltage - 208-230 V / 60 Hz / 1 Ph  
Horsepower - 5 Hp  
Maximum CFM - 17 / 175 psi  
Tank - 300L / 80 Gal / Vertical

### 7.5 HP MODEL

**VMP-7580V-601**

#5179112



Voltage - 208-230 V / 60 Hz / 1 Ph  
Horsepower - 7.5 Hp  
Maximum CFM - 26 / 175 psi  
Tank - 300L / 80 Gal / Vertical

### 10 HP MODEL

**VMP-10120V-603**

#5179114



Voltage - 208-230 V / 60 Hz / 3 Ph  
Horsepower - 10 Hp  
Maximum CFM - 35 / 175 psi  
Tank - 454L / 120 Gal / Vertical

**CE ANSI**

Extreme-duty four-cylinder cast iron pump

Protective pulley cover

Electric motor with cooling fan

Air cooling assembly

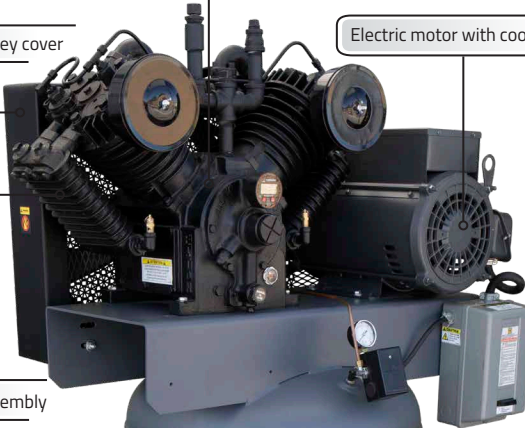

# PATRIOT SERIES

**PROUDLY MADE IN THE USA**

When a tough application calls for rugged dependability, count on BendPak Patriot Series™ air compressors to work as hard as you do. We make all of our compressors in an ISO 9001-registered manufacturing facility in Clayton Ohio, where we ensure that every compressor delivers the durability and performance you expect. Our highly efficient Patriot Series air compressors feature rugged, low-rpm 100% cast-iron pumps, ASME tanks, copper piping for cooler operation and American made motors and starter. Made in America also means that they're are backed by one of the most comprehensive warranties in the industry.

# Power Units



## Power Units Explained

Ranger™ AC hydraulic power units are self-contained, dependable sources of hydraulic power that come standard with an abundance of features and benefits in a durable and economic package. These high-quality power units are ideal for industrial AC applications, such as auto lifts, elevated work platforms, scissor lifts, dock levelers, conveyors, packaging machines, machine tools, compactors, crimping machines, presses, robotic equipment, tailgate lifts, dump bodies, cab tilts, emergency backup units, snowplows, log-splitters, harvesting machinery, lift platforms, scaffolds, presses, waste compactors, car lifts, medical and dental field lifts and more.

### E1.2B3F1 Power Unit

#5585435



### E2.1F3H1 Power Unit

#5585285



Gal Reservoir - 1.6 / PRV - 2500  
Motor - 1.5 HP / 220V - 60 Hz - 1PH  
CE Listed

Gal Reservoir - 3.6 / PRV - 2650  
Motor - 2.5 HP / 208-230V-50/60 Hz-1PH  
UL/ETL Listed

### F2.1F3H1 Power Unit

#5585280



## FEATURES:

- UL / ETL Listed (except model E1.2B8F1)
- Vertical Design
- Built-in throttle and buffer valves reduce pre-load pressure
- Integrated fixed-setting pressure relief valve
- Submerged pump
- Spare pressure port
- Multi-hole adapter plate adapts to a wide variety of mounting applications
- Suction-strainer
- Breather and fill-cap



**NEED REPLACEMENT PARTS? WE HAVE THEM TOO.**  
**CALL US TOLL FREE 1-800-253-2363**



# Wheel Service

## DT-50A FEATURES:

- Alloy steel mount and demount head
- Single-assist tower
- High torque electric turntable
- Enhanced bead breaker blade
- Inflation gauge w/ integrated air dump valve
- Forged steel foot pedals

## MB-240X FEATURES:

- Basic dynamic wheel balancing function
- Low-cost of ownership
- Computerized electronic data display for each balance
- Perfect for small garages, car-hobby garages, or a backup

## DB-70 FEATURES:

- Six dynamic balancing modes and one static balancing mode
- Manual wheel offset distance setting
- Auto-start when hood is lowered
- Wheel holding manual brake pedal
- Quick-release and mount hub nut
- LED rolling wheel weight displays

### DT-50 Tire Changer

#5140158



Internal Clamping - 14" - 26"  
External Clamping - 12" - 22"  
Maximum Tire Diameter - 47"

### DT-50A Tire Changer w/ Assist Arm

#5140157



Internal Clamping - 14" - 26"  
External Clamping - 12" - 22"  
Maximum Tire Diameter - 47"

### DB-70 Automatic Wheel Balancer

#5140159



Wheel Diameter - 10" - 28"  
Max. Tire Diameter - 49"  
Max Tire Weight - 150 lbs.

### MB-240X Manual Wheel Balancer

#5140161



(Stand NOT Included)

Wheel Diameter - 12" - 24"  
Max. Tire Diameter - 31.5"  
Max Tire Weight - 150 lbs.

### DT-50A & MB-240X Package Deal

#5140164



Package Includes:  
DT-50A / MB-240X  
(Balancer Mounts to Changer Tower)

### DT-50A DB-70 & Weights Package Deal

#5140162



Package Includes:  
DT-50A / DB-70  
Wheel Weight Roll

### Mounting Stand Fits MB-240X

#5328501



Height - 25" / Width - 23.5"  
Mounting Top Plate - 16"  
Cone Holders - 4 (spaced every 6")

### DT-50



# Tire Changers

## GET MORE - SPEED - HORSEPOWER - TORQUE

Modern tires are *more* stubborn than ever. If you want to get the job done quickly and correctly than you need a tire changer that has **more**. Equipped with 220VAC, Ranger's latest tire changers deliver more of everything. With more speed, more horsepower and gobs more torque, you can break beads and swap tires on even the most difficult tires in your shop. Plus the powerful, high-torque electric turntables, increased speed and reversible direction mean quicker tire removal and installation, giving you more bang for your buck. Important accessories come standard, like a multi-piece plastic wheel protector kit that includes turntable jaw covers, bead-breaker blade boots and specialized mount/demount head covers to help protect delicate wheels. With all of the reliable features that Ranger tire changers are known for, and now even **more power**, why settle for less?

### R745 Swing-Arm Tire Changer

#5140148

**VOLTAGE**  
110VAC  
OR  
220VAC



**NOTE:**  
Jet blast  
bead seater  
NOT INCLUDED

### R76LT Tilt-Back Tire Changer

#5140144



### R980XR Swing-Arm Tire Changer

#5140146



Internal Clamping - 12" - 20"  
External Clamping - 10" - 16"  
Maximum Tire Diameter - 36"

Internal Clamping - 10" - 30"  
External Clamping - 8" - 26"  
Maximum Tire Diameter - 43"

Internal Clamping - 10" - 30"  
External Clamping - 8" - 26"  
Maximum Tire Diameter - 50"

### R980AT Swing-Arm Power Assist

#5140147



### R76ATR Tilt-Back Power Assist

#5140140



### RimGuard™ Wheel Clamps



Internal Clamping - 10" - 30"  
External Clamping - 8" - 26"  
Maximum Tire Diameter - 50"

Internal Clamping - 10" - 30"  
External Clamping - 8" - 26"  
Maximum Tire Diameter - 43"

### R80EX Dual-Assist Tilt-Back Tire Changer

#5140139



### R26FLT Super-Duty Truck Tire Changer

#5140137



### RV1 Wheel Guardian™ Tire Changer

#5140138



Internal Clamping - 13" - 34"  
External Clamping - 10" - 30"  
Maximum Tire Diameter - 47"

Drive System - Electric / Hydraulic  
Maximum Rim Diameter - 14" - 26"  
Maximum Tire Diameter - 63"

Rim Diameter Range - 13" - 30"  
Max. Wheel Width - 15"  
Max. Tire Diameter - 47"

**Variability in Specifications and Features:** All product specifications and features listed in this catalog are for reference only. For a more accurate and comprehensive listing of product specifications and features, visit [www.bendpak.com](http://www.bendpak.com). The contents of this catalog are subject to change.

## ACCESSORIES:



**Plastic Duckhead**  
#5150523



**ATV / Motorcycle Duckhead**  
#5327457



**RimGuard™ Wheel Clamps**  
#5328311



**Elevating Clamps**  
#5328425



**RWL-150T Wheel Lift**  
#5150355

## R80EX Dual-Assist Tilt-Back Tire Changer

#5140139



**ALL RANGER TIRE CHANGERS FEATURE:**  
Polymer & Urethane  
RimGuard™ Wheel Clamps  
(Excludes R745)

See it on the BendPak / Ranger YouTube Page



# Wheel Balancers

## DST-2420 FEATURES:

- Dynamic, Static and Performance Alloy settings
- Automatic round-off with top-dead-center weight position indicator
- Hardened-steel 36 mm shaft
- Quick-release hub nut
- Multi-user save function

## DST30P FEATURES:

- Ergonomic control board and easy-to-read LED display
- Multi-user save function
- Automatic braking
- Low RPM balancing speed and rapid six-second cycle time
- Self-calibration function

## DST-64T FEATURES:

- Precision DataWand™ and inner data arm
- Low RPM balancing speed and rapid six-second cycle time
- Automatic braking
- LED inner wheel target light
- Manual or automatic start
- Self-calibration function

**DST-2420**  
Wheel Balancer  
#5140156



**DUAL VOLTAGE**  
110V / 220V

Max. Wheel Diameter - 10" - 30"  
Max. Tire Diameter - 47"  
Max. Tire Weight - 145 lbs.

**DST30P**  
Wheel Balancer  
#5140154



**DUAL VOLTAGE**  
110V / 220V

Max. Wheel Diameter - 8" - 30"  
Max. Tire Diameter - 50"  
Max. Tire Weight - 150 lbs.

**DST-64T**  
Wheel Balancer  
3D Quick-Touch™  
DataWand™  
#5140152



**VOLTAGE**  
220VAC

Max. Wheel Diameter - 10" - 30"  
Max. Tire Diameter - 50"  
Max. Tire Weight - 150 lbs.

**DST642D**  
Wheel Balancer  
#5140153



**VOLTAGE**  
220VAC

Max. Wheel Diameter - 10" - 30"  
Max. Tire Diameter - 50"  
Max. Tire Weight - 150 lbs.

**RB24T**  
Truck Wheel Balancer  
#5140149



**VOLTAGE**  
380VAC

Max. Wheel Diameter - 30"  
Max. Tire Diameter - 50"  
Max. Tire Weight - 400 lbs.



**Truck Cone Kit**  
#5150555



Double-sided centering cone fits hub sizes 4.75" - 6.75"

**Motorcycle Shaft Kit**  
#5150320



Fits DST-2420 and DST-64T  
Includes: Universal wheel clamp, shaft, centering cones, spacers and spin-on nut

**Lug Bolt Kit**  
#5150020



8-pc. kit  
Includes: Centering pin adapters, flange plate kit and measuring caliper

# Wheel Balancers Features & Specifications

## Laser-Spot Balancer

### INFORMATION:

The Ranger LS43B wheel balancer handles wheels up to 43 inches in diameter. The average cycle time is just 7 seconds, making it one of the fastest and most reliable balancing machines ever built. Top-of-the-line technology and features take all of the guesswork and human error out of wheel balancing. The standout feature on this model, of course, is Ranger's exclusive 3D Quick-Touch™ Laser-Spot™ technology. Using this feature the LS43B highlights the pinpoint location at which operators should place the minimal amount of weight in order to achieve a perfect balance at the 6 o'clock position.

### LS43B FEATURES:

- Dynamic, Static and Performance Alloy settings
- Manual or automatic start
- Automatic braking
- Low RPM balancing speed and rapid six-second cycle time
- Self-calibration function

### LS43B Wheel Balancer 3D Quick-Touch™ Laser-Spot™

#5140151

Max. Wheel Diameter - 10" - 30"  
Max. Tire Diameter - 47"  
Max. Tire Weight - 145 lbs.  
Wheel Width Cpty. - 2" - 18"  
Balancing Speed - 180 RPM

**DUAL  
VOLTAGE**  
110V / 220V

Includes FREE Wheel  
Weight Starter Kit

#### INCLUDES TOOLING KIT



#### OPTIONAL Clip-On Steel Wheel Weights

Sold separately



25 ea.

0.25oz, 0.50oz, 0.75oz, 1oz, 1.25oz, 1.5oz,  
1.75oz, 2oz, 2.25oz, 2.5oz, 2.75oz, 3oz

LED Wheel Weight Displays

DataWand™ for Automatic  
Wheel Data Entry

User-Friendly Operation

Laser-Spot™ Technology



# Brake Lathes

## RL-8500XLT FEATURES:

- Extended capacity spindle can be used on brake drums 10" deep
- Rear bushing location provides extra support for the arbor
- Capable of truing even the heaviest drum rotors
- Optional truck adapter kit available
- Simple ergonomic controls designed for minimal operator movement
- Precision electric DC servo motors designed to meet the demanding requirements of industrial motion control
- Quick-Change Adapter-Plus system
- Works on all cars or trucks, both foreign and domestic, with hubless drums, rotors (center hole sized 2-5/32" – 4") and composite rotors (center hole sized 4" – 6.25")
- Precision twin cutter tools and a quick drum-to-rotor changeover

### RL-8500XLT Combination Brake Lathe Package Super-Duty

#5150080



### Light & Medium Truck Adapter Set

#5150171



### Brake Lathe Truck Adapter Kit

#5150161



Max. Rotor Thickness - 2.5"  
Max. Rotor Diameter - 17"  
Max. Drum Diameter - 28"

A) Small Truck Cone - 4.125" x 5.25"  
B) Large Truck Cone - 5.125" x 6.25"  
C) Truck Plate - 7.40" OD

Fully Equipped Multi-Piece Set  
Accommodates Medium & Full Size Trucks

### RL-8500 Combination Brake Lathe Package

#5150066

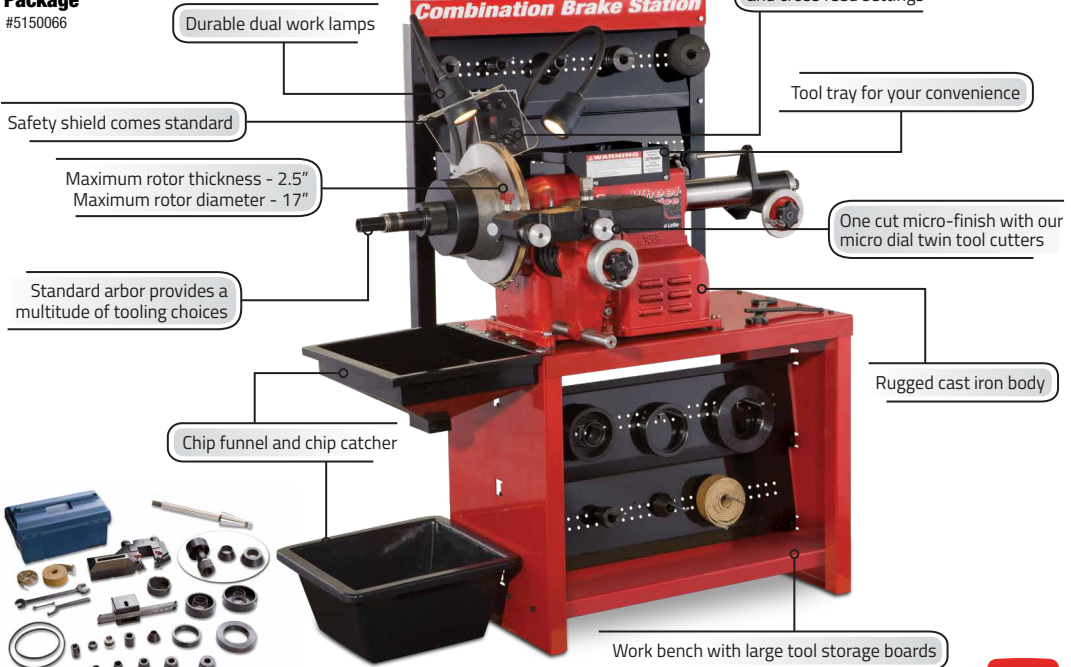

Durable dual work lamps

Infinitely variable spindle and cross feed settings

Safety shield comes standard

Tool tray for your convenience

Maximum rotor thickness - 2.5"  
Maximum rotor diameter - 17"

One cut micro-finish with our micro dial twin tool cutters

Standard arbor provides a multitude of tooling choices

Rugged cast iron body

Chip funnel and chip catcher

Work bench with large tool storage boards

Fully equipped tool package comes standard

See it on the BendPak / Ranger YouTube Page





# Wheel Aligner

## 3DP4100R FEATURES:

- User-Friendly and Time Saving Features
- Self-balancing, variable height camera lift system is built with precision bearing slides for easy adjustment
- High-resolution drive-on approach camera provides full on-screen frontal view of vehicle driving on lift platforms
- Commercial-grade cameras are designed with full frame optical lenses that ensure accuracy and stability

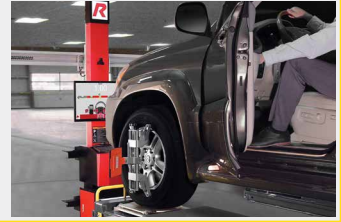

**3DP4100R**  
**Target 3D Pro™**  
**3D Imaging**  
**Wheel Aligner**  
 #5140101



**FREE SET-UP & ON-SITE TRAINING**



**Power Requirements:**  
 115 VAC, 1Ph, 50/60 Hz, 8 amp  
 230 VAC, 1Ph, 50/60 Hz, 8 amp

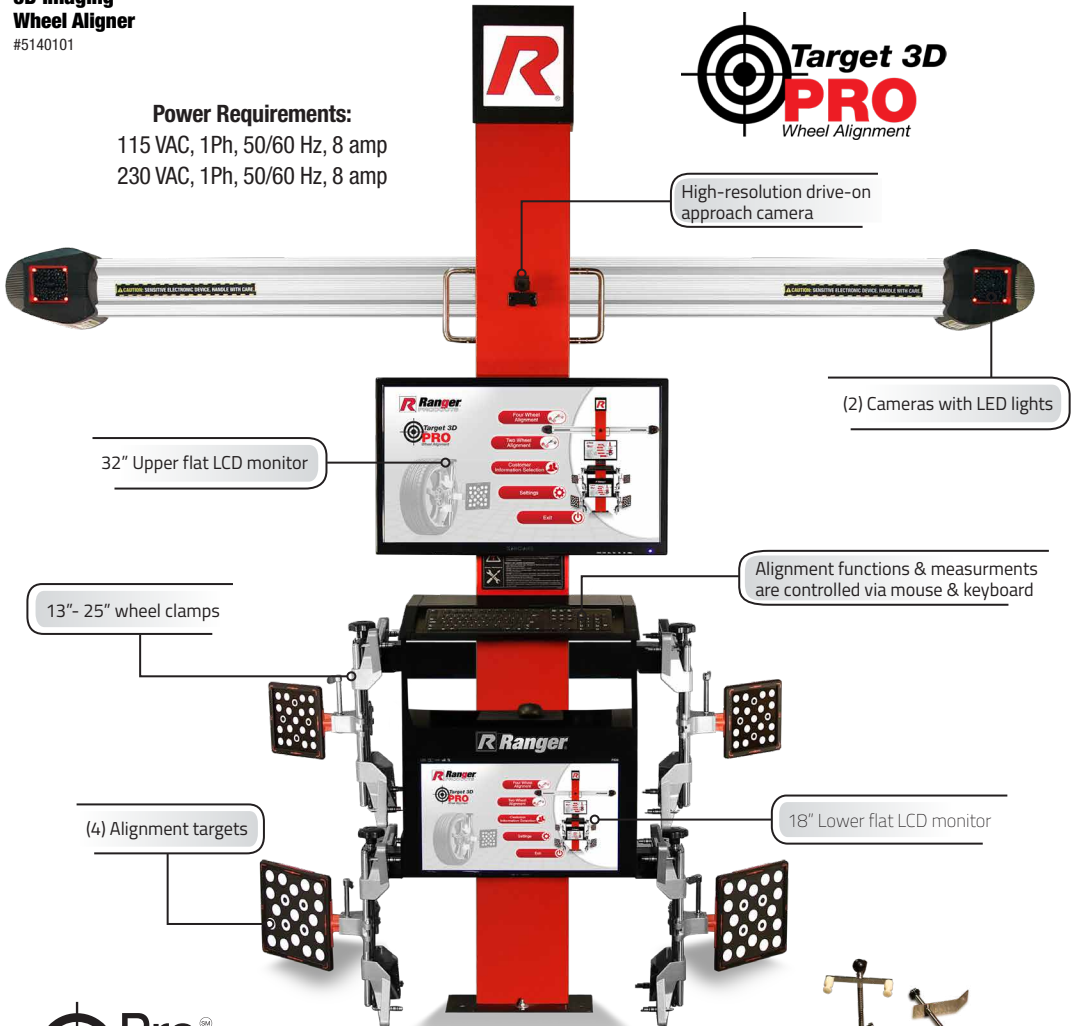

**INCLUDES:**

- Steering wheel lock
- Brake pedal depressor



# Jacks & Lifting

## INFORMATION:

Ranger's wide array of multi-purpose floor jacks just keeps getting larger and more diverse. Our floor jacks have maximum capacities ranging from 3,000 to 60,000 lbs. and come in a variety of styles, like quick-pump and low-profile. No matter which one you choose, Ranger floor jacks offer incredible lifting power and top-notch construction that you can count on to never let you down. Our impressive line of floor jacks are carefully designed to accommodate a wide spectrum of weight capacities and lifting applications, easily lifting just about anything that needs service.

**RFJ-3000AL**  
**1.5 Ton Aluminum**  
**Racing Floor Jack**

#5150061



Capacity - 3,000 lbs.  
Height - 3.5" - 17.5"  
Chassis Length - 24"

**RFJ-3000LPF**  
**1.5 Ton Super-Long**  
**Floor Jack**

#5150060

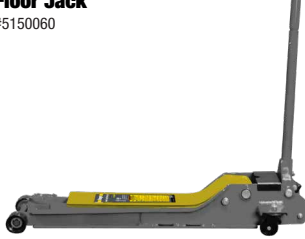

Capacity - 3,000 lbs.  
Height - 2.75" - 24"  
Chassis Length - 34"

**RFJ-4000AL**  
**2 Ton Aluminum**  
**Racing Floor Jack**

#5150085



Capacity - 4,000 lbs.  
Height - 3.5" - 17.75"  
Chassis Length - 24"

**RFJ-5000HD**  
**2.5 Ton Heavy-Duty**  
**Commercial Grade**  
**Floor Jack**

#5150056



Capacity - 5,000 lbs.  
Height - 3" - 20"  
Chassis Length - 26"

**RFJ-3TP**  
**3 Ton Professional**  
**Floor Jack**

#5150440



Capacity - 6,000 lbs.  
Height - 5.25" - 19.25"  
Chassis Length - 26"



**RFJ-3000LPF**

**RFJ-3T**  
**3 Ton Racing Style**  
**Floor Jack / Plunger-U-Joint**

#5150414



Capacity - 6,000 lbs.  
Height - 4.75" - 20.5"  
Chassis Length - 28"

**RFJ-3TQP**  
**3 Ton Quick-Pump**  
**Floor Jack**

#5150418



Capacity - 6,000 lbs.  
Height - 5" - 19.75"  
Chassis Length - 25.5"

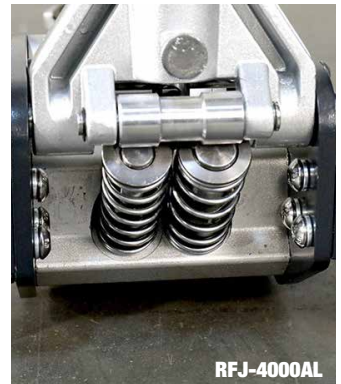

**RFJ-4000AL**

**Variability in Specifications and Features:** All product specifications and features listed in this catalog are for reference only. For a more accurate and comprehensive listing of product specifications and features, visit [www.bendpak.com](http://www.bendpak.com). The contents of this catalog are subject to change.

**GALLERY:**



**RFJ-6HD**  
**3 Ton "Low Rider"**  
**Floor Jack**

#5150446



Capacity - 6,000 lbs.  
Height - 3.625" - 21"  
Chassis Length - 27"

**RFJ-10TL**  
**10 Ton Long Frame**  
**Floor Jack**

#5150434



Capacity - 20,000 lbs.  
Height - 7" - 23"  
Chassis Length - 61"

**RBJ-30TL**  
**30 Ton Telescoping**  
**Air Bottle Jack**

#5150443



Capacity 1st Stage - 60,000 lbs.  
Capacity 2nd Stage - 30,000 lbs.  
Height - 6.5" - 12" / Chassis Length - 22.5"

**RTJ-1100**  
**1/2 Ton**  
**Transmission**  
**Jack**

#5150442



Capacity - 1,100 lbs.  
Height - 45" - 72"  
Base - 24" x 24"

**RTJ-1**  
**1 Ton**  
**Transmission**  
**Jack**

#5150404



Capacity 1st Stage - 2,000 lbs.  
Capacity 2nd Stage - 1,000 lbs.  
Height - 37" - 73" / Base - 39" x 39"

**RTJ-3000**  
**1.5 Ton**  
**Transmission**  
**Jack**

#5150406



Capacity 1st Stage - 3,000 lbs.  
Capacity 2nd Stage - 2,000 lbs.  
Height - 35.5" - 71.5" / Base - 34" x 34"



**RFJ-4000AL**

# Jacks & Lifting

## SERIES FEATURES:

- Welded steel construction for maximum durability
- Safety ratchet design ensures stands remain locked under load
- Perfect for holding drivetrain or exhaust components in position
- Sold in pairs
- Quick-adjust spin handle with thrust bearing
- Wide base provides maximum stability
- Thick, rubber adjustable pad for maximum support
- Convenient handle and column release
- Hardened ACME screw for easy adjustment
- Tripod design evenly distributes weight
- Pneumatically operated wheel lift
- One-handed lever control
- Heavy-duty steel casters
- Bearing mounted slider
- Stabilizes vehicles raised on lifts
- Heavy-steel construction for maximum durability

### RJS-3T 3 Ton Jack Stands (Set of 2)

#5150115



Holding Capacity - 6,000 lbs.  
Height - 11.5" - 17"  
Base Dimensions - 7" x 7.5"

### RJS-6T 6 Ton Jack Stands (Set of 2)

#5150120



Holding Capacity - 12,000 lbs.  
Height - 15.5" - 24.5"  
Base Dimensions - 9" x 10.5"



RJS-3T

### RJS-1T High Reach Jack Stand

#5150183



Holding Capacity - 1,650 lbs.  
Height - 54.5" - 80.5"  
Base Dimensions - 12" Diameter

### RJS-1TF High Reach Jack Stand Foot Operated

#5150185



Holding Capacity - 1,650 lbs.  
Height - 54.5" - 80.5"  
Base Dimensions - 12" Diameter

### RJS-2TH Tripod Jack Stand

#5150125



Holding Capacity - 4,000 lbs.  
Height - 55" - 87"  
Base Dimensions - 24" x 24"

### MLS-18 Mobile Jack Stand

#5175001



Holding Capacity - 18,000 lbs.  
Height - 48.75" - 74.5"  
Base Diameter - 32"

### RWL-150T Pneumatic Wheel Lift

#5150355



Fits R980XR & R980AT

Lifting Capacity - 150 lbs.  
Pneumatic Operation  
Welded Steel Construction



RWL-150T

# Lifting Features & Specifications

## Motorcycle Lifts

### SERIES FEATURES:

- Constructed out of 12-gauge steel
- Pneumatic lifting cylinder
- Durable powder coat finish
- Adjustable front wheel vise
- Drop-away rear wheel deck
- Easy ramp(s) removal
- Front and side extensions standard
- Built-in retractable swivel casters
- Full travel automatic safety locks
- Single hydraulic lifting cylinder
- Side decks can be easily removed
- Diamond-plate approach ramps
- Air powered hydraulic pump operation
- Multiple locking positions



**RML-1500XL  
Extended  
Motorcycle  
Lift**  
#5150605



Lifting Capacity - 1,500 lbs.  
Height - 7.75" - 45" / Table Width - 29.5" - 51"  
Table Length - 79.5" - 99.75"

**RML-1100  
Motorcycle Jack**  
#5150071



Lifting Capacity - 1,100 lbs.  
Height - 3.5" - 16"  
Top Dimensions - 6" - 17.75"

**RML-1500XL**

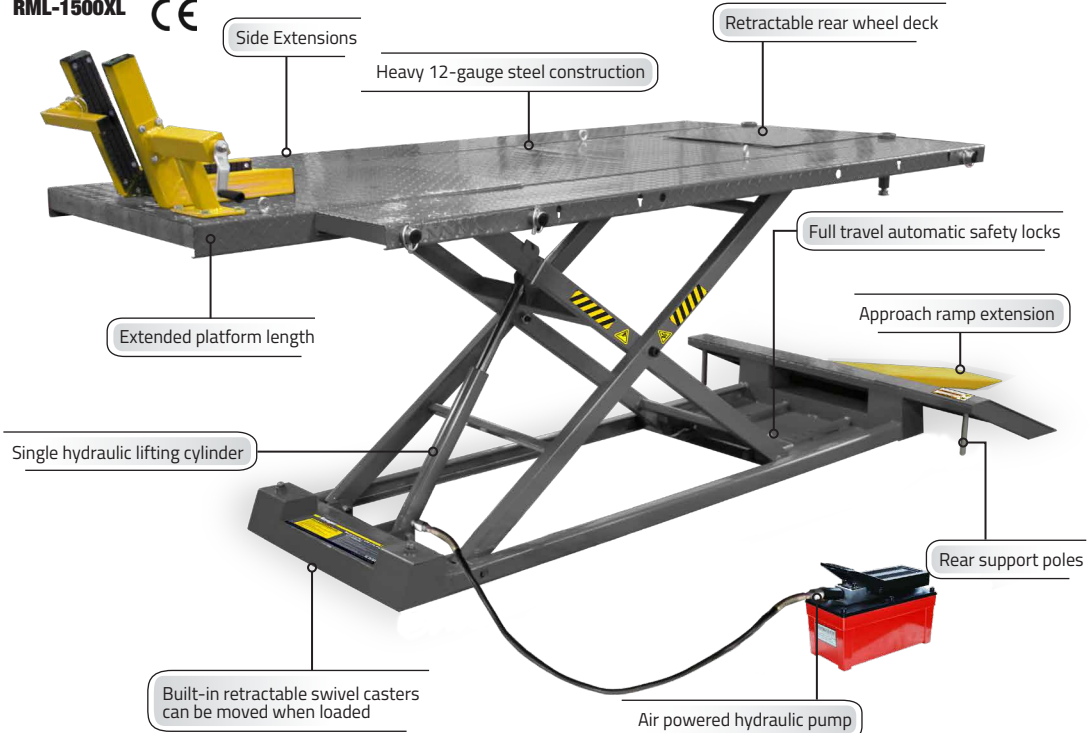

# Shop Equipment

## INFORMATION:

Let Ranger Products lighten the load with our considerable line of high-quality rolling equipment. All Ranger Carts and Dollies are made from high-gauge steel and employ only the best casters for easy maneuvering. Our service carts, chassis-mount vehicle dollies, low-profile automobile carts and rolling adjustable work tables come fully equipped to make your day in the garage infinitely easier. Don't lift or carry—roll with Ranger!

Ranger's industrial shop presses offer you the versatility of professional-grade hydraulic force, whether you're at the shop or in your own garage. Among other operations, all Ranger Hydraulic Presses are ideal for the removal and installation of gears, bushings and bearings—so you can bend, straighten, flatten, crush, press, shape, push, pull, lift and spread like you were born doing it.

### RCD-1TD Wheel Dolly Auto Carts

#5150190



Capacity - 1,000 lbs. (Each)  
Dimensions - 15.5" x 23.5"  
3.5" Cast Iron Ball Bearing Casters

### RCD-2V 4,400-lb. Capacity Vehicle Dolly

#5150409



Lifting Capacity - 4,400 lbs. (Each)  
Overall Height - 10"  
Caster Size - 4.5"

### RP-20T Bottle Jack Shop Press

#5150496



Capacity - 40,000 lbs.  
Cylinder Stroke - 8"  
Width - 23" / Height - 59"

### RCD-1500 GoCart™ Vehicle Dolly

#5150595



(Sold as Pair)

Load Rating Each - 1,500 lbs.  
Tire Width Capacity - 12"  
Tire Diameter Capacity - 15" - 28"

### RCD-1500EX GoCart™ Vehicle Dolly Extended

#5150191



(Sold as Pair)

Load Rating Each - 1,500 lbs.  
Tire Width Capacity - 13"  
Tire Diameter Capacity - 19" - 37"

### RP-20HD Hydraulic Shop Press

#5150059



Capacity - 40,000 lbs.  
Cylinder Stroke - 5.5"  
Width - 37" / Height - 60.25"

### GoCart™ Storage Rack

#5150600



Load Rating - 200 lbs.  
Dimensions - 19" x 31" x 9"  
Holds up to 4 GoCart™ Dollies



Integrated 4" diameter  
20-ton pressure gauge

Hydraulic cylinder moves laterally

Adjustable table height

RP-20HD

**Variability in Specifications and Features:** All product specifications and features listed in this catalog are for reference only. For a more accurate and comprehensive listing of product specifications and features, visit [www.bendpak.com](http://www.bendpak.com). The contents of this catalog are subject to change.

### RWB-2D FEATURES:

- Electrostatic triple-baked protective powder coat
- Rolled edges for added strength and rigidity
- Full-extension ball bearing drawer slides
- Tumbler key-lock pivot drawer latching system

### RWB-2S FEATURES:

- Glossy red finish
- Electrostatic oven-baked powder coat
- Rolled edges for added strength and rigidity
- 5/32" HD rolled edge steel table top
- 3/32" HD rolled edge steel shelves
- 12-gauge construction

### RWB-1TD FEATURES:

- Lockable heavy-duty drawer
- 500-lb. working capacity
- Heavy-duty 4" casters
- Adjustable working height
- Removable polyethylene fluid drain
- 14-gauge table top
- 3/4" liquid containing rim

**RWB-2D**  
**2-Drawer Work Bench**  
#5145330



Height - 34.5"  
Width - 59"  
Depth - 25.25"

**RWB-2S**  
**2-Shelf Work Bench**  
#5145335



Height - 34.5"  
Width - 79"  
Depth - 25.25"

**RWB-1TD**  
**Work Bench w/Fluid Catcher**  
#5145336



Height - 40"  
Width - 48"  
Depth - 32"

**RH-50PL**  
**Hose Reel**  
#5150211

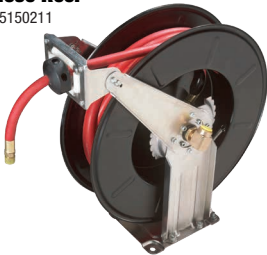

Air Pressure - 300 psi  
Hose Length - 50'  
Fittings - 3/8"

**RH-50PL**

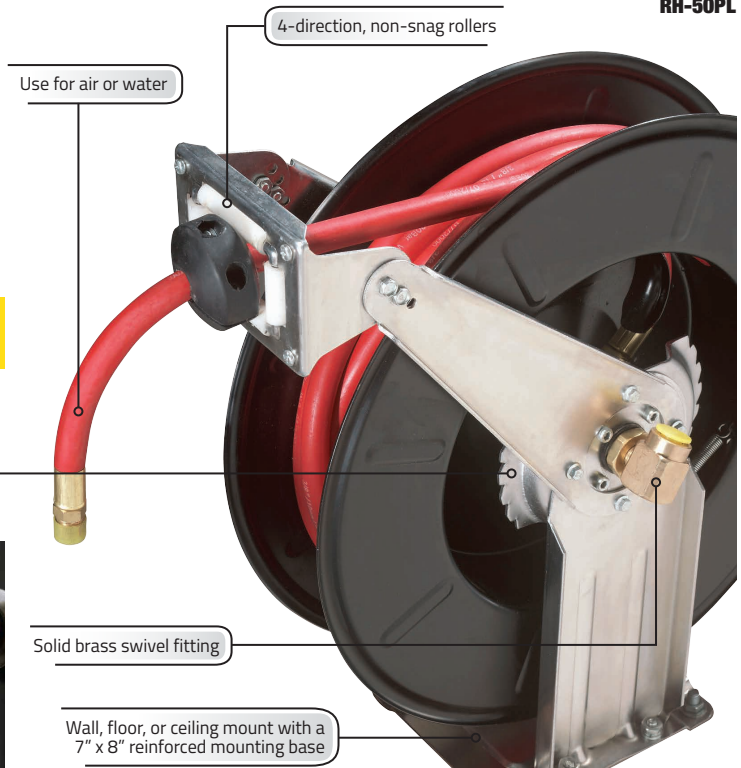

# Shop Equipment

## SERIES FEATURES:

### Oil Drains

- Lightweight for easy portability
- Safe and easy to use
- Non-corrosive telescoping tube
- Heavy-duty stainless steel clamp
- Built-in hand grips
- Durable steel construction

- Tough construction will resist dents, rust, and corrosion
- Rugged funnel with built-in contamination screen

### Oil Filter Crushers

- Reduces cans up to 20%
- Reduces filters up to 25%

- Crushes cans in only 15 seconds
- Hydraulic powered (20FC air operated)
- Fulfills EPA and other mandated environmental standards
- Removes up to 95% of the oil
- Compact floor or bench-mount design
- All-steel industrial construction

**RD-9G**  
9-Gallon  
Oil Drain  
#5150997



Capacity - 9 gal.  
Height - 32" - 64"  
Funnel Diameter - 18"

**RD-18G**  
18-Gallon  
Oil Drain  
with Pump  
#5150995



Capacity - 18 gal.  
Height - 56" - 72"  
Evacuation Pump

**RD-15**  
15-Gallon  
Low-Profile  
Oil Drain  
#5150206



Capacity - 15 gal.  
Height - 8.5"  
Shipping Weight - 43 lbs.

**RD-20SE**  
20-Gallon  
Air-Evac  
Oil Drain  
#5150996



Capacity - 20 gal.  
Height - 52" - 83"  
Funnel Diameter - 16"

**RP-20FC**  
Oil Filter  
Crusher  
with Stand  
#5150067



(Barrel not included)

Capacity - 10 Ton / Cycle Time - 15 - 20 sec.  
Air Requirements - 125 - 175 psi  
Dimensions - 29.5" x 17" x 17"

**RP-30FCH**  
Electric / Hydraulic  
Oil Filter Crusher  
with Stand  
#5150008



Capacity - 15 Ton / Cycle Time - 8 - 15 sec.  
Power Supply - 208-240V / 50/60Hz / 1 Ph  
Dimensions - 75" x 42.5" x 17"

**RP-50FC**  
Heavy-Duty  
Oil Filter  
Crusher  
with Stand  
#5150401



(Barrel not included)

Capacity - 25 Ton / Cycle Time - 8 - 15 sec.  
Power Supply - 208-240V / 50/60Hz / 1 Ph  
Dimensions - 90.5" x 32.5" x 31.5"



See it on the BendPak / Ranger YouTube Page



**Variability in Specifications and Features:** All product specifications and features listed in this catalog are for reference only. For a more accurate and comprehensive listing of product specifications and features, visit [www.bendpak.com](http://www.bendpak.com). The contents of this catalog are subject to change.

## RS-500D / RS-750D FEATURES:

- Heavy-duty steel construction
- Removable tank screen
- Stainless oil skimmer
- Removable parts tree
- Powder coat finish
- Brass nozzles
- Full opening octagonal door
- Large drain pipe
- Heavy-duty rubber casters
- Friction-drive turntable system
- Gasket-free door
- Small parts basket
- Stainless steel handles
- FREE bucket of soap included

## SOAP FEATURES:

- Non-foaming soap
- Low pH
- Mild alkali
- Water soluble
- Specially formulated
- Removes grease, oil, stains, carbon, protein and some paints

### RS-500D Spray Wash Cabinet

#5155117

**FREE 20-lb.  
Soap Bucket**



Load Capacity - 500 lbs.  
Tank Capacity - 50 gal.  
Interior Dimensions - 43" x 32"

### RS-750D Spray Wash Cabinet (Truck)

#5155118

**FREE 20-lb.  
Soap Bucket**



Load Capacity - 1,000 lbs.  
Tank Capacity - 53 gal.  
Interior Dimensions - 32" x 54"

### Aluma-Klean Detergent

20 lbs. #5155096

50 lbs. #5155100



Low pH  
Water soluble  
Non foaming soap

## STAINLESS STEEL OPTION AVAILABLE

### RS-500DS Stainless Steel Spray Wash Cabinet

#5155051

### RS-750DS Stainless Steel Spray Wash Cabinet

#5155052

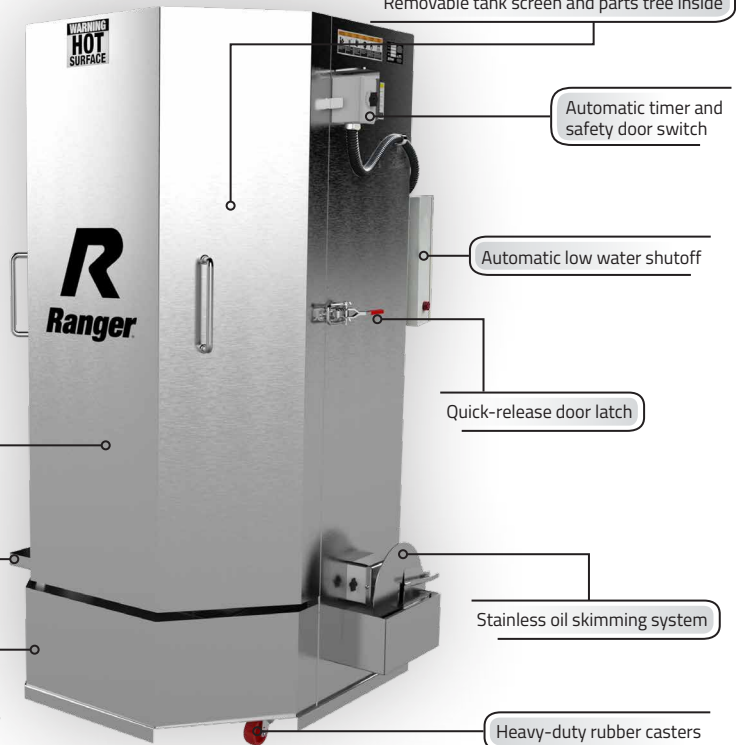

See it on the BendPak / Ranger YouTube Page

# Shop Equipment

## RWS-1B FEATURES:

### Bubble Balancer

- Rugged die-cast aluminum head cone
- Easy to use self-leveling stand
- Built-in weight-storage compartments
- Self-aligning, spring-loaded cone
- Hardened cast pivot seat
- Recessed circular level bubble

### RWS-1B Bubble Wheel Balancer

#5156100



Hub Hole Diameter - 1.5" - 4.5"  
Calibrated at - 90°- 180°- 270°- 360°  
Width - 12" / Height - 23"

## RWS-3TC FEATURES:

### Manual Tire Changer

- Heavy steel construction for maximum durability
- Efficient operation at a fraction of the cost
- Performs both mounting and bead breaking operations

### RWS-3TC Manual Tire Changer

#5150400



Tire Capacity - 8" - 7.5" x 16"  
Wheel Plate Diameter - 7.5"  
Base Dimensions - 15" x 18"

## RST-1WS Features:

### Rolling Work Seat

- Padded seat
- Swivel casters for easy maneuverability
- Relieves sore back muscles
- Work more efficiently
- Sturdy steel tubing construction
- Low profile design

### RST-1WS Rolling Work Seat

#5150514



Steel Tubing - 1"  
Swivel Casters - 2.5"  
Relieves sore back muscles

### Clip-On Steel Wheel Weights



0.25oz, 0.75oz, 1oz, 1.25oz, 1.5oz, 1.75oz,  
2oz, 2.25oz, 2.5oz, 2.75oz, 3oz  
Qty. - 25 ea.

### Ergo-RS Creep Chair

#5215988



Max Capacity - 350 lbs.  
Max Seat Height - 21" / Min Height 5.7"  
Collapsed Length - 56"

### Ergo-RS



Six Seat Locking Positions - 0° to 75°



**Variability in Specifications and Features:** All product specifications and features listed in this catalog are for reference only. For a more accurate and comprehensive listing of product specifications and features, visit [www.bendpak.com](http://www.bendpak.com). The contents of this catalog are subject to change.

### RST-500ES FEATURES:

- Adjusts to fit all vehicles
- Rubber foot pads to hold load securely
- Straddles inner fender wells
- Precisely positions engine for easy gear box and transmission removal
- Perfect for 4 and 6 cylinder engines
- Folds upright to conserve space

### RES-1TF Features

- Heavy steel construction
- Long rubber-grip handle
- Head swivels 360° for easy positioning
- Heavy-duty swivel casters
- Slotted adjustable saddle permits quick and easy installation
- Neck is reinforced for extra strength

### RSC-2TF FEATURES:

- Designed for shops with limited space
- Folds for easy storage
- Heavy-duty steel casters
- Neck is reinforced for extra strength
- Wide base for maximum stability
- Telescoping boom provides 4 positions
- Heavy steel construction

#### RST-500ES Engine Support

#5150103



Holding Capacity - 1,500 lbs.  
Screw Travel - 13"  
Adjustable Width - 40" - 63"

#### RES-1TF Engine Stand

#5150470



Holding Capacity - 2,000 lbs.  
Front Width - 31" / Rear Width - 27.5"  
Height - 37.5" / Length - 41"

#### RSC-2TF Folding Shop Crane

#5150105



Boom Length - 40" - 63"  
Boom Capacity - 1,100 - 4,400 lbs.  
Boom Height - 80" - 93"

#### RIC-4716 Inflation Cage

#5150315



Max Tire Width - 16"  
Max Tire Diameter - 47"  
Solid-steel welded-steel base

#### AC-134A

A/C Pressure adjustment

Electric database

Flushing function for rapid discharge of used coolant

R134a Refrigerant

Meets UL 1963 & SAE J2788 Standards

Automatic oil discharge

#### A/C Recovery Machine

#5150025



Refrigerant: R134a  
Car, truck, SUV and bus compatibility  
Tank Capacity - 50 lbs.

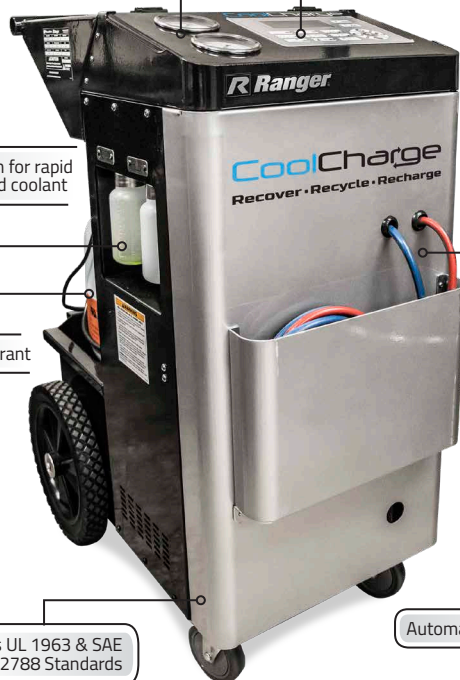

CoolCharge

# Portable Air Coolers

## COOLBREEZE SERIES FEATURES:

- Oscillating swing-louvers
- Blue Flex™ axial flow fan
- User-friendly controls
- Three-speed fan
- Water inlet flow control
- Standard power supply - 110V / 60 Hz / 1 Ph
- Honeycool™ evaporative media



- Durable swivel casters
- Constant water inlet
- Protective cover comes standard
- Space-saving design
- Extra-long power cord
- GFCI plug
- UL® Certified

## SWING-LOUVERS

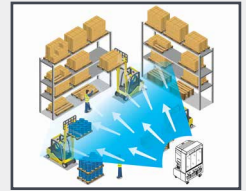

### CB-12SL Portable Evaporative Air Cooler

#5150018



OPTIONAL  
208-230V  
Model  
**CB-12SLH**  
#5150017

Fan Diameter - 12"  
Water Capacity - 15 Gal  
Max. Airflow - 1,565 CFM

### CB-14SL Portable Evaporative Air Cooler

#5150030



OPTIONAL  
208-230V  
Model  
**CB-14SLH**  
#5150031

Fan Diameter - 14"  
Water Capacity - 15.6 Gal  
Max. Airflow - 2,300 CFM

### CB-26SL Portable Evaporative Air Cooler

#5150026



OPTIONAL  
208-230V  
Model  
**CB-26SLH**  
#5150037

Fan Diameter - 26"  
Water Capacity - 50 Gal  
Max. Airflow - 6,027 CFM

## OPTIONAL ACCESSORY:

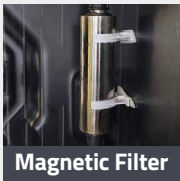

This easy-to-install magnetic filter conditions the water before it reaches your air cooler. Housed in a durable stainless steel cylinder, it helps remove odors and scale-build-up.

## Water Drip System

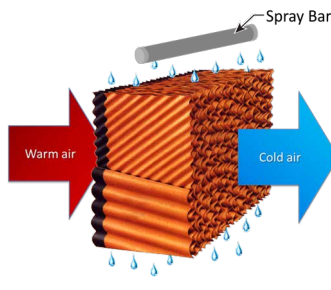

## Cool Boss Protective Cover

Small - #5326303  
Medium - #5326304  
Large - #5326305



Small Fits - CB-16  
Medium Fits - CB-28  
Large Fits - CB-36



Industrial



Commercial



Residential

**Variability in Specifications and Features:** All product specifications and features listed in this catalog are for reference only. For a more accurate and comprehensive listing of product specifications and features, visit [www.bendpak.com](http://www.bendpak.com). The contents of this catalog are subject to change.

## COOLBLAST SERIES FEATURES:

- Remote control with a convenient holder
- Automatic water source shutoff
- Water inlet flow control
- Durable ABS plastic shell construction
- Variable-speed fan
- Standard power supply - 110V / 60 Hz / 1 Ph
- Honeycool™ evaporative media
- Bluetooth® audio player
- Built-in speakers
- Anion negative ion air purifier
- LED Floodlight
- Space-saving design
- Soft-touch LED controls
- Antibacterial housing
- Durable swivel casters
- 360° handle
- Protective cover comes standard
- Built-in timer
- Extra-long power cord
- GFCI plug
- UL® Certified

### CB-16L Portable Evaporative Air Cooler

#5150151



**OPTIONAL**  
208-230V  
Model  
**CB-16H**  
#5150176

Fan Diameter - 16"  
Water Capacity - 60 Gal  
Max. Airflow - 4,950 CFM

### CB-28L Portable Evaporative Air Cooler

#5150152



**OPTIONAL**  
208-230V  
Model  
**CB-28H**  
#5150177

Fan Diameter - 28"  
Water Capacity - 80 Gal  
Max. Airflow - 9,020 CFM

### CB-36L Portable Evaporative Air Cooler

#5150153



**OPTIONAL**  
208-230V  
Model  
**CB-36H**  
#5150178

Fan Diameter - 36"  
Water Capacity - 115 Gal  
Max. Airflow - 12,615 CFM

## OPTIONAL ACCESSORY:

### CB-16 Duct Kit

Get the most out of the CB-16 with the Ducting Kit. Direct refreshing air precisely where you need it.

Length: 15 ft  
Material: Flexible Reinforced Polyvinyl Duct



# 5150236



**NEW!**



# Manufacturing Superiority

## Medium and Heavy-Duty Products

BendPak recognizes the manufacturing process as our moment of maximum influence. When we ship a piece of equipment, we need to know that the product leaving our manufacturing complex is the best it could be. That's why we demand nothing short of the very finest in facilities and machinery. Our primary factory houses development and manufacturing for medium and heavy-duty lifting products and wheel service models. At just over 300,000 square ft., it's designed for maximum efficiency and safety. Plus, we consistently employ the best steel fabrication techniques in the world.

## Main Production Facility

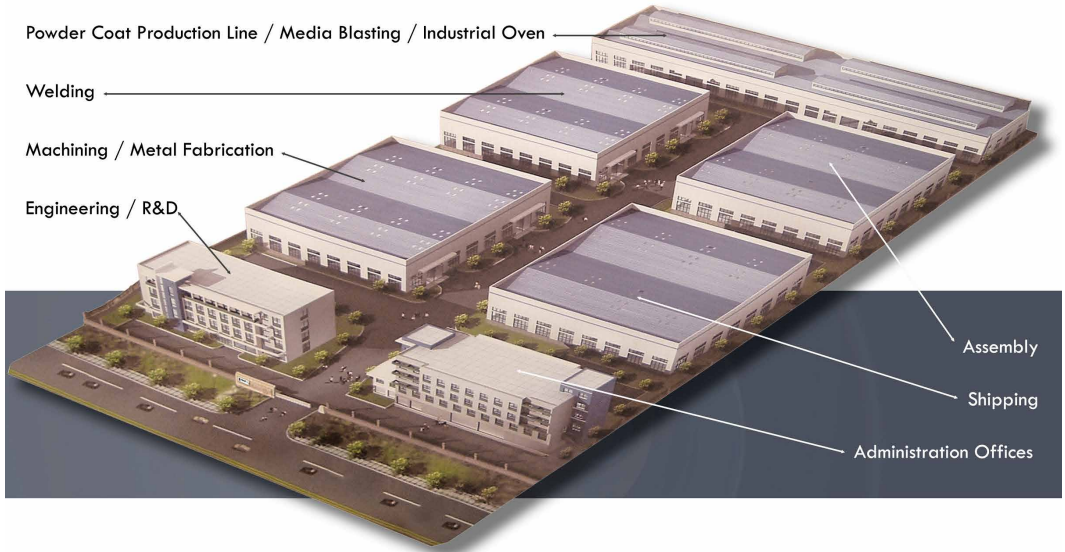

## Light and Medium-Duty Products

BendPak's second mega-sized manufacturing facility is used primarily for the fabrication of light and medium-duty lift products, select parking systems and vehicle repair tools and equipment. The multiplex factory houses state-of-the-art equipment including, numerically-controlled turning and milling equipment and automated welding systems. Full-capability services like comprehensive metallurgy testing, heat treatment, automated powder coating and other specialty operations take place here as well. The facility also houses assembly and packaging operation centers and product development testing labs for BendPak's growing customer base around the globe.



**Variability in Specifications and Features:** All product specifications and features listed in this catalog are for reference only. For a more accurate and comprehensive listing of product specifications and features, visit [www.bendpak.com](http://www.bendpak.com). The contents of this catalog are subject to change.

## New Alabama Facility Speeds up Shipping



BendPak recently announced the opening of a new 100,000 square-foot distribution center near Mobile, Alabama, to better serve customers in the eastern United States. The administrative and shipping complex, which is expected to be fully operational within 60 days, is located in Theodore, just a short drive from the expanding Port of Mobile. The new facility has easy access to three major interstates and five Class I railroads, helping BendPak to deliver products same-day or next-day to more customers in the eastern half of the country.

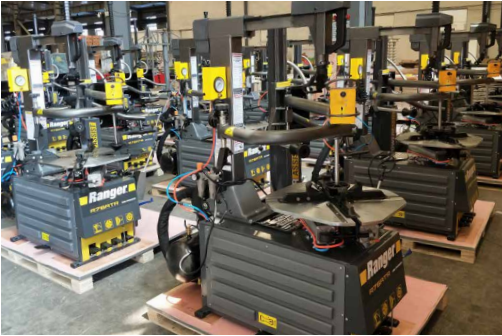

BendPak/Ranger products and related marks are trademarks and/or registered trademarks of BendPak Inc.

## Safe Practices are Best Practices

Our multi-department manufacturing complexes have allowed us to expand both machinery and employees to triple our daily production capacity. All BendPak employees are Q.C. trained and follow rigid ISO-9001 guidelines. Every day, more than 700 employees around the world dedicate themselves to putting our core values into action. Safety is first—it's our company's top priority, followed closely by environmental responsibility, cost-efficiency, quality, customer service and accountability for all departments. These principles guide our highly skilled workforce toward BendPak's unified vision.



Including new acquisitions like our latest facility in Mobile, Alabama, BendPak's facilities encompass over 700,000 sq. ft. worldwide. Each location follows strict guidelines as outlined by ISO-9001, further supporting our position as a premier global manufacturer. At BendPak, we ensure that our offshore manufacturing is no different in approach or standards from our domestic production. These facilities are audited year-round and undergo systematic evaluation of documented quality programs such as TUV, ANSI/ALI ALCTV, CSA, UL and AS/NZS 1418.9. The programs are also audited quarterly to ensure continued compliance with all applicable standards.

# AMERICA'S<sup>TM</sup> FAVORITE

SINCE 1965



**BP** BendPak<sup>®</sup>

**R** Ranger

**AUTOSTACKER**<sup>™</sup>

**LITESTIX**<sup>™</sup>

**GRANDPRIX**<sup>™</sup>

**COOL BOSS**<sup>™</sup>

**DANMAR**<sup>®</sup>

**JACKPAK**<sup>™</sup>

**QUICKJACK**<sup>™</sup>

**MAXJAX**<sup>™</sup>

1645 Lemonwood Drive • Santa Paula, CA USA 93060  
Tel: 1-800-253-2363 • [www.bendpak.com](http://www.bendpak.com)